

REGISTRATION NOT TRANSFERABLE

UNITED STATES OF AMERICA DEPARTMENT OF TRANSPORTATION - FEDERAL AVIATION ADMINISTRATION CERTIFICATE OF AIRCRAFT REGISTRATION		This certificate must be in the aircraft when operated.
NATIONALITY AND REGISTRATION MARKS N 887SP	AIRCRAFT SERIAL NO. 34-7350124	
MANUFACTURER AND MANUFACTURER'S DESIGNATION OF AIRCRAFT PIPER PA-34-200 ICAO Aircraft Address Code: 53034564		
ISSUED TO	CYLINDER SHOP INC 14351 NW 41ST AVE OPA LOCKA FL 33054-2328	This certificate is issued for registration purposes only and is not a certificate of title. The Federal Aviation Administration does not determine rights of ownership as between private persons.
	CORPORATION	
It is certified that the above described aircraft has been entered on the register of the Federal Aviation Administration, United States of America, in accordance with the Convention on International Civil Aviation dated December 7, 1944, and with Title 49, United States Code, and regulations issued thereunder.		
DATE OF ISSUE October 30, 2008	 ACTING ADMINISTRATOR	 U.S. Department of Transportation Federal Aviation Administration

AC Form 8050-3 (5/2008) Supersedes previous editions

UNITED STATES OF AMERICA DEPARTMENT OF TRANSPORTATION—FEDERAL AVIATION ADMINISTRATION STANDARD AIRWORTHINESS CERTIFICATE

1 NATIONALITY AND REGISTRATION MARKS	2 MANUFACTURER AND MODEL	3 AIRCRAFT SERIAL NUMBER	4 CATEGORY
N887SP	PIPER PA34-200	34-7350124	NORMAL

5. AUTHORITY AND BASIS FOR ISSUANCE
 This airworthiness certificate is issued pursuant to the Federal Aviation Act of 1958 and certifies that, as of the date of issuance, the aircraft to which issued has been inspected and found to conform to the type certificate therefor, to be in condition for safe operation, and has been shown to meet the requirements of the applicable comprehensive and detailed airworthiness code as provided by Annex 8 to the Convention on International Civil Aviation, except as noted herein
 Exceptions

NONE.

6. TERMS AND CONDITIONS
 Unless sooner surrendered, suspended, revoked, or a termination date is otherwise established by the Administrator, this airworthiness certificate is effective as long as the maintenance, preventative maintenance, and alterations are performed in accordance with Parts 21, 43, and 91 of the Federal Aviation Regulations, as appropriate, and the aircraft is registered in the United States

DATE OF ISSUANCE R- 01/26/1973	FAA REPRESENTATIVE ROBERT W. VAN LOON	DESIGNATION NUMBER SAT-FSDO SW17
--	---	--

Any alteration, reproduction, or misuse of this certificate may be punishable by a fine not exceeding \$1,000, or imprisonment not exceeding 3 years or both THIS CERTIFICATE MUST BE DISPLAYED IN THE AIRCRAFT IN ACCORDANCE WITH APPLICABLE FEDERAL AVIATION REGULATIONS

WAYMAN AVIATION SERVICE, INC.

Bldg. 209 Musick Rd. Opa-Locka Airport Opa-Locka, FL 33054 Ph: 305.685.6468 Fax: 305.685.6449

Piper Seneca I N887SP

E.L.T.	April 2009	April 2010
TRANSPONDER	April 2008	April 2010
STATIC SYSTEM	April 2008	April 2010
ANNUAL	April 2009	April 2010
100 HRS.	4,629.7 Tach	4,729.7 Tach

COMPUTED WEIGHT AND BALANCE

BASIC EMPTY WEIGHT	2862.8
TOTAL MOMENT	241794.1
NEW C.G.	84.46
USEFUL LOAD	1337.2

N887SP

WEIGHT AND BALANCE

DATE: April 1, 2005 WO#: 17018
A/C : PIPER PA-34-200 S/N : 34-7350124
REG # : N887SP TACH: 4138.9

THIS FORM SUPERSEDES WEIGHT AND BALANCE DATED: 12/17/01

ITEM	WEIGHT (LBS.)	ARM (IN)	MOMENT (IN LBS.)
PREVIOUS WEIGHT AND BALANCE:	2871.80	84.30	242092.90
REMOVED Left MZ-4216 Starter	-18.00	33.20	-597.60
INSTALLED Left MZ-6222 Starter	9.00	33.20	298.80
TOTAL:	2862.80	84.46	241794.10

NEW EMPTY WEIGHT: 2862.80 LBS.
NEW EMPTY WEIGHT C.G.: 84.46 IN.
MAX GROSS WEIGHT: 4200.00 LBS. Take-Off
USEFUL LOAD: 1337.20 LBS.

SYREK-MEE AVIATION

AP 2761252

United States of America Department of Transportation — Federal Aviation Administration

Supplemental Type Certificate

Number SA01140WI

Garmin International, Inc.

1200 East 151st Street

Olathe, KS 66062

This certificate issued to

certifies that the change in the type design for the following product with the limitations and conditions therefor as specified hereon meets the airworthiness requirements of Part 23 of the Federal Aviation Regulations.

3A13

Original Product—Type Certificate Number :

Make : Piper

Model : PA-34

Description of Type Design Change: Installation of a Garmin GNS 430/530 VHF NAV/COMM/GPS System and associated GI 106A Course Deviation Indicators (CDI), GTX 327 ATCRBS Transponder, and GMA 340 Audio Panel. Data Required: (1) Garmin Master Drawing List (MDL) 005-C0001-00, Revision E, dated February 18, 2003; and (2) FAA Approved Airplane Flight Manual Supplement (AFMS), for Piper Models with Garmin GNS 430 and GNS 530 VHF NAV/COMM/GPS and GI 106A Course Deviation Indicators, Garmin Document, Revision B, dated February 26, 2003; or later FAA Approved Revisions to (1) or (2).

Limitations and Conditions : Compatibility of this design change with previously approved modifications must be determined by the installer. If the holder agrees to permit another person to use this certificate to alter the product, the holder shall give the other person written evidence of that permission.

Date of application : May 31, 2002

Date of issuance : February 27, 2003

This certificate and the supporting data which is the basis for approval shall remain in effect until surrendered, suspended, revoked or a termination date is otherwise established by the Administrator of the Federal Aviation Administration.

THE

DUPLICATE **SENECA**

PILOT'S OPERATING MANUAL



BY



This manual is incomplete without an APPROPRIATE FAA APPROVED AIRPLANE FLIGHT MANUAL and an APPROPRIATE WEIGHT AND BALANCE REPORT.

WARNING



EXTREME CARE MUST BE EXERCISED TO LIMIT THE USE OF THIS MANUAL TO APPLICABLE AIRCRAFT. THIS MANUAL REVISED AS INDICATED BELOW OR SUBSEQUENTLY REVISED IS VALID FOR USE WITH THE AIRPLANE IDENTIFIED BELOW WHEN APPROVED BY PIPER AIRCRAFT CORPORATION. SUBSEQUENT REVISIONS SUPPLIED BY PIPER AIRCRAFT CORPORATION MUST BE PROPERLY INSERTED.

MODEL PA-34-200

AIRCRAFT SERIAL NO. 34-7350124 REGISTRATION NO. N8875P

PILOT'S OPERATING MANUAL, PART NUMBER 761 506 REVISION PR871130

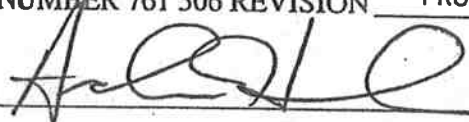
PIPER AIRCRAFT CORPORATION
APPROVAL SIGNATURE AND STAMP

Assurance that the airplane is in an airworthy condition is the responsibility of the owner. The pilot in command is responsible for determining that the airplane is safe for flight. The pilot is also responsible for remaining within the operating limitations outlined by the Airplane Flight Manual, instrument markings, and placards.

This Pilot's Operating Manual is not designed as a substitute for adequate and competent flight instruction, knowledge of the current airworthiness directives, applicable federal air regulations, or advisory circulars. It is not intended to be a guide for basic flight instruction or a training manual for transition from single to multi-engine flying.

If an inconsistency of information exists between the Pilot's Operating Manual and the Airplane Flight Manual approved by the FAA, the Airplane Flight Manual shall be the authority.

A complete or partial replacement of this manual, Part No. 761 506, may be obtained only from Piper Customer Services.

Published by
PUBLICATIONS DEPARTMENT
Piper Aircraft Corporation
761 506
Issued: March 1972

GENERAL SPECIFICATIONS

APPLICABILITY

This manual is applicable to Piper Model PA-34-200 aircraft having serial numbers 34-7250001 through 34-7250189 when Piper Kit 760 607 is installed, 34-7250190 through 34-7250214 when Piper Kit 760 611 is installed and 34-7250215 through 34-7350353. Contact Piper Customer Services for specific information on the application of this manual.

REVISIONS

The information compiled in the Mot's Operating Manual will be kept current by revisions distributed to the airplane owners.

Revision material will consist of information necessary to update the text of the present manual and/or to add information to cover added airplane equipment.

I. Revisions

Revisions will be distributed whenever necessary as complete page replacements or additions and shall be inserted into the manual in accordance with the instructions given below:

1. Revision pages will replace only pages with the same page number.
2. Insert all additional pages in proper numerical order within each section.
3. Page numbers followed by a small letter shall be inserted in direct sequence with the same common numbered page.

II. Identification of Revised Material

Revised text and illustrations shall be indicated by a black vertical line along the left hand margin of the page, opposite revised, added or deleted material. A line opposite the page number or section title and printing date, will indicate that the text or illustration was unchanged but material was relocated to a different page or that an entire page was added.

Black lines will indicate only current revisions with changes and additions to or deletions of existing text and illustrations. Changes in capitalization, spelling, punctuation or the physical location of material on a page will not be identified by symbols.

III. Original Pages Issued

The original pages issued for this manual prior to revision are given below:

1-1 through 14, 2-1 through 2-22, 3-1 through 3-26, 4-1 through 4-34, 6-1 through 6-14, 7-1, 8-1 through 8-16, 9-1 through 9-11.

REVISIONS ISSUED

Current Permanent and Temporary Revisions to the PA-34 Pilot's Operating Manual issued March 10, 1972 are as follows:

761 506 (PR720508)	Permanent Revision to F/M	Dated May 8, 1972
761 506 (PR720707)	Permanent Revision	Dated July 7, 1972
761 506 (PR720802)	Permanent Revision to W/B	Dated August 2, 1972
761 506 (PR720802)	Permanent Revision to F/M General Specifications	Dated August 2, 1972
761 506 (PR720915)	Permanent Revision to F/M	Dated September 15, 1972
761 506 (PR721116)	Permanent Revision to F/M & W/B	Dated November 16, 1972
761 506 (PR721220)	Permanent Revision to F/M & P/O/M	Dated December 20, 1972
761 506 (PR721221)	Permanent Revision to W/B	Dated December 21, 1972
761 506 (PR730525)	Permanent Revision to F/M & W/B	Dated May 25, 1973
761 506 (PR730919)	Permanent Revision to F/M, W/B and P/O/M	Dated September 19, 1973
761 506 (PR731026)	Permanent Revision to P/O/M	Dated October 26, 1973
761 506 (PR740426)	Permanent Revision to F/M, W/B and P/O/M	Dated April 26, 1974
761 506 (PR741014)	Permanent Revision to F/M, W/B and P/O/M	Dated October 14, 1974
761 506 (PR750530)	Permanent Revision to F/M, W/B and P/O/M	Dated May 30, 1975
761 506 (PR750819)	Permanent Revision to F/M and P/O/M	Dated August 19, 1975
761 506 (PR770401)	Permanent Revision to F/M and P/O/M	Dated April 1, 1977
761 506 (PR790323)	Permanent Revision to W/B and P/O/M	Dated March 23, 1979
761 506 (PR830614)	Permanent Revision to F/M and P/O/M	Dated June 14, 1983

REVISIONS ISSUED (cont)

Current Permanent and Temporary Revisions to the PA-34 Pilot's Operating Manual issued March 10, 1972 are as follows (continued):

761 506 (PR871130)

Permanent Revision to

Dated November 30, 1987

W/B and P/O/M

BLANK PAGE

TABLE OF CONTENTS

GENERAL SPECIFICATIONS

DESCRIPTION - AIRPLANE AND SYSTEMS

FLIGHT MANUAL FAA APPROVED

EMERGENCY PROCEDURE FAA APPROVED

WEIGHT AND BALANCE

OPERATING INSTRUCTIONS

OPERATING TIPS

PERFORMANCE CHARTS

HANDLING AND SERVICING

BLANK PAGE

GENERAL SPECIFICATIONS

Performance.....	1-1
Altitude Cruising Speeds (mph)	1-1
Weights	1-2
Power Plant.....	1-2
Fuel and Oil	1-2
Baggage Area	1-2
Dimensions	1-2
Landing Gear	1-3

BLANK PAGE

GENERAL SPECIFICATIONS

PERFORMANCE

Published figures are for Standard PA-34* airplanes flown at gross weight under standard condition at sea level unless otherwise stated. Performance for a specific airplane may vary from published figures depending upon the equipment installed, the condition of engines, airplane and equipment, atmospheric conditions and piloting technique.

Gross Weight (pounds)	4000	4200
Take-off Run (ft) (short field effort, flaps 25)	750	800
Take-off Distance Over 50 ft Barrier (ft) (short field effort, flaps 25)	1140	1235
Minimum Controllable Single Engine Speed (mph)	80	80
Best Rate of Climb Speed (mph) (knots)	105 (91.5)	105 (91.5)
Best Rate of Climb (ft per min)	1460	1360
Best Angle of Climb Speed (mph) (knots)	90 (78)	90 (78)
Best Single Engine Rate of Climb Speed (mph) (knots)	105 (91.5)	105 (91.5)
Single Engine Rate of Climb @ S.L. (ft per min)	230	190
Service Ceiling (ft)	18,800	17,900
Absolute Ceiling (ft)	20,000	19,400
Single Engine Service Ceiling (50 fpm) (left engine out) (ft)**	5200	3650
Single Engine Absolute Ceiling (left engine out) (ft)	6600	5000
Top Speed (mph) (knots)	196 (170)	195.3 (169.8)
Cruising Speed (75% power at sea level) (mph) (knots)	173 (150)	171.6 (149.2)
Cruising Speed (75% power at 6000) (mph) (knots)	187 (162)	186.3 (162)
Optimum Cruising Speed (65% power at 9000) (mph) (knots)	185 (160)	183.4 (159.5)
Stalling Speed (gear and flaps down) (power off) (mph) (knots)	67 (58)	69 (60)
Stalling Speed (gear down and flaps up) (power off) (mph) (knots)	73 (63.5)	76 (66)
Landing Roll (flaps down) (ft) (short field)	705***	
Landing Over 50 ft Barrier (flaps down) (ft) (short field)	1335***	
Fuel Consumption (75% power) (gph) (both engines)	20.6	20.6
Fuel Consumption (65% power) (gph) (both engines)	18.3	18.3
Cruising Range (75% power at 6000 ft) (mi)	804	804
Cruising Range (65% power at 9000 ft) (mi)	885	885

*200 BHP, Counter-Rotating Engines, 4200 lb. G.W., Maximum Take-off Weight
4000 lb. G.W., Maximum Landing Weight

**5000 Ft. Single Engine Service Ceiling Occurs at 4030 Pounds Gross Weight.

***This value applies only for the conditions stated on the Landing Distance vs Density Altitude Chart.

SENECA

WEIGHTS

Gross Weight (lbs) Max. Take-off	4200
Max. Landing	4000
Empty Weight (Standard) (lbs)	2625*
USEFUL LOAD (Standard) (lbs)	1575*

*These weights are approximate

POWER PLANT

Right Engine - Lycoming	LIO-360-C1E6
Left Engine - Lycoming	IO-360-C1E6
Rated Horsepower	200
Rated Speed (rpm)	2700
Bore (in.)	5.125
Stroke (in.)	4.375
Displacement (cubic in.)	361.0
Compression Ratio	8.7:1
Dry Weight (lbs)	350.0

FUEL AND OIL

Fuel Capacity (U.S. gal)	98
Unusable fuel	5
Fuel, Aviation Grade (minimum octane)	100/130
Oil Capacity (qts) (each engine)	8

BAGGAGE AREA

Maximum Baggage (lbs) Forward Compartment	100
Maximum Baggage (lbs) Rear Compartment	100
Baggage Space (cubic ft) Forward Compartment	15.3
Baggage Space (cubic ft) Rear Compartment	20
Baggage Door Size (in.) Forward Compartment	24 x 21

DIMENSIONS

Wing Span (ft)	38.88
Wing Area (sq ft)	208.7
Length (ft)	28.5
Height (ft)	9.9
Wing Loading (lbs per sq ft)	20.1
Power Loading (lbs per hp)	10.5
Propeller Diameter (in.)	76

LANDING GEAR

Wheel Base (ft)		7.0
Wheel Tread (ft)		11.1
Tire Pressure (psi)	Nose	31
	Main	50
Tire Size	Nose (six-ply rating)	6.00 x 6
	Main (eight-ply rating)	6.00 x 6

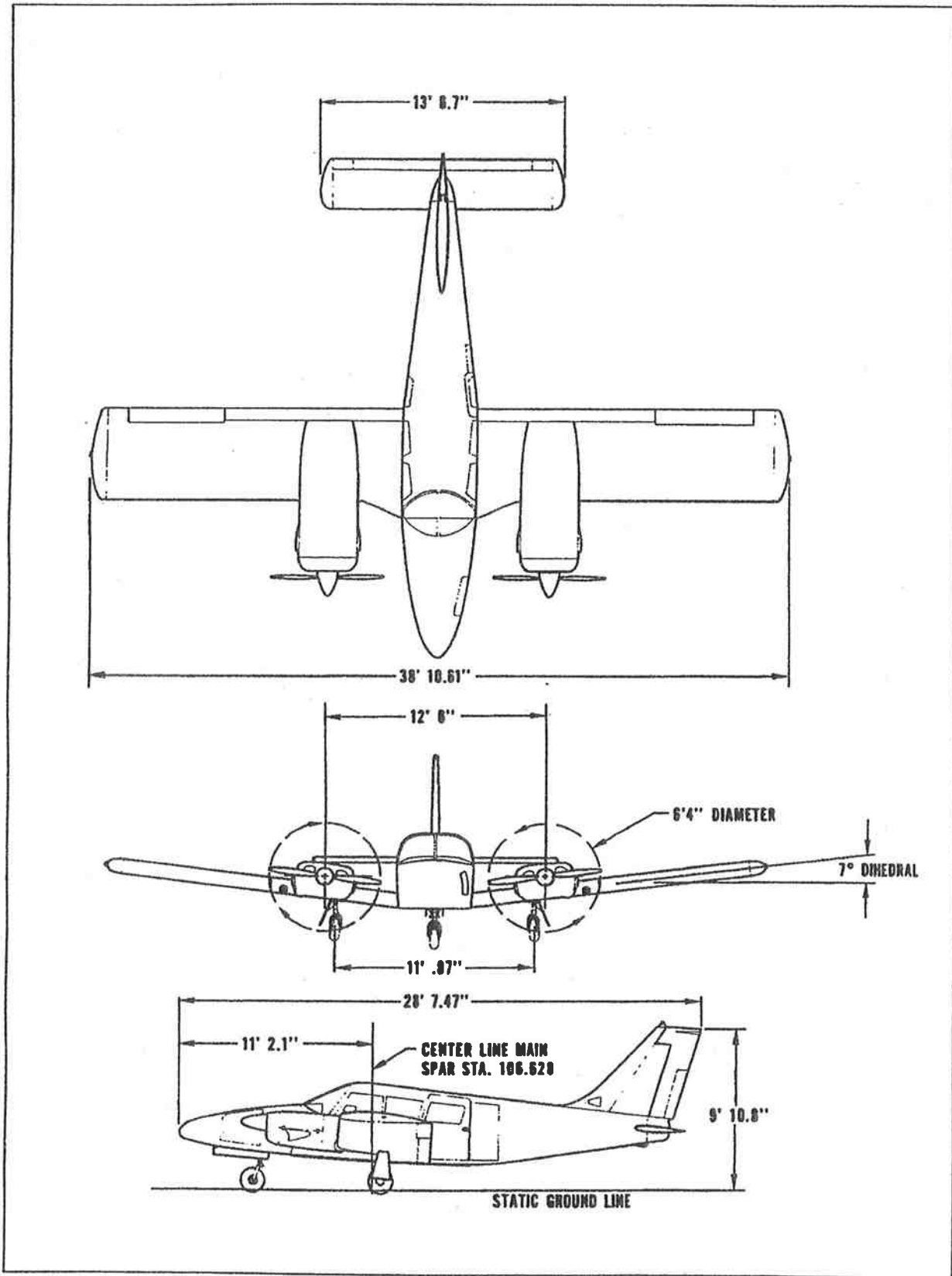

DESCRIPTION
AIRPLANE AND SYSTEMS

DESCRIPTION AIRPLANE AND SYSTEM

The Airplane	2-1
Airframe.....	2-1
Engines	2-2
Propellers	2-4
Landing Gear System	2-4
Flight Control Systems	2-9
Fuel System	2-10
Electrical System	2-12
Vacuum System	2-16
Instrument Panel	2-18
Pitot-Static Systems	2-18
Heating, Ventilating and Defrosting System	2-20
Ice Protection System	2-22
Seats	2-26
Finish	2-26
Baggage Area	2-26
Stall Warning	2-27

BLANK PAGE

DESCRIPTION

AIRPLANE AND SYSTEMS

THE AIRPLANE

The Seneca is a twin-engine, all metal retractable landing gear airplane. It has seating for up to seven occupants and two separate luggage compartments.

AIRFRAME

Except for the steel used in the engine mount and landing gear, and the fiberglass used in such portions as the nose and wing tips, the structural components of the airframe are made of aircraft aluminum alloy which has been heat treated and protected from corrosion. The airframe has been designed and tested to a limit positive load factor of 3.8. The Seneca is not designed for acrobatic flight, and consequently aerobatics are prohibited. (C)

The fuselage is a conventional semi-monocoque structure, which has a front door on the right side and a rear door on the left. An additional large-size rear door, which facilitates the loading of large pieces of cargo, is available.

The wing is of conventional metal design using one main spar located at approximately 40% of the chord aft of the leading edge, to take bending loads, and a rear spar for mounting the flaps and ailerons and to assist in taking torque and drag loads. Slotted wing flaps, which are mechanically operated by a four-position handle located between the two front seats, are provided to reduce landing speed and to give the pilot a high degree of glide path control. Two interconnected fuel tanks form an integral part of each wing. Both tanks on one side are filled through a single filler neck located well outboard of the engine nacelle.

SENECA

The wings are attached to each side of the fuselage by the butt ends of the main spars, which are bolted into a spar box carry through, an integral part of the fuselage structure. There are also fore and aft attachments at the rear spar and at an auxiliary front spar.

The empennage of the Seneca consists of a vertical stabilizer, a rudder, and a horizontal stabilator. The rudder has a trim tab capable of relieving the pilot of excessive pedal force during single-engine operation. The stabilator incorporates an anti-servo tab which improves longitudinal stability and provides longitudinal trim. This tab moves in the direction the stabilator moves but with increased travel.

ENGINES

The 400 total horsepower of the Seneca engines makes possible a high cruise speed and excellent climb performance. The aircraft is powered by two four-cylinder, Lycoming, fuel-injected engines, each rated at 200 horsepower at 2700 RPM. Asymmetric thrust is eliminated during take-off and climb by counter-rotation of the engines, the left engine rotating in a clockwise direction when viewed from the cockpit and the right engine rotating counterclockwise.

The engine compartments are easily accessible for inspection through top-hinged side panels on either side of the engine cowlings. The cowlings are cantilever structures, attached at the firewalls. Engine mounts are constructed of steel tubing, and dynafocal mounts are provided to reduce vibration.

The exhaust system is a crossover type, with exhaust gases directed outboard of the nacelles into muffler-heaters to minimize exhaust noise and provide heated air for the cabin and defroster.

The cowl flaps are located on the bottom of the engine nacelle and are manually operated by control levers below the throttle quadrant. The control levers have three positions: open, intermediate and closed. A lock, incorporated into each control lever, locks the cowl flap in the selected position. To operate, depress the lock and move the control to the desired position. Release the lock after initial movement of the control; the flap will then stop automatically in the next intermediate, open or closed position. The lock must be depressed for each selection of cowl flap.

An oil cooler for each engine is mounted on the forward side of the firewall. Air is picked up by air scoops on the side of the cowl, passed through the oil cooler and ducted overboard in the lower cowl.

The fuel injection system reduces the possibility of induction system ice and provides better fuel distribution than does a carburetor system. Each engine is equipped with a Bendix RSA-5 fuel injection system, which operates on the principle of measuring engine air consumption and using the air flow to control fuel flow to the engine. Fuel pressure regulation by means of a servo valve causes a minimal drop in fuel pressure throughout the metering system. Metering pressure is maintained above vapor forming conditions, yet fuel inlet pressure is low enough to allow the use of a diaphragm fuel pump. Thus vapor lock and associated problems of difficult starting are minimized.

PROPELLERS

Counter-rotation of the propellers provides balanced thrust during take-off and climb and eliminates the "critical engine" factor in single-engine flight.

The propellers are constant speed, controllable pitch, full feathering Hartzell propellers, operated by oil and nitrogen pressure. Compressed air may be used instead of nitrogen, provided it contains no moisture. Oil pressure sends the propeller toward the high RPM or unfeather position, while nitrogen pressure sends the propeller toward the low RPM or feather position and keeps the propeller from overspeeding. The recommended nitrogen pressure to be used when charging the unit is listed on placards on the propeller dome and inside the spinner. This pressure varies with ambient temperature at the time of charging. A governor, mounted on each engine, supplies oil through the propeller shaft at various pressures to maintain constant RPM settings.

Each propeller is controlled by use of the propeller control lever located in the center of the power control quadrant. Feathering of a propeller is accomplished by moving the control fully aft through the low RPM detent, into the feather position. Feathering takes place in approximately six seconds. Unfeathering is accomplished by moving the propeller control ahead and engaging the starter until the propeller is windmilling.

A feathering lock, operated by centrifugal force, prevents feathering during engine shut-down, by making it impossible to feather any time the engine speed is less than 800 RPM. For this reason if an engine is being feathered to save it the pilot must be sure to move the control to feather position before the engine speed drops below 800 RPM.

LANDING GEAR SYSTEM

To increase cruise speed, climb and other performance, the Seneca is equipped with a retractable tricycle landing gear, which is hydraulically operated. Rugged gear construction and a heavy duty braking system permit operation from a wide variety of landing areas.

Hydraulic pressure for gear operation is furnished by an electrically-powered reversible pump controlled by a two-position selector switch located on the instrument panel to the left of the control quadrant. The gear selector switch, which has a wheel-shaped knob, must be pulled out before it is moved to the "UP" or "DOWN" position. When hydraulic pressure is exerted in one direction the gear is retracted; when it is exerted in the other direction the gear is extended. If the landing gear is in transit and the hydraulic pump is running, it is inadvisable to move the gear selector switch to the opposite direction before it has reached its travel limit, because this sudden reversal may be harmful to the electric pump. Retraction or extension normally takes six to seven seconds.

Mounted on top of the engine is the ported fuel flow divider with four nozzle lines routed to the cylinders. The divider contains a spring loaded positive shut-off valve. Within each cylinder are continuous-flow air bleed nozzles with provisions to eliminate the adverse effects of low manifold pressure when idling. Since fuel metering is provided by the servo regulator rather than the nozzles, more uniform cylinder head temperatures result and longer engine life is possible.

Induction air for the engine enters an air scoop located on the outboard side of the lower cowl. The air is directed through a filter and thence to the servo regulator. To prevent engine malfunction if the air filter becomes blocked, the induction system incorporates a method of providing heated alternate air which does not pass through the filter. Located in the air box between the filter and servo regulator is a valve which is manually operated by the alternate air control located below the power quadrant. Since the alternate air is heated by the crossover exhaust tube, it gives extra protection against icing in the system caused by snow or freezing rain. Alternate air should not be used during ground operation because the unfiltered air may contain dust and other contamination. The primary induction source should always be used for take-off.

All throttle operations should be made with a smooth, not-too-rapid movement to prevent unnecessary engine wear, or damage to dynamic counterweights on the engines.

The pilot should read and follow the procedures recommended in the Lycoming Operator's Manual for this engine, in order to obtain maximum engine efficiency and time between engine overhauls.

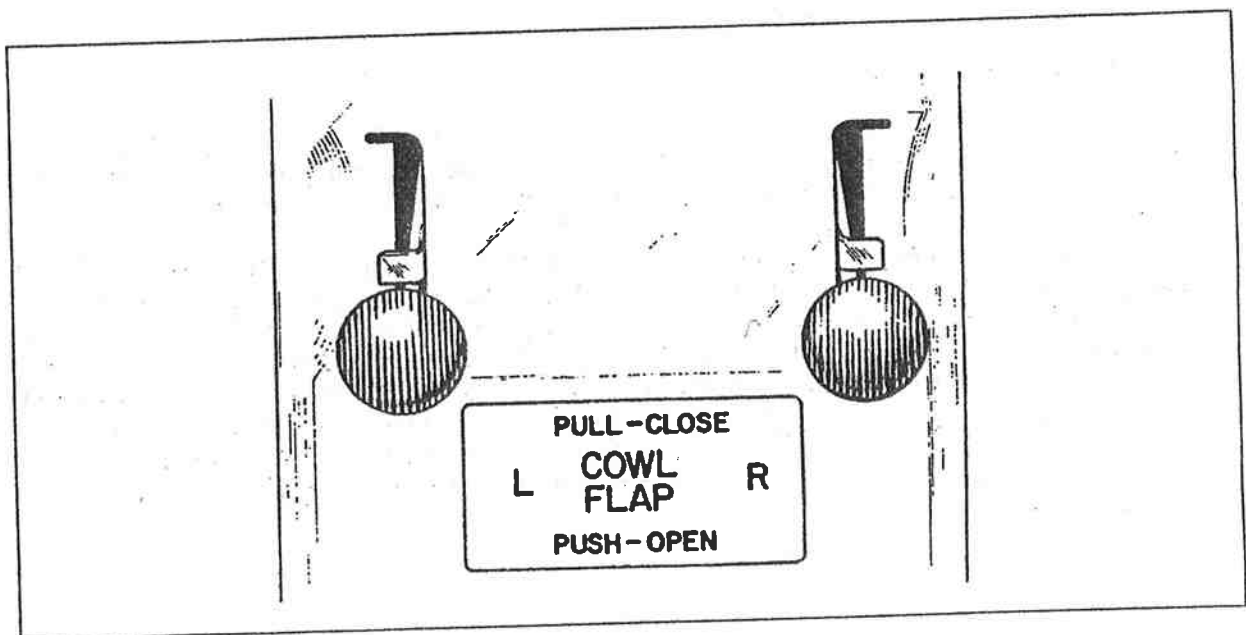

Cowl Flap Control

The gear system incorporates a number of features. Gear extension can be accomplished even in the event of hydraulic failure, since the gear is held up by hydraulic pressure. If the hydraulic system develops a leak or if the pressure is relieved for any reason, gravity will cause the gear to extend. Aerodynamic loads and springs assist in extending and locking the gear down. When the landing gear is retracted, the main wheels fold toward the centerline of the airplane and the nose gear retracts forward. Once the nose gear has started toward the down position, the airstream pushes against it and assists in moving it to the locked position. When the three gears are down and the downlock hooks engage, a spring maintains force on each hook in the locked position until it is released by hydraulic pressure.

To get the gear to extend and lock if the hydraulic pump fails, it is necessary only to relieve the hydraulic pressure. An emergency gear extension knob, located near the center of the instrument panel, is provided for this purpose. Pulling this knob releases the hydraulic pressure which holds the landing gear in the up position, and the gear can then fall free. A guard over the knob is provided to prevent inadvertent extension of the gear. Prior to pulling the emergency gear extension knob, it is advisable to place the gear selector in the DOWN position to prevent the pump from trying to raise the gear.

If the emergency gear knob has been pulled out to lower the gear by gravity, due to a gear system malfunction, leave the control in its extended position until the airplane has been put on jacks to check the proper function of the landing gears Hydraulic and Electrical systems. See Aircraft Service Manual for proper landing gear system check out procedures. If the airplane is being used for training purposes or a pilot check out mission, and the emergency gear extension has been pulled out, it may be pushed in again when desired if there has not been any apparent malfunction of the landing gear system.

When the gear is fully up or fully down and the selector is in the corresponding position, electrical limit switches stop the flow of current to the motor of the hydraulic pump. Three green lights indicate that the landing gear is down and locked, and a convex mirror on the left engine nacelle enables the pilot to confirm the position of the nose gear. When the gear is not in the full up or the full down position, a red warning light is illuminated on the instrument panel.

To add to the pilot's night vision comfort, the gear lights are automatically dimmed when the navigation lights are turned on. For this reason, if the navigation lights are unintentionally turned on in the daytime, it is difficult to see the landing gear lights. If the green lights are not observed after the landing gear switch is put in the DOWN position, the first thing to check is the position of the switch for the navigation lights.

If one or two of the three green lights do not illuminate when the gear down position has been selected, this could indicate that for each of the lights that is out, any of the following conditions might exist:

- a. The gear is not locked down.
- b. The bulb is burned out.
- c. There is a malfunction in the indicating system.

The square indicating lights can be pulled out and moved around in order to check the bulbs.

A micro switch incorporated in the throttle quadrant activates a warning horn under the following conditions:

1. Gear up and manifold pressure reduced below 14 inches on either one or both engines.
2. Gear selector switch in the UP position when the airplane is on the ground.

If the gear selector knob is placed in the "UP" position when the airplane is on the ground, a safety switch located on the left main gear will prevent the hydraulic pump from actuating if the master switch should be turned on. On take-off, when the oleo extends in excess of eight inches, the safety switch closes to complete the circuit so that the hydraulic pump can raise the landing gear when the gear switch is moved to the "UP" position. On take-off the gear should be retracted before an airspeed of 125 MPH is exceeded. It may be extended at any speed up to 150 MPH.

The nose gear is steerable through a 42-degree arc by use of the rudder pedals. As the gear retracts, the steering linkage disengages to reduce rudder pedal loads in flight and the nose wheel straightens as it enters the wheel well. A gear centering spring, incorporated in the nose gear steering system, prevents any tendency to shimmy.

The hydraulic reservoir for landing gear operation is an integral part of the gear hydraulic pump. Access to the combination pump and reservoir is through a panel in the nose baggage compartment. For filling instructions see the Seneca Service Manual.

The three landing gear wheels are the same size - 6.00-6. The nose wheel has a 6-ply tire and the main gear has 8-ply tires. Struts for nose and main gear are air-oil assemblies.

The brake system, which incorporates a single-disc double puck brake assembly on each main gear strut, is designed to meet all normal braking needs and to assist in the exceptional short-field landing capabilities of the Seneca. A brake system hydraulic reservoir, independent of the landing gear hydraulic reservoir, is located behind a panel at the rear top of the nose baggage compartment. The fluid should be maintained at the level marked on the reservoir. The brake assemblies are actuated by individual toe brake cylinders mounted on the left (optional on the right) set of rudder pedals and a handle-operated brake cylinder located below and behind the left center of the instrument panel.

The parking brake is actuated by pulling back on the handle and pushing forward on the button to the left of the handle. The brake can be released by pulling aft on the handle without touching the button, and allowing the handle to swing forward.

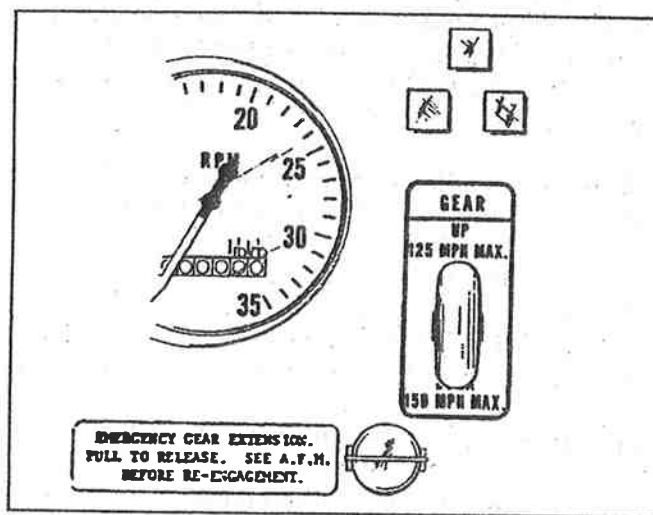

Landing Gear Actuator

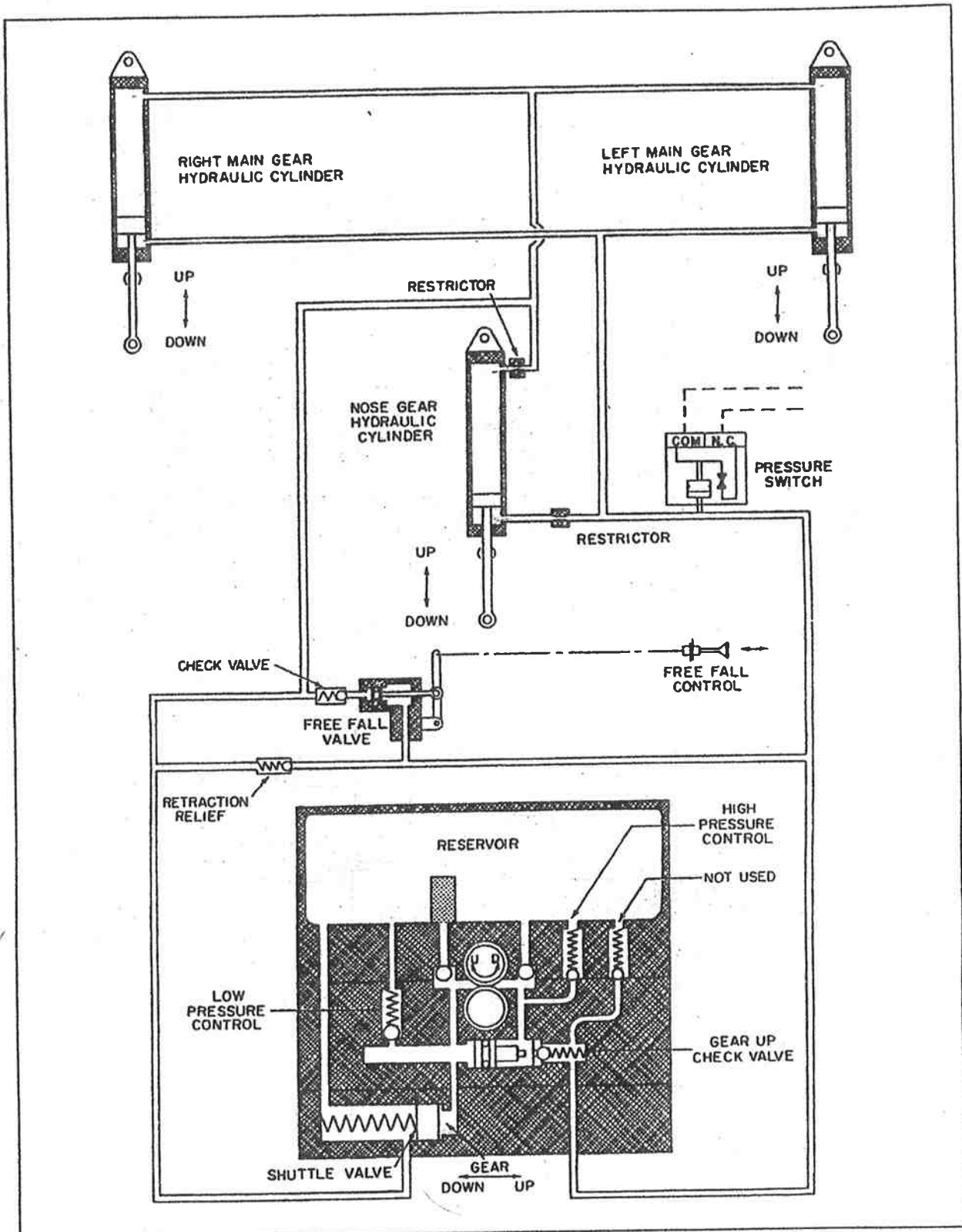

Hydraulic System Schematic

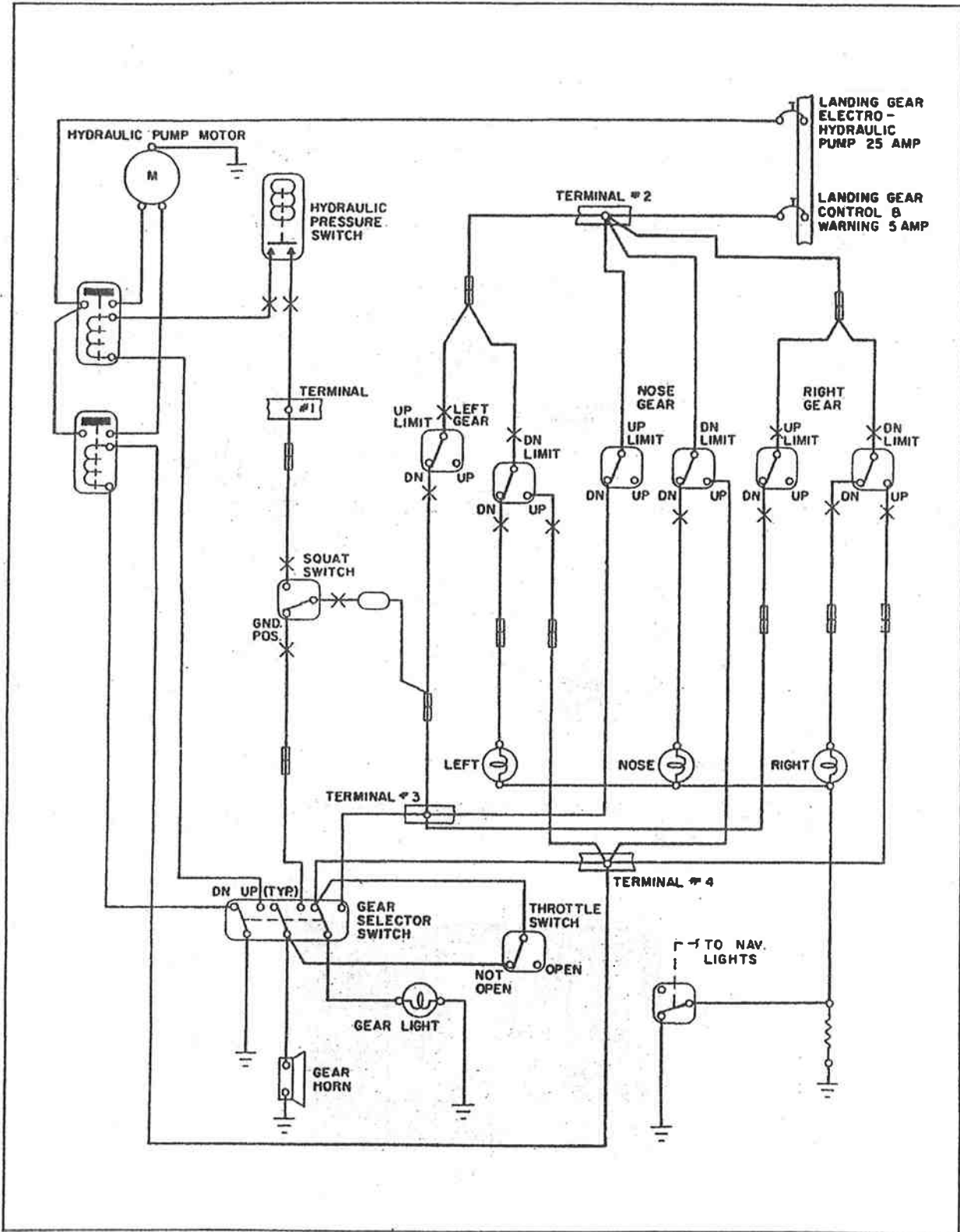

Landing Gear Electrical Schematic

FLIGHT CONTROL SYSTEMS

Dual controls are provided as standard equipment, with a cable system used between the controls and the surfaces. The horizontal tail (stabilator) is of the all movable slab type, with an anti-servo tab which also acts as a longitudinal trim tab, actuated by a control mounted on the control tunnel between the two front seats. The stabilator provides stability and controllability with less size, drag and weight than the more conventional horizontal stabilizer-elevator combination. The ailerons are provided with a differential action and are lightly interconnected by springs with the rudder. This arrangement tends to eliminate adverse yaw in turning maneuvers and to reduce the amount of coordination required in normal turns.

The flaps are manually extended, aerodynamically balanced for light operating forces and spring loaded to return to the retracted position. The flap control lever is located between the front seats on the floor. A button on the end of the lever must be depressed before moving the control. A past center lock incorporated in the actuating linkage holds the flap when it is in the retracted position so that it may be used as a step on the right side. Since the flap will not support a step load except when in the full retracted position, it should be completely retracted when people are entering and leaving the aircraft. The flaps have three extended positions, 10, 25 and 40 degrees.

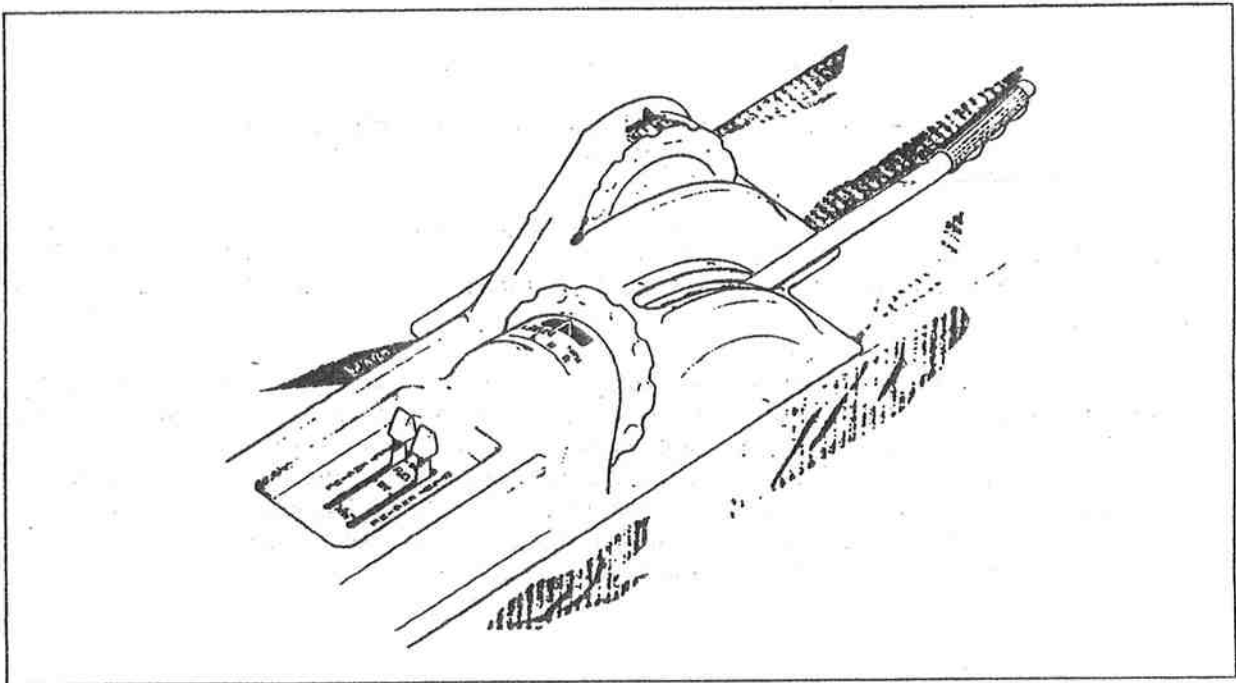

Console

FUEL SYSTEM

The Seneca fuel system offers two 24.5 gallon aluminum tanks in each wing which are interconnected to eliminate problems of tank selection and fuel management. Both tanks in each wing are filled with a single opening in the outboard tank, and fuel from the outboard tank flows into the inboard tank as the fuel from the inboard tank is consumed. The 98 gallon fuel capacity has only 2-1/2 unusable gallons on each side, making a total of 93 usable gallons. The fuel must be 100/130 octane (light green).

An engine-driven fuel pump is the primary means of supplying fuel for each engine. An electric fuel pump, located on the aft side of the firewall, is provided for each engine as a back-up in case of engine-driven fuel pump failure. The electric pump should be used during landings and take-offs to ensure sufficient fuel pressure in case of an engine-driven fuel pump failure during these portions of the flight sequence. Switches for the electric fuel pumps are conveniently located on the switch panel to the left of the pilot.

In normal operation, each engine operates with an independent fuel system, drawing fuel from the tanks in the wing on the same side as the engine. However, the two systems are interconnected by crossfeed lines which will permit an engine to use fuel from the tanks on the opposite side in order to extend single-engine range and to enable the pilot to keep fuel weight balanced. When crossfeed has been used during single-engine cruise operation, prior to landing the fuel selector should be positioned so that fuel is used from the same side as the operating engine. The fuel selectors, located on the funnel between the pilot and the copilot seats, reflect the simplified fuel system. Each lever has three positions: OFF, ON and CROSSFEED.

NOTE

Do not operate with both fuel selectors on CROSSFEED. Do not take off with a selector on CROSSFEED.

To permit the pilot to monitor the system, fuel pressure, fuel flow and fuel quantity gauges (a single fuel gauge for the two tanks in each wing) are mounted on the instrument panel. Fuel quantity sender units, one mounted in each fuel tank, transmit electrically the total quantity of fuel in each pair of tanks.

A gascolator (fuel filter) is located between the fuel selector valve and the electric fuel pump on each side. Quick drains are provided for the fuel gascolators (2), for each fuel tank (4) and each crossfeed line (2). Two fuel tank drains are located under each wing; crossfeed drains are located under the belly of the aircraft opposite the trailing edge of the right wing flap; gascolator drains are on the inboard side of the engine nacelles, forward and below the leading edge of the wing. The vent system for the fuel tanks consists of a vent in each fuel cap, a vent interconnect between the tanks in each wing, and an overflow line from the top of each filler neck.

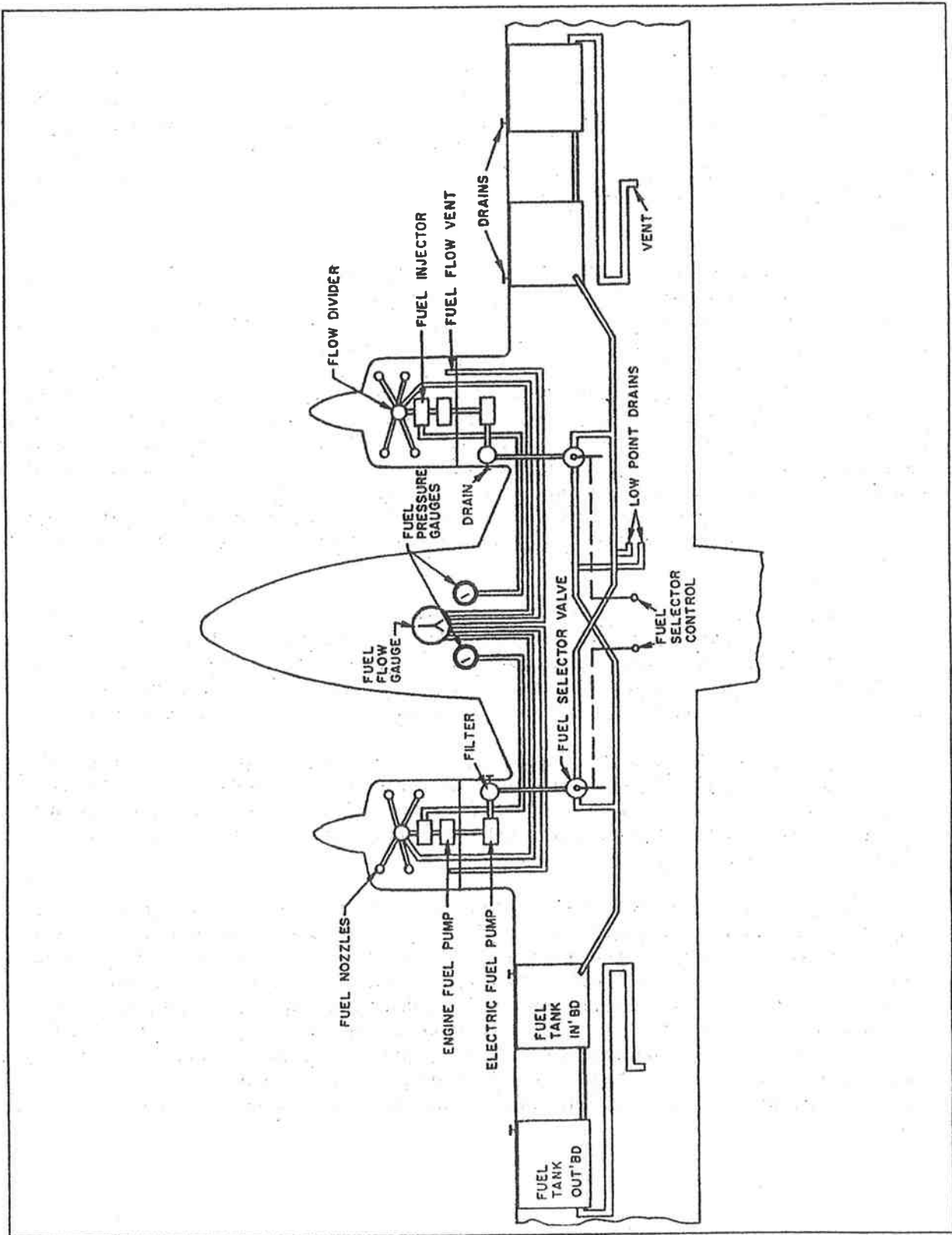

Fuel Schematic

ELECTRICAL SYSTEM

The electrical system of the Seneca is capable of supplying current for complete night IFR equipment. Electrical power is supplied by two 60-ampere alternators, one mounted on each engine. A 35 ampere-hour 12 volt battery provides current for starting, for use when the engines are not running, and for a source of stored electrical power to back up the alternator output. The battery, which is located in the nose section and is accessible through the forward baggage compartment, is normally kept charged by the alternators. If it becomes necessary to charge the battery, it should be removed from the airplane.

An external power source plug is available as optional equipment, and when installed is located on the lower left side of the nose. While an external 12-14 volt power source is being plugged in or unplugged, the master switch should be in the OFF position to prevent sparking. The master switch should be in the ON position, however, for engine starting with external power.

Two solid state voltage regulators are provided to maintain effective load sharing while regulating the electrical system bus voltage to 14.0 volts. In each alternator circuit an overvoltage relay is provided to prevent electrical damage to electrical and avionic equipment, by taking the alternator off the line if its output goes above 14.0 volts. When this occurs, a red light located on the left side switch panel illuminates to indicate that the overvoltage relay has tripped. This is the only function of this light; it does not necessarily come on for other failures of the alternator system. Voltage regulators and overvoltage relays are mounted on the forward side of the bulkhead at station 49.5

Circuit breakers are provided to protect equipment and the electrical system. These are located on the lower right hand instrument panel, and there is room for additional circuit breakers if extra electrical equipment is installed. A circuit breaker may trip automatically in case of equipment malfunctions or a sudden surge of current. The pilot can then reset it by pushing it in (preferably after a few minutes cooling period). However, he cannot pull out a circuit breaker manually.

Most of the electrical switches, including the master switch and those for the magnetos, fuel pumps, starter, alternators, lights and pitot heat, are conveniently located on the switch panel to the left of the pilot. A press switch near the top of the alternator-master switch panel turns on a light which is wired around the master switch and which permits the pilot to inspect the panel at night before turning on the master switch.

The alternator system has the advantage of being able to produce rated electrical output at low engine speed. The pilot of the Seneca is provided with an easy means of monitoring electrical system operation with dual ammeters and overvoltage warning lights. An ammeter is provided for each alternator. This acts as a load-meter, showing the amount of current being produced by the particular alternator. A zero reading would indicate that the alternator was not producing current. An indication near 60 would show that the electrical demand was taxing the alternator. In this case the pilot should turn off unnecessary electrical equipment to reduce the current required. When operating on a single engine, the pilot should be on guard against demanding too much from the one operating alternator because an overloaded alternator may burn out or its circuit breaker may trip,

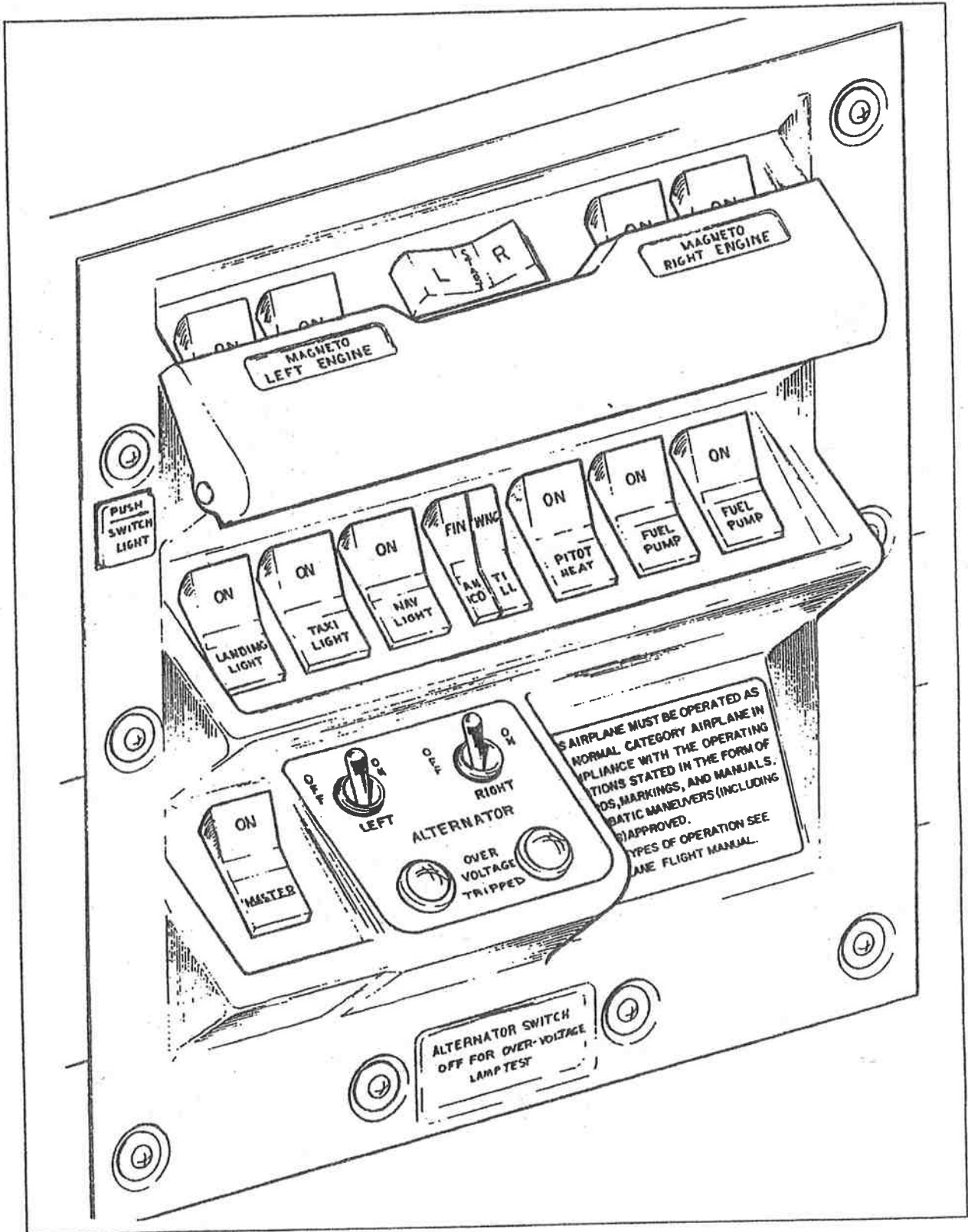

Switch Panel

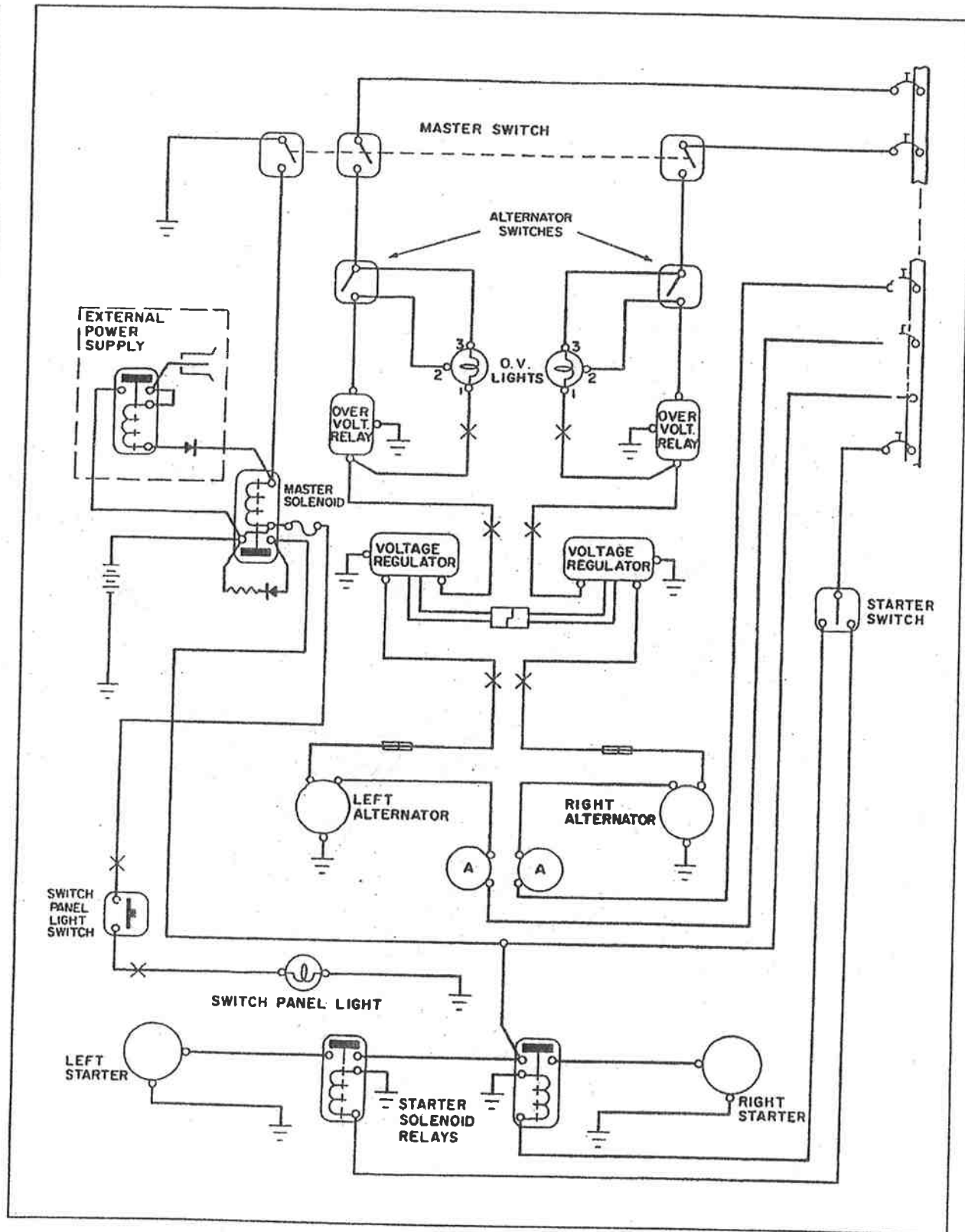

Alternator and Starter Schematic (Ser. Nos. 34-7250001 thru 34-7350135)

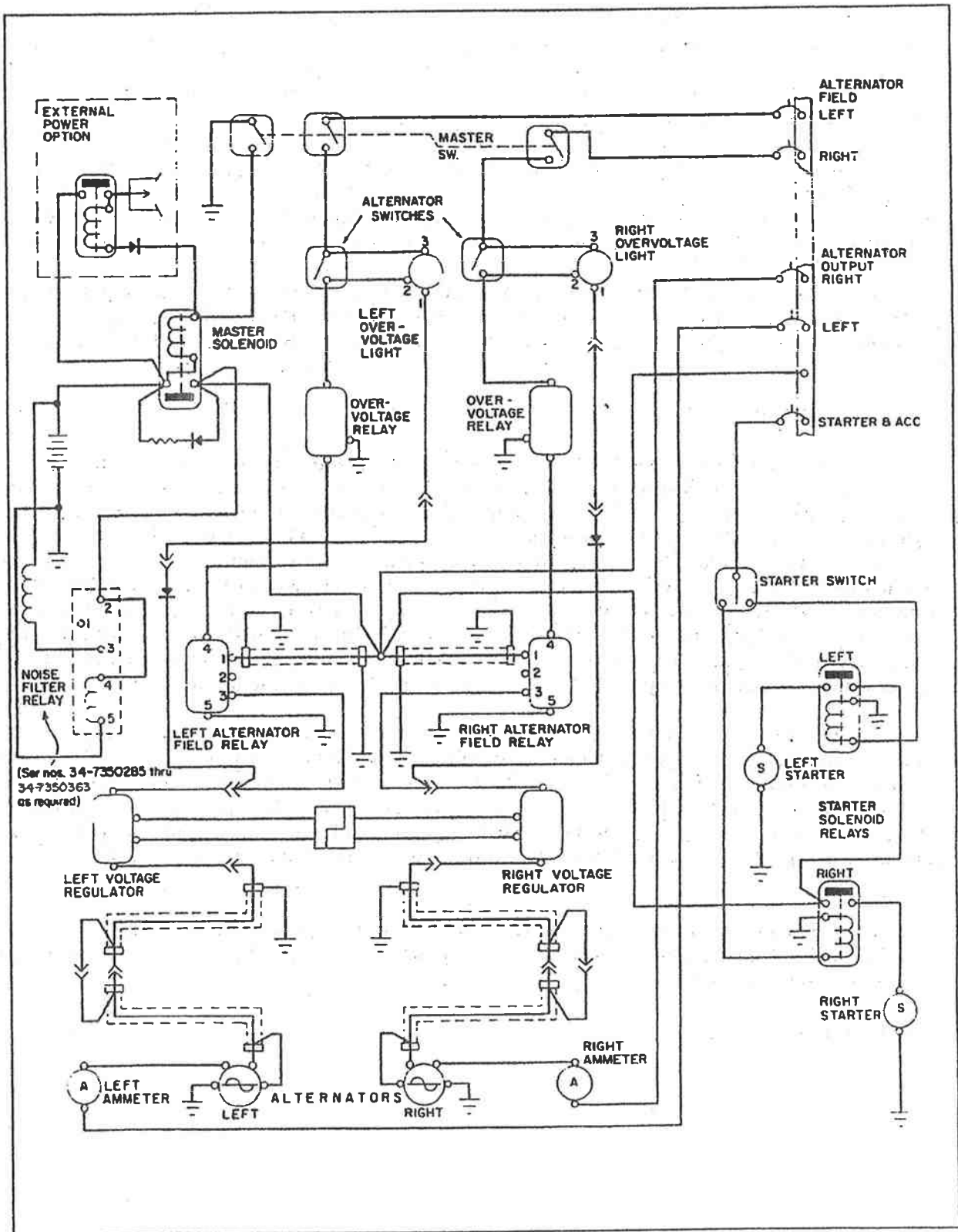

Alternator and Starter Schematic (Ser. Nos. 34-7350136 thru 34-7350363)

When all electrical equipment is turned off (except the master switch), the ammeters will indicate current being used to charge the battery and operate instrumentation. If the sum of the two readings is significant, this is an indication that the battery has a low charge. The pilot should try to determine why it is low, and if no cause is apparent the condition of the battery and the electrical system should be checked by a mechanic.

If during flight both alternators should fail, the battery becomes the only source of electrical power. Therefore all unnecessary equipment should be turned off. How long the battery will be able to supply the necessary equipment depends on the current drain of the equipment, time it took the pilot to notice the dual failure and the condition of the battery.

During night or instrument flight the pilot should continuously monitor the ammeters and warning lights so that he can take prompt corrective action if electrical malfunction occurs. Procedures for dealing with electrical malfunction are covered in the Airplane Flight Manual.

VACUUM SYSTEM*

The directional gyros and attitude indicators are operated by air drawn from the cabin through a filter and the instruments to the engine nacelle by a vacuum system. The vacuum system consists of one vacuum pump installed on each engine, plus plumbing and regulating hardware. If a second set of gyro instruments is installed, a second filter will be added for these instruments. The instruments are protected by a vacuum regulator mounted on the right aft side of each firewall. The regulators maintain a vacuum of $5.0 \pm .1$ inches of mercury at 2000 RPM. Suction is indicated by a vacuum gauge mounted to the left of the right control column. A vacuum less than 4.5 indicates a low air flow through the gyro instruments, with possibly inaccurate readings. Also incorporated in the system is a check valve, which is located behind the instrument panel on the upper right side of the baggage compartment bulkhead.

If suction is lost from either vacuum pump or from a leak in the hose of either side, the valve automatically closes and vacuum is supplied by one pump. In this case, one of two red malfunction buttons appears on the face of the vacuum gauge, indicating that vacuum is not available from that side. Each pump alone has sufficient capacity to operate a dual set of gyro instruments up to a 12,500-foot altitude. When operating with a single vacuum pump above that altitude, a high RPM setting must be maintained to get adequate suction for dual flight instruments.

Air filters are incorporated in the vacuum system to increase the life of the gyros. They are mounted behind the instrument panel in the upper corners of the baggage compartment and should be cleaned regularly.

*Optional Equipment

Vacuum Schematic

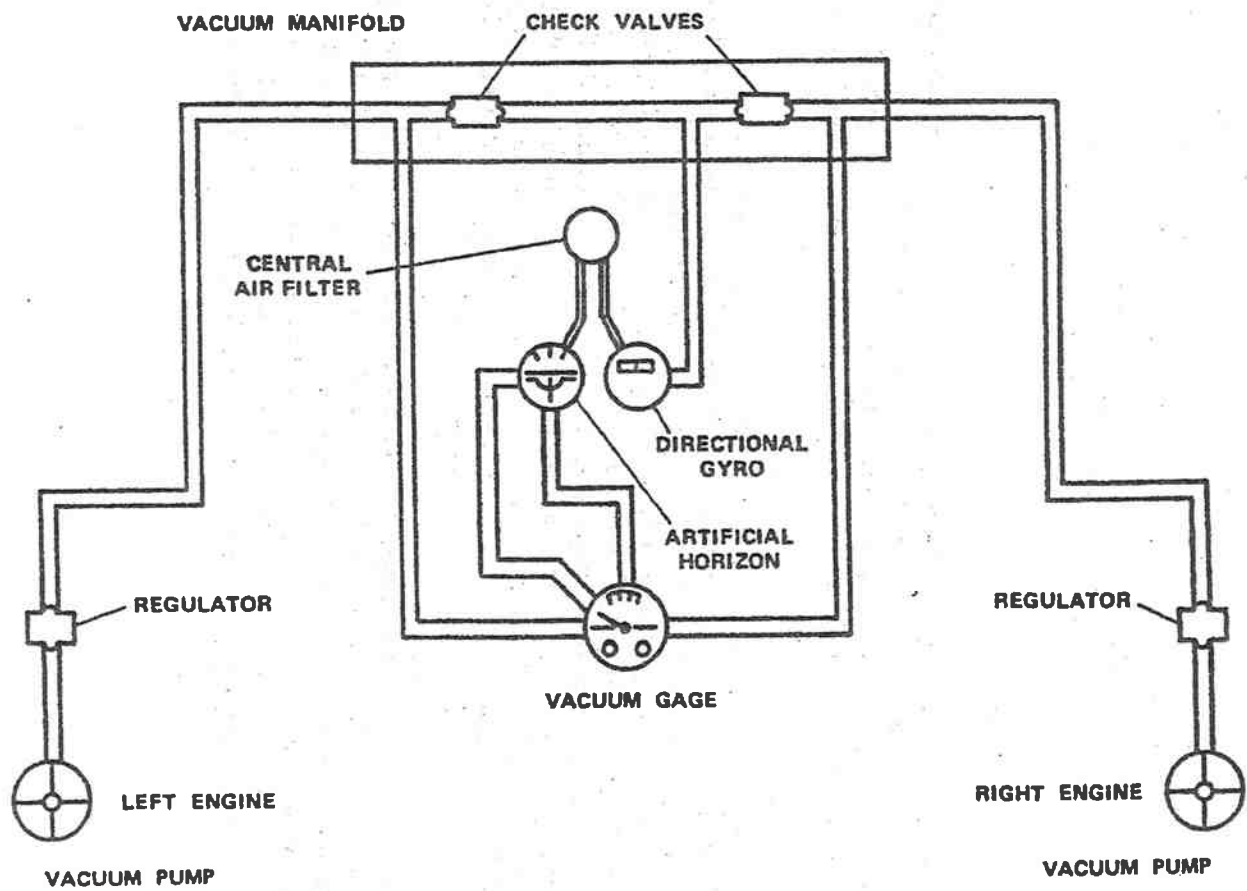

INSTRUMENT PANEL

The wide instrument panel of the Seneca offers sufficient space for two complete sets of flight instruments plus engine instruments and avionics, with ideal grouping and no crowding. Dual flight instruments are optional, and a wide range of additional optional instruments and avionics permits an equipment selection uniquely suited to individual needs. Flight instruments and avionics are grouped in the upper panel, while engine instruments, autopilot, electrical instruments and circuit breakers are located on the lower panel. Left engine and right engine instruments are conveniently separated by the control wheel shaft on the left side. In spite of the large instrument panel, over-the-nose visibility is good. A combination of white post lights (optional) and red floodlights ensure easy reading of the instruments at night.

PITOT-STATIC SYSTEMS

Pitot (total) pressure for the airspeed indicator is sensed by the aluminum mast mounted under the left wing. Static pressure for the altimeter, vertical speed and airspeed indicators is sensed by two static pressure units, one located on each side of the rear part of the fuselage. Differences in static pressure caused by a slip or skid are balanced out by a connection of the two static sources inside the fuselage.

The pitot mast can be equipped with a heating element to eliminate problems from ice or heavy rain. The static pressure sensors are not heated because experience indicates they are not likely to ice up. An alternate static source control valve is located below the instrument panel, to the right of the power quadrant. When the valve is set to alternate position, the altimeter, vertical speed indicator and airspeed indicator will be using cabin pressure for static pressure. These instruments may then give slightly different readings, depending on the situation within the cabin. Airspeed, setting of the heating and ventilating controls, or position of the storm window can influence cabin pressure. A pilot can see how his alternate static pressure affects the instruments, by switching from one source to the other at different airspeeds and ventilation configurations (including open storm window below 150 MPH).

The holes in the sensors for pitot and static pressure must be fully open and free from dirt, bugs and polish. If one or more of the pitot-static instruments malfunctions these pressure systems should be checked for leaks, dirt or water. If moisture is present, the static system can be drained by turning on the alternate static system. The selector valve is located at the low point of the system. Another drain is provided in the lower left front side panel to drain moisture from the pressure line running between the pitot mast and the instrument panel.

Instrument Panel

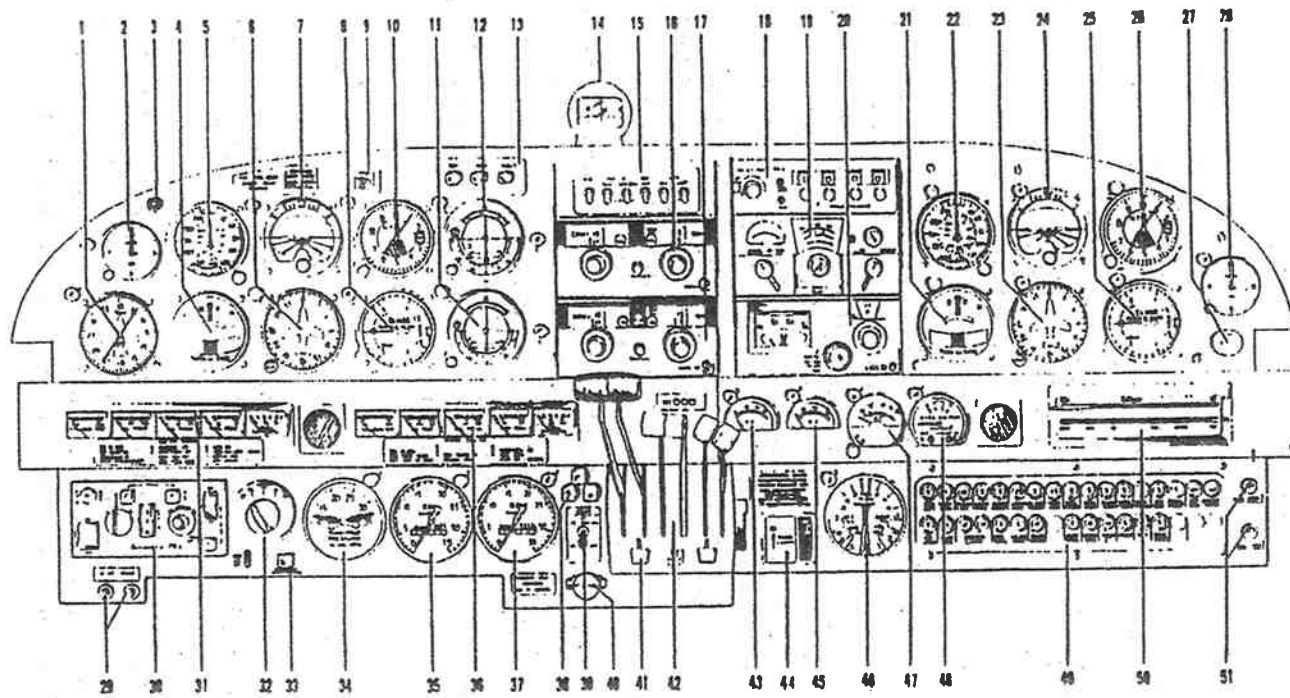

- | | | |
|---|---|--|
| 1. ADF INDICATOR | 18. TRANSPONDER | 36. RIGHT ENGINE AND FUEL INSTRUMENT CLUSTER |
| 2. CLOCK | 19. ADF RECEIVER | 37. RIGHT ENGINE TACHOMETER |
| 3. STALL WARNING LIGHT | 20. DME CONTROL AND INDICATOR | 38. LANDING GEAR DOWN LIGHTS |
| 4. TURN AND BANK INDICATOR | 21. TURN AND BANK INDICATOR (COPILOTS) | 39. LANDING GEAR SELECTOR |
| 5. AIRSPEED INDICATOR | 22. AIRSPEED INDICATOR (COPILOTS) | 40. LANDING GEAR FREE FALL VALVE CONTROL |
| 6. DIRECTIONAL GYRO | 23. DIRECTIONAL GYRO (COPILOTS) | 41. ALTERNATE AIR CONTROL |
| 7. ATTITUDE GYRO | 24. ALTITUDE GYRO (COPILOTS) | 42. CONTROL QUADRANT |
| 8. VERTICAL SPEED INDICATOR | 25. VERTICAL SPEED INDICATOR (COPILOTS) | 43. LEFT AMP METER |
| 9. GEAR UP LIGHT | 26. ALTIMETER (COPILOTS) | 44. PANEL LIGHT SWITCH |
| 10. ALTIMETER | 27. CIGAR LIGHTER | 45. RIGHT AMP METER |
| 11. OMNI INDICATORS | 28. CLOCK (COPILOTS) | 46. FUEL FLOW AND PRESSURE GAUGE |
| 12. OMNI AND GLIDE SLOPE INDICATORS | 29. MIKE AND PHONE JACKS | 47. EGT GAUGE |
| 13. MARKER BEACON RECEIVER LIGHTS | 30. ALTIMATIC IIII-1 AUTOPILOT | 48. GYRO SUCTION GAUGE |
| 14. MAGNETIC COMPASS | 31. LEFT ENGINE AND FUEL INSTRUMENT CLUSTER | 49. CIRCUIT BREAKER PANEL |
| 15. AUDIO CONTROL PANEL | 32. OMNI-COUPLER | 50. HEAT AND DEFROST CONTROLS |
| 16. COMMUNICATIONS AND NAVIGATION TRANSCEIVERS (NO.-1.) | 33. PITCH TRIM | 51. MIKE AND PHONE JACKS (COPILOTS) |
| 17. COMMUNICATIONS AND NAVIGATION TRANSCEIVERS (NO.-2.) | 34. MANIFOLD PRESSURE GAUGE | |
| | 35. LEFT ENGINE TACHOMETER | |

HEATING, VENTILATING AND DEFROSTING SYSTEM

The heating and ventilating system is designed to provide maximum comfort and controllability for pilot and passengers, with variable temperature-fresh air controls on the instrument panel and individual fresh air outlets controlled by the occupants.

Cabin and defrost heat is provided by a heat exchanger mounted on the exhaust manifold of each engine. Air is taken in through a scoop on the outboard side of each cowling and is then ducted through the heater muff, where it is heated by the exhaust manifold. A heat and defrost valve located on the forward side of the firewall sends some of the air directly to the windshield outlets when defrost is selected and sends the rest of the air to the temperature-fresh air control box, which regulates the temperature of the air to be introduced into the cabin interior. Fresh air for the cabin interior is taken in through inlets located in the leading edge of each wing. The fresh air is forced into the temperature-fresh air control box where it is mixed with heated air from the heat exchanger (as selected) and then into the cabin interior.

The cabin heat and defroster controls are located on the right side of the instrument panel. The defroster is equipped with a blower for use during ground operation to defog the windshield. The blower is energized when the mechanical defroster control lever is placed in the "full on" or "hi" position. The blower can be turned off in flight by moving the control lever away from the "full on" or "hi" position approximately one inch. When cabin heat and defrost heat controls are in the "OFF" position, heated air from the heat exchanger is dumped overboard. If maximum defrosting is desired, the heat to the cabin interior should be turned off and the defroster turned full on. An outlet near the feet of each occupant permits a flow of either heated or ventilating air, as selected by the control on the instrument panel.

Individual overhead fresh air outlets supply fresh air from an inlet located on each side of the lower leading edge of the vertical fin. The air is ducted to a plenum chamber and then to each individual adjustable outlet located in the ceiling. The amount and direction of air can be regulated for individual comfort. Rotating the rim of the outlet regulates the amount of air (clockwise to decrease the amount, counterclockwise to increase it), and moving the outlet in the desired direction of the air flow regulates the direction.

COMBUSTION HEATER*

An optional Janitrol combustion heater installed in the aft fuselage provides added air for cabin heating and windshield defrosting. The combustion heater can be used to supplement the standard muff-heater system.

Operation of the combustion heater is controlled by a three position switch located on a heater control console between the pilot's and copilot's seats, and labeled FAN, OFF, and HEATER. The "FAN" position will operate the ventilation blower only and may be used for cabin ventilation or windshield defogging on the ground when heat is not desired.

The defroster control lever for the standard muff-heater system must be in the "HI" position in order to energize the defroster blower any time defrosting or defogging is desired, with or without heat.

*Optional Equipment

For cabin heat, the air intake lever located on the heater control console must be partially or fully open and the three position switch set to "HEATER." This will start fuel flow and ignite the burner simultaneously. With instant starting and no need for priming, heat should be felt within a few seconds. Two safety switches which are installed and activated by the intake valve located aft of the Janitrol heater unit are wired to prevent both fan and heater operation unless the air intake lever is moved off the closed position.

Regulating the combustion cabin heat and airflow is accomplished by adjusting levers on the heater control console between the pilot's and copilot's seats. The right hand lever regulates the air intake valve. The left hand lever regulates cabin temperature. Cabin temperature and air circulation can be maintained by using various combinations of lever settings to suit individual desires.

Heat may be supplied to warm the cabin before starting engines by turning on the master switch, insuring mixture in the idle cut-off position, turning on the right auxiliary fuel pump, opening the air intake lever and placing the three position switch in the HEATER position.

The combustion cabin heater uses gasoline from the fuel line between the engine driven pump and injector on the right engine. Heater fuel consumption is one half gallon per hour. Fuel used for heater operation should be considered for Flight Planning Purposes. If the right fuel selector is in the off position the heater is inoperative.

In case of right engine failure the heater can be operated by leaving the fuel selector on, insuring that the mixture control is in idle cut-off position, while operating the auxiliary fuel pump. Before the heater is operated under these conditions, determine that there are no fuel leaks between the tank and the engine.

Located in the heater is a heat limit overheat switch, which acts as a safety device to render the heater system inoperative if a malfunction should occur. Operation of this switch results in illumination of the overheat light located on the heater control console. The heat limit switch is located in the forward outboard end of the heater vent jacket, with a red reset button on the heater shroud and can be reached through the bulkhead access panel into the aft fuselage.

To prevent activation of the overheat limit switch upon normal heater shutdown during ground operation, turn the switch to "FAN" for two minutes, while leaving the air intake lever in the open position, before turning the switch to the "OFF" position. During flight leave the air intake lever open for a minimum of 15 seconds after turning "OFF" the heater switch.

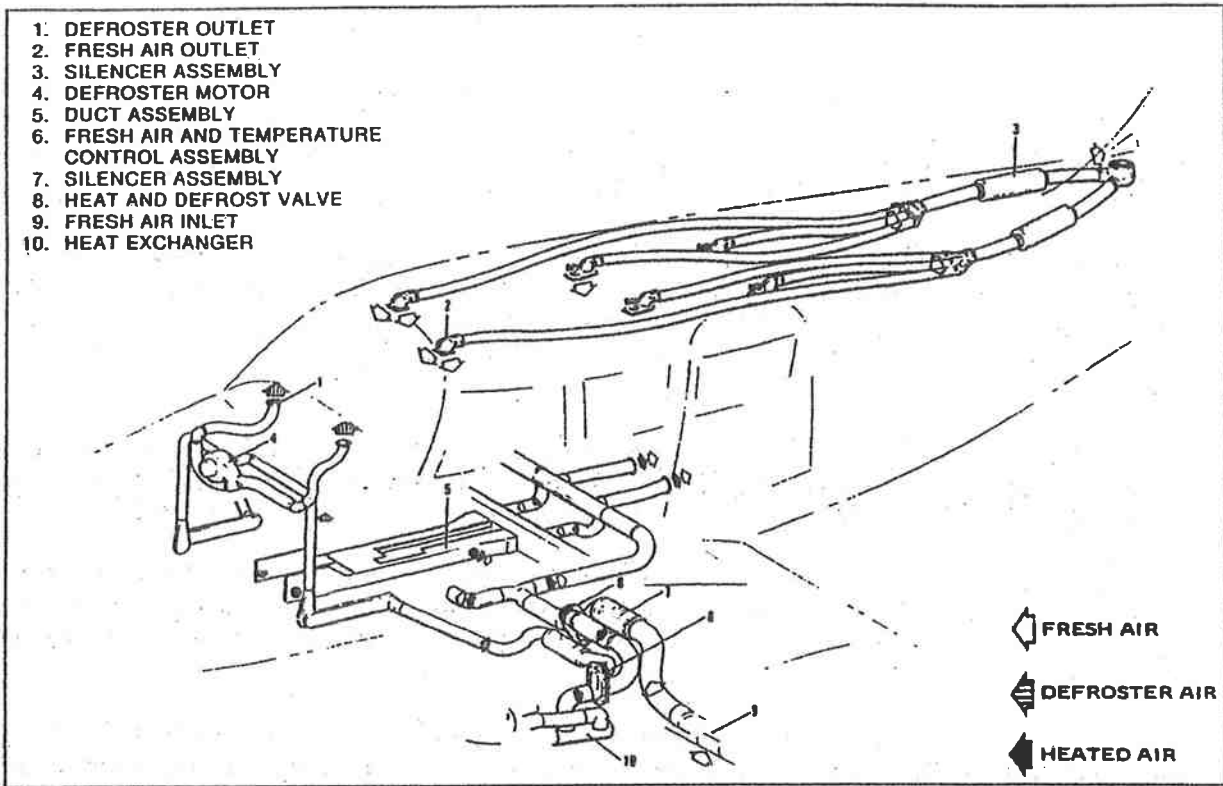

Heat and Ventilating System

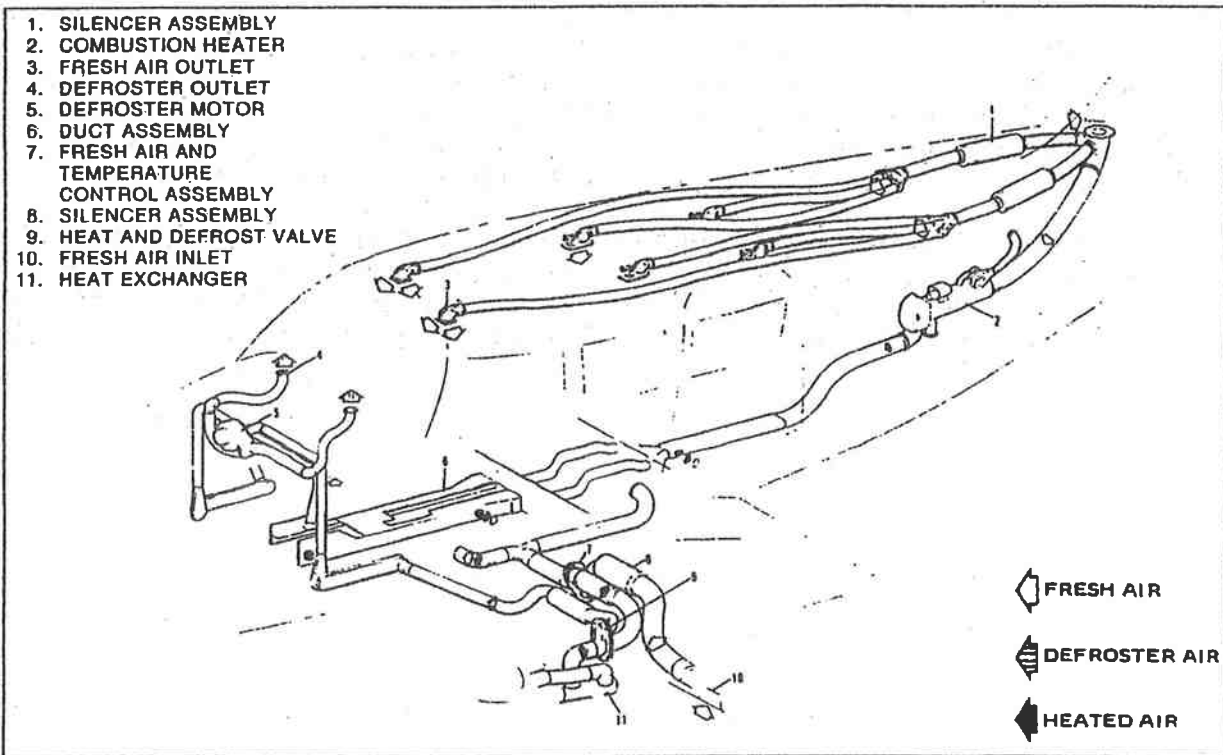

Optional Heating and Ventilating System

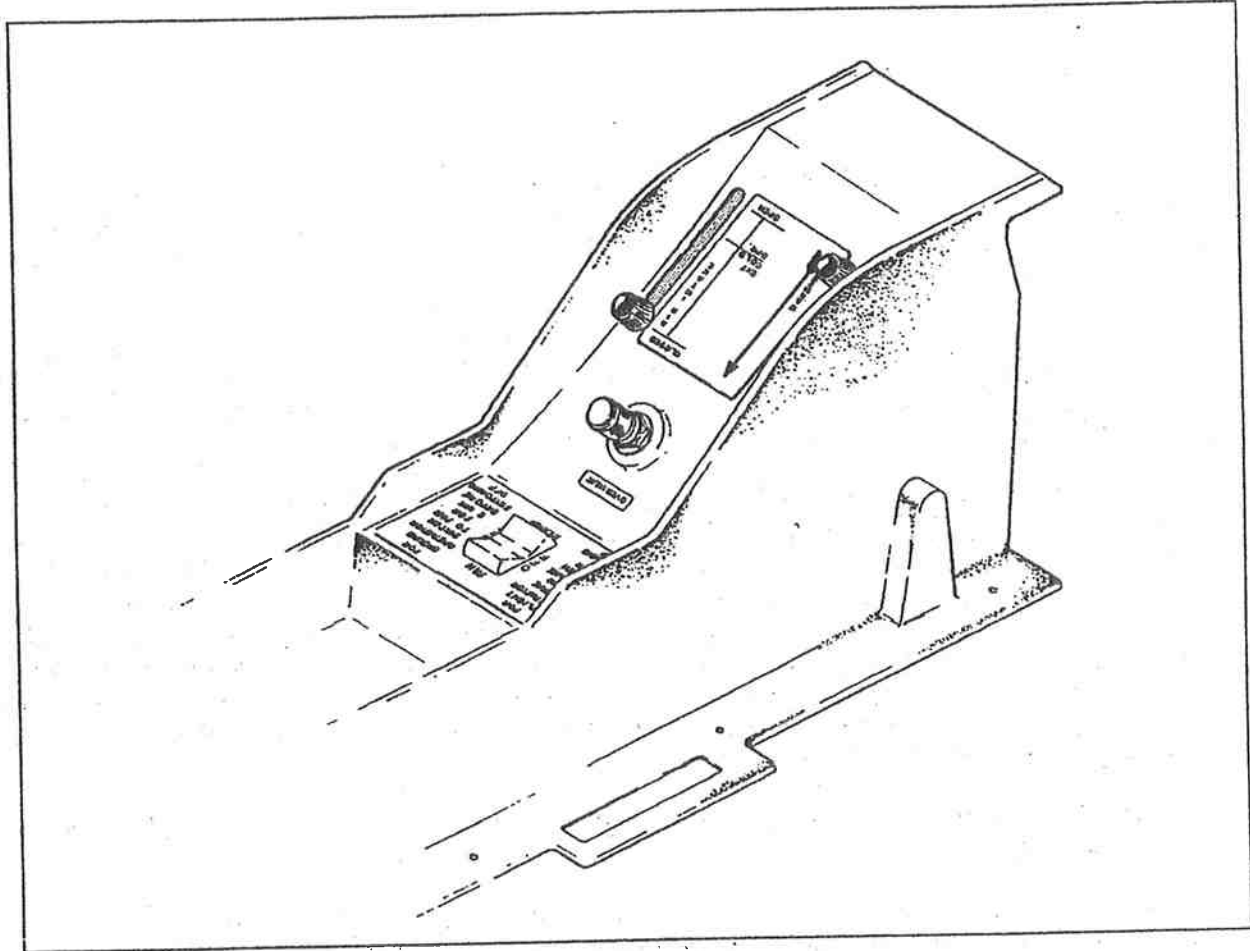

Optional Combustion Heater Control Console

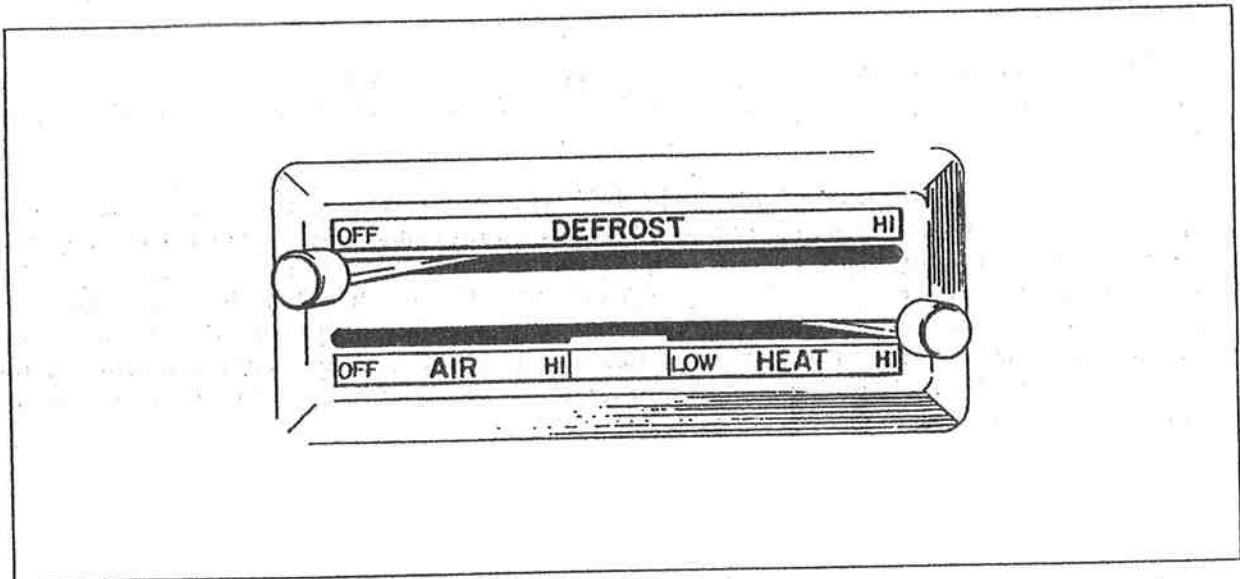

Heater and Defroster Controls

ICE PROTECTION SYSTEM*

A complete ice protection system is available as optional equipment in the Seneca to provide for flight into known icing conditions, when necessary.

This system consists of the following major components: pneumatic wing and empennage boots, wing ice detection light, electrothermal propeller deicer pads, electric windshield panel, heated stall warning transmitters, heated pitot head, anti-icing fuel tank vents, propeller governor shields and deflectors.

The pneumatic wing and empennage boots are installed on the leading edges of the wings, the vertical stabilizer and the horizontal stabilator. A constant suction is applied to all of the surface deicer boots from the engine driven vacuum pumps to provide smooth streamlined leading edges during normal operation with the surface deicer system off.

Deicer boots are inflated by a momentary "ON" type "SURFACE DE-ICE" switch located on the instrument panel directly above the control quadrant. Actuation of the "SURFACE DE-ICE" switch activates a system cycle timer which energizes the pneumatic pressure control valves for six seconds. The boot solenoid valves are activated and air pressure is released to the boots, inflating all surface deicers on the airplane. A "WING-TAIL DE-ICER" indicator light, with a "PRESS TO TEST" feature, illuminates when the surface deicer boots inflate. When the cycle is complete, the deicer solenoid valves permit automatic overboard exhaustion of pressurized air. Vacuum suction is then reapplied to the deicer boots. The deicer boots do not inflate during the "PRESS TO TEST" cycle.

Circuit protection for the surface deicer system is provided by a "WING-TAIL DE-ICERS" circuit breaker located in the circuit breaker panel.

Wing icing conditions may be detected during night flight with the use of an ice detection light installed in the outboard side of the left engine nacelle. The light is controlled by an "ICE LIGHT" switch located on the instrument panel to the right of the "SURFACE DE-ICE" switch. A "WING ICE LIGHT" circuit breaker located in the circuit breaker panel provides circuit protection.

Electrothermal propeller deicer pads are bonded to the leading edges of the propeller blades. Each deicer pad has two separate heaters, one for the outboard and one for the inboard half.

The system is controlled by an "ON-OFF" type "PROP DE-ICE" switch located to the right of the "SURFACE DE-ICE" switch above the control quadrant. Power for the propeller deicers is supplied by the airplane's electrical system through a "PROP DE-ICE" circuit breaker, located in the circuit breaker panel, to the "PROP DE-ICE" switch. When the "PROP DE-ICE" switch is actuated, power is supplied to a timer through the "PROP DE-ICER" ammeter which monitors the current through the propeller deicing system. With the propeller deicing system "ON," the "PROP DE-ICER" ammeter needle should be within the shaded portion on the ammeter for a normal reading.

*Optional equipment

Ice Protection System

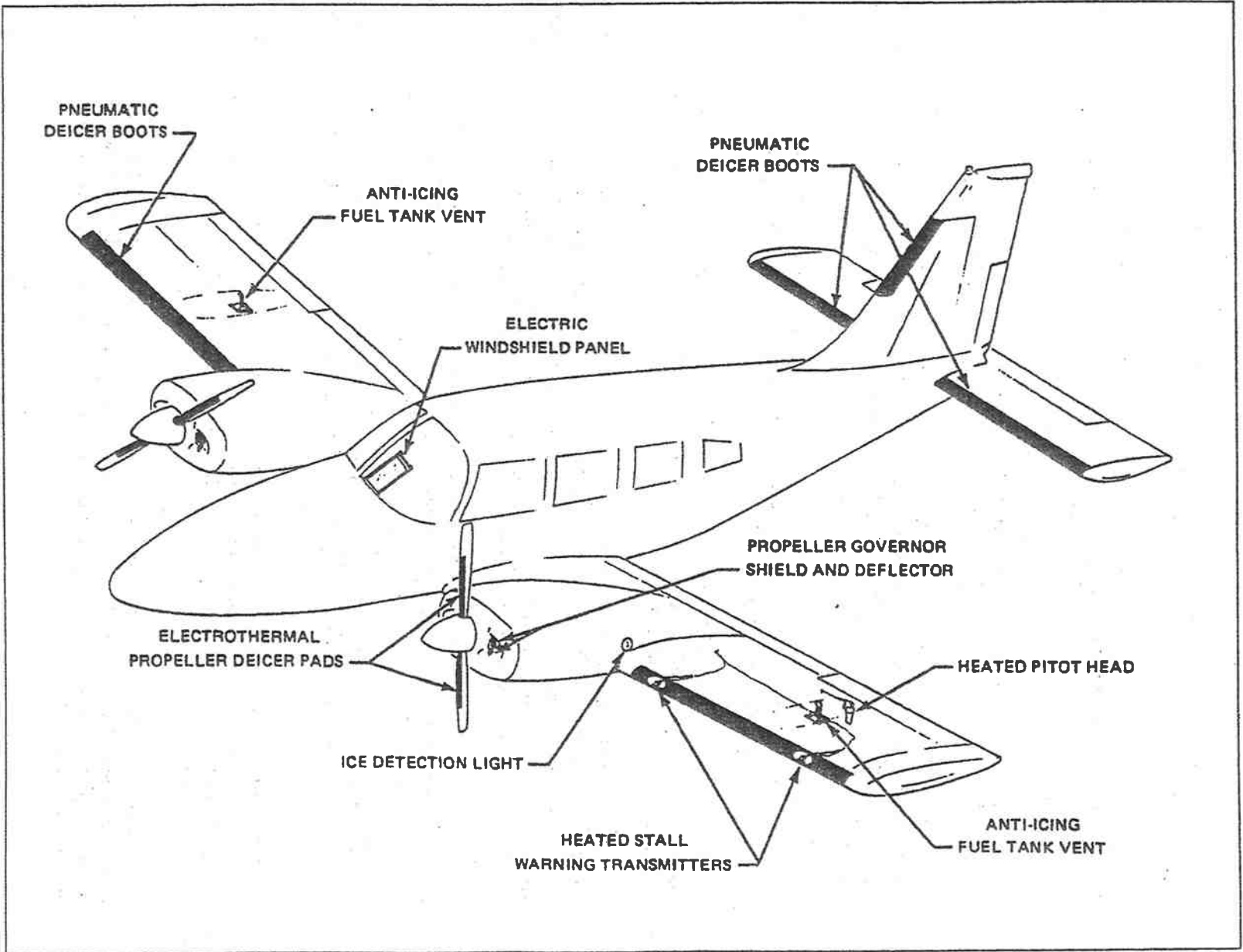

Power from the timer is cycled to brush assemblies which distribute power to modified starter ring gears incorporating slip rings. The current is then supplied from the slip rings directly to the electrothermal propeller deicer pads.

Deicing is accomplished by heating the outboard and then the inboard half of the deicer pads in a sequence controlled by the timer. The heating sequence of the deicer pads is according to the following cycle:

- a. Outboard halves of the propeller deicer pads on the right engine.
- b. Inboard halves of the propeller deicer pads on the right engine.
- c. Outboard halves of the propeller deicer pads on the left engine.
- d. Inboard halves of the propeller deicer pads on the left engine.

When the system is turned on, heating may begin on any one of the above steps, depending upon the positioning of the timer switch when the system was turned off from previous use. Once begun, cycling will proceed in the above sequence and will continue until the system is turned off.

A preflight check of the propeller deicers can be performed by turning the "PROP DE-ICE" switch "ON" and feeling the propeller deicer pads for proper heating sequence. The deicer pads should become warm to the touch.

The heat provided by the deicer pads reduces the adhesion between the ice and the propeller so that centrifugal force and the blast of airstream cause the ice to be thrown off the propeller blades in very small pieces.

A heated glass panel is installed on the exterior of the pilot's windshield to provide visibility in icing conditions. The panel is heated by current from the airplane's electrical power supply and controlled by an "ON-OFF" control switch/circuit breaker. The control switch/circuit breaker is located on the console directly below the control quadrant and placarded "WINDSHIELD PANEL HEAT - SEE ACFT FLIGHT MANUAL."

An operational check may be performed by turning the heated windshield panel switch "ON" for a period not exceeding 30 seconds. Proper operation is indicated by the glass section being warm to the touch.

Two heated lift detectors and a heated pitot head installed on the left wing are controlled by a single "ON-OFF," "HEATED PITOT" switch located on the switch panel to the left of the pilot.

The heated lift detectors, one inboard and one outboard on the left wing, are installed to prevent icing conditions from interfering with operation of the stall warning transmitters. A "STALL WARN HEAT" circuit breaker in the circuit breaker panel protects the system against an overvoltage condition.

A heated pitot head, mounted under the left wing, is installed to provide pitot pressure for the airspeed indicator with heat to prevent ice accumulation from blocking the pressure intake. The heated pitot head also has a separate circuit breaker located in the circuit breaker panel and labeled "PITOT HEAT."

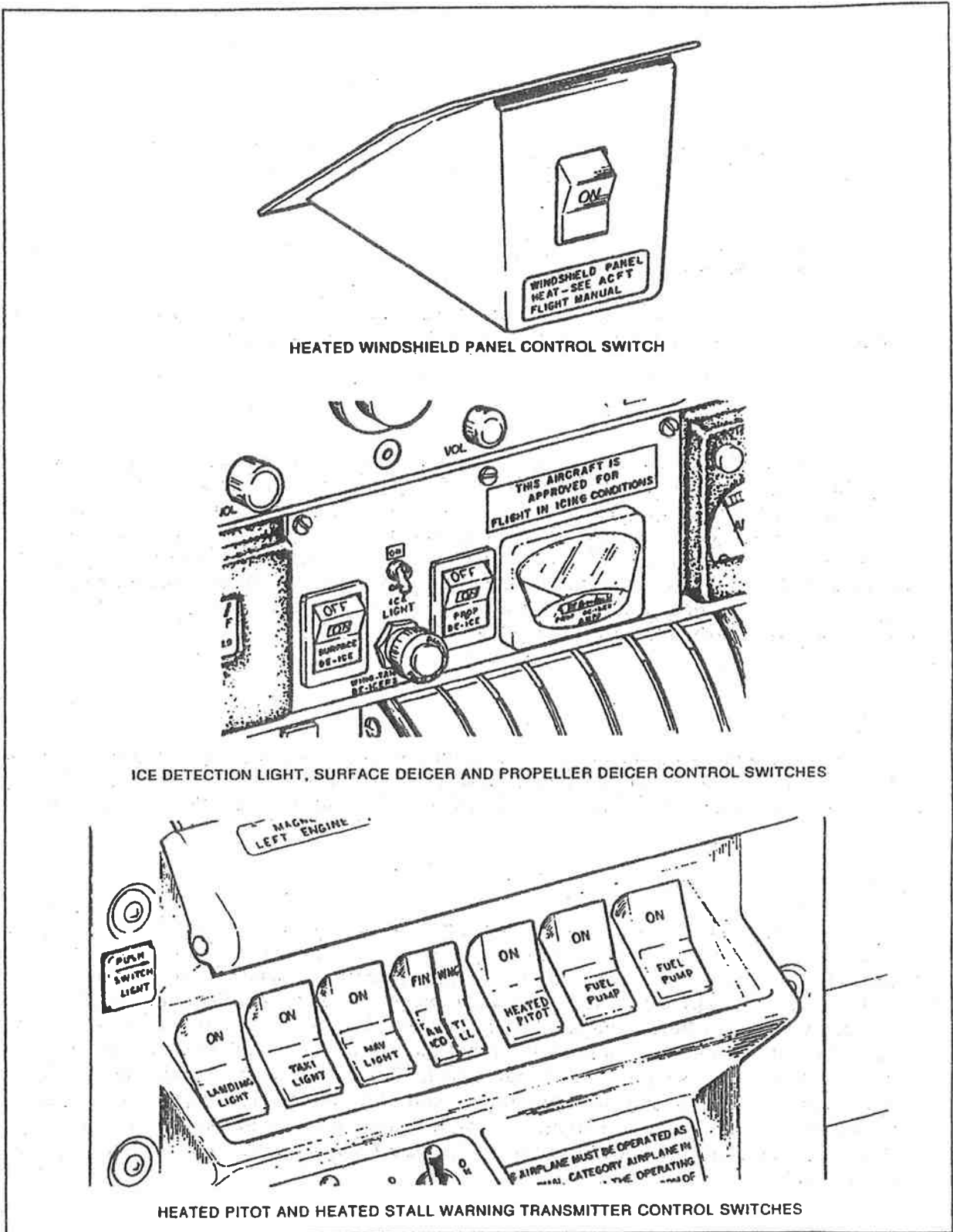

Ice Protection System Control Switches

With the "HEATED PITOT" switch "ON," check the heated pitot head and heated lift detector for proper heating.

CAUTION

Care should be taken when an operational check of the heated pitot head and the heated lift detectors is being performed. Both units become very hot.

Anti-icing fuel tank vents, one installed under each wing, are installed to prevent ice formations from blocking the fuel tank vent lines.

Propeller governor ice shields and deflectors are installed to prevent operational interference from ice and other particles entering through the opening in the front cowling.

SEATS

The front seats are adjustable fore and aft for pilot and passenger comfort. An easily accessible catch on the top of the right front seat permits one to slide that seat forward conveniently for ease of entry and exit. The center and rear seats are easily removable for added cargo space. Each seat is provided with an armrest and an adjustable back. Optional headrests and vertically adjustable front seats are also available. A jump seat, which may be mounted between the two middle seats, makes the Seneca a seven-place airplane. A shoulder harness with inertia reel is standard equipment for each of the two front seats and is available as optional equipment for the other seats except seventh seat.

FINISH

All sheet aluminum components are carefully finished to assure maximum service life. The exterior of the aircraft is finished with a durable acrylic lacquer in a variety of tasteful colors to suit individual owners. Economy size "Touch-Up" spray cans are available from Piper dealers.

BAGGAGE AREA

The large amount of available baggage space permits an exceptional flexibility of loading within the Seneca weight and balance envelope. Two separate baggage compartments are provided. One, located in the nose of the aircraft, is easily accessible through a baggage door on the left side of the aircraft. It has a maximum weight capacity of 100 pounds and a volume of 15.3 cubic feet. The other compartment is located aft of seats five and six and is accessible through the rear cabin door on the left side of the fuselage. It has a maximum weight capacity of 100 pounds and a volume of 20.0 cubic feet. This compartment is conveniently accessible during flight. Tie-down straps are provided in both the front and rear compartments and should be used whenever possible. An additional cargo loading door aft of the rear door is an optional feature which facilitates the loading of bulky items. All baggage and passenger loading doors use the same key.

STALL WARNING

An approaching stall is indicated by a stall warning light and horn, activated by two lift detectors installed on the leading edge of the left wing outboard of the engine nacelles. The inboard detector triggers the warning when the flaps are in the 25 and 40 degree positions, the outboard when the flaps are in the other positions. The stall warning horn has a different sound from that of the landing gear warning horn.

BLANK PAGE

AIRPLANE FLIGHT MANUAL
F. A. A. APPROVED

DUPLICATE

AIRPLANE FLIGHT MANUAL

FOR

SENECA

APPLICABLE TO SERIAL NUMBERS 34-7250001 THRU 34-7250189 WHEN PIPER KIT 760607 IS INSTALLED, 34-7250190 THRU 34-7250214 WHEN PIPER KIT 760611 IS INSTALLED AND 34-7250215 THRU 34-7350353.

WARNING

EXTREME CARE MUST BE EXERCISED TO LIMIT THE USE OF THIS REPORT TO APPLICABLE AIRCRAFT. THIS REPORT REVISED AS INDICATED BELOW OR SUBSEQUENTLY REVISED IS VALID FOR USE WITH THE AIRPLANE IDENTIFIED BELOW WHEN APPROVED BY PIPER AIRCRAFT CORPORATION. SUBSEQUENT REVISIONS SUPPLIED BY PIPER AIRCRAFT CORPORATION MUST BE PROPERLY INSERTED.

MODEL PA-34-200

AIRCRAFT SERIAL NO. 34-7350124 REGISTRATION NO. N 8875P

AIRPLANE FLIGHT MANUAL, REPORT NUMBER VB-423 REVISION 14

PIPER AIRCRAFT CORPORATION
APPROVAL SIGNATURE AND STAMP

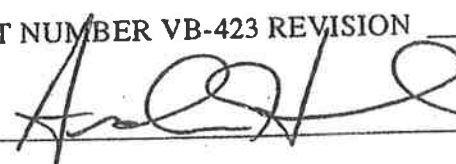
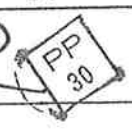
NOTE

THIS MANUAL MUST BE KEPT IN THE AIRPLANE AT ALL TIMES

FAA APPROVED BY: H. W. Barnhouse
H. W. BARNHOUSE
PIPER AIRCRAFT CORPORATION
D. O. A. No. SO-1
VERO BEACH, FLORIDA

DATE OF APPROVAL: MARCH 10, 1972

APPROVAL BASIS: FAR 23 AND FAR PART 21, SUBPART J.

REPORT: VB-423
MODEL: PA-34-200

BLANK PAGE

AIRPLANE FLIGHT MANUAL

Log of Revisions.....	3-iii
Limitations.....	3-1
Procedures	3-7
Emergency Procedures	3-11
Performance.....	3-19
Supplements.....	3-21

BLANK PAGE

TABLE OF CONTENTS

Log of Revisions..... 3-iii

SECTION I

Limitations..... 3-1

- A. Engines..... 3-1
- B. Fuel 3-1
- C. Propellers 3-1
- D. Instrument Markings (Power Plant)..... 3-1
- E. Airspeed Limitations and Indicator Markings (Calibrated Airspeed) 3-2
- F. Flight Load Factors..... 3-2
- G. Maximum Weight 3-3
- H. C. G. Range..... 3-3
- I. Unusable Fuel 3-3
- J. Usable Fuel 3-3
- K. Placards..... 3-3
- L. Vacuum Gauge..... 3-6
- M. Flight Into Known Icing Conditions 3-6

SECTION II

Procedures..... 3-7

- A. Normal Procedures 3-7
 - 1. Wing Flap Settings..... 3-7
 - 2. Cowl Flaps 3-7
 - 3. Go-Around Procedures 3-7
- B. System Operations and Checks..... 3-7
 - 1. Alternator System Description 3-7
 - 2. Alternator System Operation 3-8
 - 3. Circuit Breakers..... 3-8
 - 4. Fuel Management 3-8
 - 5. Landing Gear Down Lights 3-9
 - 6. Landing Gear Unsafe Warnings..... 3-9
 - 7. Rear Cabin and Cargo Doors Removed..... 3-9

C.	Emergency Procedures.....	3-11
1.	Detecting a Dead Engine	3-11
2.	Feathering Procedure	3-11
3.	Unfeathering Procedure	3-12
4.	Fuel Management During Single Engine Operation	3-12
5.	Engine Failure During Takeoff	3-12a
6.	Engine Failure During Climb	3-13
7.	Single Engine Landing	3-13
8.	Single Engine Go-Around	3-13
9.	Manual Extension of Landing Gear	3-14
10.	Landing Gear Unsafe Warnings.....	3-14
11.	Gear-Up Emergency Landing.....	3-14
12.	Electrical Failures	3-14
13.	Vacuum Systems Failures	3-16
14.	Engine Fire.....	3-16
15.	Spins	3-17
16.	Engine Failure In Icing Conditions.....	3-17
17.	Alternator Failure In Icing Conditions	3-17
18.	Engine Failure With Rear Cabin and Cargo Doors Removed	3-17
19.	Propeller Overspeed.....	3-18
D.	Special Operating Procedures	3-18a
1.	Flight In Known Icing Conditions	3-18a

SECTION III

	Performance	3-19
A.	Stalls	3-19
1.	Power Off Stalls.....	3-19
2.	Power On Stalls	3-19
3.	Stall Warning System.....	3-19
B.	Stalling Speeds (MPH, Calibrated Airspeed) vs Angle of Bank	3-19
C.	Aircraft Performance With Rear Cabin and Cargo Doors Removed.....	3-19

SECTION IV

	Supplements	3-21
A.	Electric Pitch Trim Installation.....	3-23
B.	AutoControl III Installation	3-24
C.	AltiMatic IIIB-1 Installation.....	3-25
D.	AltiMatic V/FD-1 and AltiMatic V-1 Installation	3-26
E.	Windshield Heating Installation	3-28
F.	Cabin Combustion Heater Installation.....	3-29



LOG OF REVISIONS

Revision	Revised Pages	Description and Revision	FAA Approved Date
1	i, ii 9 14	Changed wording for Items II. B. 6. and II. C. 10. Changed Item 6. - Landing Gear Unsafe Warnings. Changed Item 10. - Landing Gear Unsafe Warnings.	May 8, 1972 <i>H. W. Barnhouse</i> H. W. Barnhouse
2	3-ii 3-21 3-26 3-27 3-28	Under Section IV added item D. Added AltiMatic V/FD Installation. Added entire contents of page. Added page. Added page.	July 7, 1972 <i>H. W. Barnhouse</i> for H. W. Barnhouse
3	3-ii 3-10 3-11 3-12	Changed page nos. under Item C., Section II. Note added. Contents rearranged. Contents rearranged.	August 2, 1972 <i>H. W. Barnhouse</i> H. W. Barnhouse
4	3-ii 3-6 3-21, 3-28	Added item E. - Windshield Heating Installation to Section IV. Added Windshield Heating Placards. Added E. - Windshield Heating Installation.	Sept. 15, 1972 <i>H. W. Barnhouse</i>
5	3-ii 3-21 3-26 3-27	Corrected Item D. under Section IV. Corrected Item D. Changed D. to V/FD-1 or V-1. Changed Item D. 2. b. to V/FD-1 or V-1 Information Manual.	Nov. 16, 1972 <i>H. W. Barnhouse</i> for H. W. Barnhouse
6	3-ii 3-21, 3-29	Added Supplement F. Added F. - Cabin Combustion Heater Instl.	Dec. 20, 1972 <i>H. W. Barnhouse</i> H. W. Barnhouse
7	3-i, 3-ii 3-9 3-10 3-11	Retyped Pages. Changed Item 6. - Landing Gear Unsafe Warnings. Contents moved to Page 3-11. Contents moved to Page 3-12.	May 25, 1973

FAA APPROVED March 10, 1972
REVISED: May 25, 1973

REPORT: VB-423 PAGE 3-iii
MODEL: PA-34-200

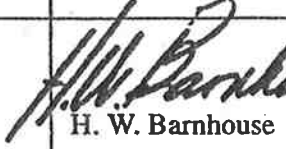
LOG OF REVISIONS (cont)

Revision	Revised Pages	Description and Revision	FAA Approved Date
7 (cont)	3-12 3-12a 3-12b	Contents moved to Page 3-12a. Added Page. Added Page.	 H. W. Barnhouse
8	Title 3-1 3-2	Added Serial No. effectivity. Revised Item C. Propeller Limitations. Revised Tachometer Limitations.	Sept. 19, 1973  H. W. Barnhouse
9	3-i 3-ii 3-3 3-4 3-6 3-9 3-15 3-17 3-18 3-19	Added Item M. - Flight Into Known Icing Conditions and Item B. 7 - Rear Cabin and Cargo Doors Removed. Added Item C. 16 - Engine Failure In Icing Conditions, Item C. 17 - Alternator Failure In Icing Conditions, Item C. 18 - Engine Failure With Rear Cabin and Cargo Doors Removed, Item D - Special Operating Procedures and Item D. 1 - Flight In Known Icing Conditions; Added Item C. - Aircraft Performance With Rear Cabin and Cargo Doors Removed. Added Icing Placard and relocated Weight Placard to page 3-4. Added Weight Placard from page 3-3. Added Placard for Aft Fuselage Doors Removed and Item M. - Flight Into Known Icing Conditions. Added Item 7. - Rear Cabin and Cargo Doors Removed. Revised Item c. Added Item 16. - Engine Failure In Icing Conditions, Item 17. - Alternator Failure In Icing Conditions and Item 18. - Engine Failure With Rear Cabin and Cargo Doors Removed. Added Item D. - Special Operating Procedures and Item D. 1 - Flight Into Known Icing Conditions. Added Item C. - Aircraft Performance With Rear Cabin and Cargo Doors Removed.	April 26, 1974  D. H. Trompler

LOG OF REVISIONS (cont)

Revision	Revised Pages	Description and Revision	FAA Approved Date
10	Title	Added PAC Approval Form (NOTE: AIRCRAFT DELIVERED WITH MANUALS PRIOR TO THIS REVISION DO NOT REQUIRE THIS REVISION.)	Oct. 14, 1974 <i>Ward Evans</i> Ward Evans
11	3-3 3-5	Revised usable fuel quantities - Item J. Usable Fuel. Revised usable fuel capacity - filler cap placard.	May 30, 1975 <i>Ward Evans</i> Ward Evans
12	3-ii 3-1 3-3 3-18 3-18a 3-18b	Added item 18., Propeller Overspeed; revised page nos. Revised Oil Pressure Red Line (Minimum). Added Maximum Landing Weight (item G.). Added item 19. (Propeller Overspeed); relocated Special Operating Procedures. Added page (Special Operating Procedures from page 3-18). Added page.	August 19, 1975 <i>Ward Evans</i> Ward Evans
13	3-4 3-8 3-9 3-12 3-14 3-15	Revised emergency gear extension placard. Added item 4. b. (1) (c). Deleted info under item 4. c. Added item 4. a. (3). Added item 9. e. and Warning; relocated info to pg. 3-15. Added items 12 (3) and (4) from pg. 3-14.	April 1, 1977 <i>Ward Evans</i> Ward Evans
14	3-18a 3-18b	Added to Warning. Added Caution.	June 14, 1983 <i>Ward Evans</i> Ward Evans

THIS PAGE INTENTIONALLY LEFT BLANK

AIRWORTHINESS DIRECTIVE



REGULATORY SUPPORT DIVISION
P.O. BOX 26460
OKLAHOMA CITY, OKLAHOMA 73125-0460

U.S. Department
of Transportation
**Federal Aviation
Administration**

The following Airworthiness Directive issued by the Federal Aviation Administration in accordance with the provisions of Federal Aviation Regulations, Part 39, applies to an aircraft model of which our records indicate you may be the registered owner. Airworthiness Directives affect aviation safety and are regulations which require immediate attention. You are cautioned that no person may operate an aircraft to which an Airworthiness Directive applies, except in accordance with the requirements of the Airworthiness Directive (reference FAR Subpart 39.3).

99-14-01 THE NEW PIPER AIRCRAFT, INC.: Amendment 39-11209; Docket No. 98-CE-77-AD; Supersedes AD 98-04-27, Amendment 39-10339.

Applicability: Models PA-23, PA-23-160, PA-23-235, PA-23-250, PA-E23-250, PA-30, PA-39, PA-40, PA-31, PA-31-300, PA-31-325, PA-31-350, PA-31P, PA-31T, PA-31T1, PA-31T2, PA-31P-350, PA-34-200, PA-34-200T, PA-34-220T, PA-42, PA-42-720, and PA-42-1000 airplanes, all serial numbers, certificated in any category.

NOTE 1: This AD applies to each airplane identified in the preceding applicability provision, regardless of whether it has been modified, altered, or repaired in the area subject to the requirements of this AD. For airplanes that have been modified, altered, or repaired so that the performance of the requirements of this AD is affected, the owner/operator must request approval for an alternative method of compliance in accordance with paragraph (d) of this AD. The request should include an assessment of the effect of the modification, alteration, or repair on the unsafe condition addressed by this AD; and, if the unsafe condition has not been eliminated, the request should include specific proposed actions to address it.

Compliance: Required as follows, unless already accomplished:

1. **For all affected airplanes, except for Models PA-31P, PA-31T, PA-31T1, PA-31T2, and PA-31P-350 airplanes:** Within 30 days after March 13, 1997 (the effective date of AD 98-04-27).
2. **For all Models PA-31P, PA-31T, PA-31T1, PA-31T2, and PA-31P-350 airplanes:** Within the next 30 days after the effective date of this AD.

To minimize the potential hazards associated with operating the airplane in severe icing conditions by providing more clearly defined procedures and limitations associated with such conditions, accomplish the following:

- (a) At the applicable compliance time presented in the **Compliance** section of this AD, accomplish the requirements of paragraphs (a)(1) and (a)(2) of this AD.

NOTE 2: Operators should initiate action to notify and ensure that flight crewmembers are apprised of this change.

- (1) Revise the FAA-approved Airplane Flight Manual (AFM) by incorporating the following into the Limitations Section of the AFM. This may be accomplished by inserting a copy of this AD in the AFM.

“WARNING

Severe icing may result from environmental conditions outside of those for which the airplane is certificated. Flight in freezing rain, freezing drizzle, or mixed icing conditions (supercooled liquid water and ice crystals) may result in ice build-up on protected surfaces exceeding the capability of the ice protection system, or may result in ice forming aft of the protected surfaces. This ice may not be shed using the ice protection systems, and may seriously degrade the performance and controllability of the airplane.

- During flight, severe icing conditions that exceed those for which the airplane is certificated shall be determined by the following visual cues. If one or more of these visual cues exists, immediately request priority handling from Air Traffic Control to facilitate a route or an altitude change to exit the icing conditions.
 - Unusually extensive ice accumulation on the airframe and windshield in areas not normally observed to collect ice.
 - Accumulation of ice on the upper surface of the wing, aft of the protected area.
 - Accumulation of ice on the engine nacelles and propeller spinners farther aft than normally observed.
- Since the autopilot, when installed and operating, may mask tactile cues that indicate adverse changes in handling characteristics, use of the autopilot is prohibited when any of the visual cues specified above exist, or when unusual lateral trim requirements or autopilot trim warnings are encountered while the airplane is in icing conditions.

SECTION I
LIMITATIONS

The following limitations must be observed in the operation of this airplane:

A. ENGINES

Lycoming IO-360-C1E6 with fuel injector Lycoming P/N LW-12586 (This engine installs on L. H. side of aircraft)

Lycoming LIO-360-C1E6 with fuel injector Lycoming P/N LW-12586 (This engine installs on R. H. side of aircraft)

ENGINE LIMITS

For all operation 2700 RPM, 200 HP

B. FUEL

100/130 Octane Aviation Gasoline (Minimum)

C. PROPELLERS

Hartzell HC-C2YK-2()E/C7666A-0 or Hartzell HC-C2YK-2()EF/FC7666A-0

Avoid continuous operation between 2200-2400 RPM

Or Hartzell HC-C2YK-2CG()/()C7666A This model includes damper
(This model installs on L. H. side of aircraft) Constant Speed

Pitch Settings at 30 in. station:

High 79° - 81°, Low 13.5

Diameter: Not over 76 inches

Not under 74 inches (No further reduction permitted)

Hartzell HC-C2YK-2()LE/JC7666A-0 or Hartzell HC-C2YK-2()LEF/FJC7666A-0

Avoid continuous operation between 2200-2400 RPM

Or Hartzell HC-C2YK-2CLG()/()JC7666A This model includes damper
(This model installs on R. H. side of aircraft) Constant Speed

Pitch Settings at 30 in. station:

High 79° - 81°, Low 13.5

Diameter: Not over 76 inches

Not under 74 inches (No further reduction permitted)

D. INSTRUMENT MARKINGS (POWER PLANT)

OIL TEMPERATURE

Green Arc (Normal Operating Range)

75° to 245°F

Red Line (Maximum)

245°F

OIL PRESSURE

Green Arc (Normal Operating Range)

60 PSI to 90 PSI

Yellow Arc (Caution)

25 PSI to 60 PSI

Red Line (Minimum)

25 PSI if installed or 60 PSI if installed

Red Line (Maximum)

90 PSI

SENECA

TACHOMETER

For Hartzell HC-C2YK-2()E, HC-C2YK-2()EF, HC-C2YK-2()LE or HC-C2YK-2()LEF propellers:

Green Arc (Normal operating Range)	500 RPM to 2200 RPM & 2400 RPM to 2700 RPM
Red Arc (Avoid continuous operation)	2200 RPM to 2400 RPM
Red Line (Maximum)	2700 RPM

For Hartzell HC-C2YK-2CG() or HC-C2YK-2CLG() propeller with dampers:

Green Arc (Normal Operating Range)	500 RPM to 2700 RPM
Red Line (Maximum)	2700 RPM

FUEL PRESSURE

Green Arc (Normal Operating Range)	14 PSI to 35 PSI
Red Line (Maximum)	35 PSI
Red Line (Minimum)	14 PSI

FUEL FLOW

Red Line (Maximum)	19.2 GPH
--------------------	----------

CYLINDER HEAD TEMPERATURE

Green Arc (Normal Range)	200° to 475°F
Red Line (Maximum)	475°F

E. AIRSPEED LIMITATIONS AND INDICATOR MARKINGS (Calibrated Airspeed)

NEVER EXCEED SPEED	217 MPH
MAXIMUM STRUCTURAL CRUISING SPEED	190 MPH
DESIGN MANEUVERING SPEEDS	
Minimum Weight (2743 lbs.)	133 MPH
Maximum Weight (4200 lbs.)	146 MPH

MAXIMUM FLAPS EXTENDED SPEED	125 MPH
------------------------------	---------

MAXIMUM GEAR EXTENDED SPEED	150 MPH
MAXIMUM GEAR RETRACT SPEED	125 MPH
MINIMUM CONTROL SPEED (Single Engine)	80 MPH

AIRSPEED INDICATOR MARKINGS

Green Arc (Normal Operating Range)	76 MPH to 190 MPH
Yellow Arc (Caution Range - Smooth Air)	190 MPH to 217 MPH
White Arc (Flaps Extended Range)	69 MPH to 125 MPH
Radial Red Line (Never Exceed - Smooth Air)	217 MPH
Radial Red Line (Minimum Control Speed - Single Engine)	80 MPH
Radial Blue Line (Best R/C Speed Single Engine)	105 MPH

F. FLIGHT LOAD FACTORS (Flaps Up)

Positive Load Factor (Maximum)	3.8 G
Negative Load Factor (Maximum)	No inverted maneuvers approved

G. MAXIMUM WEIGHT
MAXIMUM LANDING WEIGHT

4200 LBS.
4000 LBS.

H. C. G. RANGE

Weight Pounds	Forward Limit Inches Aft of Datum	Aft Limit Inches Aft of Datum
2780	80.7	94.6
3400	82.0	94.6
4200	87.9	94.6

NOTES

1. Straight line variation between the points given.
2. Datum is 78.4 inches forward of wing leading edge from the inboard edge of the inboard fuel tank.
3. It is the responsibility of the airplane owner and the pilot to assure that the airplane is properly loaded. Maximum allowable gross weight 4200 pounds. See "Weight and Balance Section" for proper loading instructions.

I. UNUSABLE FUEL

The unusable fuel in this aircraft has been determined as 2.5 gallons in each wing in critical flight attitudes. (2.5 gallons is the total per side, each side having two interconnected tanks)

J. USABLE FUEL

The usable fuel in this aircraft has been determined as 46.5 gallons in each wing (46.5 gallons is the total per side, each side having two interconnected tanks).

K. PLACARDS

In full view of the pilot:

THIS AIRPLANE MUST BE OPERATED AS A NORMAL CATEGORY AIRPLANE IN COMPLIANCE WITH THE OPERATING LIMITATIONS STATED IN THE FORM OF PLACARDS, MARKINGS, AND MANUALS. NO ACROBATIC MANEUVERS (INCLUDING SPINS) APPROVED.

THIS AIRCRAFT APPROVED FOR V.F.R., I.F.R., DAY AND NIGHT NON-ICING FLIGHT WHEN EQUIPPED IN ACCORDANCE WITH FAR 91 OR FAR 135.

When properly equipped the above placard shall read:

THIS AIRCRAFT APPROVED FOR V.F.R., I.F.R., DAY, NIGHT, AND ICING CONDITIONS WHEN EQUIPPED IN ACCORDANCE WITH FAR 91 OR FAR 135.

SENECA

MAXIMUM TAKEOFF WEIGHT 4200 POUNDS
MAXIMUM LANDING WEIGHT 4000 POUNDS
ALL WEIGHT IN EXCESS OF 4000 POUNDS MUST CONSIST
OF FUEL.

On instrument panel in full view of the pilot:

1. "DEMONSTRATED CROSSWIND COMPONENT 15 MPH"
2. "MINIMUM SINGLE ENGINE CONTROL SPEED 80 MPH"
3. "ROUGH AIR OR MANEUVERING SPEEDS"
"2743 LB GW - 133 MPH"
"4200 LB GW - 146 MPH"
4. "GEAR DOWN 150 MPH MAX"
"GEAR UP 125 MPH MAX"
"EXTENDED 150 MPH MAX"

Near emergency gear release:

EMERGENCY GEAR EXTENSION
PULL TO RELEASE. SEE A.F.M.
BEFORE RE-ENGAGEMENT.

Near gear selector switch:

"GEAR UP 125 MPH MAX"
"DOWN 150 MPH MAX"

Adjacent to upper door latch (Front and rear doors):

"ENGAGE LATCH BEFORE FLIGHT"

In full view of pilot:

WARNING - TURN OFF STROBE LIGHTS WHEN TAXIING
IN VICINITY OF OTHER AIRCRAFT, OR DURING FLIGHT
THROUGH CLOUD, FOG OR HAZE.

On the inside of forward baggage compartment door:

"MAXIMUM BAGGAGE THIS COMPARTMENT 100 LBS. SEE
THE LIMITATIONS SECTION OF THE AIRPLANE FLIGHT
MANUAL."

On aft baggage closeout:

"MAXIMUM BAGGAGE THIS COMPARTMENT 100 LBS. NO
HEAVY OBJECTS ON HAT SHELF."

On instrument panel:

“SINGLE ENGINE STALLS NOT RECOMMENDED. CAN CAUSE 500 FT. LOSS OF ALTITUDE AND 15° PITCH ANGLE.”

On instrument panel:

“TAKEOFF CHECKLIST

Fuel Selectors On
Electric Fuel Pumps On
Alternators On
Engine Gauges Checked
Mixtures Set
Propellers Set
Alt. Air Off
Cowl Flaps Set
Seat Backs Erect
Flaps Set
Trim Set (Stab. & Rudder)
Fasten Belts/Harness
Controls Free - Full Travel
Doors Latched”

“LANDING CHECKLIST

Seat Backs Erect
Fasten Belts/Harness
Fuel Selectors On
Cowl Flaps Set
Electric Fuel Pumps On
Mixtures Rich
Propellers Set
Gear Down
Flaps Set- 125 MPH Max.”

Adjacent to fuel tank filler cap:

“FUEL - 100/130 AVIATION GRADE - USABLE CAPACITY
46.5 GAL.”

On storm window:

"DO NOT OPEN ABOVE 150 MPH."

On instrument panel:

"OIL COOLER WINTERIZATION PLATE TO BE REMOVED
WHEN AMBIENT TEMPERATURE EXCEEDS 50°F."

On switch located below engine control pedestal with windshield heating installation:

"WINDSHIELD PANEL HEAT - SEE AIRCRAFT FLIGHT
MANUAL."

On engine instrument panel cover to left of engine controls with windshield heating installation:

"WARNING - THIS AIRCRAFT IS NOT APPROVED FOR
FLIGHT IN ICING CONDITIONS."

In full view of the pilot for flight with the aft fuselage doors removed:

"FOR FLIGHT WITH AFT DOORS REMOVED, CONSULT
THE LIMITATIONS AND PROCEDURES SECTIONS OF THE
AIRPLANE FLIGHT MANUAL."

L. VACUUM GAUGE

The operating limits for the vacuum system are 4.5 to 5.2 inches of mercury for all operations.

M. FLIGHT INTO KNOWN ICING CONDITIONS

For flight in icing conditions the following equipment must be installed in accordance with Piper drawings or in an FAA approved manner:

1. Pneumatic wing and empennage boots.
2. Electrothermal propeller boots.
3. Electric windshield panel.
4. Heated pitot head.
5. Anti-icing fuel tank vents.
6. Propeller governor shield and deflectors.
7. Wing ice light.
8. Heated Stall Warning Transmitters.

SECTION II
PROCEDURES

A. NORMAL PROCEDURES

1. WING FLAP SETTINGS

Take-Off 0°

Landing 40°

The flaps are manually operated.

Flap deflection versus handle position is:

First notch	10 Degrees
Second notch	25 Degrees
Third notch	40 Degrees

2. COWL FLAPS

Cowl flaps are provided to allow manual control of engine temperatures. The cowl flaps should be open during ground operations and in climbs. In no case should the cylinder head temperatures be allowed to exceed 475°F and the oil temperatures allowed to exceed 245°F.

3. GO-AROUND PROCEDURES

If a go-around from a normal landing with the airplane in the landing configuration becomes necessary:

- a. Apply takeoff power to both engines.
- b. Establish positive climb.
- c. Retract wing flaps.
- d. Retract landing gear.
- e. Adjust cowl flaps for adequate engine cooling.

B. SYSTEM OPERATIONS AND CHECKS

1. ALTERNATOR SYSTEM DESCRIPTION

The two ammeters continuously indicate the alternator outputs.

Certain regulator failures can cause the alternator output voltage to increase uncontrollably. To prevent damage, overvoltage relays are installed to automatically shut-off the alternator(s). The overvoltage trip lights adjacent to the alternator switches on the switch panel illuminate to warn of the tripped condition.

The alternator switch must be OFF to use the press-to-test feature of the overvoltage trip lights.

2. **ALTERNATOR SYSTEM OPERATION**

Both alternator switches should be ON for normal operation.

A preflight check should assure operation of the overvoltage lights, and that both ammeters show approximately equal outputs when both engines are at 1500 RPM or more.

Alternator outputs will vary with the electrical equipment in use and the state of charge of the battery. Alternator outputs should not exceed 60 amperes each except during engine cranking.

3. **CIRCUIT BREAKERS**

All circuit breakers are grouped in the lower right corner of instrument panel. To reset the circuit breakers push in on the reset button.

4. **FUEL MANAGEMENT**

a. **Normal Operation**

Each engine is normally supplied with fuel from the two interconnected tanks on the same side of the airplane. These two interconnected tanks are considered a single tank for tank selection purposes.

(1) **Take-off and landing**

- (a) Fuel selectors in "ON" position
- (b) Electric fuel pumps "ON"

(2) **Cruising**

- (a) Fuel selectors in "ON" position
- (b) Electric fuel pumps "OFF"

b. **Crossfeed Operation and Single Engine Operation**

A crossfeed is provided to increase range during single engine operation. Fuel system operation is as follows:

(1) **Cruising**

- (a) **When using fuel from tank on the same side as the operating engine:**

- (1) Fuel selector of operating engine in "ON" position.
- (2) Fuel selector of inoperative engine in "OFF" position.
- (3) Electric fuel pumps "OFF" (except in case of engine driven pump failure, electric fuel pump on operating engine side must be used).

- (b) **When using fuel from tank on the side opposite the operating engine:**

- (1) Fuel selector of operating engine in "X-FEED" (CROSSFEED) position.
- (2) Fuel selector of inoperative engine in "OFF" position.
- (3) Electric fuel pumps "OFF" (except in case of engine driven pump failure, electric fuel pump on operating engine side must be used).

- (c) Use crossfeed in level flight only.

(2) Landing

- (a) Fuel selector of operating engine in ON position.
- (b) Fuel selector of inoperative engine in OFF position.
- (c) Electric fuel pump of operating engine ON.

c. Crossfeed Operation With Both Engines Operating

In cruising flight it is permissible to operate both engines from the same tank.

d. Turning takeoffs

Fast taxi turns immediately prior to takeoff run can cause temporary malfunction of one engine during takeoff if the electric boost pumps are not in the ON position.

5. LANDING GEAR DOWN LIGHTS

The green gear down lights on the instrument panel indicate when each landing gear is down and locked. GEAR INDICATOR LIGHTS ARE DIMMED WHILE THE NAVIGATION LIGHTS ARE ON.

6. LANDING GEAR UNSAFE WARNINGS

The red landing gear unsafe light will illuminate when the landing gear is in transition between the full up position and the down and locked position. Additionally, on aircraft with serial numbers 34-7250046 and up, the light will illuminate when the gear warning horn sounds. The gear warning horn will sound at low throttle settings with the gear in the up position.

The light is off when the landing gear is in either the full down and locked or full up positions.

7. REAR CABIN AND CARGO DOORS REMOVED

a. Limitations

The airplane is approved for flight with the rear cabin and cargo doors removed.

The following limitations must be observed in the operation of this airplane with the rear cabin and cargo doors removed:

- (1) Maximum speed - 150 MPH.
- (2) Minimum single engine control speed - 81 MPH.
- (3) No smoking.
- (4) All loose articles must be tied down and stowed.
- (5) Jumper's static lines must be kept free of pilot's controls and control surfaces.
- (6) Operation approval for VFR non icing flight conditions only.

(b) Procedure

- (1) When operating with the rear cabin and cargo doors removed, it is recommended that all occupants wear parachutes.

THIS PAGE INTENTIONALLY LEFT BLANK

EMERGENCY PROCEDURES
F. A. A. APPROVED

C. EMERGENCY PROCEDURES

1. DETECTING A DEAD ENGINE

- a. Loss of Thrust
- b. Nose of aircraft will yaw in direction of dead engine (with coordinated controls)

2. FEATHERING PROCEDURE

The propellers can be feathered only while the engine is rotating above 800 RPM. Loss of centrifugal force due to slowing RPM will actuate a stop pin that keeps the propeller from feathering each time the engine is stopped on the ground. Single engine performance will decrease if the propeller of the inoperative engine is not feathered.

NOTE

If circumstances permit, in the event of an actual engine failure, the pilot may elect to attempt to restore power prior to feathering. The following actions are suggested:

- (1) Mixture - As Required
- (2) Fuel Boost Pump - On
- (3) Fuel Selector - Crossfeed
- (4) Magnetos - Select L or R only
- (5) Alternate Air - On

- a. Minimum Control Speed - 80 MPH.
- b. Best R/C Speed Single Engine - 105 MPH.
- c. Maintain Direction and Airspeed above 90 MPH.
- d. Mixture Controls - forward.
- e. Propeller Controls - forward.
- f. Throttle Controls - forward.
- g. Flaps - retract.
- h. Gear - retract.
- i. Electric Fuel Pumps - "ON."
- j. Identify inoperative engine.
- k. Throttle of inoperative engine - retard to verify.
- l. Propeller of inoperative engine - feather.
- m. Mixture of inoperative engine - idle cut off.
- n. Trim - as required.
- o. Maintain 5° bank toward operating engine.
- p. Electric Fuel Pump of inoperative engine - "OFF."
- q. Magnetos of inoperative engine - "OFF."
- r. Cowl Flaps - close on inoperative engine, use as required on operative engine.
- s. Alternator of inoperative engine - "OFF."
- t. Electrical Load - reduce to prevent battery depletion.
- u. Fuel Management - fuel "OFF" inoperative engine; consider crossfeed use.
- v. Electric fuel pump operative engine - "OFF."

3. UNFEATHERING PROCEDURE

- a. Fuel selector inoperative engine - "ON."
- b. Electric fuel pump inoperative engine - "OFF."
- c. Throttle - open 1/4 inch.
- d. Propeller control - forward to cruise RPM position.
- e. Mixture - rich.
- f. Magneto switches - "ON."
- g. Starter - engage till prop windmills.
- h. Throttle - reduced power till engine is warm.
- i. If engine does not start, prime by turning electric fuel pump of inoperative engine on for 3 seconds and then repeat steps g., h., and i.
- j. Alternator - "ON."

4. FUEL MANAGEMENT DURING SINGLE ENGINE OPERATION

A crossfeed is provided to increase range during single engine operation. Fuel system operation is as follows:

a. Cruising

- (1) When using fuel from tank on the same side as the operating engine:
 - (a) Fuel selector of operating engine in "ON" position.
 - (b) Fuel selector of inoperative engine in "OFF" position.
 - (c) Electric fuel pumps "OFF" (except in case of engine driven pump failure, electric fuel pump on operating engine side must be used).
- (2) When using fuel from tank on the side opposite the operating engine:
 - (a) Fuel selector of operating engine in "X-FEED" (CROSSFEED) position.
 - (b) Fuel selector of inoperative engine in "OFF" position.
 - (c) Electric fuel pumps "OFF" (except in case of engine driven pump failure, electric fuel pump on operating engine side must be used).
- (3) Use crossfeed in level flight only.

b. Landing

- (1) Fuel selector of operating engine in "ON" position.
- (2) Fuel selector of inoperative engine in "OFF" position.
- (3) Electric fuel pump of operating engine "ON."

5. ENGINE FAILURE DURING TAKEOFF

The single engine minimum control speed for this airplane is 80 mph (CAS) under sea level standard conditions.

- a. If engine failure occurs during takeoff ground roll and 100 mph (CAS) has not been attained, **CLOSE BOTH THROTTLES IMMEDIATELY AND STOP STRAIGHT AHEAD.** If inadequate runway remains to stop, then:
 - (1) Throttles - CLOSED.
 - (2) Brakes - apply maximum braking.
 - (3) Master switch - OFF.
 - (4) Fuel selectors - OFF.
 - (5) Continue straight ahead, turning to avoid obstacles as necessary.

- b. If engine failure occurs during takeoff ground roll or after lift-off with gear still down and 100 mph (CAS) has been attained:
 - (1) If adequate runway remains, **CLOSE BOTH THROTTLES IMMEDIATELY, LAND IF AIRBORNE, AND STOP STRAIGHT AHEAD.**
 - (2) If the runway remaining is inadequate for stopping, the pilot must decide whether to abort the takeoff or to continue. The decision must be based on the pilot's judgement considering loading, density altitude, obstructions, the weather, and the pilot's competence. If the decision is made to continue, then:
 - (a) Maintain heading and airspeed.
 - (b) Retract landing gear when climb is established.
 - (c) Feather inoperative engine (see feathering procedure).

THIS PAGE INTENTIONALLY LEFT BLANK

6. ENGINE FAILURE DURING CLIMB

The single engine minimum control speed for this airplane is 80 mph (CAS) under sea level standard conditions.

- a. If engine failure occurs when airspeed is below 80 mph (CAS) reduce the power on the good engine as required to maintain directional control. Reduce nose attitude to accelerate toward the single engine best rate of climb speed of 105 mph. Then feather inoperative engine (see feathering procedure).
- b. If engine failure occurs when the airspeed is above 80 mph (CAS):
 - (1) Maintain directional control.
 - (2) Adjust airspeed toward the single engine best rate of climb speed of 105 mph.
 - (3) Feather inoperative engine (see feathering procedure).

7. SINGLE ENGINE LANDING

- a. Feather inoperative engine (see feathering procedure).
- b. Do not extend landing gear until certain of making field.
- c. Do not lower wing flaps until certain of making field.

Maintain additional altitude and speed during approach, keeping in mind that landing should be made right the first time and that a go-around may require the use of full power on the operating engine, making control more difficult.

A final approach speed of 105 miles per hour and the use of 25° rather than full wing flaps will place the airplane in the best configuration for a go-around should this be necessary, but it should be avoided if at all possible. Under some conditions of loading and density altitude a go-around may be impossible, and in any event the sudden application of power during single engine operation makes control of the airplane more difficult.

8. SINGLE ENGINE GO-AROUND

If a single engine go-around cannot be avoided proceed as follows:

- a. Mixture - forward.
- b. Propeller - forward.
- c. Throttle - open.
- d. Flaps - retract.
- e. Landing Gear - retract.
- f. Airspeed - one engine inoperative best rate-of-climb speed 105 MPH.
- g. Trim - set.
- h. Cowl Flap - as required (operating engine).

9. MANUAL EXTENSION OF LANDING GEAR

Check the following before extending the gear manually:

- a. Circuit breakers - check.
- b. Master switch - ON.
- c. Alternators - check.
- d. Navigation lights - OFF (daytime).

To extend the gear, reposition the clip covering the emergency disengage control downward, clear of the knob, and proceed as listed below:

- a. Reduce power; airspeed not to exceed 100 MPH.
- b. Place Landing Gear Selector Switch in "GEAR DOWN LOCKED" position.
- c. Pull emergency gear extension knob.
- d. Check for 3 green lights.
- e. Leave emergency gear extension knob out.

WARNING

If the emergency gear extension knob has been pulled out to lower the gear due to a gear system malfunction, leave the control in its extended position until the airplane has been put on jacks to check the proper function of the landing gears hydraulic and electrical systems.

10. LANDING GEAR UNSAFE WARNINGS

The red landing gear light will illuminate when the landing gear is in transition between the full up position and the down and locked position. The pilot should recycle the landing gear if continued illumination of the light occurs. Additionally, on aircraft with serial numbers 34-72500046 and up, the light will illuminate when the gear warning horn sounds. The gear warning horn will sound at low throttle settings with the gear in the up and locked position.

11. GEAR-UP EMERGENCY LANDING

- a. Approach with power at a normal airspeed.
- b. Leave flaps up (to reduce wing and flap damage).
- c. Close the throttles just before touchdown.
- d. Turn off the master and ignition switches.
- e. Turn fuel selector valves to "OFF."
- f. Contact the surface at minimum airspeed.

12. ELECTRICAL FAILURES

- a. In the event that both overvoltage lights illuminate:
 - (1) Turn off all electrical loads, except the master switch.
 - (2) Turn both alternator switches OFF to extinguish the warning lights.
 - (a) Turn the alternator switches momentarily ON, one at a time while observing the ammeters.
 - (b) Determine the alternator showing the LEAST output amperes and turn its switch ON.

- (3) Turn electrical equipment on as required but do not exceed 50 amperes output.
 - (4) If both alternators show approximately equal output (less than 50 amperes each).
 - (a) Turn both alternators "ON."
 - (b) Turn equipment on as required.
 - (c) Resume normal operation.
- b. In the event that one overvoltage light illuminates:
- (1) Turn off all electrical loads, except the master switch.
 - (2) Turn off the alternator switch associated with the overvoltage trip warning.
 - (3) While observing ammeters, turn the alternator switch momentarily on to verify that the alternator output is excessive, then leave the alternator switch in the off position.
 - (4) Turn electrical equipment on as required but do not exceed 50 amperes output.
- c. In case the battery becomes depleted from a weakened condition or from excessive restart cranking, it may be necessary to perform the following procedure to get an operating alternator on the line if it has become disconnected for any reason.
- (1) Check alternator circuit breakers, reset if tripped.
 - (2) Remove heavy electrical loads such as pitot head, lighting, blower motor; minimize radio load. (Do not use master switch to accomplish this.)
 - (3) Turn operating alternator switch to on. Turn master switch to off. Wait a short time period, then cycle master switch to on. Observe ammeter for output.
 - (4) If no output is noted, recycle step (3) using longer waiting periods.
 - (5) When power is reestablished, use electrical equipment so that 50 amperes is not exceeded.
- d. In case of loss of output from one alternator:
- (1) Reduce electrical load as necessary to keep alternator output to 50 amperes or less.
 - (2) Check alternator circuit breakers, reset if necessary.
 - (3) Cycle the alternator switch for the inoperative alternator OFF, then ON.
 - (4) If step (3) fails to restore output:
 - (a) Maintain conditions of step (1) to continue flight.
 - (b) Take corrective maintenance action before further flights.
- e. In case of alternator output loss due to an engine failure, reduce the electrical load as necessary to keep the alternator output to 50 amperes or less.

WARNING

Compass error may exceed 10° with both alternators inoperative.

13. VACUUM SYSTEM FAILURES

- a. A malfunction of the vacuum system will become apparent as a reduction of indication on the gauge. A red button annunciator will show in case of a feathered engine or vacuum pump failure.
- b. In the event of vacuum system malfunction (vacuum lower than 4.5 inches of mercury):
 - (1) Increase engine RPM to 2700.
 - (2) Descend to an altitude, if possible, at which 4.5 inches of mercury vacuum can be maintained.
 - (3) Use Turn Indicator (Electric) to monitor the Direction Indicator and Attitude Indicator performance.

14. ENGINE FIRE

- a. In case of engine fire in flight (on the affected engine)
 - (1) Fuel Selector - OFF
 - (2) Throttle - CLOSE
 - (3) Propeller - FEATHER
 - (4) Mixture - IDLE CUT OFF
 - (5) Heater - OFF (In all cases of fire)
 - (6) Defroster - OFF (In all cases of fire)
 - (7) If terrain permits - Land Immediately

The possibility of an engine fire in flight is extremely remote. The procedure given above is general and pilot judgement should be the deciding factor for action in such an emergency.

- b. In case of engine fire on the ground
 - (1) If engine has not started
 - (a) Mixture - IDLE CUT OFF
 - (b) Throttle - OPEN
 - (c) Turn engine with starter (This is an attempt to pull the fire into the engine.)
 - (2) If engine has already started and is running, continue operating to try pulling the fire into the engine.
 - (3) In either case stated in (1) and (2), if the fire continues longer than a few seconds, the fire should be extinguished by the best available external means.
 - (4) If external fire extinguishing is to be applied
 - (a) Fuel Selector Valves - OFF
 - (b) Mixture - IDLE CUT OFF

15. SPINS

Intentional spins are prohibited. In the event that an unintentional spin is encountered, recovery can be accomplished by immediately using the following procedures:

- a. Retard both throttles to the idle position.
- b. Apply full rudder in the direction opposite the spin rotation.
- c. Let up all back pressure on the control wheel. If nose does not drop immediately push control wheel full forward.
- d. Keep ailerons in neutral.
- e. Maintain the controls in these positions until spin stops, then neutralize rudder.
- f. Recover from the resulting dive with smooth back pressure on the control wheel. No abrupt control movement should be used during recovery from the dive, as the positive limit maneuvering load factor may be exceeded.

16. ENGINE FAILURE IN ICING CONDITIONS

If engine failure occurs during icing flight, select ALTERNATE AIR and attempt to restart engine. If unable to restart engine:

- a. Feather inoperative propeller (see feathering procedure).
- b. Maintain airspeed at or above 105 mph (CAS).
- c. Descend if necessary to maintain airspeed.
- d. Reduce electrical loads per alternator failure procedure below.
- e. Avoid further icing conditions if possible.
- f. Land as soon as practical.
- g. Maintain at least 105 mph (CAS) during final approach.
- h. Do not extend landing gear until certain of making field.
- i. Do not lower wing flaps until certain of making field.
- j. Use 25 ° flaps rather than full flaps for landing.

17. ALTERNATOR FAILURE IN ICING CONDITIONS

In the event of an alternator failure during flight in icing conditions:

- a. Attempt to reset alternator overvoltage relay.
- b. Check circuit breakers and reset if possible,

If unable to restore alternator:

- c. Turn off all avionics except one NAVCOM and TRANSPONDER.
- d. Turn off electric windshield to maintain 60 AMP load.
- e. If icing conditions continue terminate flight as soon as practical.
- f. Prior to landing electric windshield may be turned on if necessary. Battery may be depleted and gear may require free-fall extension.

18. ENGINE FAILURE WITH REAR CABIN AND CARGO DOORS REMOVED.

The single engine minimum control speed for this configuration is 81 mph (CAS). If engine failure occurs at an airspeed below 81 mph, reduce power as necessary on the operating engine to maintain directional control.

19. PROPELLER OVERSPEED

Loss of the air charge in the propeller dome may cause the propeller to overspeed if the throttle is advanced rapidly or airspeed is abruptly increased. If an overspeed condition is encountered, the propeller will not feather and the following procedure should be used.

- a. Close throttle.
- b. Slow aircraft to best rate of climb speed.
- c. Pull propeller control back to low RPM.
- d. Slowly increase throttle until propeller governor is engaged.
- e. Slowly increase propeller and throttle to the desired power setting.
- f. Continue flight at reduced speed and power and land as soon as practical.

If the throttle is retarded below 15-20 IN - MP at speeds above 105 MPH, the propeller may overspeed again upon reapplying power. If this occurs, follow the same procedure to regain propeller control.

D. SPECIAL OPERATING PROCEDURES

1. FLIGHT INTO KNOWN ICING CONDITIONS

Prior to dispatch into forecast icing conditions all ice protection should be functionally checked for proper operation. The windshield defroster should be turned on before entering icing conditions. Upon entering probable icing conditions accomplish the following:

- a. Pitot heat - On (immediately).
- b. Windshield heat - On (immediately).
- c. Propeller Deice - On (immediately).
- d. Wing Deice - On (after 1/4 to 1/2 inch accumulation).
- e. Relieve propeller unbalance (if required) by increasing RPM briefly. Repeat as required.

WARNING

Do not cycle pneumatic boots with less than 1/4 inch of ice accumulation; operation of boots with less than 1/4 inch ice accumulation can result in failure to remove ice. Do not hold momentary deice switch ON. If wing-tail deicer panel light illuminates for more than 20 seconds pull surface deice circuit breaker.

Heat for the stall warning transmitters is activated by the pitot heat switch. When ice has accumulated on the unprotected surfaces of the airplane, aerodynamic buffet commences between 5 and 10 mph above the stall speed. A substantial margin of airspeed should be maintained above the normal stall speeds, since the stall speed may increase by up to 12 mph in prolonged icing encounters.

If ice is remaining on the unprotected surfaces of the airplane at the termination of the flight the landing should be made using full flaps and carrying a slight amount of power whenever practical, and approach speeds should be increased by 10 to 15 mph.

Cruise speed may be significantly reduced in prolonged icing encounters. If icing conditions are encountered at altitudes above 10,000 feet it may be necessary to descend in order to maintain airspeed above best rate of climb speed (105 mph - CAS).

NOTE

Pneumatic boots must be regularly cleaned and waxed for proper operation in icing conditions. Pitot, windshield and stall warning heat should be checked on the ground before dispatch into icing conditions.

Performance

Installation of ice protection equipment results in a 30 FPM decrease in single engine climb rate and a reduction of 850 feet in single engine service ceiling.

CAUTION

If the airplane is to be flown with the heated glass panel removed, rotate the receptacle plate 180° and replace it to cover the holes in the fuselage skin. Also replace the windshield collar screws.

SECTION III
PERFORMANCE

A. STALLS

1. POWER OFF STALLS

The loss of altitude during a power off stall with gear and flaps retracted may be as much as 450 feet. The loss of altitude with gear down and 40° of flaps may be as much as 450 feet.

2. POWER ON STALLS

The loss of altitude during a power on stall with gear and flaps retracted may be as much as 550 feet. The loss of altitude with gear down and 40° of flaps may be as much as 400 feet.

3. STALL WARNING SYSTEM

The stall warning system is inoperative with the master switch off.

B. STALLING SPEEDS (MPH, CALIBRATED AIRSPEED) VS ANGLE OF BANK

ANGLE OF BANK	0°	20°	40°	50°	60°
Flaps Up	76	78	87	95	108
Flaps 40°	69	71	79	86	98

C. AIRCRAFT PERFORMANCE WITH REAR CABIN AND CARGO DOORS REMOVED

All climb and cruise performance will be reduced by approximately five percent when the airplane is operated with the rear cabin and cargo doors removed.

THIS PAGE INTENTIONALLY LEFT BLANK.

SECTION IV
SUPPLEMENTS

NOTE

A FLIGHT MANUAL SUPPLEMENT IS REQUIRED TO BE IN THE AIRPLANE FLIGHT MANUAL ONLY IF THE EQUIPMENT WHICH IS THE SUBJECT OF THE SUPPLEMENT IS INSTALLED.

- A. Electric Pitch Trim Installation
- B. AutoControl III Installation
- C. AltiMatic IIIB-1 Installation
- D. AltiMatic V/FD-1 and AltiMatic V-1 Installation
- E. Windshield Heating Installation
- F. Cabin Combustion Heater Installation

THIS PAGE INTENTIONALLY LEFT BLANK.

A. ELECTRIC PITCH TRIM INSTALLATION**1. LIMITATIONS**

There are no limitations for this installation.

2. PROCEDURES**a. Preflight**

- (1) Circuit breaker - Set
- (2) Depress center bar - Trim fore and aft
- (3) Manually override electric trim
- (4) Check manual trim operation
- (5) Depress center bar - No operation
- (6) Push rocker Fore/Aft only - No operation
- (7) If trim fails preflight, disengage electric trim by operating push button trim switch on instrument panel until repaired. If trim does not disengage have unit repaired before further flight.

b. Inflight

- (1) Depress center bar
- (2) Activate rocker fore/aft for trim

3. EMERGENCY OPERATION**a. In Case Of Malfunction -**

Disengage electric pitch trim by operating push button trim switch on instrument panel.

b. In Emergency -

Electric pitch trim may be overpowered using manual pitch trim.

B. AUTOCONTROL III INSTALLATION

1. LIMITATIONS

- a. Autopilot use is prohibited above 195 MPH-CAS
- b. Use of flaps is limited to 25° or less during autopilot operations
- c. Autopilot "OFF" for takeoff and landing

2. PROCEDURES

- a. Normal Operation -
Refer to the current AutoControl III Owner's Handbook
- b. Emergency Operation
 - (1) In an emergency
 - (a) The AutoControl III can be disconnected by pushing the roll "ON-OFF" switch to "OFF."
 - (b) The AutoControl III can be overpowered at either control wheel.
 - (2) An autopilot runaway, with a 3 second delay in the initiation of recovery, while operating in a climb, cruise or descending flight could result in a 45° bank and a 175 foot altitude loss.
 - (3) An autopilot runaway, with a 1 second delay in the initiation of recovery, during an approach operation, coupled or uncoupled, single or multi-engine, could result in an 18° bank and a 40 foot altitude loss.

3. PERFORMANCE

The airplane performance remains unchanged.

D. ALTIMATIC V/FD-1 OR ALTIMATIC V-1 INSTALLATION

1. LIMITATIONS

- a. Autopilot OFF during takeoff and landing.
- b. Do not engage autopilot if airplane is out of trim.
- c. Maximum airspeed for autopilot operation is 207 MPH, (180 KTS), CAS.
- d. During autopilot operation, the pilot must be in his seat with the belt fastened.
- e. Do not manually override autopilot to produce or prevent pitch attitude changes or to increase bank angle.
- f. If one engine becomes inoperative, adjust rudder trim for single engine operation.

2. PROCEDURES

a. Preflight

(1) Manual Electric Trim

- (a) Aircraft Master Switch - ON
- (b) Trim Warning Light - OUT
- (c) Manual Trim Wheel freedom of movement - CHECK
- (d) Actuate Electric Trim Switch and observe proper direction of movement of trim wheel - CHECK
- (e) Depress the test button next to the trim warning light. Light should light and trim should not run. If trim runs or if light does not illuminate, pull trim disconnect switch and do not reset until problem has been corrected. **DO NOT ENGAGE AUTOPILOT WITH TRIM DISCONNECTED.**

(2) Autopilot

- (a) Start engines
- (b) Autopilot Master Switch - ON
- (c) Gyro Check - Check attitude gyro for proper erection. Set directional gyro if non-slaving type.
- (d) Before takeoff - Engage autopilot, apply force to controls (one axis at a time) to determine if the autopilot can be overpowered.
- (e) Press HDG, VOR, APPR, REV buttons one at a time, place pitch command disc in center detent position and check respective lights on the Flight Controller for operation.

NOTE

Automatic pitch trim will operate during this check and should be reset prior to takeoff.

C. ALTIMATIC IIIB-1 INSTALLATION

1. LIMITATIONS

- a. Autopilot use is prohibited above 195 MPH-CAS
- b. Use of flaps is limited to 25° or less during autopilot operations
- c. Autopilot "OFF" for takeoff and landing

2. PROCEDURES

- a. Preflight
 - (1) Circuit breaker - Set
 - (2) Depress center bar - Trim fore and aft
 - (3) Manually override electric trim
 - (4) Check manual trim operation
 - (5) Depress center bar - No operation
 - (6) Push rocker Fore/Aft only - No operation
 - (7) If trim fails preflight, disengage electric trim by operating push button trim switch on instrument panel until repaired. If trim does not disengage have unit repaired before further flight.
- b. Normal Operation -
Refer to the current AltiMatic IIIB-1 Owner's Handbook
- c. Emergency Operation -
 - (1) In the event of malfunction, the autopilot can be
 - (a) Disconnected by pushing the wheel disconnect switch (AP OFF)
 - (b) Disconnected by pushing the roll rocker switch "OFF"
 - (c) Overpowered manually in roll and pitch at either control wheel.
 - (2) In the event of malfunction, the trim system can be
 - (a) Disabled by operating the push button trim switch on the instrument panel
 - (b) Overpowered manually at the trim wheel
 - (3) Single engine operation
 - (a) Disengage autopilot and retrim aircraft -
Maintain aircraft in trim throughout all single engine operations.
(Ball centered)
 - (b) Perform normal engine out emergency procedure
 - (c) Re-engage autopilot
 - (4) An autopilot malfunction during climb, cruise or descent, either single or multi-engine, with a 3 second delay in the initiation of recovery could result in a 45° bank and a 600 foot altitude loss.
 - (5) An autopilot malfunction during approach operations, either single or multi-engine, coupled or uncoupled, with a 1 second delay in the initiation of recovery could result in an 18° bank and a 60 foot altitude loss.

3. PERFORMANCE

The airplane performance remains unchanged.

(f) **AUTOPILOT RELEASE** - Disengage the autopilot by operating trim switch on left side of pilot's control wheel. Ascertain that servos have disengaged by free movement of controls.

b. **Normal Operation** - Refer to Piper AltiMatic V/FD-1 or Piper AltiMatic V-1 Information Manual.

c. **Emergency Operation**
Autopilot

(1) In the event a malfunction in the autopilot performance is detected, the pilot must immediately disengage the autopilot by momentarily operating the trim switch on the left side of the pilot's control wheel.

(2) Maximum altitude loss during malfunction tests in the following flight configuration:

(a) Cruise, Climb	170 Feet
(b) Descent	250 Feet
(c) ILS approach (Twin Engine)	90 Feet
(d) ILS approach (Single Engine)	90 Feet

Pitch Trim

(3) If Trim Warning Light illuminates in flight, pull the Pitch Trim Disconnect switch and have system inspected prior to operation.

(4) If a runaway trim should occur with autopilot on, the electric trim circuit breaker will open with an out of trim condition of approximately 15 lbs.

3. PERFORMANCE

The airplane performance remains unchanged.

E. WINDSHIELD HEATING INSTALLATION

1. LIMITATIONS

UNDER NO CIRCUMSTANCES SHOULD THE UNIT BE TURNED ON FOR A PERIOD EXCEEDING 30 SECONDS UNLESS:

- a. The aircraft is in flight, or
- b. Ice exists on the heated panel.

2. PROCEDURES

An operational check is accomplished by turning the heated panel switch ON for a period not exceeding 30 SECONDS. Proper operation is indicated by the glass section being warm to the touch.

3. PERFORMANCE

NOTE

An additional compass deviation card is required with this installation. This card should indicate corrected readings with windshield heat and radios on.

F. CABIN COMBUSTION HEATER**1. LIMITATIONS**

- a. The use of windshield electric anti-ice and cabin combustion heater at the same time is prohibited due to excessive compass error.
- b. Placards
Near the heater controls in full view of the pilot "Operation of Combustion Heater prohibits the use of Windshield Heater due to excessive compass error".
- c. Operation of the combustion heater above 20,000 feet is not approved.

2. PROCEDURES

- a. Normal Operation
Refer to Pilot's Operating Manual for normal operation.
- b. Emergency Operation
In the event of an overheat condition, the fuel, air and ignition to the heater is automatically cut off. Do not attempt to restart the heater until it has been inspected and the cause of the malfunction has been determined and corrected.

3. PERFORMANCE

The airplane performance remains unchanged.

THIS PAGE INTENTIONALLY LEFT BLANK

WEIGHT AND BALANCE

Installation Center

GARMIN GNS 530 VHF Communications
Transceiver / VOR/ILS Receiver / GPS Receiver

Repair Station #

Tomlinson Avionics, Inc.

PH. 941-936-6969

Name:

511 Danley, Page Field

Ft. Myers, FL 33907

Address:

Repair Station NO. YN1D644K

**FAA APPROVED FLIGHT MANUAL SUPPLEMENT
GARMIN GNS 530 VHF COMMUNICATIONS TRANSCEIVER /
VOR/ILS RECEIVER / GPS RECEIVER**

AIRCRAFT MAKE: Piper

AIRCRAFT MODEL: PA34-200

AIRCRAFT SERIAL NO.: 34-7350124
N8875P

This document must be carried in the aircraft at all times. It describes the operating procedures for the GARMIN GNS 530 navigation system when it has been installed in accordance with GARMIN Installation Manual, 190-00181-02 Rev. (Rev. A or later) and FAA Form 337 dated DEC 07 2001.

For aircraft with an FAA Approved Airplane Flight Manual, this document serves as the FAA Approved Flight Manual Supplement for the GARMIN GNS 530. For aircraft that do not have an approved flight manual, this document serves as the FAA Approved Supplemental Flight Manual for the GARMIN GNS 530.

The Information contained herein supplements or supersedes the basic Airplane Flight Manual only in those areas listed herein. For limitations, procedures, and performance information not contained in this document, consult the basic Airplane Flight Manual.

Jesus William TAI FSDO #35

*Federal Aviation Administration
5601 MARINER ST Suite 310
TAMPA, FL 33609
FAA FSDO TAMPA*

FAA APPROVED
190-00181-04 Rev. B

TAMPA FSDO

DATE: DEC 07 2001

PAGE 1 OF 8

Tomlinson Avionics, Inc.
PH. 941-936-6969
511 Danley, Page Field
Ft. Myers, FL 33907
Repair Station NO. YN10044K

Aircraft Make: Piper
Aircraft Model: PA-34-200
Aircraft Serial Number: 34-7350124

GARMIN GNS 530 VHF Communications
Transceiver / VOR/ILS Receiver / GPS Receiver

Table of Contents

SECTION	PAGE
GENERAL	3
LIMITATIONS	4
EMERGENCY PROCEDURES	5
NORMAL PROCEDURES	6
PERFORMANCE	8
WEIGHT AND BALANCE	8
AIRPLANE & SYSTEM DESCRIPTIONS	8

FAA APPROVED TAMPA FSDO
190-00181-04 Rev. B

DATE: DEC 07 2008

PAGE 2 OF 8

Tomlinson Avionics, Inc.
PH. 941-936-6969
511 Danley, Page Field
Ft. Myers, FL 33907
Repair Station NO. YN1D644K

Aircraft Make: Piper GARMIN GNS 530 VHF Communications
Aircraft Model: PA 34-200 Transceiver / VOR/ILS Receiver / GPS Receiver
Aircraft Serial Number: 34-750174

N 8875P

**SECTION I
GENERAL**

1. The GNS 530 System is a fully integrated, panel mounted instrument, which contains a VHF Communications Transceiver, a VOR/ILS receiver, and a Global Positioning System (GPS) Navigation computer. The system consists of a GPS antenna, GPS Receiver, VHF VOR/LOC/GS antenna, VOR/ILS receiver, VHF COMM antenna and a VHF Communications Transceiver. The primary function of the VHF Communication portion of the equipment is to facilitate communication with Air Traffic Control. The primary function of the VOR/ILS Receiver portion of the equipment is to receive and demodulate VOR, Localizer, and Glide Slope signals. The primary function of the GPS portion of the system is to acquire signals from the GPS system satellites, recover orbital data, make range and Doppler measurements, and process this information in real-time to obtain the user's position, velocity, and time.
2. Provided the GARMIN GNS 530's GPS receiver is receiving adequate usable signals, it has been demonstrated capable of and has been shown to meet the accuracy specifications for:
 - VFR/IFR enroute, terminal, and non-precision instrument approach (GPS, Loran-C, VOR, VOR-DME, TACAN, NDB, NDB-DME, RNAV) operation within the U.S. National Airspace System in accordance with AC 20-138.
 - One of the approved sensors, for a single or dual GNS 530 installation, for North Atlantic Minimum Navigation Performance Specification (MNPS) Airspace in accordance with AC 91-49 and AC 120-33.
 - The system meets RNP5 airspace (BRNAV) requirements of AC 90-96 and in accordance with AC 20-138, and JAA AMJ 20X2 Leaflet 2 Revision 1, provided it is receiving usable navigation information from the GPS receiver.

Navigation is accomplished using the WGS-84 (NAD-83) coordinate reference datum. Navigation data is based upon use of only the Global Positioning System (GPS) operated by the United States of America.

FAA APPROVED TAMPA FSDO DATE: DEC 07 2001 PAGE 3 OF 8
190-00181-04 Rev. B

Tomlinson Avionics, Inc.
PH. 941-936-6969
511 Danley, Page Field
Ft. Myers, FL 33907
Repair Station NO. YN1D644K

Aircraft Make: Piper GARMIN GNS 530 VHF Communications
Aircraft Model: PA-34-200 Transceiver / VOR/ILS Receiver / GPS Receiver
Aircraft Serial Number: 31-7350124
N 8875P

**SECTION II
LIMITATIONS**

1. The GARMIN GNS 530 Pilot's Guide, P/N 190-00181-00, Rev. A, dated April 2000 or later appropriate revision must be immediately available to the flight crew whenever navigation is predicated on the use of the system.
2. The GNS 530 must utilize the following or later FAA approved software versions:

Sub-System	Software Version
Main	2.00
GPS	2.00
COMM	1.22
VOR/LOC	1.25
G/S	2.00

The Main software version is displayed on the GNS 530 self test page immediately after turn-on for 5 seconds. The remaining system software versions can be verified on the AUX group sub-page 2, "SOFTWARE/DATABASE VER".

3. IFR enroute and terminal navigation predicated upon the GNS 530's GPS Receiver is prohibited unless the pilot verifies the currency of the data base or verifies each selected waypoint for accuracy by reference to current approved data.
4. Instrument approach navigation predicated upon the GNS 530's GPS Receiver must be accomplished in accordance with approved instrument approach procedures that are retrieved from the GPS equipment data base. The GPS equipment database must incorporate the current update cycle.
 - (a) Instrument approaches utilizing the GPS receiver must be conducted in the approach mode and Receiver Autonomous Integrity Monitoring (RAIM) must be available at the Final Approach Fix.
 - (b) Accomplishment of ILS, LOC, LOC-BC, LDA, SDF, MLS or any other type of approach not approved for GPS overlay with the GNS 530's GPS receiver is not authorized.
 - (c) Use of the GNS 530 VOR/ILS receiver to fly approaches not approved for GPS requires VOR/ILS navigation data to be present on the external indicator.

TAMPA FSDO

Tomlinson Avionics, Inc
PH. 941-936-6969
511 Danley, Page Field
Ft. Myers, FL 33907
Repair Station NO. YN1D644K

Aircraft Make: Piper GARMIN GNS 530 VHF Communications
Aircraft Model: PA-37-20 Transceiver / VOR/ILS Receiver / GPS Receiver
Aircraft Serial Number: 31-7350124
N8875P

- (d) When an alternate airport is required by the applicable operating rules, it must be served by an approach based on other than GPS or Loran-C navigation, the aircraft must have the operational equipment capable of using that navigation aid, and the required navigation aid must be operational.
- (e) VNAV information may be utilized for advisory information only. Use of VNAV information for Instrument Approach Procedures does not guarantee Step-Down Fix altitude protection, or arrival at approach minimums in normal position to land.
5. If not previously defined, the following default settings must be made in the "SETUP 1" menu of the GNS 530 prior to operation (refer to Pilot's Guide for procedure if necessary):
- (a) **dis, spd** $\frac{n}{m}$ $\frac{k}{t}$ (sets navigation units to "nautical miles" and "knots")
(b) **alt, vs** $\frac{f}{t}$ fpm (sets altitude units to "feet" and "feet per minute")
(c) **map datum** ..WGS 84 (sets map datum to WGS-84, see note below)
(d) **posn**deg-min (sets navigation grid units to decimal minutes)

NOTE: In some areas outside the United States, datums other than WGS-84 or NAD-83 may be used. If the GNS 530 is authorized for use by the appropriate Airworthiness authority, the required geodetic datum must be set in the GNS 530 prior to its use for navigation.

SECTION III EMERGENCY PROCEDURES

ABNORMAL PROCEDURES

1. If GARMIN GNS 530 navigation information is not available or invalid, utilize remaining operational navigation equipment as required.
2. If "RAIM POSITION WARNING" message is displayed the system will flag and no longer provide GPS based navigational guidance. The crew should revert to the GNS 530 VOR/ILS receiver or an alternate means of navigation other than the GNS 530's GPS Receiver.
3. If "RAIM IS NOT AVAILABLE" message is displayed in the enroute, terminal, or initial approach phase of flight, continue to navigate using the GPS equipment or revert to an alternate means of navigation other than the GNS 530's GPS receiver appropriate to the route and phase of flight. When continuing to use GPS navigation, position must be verified every 15 minutes using the GNS 530's VOR/ILS receiver or another IFR-approved navigation system.

FAA APPROVED TAMPA FSDO DATE: DEC 07 2001 PAGE 5 OF 8
190-00181-04 Rev. B

Tomlinson Avionics, Inc.
PH. 941-936-6969
511 Danley, Page Field
Ft. Myers, FL 33907
Repair Station NO. YN1D644K

Aircraft Make: R. JCR GARMIN GNS 530 VHF Communications
Aircraft Model: RA34-202 Transceiver / VOR/ILS Receiver / GPS Receiver
Aircraft Serial Number: 34-7350124

4. If "RAIM IS NOT AVAILABLE" message is displayed while on the final approach segment, GPS based navigation will continue for up to 5 minutes with approach CDI sensitivity (0.3 nautical mile). After 5 minutes the system will flag and no longer provide course guidance with approach sensitivity. Missed approach course guidance may still be available with 1 nautical mile CDI sensitivity by executing the missed approach.
5. In an in-flight emergency, depressing and holding the Comm transfer button for 2 seconds will select the emergency frequency of 121.500 Mhz into the "Active" frequency window.

SECTION IV NORMAL PROCEDURES

1. DETAILED OPERATING PROCEDURES

Normal operating procedures are described in the GARMIN GNS 530 Pilot's Guide, P/N 190-00181-00, Rev. A, dated April 2000 or later appropriate revision.

2. PILOTS DISPLAY

The GNS 530 System data will appear on the Pilot's CDI/HSI. The source of data is either GPS or VLOC as annunciated on the display above the CDI key.

NOTE: It is the pilot's responsibility to assure that published or assigned procedures are correctly complied with. Course guidance is not provided for all possible ARINC 424 leg types. See the GNS 530 Pilot's Guide for detailed operating procedures regarding navigation capabilities for specific ARINC 424 leg types.

3. AUTOPILOT / FLIGHT DIRECTOR OPERATION

Coupling of the GNS 530 System steering information to the autopilot/flight director can be accomplished by engaging the autopilot/flight director in the NAV or APR mode.

When the autopilot/flight director system is using course information supplied by the GNS 530 System and the course pointer is not automatically driven to the desired track, the course pointer on the CDI must be manually set to the desired track (DTK) indicated by the GNS 530. For detailed autopilot/flight director operational instructions, refer to the FAA Approved Flight Manual Supplement for the autopilot/flight director.

Tomlinson Avionics, Inc.
PH. 941-936-6969
511 Danley, Page Field
Ft. Myers, FL 33907
Repair Station NO. YN1D644K

Aircraft Make: Piper GARMIN GNS 530 VHF Communications
Aircraft Model: PA34-200 Transceiver / VOR/ILS Receiver / GPS Receiver
Aircraft Serial Number: 34-730124

4. CROSSFILL OPERATIONS

For dual GNC 500 Product Series or GNC 500/GNC 400 Product Series installations, crossfill capabilities exist between the number one and number two Systems. Refer to the GARMIN GNS 530 Pilot's Guide for detailed crossfill operating instructions.

5. AUTOMATIC LOCALIZER COURSE CAPTURE

By default, the GNS 530 automatic localizer course capture feature is enabled. This feature provides a method for system navigation data present on the external indicators to be switched automatically from GPS guidance to localizer / glide slope guidance as the aircraft approaches the localizer course inbound to the final approach fix. If an offset from the final approach course is being flown, it is possible that the automatic switch from GPS course guidance to localizer / glide slope course guidance will not occur. It is the pilot's responsibility to ensure correct system navigation data is present on the external indicator before continuing a localizer based approach beyond the final approach fix. Refer to the GNS 530 Pilot's Guide for detailed operating instructions.

6. DISPLAY OF LIGHTNING STRIKE DATA

For installations that interface the BFGoodrich WX-500 Stormscope and the GNS 530, lightning strike data detected by the WX-500 will appear on the GNS 530. For detailed operating instructions regarding the interface of the GNS 530 with the WX-500, refer to the WX-500 Pilot's Guide and the GNS 530 Pilot's Guide Addendum for the WX-500 Stormscope interface.

7. DISPLAY OF TRAFFIC ADVISORY DATA

For installations that interface the BFGoodrich SKYWATCH Traffic Advisory System (TAS) and the GNS 530, traffic data detected by the SKYWATCH will appear on the GNS 530. For detailed operating instructions regarding the interface of the GNS 530 with the SKYWATCH, refer to the FAA Approved Flight Manual Supplement for the SKYWATCH, the Pilot's Guide for the SKYWATCH and the GNS 530 Pilot's Guide Addendum for the SKYWATCH Traffic Advisory System interface.

Tomlinson Avionics, Inc.
PH. 941-936-6969
511 Danley, Page Field
Ft. Myers, FL 33907
Repair Station NO. YN1D644K

Aircraft Make: Piper GARMIN GNS 530 VHF Communications
Aircraft Model: PA-34-200 Transceiver / VOR/LS Receiver / GPS Receiver
Aircraft Serial Number: 34-7350124

N8875P

**SECTION V
PERFORMANCE**

No change.

**SECTION VI
WEIGHT AND BALANCE**

See current weight and balance data.

**SECTION VII
AIRPLANE & SYSTEM DESCRIPTIONS**

See GNS 530 Pilot's Guide for a complete description of the GNS 530 system.

TAMPA FSDO

FAA APPROVED _____
190-00181-04 Rev. B

DATE: DEC 07 2001

PAGE 8 OF 8

WEIGHT AND BALANCE

FOR

SENECA

APPLICABLE TO SERIAL NUMBERS 34-7250001 THRU 34-7250189 WHEN PIPER KIT 760607 IS INSTALLED, 34-7250190 THRU 34-7250214 WHEN PIPER KIT 760611 IS INSTALLED AND 34-7250215 THRU 34-7350353.

WARNING

EXTREME CARE MUST BE EXERCISED TO LIMIT THE USE OF THIS REPORT TO APPLICABLE AIRCRAFT. THIS REPORT REVISED AS INDICATED BELOW OR SUBSEQUENTLY REVISED IS VALID FOR USE WITH THE AIRPLANE IDENTIFIED BELOW WHEN APPROVED BY PIPER AIRCRAFT CORPORATION. SUBSEQUENT REVISIONS SUPPLIED BY PIPER AIRCRAFT CORPORATION MUST BE PROPERLY INSERTED.

MODEL PA-34-200

AIRCRAFT SERIAL NO. _____ REGISTRATION NO. _____

WEIGHT AND BALANCE, REPORT NUMBER VB-424 REVISION _____

PIPER AIRCRAFT CORPORATION
APPROVAL SIGNATURE AND STAMP _____

ISSUED: August 2, 1972
REVISED: October 14, 1974

REPORT: VB-424
MODEL: PA-34-200

BLANK PAGE

WEIGHT AND BALANCE

Log of Revisions.....	4-iii
Weight and Balance	4-1
Weight and Balance Data - Weighing Procedure.....	4-3
Weight and Balance Data.....	4-4
C. G. Range and Weight Instructions	4-7
Instructions for Using the Weight and Balance Plotter	4-10
Sample Problem.....	4-12
Equipment List	4-13

BLANK PAGE

INDEX - WEIGHT AND BALANCE

Log of Revisions.....	4-iii
Weight and Balance	4-1
Weight and Balance Data - Weighing Procedure.....	4-3
Weight and Balance Data.....	4-6
C. G. Range and Weight Instructions	4-7
Instructions for Using the Weight and Balance Plotter	4-10
Sample Problem.....	4-12
Equipment List	4-13
A. Propellers and Propeller Accessories	4-13
B. Engine and Engine Accessories - Fuel and Oil Systems.....	4-14
C. Landing Gear and Brakes	4-15
D. Electrical Equipment.....	4-16
E. Instruments	4-17
F. Hydraulic Equipment	4-18
G. Miscellaneous.....	4-19
H. Engine and Engine Accessories - Fuel and Oil System (Optional Equipment).....	4-20
I. Electrical Equipment (Optional Equipment).....	4-21
J. Autopilots (Optional Equipment).....	4-23
K. Radio Equipment (Optional Equipment)	4-24
L. Instruments (Optional Equipment).....	4-31
M. Miscellaneous (Optional Equipment)	4-33

THIS PAGE INTENTIONALLY LEFT BLANK

LOG OF REVISIONS

Revision	Revised Pages	Description and Revision	Approved Date
1	4-23 4-23a 4-23b 4-24	Corrected AltiMatic IIIB-1 totals. Added page. Added page. Added Narco Nav 14	July 7, 1972 <i>John R. McLean</i> H. W. Barnhouse
2	4-17 4-31 4-32	Correct Instrument Specification Numbers. Changed from Turn and Bank - Piper 99005 to Turn and Slip Indicator PS50030-2 or -3. Changed Instrument Specification Numbers.	July 10, 1972 <i>John R. McLean</i> H. W. Barnhouse
3	Title 4-15 4-16a 4-16b 4-19 4-21 4-22 4-26 4-28 4-33 4-34	Added page. Added New Nose Wheel (40-76B). Added page. Added page. Added Rear Seat Belts, Cargo Door, Right Front Seat 96806-5, Center Seats 96827-2, -3, Rear Seats 99730-2, -3, 968274, -5. Removed Lights (Landing, Navigation, Grimes 15-0083-1 Instrument and Forward Baggage). Removed Power Supply No. A412A-14, Fin Tip and Cable. Added King KX-175, King KN73 and KN77. Added King KT76/78 and KMA-20. Added Jumpseat 69595-5, Fire Extinguisher, Sun Visors & Tow Bar. Removed Rear Seats & Rear Seat Belts. Removed Fire Extinguisher, Sun Visors, Tow Bar & Cargo Door. Added Adjustable Front Seats 69568-2 & -3, and Headrests 96806-17.	August 2, 1972 <i>V. Tennant</i>
4	4-34	Added Windshield Heating Unit	Sept. 15, 1972 <i>V. Tennant</i>
5	4-23a 4-23b 4-24	Changed from V/FD to V/FD-1 AltiMatic. Changed from V to V-1 AltiMatic. Changed Comm Antenna Cable Arms and Moments, Added Anti Static Kit.	Nov. 16, 1972 <i>V. Tennant</i>

ISSUED: March 10, 1972
REVISED: November 16, 1972

REPORT: VB-424 PAGE 4-iii
MODEL: PA-34-200

LOG OF REVISIONS

Revision	Revised Pages	Description and Revision	Approved Date
6	4-34 4-35 4-36	Added Combustion Heater. Added page. Added page.	Dec. 21, 1972 <i>N. Terrant</i>
7	4-34	Corrected Combustion Heater Weight and Moment.	Dec. 21, 1972 <i>N. Terrant</i>
8	4-25 4-26	Added King KX-175, KN-73, KN-77 and KN-520 Installations. Removed King KN-77 and KN-73 Installations. Added King KN-65 DME Installation.	May 25, 1973 <i>N. Terrant</i>
9	Title 4-13 4-17 4-34 4-35	Added Serial No. effectivity. Added Propellers with Dampers. Added -4, -5 Spinners. Added -9 Tachometer. Removed - Total Optional Equipment. Added Fire Extinguishers.	<i>N. Terrant</i> Sept. 19, 1973
10	4-23a 4-35	Revised Misc. Hardware Moment and Total Arm and Moment. Added Ice Protection System Instl.	April 26, 1974 <i>R. Bernardy</i>
11	Title	Added PAC Approval Form (NOTE: AIRCRAFT DELIVERED WITH MANUALS PRIOR TO THIS REVISION DO NOT REQUIRE THIS REVISION.)	Oct. 14, 1974 <i>R. Bernardy</i>
12	4-7	Revised fuel capacity - Sample Loading Problem.	May 30, 1975 <i>J. Hargaley</i>
13	4-15 4-35	Revised Type III Tube Cert. Basis. Added Heavy Duty Wheels, Brakes and Tires	April 1, 1977 <i>J. Hargaley</i>

LOG OF REVISIONS (cont)

Revision	Revised Pages	Description and Revision	Approved Date
14	1, 2	Revised general weight and balance introduction.	March 23, 1979 <i>Hal Fletcher</i>
15	16	Added Electrodelta voltage regulator.	November 30, 1987 <i>W. G. Smith</i>

BLANK PAGE

WEIGHT AND BALANCE

In order to achieve the performance and flying characteristics which are designed into the aircraft, the Seneca must be flown with the weight and center of gravity (C.G.) position within the approved envelope. The aircraft offers a tremendous flexibility of loading. You can carry a large payload (distributed in a variety of combinations of passengers and cargo) or a large amount of fuel. However, you cannot fill the aircraft with seven adults and full fuel tanks. With the flexibility comes responsibility. The pilot must insure that the airplane is loaded within the loading envelope before he makes a takeoff.

Misloading carries consequences for any aircraft. An overloaded airplane will not take off, climb or cruise as well as when it is properly loaded. The heavier the airplane is loaded the less single-engine climb performance it will have, and the pilot may be deprived of one of the advantages of twin-engine flight.

Center of gravity is a determining factor in flight characteristics. If the C.G. is too far forward in any airplane, it may be difficult to rotate for takeoff or landing. If the C.G. is too far aft, the airplane may rotate prematurely on takeoff or try to pitch up during climb. Longitudinal stability will be reduced. This can lead to inadvertent stalls and even spins; and spin recovery becomes more difficult as the center of gravity moves aft of the approved limit.

A properly loaded aircraft, however, will perform as intended. Before the aircraft is delivered, the Seneca is weighed and a basic weight and C.G. location computed. (Basic weight consists of the empty weight of the aircraft plus the unusable fuel and full oil capacity.) Using the basic weight and C.G. location, the pilot can easily determine the weight and C.G. position for the loaded airplane by means of a plotter which is furnished with the aircraft. If he wants more precise values or if the plotter is not available, he can compute the total weight and moment and then determine whether they are within the approved envelope.

The basic weight and C.G. location for a particular airplane are recorded on the plotter for the airplane. These values are also entered in the weight and balance section of the Airplane Flight Manual. The current values should always be used. Whenever new equipment is added or any modification work is done, the mechanic responsible for the work is required to compute a new basic weight and basic C.G. position and to write these in the aircraft log book. The owner should make sure he does, and should change these values on his plotter.

A weight and balance calculation is necessary in determining the best positions for locating passengers or cargo, and can guide the pilot in relocating people or baggage so as to keep within allowable limits. If it is necessary to remove some of the fuel or payload to stay within maximum allowable gross weight, the pilot should not hesitate to do so.

The following pages are forms used in weighing an airplane in production and in computing basic weight, basic C.G. position, and useful load. Note that the useful load includes fuel, oil, baggage, cargo and passengers. Following these are (1) a method for computing takeoff weight and C.G. if precision is desired, if a plotter is not available, or if cargo is carried, and (2) an explanation of how to use the weight and balance plotter.

On one side of the weight and balance plotter are some general loading recommendations which will assist the pilot in arranging his load. If these are followed much time can be saved without degrading safety.

WEIGHT AND BALANCE DATA

WEIGHING PROCEDURE

At the time of delivery, Piper Aircraft Corporation provides each airplane with the licensed empty weight and center of gravity location.

The removal or addition of an excessive amount of equipment or excessive airplane modifications can affect the licensed empty weight and empty weight center of gravity. The following is a weighing procedure to determine this licensed empty weight and center of gravity location:

1. PREPARATION

- a. Be certain that all items checked in the airplane equipment list are installed in the proper location in the airplane.
- b. Remove excessive dirt, grease, moisture, foreign items such as rags and tools from the airplane before weighing.
- c. Defuel airplane. Then open all fuel drains until all remaining fuel is drained. Operate each engine until all undrainable fuel is used and engine stops.
- d. Drain all oil from the engines, by means of the oil drain, with the airplane in ground attitude. This will leave the undrainable oil still in the system. Engine oil temperature should be in the normal operating range before draining.
- e. Place pilot and copilot seats in fourth (4th) notch, aft of forward position. Put flaps in the fully retracted position and all control surfaces in the neutral position. Tow bar should be in the proper location and all entrance and baggage doors closed.
- f. Weigh the airplane inside a closed building to prevent errors in scale readings due to wind.

2. LEVELING

- a. With airplane on scales, block main gear oleo pistons in the fully extended position.
- b. Level airplane (see diagram) deflating nose wheel tire, to center bubble on level.

3. WEIGHING - AIRPLANE EMPTY WEIGHT

- a. With the airplane level and brakes released, record the weight shown on each scale. Deduct the tare, if any, from each reading.

Scale Position and Symbol	Scale Reading	Tare	Net Weight
Nose Wheel (N)			
Right Main Wheel (R)			
Left Main Wheel (L)			
Airplane Empty Weight, as Weighed (T)			

4. EMPTY WEIGHT CENTER OF GRAVITY

- a. The following geometry applies to the PA-34-200 airplane when airplane is level. (See Item 2)

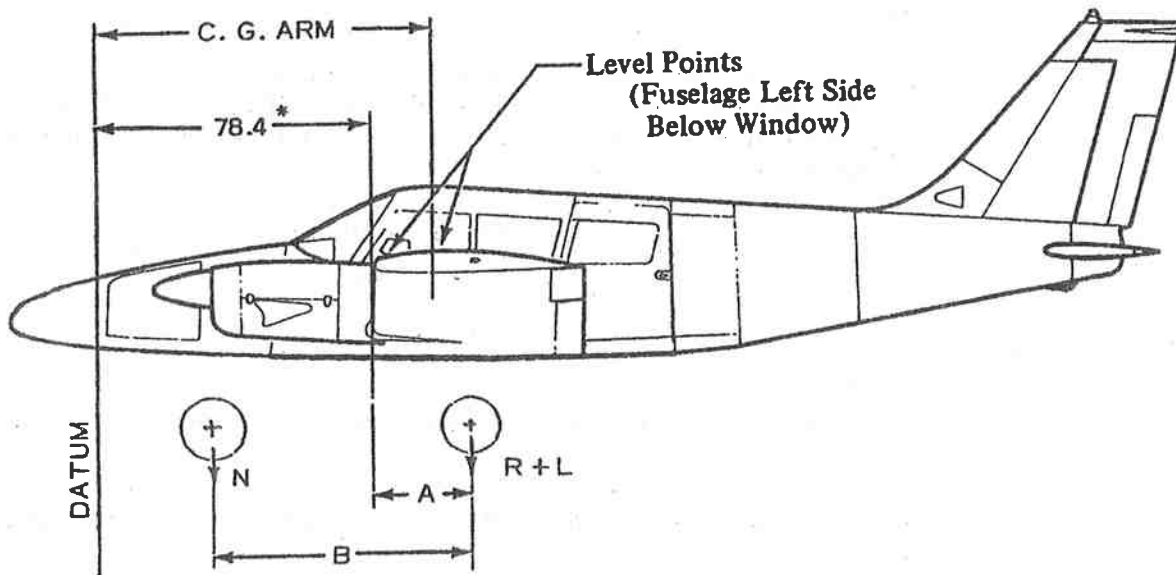

*The datum is 78.4 inches ahead of the wing leading edge at the inboard edge of the inboard fuel tank.

- b. Obtain measurement "A" by measuring from a plumb bob dropped from the wing leading edge, at the intersection of the straight and tapered section, horizontally and parallel to the airplane centerline, to the main wheel centerline.
- c. Obtain measurement "B" by measuring the distance from the main wheel centerline, horizontally and parallel to the airplane centerline, to each side of the nose wheel axle. Then average the measurements.
- d. The empty weight center of gravity (as weighed including optional equipment and undrainable oil) can be determined by the following formula:

$$C.G. \text{ Arm} = 78.4 + A - \frac{B(N)}{T}$$

$$C. G. \text{ Arm} = 78.4 + (\quad) - \frac{(\quad)(\quad)}{(\quad)} = \quad \text{inches}$$

5. LICENSED EMPTY WEIGHT AND EMPTY WEIGHT CENTER OF GRAVITY

	Weight	Arm	Moment
Empty Weight (as weighed)			
Unusable Fuel (5.0 gallon)	+30	103.0	+3090
Licensed Empty Weight			

SENECA

WEIGHT AND BALANCE DATA

MODEL PA-34-200 SENECA

Airplane Serial Number 34

Registration Number

Date

AIRPLANE BASIC WEIGHT

Item	Weight (Lbs)		C. G. Arm (Inches Aft of Datum)	= Moment (In-Lbs)
	Actual	Computed		
Standard Empty Weight*				
Optional Equipment				
Unusable Fuel (5 gallon)	30		103.0	3090
Licensed Empty Weight = Total of above items				
Oil (16 quarts)	30		49.0	1470
Basic Weight = Licensed Empty Weight Plus Oil				
*Standard Empty Weight includes paint, hydraulic fluid and undrainable engine oil.				

AIRPLANE USEFUL LOAD - NORMAL CATEGORY OPERATION

(Gross Weight) - (Licensed Empty Weight) = Useful Load

(4200 lbs) - (lbs) = lbs

THIS LICENSED EMPTY WEIGHT, C.G. AND USEFUL LOAD ARE FOR THE AIRPLANE AS DELIVERED FROM THE FACTORY. REFER TO APPROPRIATE AIRCRAFT RECORD WHEN ALTERATIONS HAVE BEEN MADE.

C. G. RANGE AND WEIGHT INSTRUCTIONS

1. Add the weight of all items to be loaded to the licensed empty weight.
2. Use the loading graph to determine the moment of all items to be carried in the airplane.
3. Add the moment of all items to be loaded to the licensed empty weight moment.
4. Divide the total moment by the total weight to determine the C.G. location.
5. By using the figures of Item 1 and Item 4, locate a point on the C.G. range and weight graph. If the point falls within the C.G. envelope, the loading meets the weight and balance requirements.

SAMPLE LOADING PROBLEM (Normal Category)

	Weight (Lbs)	Arm Aft Datum (Inches)	Moment (In-Lbs)
Licensed Basic Weight			
Pilot and Front Passenger	340.0	85.5	29070
Passengers (Center Seats)	340.0	118.1	40154
Passengers (Rear Seats)*		155.7	
Passenger (Jump Seat)*		118.1	
Fuel (93 Gallon Maximum)		93.6	
Baggage (Forward)		22.5	
Baggage (Aft)		178.7	
Total Loaded Airplane			

The center of gravity (C.G.) of this sample loading problem is at _____ inches aft of the datum line. Locate this point () on the C.G. range and weight graph. Since this point falls within the weight-C.G. envelope, this loading meets the weight and balance requirements.

IT IS THE RESPONSIBILITY OF THE PILOT AND AIRCRAFT OWNER TO INSURE THAT THE AIRPLANE IS LOADED PROPERLY.

*Optional Equipment

LOADING GRAPH

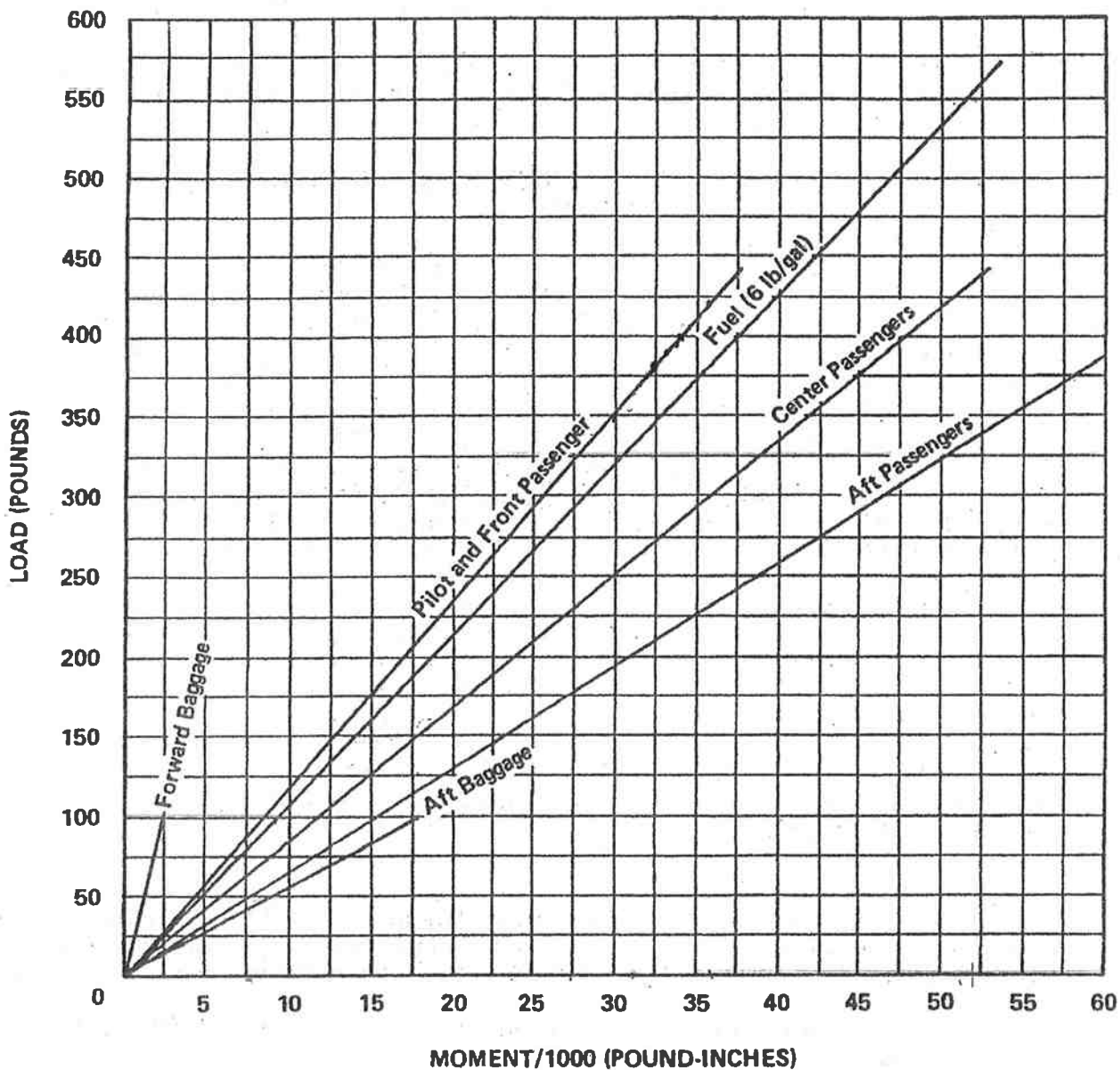

IT IS THE RESPONSIBILITY OF THE OWNER AND PILOT TO ASCERTAIN THAT THE AIRPLANE ALWAYS REMAINS WITHIN THE ALLOWABLE WEIGHT VS. CENTER OF GRAVITY ENVELOPE WHILE IN FLIGHT.

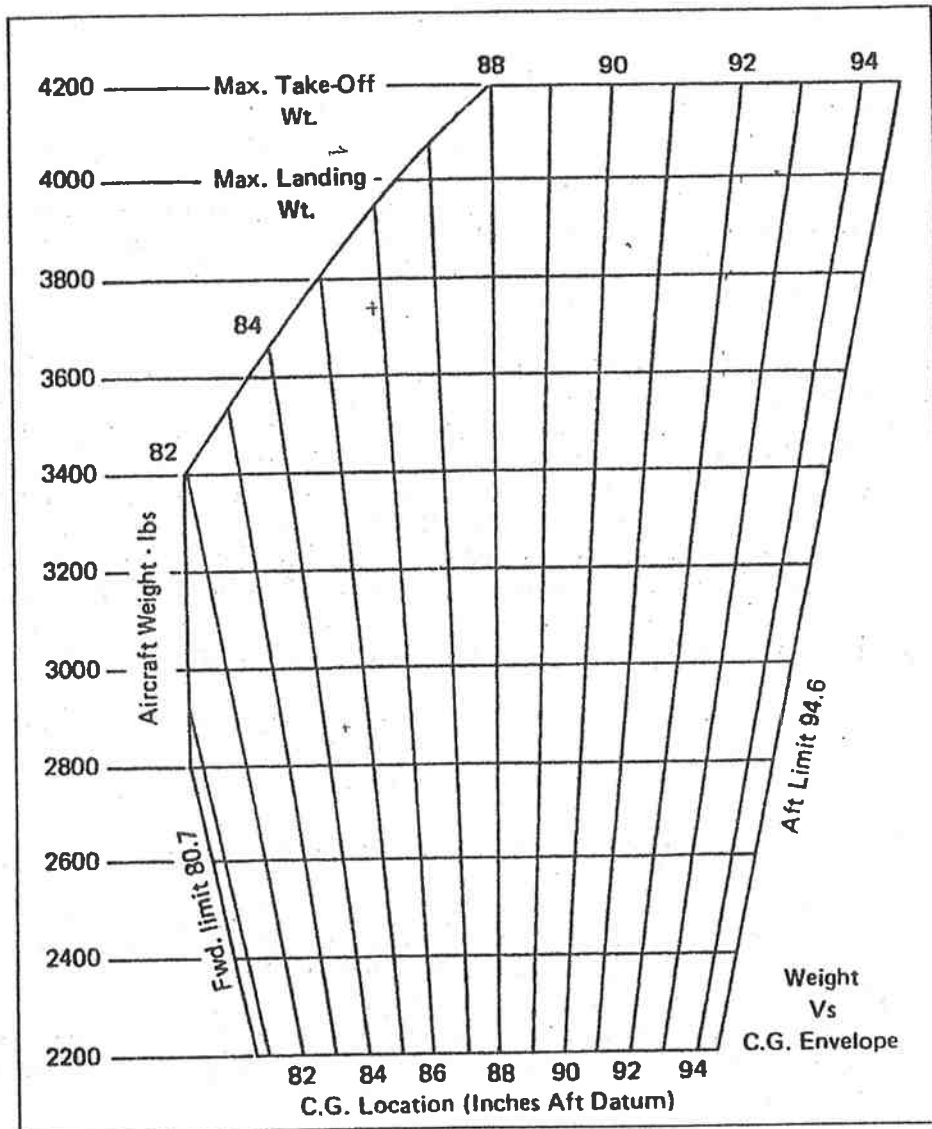

Moment change due to retracting Landing Gear = - 32 in. -lbs.

INSTRUCTIONS FOR USING THE WEIGHT AND BALANCE PLOTTER

This plotter is provided to enable the pilot quickly and conveniently to:

- (1) Determine the total weight and C.G. position.
- (2) Decide how to change his load if his first loading is not within the allowable envelope.

Heat can warp or ruin the plotter if it is left in the sunlight. Replacement plotters may be purchased from Piper dealers and distributors.

When the airplane is delivered, the basic weight and basic C.G. will be recorded on the computer. These should be changed anytime the basic weight or C.G. location is changed.

The plotter enables the user to add weights and corresponding moments graphically. The effect of adding or disposing of useful load can easily be seen. The plotter does not cover the situation where cargo is loaded in locations other than on the seats or in the baggage compartments.

Brief instructions are given on the plotter itself. To use it, first plot a point on the grid to locate the basic weight and C.G. location. This can be put on more or less permanently because it will not change until the airplane is modified. Next, position the zero weight end of one of the six slots over this point. Using a pencil, draw a line along the slot to the weight which will be carried in that location. Then position the zero weight end of the next slot over the end of this line and draw another line representing the weight which will be located in this second position. When all the loads have been drawn in this manner, the final end of the segmented line locates the total load and the C.G. position of the airplane for take-off. If this point is not within the allowable envelope it will be necessary to offload fuel, baggage, or passengers and/or to rearrange baggage and passengers to get the final point to fall within the envelope.

Fuel burn-off and gear movement do not significantly affect the center of gravity.

SAMPLE PROBLEM

A sample problem will demonstrate the use of the weight and balance plotter.

Assume a basic weight and C.G. location of 2615 pounds at 82.0 inches respectively. We wish to carry a pilot and 5 passengers. Two men weighing 180 and 200 pounds will occupy the front seats, two women weighing 115 and 135 pounds will occupy the middle seats and two children weighing 80 and 100 pounds will ride in the rear. Two 25 pound suitcases will be tied down in the front baggage compartment and two suitcases weighing 25 pounds and 20 pounds respectively will be carried in the rear compartment. We wish to carry 60 gallons of fuel. Will we be within the safe envelope?

1. Place a dot on the plotter grid at 2615 pounds and 82.0 inches to represent the basic airplane. (See illustration.)
2. Slide the slotted plastic into position so that the dot is under the slot for the forward seats, at zero weight.
3. Draw a line up the slot to the 380 pound position ($180 + 20.0$) and put a dot.
4. Move the slotted plastic again to get the zero end of the middle seat slot over this dot.
5. Draw a line up this slot to the 250 pound position ($115 + 135$) and place the 3rd dot.
6. Continue moving the plastic and plotting points to account for weight in the rear seats ($80 + 100$), forward baggage compartment (50), rear baggage compartment (45), and fuel tanks (360).
7. As can be seen from the illustration, the final dot shows the total weight to be 3880 pounds with the C.G. at 89.52. This is well within the envelope.
8. There will be room for more fuel.

As fuel is burned off, the weight and C.G. will follow down the fuel line and stay within the envelope for landing.

SAMPLE PROBLEM

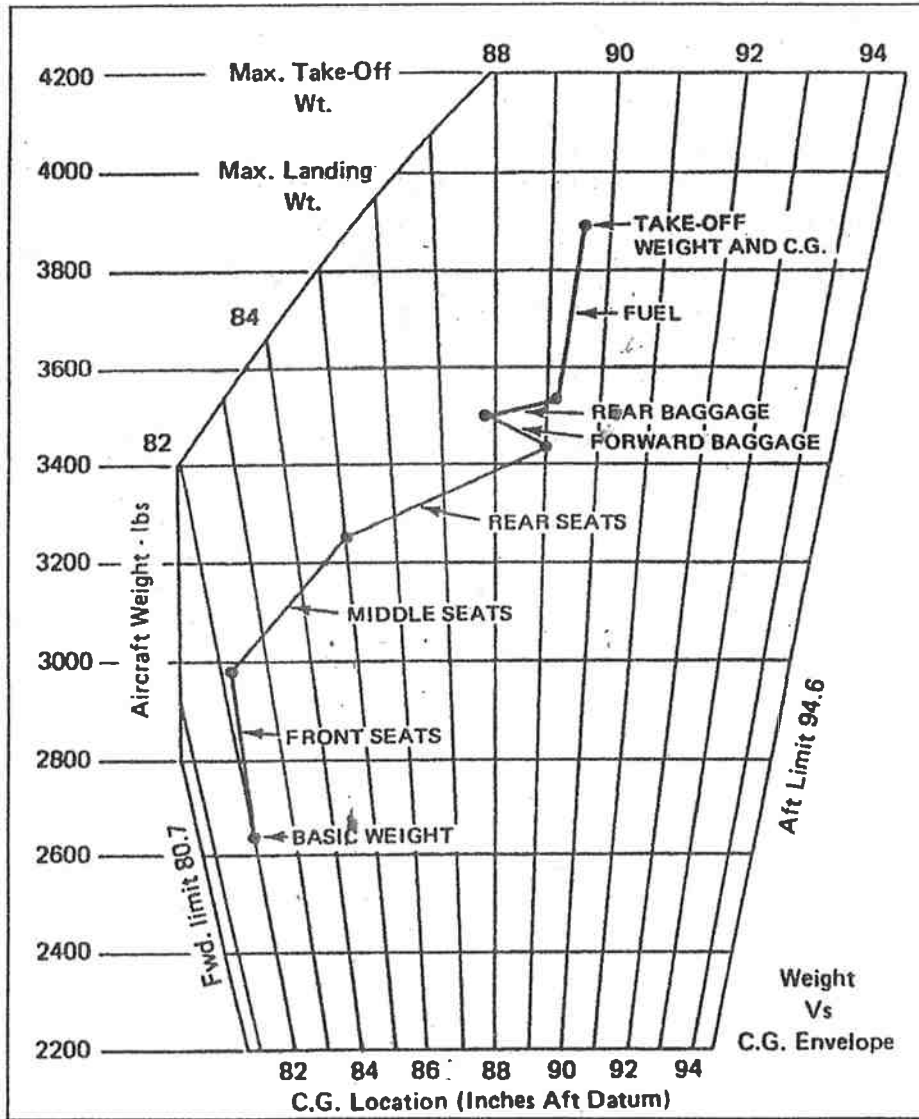

Moment change due to retracting Landing Gear = -32 in.-lbs.

EQUIPMENT LIST

The following is a list of equipment which may be installed in the PA-34. Items marked with an "X" are items installed when the airplane was delivered by the manufacturer.

Item	Item	Weight Lbs.	Arm Aft Datum	Moment	Cert. Basis
A. Propellers and Propeller Accessories					
Two Propellers					
_____	Hartzell Model HC-C2YK-2()E /C7666A-0 (Left Wing)	55.0	22.6	1243	TC P920
_____	Hartzell Model HC-C2YK-2()EF /FC7666A-0 (Left Wing)	55.0	22.6	1243	TC P920
_____	Hartzell Model HC-C2YK-2()LE /JC7666A-0 (Right Wing)	55.0	22.6	1243	TC P920
_____	Hartzell Model HC C2YK-2()LEF /FJC7666A-0 (Right Wing)	55.0	22.6	1243	TC P920
X	Hartzell Model HC-C2YK-2CG(F) /(J)C7666A (Includes Damper) (Left Wing)	62.9	23.2	1459	TC P920
X	Hartzell Model HC-C2YK-2CLG(F) /(J)JC7666A (Includes Damper) (Right Wing)	62.9	23.2	1459	TC P920
Two Spinners					
X	PAC Dwg. 96083-0 (Left Wing)	4.0	22.9	92	TC A7SO
X	PAC Dwg. 96083-1 (Right Wing)	4.0	22.9	92	TC A7SO
_____	PAC Dwg. 96083-4 (Left Wing)	4.2	22.9	96	TC A7SO
_____	PAC Dwg. 96083-5 (Right Wing)	4.2	22.9	96	TC A7SO
Two Hydraulic Governors					
X	Hartzell Model F-6-18A (Left Wing)	5.5	33.6	185	TC P920
X	Hartzell Model F-6-18AL (Right Wing)	5.5	33.6	185	TC P920

SENECA

Item	Item	Weight Lbs.	Arm Aft Datum	Moment	Cert. Basis
B. Engine and Engine Accessories- Fuel and Oil Systems					
	Two Engines Lycoming Model IO-360-C1E6 with Fuel Injector Lycoming P/N LW-12586 (Left Wing)	306	43.2	13219	TC 1E10
X	Lycoming Model LIO-360-C1E6 with Fuel Injector Lycoming P/N LW-12586 (Right Wing)	306	43.2	13219	TC 1E10
X	Two Fuel Pumps - Electric Auxiliary Airborne 1B5-6 (3.2 lbs. each)	6.4	70.0	448	TC A7SO
X	Two Induction Air Filters Fram Model CA-144PL (.5 lbs. each)	1.0	61.7	62	TC A7SO
X	Two Fuel Pumps - Engine Driven AC Type JT (1.6 lbs. each) Lycoming 75247	3.2	55.7	178	TC 1E10
X	Two Alternators 12V 60 Amp Prestolite ALY 6408 (13 lbs. each)	26.0	35.0	910	TC A7SO
	Two Starters - 12V Prestolite Model MZ-4206 (Left Wing)	18.0	33.2	598	TC 1E10
X	Prestolite Model MZ-4216 (Right Wing)	18.0	33.2	598	TC 1E10
X	Two Oil Coolers PAC Dwg. 96809 Stewart-Warner Model 10557-A	5.2	64.2	334	TC A7SO

Item	Item	Weight Lbs.	Arm Aft Datum	Moment	Cert. Basis
C. Landing Gear and Brakes					
	Two Main Wheel - Brake Assemblies				
	40-90 Wheel Assembly (Cleveland)				TSO C26a
	30-65 Brake Assembly (Cleveland)				TSO C26a
	Two Main 8 Ply Rating Tires				
	6.00-6 Type III with Regular Tubes (18.8 lbs. each)	37.6	109.8	4128	TSO C62
	One Nose Wheel Assembly				
	38501 Wheel Assembly (Cleveland)				TSO C26a
	One 6 Ply Rating Tire				
	6.00-6 Type III Regular Tube	12.5	** 25.5	319	TSO C62
	One Nose Wheel Assembly				
	40-76B Wheel Assembly (Cleveland)				TSO C26a
	One 6 Ply Rating Tire				
	6.00-6 Type III Regular Tube	12.8	** 25.5	326	TSO C62

**Static position shown, retracted position is at sta. 5.6

SENECA

Item	Item	Weight Lbs.	Arm Aft Datum	Moment	Cert. Basis
D. Electrical Equipment					
<u>X</u>	One Battery 12V, 35 Amp Hour Rebat R-35	27.0	-7.8	-211	TC A7SO
<u>X</u>	Power Relay 63880-0	1.2	-7.8	-9	TC A730
<u>X</u>	Stall Warning Detector, Safe Flight Inst. Corp. No. C52207-4 (.2 lbs. each)	.4	80.2	32	TC A7SO
<u>X</u>	Horn (Stall Warn) Safe Flight 53514-101	0.2	64.6	13	TSO C30b
<u>X</u>	Horn (Gear Warn) Safe Flight 2024-1	0.2	61.5	12	TSO C30b
<u>X</u>	Switch - Landing Gear Selector Cutler Hammer 8906 K 1736	0.1	67.7	7	TC A7SO
<u>X</u>	Two Voltage Regulators Wico Electric No. X18150 (1.0 lbs. each) or	2.0	49-4	99	TC A7SO
<u>X</u>	Electrodelta No. VF 710 (0.5 lbs. each)	1.0	49.4	49.4	TC A7SO
<u>X</u>	Two Overvoltage Relays Piper NO. PS50034-1 (.5 lbs. each)	1.0	49.1	49	TC A7SO
	Two Starter Relays Piper Dwg. 99130-2 (1.1 lbs. each)	2.2	41.5	91	TC A7SO

Item	Item	Weight Lbs.	Arm Aft Datum	Moment	Cert. Basis
D. Electrical Equipment (cont)					
<u>X</u>	Two Landing Lights G. E. Model 4509 (.8 lbs. each)	1.6	27.0	43	TC A7SO
<u>X</u>	Forward Baggage Light Piper 66632-0	0.2	40.8	8	TC A7SO
<u>X</u>	Navigation Light (rear) Grimes A2064	0.2	316.0	63	TSO C30b
<u>X</u>	Navigation Light (Wing) (2) Grimes A1285 - G - 12 A1285 - R - 12 (0.2 lbs. each)	0.4	102.4	41	TSO C30b
<u>X</u>	Instrument Light, Grimes 15-0083-1 (2) .25 lbs. each	0.5	92.7	46	TC A7SO
	Anti-Collision Lights Whelen Engineering Co. Piper Dwg. 95267				
<u>X</u>	Power Supply, Model HS, No. A412A-14 (with fin light only)	2.3	127.5	293	TC A7SO
	Light, Fin Tip, A408	0.4	289.5	116	TC A7SO
	Cable, Fin Light, A417-1/300	0.4	260.1	104	TC A7SO

THIS PAGE INTENTIONALLY LEFT BLANK

Item	Item	Weight Lbs.	Arm Aft Datum	Moment	Cert. Basis
	E. Instruments				
<u>X</u>	Compass - Piper Dwg. 67462	0.9	64.9	58	TSO C7c
<u>X</u>	Tachometer - Piper 62177-3 (2) .70 lbs. each	1.4	66.2	93	TC A7SO
<u>X</u>	Tachometer - Piper 62177-9 (2) .70 lbs. each	1.4	66.2	93	TC A7SO
<u>X</u>	Engine Cluster - Piper 95241-8 (2) 95 lbs. each	1.9	67.4	128	TC A7SO
<u>X</u>	Altimeter - Piper PS50008-2 or -3	1.0	65.9	66	TSO C10b
<u>X</u>	Manifold Pressure (Dual) - Piper PS50031-2	1.2	66.2	79	TSO C45
<u>X</u>	Fuel Flow Gauge (Dual) - Piper 96394-0	1.2	66.2	79	TSO C47
<u>X</u>	Ammeter- Piper 66696(2) .3 lbs. each	0.6	67.4	40	TC A7SO
<u>X</u>	Tru Speed Indicator - Piper PS50049-6 or -8	0.6	66.8	40	TSO C2b

SENECA

Item	Item	Weight Lbs.	Arm Aft Datum	Moment	Cert. Basis
	F. Hydraulic Equipment				
<u>X</u>	Cylinder Hydraulic Nose Gear Piper Dwg. 96860-0	0.9	41.6	37	TC A7SO
<u>X</u>	Cylinder Hydraulic (2) Main Gear Piper Dwg. 96860-0 (0.9 lbs each)	1.8	108.4	195	TC A7SO
<u>X</u>	Pump Assembly - Piper Dwg. 96110-0	9.0	-0.2	-2	TC A7SO
<u>X</u>	Switch, Pressure Consolidated Control 211c243-12	0.2	48.9	10	TC A7SO
<u>X</u>	Valve - Relief AN6245AB4 (2350±50 PSI Opening Pressure)	0.2	43.3	9	TC A7SO
<u>X</u>	Valve - Free Fall Piper Dwg. 67522-2	0.3	43.3	13	TC A7SO
<u>X</u>	Valve - Check MS24593-4	0.05	42.4	2	TC A7SO

Item	Item	Weight Lbs.	Arm Aft Datum	Moment	Cert. Basis
G. Miscellaneous					
<u>X</u>	Forward Seat Belts (2) PS50039-4-2 .75 lbs. each	1.5	86.9	130	TSO C22
<u>X</u>	Center Seat Belts (2) PS50039-4-3 .70 lbs. each	1.4	123.0	172	TSO C22
<u>X</u>	Rear Seat Belts (2) .75 lbs. each PS50039-4-4	1.5	163.0	245	TSO C22
<u>X</u>	Inertia Safety Belts, Front Seats (2) PS50039-4-8 0.9 lbs. each	1.8	120.1	216	TC A7SO
<u>X</u>	Toe Brakes (Left) Piper Dwg. 95392-0	5.0	54.6	273	TC A7SO
<u>X</u>	Rear Cabin Door Piper Dwg. 69373-5	16.5	152.2	2511	TC A7SO
<u>X</u>	Cargo Door Piper Dwg. 68999-11	6.8	179.0	1217	TC A7SO
<u>X</u>	Right Front Seat Piper Dwg. 99727-5	15.5	93.0	1442	TC A7SO
	Right Front Seat Piper Dwg. 96806-5	15.6	92.7	1446	TC A7SO
	Center Seats (2) Piper Dwg. 99730-0 & -1 13.5 lbs. each	27.0	124.1	3351	TC A7SO
<u>X</u>	Center Seats (2) Piper Dwg. 96827-2, -3 11.9 lbs. each	23.8	124.4	2961	TC A7SO
	Rear Seats (2) 14.5 lbs. each 99730-2 & -3	29.0	160.7	4660	TC A7SO
<u>X</u>	Rear Seats (2) 12.3 lbs. each 96827-4 & -5	24.6	161.1	3963	TC A7SO
<u>X</u>	Flight Manual and Logs	2.6	95.1	247	TC A7SO
<u>X</u>	Alternate Static Source Piper Dwg. 95331-2, -4, -6, -8, or-10	.4	66.0	26	TC A7SO

Calibrated Alternate Static Source
Placard Required: YES NO

SENECA

Item	Item	Weight Lbs.	Arm Aft Datum	Moment	Cert. Basis
	H. Engine and Engine Accessories - Fuel and Oil System (Optional Equipment)				
	Two Vacuum Pumps				
<u>X</u>	Airborne Manufacturing Co. Model 201CC (Left Wing)	4.5	54.5	245	TC A7SO
<u>X</u>	Airborne Manufacturing Co. Model 202CW (Right Wing)	4.5	54.5	245	TC A7SO
	Two Oil Filters with Adapters				
<u>X</u>	AC OF5578770 (3.3 lbs. each) (Lycoming # 75528)	6.6	58.7	387	TC A7SO

Item	Item	Weight Lbs.	Arm Aft Datum	Moment	Cert. Basis
I. Electrical Equipment (Optional Equipment)					
<u>X</u>	Auxiliary Power Receptacle Piper 62355-8	2.6	-7.8	-20	TC A7SO
<u> </u>	External Power Cable Piper 62355-2	4.6	33.0	152	TC A7SO
<u>X</u>	Cabin Speaker Quincy Spkr. Co. 8B-15052 or Oaktron Ind. GEV 1937	0.8	97.5	78	TC A7SO
<u>X</u>	Instrument Lights (Post) GLAR-BAN 5952-3RH-CW	0.2	68.0	14	TC A7SO

SENECA

Item	Item	Weight Lbs.	Arm Aft Datum	Moment	Cert. Basis
I. Electrical Equipment (Optional Equipment)					
<u>X</u>	Heated Pitot Head - Piper 96392-0	0.4	100.0	40	TC A7SO
	Anti-Collision Lights Whelen Engineering Co. Piper Dwg. 95267				
	Power Supply, Model HD, T3 No. A413 (with fin and wing lights)	3.0	127.5	383	TC A7SO
	Lights, Wing Tip (2) 0.15 lbs. each, No. A429	0.3	102.4	31	TC A7SO
	Cable, Wing Lights, A417-1/298 & A417-1/252	1.9	110.0	209	TC A7SO
<u>X</u>	Manual Electric Trim Servo # 1C345-4-321	2.3	196.0	451	TC A7SO
<u>X</u>	Cable Assembly	.5	106.6	53	TC A7SO
<u>X</u>	Reading Light (2) Grimes 10-0154-1 .25 lbs. each	0.5	149.3	75	TC A7SO
	Reading Light (2) Grimes 10-0154-1 .25 lbs. each	0.5	115.0	58	TC A7SO

Item	Item	Weight Lbs.	Arm Aft Datum	Moment	Cert. Basis
J. Autopilots (Optional Equipment)					
Autocontrol III					
<u>X</u>	Roll Servo #1C363-1-298R	2.5	121.8	305	TC A7SO
<u>X</u>	Console #1C338	1.2	65.0	78	TC A7SO
<u>X</u>	Attitude Gyro #52D66	2.3	64.9	149	TC A7SO
<u>X</u>	Directional Gyro #52D54	3.2	63.8	204	TC A7SO
<u>X</u>	Cable Assys.	<u>.7</u>	<u>95.5</u>	<u>67</u>	TC A7SO
	TOTAL	9.9	81.1	803	
Altimatec IIIB-1					
<u> </u>	Roll Servo #1C363-1-298R	2.5	121.8	305	TC A7SO
<u> </u>	Pitch Servo #1C508-1-298P	2.5	117.6	294	TC A7SO
<u> </u>	Trim Servo #1C345-1-298	2.8	196.0	549	TC A7SO
<u> </u>	Trim Sensor #1C656-298	.6	135.1	81	TC A7SO
<u> </u>	Relay Box #1A526	.3	57.8	17	TC A7SO
<u> </u>	Console #1C519-2	1.5	65.0	98	TC A7SO
<u> </u>	Amplifier #1C515-1	2.6	126.2	328	TC A7SO
<u> </u>	Altitude Selector #1D391-2	1.1	56.4	62	TC A7SO
<u> </u>	Altitude Gyro #52D67	2.7	64.9	175	TC A7SO
<u> </u>	Directional Gyro #52D54	3.2	63.8	204	TC A7SO
<u> </u>	Cable Assys.	<u>4.5</u>	<u>106.6</u>	<u>480</u>	TC A7SO
	TOTAL	24.3	106.7	2593	
<u> </u>	Radio Coupler #1C388P	.9	64.4	58	TC A7SO
<u> </u>	Glide Slope Coupler #1C493	.9	60.1	54	TC A7SO

SENECA

Item	Item	Weight Lbs.	Arm Aft Datum	Moment	Cert. Basis
J. Autopilots (Optional Equipment) (cont)					
_____	AltiMatic V/FD-1 Installation Power Supply PS-815B	2.5	202.1	505	TC A7SO
_____	Corrector 4000202-8501	.2	205.8	41	TC A7SO
_____	Computer Amplifier CA-814A	4.1	199.6	818	TC A7SO
_____	Directional Gyro SG-832B	3.0	196.8	590	TC A7SO
_____	Pitch Trim Servo ST-816B	3.2	197.0	630	TC A7SO
_____	Aileron Servo SA-816A	3.3	118.5	391	TC A7SO
_____	Altitude Controller AC-844B	1.5	218.8	328	TC A7SO
_____	Stabilator Servo SE-816A	3.7	267.7	990	TC A7SO
_____	Magnetic Flux Sensor 4000191- 8501	.3	216.5	65	TC A7SO
_____	Flight Controller FC-823B	1.8	66.7	120	TC A7SO
_____	Manual Navigation Converter 4000207	1.7	59.8	102	TC A7SO
_____	Slaving Meter 4000192-8501	0.1	67.8	7	TC A7SO
_____	Horizontal Situation Indicator IN-831 A	3.5	63.9	224	TC A7SO
_____	Director Horizon Ind. DH-841A	3.3	64.8	214	TC A7SO
_____	Shelf and Instl. - Trim Servo, Amp	2.9	199.7	579	TC A7SO
_____	Shelf and Instl. - Aileron Servo	1.0	119.7	120	TC A7SO
_____	Shelf and Instl. - Altitude Cont.	0.7	218.1	153	TC A7SO
_____	Shelf and Instl. - Stabilator Servo	1.4	267.1	374	TC A7SO
_____	Shelf and Instl. - Flux Sensor	.5	216.5	108	TC A7SO
_____	Miscellaneous Hardware	2.0	118.0	236	TC A7SO
_____	Wire Harness	11.0	145.0	1595	TC A7SO
	TOTAL	51.7	158.4	8190	

Item	Item	Weight Lbs.	Arm Aft Datum	Moment	Cert. Basis
J. Autopilots (Optional Equipment) (cont)					
_____	AltiMatic V-1 Installation Power Supply PS-815A	2.5	202.1	505	TC A7SO
_____	Computer Amplifier CA-814A	4.1	199.6	818	TC A7SO
_____	Pitch Trim Servo ST-816B	3.2	197.0	630	TC A7SO
_____	Aileron Servo SA-816A	3.3	118.5	391	TC A7SO
_____	Altitude Controller AC-844B	1.5	218.8	328	TC A7SO
_____	Stabilator Servo SE-816A	3.7	267.7	990	TC A7SO
_____	Flight Controller FC-823A	1.6	66.7	107	TC A7SO
_____	Directional Gyro DG-817A	3.6	63.9	230	TC A7SO
_____	Altitude Gyro 2179ACF	2.9	64.8	188	TC A7SO
_____	Shelf and Instl. - Trim Servo, Amp.	2.9	199.7	579	TC A7SO
_____	Shelf and Instl. - Aileron Servo	1.0	119.7	120	TC A7SO
_____	Shelf and Instl. - Altitude Cont.	0.7	218.1	153	TC A7SO
_____	Shelf and Instl. - Stabilator Servo	1.4	267.1	374	TC A7SO
_____	Miscellaneous Hardware	2.0	118.0	236	TC A7SO
_____	Wire Harness	11.0	145.0	1595	TC A7SO
	TOTAL	45.4	159.6	7244	

SENECA

Item	Item	Weight Lbs.	Arm Aft Datum	Moment	Cert. Basis
K. Radio Equipment (Optional Equipment)					
_____	Narco Mark 16 Transceiver, Single	7.5	61.9	464	TC A7SO
_____	Narco Mark 16 Transceiver, Dual	15.0	61.9	929	TC A7SO
_____	Narco VOA-50M Omni Converter	2.1	64.9	136	TC A7SO
_____	Narco VOA-40M Omni Converter	1.9	64.9	123	TC A7SO
_____	Narco VOA-40 Omni Converter	1.9	64.9	123	TC A7SO
_____	Nav. Receiving Antenna	0.5	283.1	142	TC A7SO
_____	Cable, Nav. Antenna	1.1	172.0	189	TC A7SO
_____	#1 VHF Comm. Antenna	0.3	190.6	57	TC A7SO
_____	Cable, #1 VHF Comm. Antenna	0.5	122.0	61	TC A7SO
_____	#2 VHF Comm. Antenna	0.3	225.2	68	TC A7SO
_____	Cable, #2 VHF Comm. Antenna	0.6	139.0	83	TC A7SO
Anti Static Kit					
_____	#1 VHF Comm. Antenna	1.0	190.6	191	TC A7SO
_____	Cable, #1 VHF Comm. Antenna	0.5	122.0	61	TC A7SO
_____	#2 VHF Comm. Antenna	1.0	225.2	225	TC A7SO
_____	Cable, #2 VHF Comm. Antenna	0.6	139.0	83	TC A7SO
_____	Low Frequency Antenna	0.6	160.0	96	TC A7SO
_____	Static Wicks	—	—	—	TC A7SO
_____	Narco Comm 10	3.9	62.4	243	TC A7SO
_____	Narco Comm 11	3.6	62.4	225	TC A7SO
_____	Narco Dual Comm 11	7.1	62.4	443	TC A7SO
_____	Narco Nav 10	1.9	63.6	120	TC A7SO
_____	Narco Nav 11	2.8	63.6	178	TC A7SO
_____	Narco Nav 12	3.4	63.6	214	TC A7SO
_____	Narco Dual Nav 11	5.6	63.6	356	TC A7SO
_____	Narco Nav 14	3.0	62.4	187	TC A7SO

Item	Item	Weight Lbs.	Arm Aft Datum	Moment	Cert. Basis
K. Radio Equipment (Optional Equipment) (cont)					
_____	Bendix ADF-T- 12 C or D Receiver Model 201F	3.9	64.4	251	TC A7SO
_____	Receiver Model 210 C or D	3.5	64.4	225	TC A7SO
_____	Audio Amplifier 102A	0.8	52.0	42	TC A7SO
_____	Servo Indicator 551A	1.7	65.9	112	TC A7SO
_____	Loop Antenna 2321E	1.3	198.8	258	TC A7SO
_____	Cable, Interconnecting	2.5	124.0	310	TC A7SO
_____	Sense Antenna and Cable	.4	182.0	73	TC A7SO
_____	King KX-175 VHF Transceiver	8.5	61.6	524	TC A7SO
_____	King KN-73 Glide Slope	2.7	12.7	34	TC A7SO
_____	King KN-77 VOR/LOC Conv.	3.2	12.0	38	TC A7SO
_____	King KNI-520 VOR/ILS Indicator	1.7	65.5	111	TC A7SO
_____	King KX-175 VHF Transceiver (2nd)	8.0	61.6	493	TC A7SO
_____	King KN-77 VOR/LOC Conv.	3.2	12.0	38	TC A7SO
_____	King KNS-520 VOR/ILS Indicator	1.7	65.5	111	TC A7SO

SENECA

Item	Item	Weight Lbs.	Arm Aft Datum	Moment	Cert. Basis
	K. Radio Equipment (Optional Equipment) (cont)				
<u>X</u>	King KX 170 ()/175 ()	7.5	61.6	462	TC A7SO
<u>X</u>	King Dual KX 170()/175()	15.0	61.6	924	TC A7SO
_____	King KI 201 ()	2.5	64.9	162	TC A7SO
_____	King KI 211 ()	3.3	64.9	214	TC A7SO
_____	King Dual KI 201 ()	5.0	64.9	325	TC A7SO
_____	King KR-85 Receiver	4.3	64.4	277	TC A7SO
_____	Servo Indicator	1.2	66.3	79	TC A7SO
_____	Loop Antenna	1.3	193.2	251	TC A7SO
_____	Loop Cable	1.8	124.0	223	TC A7SO
_____	Audio Amplifier	.8	52.5	42	TC A7SO
_____	Sense Antenna & Cable	.4	160.0	64	TC A7SO
_____	King KN-65 DME				TC A7SO
_____	King KI-265 Indicator	1.0	65.4	65	TC A7SO
_____	Remote Unit	8.4	27.2	228	TC A7SO
_____	King KA-41 Antenna	0.2	20.9	4	TC A7SO
_____	Cable Assy.	1.5	42.2	63	TC A7SO

* |

Item	Item	Weight Lbs.	Arm Aft Datum	Moment	Cert. Basis
	K. Radio Equipment (Optional Equipment) (cont)				
_____	PM-1 Marker Beacon Receiver	1.1	121.7	134	TC A7SO
_____	Remote Unit	0.3	128.0	38	TC A7SO
_____	Cable	0.2	96.0	19	TC A7SO
_____	UGR-2 Glide Slope Receiver	2.4	28.6	69	TC A7SO
_____	Cable	.7	45.3	32	TC A7SO
_____	Antenna Coupler (with dual VHF and/or Glide Slope)	.2	55.3	11	TC A7SO
_____	IFD Starlight Transponder Panel Unit	2.3	64.4	148	TC A7SO
_____	Antenna	0.1	52.5	5	TC A7SO
_____	Cable	0.3	51.5	15	TC A7SO
_____	King KN60C DME Receiver	6.8	61.7	420	TC A7SO
_____	Antenna	.15	112.1	17	TC A7SO
_____	Cable, Antenna	0.3	85.6	26	TC A7SO
_____	Narco AT5-A Transponder Panel Unit	2.0	64.4	129	TC A7SO
_____	Remote Unit	5.7	20.7	118	TC A7SO
_____	Cable, Interconnecting	0.5	43.5	22	TC A7SO
_____	Antenna and Cable	0.3	45.0	14	TC A7SO

SENECA

Item	Item	Weight Lbs.	Arm Aft Datum	Moment	Cert. Basis
K. Radio Equipment (Optional Equipment) (cont)					
_____	Narco AT6-A Transponder Panel Unit	2.0	64.4	129	TC A7SO
_____	Remote Unit	5.7	20.7	118	TC A7SO
_____	Cable, Interconnecting	0.5	43.5	22	TC A7SO
_____	Antenna and Cable	0.3	45.0	14	TC A7SO
_____	Narco AT50 Transponder Panel Unit	3.0	62.3	187	TC A7SO
_____	Antenna and Cable	—	—	—	TC A7SO
<u> X </u>	King KT76/78 Transponder Panel Unit	3.1	63.1	196	TC A7SO
<u> X </u>	Antenna and Cable	—	—	—	TC A7SO
<u> X </u>	King KMA-20 Audio Panel	2.8	65.2	183	TC A7SO
<u> X </u>	Antenna	.5	116.3	58	TC A7SO
<u> X </u>	Cable	.4	90.0	36	TC A7SO
_____	Audio Selector Panel Piper 99395-0, -2, or -3	.7	66.3	46	TC A7SO
_____	Microphone	.5	75.0	38	TC A7SO
_____	Headset	.5	65.0	33	TC A7SO

11/15/89

 X

Narco AR 500
Blind Encoder

.75

54.0

40.5

Item	Item	Weight Lbs.	Arm Aft Datum	Moment	Cert. Basis
	K. Radio Equipment (Optional Equipment) (cont)				
<u> X</u>	Piper Automatic Locator Transmitter	1.7	267.2	454	TC A7SO
<u> X</u>	Antenna & Coax	.2	255.4	51	TC A7SO
<u> X</u>	Shelf & Access Hole	.33	266.4	88	TC A7SO
<u> </u>	IFD Skyline 300 Panel Unit	1.7	65.4	111	TC A7SO
<u> </u>	Remote Unit	1.8	58.7	106	TC A7SO
<u> </u>	Antenna	.1	52.5	5	TC A7SO
<u> </u>	Cable	.1	53.6	5	TC A7SO

THIS PAGE INTENTIONALLY LEFT BLANK

Item	Item	Weight Lbs.	Arm Aft Datum	Moment	Cert. Basis
L. Instruments (Optional Equipment)					
_____	Suction Gauge - Piper 96395	0.5	67.2	34	TC A7SO
_____	Vacuum Regulator, Airborne Mech. 133C3 (2) .7 lbs. each	1.4	70.2	98	TC A7SO
_____	Vacuum Filter, Piper 66673	0.3	54.8	16	TC A7SO
_____	Indicator - Rate of Climb - Piper 99010-2, -4, or -5	1.0	65.9	66	TSO C8b
_____	Indicator - Rate of Climb - Piper 99010-3	.5	67.2	34	TSO C8b
_____	Attitude Gyro - Piper 99002-2, -3, -4, or -5	2.2	64.4	142	TSO C4c
_____	Directional Gyro - Piper 99003-2, -3, -4, or -5	2.6	64.7	168	TSO C5c
_____	Air Temperature Gauge - Piper 99470-0 or -2	0.2	77.6	16	TC A7SO
_____	Clock AN5743-L2	0.4	62.9	25	TC A7SO
_____	Turn and Slip Indicator - Piper PS50030-2 or -3	2.6	64.7	168	TSO C3A Type II
_____	Exhaust Gas Temperature - Piper 99027-2	0.7	60.4	42	TC A7SO

SENECA

Item	Item	Weight Lbs.	Arm Aft Datum	Moment	Cert. Basis
	L. Copilot's Advanced Instrumentation (Optional Equipment) (cont)				
_____	Attitude Gyro - Piper 99002-2, -3, 4, or -5	2.2	64.4	142	TSO C4c
_____	Directional Gyro, Piper 99003-2, -3, -4, or -5	2.6	64.7	168	TSO C5c
_____	Tru-Speed Indicator Piper PS50049-6 or -8	.6	66.8	40	TSO C2b
_____	Turn and Slip Indicator Piper PS50030-2 or -3	2.6	64.7	168	TSO C3a Type II
_____	Altimeter - Piper PS50008-2 or -3	1.0	65.9	66	TSO C10b
_____	Indicator Rate of Climb - Piper 99010-2, -4, or -5	1.0	65.9	66	TSO C8b
_____	Indicator Rate of Climb - Piper 99010-3	.5	67.2	34	TSO C8b
_____	Clock AN5743-L2	.4	62.9	25	TC A7SO

Item	Item	Weight Lbs.	Arm Aft Datum	Moment	Cert. Basis
M. Miscellaneous (Optional Equipment)					
<u>X</u>	Assist Step Piper Dwg. 68014-0	1.5	147.5	221	TC A7SO
<u>X</u>	Toe Brakes (Right) Piper Dwg. 95391-0	5.0	54.6	273	TC A7SO
	Jumpseat Piper Dwg. 69068-15	7.8	122.3	954	TC A7SO
<u>X</u>	Jumpseat Piper Dwg. 69595-5	8.1	122.3	991	TC A7SO
<u>X</u>	Seat Belt (Jumpseat) PS50039-4-5	1.4	123.0	172	TSO C22
<u>X</u>	Assist Straps and Coat Hooks (2) Piper Dwg. 62353-5 .15 lbs. each	0.3	120.0	36	TC A7SO
	Inertia Safety Belts Center Seats (2) PS50039-4-6 0.7 lbs. each	1.4	133.9	187	TC A7SO
	Inertia Safety Belts, Rear Seats (2) PS50039-4-7 (Std. Fuselage) 1.4 lbs. each	2.8	182.7	512	TC A7SO
	Inertia Safety Belts, Rear Seats (2) PS50039-4-7 (Fuselage w/Cargo Door) 1.4 and 1.6 lbs. each	3.0	181.5	545	TC A7SO
<u>X</u>	Lighter 200462 (12V Universal)	0.2	67.9	14	TC A7SO
	Fire Extinguisher, Kiddie Compact VI (with brackets) Piper Dwg. 65337-0	5.3	85.0	451	TC A7SO
<u>X</u>	Sun Visors (2) 66991-2 1.05 lbs. each	2.1	79.0	166	TC A7SO
<u>X</u>	Tow Bar Piper Dwg. 96331-0	4.4	168.0	739	TC A7SO

SENECA

Item	Item	Weight Lbs.	Arm Aft Datum	Moment	Cert. Basis
	M. Miscellaneous (Optional Equipment) (cont)				
_____	Adjustable Front Seat (Left) Piper Dwg. 99353-16	** 3.2	87.5	280	TC A7SO
<u> X </u>	Adjustable Front Seat (Left) Piper Dwg. 69568-2	** 3.1	90.8	281	TC A7SO
_____	Adjustable Front Seat (Right) Piper Dwg. 99353-17	** 3.2	87.5	280	TC A7SO
_____	Adjustable Front Seat (Right) Piper Dwg. 69568-3	** 2.4	90.8	218	TC A7SO
_____	Headrests, Front (2) 99255-3 1.0 lbs. each	2.0	99.5	199	TC A7SO
<u> X </u>	Headrests, Front (2) 96806-17 1.0 lbs. each	2.2	99.5	219	TC A7SO
_____	Headrests, Center (2) 99255-3 1.0 lbs. each	2.0	132.1	264	TC A7SO
_____	Headrests, Center (2) 96806-17 1.0 lbs. each	2.2	132.1	291	TC A7SO
_____	Headrests, Rear (2) 99255-3 1.0 lbs. each	2.0	169.7	339	TC A7SO
<u> X </u>	Headrests, Rear (2) 96806-17 1.0 lbs. each	2.2	169.7	373	TC A7SO
_____	Windshield Heating Unit	2.6	59.6	155	TC A7SO
_____	Combustion Heater Piper Dwg. 78424	46.8	193.3	9046	TSO C20

**Weight and moment difference between standard and optional equipment.

Item	Item	Weight Lbs.	Arm Aft Datum	Moment	Cert. Basis
M. Miscellaneous (Optional Equipment) (cont)					
_____	Fire Extinguisher, Scott Aviation (with Brackets) Piper Dwg. 78621-2	5.0	58.6	293	TC A7SO
_____	Fire Extinguisher, Kiddie & Co. (with Brackets) Piper Dwg. 76167-0	5.3	71.0	376	TC A7SO
_____	Fire Extinguisher, Scott Aviation (with Brackets) Piper Dwg. 76167-2	5.0	71.0	355	TC A7SO
_____	Ice Protection System Instl. (includes Windshield Heating Unit, Heated Pitot Head and Two Vacuum Pumps) Piper Dwg. 78642	56.3	87.9	4949	TC A7SO
Heavy Duty Wheels, Brakes and Tires					
_____	Two Main Wheel - Brake Assemblies Piper PS50035-14 Wheel Assembly 30-83 Brake Assembly (Cleveland) Two Main 8 Ply Rating Tires (Goodrich) 6.00 x 6 Ribbed Type III with Tube	*2.9	109.8	318	TSO C26 TSO C26 TSO C62
_____	One Nose Wheel Assembly Piper PS50035-11 Wheel Assembly One 8 Ply Rating Tire (Goodrich) 6.00 x 6 Ribbed Type III with Tube	*2.0	25.5	51	TSO C26 TSO C62
TOTAL OPTIONAL EQUIPMENT		_____	_____	_____	

EXTERIOR FINISH

Base Color _____ Registration No. Color _____
 Trim Color _____ Type Finish _____
 Accent Color _____

*Weight and moment difference between standard and optional equipment.

THIS PAGE INTENTIONALLY LEFT BLANK

OPERATING INSTRUCTIONS

Icing Page 6-12 n

OPERATING INSTRUCTIONS

THIS SECTION IS DESIGNED:

1. To help you operate your Seneca with safety and confidence.
2. To more fully acquaint you with the basic performance and handling characteristics of the airplane.
3. To more fully explain your Seneca's operation than is permissible to set forth in the Airplane Flight Manual.

Preflight	6-1
Walk-Around Inspection.....	6-2
Before Starting Engines.....	6-3
Starting Engines.....	6-3
Hot Start.....	6-3
Flooded Start.....	6-4
Starting Engines With Aid of External Electric Power	6-4
Taxi	6-5
Pretake-Off Check	6-5
Take-Off.....	6-7
Door Open on Take-Off.....	6-8
Climb	6-8
Normal Cruise.....	6-8
Descent	6-9
Approach and Landing	6-10
Post Landing.....	6-11
Shut Down	6-11
Airspeed Data	6-12
Rough Air Flight.....	6-12
Vmc - Minimum Single-Engine Control Speed	6-12
Operation In Known Icing Conditions	6-13
Emergency Procedures	6-14
Piper Automatic Locator	6-14

BLANK PAGE

OPERATING INSTRUCTIONS**PREFLIGHT**

If you are planning a flight in the Seneca:

1. Make sure the weather is suitable.
2. Plan the navigation (if going cross-country).
3. Check weight and balance for the flight. (See weight and balance section of this manual.)
4. Investigate performance and range. (See performance section of this manual.)

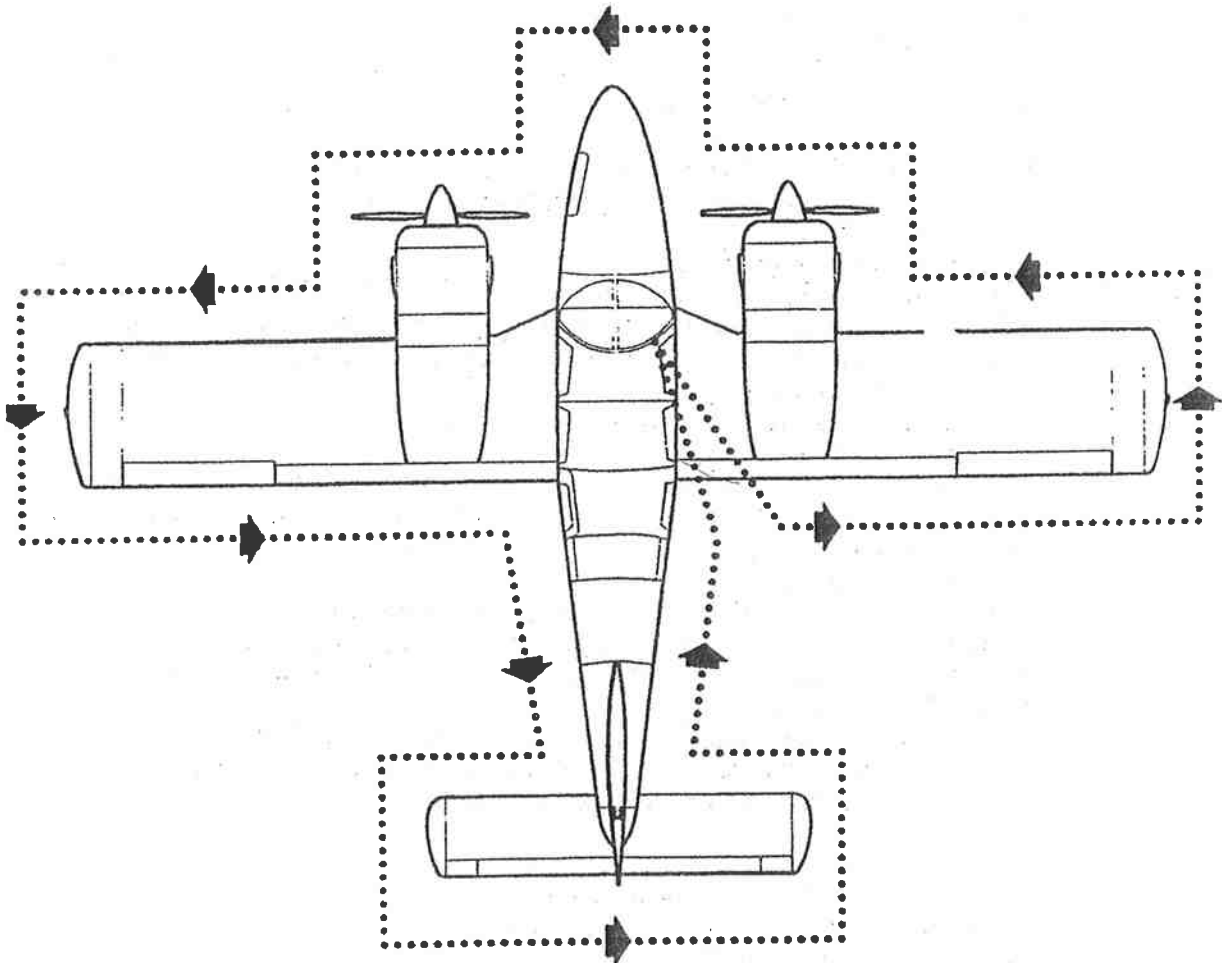

WALK-AROUND INSPECTION

In Cabin

1. Landing gear control - Ensure that it is in the "DOWN" position.
2. Avionics - Turn off, to save power and wear on the units.
3. Master switch - Turn on.
4. Landing gear lights - Three green lights should be illuminated. No red light.
5. Fuel quantity - Ensure adequate for flight plus reserve.
6. Cowl flaps - Open to facilitate inspection and ensure cooling after engine start.
7. Master switch - Turn off to save battery.
8. Ignition switches - should be off to prevent inadvertent start during inspection of propeller.
9. Mixture controls - should be in idle cut-off position, again to prevent inadvertent engine start.
10. Trim indicators - Set to neutral so that tabs may be checked for alignment.
11. Flaps - Extend and retract to check operation. This should be done before engine start so that you can hear any noise which might indicate binding.
12. Control locks - Unlock, and check control motion.
13. Fasten seat belts snugly on empty seats.
14. Drain pitot and static systems before flight.
15. Paperwork - Check that the proper aircraft papers are aboard and that the necessary inspections have been performed.

Outside Airplane

1. Right wing, aileron and flap - no damage, no ice. Check hinges.
2. Right main gear - no leaks, tires inflated and not excessively worn, 3-1/2 inches piston exposed under static load.
3. Right wing tip - no damage.
4. Right leading edge - no damage or ice.
5. Fuel cap - open to check quantity and color of fuel. Check cap vent, and then secure.
6. Right engine nacelle - Open doors to inspect engine. Check oil quantity - six to eight quarts. Secure both inspection doors.
7. Right propeller - no nicks or leaks, spinner secure and not cracked.
8. Cowl flaps - open and secure.
9. Fuel drains - Drain five on right side: two fuel tank drains (under wing), one gascolator drain (near bottom of engine nacelle), two crossfeed drains on bottom of fuselage inboard from wing flap.
10. Nose section - undamaged.
11. Nose gear - no leaks, tire inflated and not excessively worn, 2-1/2 inches piston exposed under static load, tow bar removed, condition of landing light checked.
12. Forward baggage door - secure and locked. (Key removable in locked position only.)
13. Windshield - clean and secure.
14. Left wing, engine nacelle and landing gear - inspect as on right side.
15. Pitot tube - hole unobstructed, heat checked by feel if need is anticipated.
16. Stall warning vanes - no damage, free movement.
17. Rear door - latched.
18. Left static vent - unobstructed.
19. Dorsal fin air scoop - free of obstruction.
20. Empennage - no damage, free of ice, hinges secure.
21. Stabilator - freedom of motion.
22. Right static vent - unobstructed.
23. Antennas - secure and undamaged.
24. Navigation and landing lights - check (after master switch and light switches have been turned on in cabin).

TAXI

Before taxiing, the brakes should be checked by moving forward a few feet, throttling back and applying pressure on the toe pedals. As much as possible, turns during taxiing should be made using rudder pedal motion and differential power (more power on the engine on the outside of the turn, less on the inside engine) rather than brakes. The following equipment may be checked during taxiing:

1. Instruments - turn indicator, directional gyro, coordination ball
2. Heater and defroster - especially important on a cold day
3. Fuel selector - Place each selector on "CROSSFEED" for a short time, while the other selector is in the "ON" position. Return selectors to the "ON" position. Do not attempt takeoff with selector on "CROSSFEED."

The autopilot, if installed, should be off during taxiing, and the electric fuel pump should be off in order to check the operation of the engine-driven fuel pump.

PRETAKE-OFF CHECK

A thorough check should be made before take-off, using a check list. Before advancing the throttle to check the magnetos and the propeller action, be sure that the engine is warm enough to accept the power if it is a cold day. If there is no hesitation in engine action when the throttle is advanced, the engine is warm enough.

1. Parking brake - on
2. Engine run-up
 - a. Mixture controls - forward
 - b. Propeller controls - forward
 - c. Throttle controls - forward to 1500 RPM
 - d. Propeller controls - Check the feather position by bringing the propeller controls fully back and then to the full forward position. The RPM should drop to 1000 RPM in 1 - 3 seconds. If more time is required, the propeller dome pressure may be excessively low resulting in a danger of propeller overspeed or loss of feathering capability.
 - e. Throttle controls - forward to 2000 RPM
 - f. Propeller controls - Exercise to check governor. Retard control until a 200 to 300 drop in RPM is indicated. This should be done three times on the first flight of the day. The governor can be checked by retarding the propeller control until a drop of 100 RPM to 200 RPM appears, then advancing the throttle to get a slight increase in manifold pressure. The propeller speed should stay the same when the throttle is advanced, thus showing that the governor is governing.
 - g. Propeller controls - full forward
 - h. Alternate air controls - on, then off again. There should be a drop in RPM when the control is placed in the "ON" position, since heated air is being supplied to the engine. Do not check the alternate air on the ground if dusty air conditions prevail.
 - i. Magnetos - check
Normal drop - 100 RPM
Maximum drop - 175 RPM
Maximum differential drop - 50 RPM
 - j. Alternator output - check, approximately equal output for both alternators
 - k. Throttles - 800-1000 RPM

3. Fuel - "ON" position
4. Alternators - on
5. Engine gauges - in the green
6. Vacuum gauge - 4.5 to 5.2 in. Hg.
7. Altimeter - set
8. Attitude indicator - set
9. Clock - wound and set
10. Mixtures - set
11. Propellers - set in forward position
12. Quadrant friction - adjusted
13. Alternate air - off
14. Cowl flaps - set
15. Seat backs - erect
16. Wing flaps - set
17. Trim (stabilator and rudder) - set
18. Seat belts and shoulder harness - fastened
19. Empty seats - seat belts snugly fastened
20. Controls - free, full travel
21. Doors - latched
22. Electric fuel pumps - on
23. Pitot heat - as required

The normally recommended procedure for sea level take-off is full throttle at 2700 RPM. During pretake-off check at a high elevation, lean the mixture to obtain maximum power. Apply full throttle; then lean the mixture until the fuel flow pointer stabilizes at a fuel consumption mark consistent with the density altitude (about 14.9 for 2000-foot elevation, 14.0 for 4000-foot elevation and 13.3 for 6000-foot elevation). Leave the mixture in this position for take-off. Do not overheat the engine when operating with mixture leaned. If overheating occurs, enrich the mixture enough that temperature returns to normal.

TAKE-OFF

Take-off should not be attempted with ice or frost on the wings. Take-off distances and 50-foot obstacle clearance distances are shown on charts in the Performance section of this manual. The performance shown on charts will be reduced by uphill gradient, tailwind component, or soft, wet, rough or grassy surface.

Avoid fast turns onto the runway, followed by immediate take-off, especially with a low fuel supply. As power is applied at the start of the take-off roll, look at the engine instruments to see that the engines are operating properly and putting out normal power, and at the airspeed indicator to see that it is functioning.

Normal Take-off (Flaps Up)

When obstacle clearance is no problem, a normal take-off may be used. Accelerate to 80-85 MPH and ease back on the wheel enough to let the airplane lift off. After lift-off, accelerate to the best rate of climb speed (105 MPH) or higher if desired, retracting the landing gear when a gear-down landing is no longer possible on the runway.

Short Field Take-off (Flaps Up)

When a short field effort is required but the situation presents a wide margin on obstacle clearance, the safest short field technique to use is with the flaps up. In the event of an engine failure, the airplane is in the best flight configuration to sustain altitude immediately after the gear is raised. Set the stabilator trim indicator in the take-off range. Set the brakes and bring the engines to full power before release. Accelerate to 80 MPH and rotate the airplane firmly so that the airspeed is approximately 85 MPH when passing through the 50-foot height. The airplane should then be allowed to accelerate to the best angle of climb speed (90 MPH at sea level) if obstacle clearance is necessary, or best rate of climb speed (105 MPH) if obstacles are not a problem. The landing gear should be retracted when a gear-down landing is no longer possible on the runway. The distances for this take-off procedure are given on a chart in the performance section of this manual.

Short Field Take-off (25-degree Flaps)

When the shortest possible ground roll and the greatest clearance distance over a 50-foot obstacle is desired, use a 25-degree flap setting (second notch). Set the stabilator trim indicator slightly nose up from the take-off range. Set the brakes and bring the engines to full power before release. Accelerate to 70 MPH and rotate firmly so that when passing through the 50-foot height the airspeed is approximately 80 MPH. Retract the gear when a gear down landing is no longer possible on the runway.

It should be noted that the airplane is momentarily below V_{mc} when using the above procedure. IN THE EVENT THAT AN ENGINE FAILURE SHOULD OCCUR WHILE THE AIRPLANE IS BELOW V_{mc} IT IS MANDATORY THAT THE THROTTLE ON THE OPERATING ENGINE BE RETARDED AND THE NOSE LOWERED IMMEDIATELY TO MAINTAIN CONTROL OF THE AIRPLANE. It should also be noted that when a 25-degree flap setting is used on the take-off roll, an effort to hold the airplane on the runway too long may result in a "wheelbarrowing" tendency. This should be avoided.

The distances required using this take-off procedure are given on a chart in the Performance section of this manual.

DOOR OPEN ON TAKE-OFF

If either the main or rear cabin door is inadvertently left open or partially open on take-off, fly the airplane in a normal manner and return for a landing to close the door on the ground. If a landing cannot be made, it may be possible to close a door in flight in the following manner:

1. Maintain airspeed between 100 and 110 MPH.
2. Open the storm window.
3. Pull the door closed, making certain the upper latch is properly positioned.
4. Close the upper latch. It may be necessary to pull in on the upper portion of the door while the latch is being closed.

It is necessary to have someone in the airplane in addition to the pilot to carry out this procedure. If the door, either main or rear, cannot be closed in flight it is possible to continue safely for an extended period. In this case, the airspeed should be kept below 125 MPH and above 100 MPH to prevent buffeting as a result of the open door.

CLIMB

On climb-out after take-off, the best angle of climb speed (90 MPH at sea level) should be maintained until obstacles are cleared. The best rate of climb speed (105 MPH at sea level) should be maintained with full power on the engines until approximately 500 feet AGL. The best rate of climb speed decreases slightly with increased density altitude and the best angle of climb speed increases slightly. There is no time limit on full power engine operation. However, since full power requires a high fuel consumption and is unnecessary in most flight situations, it is advisable to reduce to a climb power setting any time after 500 feet AGL. When reducing power, the throttles should be retarded first, then the propeller controls. An en route climb speed of 120 MPH provides good visibility, climb performance and engine cooling.

Cylinder head temperatures should be monitored during climb and should be kept below 475° at all times. Better climb performance is attained with cowl flaps closed; however, cowl flap position should be adjusted for proper engine cooling during climb. The electric fuel pumps may be turned off one at a time above 500 feet AGL, and fuel pressure should be monitored as each pump is turned off, to see that the pressure stays in the green.

NORMAL CRUISE

When leveling off at cruise altitude, the pilot may reduce to a cruise power setting in accordance with the Power Setting Table in this manual. The mixture should be leaned in accordance with the recommendations for the IO-360-C engine in the Lycoming Operator's Manual which is provided with the aircraft.

For maximum service life, cylinder head temperature should be maintained below 435°F. during high performance cruise operation and below 400°F. during economy cruise operation. If cylinder head temperatures become too high during flight, reduce them by enriching the mixture, by opening cowl flaps, by reducing power, or by use of any combination of these methods.

BEFORE STARTING ENGINES

1. Seats adjusted
2. Seat belts, shoulder harness - fastened
3. Parking brake - set
4. Circuit breakers - in
5. Radios - off
6. Cowl flaps - open
7. Alternate air - off
8. Alternators - on

STARTING ENGINES

1. Mixture controls - idle cut-off
2. Throttle controls - open 1/2 inch
3. Propeller controls - forward
4. Master switch - on
5. Ignition switch - on
6. Electric fuel pumps - on
7. Mixture controls - Move to rich position until a fuel flow is indicated and stabilized; then move to idle cut-off.
8. Propeller - clear
9. Starter - engage
10. Mixture control - Advance as engine starts.
11. Oil pressure - Check to see that the oil pressure comes up within 30 seconds, (except in very cold weather, when it may take somewhat longer). If the oil pressure does not show an indication, shut down the engine and have it checked.
12. Repeat steps 8 through 11 with the other engine.
13. Electric fuel pumps - off; check fuel pressure.

HOT START

1. Mixture controls - idle cut-off
2. Throttle controls - open 1/2 inch
3. Propeller controls - forward
4. Master switch - on
5. Ignition switches - on
6. Electric fuel pumps - off
7. Propeller - clear
8. Starter - engage
9. Mixture control - Advance as engine starts.
10. Repeat steps 7 through 9 with the other engine.
11. If an engine does not start with the above method, which omits the priming, use the normal starting procedure, which includes priming.

NOTE

To prevent starter damage, limit starter cranking to 30-second periods. If the engine does not start within that time, allow a cooling period of several minutes before engaging starter again. Do not engage the starter immediately after releasing it. This practice may damage the starter mechanism.

FLOODED START

1. Mixture control - idle cut-off
2. Throttle control - full forward
3. Propeller control - forward
4. Master switch - on
5. Ignition switches - on
6. Electric fuel pump - off
7. Propeller - clear
8. Starter - engage
9. When engine fires, retard throttle and advance mixture slowly.

STARTING ENGINES WITH AID OF EXTERNAL ELECTRIC POWER

An optional feature known as Piper External Power (PEP) allows the operator to use an external battery to crank the engine without having to gain access to the aircraft battery.

The procedure is as follows:

1. Turn aircraft MASTER SWITCH to OFF.
2. Connect RED lead to PEP kit jumper cable to POSITIVE (+) terminal of external 12 volt battery and BLACK lead to NEGATIVE (-) terminal.
3. Insert plug of jumper cable into socket located on aircraft fuselage.
4. Turn aircraft MASTER SWITCH to ON and proceed with NORMAL engine starting technique.
5. After engine has been started, turn MASTER SWITCH to OFF and remove jumper cable plug from aircraft.
6. Turn aircraft MASTER SWITCH to ON and check alternator ammeter for indication of output. DO NOT ATTEMPT FLIGHT IF THERE IS NO INDICATION OF ALTERNATOR OUTPUT.

Following level-off for cruise, the electric fuel pumps should be checked for being off. The cowl flaps should be closed or adjusted as necessary to maintain proper cylinder head temperatures, and the airplane should be trimmed to fly hands off.

The pilot should monitor weather conditions while flying and should be alert to conditions which might lead to induction system icing. Snow or freezing rain could result in icing of the air filter. Since alternate air is controlled manually by the pilot (not automatically), it should be turned on any time icing may occur. If the flight has been through rain in air that is above freezing and is then continued into an air mass which is below freezing, moisture which has collected in the air filter may subsequently freeze. Since the alternate air system of the Seneca supplies heated air, it is an excellent protection against induction icing if it is applied soon enough in an icing situation.

WARNING

Flight in icing conditions is prohibited unless aircraft is equipped with approved deicing equipment. If icing is encountered immediate action should be taken to fly out of icing conditions. Icing is hazardous due to greatly reduced performance, loss of forward visibility, possible longitudinal control difficulties due to increased control sensitivity, and impaired power plant and fuel system operation.

The ammeters for the electrical system should be monitored during flight, especially during night or instrument flight so that corrective measures can be taken in case of malfunction. The procedures for dealing with electrical failures are contained in the Airplane Flight Manual portion of this manual. The sooner a problem is recognized and corrective action taken, the greater is the chance of avoiding total electrical failure.

It is not recommended to take-off into IFR operation with a single alternator. During flight, electrical loads should be limited to 50 amperes for each alternator. Although the alternators are capable of 60 amperes output, limiting loads to 50 amperes will assure battery charging current.

Since the Seneca has one combined fuel tank per engine, it is advisable to feed the engines symmetrically during cruise so that approximately the same amount of fuel will be left in each side for the landing. A crossfeed is provided and can be used to even up the fuel should it be necessary.

During flight, keep account of time and fuel used in connection with power settings to determine how the fuel flow and fuel quantity gauging systems are operating. If the fuel flow indication is considerably higher than the fuel actually being consumed or an asymmetric flow gauge indication is observed, you may have a clogged fuel nozzle, which should be cleaned.

There are no mechanical uplocks in the landing gear system. In the event of a hydraulic system malfunction, the landing gear will free-fall to the gear down position. The true airspeed with gear down is approximately 75% of the gear retracted airspeed for any given power setting. Allowances for the reduction in airspeed and range should be made when planning extended flight between remote airfields or flight over water.

DESCENT

When power is reduced for descent, the mixtures should be enriched as altitude decreases. The propellers may be left at cruise setting; however if the propeller speed is reduced, it should be done after the throttles have been retarded.

APPROACH AND LANDING

Sometime during the approach for a landing, the throttle controls should be retarded to check the gear warning horn. Flying the airplane with the horn inoperative is not advisable. It can lead to a gear up landing as it is easy to forget the landing gear, especially when approaching for a single-engine landing, when other equipment is inoperative, or when attention is drawn to events outside the cabin.

Prior to entering the traffic pattern, the aircraft should be slowed to approximately 115 MPH, and this speed should be maintained on the downwind leg. The landing check should be performed on the downwind leg:

1. Seat backs - erect
2. Seat belts and shoulder harness - fastened
3. Fuel selectors - "ON"
4. Cowl flaps - set as required
5. Electric fuel pumps - on
6. Mixture controls - rich
7. Propellers - set to 2500 RPM
8. Landing gear - down (three green lights and nose wheel in mirror)
9. Flaps - set as required; 125 MPH maximum airspeed

The landing gear should be lowered at speeds below 150 MPH and the flaps at speeds as follows:

10 (first notch)	160 MPH maximum
25° (second notch)	140 MPH maximum
40° (third notch)	125 MPH maximum

Maintain a speed of 115 MPH on the downwind leg, 110 MPH on base leg, 110 MPH during the turn onto final approach, and 95 MPH on final approach. If the aircraft is lightly loaded, the final approach speed may be reduced to 90 MPH.

When the power is reduced on close final approach, the propeller controls may be advanced to the full forward position to provide maximum power in the event of a go-around.

The landing gear position should be checked on the downwind leg and again on final approach by checking the three green indicator lights on the instrument panel and looking at the external mirror to check that the nose gear is extended. Remember that when the navigation lights are on, the gear position lights are dimmed and are difficult to see in the daytime.

Flap position for landing will depend on runway length and surface wind. Full flaps will reduce stall speed during final approach and will permit contact with the runway at a slower speed. Good pattern management includes a smooth, gradual reduction of power on final approach, with the power fully off before the wheels touch the runway, to give the horn a chance to blow if the gear is not locked down. If electric trim is available, it can be used to assist a smooth back pressure during flare-out.

Maximum braking after touch-down is achieved by retracting the flaps, applying back pressure to the wheel and applying pressure on the brakes. However, unless extra braking is needed or unless a strong crosswind or gusty air condition exists, it is best to wait until turning off the runway to retract the flaps. This will avoid reaching for the gear handle instead of the flap handle by mistake and will permit full attention to be given to the landing and landing roll.

Normal Landing

Approach with full flaps (40 degrees) and partial power until shortly before touch-down. Hold the nose up as long as possible before and after contacting the ground with the main wheels.

Short Field Landing

Approach with full flaps at 87 MPH CAS. Immediately after touch-down, raise the flaps, apply back pressure to the wheel and apply brakes.

Crosswind or High-wind Landing

Approach with higher than normal speed and with zero to 25 degrees of flaps. Immediately after touch-down, raise the flaps. During a crosswind approach hold a crab angle into the wind until ready to flare out for the landing. Then lower the wing that is into the wind, to eliminate the crab angle without drifting, and use the rudder to keep the wheels aligned with the runway. Avoid prolonged side slips with a low fuel indication.

The maximum crosswind component for landing is 15 MPH.

POST LANDING

After leaving the runway:

1. Wing flaps - retract
2. Cowl flaps - fully open
3. Electric fuel pumps - off

SHUT DOWN

1. Radio and electrical equipment - off
2. Mixture controls - idle cut-off
3. Magneto switches - off
4. Master switch - off
5. Parking brake - on

AIRSPEED DATA

All airspeeds quoted in this manual are calibrated unless otherwise noted. Calibrated airspeed is indicated airspeed corrected for instrument and position errors. The following table gives the correlation between indicated airspeed and calibrated airspeed for the Seneca if zero instrument error is assumed. When below 90 MPH IAS, this calibration is valid only when level flight is maintained using power as required to prevent rapid altitude changes.

AIRSPEED CORRECTION TABLE

Flaps 0°										
IAS - MPH	70	80	90	100	120	140	160	180	200	218
CAS - MPH	72	82	92	102	122	142	161	181	200	217
Flaps 40°										
IAS - MPH	70	80	90	100	110	120	127			
CAS - MPH	70	80	89	99	109	118	125			

ROUGH AIR FLIGHT

In conditions of extreme turbulence, reduce power to slow the airplane to slightly below the design maneuvering speed, which varies from 133 MPH at light weight to 146 MPH at 4200 pounds gross weight. When flying in extreme turbulence or strong vertical currents and using the autopilot, the altitude-hold mode should not be used.

V_{mc} - MINIMUM SINGLE-ENGINE CONTROL SPEED

V_{mc} is the calibrated airspeed below which a twin-engine aircraft cannot be controlled in flight with one engine operating at take-off power at sea level density altitude and the other engine windmilling. V_{mc} for the Seneca has been determined to be 80 MPH. Under no circumstances should an attempt be made to fly at a speed below this V_{mc} with only one engine operating. As a safety precaution, when operating under single-engine flight conditions either in training or in emergency situations, maintain an indicated airspeed above 90 MPH.

The V_{mc} demonstration required for the FAA flight test for the multi-engine rating approaches an uncontrolled flight condition with power reduced on one engine. The demonstration should not be performed at an altitude of less than 3500 feet above the ground. Initiate recovery during the demonstration by immediately reducing power on the operating engine and promptly lowering the nose of the airplane.

More power is available on the operating engine at lower altitudes and hence there can be more asymmetric thrust. The V_{mc} is highest at low altitudes. Since V_{mc} decreases with altitude, at higher altitudes the airplane will approach a stall before reaching V_{mc}. The most critical situation occurs at the altitude where the stall speed and V_{mc} speed coincide. Care should be taken to avoid this flight condition because at this point loss of directional control occurs at the same time the airplane stalls and a spin could result.

99-14-01 THE NEW PIPER AIRCRAFT, INC.: Amendment
39-11209; Docket No. 98-CE-77-AD; Supersedes AD 98-04-27,
Amendment 39-10339.

Applicability: Models PA-23, PA-23-160, PA-23-235, PA-23-250,
PA-E23-250, PA-30, PA-39, PA-40, PA-31, PA-31-300, PA-31-325,
PA-31-350, PA-31P, PA-31T, PA-31T1, PA-31T2, PA-31P-350,
PA-34-200, PA-34-200T, PA-34-220T, PA-42, PA-42-720, and
PA-42-1000 airplanes, all serial numbers, certificated in any
category.

NOTE 1: This AD applies to each airplane identified in the
preceding applicability provision, regardless of whether it has
been modified, altered, or repaired in the area subject to the
requirements of this AD. For airplanes that have been modified,
altered, or repaired so that the performance of the requirements
of this AD is affected, the owner/operator must request approval
for an alternative method of compliance in accordance with
paragraph (d) of this AD. The request should include an assessment
of the effect of the modification, alteration, or repair on the
unsafe condition addressed by this AD; and, if the unsafe
condition has not been eliminated, the request should include
specific proposed actions to address it.

Compliance: Required as follows, unless already accomplished:

1. For all affected airplanes, except for Models PA-31P,
PA-31T, PA-31T1, PA-31T2, and PA-31P-350 airplanes:
Within 30 days after March 13, 1997 (the effective date of AD
98-04-27).
2. For all Models PA-31P, PA-31T, PA-31T1, PA-31T2, and
PA-31P-350 airplanes: Within the next 30 days after the
effective date of this AD.

To minimize the potential hazards associated with operating the
airplane in severe icing conditions by providing more clearly
defined procedures and limitations associated with such
conditions, accomplish the following:

(a) At the applicable compliance time presented in the
Compliance section of this AD, accomplish the requirements of
paragraphs (a)(1) and (a)(2) of this AD.

NOTE 2: Operators should initiate action to notify and ensure that
flight crewmembers are apprised of this change.

(1) Revise the FAA-approved Airplane Flight Manual
(AFM) by incorporating the following into the
Limitations Section of the AFM. This may be
accomplished by inserting a copy of this AD in the
AFM.

"WARNING

Severe icing may result from environmental conditions outside of those for which the airplane is certificated. Flight in freezing rain, freezing drizzle, or mixed icing conditions (supercooled liquid water and ice crystals) may result in ice build-up on protected surfaces exceeding the capability of the ice protection system, or may result in ice forming aft of the protected surfaces. This ice may not be shed using the ice protection systems, and may seriously degrade the performance and controllability of the airplane.

- During flight, severe icing conditions that exceed those for which the airplane is certificated shall be determined by the following visual cues. If one or more of these visual cues exists, immediately request priority handling from Air Traffic Control to facilitate a route or an altitude change to exit the icing conditions.
- Unusually extensive ice accumulation on the airframe and windshield in areas not normally observed to collect ice.
- Accumulation of ice on the upper surface of the wing, aft of the protected area.
- Accumulation of ice on the engine nacelles and propeller spinners farther aft than normally observed.
- Since the autopilot, when installed and operating, may mask tactile cues that indicate adverse changes in handling characteristics, use of the autopilot is prohibited when any of the visual cues specified above exist, or when unusual lateral trim requirements or autopilot trim warnings are encountered while the airplane is in icing conditions.
- All wing icing inspection lights must be operative prior to flight into known or forecast icing conditions at night.
[NOTE: This supersedes any relief provided by the Master Minimum Equipment List (M MEL).]"

(2) Revise the FAA-approved AFM by incorporating the following into the Normal Procedures Section of the AFM. This may be accomplished by inserting a copy of this AD in the AFM.

"THE FOLLOWING WEATHER CONDITIONS MAY BE CONDUCIVE TO SEVERE IN-FLIGHT ICING:

- Visible rain at temperatures below 0 degrees Celsius ambient air temperature.
- Droplets that splash or splatter on impact at temperatures below 0 degrees Celsius ambient air temperature.

PROCEDURES FOR EXITING THE SEVERE ICING ENVIRONMENT:

These procedures are applicable to all flight phases from takeoff to landing. Monitor the ambient air temperature. While severe icing may form at temperatures as cold as -18 degrees Celsius, increased vigilance is warranted at temperatures around freezing with visible moisture present. If the visual cues specified in the Limitations Section of the AFM for identifying severe icing conditions are observed, accomplish the following:

- Immediately request priority handling from Air Traffic Control to facilitate a route or an altitude change to exit the severe icing conditions in order to avoid extended exposure to flight conditions more severe than those for which the airplane has been certificated.
- Avoid abrupt and excessive maneuvering that may exacerbate control difficulties.
- Do not engage the autopilot.
- If the autopilot is engaged, hold the control wheel firmly and disengage the autopilot.
- If an unusual roll response or uncommanded roll control movement is observed, reduce the angle-of-attack.
- Do not extend flaps when holding in icing conditions. Operation with flaps extended can result in a reduced wing angle-of-attack, with the possibility of ice forming on the upper surface further aft on the wing than normal, possibly aft of the protected area.
- If the flaps are extended, do not retract them until the airframe is clear of ice.
- Report these weather conditions to Air Traffic Control."

(b) Incorporating the AFM revisions, as required by this AD, may be performed by the owner/operator holding at least a private pilot certificate as authorized by section 43.7 of the Federal Aviation Regulations (14 CFR 43.7), and must be entered into the aircraft records showing compliance with this AD in accordance with section 43.9 of the Federal Aviation Regulations (14 CFR 43.9).

(c) Special flight permits may be issued in accordance with sections 21.197 and 21.199 of the Federal Aviation Regulations

(14 CFR 21.197 and 21.199) to operate the airplane to a location where the requirements of this AD can be accomplished.

(d) An alternative method of compliance or adjustment of the compliance time that provides an equivalent level of safety may be approved by the Manager, Small Airplane Directorate, FAA, 1201 Walnut, suite 900, Kansas City, Missouri 64106. The request shall be forwarded through an appropriate FAA Maintenance Inspector, who may add comments and then send it to the Manager, Small Airplane Directorate.

NOTE 3: Information concerning the existence of approved alternative methods of compliance with this AD, if any, may be obtained from the Small Airplane Directorate.

(e) All persons affected by this directive may examine information related to this AD at the FAA, Central Region, Office of the Regional Counsel, Room 1558, 601 E. 12th Street, Kansas City, Missouri 64106.

(f) This amendment supersedes AD 98-04-27, Amendment 39-10339.

(g) This amendment becomes effective on August 17, 1999.

FOR FURTHER INFORMATION CONTACT:

Mr. John P. Dow, Sr., Aerospace Engineer, FAA, Small Airplane Directorate, 1201 Walnut, suite 900, Kansas City, Missouri 64106; telephone: (816) 426-6932; facsimile: (816) 426-2169.

- All wing icing inspection lights must be operative prior to flight into known or forecast icing conditions at night. [NOTE: This supersedes any relief provided by the Master Minimum Equipment List (MMEL).]

(2) Revise the FAA-approved AFM by incorporating the following into the Normal Procedures Section of the AFM. This may be accomplished by inserting a copy of this AD in the AFM.

**“THE FOLLOWING WEATHER CONDITIONS
MAY BE CONDUCTIVE TO SEVERE
IN-FLIGHT ICING:**

- Visible rain at temperatures below 0 degrees Celsius ambient air temperature.
- Droplets that splash or splatter on impact at temperatures below 0 degrees Celsius ambient air temperature.

**PROCEDURES FOR EXITING
THE SEVERE ICING ENVIRONMENT:**

These procedures are applicable to all flight phases from takeoff to landing. Monitor the ambient air temperature. While severe icing may form at temperatures as cold as -18 degrees Celsius, increased vigilance is warranted at temperatures around freezing with visible moisture present. If the visual cues specified in the Limitations Section of the AFM for identifying severe icing conditions are observed, accomplish the following:

- Immediately request priority handling from Air Traffic Control to facilitate a route or an altitude change to exit the severe icing conditions in order to avoid extended exposure to flight conditions more severe than those for which the airplane has been certificated.
- Avoid abrupt and excessive maneuvering that may exacerbate control difficulties.
- Do not engage the autopilot.
- If the autopilot is engaged, hold the control wheel firmly and disengage the autopilot.
- If an unusual roll response or uncommanded roll control movement is observed, reduce the angle-of-attack.
- Do not extend flaps when holding in icing conditions. Operation with flaps extended can result in a reduced wing angle-of-attack, with the possibility of ice forming on the upper surface further aft on the wing than normal, possibly aft of the protected area.
- If the flaps are extended, do not retract them until the airframe is clear of ice.
- Report these weather conditions to Air Traffic Control.”

(b) Incorporating the AFM revisions, as required by this AD, may be performed by the owner/operator holding at least a private pilot certificate as authorized by section 43.7 of the Federal Aviation Regulations (14 CFR 43.7), and must be entered into the aircraft records showing compliance with this AD in accordance with section 43.9 of the Federal Aviation Regulations (14 CFR 43.9).

(c) Special flight permits may be issued in accordance with sections 21.197 and 21.199 of the Federal Aviation Regulations (14 CFR 21.197 and 21.199) to operate the airplane to a location where the requirements of this AD can be accomplished.

(d) An alternative method of compliance or adjustment of the compliance time that provides an equivalent level of safety may be approved by the Manager, Small Airplane Directorate, FAA, 1201 Walnut, suite 900, Kansas City, Missouri 64106. The request shall be forwarded through an appropriate FAA Maintenance Inspector, who may add comments and then send it to the Manager, Small Airplane Directorate.

NOTE 3: Information concerning the existence of approved alternative methods of compliance with this AD, if any, may be obtained from the Small Airplane Directorate.

(e) All persons affected by this directive may examine information related to this AD at the FAA, Central Region, Office of the Regional Counsel, Room 1558, 601 E. 12th Street, Kansas City, Missouri 64106.

(f) This amendment supersedes AD 98-04-27, Amendment 39-10339.

(g) This amendment becomes effective on August 17, 1999.

FOR FURTHER INFORMATION CONTACT:

Mr. John P. Dow, Sr., Aerospace Engineer, FAA, Small Airplane Directorate, 1201 Walnut, suite 900, Kansas City, Missouri 64106; telephone: (816) 426-6932; facsimile: (816) 426-2169.

AD's are posted on the internet at <http://av-info.faa.gov>

NOTE

SINGLE ENGINE STALLS ARE NOT RECOMMENDED.

OPERATION IN KNOWN ICING CONDITIONS

The Piper Seneca is approved for flight into known icing conditions when equipped with the complete Piper Ice Protection System. Operating in icing conditions in excess of the Continuous Maximum and Intermittent Maximum as defined in FAR 25 Appendix C has been substantiated; however, there is no correlation between these conditions and forecast or reported "Light, Moderate and Severe" conditions. Therefore, on the basis of flight tests the following guidelines should be observed:

1. Flight into Severe icing is prohibited.
2. Moderate icing conditions above 10,000 ft. should be avoided whenever possible; if moderate icing conditions are encountered above 10,000 ft. a descent to a lower altitude should be initiated if practical.
3. Light icing is approved at all altitudes.

Icing conditions of any kind should be avoided wherever possible, since any minor malfunction which may occur is potentially more serious in icing conditions. Continuous attention of the pilot is required to monitor the rate of ice buildup in order to effect the boot cycle at the optimum time. Boots should be cycled when ice has built to between 1/4 and 1/2 inch thickness on the leading edge to assure proper ice removal. Repeated boot cycles at less than 1/4 inch can cause a cavity to form under the ice and prevent ice removal; boot cycles at thicknesses greater than 1/2 inch may also fail to remove ice.

Icing conditions can exist in any clouds when the temperature is below freezing; therefore it is necessary to closely monitor outside air temperature when flying in clouds or precipitation. Clouds which are dark and have sharply defined edges contain high water content and should be avoided whenever possible. Freezing rain must always be avoided.

The following listing contains a few of the more highly recommended operating procedures for flight in icing conditions.

1. Perform careful functional check of ice protection systems before flight. Turn on Pitot Heat, Windshield Heat and Propeller Heat for 30 seconds and feel for heat.
2. Avoid forecast icing conditions when possible.
3. When flying in clouds or precipitation monitor temperature closely.
4. Turn on windshield defroster and pitot heat before entering icing conditions.
5. Turn on Propeller Heat and Windshield Heat immediately upon entering icing conditions. Cycle boots as required.
6. Review Flight Manual procedures before any flight which might encounter icing conditions.
7. Plan an alternate airport whenever flying in ice.

EMERGENCY PROCEDURES

Procedures for handling in-flight emergencies and equipment malfunctions are detailed in the Airplane Flight Manual section. These should be read and followed by the pilot.

PIPER AUTOMATIC LOCATOR*

The Piper Automatic Locator, when installed, is located in the aft portion of the fuselage just below the stabilator leading edge and is accessible through a plate on the right side of the fuselage. It is an emergency locator transmitter which meets the requirements of FAR 91.52. The unit operates on a self contained battery.

The battery has a useful life of four years. However, it complies with FAA regulations, it must be replaced after two years of shelf life or service life. The battery should also be replaced if the transmitter has been used in an emergency situation or if the accumulated test time exceeds one hour. The replacement date is marked on the transmitter label.

The unit has a three position selector switch placarded OFF, ARM and ON. The ARM position is provided to set the unit to the automatic position so that it will transmit only after impact and continue to transmit until the battery power is drained to depletion or the switch is manually moved to the OFF position. The ARM position is selected when the locator is installed at the factory and should remain in that position whenever the unit is installed in the aircraft. The ON position is provided so the unit can be used as a portable transmitter or in the event the automatic feature was not triggered by impact or to check the function of the transmitter periodically.

The OFF position is provided for the purpose of changing the battery or to prolong the service life of the battery if used as a portable transmitter or rearming the unit if it should be activated for any reason.

NOTE

If the switch has been placed in the ON position for any reason, the OFF position has to be selected before selecting ARM. If ARM is selected directly from the ON position the transmitter will continue to transmit in the ARM position.

Attached to the unit is a portable antenna, provided so that the locator may be removed from the aircraft, in case of an emergency, and used as a portable signal transmitter.

The locator should be checked during the Ground Check to make certain the unit has not been accidentally activated. Check by tuning a radio receiver to 121.5 MHz. If you hear an oscillating audio sound the locator may have been activated and should be turned off immediately. Reset to ARM position and check again to insure against outside interference.

*Optional equipment

OPERATING TIPS

OPERATING TIPS

Operating Tips 7-1

BLANK PAGE

OPERATING TIPS

The following Operating Tips are of particular value in the operation of the Seneca.

1. Learn to trim for take-off so that only a very light back pressure on the wheel is required to lift the airplane off the ground.
2. On take-off, do not retract the gear prematurely. The airplane may settle and make contact with the ground because of lack of flying speed, atmospheric conditions, or rolling terrain.
3. In high density areas where high traffic pattern speeds are necessary or when it is advantageous to extend the gear, it is permissible to extend the landing gear at speeds up to 150 MPH.
4. Flaps may be lowered at airspeeds up to 125 MPH. To reduce flap operating loads, it is desirable to have the airplane at a slower speed before extending the flaps.
5. Before attempting to reset any circuit breaker, allow a two to five minute cooling off period.
6. Always determine position of landing gear by checking the gear position lights.
7. Before starting the engine, check that all radio switches, light switches, and the pitot heat switch are in the off position so as not to create an overloaded condition when the starter is engaged.
8. A high fuel pressure indication on the fuel flow indicator is a possible sign of restricted fuel nozzles.
9. The vacuum gauge is provided to monitor the pressure available to assure the correct operating speed of the vacuum-driven gyroscopic flight instruments. It also monitors the condition of the common air filter by measuring the flow of air through the filter.
If the vacuum gauge does not register $5'' \pm .10''$ Hg at 2000 RPM, the following items should be checked before flight:
 - a. Common air filters, could be dirty or restricted.
 - b. Vacuum lines, could be collapsed or broken.
 - c. Vacuum pumps, worn.
 - d. Vacuum regulators, not adjusted correctly. The pressure, even though set correctly, can read lower under two conditions:
 - (1) Very high altitude, above 12,000 feet.
 - (2) Low engine RPM usually on approach or during training maneuvers.
This is normal and should not be considered a malfunction.
10. The shape of the wing fuel tanks is such that in certain maneuvers the fuel may move away from the tank outlet. If the outlet is uncovered, the fuel flow will be interrupted and a temporary loss of power may result. Pilots can prevent inadvertent uncovering of the outlet by avoiding maneuvers which could result in uncovering the outlet.
Extreme running turning takeoffs should be avoided as fuel flow interruption may occur.
Prolonged slips or skids which result in excess of 2000 feet of altitude loss, or other radical or extreme maneuvers which could cause uncovering of the fuel outlet must be avoided as fuel flow interruption may occur when tank being used is not full.
11. The rudder pedals are suspended from a torque tube which extends across the fuselage. The pilot should become familiar with the proper positioning of his feet on the rudder pedals so as to avoid interference with the torque tube when moving the rudder pedals or operating the toe brakes.
12. Anti-collision lights should not be operating when flying through overcast and clouds, since reflected light can produce spacial disorientation. Do not operate strobe lights when taxiing in the vicinity of other aircraft.

13. In an effort to avoid accidents, pilots should obtain and study the safety related information made available in FAA publications such as regulations, advisory circulars, Aviation News, AIM and safety aids.
14. Sluggish RPM control and propeller overspeed with poor RPM recovery after rapid throttle application are indications that nitrogen pressure in the propeller dome is low.
15. Experience has shown that the training advantage gained by pulling a mixture control or turning off the fuel to simulate engine failure at low altitude is not worth the risk assumed. Therefore, it is recommended that instead of using either of these procedures to simulate loss of power at low altitude, the throttle be retarded slowly to idle position. Fast reduction of power may be harmful to the engine.

PERFORMANCE CHARTS

PERFORMANCE CHARTS

Altitude Conversion Chart.....	8-1
Take-off Ground Run Distance (Flap Setting 0°).....	8-2
Take-off Ground Run Distance (Flap Setting 25°).....	8-3
Take-off Distance Over 50 Ft (Flap Setting 25°).....	8-4
Take-off Distance Over 50 Ft (Flap Setting 0°).....	8-5
Accelerate-Stop Distance	8-6
Multi-Engine Climb Performance	8-7
Single Engine Climb Performance	8-8
Cruise Performance - True Airspeed	8-9
Cruise Performance - Range.....	8-10
Stalling Speed vs Weight	8-11
Stalling Speed vs Angle of Bank.....	8-12
Landing Ground Run Distance	8-13
Landing Distance Over 50 Ft.....	8-14
Power Setting Table.....	8-16

WARNING

Performance information derived by extrapolation beyond the limits shown on the charts should not be used for flight planning purposes.

BLANK PAGE

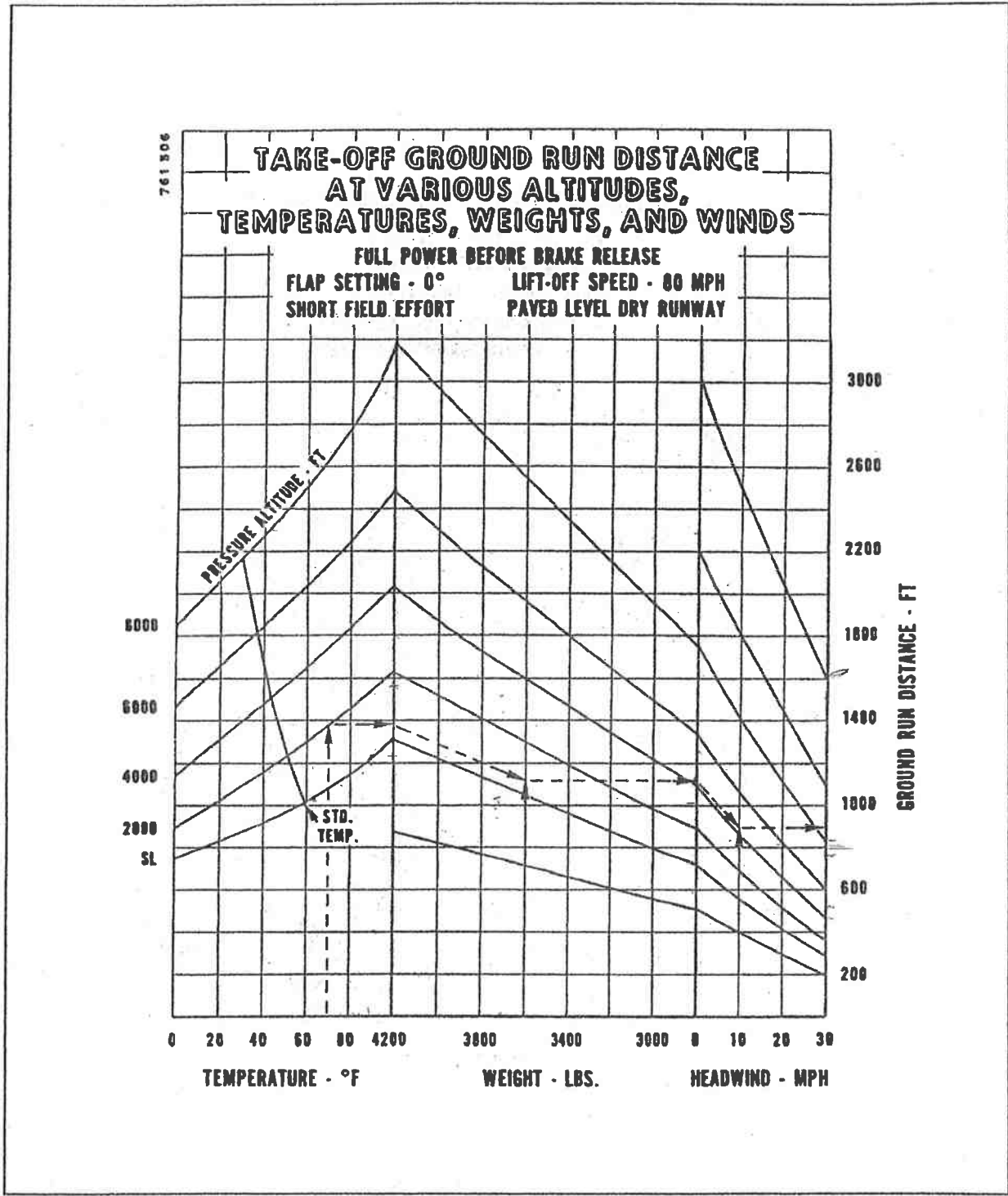

Example: Temp. 70° F
Press. Alt. 2000 Ft.

Wt. 3600 lbs.
Hd. wind 10 MPH

Ground run 900 ft

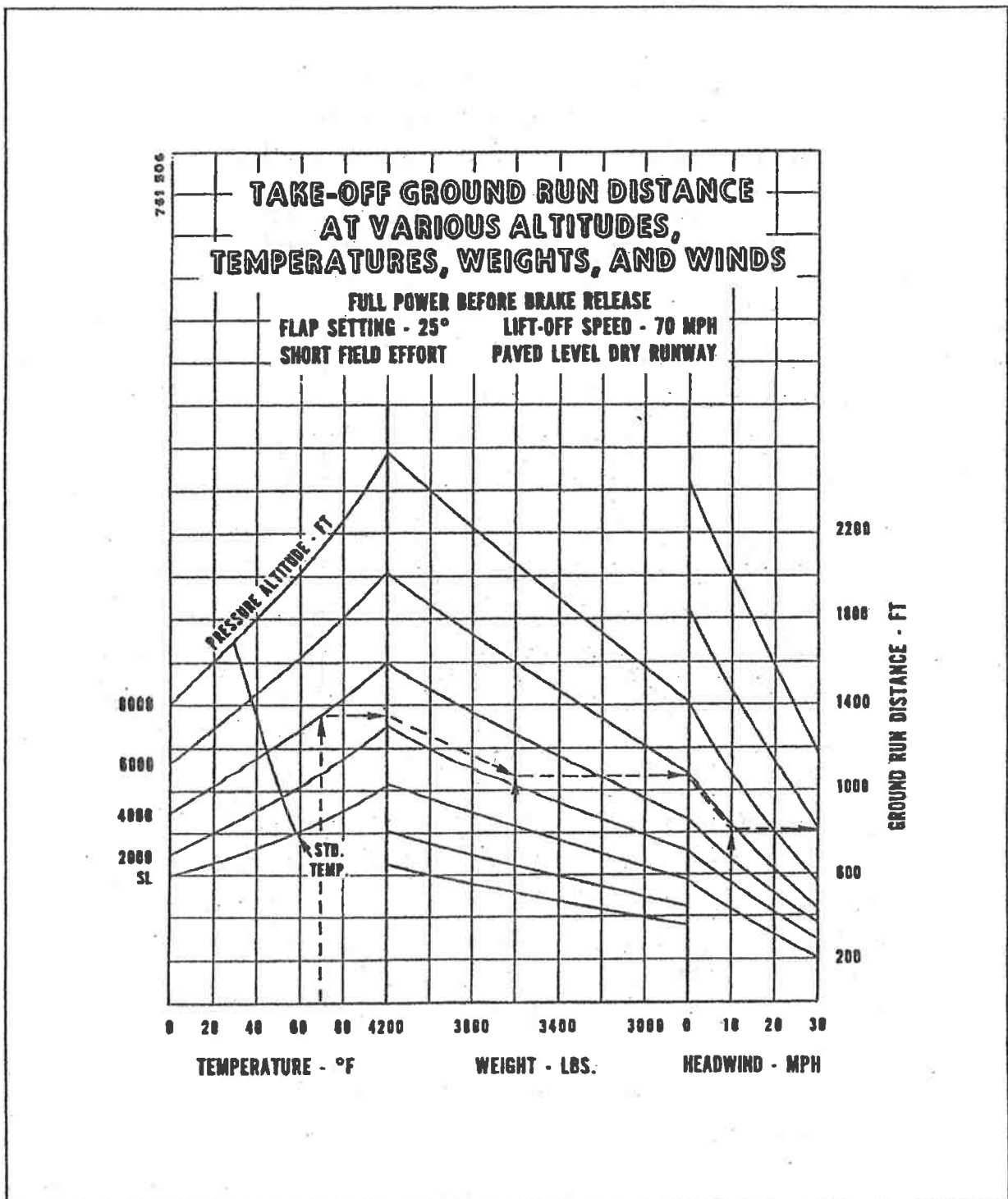

Example: Temp. 70° F Wt. 3600 lbs Ground Run 810 ft
 Press. Alt. 4000 ft Hd. wind 10 MPH

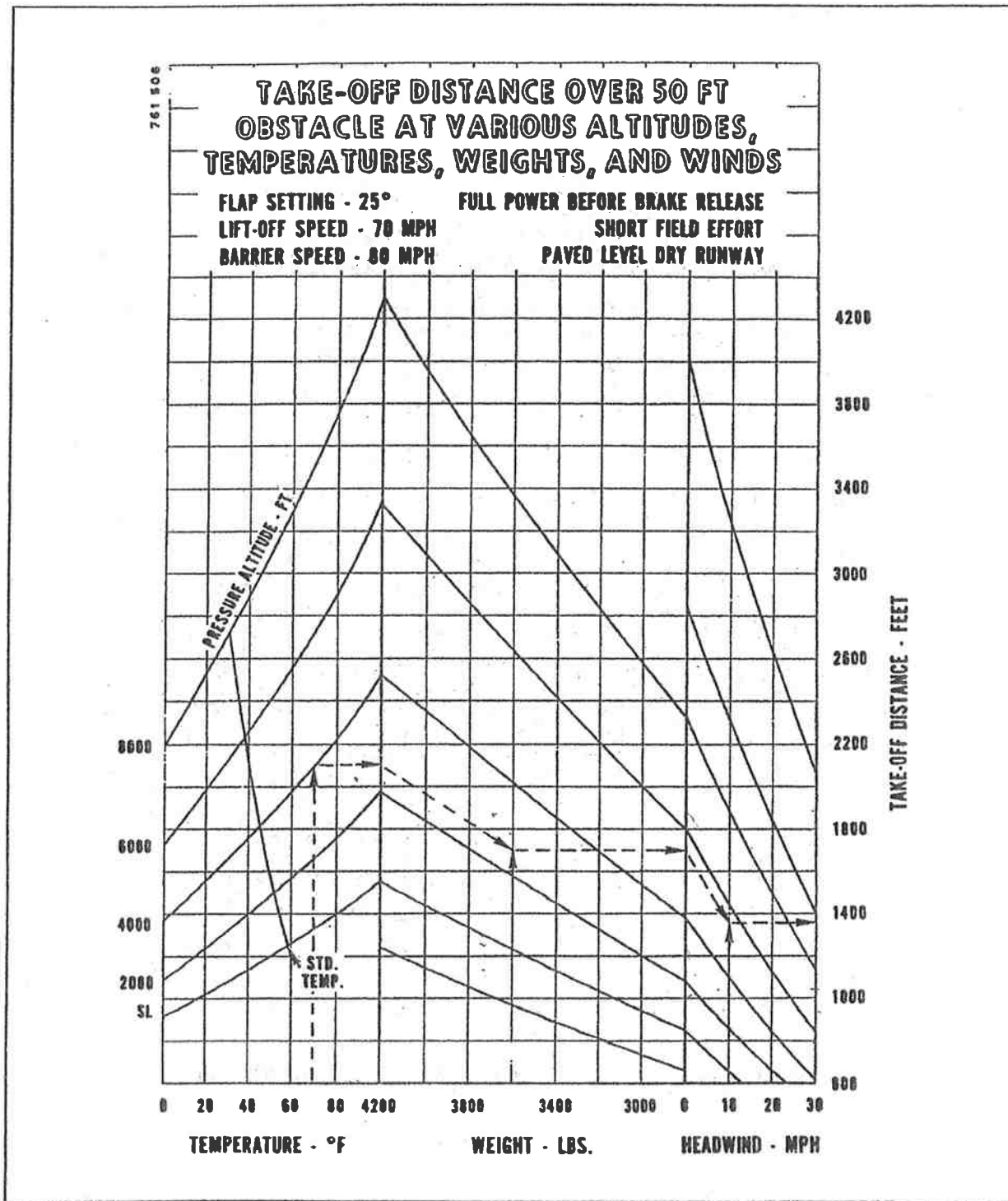

Example: Temp. 70° F Wt. 3600 lbs T. O. Dist. 1350 ft
 Press. Alt. 4000 ft Hd. wind 10 MPH

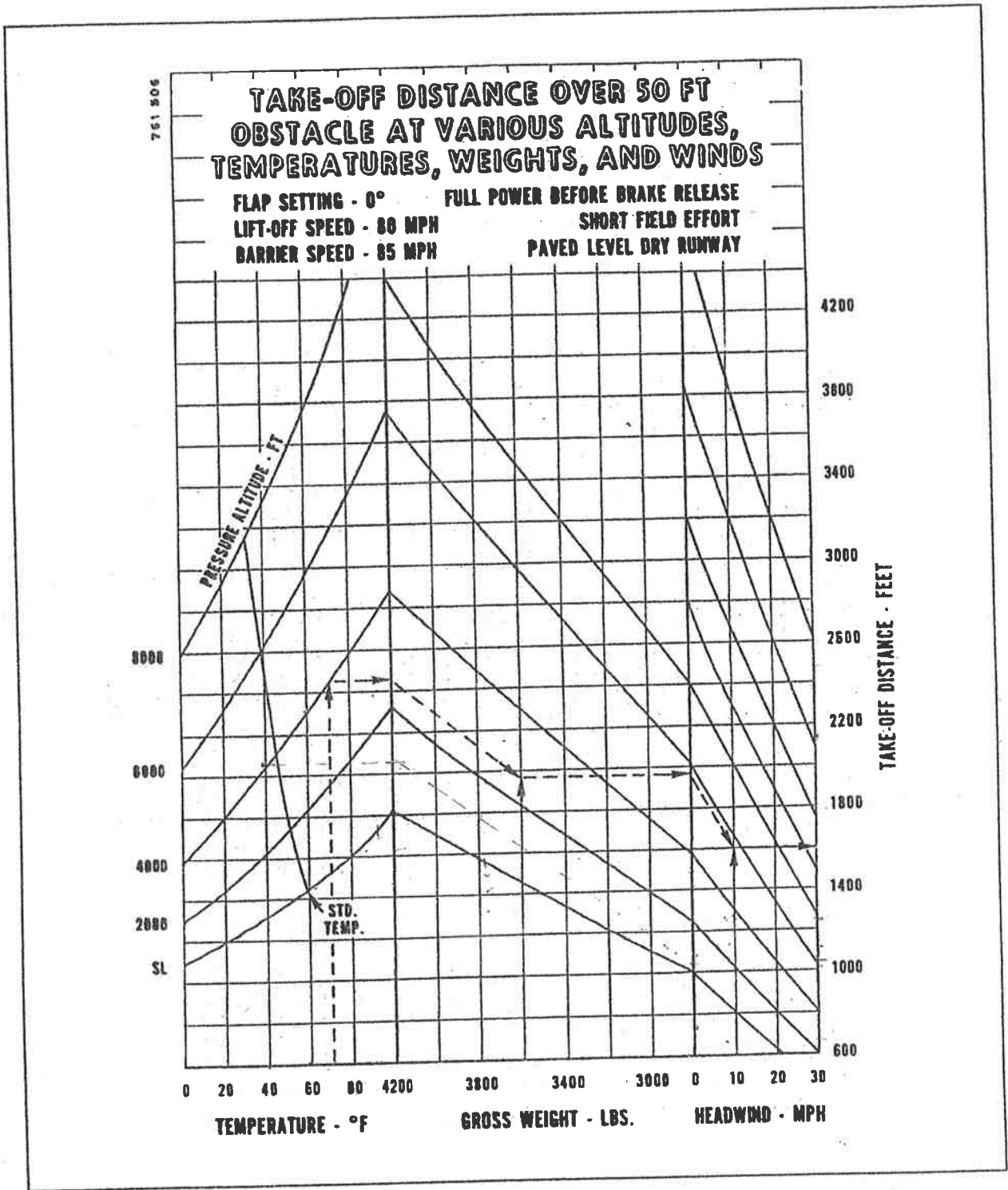

Example: Temp. 70° F Wt. 3600 lbs T. O. Dist. 1600 ft
 Press. Alt. 4000 ft Hd. wind 10 MPH

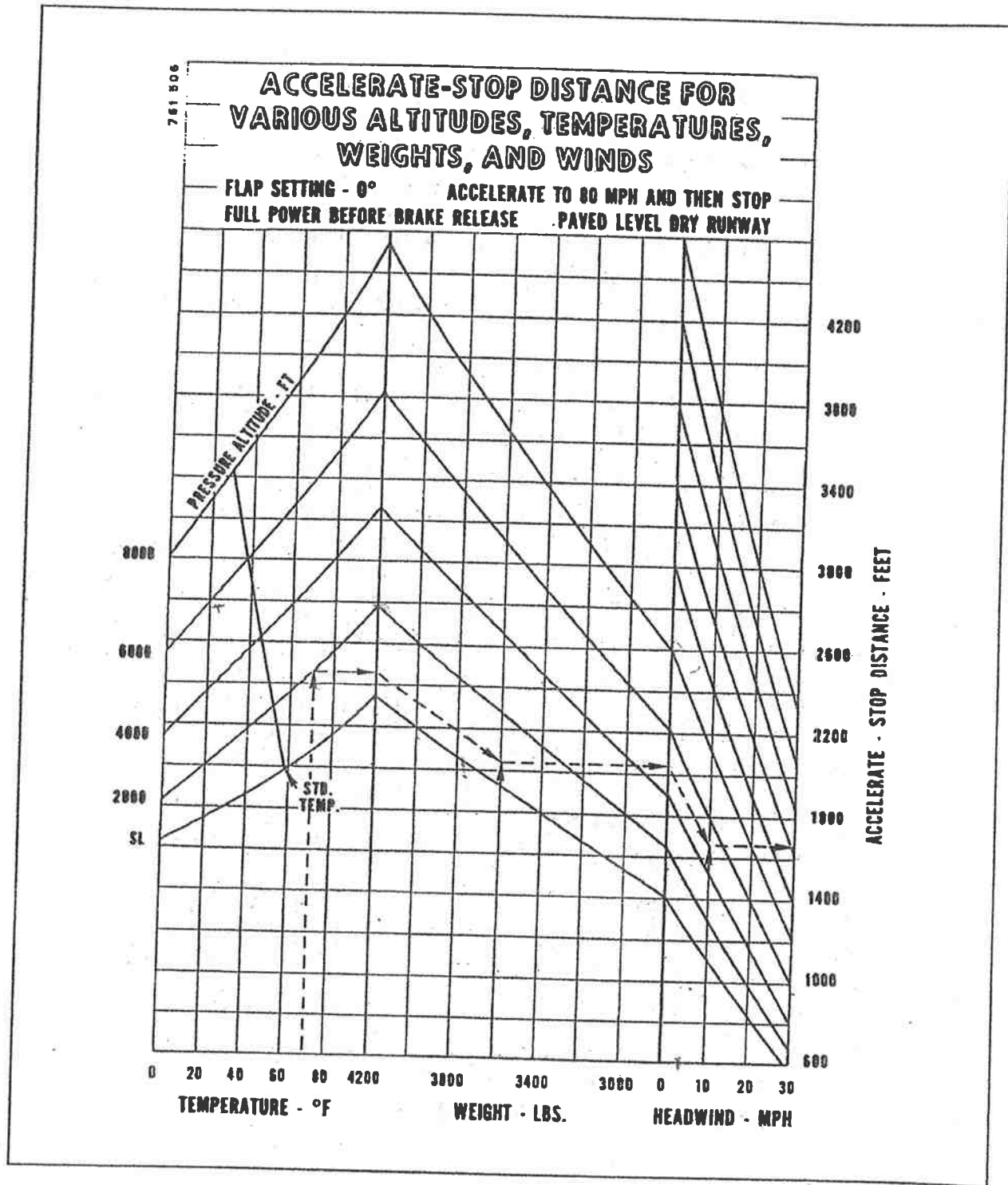

Example: Temp. 70°F Wt. 3600 lbs Accel.- Stop Dist. 1650 ft
 Press. Alt. 2000 ft Hd. wind 10 MPH

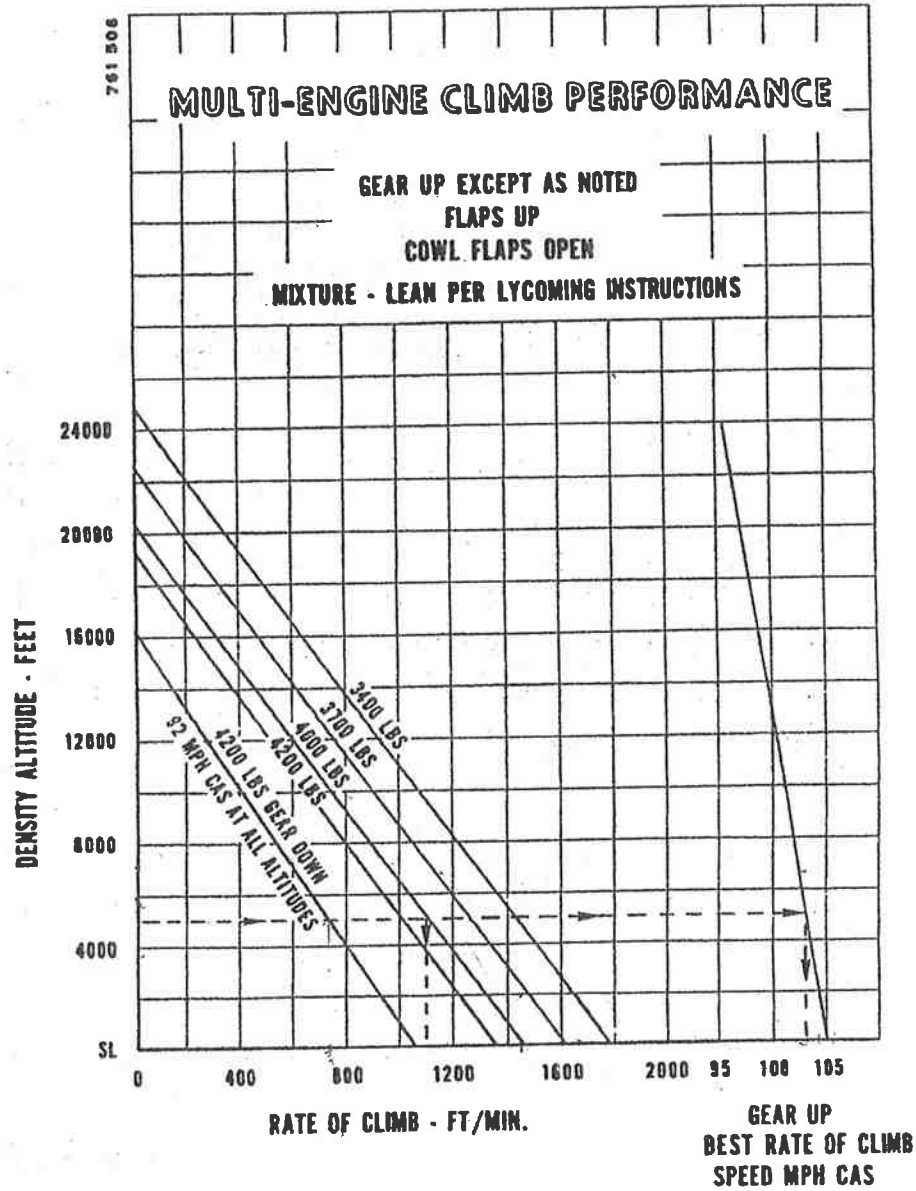

*Gear down best rate of climb speed is 92 MPH CAS at all altitudes.

Example: Wt. 4000 lbs
 Den. Alt. 5000 ft
 (Gear Up)

Rate of Climb 1100 ft/min
 Best R/C Speed 103 MPH

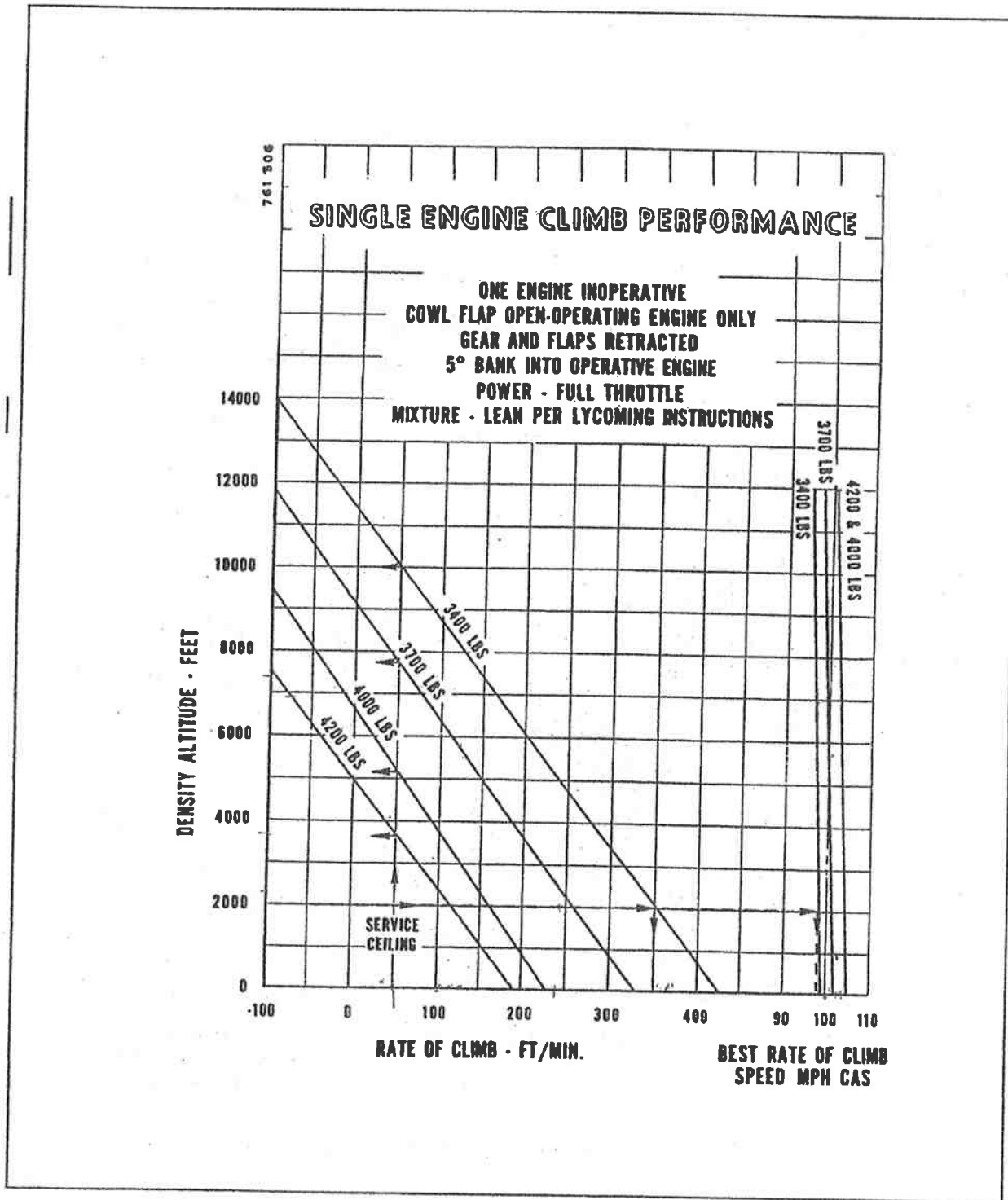

Example: Wt. 3400 lbs
 Den. Alt. 2000 ft

Rate of Climb 350 ft/min
 Best R/C Speed 98 MPH

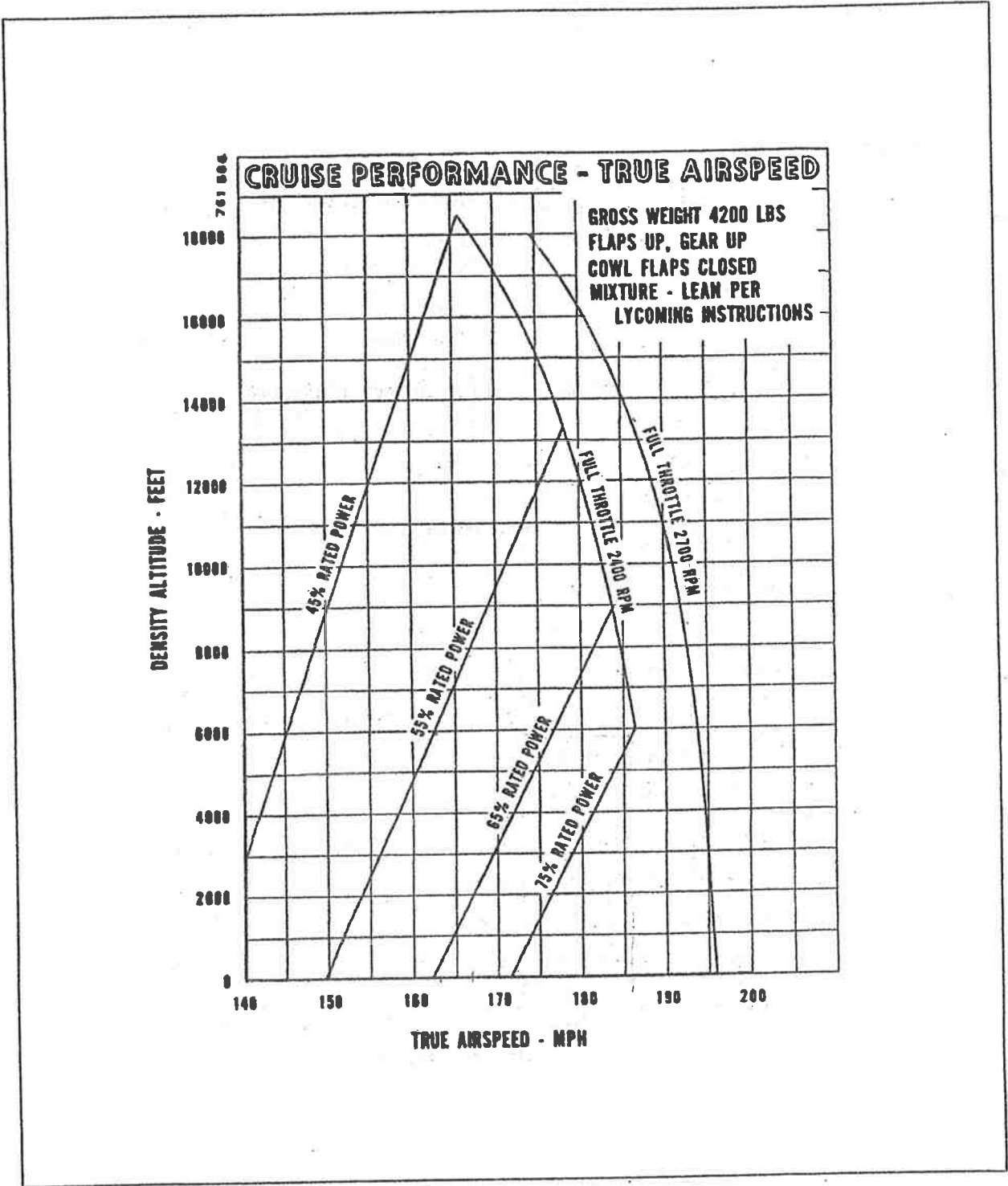

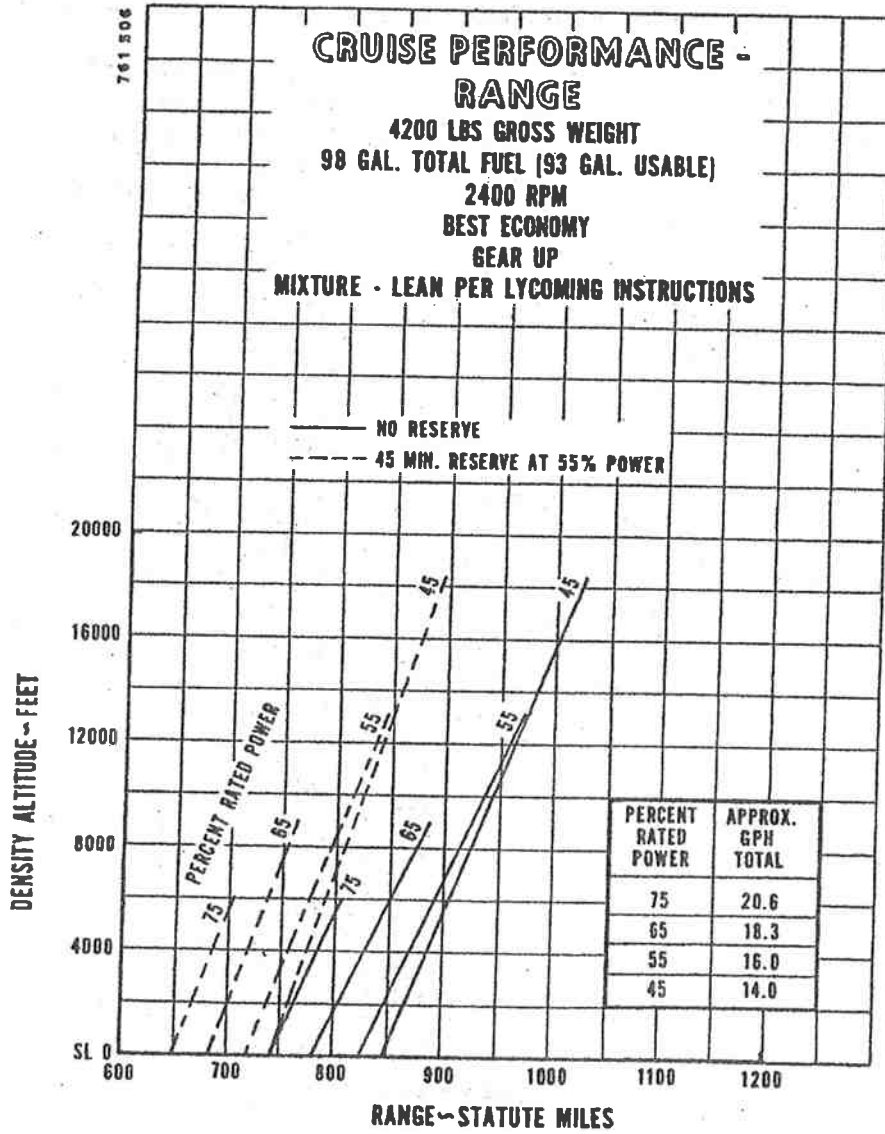

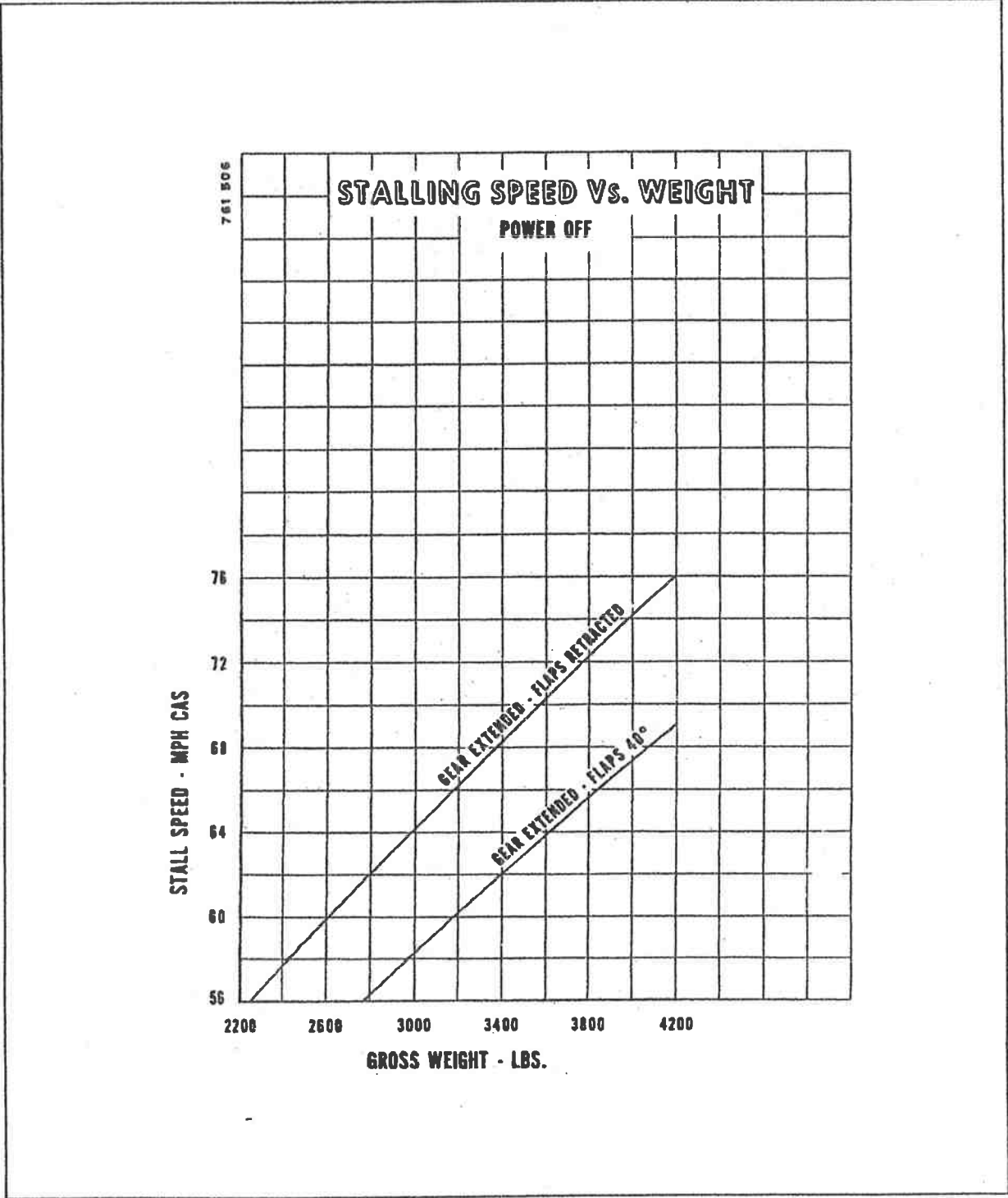

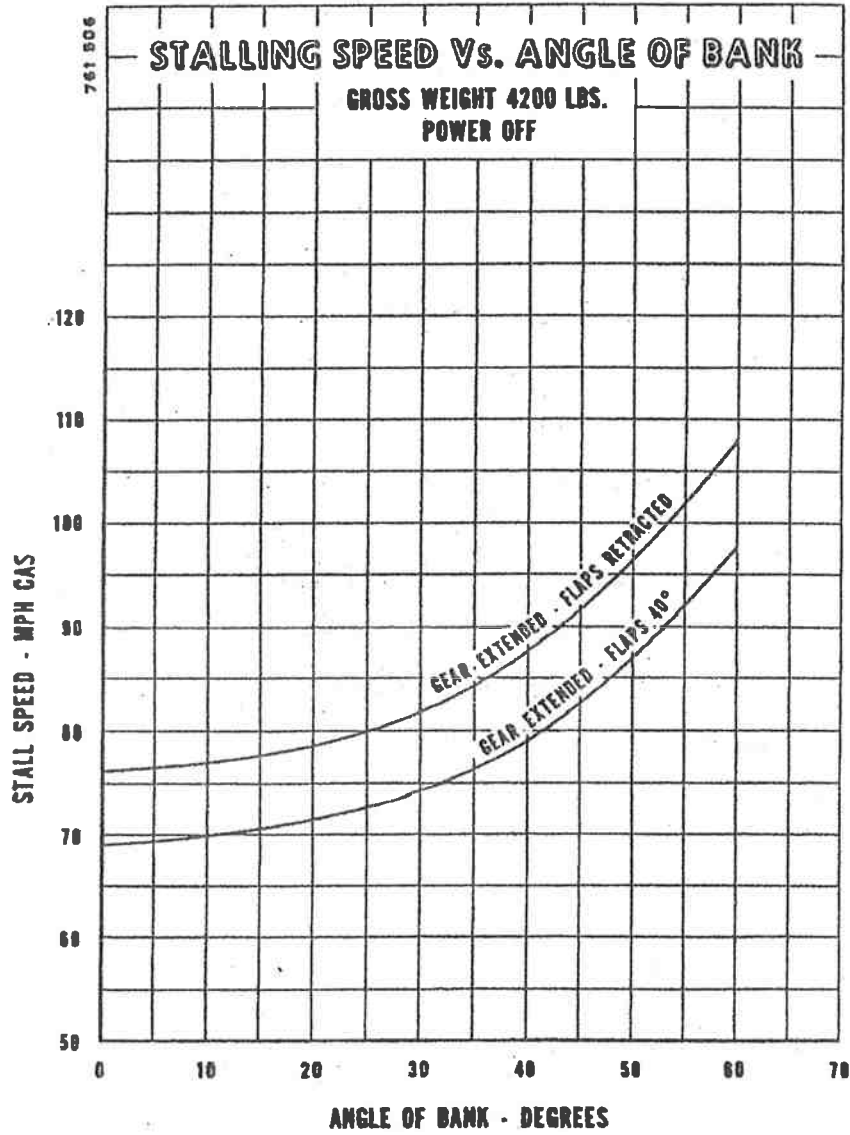

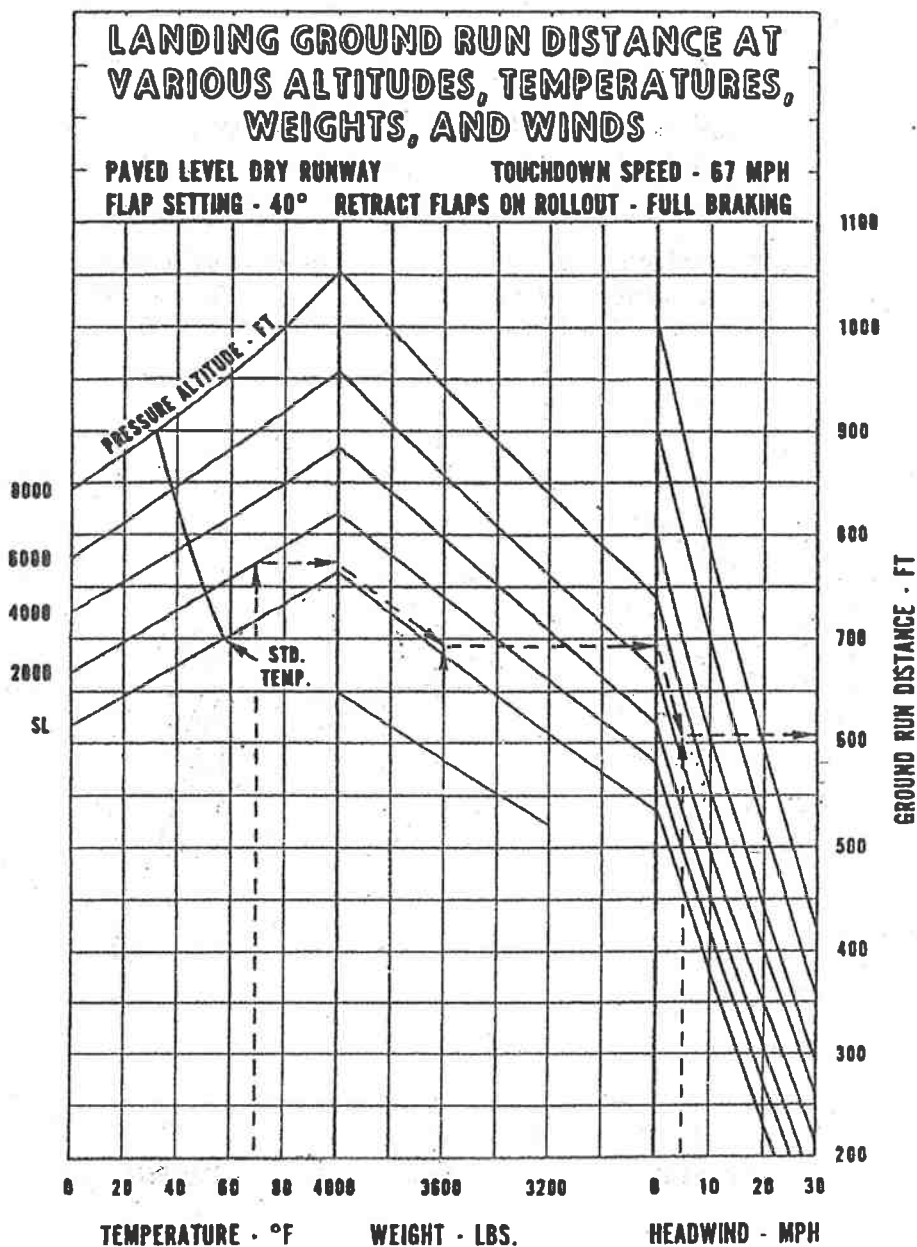

NOTE: The above distances may be reduced by approximately 25% when the aircraft is equipped with optional Heavy Duty Wheels, Brakes and Tires. (Reference Aircraft Equipment List in Weight and Balance Section of this Manual.)

Example: Temp. 70° F Wt. 3600 lbs Ground Run 615 ft
 Press. Alt. 2000 ft Hd. wind 5 MPH

LANDING DISTANCE OVER 50 FT OBSTACLE AT VARIOUS ALTITUDES, TEMPERATURES, WEIGHTS, AND WINDS

TOUCH-DOWN SPEED - 67 MPH PAVED LEVEL DRY RUNWAY
 POWER OFF APPROACH SPEED - 87 MPH FLAP SETTING - 40°
 RETRACT FLAPS ON ROLLOUT - FULL BRAKING SHORT FIELD EFFORT

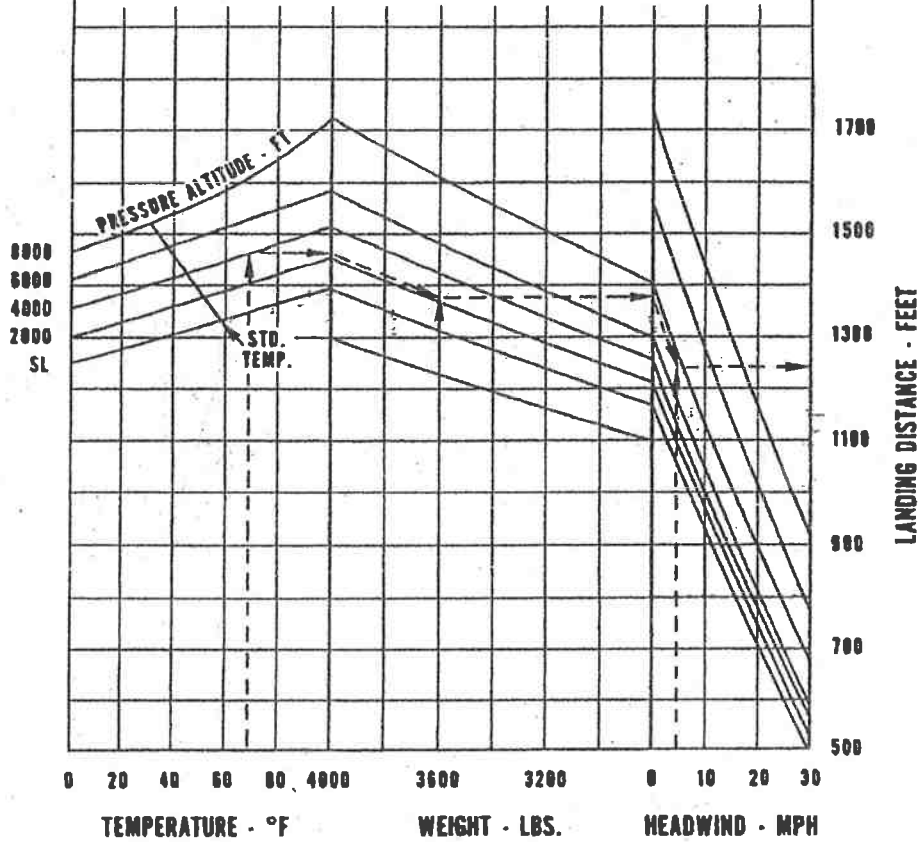

NOTE: The above distances may be reduced by approximately 12% when the aircraft is equipped with optional Heavy Duty Wheels, Brakes and Tires. (Reference Aircraft Equipment List in Weight and Balance Section of this Manual.)

Example: Temp. 70° F Wt. 3600 lbs. Landing Dist. 1240 ft
 Press. Alt. 4000 ft Hd. wind 5 MPH

THIS PAGE INTENTIONALLY LEFT BLANK

Power Setting Table - Lycoming Model IO-360-C Series, 200 HP Engine

Press. Alt Feet	Std. Alt Temp ° F	110 HP - 55% Rated RPM AND MAN. PRESS.		130 HP - 65% Rated RPM AND MAN. PRESS.		150 HP - 75% Rated RPM AND MAN. PRESS.	Press. Alt Feet
		2100	2400	2100	2400	2400	
SL	59	22.9	20.4	25.9	22.9	25.5	SL
1,000	55	22.7	20.2	25.6	22.7	25.2	1,000
2,000	52	22.4	20.0	25.4	22.5	25.0	2,000
3,000	48	22.2	19.8	25.1	22.2	24.7	3,000
4,000	45	21.9	19.5	24.8	22.0	24.4	4,000
5,000	41	21.7	19.3	FT	21.7	FT	5,000
6,000	38	21.4	19.1	—	21.5	—	6,000
7,000	34	21.2	18.9	—	21.3	—	7,000
8,000	31	21.0	18.7	—	21.0	—	8,000
9,000	27	FT	18.5	—	FT	—	9,000
10,000	23	—	18.3	—	—	—	10,000
11,000	19	—	18.1	—	—	—	11,000
12,000	16	—	17.8	—	—	—	12,000
13,000	12	—	17.6	—	—	—	13,000
14,000	9	—	FT	—	—	—	14,000

To maintain constant power, correct manifold pressure approximately 0.16" Hg for each 10°F variation in inlet air temperature from standard altitude temperature. Add manifold pressure for air temperatures above standard; subtract for temperatures below standard.

HANDLING AND SERVICING

HANDLING AND SERVICING

Ground Handling	9-1
Towing	9-1
Taxiing	9-1
Parking	9-2
Mooring.....	9-3
Cleaning.....	9-3
Cleaning Engine Compartment.....	9-4
Cleaning Landing Gear	9-4
Cleaning Exterior Surfaces	9-4
Cleaning Windshield and Windows.....	9-5
Cleaning Headliner, Side Panels and Seats.....	9-5
Cleaning Carpets.....	9-5
Power Plant Induction Air Filter	9-5
Removal of Induction Air Filter	9-5
Cleaning Induction Air Filter.....	9-5
Installation of Induction Air Filter	9-6
Brake Service.....	9-6
Landing Gear Service	9-6
Propeller Service.....	9-7
Oil Requirements	9-7
Fuel System	9-7
Fuel Requirements	9-7
Filling Fuel Tanks	9-7
Draining Fuel Valves and Lines	9-8
Draining Fuel System	9-8
Tire Inflation.....	9-8
Battery Service	9-9
Maintenance Advice to Owners	

BLANK PAGE

HANDLING AND SERVICING

This section contains information on preventive maintenance. Refer to the Seneca Service Manual for further maintenance. Any complex repair or modification should be accomplished by a Piper Certified Service Center.

GROUND HANDLING

TOWING

The airplane may be moved by using the nose wheel steering bar provided, or power equipment that will not damage or cause excess strain to the nose gear assembly. The steering bar is stowed aft of the fifth and sixth seats.

CAUTION

When towing with power equipment, do not turn nose gear more than 20 degrees in either direction as this will result in damage to the nose gear and steering mechanism.

TAXIING

Before attempting to taxi the airplane, ground personnel should be checked out by a qualified pilot or other responsible person. Engine starting and shut-down procedures should be covered as well. When it is ascertained that the propeller back blast and taxi areas are clear, apply power to start the taxi roll and perform the following checks:

- a. Taxi forward a few feet and apply brakes to determine their effectiveness.
- b. Taxi with propeller set in low pitch, high RPM setting.
- c. While taxiing, make slight turns to ascertain the effectiveness of steering.
- d. Observe wing clearances when taxiing near buildings or other stationary objects. If possible, station a guide outside the airplane to observe.
- e. When taxiing on uneven ground, look for holes and ruts.
- f. Do not operate the engine at high RPM when running up or taxiing over ground containing loose stones, gravel or any loose material that may cause damage to the propeller blades.

PARKING

When parking the airplane, insure that it is sufficiently protected against adverse weather conditions and presents no danger to other aircraft. When parking the airplane for any length of time or overnight, it is recommended that it be moored securely.

- a. To park the airplane, head it into the wind, if possible.
- b. Set the parking brake.

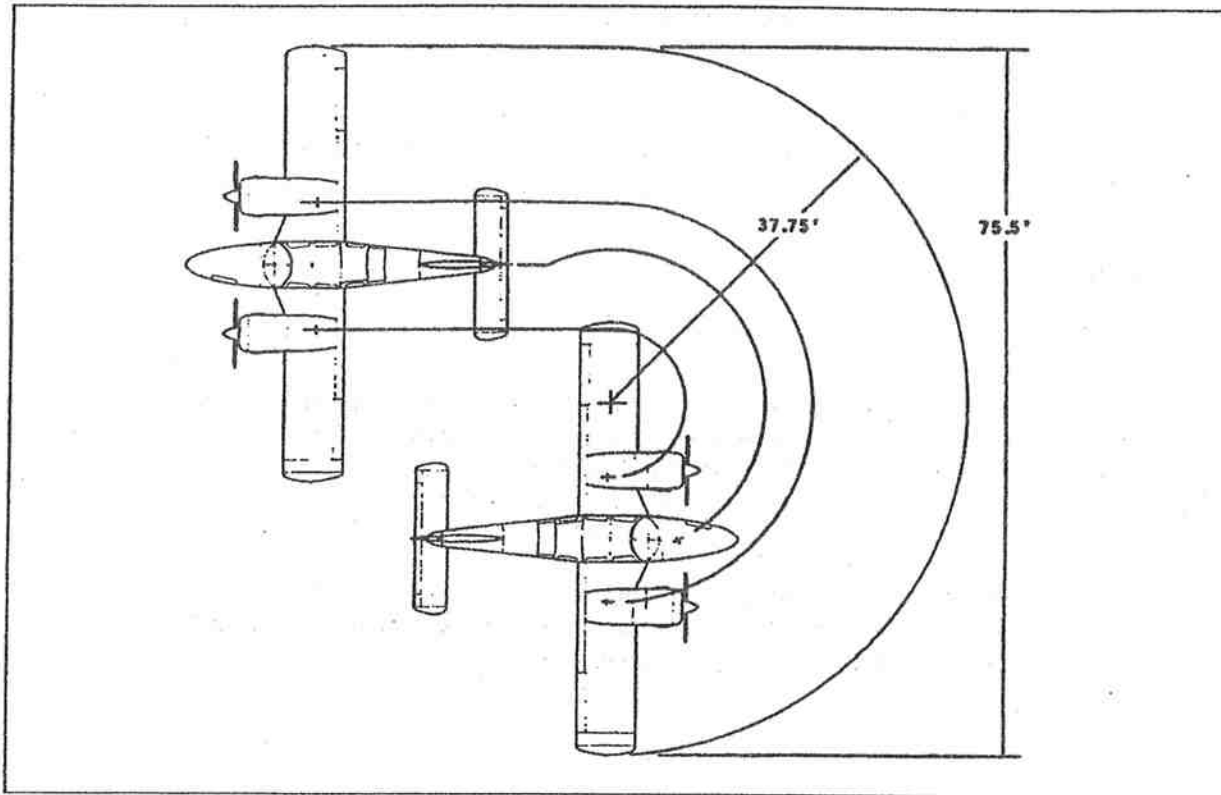

Minimum Turning Radius

NOTE

Care should be taken when setting brakes that are overheated or during cold weather when accumulated moisture may freeze a brake.

MOORING

The airplane should be moored to insure its immovability, protection and security under varying weather conditions. The following procedure should be used for proper mooring of the airplane.

- a. Head the airplane into the wind, if possible.
- b. Lock the aileron and stabilator controls using the control wheel lock, or control surface blocks.
- c. Block the wheels.
- d. Secure tie-down ropes to the wing tie-down rings and the tail skid at approximately 45-degree angles to the ground.

CAUTION

Use bowline knots. Do not use slip knots.

NOTE

Additional preparations for high winds include using tie-down ropes from the landing gear forks, and securing the rudder.

- e. Install pitot tube cover, if possible.

CLEANING**CLEANING ENGINE COMPARTMENT**

Before cleaning the engine compartment, place a strip of tape on the magneto vents to prevent any solvent from entering these units.

- a. Place a large pan under the engine to catch waste.
- b. With the engine cowling removed, spray or brush the engine with solvent or a mixture of solvent and degreaser, as desired. It may be necessary to brush areas that were sprayed where heavy grease and dirt deposits have collected in order to clean them.

CAUTION

Do not spray solvent into the alternator, vacuum pump, starter or air intakes.

- c. Allow the solvent to remain on the engine from five to ten minutes. Then rinse the engine clean with additional solvent and allow to dry.

CAUTION

Do not operate engine until excess solvent has evaporated or otherwise been removed.

- d. Remove the protective covers from the magnetos.
- e. Lubricate controls, bearing surfaces, etc., per Lubrication Chart.

CLEANING LANDING GEAR

Before cleaning the landing gear, place a plastic cover or similar material over the wheel and brake assembly.

- a. Place a pan under the gear to catch waste.
- b. Spray or brush the gear area with solvent or a mixture of solvent and degreaser, as desired. It may be necessary to brush areas that were sprayed where heavy grease and dirt deposits have collected in order to clean them.
- c. Allow the solvent to remain on the gear from five to ten minutes. Then rinse the gear with additional solvent and allow to dry.
- d. Remove the cover from the wheel and remove the catch pan.
- e. Lubricate the gear per Lubrication Chart.
- f. Caution: Do not brush the micro switches.

CLEANING EXTERIOR SURFACES

The airplane should be washed with a mild soap and water. Harsh abrasive or alkaline soaps or detergents used on painted or plastic surfaces could make scratches or cause corrosion of metal surfaces. Cover areas where cleaning solution could cause damage. To wash the airplane, the following procedure may be used:

- a. Flush away loose dirt with water.
- b. Apply cleaning solution with a rag, sponge or soft bristle brush.
- c. To remove stubborn oil and grease, use a cloth dampened with naphtha.
- d. Where exhaust stains exist, allow solution to remain on the surface longer.
- e. Any good automotive wax may be used to preserve the painted surfaces. Soft cleaning cloths or a chamois should be used to prevent scratches when cleaning or polishing. A heavier coating of wax on the leading surfaces will reduce the abrasion problems in these areas.

CLEANING WINDSHIELD AND WINDOWS

- a. Remove dirt, mud, and other marks from exterior surface with clean water.
- b. Wash with mild soap and warm water or an aircraft plastic cleaner. Use a soft cloth or sponge using a straight rubbing motion. Do not rub surface harshly.
- c. Remove oil and grease with a cloth moistened with kerosene.

NOTE

Do not use gasoline, alcohol, benzene, carbon tetrachloride, thinner, acetone, or window cleaning sprays.

- d. After cleaning plastic surfaces, apply a thin coat of hard polishing wax. Rub lightly with a soft cloth. Do not use a circular motion.
- e. A severe scratch or mar in plastic can be removed by using jeweler's rouge to rub out the scratch. Smooth both sides and apply wax.

CLEANING HEADLINER, SIDE PANELS AND SEATS

- a. Clean headliner, side panels and seats with a stiff bristle brush, and vacuum where necessary.
- b. Soiled upholstery, except leather, may be cleaned by using an approved foam upholstery cleaner. Carefully follow the manufacturer's instructions. Avoid soaking or harsh rubbing.

CAUTION

Solvent cleaners require adequate ventilation.

CLEANING CARPETS

Use a small whisk broom or vacuum to remove dirt. For soiled spots, use a non-inflammable dry cleaning fluid.

POWER PLANT INDUCTION AIR FILTER

The induction air filters must be cleaned at least once every 50 hours. Depending on the type of condition existing, it may be necessary to clean the filters more often.

REMOVAL OF INDUCTION AIR FILTER

- a. Open the outboard section of the cowling to gain access to the air filter box.
- b. Turn the three studs and remove the air filter box cover.
- c. Lift the air filter from the filter box.

CLEANING INDUCTION AIR FILTER

- a. Tap filter gently to remove dirt particles. Do not use compressed air or cleaning solvents.
- b. Inspect filter. If paper element is torn or ruptured or gasket is damaged, the filter should be replaced. The usable life of the filter should be restricted to one year or 500 hours, whichever comes first.

INSTALLATION OF INDUCTION AIR FILTER

- a. Place filter in air box and install cover.
- b. Secure cover by turning studs. Close cowl.

BRAKE SERVICE

The brake system is filled with MIL-H-5606 (petroleum base) hydraulic brake fluid. This should be checked periodically or at every 100-hour inspection and replenished when necessary. The brake reservoir is located to the rear of the front baggage compartment. Remove the access panel marked "Brake Reservoir Behind" located at the top rear of the compartment. Keep the fluid level at the level marked on the reservoir.

No adjustment of brake clearance is necessary. Refer to Aircraft Service Manual for replacing brake linings.

LANDING GEAR SERVICE

Two jack points are provided for jacking the aircraft for servicing. One is located outboard of each main landing gear and one just aft of the nose gear.

Landing gear oleos should be serviced according to instruction on the units. The main oleo struts should be exposed three and one half inches and the nose oleo strut should be exposed two and one half inches in the static position. Refer to Aircraft Service Manual for servicing oleo struts.

PROPELLER SERVICE

The gas charge in the propeller cylinder should be kept at the pressure specified on the placard located in the spinner cap. The pressure in the cylinder will increase about one-third psi for every degree Fahrenheit increase in temperature. This effect should be considered when checking pressure. The charge maintained must be accurate and free of excessive moisture since moisture may freeze the piston during cold weather. Dry nitrogen gas is recommended.

**CHAMBER PRESSURE REQUIREMENTS
WITH TEMPERATURE FOR COUNTERWEIGHT TYPE PROPELLERS**

Temp. °F	Press. (PSI)	Temp. °F	Press. (PSI)
100	86	30	72
90	84	20	70
80	82	10	68
70	80	0	66
60	78	-10	64
50	76	-20	62
40	74	-30	60

NOTE: Do not check pressure or charge with propeller in feather position.

OIL REQUIREMENTS

The oil capacity of the Lycoming engines is 8 quarts with a minimum safe quantity of 2 quarts. It is recommended that engine oil be drained and renewed every 50 hours or sooner under unfavorable conditions. Intervals between oil changes can be increased as much as 100% on engines equipped with full flow cartridge type oil filters provided the element is replaced each 50 hours of operation. The following grades are required for temperatures:

Temperatures above 60° F	S.A.E. 50
Temperatures between 30° F and 90° F	S.A.E. 40
Temperatures between 0° F and 70° F	S.A.E. 30
Temperatures below 10° F	S.A.E. 20

FUEL SYSTEM

The fuel screens in the strainers require cleaning at 50 hour or 90 day intervals, whichever first occurs. The fuel gascolator strainers are located between the fuel selector valves and the auxiliary boost pumps in the nacelles. The fuel injector screen is located in the housing where the fuel inlet line connects to the injector. This screen should be cleaned every 50 hours of operation.

FUEL REQUIREMENTS

A minimum octane of 100/130 Aviation Grade fuel must be used in the Seneca. Since the use of lower grades of fuel can cause serious damage in a short period of time, the engine warranty is invalidated by use of lower octanes.

FILLING FUEL TANKS

Observe all required precautions for handling gasoline. Fill the fuel tanks to the bottom of the filler neck with 100/130 octane fuel. Each wing holds a maximum of 49 gallons giving a total of 98 gallons of fuel.

DRAINING FUEL VALVES AND LINES

Each gascolator strainer is provided with a quick drain which should be drained before the first flight of the day or after refueling, to check for fuel contamination. If contamination is found, fuel should be drained until the contamination stops. If contamination persists after draining fuel for a minute, contact a mechanic to check the fuel system.

Each fuel tank is provided with a fuel quick drain to check for contamination. Each tank should be checked for contamination in accordance with the above procedure. Crossfeed drains are located on the bottom of the fuselage inboard of the right flap.

DRAINING FUEL SYSTEM

The bulk of the fuel may be drained from the fuel cells by the use of a siphon hose placed in the cell or tank through the filler neck. The remainder of the fuel may be drained by opening all the drain valves.

TIRE INFLATION

For maximum service from the tires, keep them inflated to the proper pressure of 31 psi for nose tire and 53 psi for main tires. Interchange the tires periodically for even wear. All wheels and tires are balanced before original installation, and the relationship of tire, tube and wheel should be maintained upon reinstallation. In the installation of new components, it may be necessary to rebalance the wheels with the tires mounted. Out of balance wheels can cause extreme vibration in the landing gear.

BATTERY SERVICE

Access to the 12-volt 35 ampere hour battery is gained through the nose baggage compartment. It is located just forward of the nose baggage compartment. The battery container has a plastic drain tube which is normally closed off.

The battery fluid level must not be brought above the baffle plates. It should be checked every 30 days to determine that the fluid level is proper and the connections are tight and free of corrosion.

If the battery is not properly charged, recharge it starting with a rate of 4 amperes and finishing with a rate of 2 amperes. Quick charges are not recommended.

The external power receptacle, if installed, is located on the left side of the nose section. Be sure that master switch is off while inserting or removing a plug at this receptacle.

Refer to Aircraft Service Manual for servicing battery.

Tire: Nose - 31 PSI
Main - 53 PSI

MAINTENANCE ADVICE TO OWNERS

Proper maintenance and servicing of the Seneca will ensure that it stays in good condition to provide years of satisfactory performance. It is usually best to have aircraft maintenance performed at an authorized Piper Service Center because such a shop has the tools, Service Manuals, parts and training to do the work properly. If the work is done elsewhere, be sure the mechanic uses a Piper Inspection Report form for the Seneca and a Seneca Service Manual. These are available from Piper dealers and distributors. When maintenance or repair work is done on the aircraft, the owner should make sure that the mechanic makes a complete and accurate record of the work performed, in the aircraft or engine log book.

Preventive maintenance is the key to dependable service. Every airplane must have an annual inspection by an FAA-authorized inspector. In addition, if the airplane is to be used commercially it must have an inspection every 100 hours. The Inspection Report form for the Seneca lists inspection and maintenance which should be performed every 50 hours in addition to items to be covered at 100 hours, 500 hours and 1000 hours.

When parts must be replaced, they should be replaced with Piper parts. Bogus parts, which are not exactly like or equivalent to the originals, are often less expensive than genuine parts. These may be made of a poor substitute material, they may not be properly heat treated, or dimensions may differ slightly. Because it is possible for a bogus part to look just like the real one and still be deficient, it is important to use only genuine Piper parts when servicing the Seneca.

The FAA occasionally publishes Airworthiness Directives, which are mandatory and should be complied with promptly. Piper Aircraft Corporation takes a continuing interest in having the owner get the most efficient use from his aircraft and in keeping it in the best mechanical condition. From time to time Piper issues Service Bulletins, Service Letters and Service Spares Letters relating to the aircraft. The Service Bulletins are of special importance and should be complied with promptly. Service Letters deal with product improvements and careful attention should be given to Service Letter information. The Service Spares Letters offer improved parts and operations which may be of interest to an owner.

From time to time, supplements to the Operating Manual will be distributed by the manufacturer. These revisions and additions should be studied and put into the operating Manual.

If the owner desires to modify the aircraft, he must obtain FAA approval for the change. Minor changes may be accomplished by a mechanic who records and approves the change on an FAA Form 337, but major changes must be accomplished under a Supplemental Type Certificate (STC).

IDENTIFICATION LETTER	SPECIFICATION	TYPE OF LUBRICANT	LUBRICANT
A	ML-L-7810		LUBRICATING OIL, GENERAL PURPOSE, LOW TEMPERATURE
B	ML-L-6632 7		LUBRICATING OIL, AIRCRAFT REGRIPACATING ENGINE (PISTON) GRADE AS SPECIFIED SAE 50 ABOVE 60°F AIR TEMP. SAE 40 30° TO 50°F AIR TEMP. SAE 30 0° TO 10°F AIR TEMP. SAE 20 BELOW 10°F AIR TEMP.
C	ML-H-6608 (NONE)		HYDRAULIC FLUID, PETROLEUM BASE (FOR HYDRAULIC SYSTEMS)
D	ML-Q-2357		GREASE, AIRCRAFT AND INSTRUMENT, GREASE AND ACTUATOR SCREWDRIFT
E			TEZACO MARFAK ALL PURPOSE GREASE OR MOBIL MOBIL GREASE #7 (OR MOBIL EP2 GREASE)
F	ML-L-7711		GREASE, LUBRICATION, GENERAL PURPOSE, LUBRICANT
G			FLUOROCARBON RELEASE AGENT
H			DRY LUBRICANT (MAG-12 (PUNCH) ASTRO LUBRICATE (PUNCH) PRIME BROS. REFINING CO.

TYPE OF LUBRICANT

NOTES

1. PILOT AND PASSENGER SEATS - LUBRICATE TRACK ROLLERS AND STOP PINS AS REQUIRED (TYPE OF LUBRICANT: 'A')
2. WHEEL BEARINGS REQUIRE CLEANING AND REPACKING AFTER EXPOSURE TO AN ABNORMAL QUANTITY OF WATER.
3. SEE LYCOMING SERVICE INSTRUCTIONS NO. 1014 FOR USE OF DETERGENT OIL.
4. FUEL SYSTEM - SERVICE REGULARLY - FUEL PUMP STRAINER INJECTOR SCREEN - FILTER BOWL - QUICK DRAIN UNIT.
5. BATTERY - FLUID LEVEL & CONDITION CHECK EVERY 25 HOURS.
6. ML-Q-6529 TYPE 200L IS THE OIL THE ENGINE IS SERVICED WITH AT INSTALLATION. THE ENGINE MUST OPERATE ON THIS OIL 24 HOURS MINIMUM, 50 HOURS MAXIMUM (SEE LYCOMING SERVICE LETTER NO. L1714)
7. THIS CHART IS FOR INITIAL FACTORY LUBRICATION AND SERVICE.

CAUTIONS

1. DO NOT USE HYDRAULIC FLUID WITH A CASTOR OIL OR ESTER BASE.
2. DO NOT OVER-LUBRICATE COCKPIT CONTROLS.
3. DO NOT APPLY LUBRICANT TO RUBBER PARTS.
4. DO NOT LUBRICATE CABLES - THIS CAUSES SLIPPAGE.

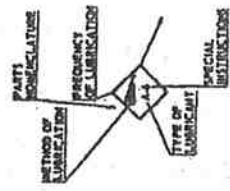

SPECIAL INSTRUCTIONS

1. AIR FILTER - TO CLEAN FILTER, TAP GENTLY TO REMOVE DIRT PARTICLES. DO NOT BLOW OUT WITH COMPRESSED AIR OR USE OIL. REPLACE FILTER IF PUNCTURED OR DAMAGED.
2. BEARING AND BUSHINGS - CLEAN EXTERIOR WITH A DRY TYPE SOLVENT BEFORE LUBRICATING.
3. WHEEL BEARINGS - DISASSEMBLE AND CLEAN WITH A DRY TYPE SOLVENT. ASCERTAIN THAT GREASE IS PACKED BETWEEN THE BEARING ROLLER AND CONE. DO NOT PACK GREASE IN WHEEL HOUSING.
4. OLEO STRUTS, HYDRAULIC PUMP RESERVOIR AND BRAKE RESERVOIR - FILL PER INSTRUCTIONS ON UNIT OR CONTAINER OR REFER TO SERVICE MANUAL.
5. PROPELLER - REMOVE ONE OF THE TWO GREASE FITTINGS FOR EACH BLADE. APPLY GREASE THROUGH FITTING UNTIL FRESH GREASE APPEARS AT HOLE OF REMOVED FITTING.
6. LUBRICATION POINTS - WIPE ALL LUBRICATION POINTS CLEAN OF OLD GREASE, OIL, DIRT, ETC. BEFORE LUBRICATING.

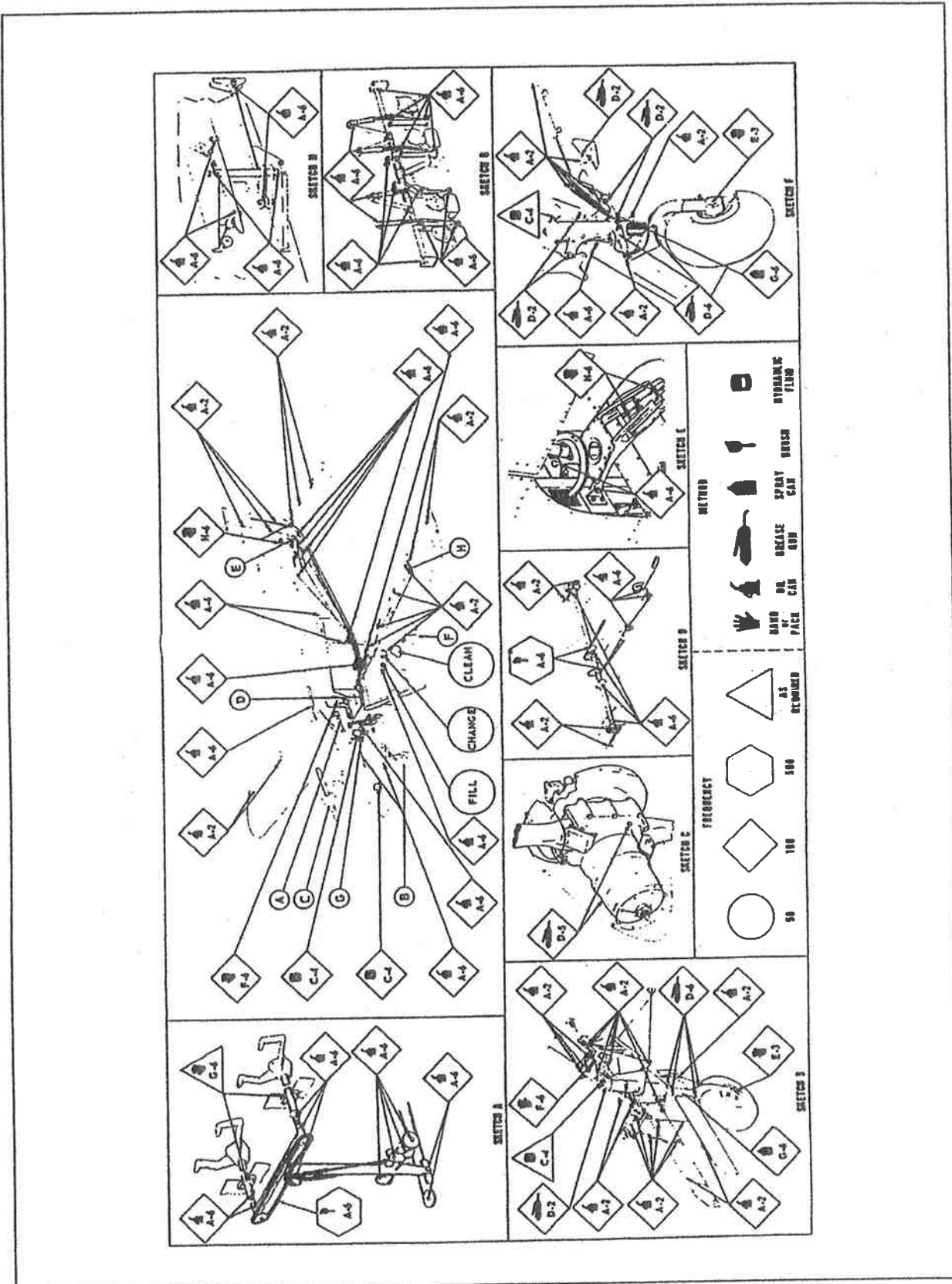

WAYMAN AVIATION SERVICE, INC.

Bldg. 209 Musick Rd. Opa-Locka Airport Opa-Locka, FL 33054 Ph: 305.685.6468 Fax: 305.685.6449

Piper Seneca I N887SP

E.L.T.	April 2009	April 2010
TRANSPONDER	April 2008	April 2010
STATIC SYSTEM	April 2008	April 2010
ANNUAL	April 2009	April 2010
100 HRS.	4,629.7 Tach	4,729.7 Tach

COMPUTED WEIGHT AND BALANCE

BASIC EMPTY WEIGHT	2862.8
TOTAL MOMENT	241794.1
NEW C.G.	84.46
USEFUL LOAD	1337.2

C. G. RANGE AND WEIGHT INSTRUCTIONS

1. Add the weight of all items to be loaded to the licensed empty weight.
2. Use the loading graph to determine the moment of all items to be carried in the airplane.
3. Add the moment of all items to be loaded to the licensed empty weight moment.
4. Divide the total moment by the total weight to determine the C.G. location.
5. By using the figures of Item 1 and Item 4, locate a point on the C.G. range and weight graph. If the point falls within the C.G. envelope, the loading meets the weight and balance requirements.

SAMPLE LOADING PROBLEM (Normal Category)

	Weight (Lbs)	Arm Aft Datum (Inches)	Moment (In-Lbs)
Licensed Basic Weight	2862.8	84.46	241794.1
Pilot and Front Passenger		85.5	
Passengers (Center Seats)		118.1	
Passengers (Rear Seats)*		155.7	
Passenger (Jump Seat)*		118.1	
Fuel (93 Gallon Maximum)		93.6	
Baggage (Forward)		22.5	
Baggage (Aft)		178.7	
Total Loaded Airplane			

The center of gravity (C.G.) of this sample loading problem is at _____ inches aft of the datum line. Locate this point () on the C.G. range and weight graph. Since this point falls within the weight-C.G. envelope, this loading meets the weight and balance requirements.

IT IS THE RESPONSIBILITY OF THE PILOT AND AIRCRAFT OWNER TO INSURE THAT THE AIRPLANE IS LOADED PROPERLY.

*Optional Equipment

C. G. RANGE AND WEIGHT INSTRUCTIONS

1. Add the weight of all items to be loaded to the licensed empty weight.
2. Use the loading graph to determine the moment of all items to be carried in the airplane.
3. Add the moment of all items to be loaded to the licensed empty weight moment.
4. Divide the total moment by the total weight to determine the C.G. location.
5. By using the figures of Item 1 and Item 4, locate a point on the C.G. range and weight graph. If the point falls within the C.G. envelope, the loading meets the weight and balance requirements.

SAMPLE LOADING PROBLEM (Normal Category)

	Weight (Lbs)	Arm Aft Datum (Inches)	Moment (In-Lbs)
Licensed Basic Weight	2862.0	84.46	241794.1
Pilot and Front Passenger		85.5	
Passengers (Center Seats)		118.1	
Passengers (Rear Seats)*		155.7	
Passenger (Jump Seat)*		118.1	
Fuel (93 Gallon Maximum)		93.6	
Baggage (Forward)		22.5	
Baggage (Aft)		178.7	
Total Loaded Airplane			

The center of gravity (C.G.) of this sample loading problem is at _____ inches aft of the datum line. Locate this point () on the C.G. range and weight graph. Since this point falls within the weight-C.G. envelope, this loading meets the weight and balance requirements.

IT IS THE RESPONSIBILITY OF THE PILOT AND AIRCRAFT OWNER TO INSURE THAT THE AIRPLANE IS LOADED PROPERLY.

*Optional Equipment

C. G. RANGE AND WEIGHT INSTRUCTIONS

1. Add the weight of all items to be loaded to the licensed empty weight.
2. Use the loading graph to determine the moment of all items to be carried in the airplane.
3. Add the moment of all items to be loaded to the licensed empty weight moment.
4. Divide the total moment by the total weight to determine the C.G. location.
5. By using the figures of Item 1 and Item 4, locate a point on the C.G. range and weight graph. If the point falls within the C.G. envelope, the loading meets the weight and balance requirements.

SAMPLE LOADING PROBLEM (Normal Category)

	Weight (Lbs)	Arm Aft Datum (Inches)	Moment (In-Lbs)
Licensed Basic Weight	2862.8	84.46	241794.1
Pilot and Front Passenger		85.5	
Passengers (Center Seats)		118.1	
Passengers (Rear Seats)*		155.7	
Passenger (Jump Seat)*		118.1	
Fuel (93 Gallon Maximum)		93.6	
Baggage (Forward)		22.5	
Baggage (Aft)		178.7	
Total Loaded Airplane			

The center of gravity (C.G.) of this sample loading problem is at _____ inches aft of the datum line. Locate this point () on the C.G. range and weight graph. Since this point falls within the weight-C.G. envelope, this loading meets the weight and balance requirements.

IT IS THE RESPONSIBILITY OF THE PILOT AND AIRCRAFT OWNER TO INSURE THAT THE AIRPLANE IS LOADED PROPERLY.

*Optional Equipment

C. G. RANGE AND WEIGHT INSTRUCTIONS

1. Add the weight of all items to be loaded to the licensed empty weight.
2. Use the loading graph to determine the moment of all items to be carried in the airplane.
3. Add the moment of all items to be loaded to the licensed empty weight moment.
4. Divide the total moment by the total weight to determine the C.G. location.
5. By using the figures of Item 1 and Item 4, locate a point on the C.G. range and weight graph. If the point falls within the C.G. envelope, the loading meets the weight and balance requirements.

SAMPLE LOADING PROBLEM (Normal Category)

	Weight (Lbs)	Arm Aft Datum (Inches)	Moment (In-Lbs)
Licensed Basic Weight	2862.8	84.46	241794.1
Pilot and Front Passenger		85.5	
Passengers (Center Seats)		118.1	
Passengers (Rear Seats)*		155.7	
Passenger (Jump Seat)*		118.1	
Fuel (93 Gallon Maximum)		93.6	
Baggage (Forward)		22.5	
Baggage (Aft)		178.7	
Total Loaded Airplane			

The center of gravity (C.G.) of this sample loading problem is at _____ inches aft of the datum line. Locate this point () on the C.G. range and weight graph. Since this point falls within the weight-C.G. envelope, this loading meets the weight and balance requirements.

IT IS THE RESPONSIBILITY OF THE PILOT AND AIRCRAFT OWNER TO INSURE THAT THE AIRPLANE IS LOADED PROPERLY.

*Optional Equipment

C. G. RANGE AND WEIGHT INSTRUCTIONS

1. Add the weight of all items to be loaded to the licensed empty weight.
2. Use the loading graph to determine the moment of all items to be carried in the airplane.
3. Add the moment of all items to be loaded to the licensed empty weight moment.
4. Divide the total moment by the total weight to determine the C.G. location.
5. By using the figures of Item 1 and Item 4, locate a point on the C.G. range and weight graph. If the point falls within the C.G. envelope, the loading meets the weight and balance requirements.

SAMPLE LOADING PROBLEM (Normal Category)

	Weight (Lbs)	Arm Aft Datum (Inches)	Moment (In-Lbs)
Licensed Basic Weight	2862.8	84.46	241794.1
Pilot and Front Passenger	380	85.5	32490
Passengers (Center Seats)	380	118.1	29525
Passengers (Rear Seats)*	180	155.7	28026
Passenger (Jump Seat)*	—	118.1	
Fuel (93 Gallon Maximum)	60/360	93.6	33696
Baggage (Forward)	50	22.5	1125
Baggage (Aft)	45	178.7	8041.5
Total Loaded Airplane	4127.8	90.77	374697.6

The center of gravity (C.G.) of this sample loading problem is at _____ inches aft of the datum line. Locate this point (_____) on the C.G. range and weight graph. Since this point falls within the weight-C.G. envelope, this loading meets the weight and balance requirements.

IT IS THE RESPONSIBILITY OF THE PILOT AND AIRCRAFT OWNER TO INSURE THAT THE AIRPLANE IS LOADED PROPERLY.

*Optional Equipment

