

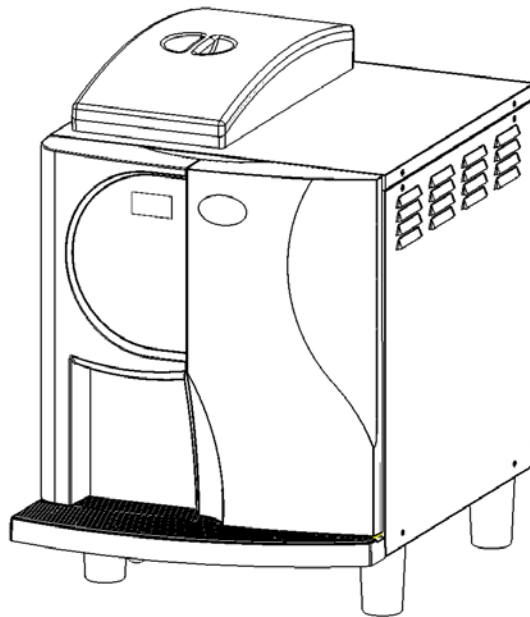

CONCORDIA

COFFEE SYSTEMS



Integra *User Guide*

Table of Contents

Important Safety Information	1
Machine Overview	2
The Integra System	2
The Integra System Components	3
1. Touch Pad	3
2. Product Outlet	3
3. Power Switch	3
4. Drain Tray and Grate	3
5. Refrigeration Unit	3
6. Service Switch	3
7. Bean Hopper	3
8. Grounds Bin	3
Using the Espresso System	4
Starting the System	4
Starting System if Display Reads: MACHINE IS OFF ...	4
Touch Pad	5
Pouring Drinks	7
Product Outlet	7
Sample Drinks	8
Machine Software Overview	9
Service Switch	9
The Service Switch in the SERVICE position	9
The Service Switch in the RUN position	9
The Service Switch and Cleaning the Machine	9
Software Programming Menu	10
Accessing the Programming Menu	10
Scrolling in the Menu	10
Accessing a Sub-Category	10
Changing a Value	10
Exiting a Sub-Category	10
Exiting the Main Menu	10
Check Grand Total Drink Statistics	11
Detailed Total Drink Statistics	11
Detailed Daily Drink Statistics	11
Software	12
Programming Menu Informational Screens	12
Categories	12
Beans and the Bean Hopper	14
Storing Espresso Roast Beans	14
Bean Hopper	14
Directions for Filling Bean Hopper	14
The Hopper Stopper	15
Using the Hopper Stopper	15
Removing a Bean Hopper	15
Milk and the Milk System	16

Refrigeration Unit	16
Placing Milk in the Machine	16
Checking the Refrigeration Unit Temperature	17
The Flavor System	18
Flavor Storage	18
Replacing Empty Flavor Boxes	19
Removing a Flavor Box Connector	19
Replacing a Flavor Box	20
Chocolate Sauce	20
Steam Wand	21
Steam Wand Overview	21
ON/OFF Button	21
Cleaning the Steam Wand	21
Cleaning and Maintenance	22
Cleaning	22
Cleaning Timers	22
Auto-Rinse Cycle	22
Daily Cleaning Procedures	23
Clean the Milk System	23
Clean the Brew Group	23
Empty Grounds Bin	24
Clean Drain Grate and Drain Tray	24
Clean Exterior Surfaces	24
Clean Interior of Refrigeration Unit	25
Refill Consumables.....	25
Clean Product Outlet.....	25
Monthly Cleaning Procedures	26
Check Air Filter.....	26
Removing the Air Filter	26
Clean the Bean Hopper	26
Replace the Upper Piston O-Ring	27
Reset the O-Ring Counter	28
Preventive Maintenance	29
Ordering Cleaning and Replacement Items	29
Operational Messages	30
Error Messages	32
Troubleshooting	33
FAQ	35
Machine Warranty	38



Important Safety Information

The safety of you and your customers is important to Concordia. The Integra dispenses hot liquids and steam. Please follow all safety precautions outlined in this manual, in order to reduce the risk of electric shock, burns, and/or injury to persons or property.

Machine Operation

- Do not use the machine for anything other than its specific intended purpose.
- Close supervision is required anytime the machine is used near children.
- Machine must be installed in a safe and stable location and in accordance with Concordia's installation requirements.
- Do not attempt to override safety interlocks.
- Do not operate the machine with unauthorized parts or attachments. Improper use may cause fire, electrical shock, hazard, or injury.

WARNING: Use of unauthorized parts or attachments will nullify the machine warranty.

Hot Surfaces and Liquids

- Care must be taken around the machine, as hot liquids and steam are produced and dispensed. Serious burns can occur.
- Do not touch hot surfaces or parts.

Electrical

- To protect against electrical hazards, do not immerse the power cord, plugs, or machine in water or any other liquid.
- Turn the power switch to "OFF" when the machine will not be used for an extended period.
- Do not operate the machine with an improper or damaged power cord or plug, or after the machine has been damaged in any manner.



Machine Overview

The Integra System

The Integra espresso machine grinds fresh whole beans, brews fresh espresso, steams fresh milk, and delivers a perfect, freshly brewed, gourmet espresso beverage.

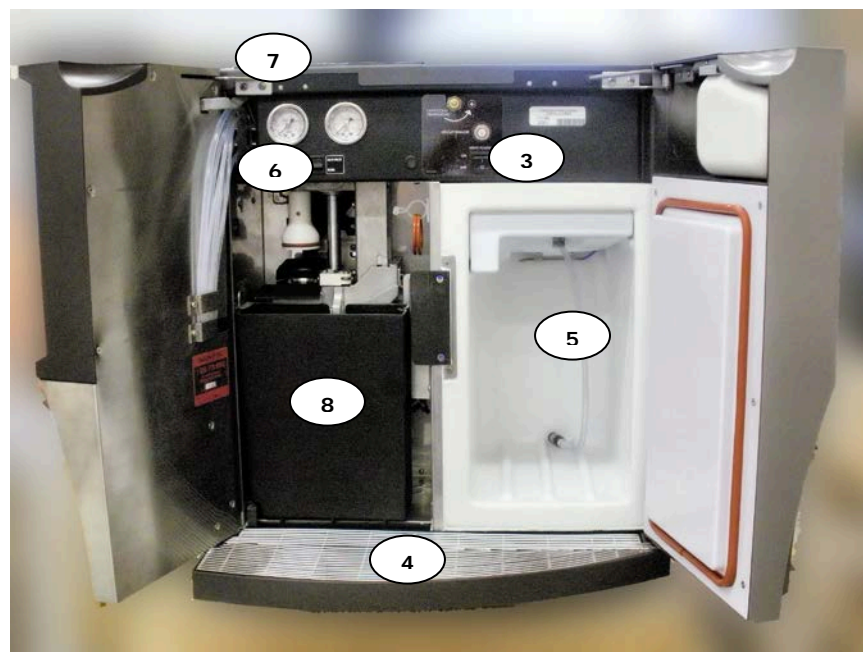



The Integra System Components

1. Touch Pad

SHOWN IN TOP PHOTO

The touch pad provides a user-friendly interface for selecting and pouring beverages.

2. Product Outlet

SHOWN IN TOP PHOTO

The product outlet is where drinks and hot water are dispensed.

3. Power Switch

Located behind the right front door of the machine.

4. Drain Tray and Grate

The drain tray and grate direct excess liquid to the drain.

5. Refrigeration Unit

The refrigeration unit holds one 1-gallon milk container.

6. Service Switch

The service switch is used to alternate between **RUN** mode and **SERVICE** mode, and is located behind the left door below the gauges.

7. Bean Hopper

NOT SHOWN

Located on top of the machine, the bean hopper has two compartments. Each compartment holds fresh, whole espresso roast beans.

8. Grounds Bin

The grounds bin holds the used espresso grounds. The **EMPTY GRNDS BIN** message will appear on the display every 35 drinks.



Using the Espresso System

Starting the System

The power switch is located on the panel behind the door for the refrigeration unit.

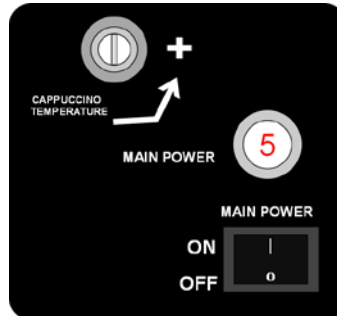

1. To start the machine, press the power switch to the **ON** position.
2. Close the door. The machine will not warm up if the door is open.
3. The display will read:

**CALIBRATING
WAIT WARMING UP**

Machine warm-up takes approximately 20-30 minutes. During warm-up, the machine is heating the water, generating steam, and calibrating the brew group.

NOTE: During the machine warm-up process, it is normal for hot water to be dispensed from the product outlet.

WARNING: Wait at least 10 seconds between turning the machine off and back on again. Quickly flipping the power switch on and off can blow a fuse within the machine and/or result in machine malfunction.

Starting System if Display Reads: **MACHINE IS OFF**

If the power switch is on and the display reads **MACHINE IS OFF**, you are unable to pour drinks. In this mode, only the refrigeration unit is functioning.

To start the machine, press and hold the **PROGRAM** button. A tone will sound; when the tone stops, release the **PROGRAM** button.



Touch Pad

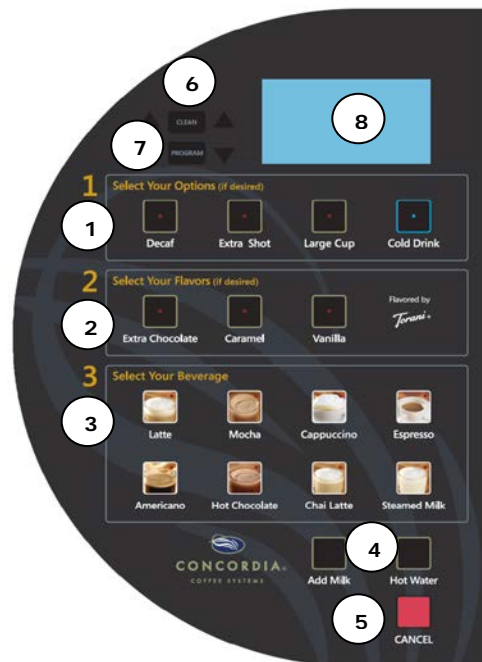

1. OPTIONS

THESE BUTTONS DETERMINE OPTIONS FOR DRINKS.

DECAF

Decaffeinated beans will be used when pouring the selected espresso-based drink.

EXTRA SHOT

An extra shot of espresso is added to the selected espresso-based drink.

LARGE CUP

The drink poured will be 16oz/480mL.

COLD DRINK

The drink will be poured using cold milk.

2. FLAVORS

THESE BUTTONS ARE USED TO SELECT THE DESIRED FLAVOR TO BE ADDED TO A DRINK.

EXTRA CHOCOLATE

Adds an additional serving of chocolate sauce to a milk-based drink.

CARAMEL

Adds a serving of caramel syrup to a milk-based drink.

VANILLA

Adds a serving of vanilla syrup to a milk-based drink.



3. DRINKS

THESE BUTTONS DETERMINE WHICH TYPE OF DRINK WILL BE Poured.

LATTE

Latte is poured.

MOCHA

Mocha is poured.

CAPPUCCINO

Cappuccino is poured.

ESPRESSO

Espresso is poured.

AMERICANO

Espresso with hot water is poured.

HOT CHOCOLATE

Hot chocolate is poured.

CHAI LATTE

Chai Latte is poured.

STEAMED MILK

Steamed milk is poured.

4. ADDITIONAL OPTIONS

ADD MILK

Will pour milk.

HOT WATER

Will pour hot water.

5. CANCEL BUTTON

CANCEL

Will clear current selection(s) or stop the pouring of a drink.

6. CLEAN BUTTON

*THE SERVICE SWITCH MUST BE IN THE **SERVICE** MODE FOR THIS FUNCTION. PLEASE SEE THE CLEANING CARD INCLUDED WITH THE MACHINE FOR FULL CLEANING PROCEDURES.*

7. PROGRAM BUTTON

FOR COMPLETE PROGRAMMING AND SOFTWARE MENU NAVIGATION INSTRUCTIONS, SEE PAGE 10.

MENU SCROLL UP ARROW

Scroll up in menu and submenu categories

MENU SCROLL DOWN ARROW

Scroll down in menu and submenu categories

INCREASE VALUE ARROW

Increase value in submenu category

DECREASE VALUE ARROW

Decrease value in submenu category

PROGRAM BUTTON

Press once for **GRAND TOTAL** drink statistics

Press 3 times to access main programming menu

8. LCD SCREEN

THE BLUE SCREEN PROVIDES MESSAGING ABOUT THE STATE OF THE MACHINE.



Pouring Drinks

Product Outlet

Drinks are dispensed at the product outlet. Before selecting a drink, the customer places their selected cup directly under the product outlet.

1. Place Cup Under Product Outlet

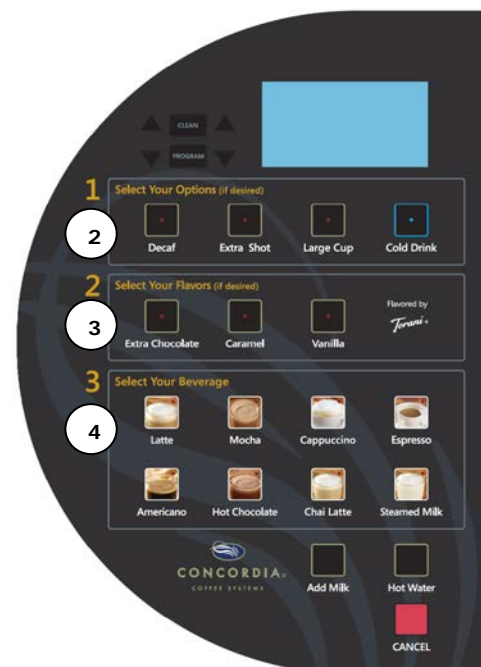

2. Select Drink Options

Decaf
Extra Shot
Large Cup
Cold Drink

3. Select Flavor (if desired)

Extra Chocolate
Caramel
Vanilla

4. Select Drink

Latte
Mocha
Cappuccino
Espresso
Americano
Hot Chocolate
Chai Latte
Steamed Milk

To stop a drink

Press the **CANCEL** button to interrupt the dispensing of a beverage.



Sample Drinks

LATTE

TO SELECT A REGULAR LATTE:

Press the **LATTE** button

TO SELECT A LARGE LATTE:

Press the **LARGE CUP** button

Press the **LATTE** button

MOCHA

TO SELECT A LARGE MOCHA:

Press the **LARGE CUP** button

Press the **MOCHA** button

TO SELECT A MOCHA WITH EXTRA CHOCOLATE:

Press the **EXTRA CHOCOLATE** button

Press the **MOCHA** button

Drink Variations

Make it Decaf

The beverage will be made with decaffeinated espresso beans.

TO SELECT: Press the **DECAF** button
Press desired option, flavor, and drink button(s)

Add a Flavor

A flavor will be added to the beverage.

TO SELECT: Press the desired **FLAVOR** button
Press desired option and drink button(s)

NOTE: Only one flavor can be chosen per milk-based drink, and no flavor can be chosen for an Americano. Flavor can be added to a hot chocolate, chai, or mocha drink.

NOTE: Pressing the **EXTRA CHOCOLATE** button will add a second serving of chocolate to a mocha or hot chocolate drink.



Machine Software Overview

Service Switch

The service switch is located behind the left door and below the water and steam gauges, and is used to place the Integra in either **SERVICE** or **RUN** mode.

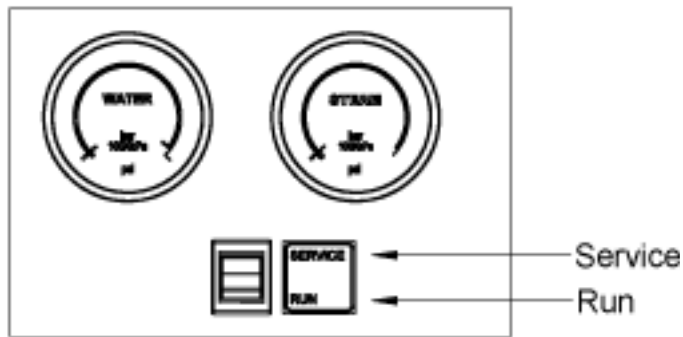

The Service Switch in the **SERVICE** position

- The machine will beep and the display will read **SERVICE KEY**
- Cleaning and programming buttons are enabled

The Service Switch in the **RUN** position

- Normal operating position
- Cleaning and programming buttons are disabled

The Service Switch and Cleaning the Machine

To clean the machine, the service switch must be in the **SERVICE** position.

1. Open the left door.
2. Press the service switch into the **SERVICE** position.
3. Follow the cleaning instructions outlined on the milk system and brew system cleaning cards.
4. Press the service switch back into the **RUN** position when the cleaning processes are complete.



Software Programming Menu

Accessing the Programming Menu

- Press the service switch into the **SERVICE** position.
- Press the **PROGRAM** button three times, slowly. You should hear a tone after each press.
- The display will change from **SELECT DRINK** to **SELECT CATEGORY**.

Scrolling in the Menu

Press the **SCROLL DOWN** arrow to scroll forward.

Press the **SCROLL UP** arrow to scroll in reverse.

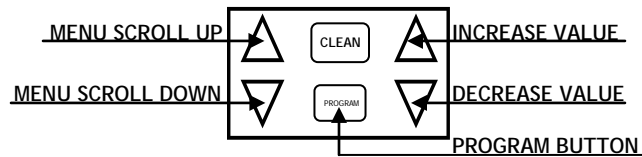

Accessing a Sub-Category

With the desired category appearing in the display, press the **PROGRAM** button once to enter the sub-category.

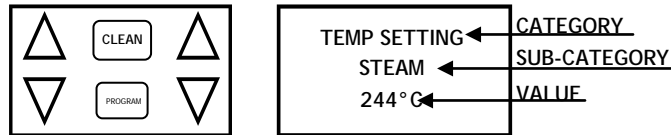

While in the sub-category, the main menu category moves to the top line of the display, the sub-category appears on the middle line, and the current value appears on the lower line of the display.

Changing a Value

- Press the **INCREASE VALUE** arrow to increase the value.
- Press the **DECREASE VALUE** arrow to decrease the value.

Exiting a Sub-Category

- Press the **PROGRAM** button once.
- The main menu category will appear in the middle of the display.

Exiting the Main Menu

From any main menu category, press any drink button once.

Display will read: **SELECT DRINK**



Check Grand Total Drink Statistics

- Press the **PROGRAM** button once.
- The drink **GRAND TOTAL** appears in the display.
- **SELECT DRINK** will automatically reappear on the display after a few seconds.

Detailed Total Drink Statistics

- Press the **PROGRAM** button three times (press slowly, you will hear a beep after each press).
- **SELECT CATEGORY** will appear in the display.
- Scroll to the sub-category **TOTAL DRINK COUNTS**.
- Press the **PROGRAM** button.
- Press the **SCROLL UP** arrow to scroll through the statistics.

To Exit

- Press the **PROGRAM** button once.
- Press any drink button.

Detailed Daily Drink Statistics

Daily statistics are reset after a brew system clean is completed.

- Press the **PROGRAM** button three times (press slowly, you will hear a beep after each press).
- **SELECT CATEGORY** will appear in the display.
- Scroll to the sub-category **DAILY DRINK COUNTS**.
- Press the **PROGRAM** button.
- Press the **SCROLL UP** arrow to scroll through the statistics.

To Exit

- Press the **PROGRAM** button once.
- Press any drink button.



Software

Below is a list of software categories for the Integra. For information and instructions on adjusting these settings, please contact Concordia Coffee Systems for assistance.

Programming Menu Informational Screens

- **GRAND TOTAL**
Displays the total number of drinks dispensed.
- **PART NUMBER**
Displays the part number (version) of the installed software.

Categories

- **TOTAL DRINK COUNTS**
Displays the total number of drinks poured since CPU board installation. This number is reset only when a new CPU board is installed.
- **DAILY DRINK COUNTS**
Displays the total number of drinks poured, by drink type, since the last brew clean.
- **TIME & DATE**
Contains settings for the internal clock and the automatic start feature.
- **CHK TEMPERATURES**
Displays water, refrigerator, and steam temperatures.
- **SET TEMPERATURES**
Change steam and water settings.
- **GRIND TIMES**
Changes the amount of ground coffee delivered into the brew chamber.
- **SHOT SELECT**
Determines the quantity of espresso shots per drink.
- **WATER VOLUME**
Changes water volume for espresso extraction, Americano, and hot water button settings.
- **MILK TIMINGS**
Changes milk timings for all milk-based drinks and milk buttons.



- **FLAVOR TIMINGS**
Displays the flavor dosage of drinks, in seconds of pour time.
- **DRINK PRICES**
Displays the prices for each drink.
- **SPECIAL FEATURES**
Enables or disables the following features: o-ring counter, vending, grounds bin, decaf, hot water button, or steamed milk button.
- **MISCELLANEOUS**
Display current software version, load defaults, and reset the Preventive Maintenance (PM) counter.
- **TEST ROUTINES**
Used for service diagnostic testing; each component of the machine can be run independently.



Beans and the Bean Hopper

The Integra is configured to deliver both regular and decaffeinated espresso beverages.

Whole espresso roast beans are placed in the bean hopper compartments, which are gravity fed to the grinders. Always use fresh, whole espresso roast beans to ensure a quality beverage.

WARNING: Never place espresso roast beans in the grinder using your hand(s).

WARNING: Do not place ground coffee, or other foreign materials, in the bean hopper.

Storing Espresso Roast Beans

Espresso roast beans are typically sealed in airtight packaging by the roaster. Once the bag has been opened, the freshness of the beans will begin to decrease.

NOTE: Do not store espresso roast beans in a freezer.

Bean Hopper

The large bean hopper compartment (right side) holds approximately 3lbs/1.5kg of regular beans, and the small bean hopper compartment (left side) holds approximately 2lbs/1kg of decaffeinated beans. Hoppers for only one bean hold approximately 5lbs/2.5kg of beans.

The bean hopper must be placed on the machine with the large bean hopper compartment on the right side, or the hopper will not properly feed beans into the machine.

Directions for Filling Bean Hopper

1. Remove the hopper lid.
2. Pour the beans into the hopper compartments.
3. Replace the hopper lid.

NOTE: If it is necessary to remove the bean hopper, insert both hopper stoppers first. Be sure to remove the hopper stoppers when finished.

DO Use fresh, whole, espresso roast beans.

DO NOT Place ground coffee into the bean hopper.

DO NOT Place foreign materials in the bean hopper.

DO NOT Feed beans into the grinder by hand.



The Hopper Stopper

The hopper stopper prevents beans from passing through the hopper chute when a bean hopper with beans is being removed from the machine.

Using the Hopper Stopper

1. To insert a hopper stopper, slide it between the beans and the interior hopper wall.
2. Use pressure when inserting the hopper stopper, to ensure that there is no space between the interior hopper wall and the hopper stopper.
3. With both hopper stoppers in place, a full hopper can be removed from the machine.

NOTE: Both hopper stoppers must be used when removing the bean hopper.

To remove the hopper stoppers once the bean hopper is back in its proper position on top of the Integra, simply pull the hopper stoppers out of the bean hopper compartments.



Removing a Bean Hopper

Once both hopper stoppers are in place, simply lift the bean hopper upwards.



Milk and the Milk System

Refrigeration Unit

The Integra features an on-board refrigeration unit to house the milk used for drinks. The refrigeration unit is designed to accommodate one standard, off-the-shelf one gallon/four liter milk container.

The following types of milk can be used in the Integra:

- Whole
- 2%
- 1%
- Non-Fat

WARNING: Do NOT use any type of flavored milk in the milk delivery system. The sugars in flavored milk (including eggnog) can damage the machine and clog the milk delivery tubes. Flavored milk can only be used on machines with the steam wand option. For more information on the steam wand option, please see page 21.

NOTE: For machines with the optional steam wand feature, flavored milks can be heated using the steam wand.

Placing Milk in the Machine

1. Open the refrigeration unit door and partially place the opened milk container in the refrigeration unit.
2. Place the milk pick-up tube in the milk container.
3. Slide the milk container into the refrigeration unit while feeding the milk pick-up tube fully into the milk container.
4. Close the refrigeration unit door.



- DO** make sure the milk pick-up tube is fed into the middle of the container.
- DO NOT** place the milk pick-up tube into the milk container handle.
- DO NOT** kink or bend the milk pick-up tube.
- DO NOT** pull excessively on the milk pick-up tube.



Checking the Refrigeration Unit Temperature

The temperature for the refrigeration unit is always displayed on the blue LCD.

If the refrigeration unit door has been open for an extended period, it is normal for the temperature will rise. To have the refrigeration unit return to the proper temperature, close the refrigeration unit door, and then check the temperature in an hour. If the temperature is not correct at that time, please contact Concordia Coffee Systems for assistance.



The Flavor System

Integra 1 and Integra 4 machines only

The Integra 1 and Integra 4 provide flavors for customer drinks. The Integra 1 offers an option for chocolate sauce and the Integra 4 offers options for chocolate sauce, caramel or vanilla syrup, or chai. These flavors are automatically dispensed and infused into the milk to ensure an even distribution of flavor in the drink.

Flavor Storage

The flavor storage area contains the flavors used to make the drinks. Each dispensing tube has a colored band, and each flavor box has a corresponding sticker with the same color. It is important to ensure the sticker color on the flavor tube matches the sticker color on the flavor box, to ensure customers receive the correct flavor in their drink and to prevent flavor tubes from being contaminated with secondary flavors.

Black	Yellow	White	Red
Chocolate	Caramel	Vanilla	Chai

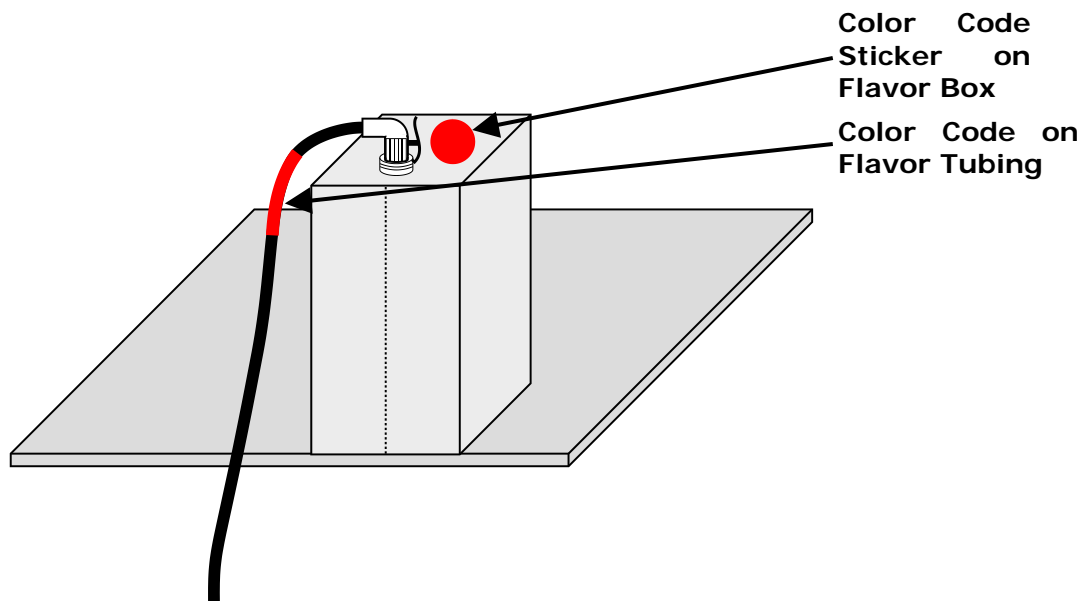

It is necessary to periodically check the flavor boxes, as the available flavor levels are not automatically monitored by the machine. Lift the box to check the level of flavor; if the box is very lightweight, the flavor level is getting low and it may be necessary to replace the box.

Do NOT lift a flavor box by grabbing a connector.



Replacing Empty Flavor Boxes

Before replacing a flavor box, verify the bag is empty.

For chocolate sauce boxes, the bag inside the box may crease or partially collapse and it may only be necessary to manipulate the bag for chocolate sauce to flow properly. For instructions on how to do this, please contact Concordia Coffee Systems for assistance.

Removing a Flavor Box Connector

1. To catch any flavor drips, place a cleaning rag under the nozzle.
2. Hold the nozzle in place with one hand.
3. Grasp the connector with your other hand.
4. Using your thumb, push on the left side of the connector handle to release the connector, and then pull from nozzle.

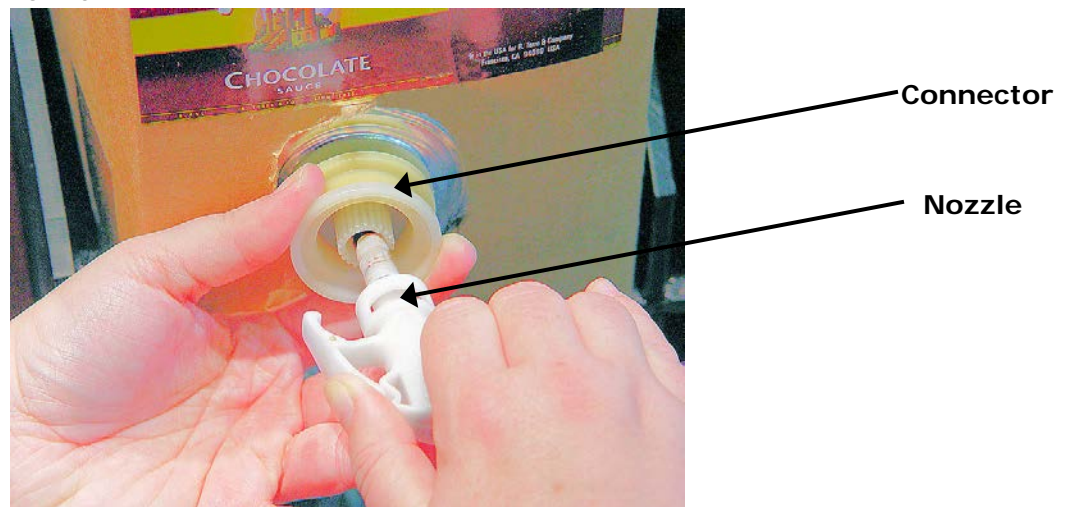

Once the nozzle is removed from the connector, remove the empty box from the flavor storage area. Do NOT place the nozzle on the floor.

NOTE: It is normal for a small amount of syrup or sauce in a bag. A small amount of syrup or sauce may also drip when the nozzle is removed from the bag.



Replacing a Flavor Box

1. Open the flavor box at the "OPEN HERE" location, and then extract the connector.
2. Remove the protective seal from the connector.
3. Clean the nozzle and o-ring thoroughly with a wet cloth to remove any debris, provide lubrication, and remove any syrup or chocolate sauce residue.
IMPORTANT: Wet the black o-ring seal at the tip of the nozzle with water prior to inserting it into a new flavor box. Inserting a dry o-ring will result in leaks.
4. Hold the connector firmly in your hand.
5. Firmly insert the correct color-coded nozzle into the connector, until the nozzle handle clicks into place.

WARNING: Do not try to insert the nozzle without holding the connector, or the connector may be pushed into the box.

Chocolate Sauce

It is necessary to pre-warm the chocolate sauce to a minimum temperature of 85°F/29°C, otherwise it will not flow properly. If chocolate sauce is not flowing and the flavor box is not empty, confirm the warming tray is on and operating. If it is not, contact Concordia Coffee Systems for assistance. The power switch for the chocolate sauce flavor tray is on the back of the tray.

NOTE: It can take up to 24 hours for a bag of chocolate to warm up to the proper temperature. The warming tray has room for two boxes of chocolate sauce. Due to the length of time necessary to fully heat a box of chocolate sauce, storing a second box of chocolate sauce on the warming tray is strongly recommended.

WARNING: The chocolate flavor tube may rupture if cold chocolate sauce is used.



Steam Wand

Steam Wand Overview

The Integra has an optional steam wand feature. The steam wand is used to steam liquids that cannot be used in the machine (e.g. eggnog, chai, flavored milks).



ON/OFF Button

The ON/OFF button is located directly above the steam wand. To activate the steam wand, press the button once. To deactivate the steam wand, press the button so that it pops back into the up position.

Cleaning the Steam Wand

Simply press the steam wand button and run steam through the steam wand for cleaning. It is recommended to do this several times a day.

After using the steam wand, it is recommended to run steam through the wand for 1-3 seconds and to wipe down the length of the steam wand to prevent build-up of milk, etc.

If there is a build-up of residue on the steam wand, place the steam wand in a container of hot water and let it soak for 5-10 minutes. Then, remove the steam wand from the water, wipe it down thoroughly, and then run steam for 5-10 seconds.



Cleaning and Maintenance

Cleaning

To maintain the machine warranty, ensure sanitation, avoid mechanical failure, and ensure continual operation, the Integra MUST be cleaned and maintained on a regular basis.

Concordia cleaning products must be used in order to ensure proper cleaning and to maintain machine warranty. Please see page 29 for ordering information.

WARNING: Do NOT store cleaning products in the flavor cabinet or near consumables.

Cleaning Timers

The milk system and brew group must be cleaned every 24 hours, or after every 150 drinks, whichever occurs first.

All timers start after the first drink is poured following a cleaning. For example, if you clean the machine on Friday night, and it is idle Saturday and Sunday, the timers are not started until the first drink is poured Monday morning.

Auto-Rinse Cycle

The machine has the option of an automatic rinse cycle to run at a pre-set interval. A loud tone will sound as a warning before the auto-rinse cycle begins. The display will read: **DANGER! HOT WATER.**

During the auto-rinse cycle, hot water runs through the brew system and steam runs through the milk delivery system to provide a quick rinse.

You cannot pour drinks during the auto-rinse cycle (approximately 30 seconds).



Daily Cleaning Procedures

Daily cleaning and maintenance can be performed in less than 15 minutes a day!

- 1. Clean the milk system.**
- 2. Clean the brew group.**
- 3. Empty the grounds bin.**
- 4. Clean the drain grate and drain tray.**
- 5. Clean exterior surfaces.**
- 6. Clean the interior of the refrigeration unit.**
- 7. Clean the product outlet.**

To perform cleaning procedures, the service switch must be in the **SERVICE** position. For more information about the service switch, please see page 9.

Clean the Milk System

Every 24 hours, or after 100 drinks are poured, the machine's display will read **MILK CLEAN DUE**. The milk system must be cleaned within two hours or 50 drinks, or the machine will stop dispensing drinks. When this happens, the display will read **RUN MILK CLEAN!** Once the milk system is cleaned, the system will reset and normal operation will resume.

For complete instructions on cleaning the milk system, please see the cleaning card included with the machine.

Clean the Brew Group

Every 24 hours, the machine's display will read **BREW CLEAN DUE**. The brew group must be cleaned within two hours, or the machine will stop dispensing drinks. When this happens, the display will read **RUN BREW CLEAN!** Once the brew group is cleaned, the system will reset and normal operation will resume.

For complete directions on cleaning the brew group, please see the cleaning card included with the machine.



Empty Grounds Bin

The grounds bin holds the used espresso grounds. The **EMPTY GRNDS BIN** message will appear on the display every 35 drinks.



To empty the grounds bin:

1. Open the left machine door.
2. Remove the grounds bin.
3. Discard the used grounds into a waste receptacle. To clear the **EMPTY GRNDS BIN** message, remove the grounds bin from the machine for at least six seconds.
4. Wipe out residue from the grounds bin. Rinse as necessary.
5. Replace the grounds bin into the machine. Be sure to push it in all the way!
6. Close the front machine door.

NOTE: To avoid overfilling the grounds bin, always empty the grounds bin each time it is removed. Each time the grounds bin is removed for more than six seconds, the grounds bin counter is reset to zero.

Clean Drain Grate and Drain Tray

1. Remove the drain grate and clean with sanitizer to remove residue.
2. The drain grate can be placed in a dishwasher.
3. Clean the black plastic drain tray with towel moistened with soap and water. Do NOT use bleach or any other chemical cleaner, or wash in a dishwasher.

Clean Exterior Surfaces

1. Clean the exterior of the machine area using a towel moistened with sanitizer.
2. Clean the doors and the front panel of the machine.
3. Thoroughly clean around the drink dispensing area. Wipe with a wet towel.
4. If further cleaning is necessary, clean using mild dish soap mixed with warm water.

WARNING: To avoid contact with chemicals and hot water, do not clean the drink dispensing area during the milk system clean or brew system clean processes.



Clean Interior of Refrigeration Unit

1. Remove the milk container.
2. Use a cloth or paper towel and wipe up any spilled milk.
3. Use a mixture of soap and water to clean the walls of the refrigeration unit and to wipe down the milk pick-up tube.
4. Return the milk container to the refrigeration unit.

WARNING: Do NOT use bleach on any part of the refrigeration unit or on a milk pick-up tube.

Refill Consumables

Refill all beans, milk, and flavors, as needed.

Check level of flavor in the boxes by lifting the front of each box.

Clean Product Outlet

Wipe down the product outlet in order to ensure no cleaning chemicals remain. Use a mild soap and water mixture, and rinse thoroughly.



Monthly Cleaning Procedures

Certain cleaning tasks only need to be completed once per month. These tasks include:

1. **Check the air filter; replace if necessary.**
2. **Clean the bean hopper.**
3. **Replace the upper piston o-ring, and then reset the o-ring counter.**

Check Air Filter

Check the filter monthly for buildup of dust and grime. When dirty, replace filter.

Removing the Air Filter

The air filter is located to the upper right of the refrigeration unit.

1. Open the refrigeration unit door. The filter is located in upper right-hand corner.
2. Pull air filter forward to remove.
3. If dirty, replace with new air filter. To order an air filter, contact Concordia Coffee Systems for assistance.

NOTE: Failure to replace a dirty air filter may cause damage to the machine's cooling system.

Clean the Bean Hopper

1. Insert a hopper stopper in each bean hopper compartment.
2. Remove the bean hopper from machine.
3. Empty the beans into a clean container.
4. Clean the inside of both bean hopper compartments with warm soapy water, and rinse thoroughly.

WARNING: Do not wash a bean hopper in a dishwasher.

5. Dry the inside of the bean hopper.
6. Ensure the hopper stoppers are in place.
7. Refill the bean hopper compartments with beans.
8. Place the bean hopper in its proper position on machine.
9. Remove the hopper stoppers.



Replace the Upper Piston O-Ring

The upper piston o-ring must be replaced every 5,000 drinks. When the message **REPLACE O-RING** is displayed, follow the procedure below.

1. Open the machine doors.
2. Use the brush provided in the cleaning kit to clean the upper piston and o-ring area.



3. To remove the o-ring: press both sides of the o-ring with your index fingers and gently pull the o-ring towards the front of the machine. You should see a portion of the o-ring pull away from the o-ring groove. Using your thumb, press down on the exposed edge and roll the o-ring down and off of the upper piston.

NOTE: If it is difficult to use your thumb to remove the o-ring, you can use a small flathead screwdriver to remove the o-ring. If you use a flathead screwdriver, *very gently* insert it gently between the o-ring and the upper piston; once the head of the screwdriver is under the o-ring, gently run it under the o-ring to loosen (it is only necessary to loosen half of the o-ring).

WARNING: Be very careful not to damage the piston.





4. Once the o-ring is fully removed, clean the piston and o-ring groove. Ensure that no coffee grounds exist in the o-ring groove.
5. Locate the spare o-rings located behind the right door.

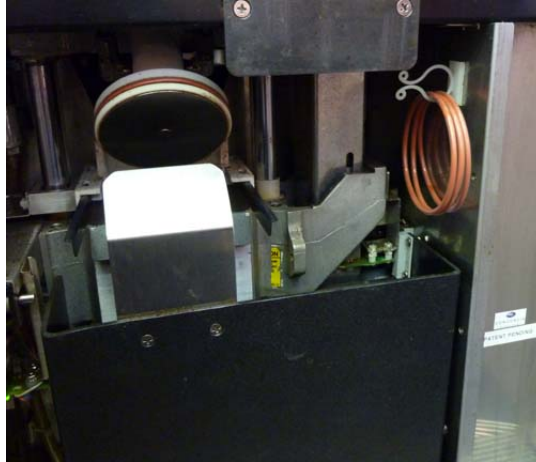

6. Position the new o-ring around the bottom of the piston and roll it up and into place in the o-ring groove. Ensure the o-ring fits smoothly and snugly in the o-ring groove.

Reset the O-Ring Counter

1. Press the service switch into the **SERVICE** position and close both machine doors.
2. On the touchpad, press the **PROGRAM** button three times. **SELECT CATEGORY** will be displayed.
3. Using the left down arrow, scroll to the **SPECIAL FEATURES** category.
4. Press the **PROGRAM** button once.
5. Using the left down arrow, scroll through the menu until **RESET O-RING MSG** is displayed.
6. Press either arrow to the right of the **CLEAN** button once. This will clear the warning message and reset the counter.
7. Press the **PROGRAM** button once to exit the **SPECIAL FEATURES** category.
8. Press the **CANCEL** button. **SELECT DRINK** or **WAIT WARMING UP** should be displayed.
9. Open the left door and press the service switch into the **RUN** position.
10. Close the machine doors.



Preventive Maintenance

The Preventive Maintenance (PM) Service Call ensures continued optimal operation of the machine through the proactive replacement, cleaning and adjustment of internal components. Preventive Maintenance is required to maintain the warranty and extended service agreements.

Preventive Maintenance must be performed every 10,000 drinks by a Certified Technician. The Integra is equipped to monitor the total drink statistics, and a **REQUEST PM** message will be displayed when the machine reaches 10,000 drinks.

When the **REQUEST PM** message appears, contact Concordia Coffee Systems to schedule a Preventive Maintenance Service Call.

Ordering Cleaning and Replacement Items

The following items can be ordered for the Integra:

PART
Hopper Stopper
Brew Group and Milk System Cleaning Card
6-Month Cleaning Kit (includes Milk System Cleaner #1, Milk System Cleaner #2, Brew Group Cleaning tablets)

To order any of these items, contact Concordia Coffee Systems for assistance.



Operational Messages

DISPLAY MESSAGE	WHAT TO DO
BREW CLEAN DUE	Clean the brew group. For cleaning procedures, see the cleaning card included with the machine.
MILK CLEAN DUE	Clean the milk system. For cleaning procedures, see the cleaning card included with the machine.
RUN MILK CLEAN!	The milk system must be cleaned to resume operation. See the cleaning card included with the machine.
RUN BREW CLEAN!	The brew group must be cleaned to resume operation. See the cleaning card included with the machine.
EMPTY GRNDS BIN	Empty the grounds bin. See page 24.
MACHINE IS OFF	To turn the machine on, press and hold the PROGRAM button until the tone stops, see page 6.
NO BEANS - REGULAR	Fill right bean hopper. Stir beans to loosen them.
NO BEANS – DECAF	Fill left bean hopper. Stir beans to loosen them.
CHECK MILK	Replace the milk supply in the refrigeration unit.



DISPLAY MESSAGE	WHAT TO DO
Refrigerator temperature	<p>The refrigeration unit temperature is displayed on the LCD at all times.</p> <p>A refrigerator temperature of 42°F/6°C or greater is considered high. Machine will beep in warning.</p> <p>Make sure the refrigeration unit door is closed.</p> <p>If the milk system was recently cleaned and the refrigeration unit door was open for an extended period, close the door and wait one hour. Refrigeration unit should return to operating temperature.</p>
REQUEST PM	<p>Contact Concordia Coffee Systems to schedule a Preventive Maintenance service call, see page 29.</p> <p>Machine is still operational.</p>
REPLACE O-RING	<p>Follow the o-ring replacement procedure on page 27.</p>
WAIT WARMING UP	<p>Machine warm-up requires 20-30 minutes. If message appears on screen for more than 30 minutes, turn machine off at power switch, wait 10 seconds, and turn machine on.</p> <p>If message continues more than 30 minutes after restarting machine, contact Concordia Coffee Systems for assistance.</p>



Error Messages

DISPLAY MESSAGE	WHAT TO DO
CHK WATER SUPPLY	<p>Make sure incoming water supply valve is open. This valve controls the water supply to the machine.</p> <p>If error persists, contact Concordia Coffee Systems for assistance.</p>
CHK WATER FLOW	<p>Make sure incoming water supply valve is open. This valve controls the water supply to the machine.</p> <p>Run a brew clean.</p> <p>If error persists, contact Concordia Coffee Systems for assistance.</p>
GROUND BIN OUT	<p>Make sure grounds bin is in place.</p>



Troubleshooting

MACHINE SYMPTOM	WHAT TO DO
Display is blank	<p>Make sure machine's power switch is in the ON position. See page 4.</p> <p>Make sure the power cord is plugged into the wall receptacle.</p>
No milk flow	<p>Check milk containers in the refrigeration unit.</p> <p>Make sure the milk pickup tube is inserted all the way into the milk container, see page 16.</p> <p>Make sure the milk pickup tube is fed into the middle of the container and not into the handle.</p> <p>Check milk pick-up tube for kinks or bends. Gently try to smooth out kink. Remove tube from milk container, if necessary, and then re-insert.</p> <p>Clean the milk system. See the cleaning card included with the machine.</p>
Machine won't operate	<p>Make sure all doors are closed.</p> <p>Check for error message on LCD.</p> <p>Make sure the front panel is closed.</p> <p>Make sure the grounds bin is correctly positioned.</p> <p>Make sure the power cord is plugged into the wall receptacle.</p> <p>Make sure machine's power switch is in the ON position. See page 4.</p> <p>Verify building main circuit breaker is not tripped.</p>
Inconsistent cup fill	<p>Clean the milk system. See the cleaning card included with the machine.</p>
All drinks are over or under filling	<p>Clean the milk system. See the cleaning card included with the machine.</p>
All drinks are overflowing	<p>Clean the milk system. See the cleaning card included with the machine.</p>



MACHINE SYMPTOM	WHAT TO DO
Espresso is bitter	Clean the brew group. See the cleaning card included with the machine. The machine needs to be recalibrated. Contact Concordia Coffee Systems for assistance. The espresso beans are stale. Use fresh beans.
Cappuccino milk isn't foamy	Clean the milk system. See the cleaning card included with the machine.
Flavor system is leaking	If the leak is at the bag connection, disconnect connector from bag nozzle, clean connector with hot water, reconnect. If leak persists, contact Concordia Coffee Systems for assistance. If the leak is anywhere other than the connector, contact Concordia Coffee Systems for assistance.
Flavor is not being dispensed	Check flavor tubes for kinks or bends. Gently try to smooth out kink. Verify level of flavor supply. Check chocolate sauce tray. If the flavor tubes are not kinked, contact Concordia Coffee Systems for assistance.
There is a blockage in a flavor tube	Contact Concordia Coffee Systems for assistance.



FAQ

- Q Can I use different types of espresso roast beans?**
Yes. You are free to choose the type of bean that you will use in the Integra. If you plan to change the type of beans being used, you must schedule a calibration service call.
- Q Can I use regular coffee beans in my espresso machine?**
No. Use only espresso roast beans.
- Q Can I change the brand of milk?**
Yes. Changing the brand of milk may result in a noticeable change in drink quality.
- Q Can I change the type of milk on offer?**
Yes. You are free to use any type of milk that you desire. If you change from whole milk to 2%, you may notice a difference in steamed and foamed milk, but this difference is not significant enough to affect overall drink quality.
- Q Can I use flavored milk(s) in my espresso machine?**
No. Never use flavored milk, such as eggnog or chocolate milk. The machine's internal components are not designed to handle the additional sugars in flavored milk. For machines with the optional steam wand feature, flavored milks can be heated using the steam wand.
- Q How do I cancel a drink?**
Press the **CANCEL** button to stop the pouring of a drink.
- Q How do I change the cup size? For example, I want to change from a 12oz/360mL cup to a 10oz/300mL cup.**
Contact Concordia Coffee Systems to schedule a Calibration Service Call, and a Concordia-Certified Technician will adjust your machine to the new drink size. A Calibration Service Call is not covered under the Machine Warranty or Extended Service Agreement.
- Q Can I adjust the amount of syrup added to a drink?**
Yes. Contact Concordia Coffee Systems to schedule a calibration service call.



Q How can I tell if my employees cleaned the machine?

If your machine is not cleaned within 24 hours, the display will read **MILK CLEAN DUE** or **BREW CLEAN DUE**. For complete information on the cleaning timers, see page 22.

Q How do I check the daily drink statistics?

Your espresso machine tracks both daily and cumulative drink statistics. For step-by-step directions on checking drink statistics, see page 11.

Q Where do I purchase espresso roast coffee beans?

Espresso roast beans can be purchased from retail and wholesale stores, as well as directly from the roaster.

Q What is the difference between coffee beans and espresso roast coffee beans?

Espresso roast coffee beans are specifically roasted for use in espresso machines. They retain their oils for a full-flavored drink.

Q My machine is beeping and the display reads EMPTY GRNDS BIN. What do I do?

Empty the grounds bin. The grounds bin must be emptied every 35 drinks. For directions on emptying the grounds bin, see page 24.

Q If I want to clean my bean hopper, how do I pull them off the machine without spilling the beans?

To remove a full bean hopper you must first place both hopper stoppers in the bean hopper compartments. For directions on inserting the hopper stoppers, see page 15. Once the hopper stoppers are in place, pull straight up to remove.

Q My machine is beeping and the display reads BREW CLEAN DUE.

When the display reads **BREW CLEAN DUE**, the brew group must be cleaned within two hours to ensure uninterrupted operation. If the brew group is not cleaned within two hours, the message will change to **RUN BREW CLEAN!** and the machine will be disabled. The brew group must be cleaned to resume operation. For directions on cleaning the brew group, see the cleaning card included with the machine.



Q My machine is beeping and the display reads MILK CLEAN DUE.

When the display reads **MILK CLEAN DUE**, the milk system must be cleaned within 50 drinks or two hours to ensure uninterrupted operation. If the milk system is not cleaned within two hours, the message will change to **RUN MILK CLEAN!** and the machine will be disabled. The milk system must be cleaned to resume operation. For complete directions on cleaning the milk system, see the cleaning card included with the machine.

Q I cleaned my machine, and several hours later the display reads MILK CLEAN DUE.

The milk clean cycle is required every 24 hours or every 150 drinks. When high volumes of drinks are sold, it is necessary to clean the milk system more than once per day.

For directions on cleaning the milk system, see the cleaning card included with the machine.

Q Can I change the time my machine turns on each day?

Yes! You can program your machine to automatically turn on Monday-Friday or Monday-Sunday, and you can program the time in five-minute intervals. This feature is adjustable through the **DATE & TIME** programming menu category. Please contact Concordia Coffee Systems for assistance in accessing and changing this setting.

Q What are the default temperature settings?

	Default Temperature Setting
Steam	252°F/122.2°C
Brew Water	198°F/92.2°C
Refrigerator	36°F/2.2°C
Refer Temp Hi (alarm)	41°F/5°C
Refer Temp Lo (alarm)	0°F/-17.8°C



Machine Warranty

Limited Warranty Statement and Disclaimers

Concordia warrants the Goods to be free from defects in materials and workmanship under normal conditions for a period of either twelve (12) months after the original date of shipment; or either 36,500 drink cycles; whichever period ends first ("Limited Warranty period"), subject to the terms set forth herein.

In the event of a failure of the Goods during the Limited Warranty due to a defect in materials or workmanship, subject to the warranty exclusions set forth below, Concordia will arrange for the Goods to be repaired on-site, without charge for labor or parts, if the limited warranty service occurs during normal business hours (8:00 a.m. to 5:00 p.m., local time, Monday through Friday, except holidays). If limited warranty service is required outside normal business hours, you will not be charged for parts but you will be charged for labor at Concordia's scheduled rates.

The foregoing limited warranty represents the full extent of Concordia's liability with respect to the Goods. Your right to repair as specified above is your sole and exclusive remedy against Concordia. In no event shall Concordia be liable for damages of any kind, including but not limited to special, indirect, incidental or consequential damages, arising from or relating to the sale or use of the Goods, either during or after the term of limited warranty.

Additional Limited Warranty Exclusions

This limited warranty does not cover cost of repairs made or attempted by anyone other than Concordia-authorized personnel. In the event of such unauthorized repairs, Concordia may void the limited warranty. In addition, this limited warranty does not apply if Concordia determines that a problem resulted from inadequate or improper maintenance, improper operations, unauthorized alterations or adjustments, or use of unapproved supplies. This includes, but is not limited to the following:

Evidence of abnormal wear and tear due to abuse, misuse, or improper maintenance;

Water used with the Goods that exceeds three grains of hardness per gallon or substantially similar standard;

Inoperative or dirty milk valves and milk pumps from improper maintenance;

Jammed or impacted coffee grinder caused by foreign objects in grinder;

Plugged drain;



Inoperative brew group due to improper maintenance;

Insufficient water supply and/or insufficient or incorrect power;

Improper recalibration due to the use of different coffee beans, type of milk or size of cups;

Relocation of the Goods from originally approved location;

Newly installed equipment which interferes with the operation of the Concordia unit;

In addition, the Goods must be cleaned properly each day it is used and operated only in accordance with instructions.

Except for the above limited warranty, Concordia disclaims and makes no performance representations, warranties, guarantees or conditions, either express or implied, oral or written, with respect to the Goods or any services provided, including without limitation any implied warranty, guarantee or condition (a) of merchantability, (b) of fitness for a particular purpose, or (c) arising from course of performance, course of dealing, or usage of trade. In no event shall Concordia's liability exceed the amount of the purchase price for the Goods.



CONCORDIA

COFFEE SYSTEMS

**Customer Service
USA (800) 778-0990**

**Concordia Coffee Systems
1287 120th Avenue NE
Bellevue, WA 98005
USA**