

KNOCHEN - CHIRURGIE
BONE SURGERY
CIRURGIA ORTOPEDICA
CHIRURGIE OSSEUSE

ELCON
MEDICAL INSTRUMENTS GmbH

ELCON
R1 - R100

390 - 419

**KNOCHEN - CHIRURGIE
BONE SURGERY
CIRURGIA ORTOPEDICA
CHIRURGIE OSSEUSE**

A

ADSON
 - cranial rongeur R76
 - periosteal elevator R24-26
 ALDERDYCE
 - dissector R15
 ALEXANDER
 - chisel R55
 - gouge R55
 ALEXANDER-FARABEUF
 - rib raspatory R37
 Amputation retractors R2
 Amputation saws R2
 Antrum raspatories R42
 AUFRANC-COBRA
 - bone lever R23
 AUFRICHT
 - nasal rasp R41

B

BACON
 - cranial rongeur R76
 BAILEY-DEMARTEL
 - saw guide R4
 Bandage scissors R9-12
 BARTH
 - bone curette, double-ended R44
 BEESON
 - cast breaker R13
 BENNET
 - bone lever R23
 BERGMANN
 - bandage scissor R9
 BERRY
 - tungstengrip wire twister R91
 BEYER
 - bone rongeur R74, R77
 BIER
 - amputation saw R2
 - saw blade R2
 BLOUNT
 - bone lever R22
 BLUMENTHAL
 - bone rongeur R74
 BOEHLER
 - bone cutting forceps R83
 - bone rongeur R77
 - traction bows R92
 Bone clamps R72
 Bone curettes R45-50
 - double-ended R43-45
 Bone cutting forceps R82-86
 Bone elevator R17
 Bone files R38-41
 Bone flap elevators R15
 Bone holding forceps R64-72
 Bone levers R17-R23
 Bone rasps R38-R40
 Bone rongeurs R73-R81
 Bone wire R90
 BRAND
 - tendon holding forceps R86
 BRISTOW
 - bone lever R22
 BRUNS
 - bandage scissor R10
 - bone curette R45, R47
 - plaster scissor R11
 BUCK-GRAMCKO
 - bone lever R17
 BUCKLEY
 - gouge R56

- osteotome R56
 BUECHS
 - raspatory R32
 BUNNEL
 - hand drill R88

C

CAIRNS
 - bone flap elevator R15
 CARROLL
 - osteotome R56
 - tendon seizing forceps R86
 Cartilage Clamps R64
 CASPAR
 - bone curette R48
 Cast Breakers R13
 CHARRIERE
 - amputation saw R3
 - saw blade R3
 Chisels R54-R56,
 R58, R61
 CLEVELAND
 - bone cutting forceps R82
 - bone rongeur R76
 COBB
 - spinal elevator R34
 - spinal gouge R62
 Combi flat nose pliers R94
 Compression
 - bandage R1
 - tube R1
 Comprimeter R1
 CORWIN
 - wire twisting forceps with tungstengrip R91
 COTTLE
 - elevator R29
 - nasal rasp R41
 - osteotome R57
 COTTLE-MC KENTY
 - elevator R29
 Cranial rongeurs R76
 Cuff
 - for the arm R1
 - for the leg R1
 - for children R1
 CUSHING
 - elevator R25
 - raspatory R24-26

D

DEMEL
 - wire guide R90
 - wire tightening forceps R90
 DINGMANN
 - cartilage clamp R64
 Dissectors R15
 DOYEN
 - mallet R50
 - rib raspatory R36
 Drill handles R87
 Drills R88

E

EAST GRINSTEAD
 - chisel R56
 - osteotome R56
 ECHLIN
 - bone rongeur R80
 Electric plaster saw R6-8

Elevators	R14-17,	HEY-GROVES	
R25,	R27-29	- bone holding forceps	R69
Elevator, spinal	R36	HILL	
ENGEL		- elevator	R29
- plaster saw	R5	HOEN	
ESMARCH		- elevator	R25
- bandage scissor	R9	HOHMANN	
- compression bandage, tube	R1	- bone lever	R17, R19-22
- plaster knife	R5	HOPKINS	
EXCENTRIC		- plaster knife	R5
- bandage scissor	R9	HOUSE	
Extracting forceps	R94	- bone curettes, double-ended	R43
		HOWARTH	
		- elevator	R28
F			
FARABEUF		I	
- bone holding forceps	R68	Interlacing forceps	R86
- raspatory	R32		
FARABEUF-COLLIN			
- raspatory	R32	J	
FARABEUF-LAMBOTTE		JACOBSON	
- bone holding forceps	R68	- bone curettes, double-ended	R44
FERGUSON		JANSEN	
- bone holding forceps	R65	- bone curettes, double-ended	R44
Finger nail instruments		- bone rongeur	R74
- compression	R98	- raspatory	R31
- extracting forceps	R98	JOSEPH	
- ring saw	R98	- nasal rasp	R42
- splitting forceps	R98	- raspatory	R30
Flat nose pliers	R94-R95		
FOMON with Tungstengrip		K	
- bone rasp	R40	KAZANJIAN	
FOMON (KLEINERT KUTZ)		- bone cutting forceps	R82
- bone rasp	R39	KERN	
FOMON-MASING		- bone holding forceps	R67
- bone rasp	R39	KEY	
Forceps		- periosteal raspatory	R33
- bone holding	R64-72	KILLIAN	
- reposition	R63-65	- elevator	R28
FREER		- gouge	R54
- chisel	R54	KILLIAN-CLAUS	
- elevator	R28	- gouge	R54
- gouge	R54	KIRSCHNER	
FREER-YASARGIL		- extension bow	R92
- elevator	R28	- wire	R93
FRIEDMANN		KLEINERT-KUTZ	
- bone rongeur	R73	- tendon seizing forceps	R86
		KOENIG	
		- elevator	R14, R24
G			
GERSTER		L	
- traction bar	R72	LAHEY	
GIGLI		- bone holding forceps	R66
- saw handle	R4	LAMBOTTE	
- wire saw	R4	- osteotome	R57
Glabella rasps	R41-43	- raspatory	R32
Gouges	R54-56, R58-62	LANDOLT	
		- raspatory	R29
		LANE	
H		- bone holding forceps	R67
HALLE		- bone lever	R22
- elevator	R27	LANE-THRETHOWAN	
Hammer	R50-54	- bone lever	R22
Hand drills	R88	LANGE-HOHMANN	
Handles for drill	R87	- bone lever	R18
HARTMANN		LANGENBECK	
- bone rongeur	R74	- bone holding forceps	R65
HEATH		- elevator	R16
- mallet	R51	- finger saw	R3
HENNING			
- cast breaker	R13		

- raspatory	R31	MINI-LEXER	
LEKSELL		- gouge	R60
- bone rongeur	R80	- osteotome	R60
LEMPERT		MITCHELLS	
- bone rongeur	R75	- raspatory	R32
- elevator	R30	MOLT	
- raspatory	R27	- periosteal elevator	R29
LEWIN		MURPHY-LANE	
- bone holding forceps	R64	- bone lever	R23
LEWIS			
- septum raspatory	R42		
LEXER		N	
- gouge	R60	Nail extracting forceps	R98
- osteotome	R60-62	Nail splitting forceps	R98
- spongiosa gouge	R61	Nasal rasps	R41-43
LISTER EXCENTRIC		NORTHFIELD	
- bandage scissor	R9, R11	- bone rongeur	R75
LISTON			
- bone cutting forceps	R82, R84		
LITTAUER-LISTON		O	
- bone cutting forceps	R82	OBWEGGESER- FREER	
LORENZ		- elevator	R28
- bandage scissor	R10	OLIVECRONA	
LOUTE		- bone rongeur	R76
- wire twisting instrument	R90	- wire saw	R4
LOVE-ADSON		OMBREDANNE	
- elevator	R24	- hammer	R51
LOWMAN		Osteotomes	R54-62
- bone clamp	R72		
LOWMAN-HOGLUND			
- bone clamp	R72		
LUCAE		P	
- mallet	R50	PARTSCH	
LUCAS		- chisel	R55
- chisel	R56	- gouge	R55
- gouge	R56	- mallet	R51
LUER		- raspatory	R26
- bone rongeur	R73, R75	PENNYBAKER	
		- raspatory	R25
M		PERCY	
Mallets	R50-54	- amputation retractor	R2
MALTZ		Periosteal elevators	R24, R26, R29-31, R35
- nasal rasp	R41	Periosteal raspatories	R25-31, R33
MARQUART		PERTHES	
- bone rongeur	R77	- reamer	R87
MARTIN		PHILIPS	
- plaster knife	R5	- screw driver	R89
MATSON		Plaster breakers	R12
- rib raspatory	R37	plaster knives and saw	R5
MAYFIELD		Plaster scissors	R9-12
- bone rongeur	R77	Plaster shears	R10, R12
MC DONALD		Plaster spreaders	R13
- dissector	R15	PLESTER	
MC INDOE		- raspatory	R26
- bone cutting forceps	R83	Pump with manometer	R1
MC KISSOCK		PUTTI	
- raspatory	R31	- bone rasp	R38
MEAD			
- bone rongeur	R75	Q	
- mallet	R50	QUERVAIN	
- periosteal elevator	R29	- elevator	R16
MEYER			
- reposition forceps	R63		
Micro elevators	R14	R	
MILLER		RADOLF	
- bone rasp	R39	- nail extracting forceps	R98
MINI FRIEDMANN		RALK	
- bone rongeur	R73	- hand drill	R88
MINI-LAMBOTTE		Raspatories	R24-28, R29-36
- osteotome	R57	Reamer	R87
MINI-LANGENBECK		REILL	
- elevator	R16		

- reposition forceps	R63
Reposition forceps	R63-65
Resection saw	R3
Rib raspatories	R36-38
ROETTGEN-RUSKIN	
- bone rongeur	R78
ROSE	
- raspatory	R26
ROWLAND	
- bone cutting rongeur	R83
RUBIO	
- wire twisting forceps with tungstengrip	R91
RUSKIN	
- bone rongeur	R78
RUSKIN-LISTON	
- bone cutting rongeur	R83
RUSKIN-STILLE	
- bone rongeur	R78

S

SATTERLEE	
- amputation saw	R3
- saw blade	R3
SAUERBRUCH	
- bone rongeur	R81
Saw	R2-7
Saw blades for electric saw	R8
Saw guides	R4
SCHEDE	
- bone curette	R46
SCHNEIDER	
- raspatory	R31
SCHNEIDER-SAUERBRUCH	
- raspatory	R31
SCOVILLE	
- bone curette	R49
Screw driver	R89
SEBILEAU	
- elevator	R14
SEDILLOT	
- raspatory	R31
SEMB	
- bone cutting forceps	R85
- bone holding forceps	R66
- bone rongeur	R79
- raspatory	R37
Septum raspatory	R42
Sequestrum forceps	R65
SEUTIN	
- bandage scissor	R10
SEWALL	
- raspatory	R27
SHEEHAN	
- osteotome	R54
SIMON	
- bone curette	R46
SMITH-PETERSON	
- gouge	R59
- osteotome	R59
Spinal curettes	R47
Spinal elevators	R34
Spinal gouges	R62
Spongiosa gouges	R61
SPINAL	
- bone curette	R47
SPRATT	
- bone curette	R46
ST. CLAIR THOMPSON	
- raspatory	R27
Steel wire	R90
STEINMANN	
- pin	R92

STELLBRINK	
- synovectomy rongeur	R73
STILLE	
- bone rongeur	R80
- chisel	R58
- gouge	R58
- osteotome	R58
- plaster shear	R12
STILLE-HORSLEY	
- bone cutting forceps	R85
STILLE LUER	
- bone rongeur	R79
STOOKEY	
- cranial rongeur	R76
Synovectomy rongeurs	R73

T

Tampers	R54
Tendon holding forceps	R86
Traction bar	R72
Traction bows	
- for the arm	R92
- for the leg	R92
- for thigh and knee	R92
TUDOR EDWARDS	
- bone cutting forceps	R85
Tungstencut	
- bandage scissors	R11
- wire cutting pliers	R96-98
- wire cutting scissors	R11
Tungstengrip	
- bone rasp	R40
- flat nose pliers	R94
- wire twister	R91, R94
Twist drills	R88

U

Universal wire cutting scissor	R11
ULRICH	
- bone holding forceps	R69
USA	
- plaster spreader	R13

V

VAN BUREN	
- bone holding forceps	R65
VERBRUGGE	
- bone holding forceps	R70
- bone lever	R20
VICKERS	
- mallet	R50
VOLKMANN	
- bone curettes	R45
- bone curettes, double-ended	R43-45

W

WAGNER	
- bone lever	R19
WARD	
- periosteal elevator	R26
WATSON-CHEYNE	
- dissector	R15
- elevator	R15
WATSON-JONES	
- bone lever	R22
WIENER	
- nasal rasp	R42
WILLIGER	

- bone curettes	R46
- bone curettes, double-ended	R43
- elevator	R14, R24
- mallet	R51
Wire cutting pliers	R94,
R96-98	
Wire cutting scissors	R11
Wire dispenser	R93
Wire guides	R90
Wire saw	R6
Wire tightener	R90
Wire twister	R91
Wires	
- double trocar point	R93
- trocar point / round shaft	R93
- trocar point / flat shaft	R93
WOLF-BOEHLER	
- plaster breaker	R12
Wrench	R8

Z

ZAUFAL-JANSEN	
- bone rongeur	R77

120		340-914	R24			410-120	R14	410-302	R24
121-099	R11	340-915	R24	400		410-121	R15	410-306	R24
121-905	R11	340-929	R25	400-201	R12	410-122	R16	410-3081	R27
121-917	R11	340-935	R25	400-203	R12	410-124	R16	410-3082	R27
124-225	R10	340-950	R25	400-211	R12	410-126	R16	410-3083	R27
124-227	R9	340-951	R25	400-300	R5	410-128	R16	410-3084	R27
124-251	R9	340-952	R25	400-310	R5	410-1291	R16	410-313	R29
124-253	R9	340-954	R24	400-331	R5	410-1292	R16	410-315	R26
124-261	R9	340-960	R25	400-410	R5	410-1293	R16	410-316-01	R26
124-305	R10	340-961	R25	400-450	R6	410-1294	R16	410-316-02	R26
124-321	R9	340-962	R25	400-452	R6	410-130	R16	410-318	R32
124-323	R9	340-963	R25	400-460-1	R8	410-132	R16	410-320	R32
124-331	R10	340-966	R24	400-460-2	R8	410-134	R16	410-324	R31
124-333	R10	341-620	R47	400-460-3	R8	410-140	R34	410-325	R31
		341-628	R47	400-461-1	R8	410-141	R34	410-327	R31
180		341-630	R47	400-461-2	R8	410-142	R34	410-330-04	R32
180-450	R15	341-638	R47	400-461-3	R8	410-143	R34	410-330-06	R32
180-451	R15	341-680	R49	400-462-1	R8	410-144	R34	410-330-08	R32
		341-681	R49	400-462-2	R8	410-145	R34	410-330-10	R32
		341-683	R49	400-468	R8	410-146	R34	410-330-12	R32
200		343-711	R76	400-469	R6	410-147	R34	410-330-14	R32
200-900	R91	343-711	R76	400-469	R7	410-148	R34	410-330-16	R32
200-902	R91	343-713	R76	400-470-1	R8	410-149	R34	410-331-04	R32
200-904	R91	343-713	R76	400-470-2	R8	410-151	R33	410-331-06	R32
200-906	R91	343-714	R76	400-471-1	R8	410-152	R33	410-331-08	R32
200-908	R91	343-781	R80	400-471-2	R8	410-153	R33	410-331-10	R32
200-910	R91	343-783	R80	400-472-1	R8	410-155	R33	410-331-12	R32
200-912	R91	343-785	R79	400-472-2	R8	410-156	R33	410-331-16	R32
200-914	R91			400-473-1	R8	410-160	R15	410-336	R32
200-922	R91	390		400-473-2	R8	410-165	R15	410-337	R32
200-926	R91	390-100	R1	400-478	R8	410-196	R23	410-340	R31
		390-105	R1	400-490	R7	410-197	R23	410-342	R31
250		390-120	R1	400-492	R7	410-200	R18	410-345	R31
250-900	R66	390-130	R1	400-495-1	R7	410-202	R18	410-346	R31
250-901	R66	390-300	R2	400-495-2	R7	410-204	R18	410-350	R32
251-002-20	R81	390-302	R2	400-495-3	R7	410-206	R19	410-351	R32
251-002-20	R81	390-400	R3	400-495-4	R7	410-210	R21	410-352	R32
251-004-20	R81	390-410	R3	400-500	R12	410-219	R19	410-353	R32
251-004-20	R81	390-411	R3	400-502	R12	410-220	R19	410-354	R32
251-100	R37	390-420	R3	400-515	R13	410-222	R19	410-359	R22
251-101	R37	390-421	R3	400-520	R13	410-228	R19	410-360	R22
251-102	R37	390-430	R3	400-530	R13	410-230	R20	410-368	R26
251-104	R37	390-431	R3			410-231	R20	410-369	R26
251-105	R37	390-432	R3	410		410-240	R20	410-380	R35
251-107	R37	390-440	R2	410-090	R14	410-241	R20	410-381	R35
251-122	R37	390-441	R2	410-092	R14	410-244	R21	410-382	R35
251-132	R36	390-442	R2	410-100	R17	410-246	R21	410-383	R35
251-133	R36	390-443	R2	410-102	R17	410-251	R22	410-384	R35
251-134	R36	390-500	R4	410-104	R17	410-253	R22	410-388	R35
251-135	R36	390-501	R4	410-105	R17	410-254	R22	410-393-01	R27
251-136	R36	390-512	R4	410-106	R17	410-256	R22	410-393-02	R27
251-136	R36	390-513	R4	410-107	R17	410-262	R22	410-395	R31
251-137	R36	390-514	R4	410-108	R17	410-265	R23	410-400	R38
251-140	R37	390-515	R4	410-109	R17	410-270	R23	410-402	R39
		390-516	R4	410-112	R14	410-271	R23	410-410	R38
340		390-517	R4	410-114	R14	410-285	R23	410-411	R38
340-835	R4	390-518	R4	410-116	R14	410-285	R35	410-420	R38
340-910	R25	390-519	R4	410-117	R14	410-286	R23	410-430	R39
340-912	R24	390-522	R4	410-119	R14	410-287	R23	410-431	R39
340-913	R24	390-524	R4			410-287	R35	410-432	R39
		390-526	R4			410-300	R24	410-450	R46

NUMERISCHER INDEX
 NUMERIC INDEX
 ÍNDICE NUMÉRO
 INDEX NUMERIQUE



410-451	R46	410-560	R46	410-629	R50	410-913	R55	411-160-25	R59
410-452	R46	410-561	R46	410-630	R47	410-914	R55	411-160-32	R59
410-453	R46	410-562	R46	410-631	R47	410-930	R55	411-161-06	R59
410-460	R44	410-563	R46	410-632	R47	410-931	R55	411-161-09	R59
410-462	R44	410-564	R46	410-632	R52	410-932	R55	411-161-13	R59
410-476	R43	410-565	R46	410-633	R47	410-933	R55	411-161-16	R59
410-477	R43	410-566	R46	410-634	R47	410-934	R55	411-161-19	R59
410-478	R43	410-5710	R46	410-634	R52	410-940	R55	411-161-25	R59
410-480	R43	410-5711	R46	410-635	R47	410-941	R55	411-161-32	R59
410-481	R43	410-5712	R46	410-636	R47	410-942	R55	411-162-06	R59
410-482	R43	410-5713	R46	410-637	R47	410-943	R55	411-162-09	R59
410-485	R44	410-5740	R45	410-637	R52	410-944	R55	411-162-13	R59
410-486	R44	410-5741	R45	410-638	R47	410-960	R55	411-162-16	R59
410-487	R44	410-5742	R45	410-646	R52	410-961	R55	411-162-19	R59
410-490	R43	410-5743	R45	410-648	R53	410-962	R55	411-162-25	R59
410-492	R43	410-5744	R45	410-656	R53	410-963	R55	411-162-32	R59
410-494	R43	410-5745	R45	410-660	R51	410-964	R55	411-163-06	R59
410-496	R44	410-5746	R45	410-668	R53	410-965	R55	411-163-09	R59
410-498	R44	410-5747	R45	410-670	R53	410-970	R55	411-163-13	R59
410-510	R45	410-5748	R45	410-671	R53	410-971	R55	411-163-16	R59
410-511	R45	410-5749	R45	410-682	R54	410-972	R55	411-163-19	R59
410-512	R45	410-5769	R45	410-683	R54	410-973	R55	411-163-25	R59
410-513	R45	410-5770	R45	410-684	R54	410-974	R55	411-163-32	R59
410-514	R45	410-5771	R45	410-685	R54	410-975	R55	411-200	R57
410-515	R45	410-5772	R45	410-686	R54	411-000	R60	411-201	R57
410-516	R45	410-5773	R45	410-688	R54	411-001	R60	411-202	R57
410-517	R45	410-5774	R45	410-689	R54	411-002	R60	411-203	R57
410-518	R45	410-5775	R45	410-690	R54	411-003	R60	411-204	R57
410-519	R45	410-5776	R45	410-720-04	R56	411-004	R60	411-205	R57
410-520	R47	410-5786	R45	410-720-06	R56	411-010	R60	411-206	R57
410-520	R47	410-583	R49	410-722-03	R56	411-011	R60	411-207	R57
410-521	R47	410-584	R49	410-722-05	R56	411-012	R60	411-210	R57
410-522	R47	410-585	R49	410-796	R58	411-013	R60	411-211	R57
410-523	R47	410-586	R49	410-798	R58	411-014	R60	411-212	R57
410-524	R47	410-593	R49	410-800	R58	411-020	R60	411-213	R57
410-525	R47	410-594	R49	410-802	R58	411-021	R60	411-214	R57
410-526	R47	410-595	R49	410-804	R58	411-022	R60	411-215	R57
410-527	R47	410-596	R49	410-806	R58	411-023	R60	411-216	R57
410-528	R47	410-604	R51	410-808	R58	411-024	R60	411-217	R57
410-528	R47	410-606	R51	410-816	R58	411-025	R60	411-220	R57
410-530	R47	410-607	R51	410-818	R58	411-030	R60	411-221	R57
410-530	R47	410-608	R51	410-820	R58	411-031	R60	411-222	R57
410-531	R47	410-613	R51	410-822	R58	411-032	R60	411-223	R57
410-532	R47	410-614	R51	410-824	R58	411-033	R60	411-224	R57
410-533	R47	410-616	R51	410-826	R58	411-034	R60	411-225	R57
410-534	R47	410-618	R50	410-828	R58	411-035	R60	411-226	R57
410-535	R47	410-620	R47	410-836	R58	411-050	R61	411-227	R57
410-536	R47	410-620	R50	410-838	R58	411-051	R61	411-228	R57
410-537	R47	410-621	R47	410-840	R58	411-052	R61	411-229	R57
410-538	R47	410-622	R47	410-842	R58	411-053	R61	411-230	R57
410-538	R47	410-623	R47	410-844	R58	411-054	R61	411-231	R57
410-540	R45	410-623	R50	410-846	R58	411-055	R61	411-232	R57
410-541	R45	410-624	R47	410-848	R58	411-080	R62	411-240	R57
410-542	R45	410-624	R50	410-900	R55	411-081	R62	411-241	R57
410-543	R45	410-625	R47	410-901	R55	411-082	R62	411-242	R57
410-544	R45	410-625	R50	410-902	R55	411-083	R62	411-243	R57
410-545	R45	410-626	R47	410-903	R55	411-160-06	R59	411-244	R57
410-546	R45	410-626	R50	410-904	R55	411-160-09	R59	411-245	R57
410-547	R45	410-627	R47	410-910	R55	411-160-13	R59	411-246	R57
410-548	R45	410-628	R47	410-911	R55	411-160-16	R59	411-247	R57
410-549	R45	410-628	R50	410-912	R55	411-160-19	R59	411-248	R57

411-249	R57	411-392	R69	411-621	R78	412-540	R87	413-179	R94
411-250	R57	411-392	R69	411-624	R78	412-580	R87	413-186	R96
411-251	R57	411-393	R69	411-625	R78	412-581	R87	413-192	R96
411-252	R57	411-394	R69	411-625	R78	412-586	R87	413-193-15	R96
411-2602	R56	411-394	R69	411-631	R78	412-588	R87	413-193-18	R96
411-2603	R56	411-395	R69	411-632	R78	412-600	R89	413-195	R96
411-2604	R56	411-400	R72	411-633	R78	412-601	R89	413-198	R97
411-2612	R56	411-401	R72	411-641-03	R80	412-602	R89	413-199	R97
411-2613	R56	411-402	R72	411-641-05	R80	412-603	R89	413-202	R97
411-2614	R56	411-403	R72	411-641-08	R80	412-604	R89	413-600	R92
411-2620	R61	411-411	R72	411-645-03	R80	412-606	R89	413-601	R92
411-2621	R61	411-412	R72	411-645-05	R80	412-608	R89	413-602	R92
411-2622	R61	411-450	R72	411-645-08	R80	412-610	R89	413-650	R92
411-2623	R61	411-503	R74	411-651	R80	412-702-10	R88	413-651	R92
411-2624	R61	411-505	R73	411-660	R79	412-702-15	R88	413-661	R92
411-2625	R61	411-507	R73	411-661	R79	412-702-20	R88	413-662	R92
411-2626	R61	411-509	R73	411-670	R79	412-702-25	R88	413-663	R92
411-2627	R61	411-510	R74	411-671	R79	412-702-28	R88	414-643	R48
411-2628	R61	411-511	R74	411-672	R79	412-702-30	R88	414-643	R48
411-2629	R61	411-513	R74	411-673	R79	412-702-32	R88	414-644	R48
411-300	R65	411-520	R75	411-681	R79	412-702-35	R88	414-645	R48
411-301	R65	411-521	R75	411-700	R82	412-702-40	R88	414-653	R48
411-303	R63	411-522	R75	411-701	R82	412-702-45	R88	414-654	R48
411-3046	R63	411-523	R75	411-702	R82	412-702-50	R88	414-655	R48
411-305	R65	411-527	R74	411-703	R82	412-702-60	R88	414-734	R48
411-307	R63	411-529	R74	411-704	R82	413-002	R90	414-735	R48
411-308	R63	411-535	R76	411-705	R82	413-003	R90	414-743	R48
411-309	R64	411-539	R73	411-706	R82	413-004	R90	414-743	R48
411-310	R64	411-541	R73	411-707	R82	413-005	R90	414-744	R48
411-313	R63	411-543	R73	411-710	R82	413-006	R90	414-744	R48
411-316	R66	411-546	R75	411-749	R82	413-007	R90	414-754	R48
411-317	R66	411-547	R75	411-751	R82	413-008	R90	414-755	R48
411-318	R66	411-548	R75	411-800	R83	413-009	R90	414-756	R48
411-319	R64	411-549	R75	411-801	R83	413-010	R90	416-0508	R92
411-320	R65	411-553	R75	411-810	R83	413-012	R90	416-0510	R92
411-322	R65	411-567	R74	411-811	R83	413-015	R90	416-0512	R92
411-324	R65	411-565	R74	411-820	R83	413-062	R90	416-0514	R92
411-330	R64	411-569	R74	411-821	R83	413-065	R90	416-0515	R92
411-340	R68	411-570-01	R73	411-822	R83	413-072	R90	416-0516	R92
411-341	R68	411-570-02	R73	411-823	R83	413-100	R90	416-0518	R92
411-342	R68	411-570-03	R73	411-829	R84	413-120	R90	416-0520	R92
411-345	R69	411-570-04	R73	411-830	R84	413-130	R95	416-0521	R92
411-346	R69	411-575	R73	411-831	R84	413-134	R95	416-0525	R92
411-347	R69	411-577	R73	411-833	R84	413-135	R95	416-0530	R92
411-350	R67	411-583	R75	411-840	R85	413-140	R96	419-0038	R93
411-351	R67	411-589	R75	411-850	R85	413-146	R96	419-0040	R93
411-352	R67	411-593	R76	412-006	R98	413-150	R94	419-0042	R93
411-353	R67	411-595	R76	412-010	R98	413-152	R94	419-0044	R93
411-356	R67	411-600	R77	412-033	R98	413-153	R94	419-0045	R93
411-357	R67	411-601	R77	412-034	R98	413-154	R94	419-0046	R93
411-370	R70	411-602	R77	412-090SS	R98	413-158	R95	419-0048	R93
411-371	R70	411-603	R77	412-127	R86	413-160	R95	419-0050	R93
411-372	R70	411-605	R77	412-158	R86	413-161	R95	419-0052	R93
411-373	R70	411-611	R77	412-159	R86	413-165	R95	419-0055	R93
411-375	R71	411-613	R77	412-180	R86	413-170	R94	419-0060	R93
411-376	R71	411-614	R77	412-182	R86	413-171	R94	419-0138	R93
411-377	R71	411-615	R77	412-196	R86	413-172	R94	419-0140	R93
411-378	R71	411-617	R77	412-412	R87	413-173	R94	419-0142	R93
411-379	R71	411-619	R77	412-500	R88	413-174	R94	419-0144	R93
411-390	R69	411-620	R78	412-510	R88	413-177	R94	419-0145	R93
411-391	R69	411-620	R78	412-520	R88	413-178	R94	419-0146	R93

419-0148	R93	419-2210	R93	440-544	R56	450-520	R41
419-0150	R93	419-2212	R93	440-546	R56	450-530	R41
419-0152	R93	419-2214	R93	440-591	R54	450-531	R41
419-0155	R93	419-2215	R93	440-593	R54	450-531	R41
419-0160	R93	419-2216	R93	440-602	R28	450-540	R39
419-0308	R93	419-2218	R93	440-603	R28	450-542	R39
419-0310	R93	419-2220	R93	440-611	R27	450-548	R39
419-0312	R93	419-2222	R93	440-612	R27	450-590	R40
419-0314	R93	419-2225	R93	440-614	R26	450-591	R40
419-0315	R93	419-2230	R93	440-615	R28	450-592	R40
419-0316	R93	419-2308	R93	440-616	R28	450-593	R40
419-0318	R93	419-2310	R93	440-618	R27	450-594	R40
419-0320	R93	419-2312	R93	440-620	R28	450-698	R30
419-0322	R93	419-2314	R93	440-621	R28	450-700	R30
419-0325	R93	419-2315	R93	440-626	R28	450-701	R30
419-0330	R93	419-2316	R93	440-627	R28	450-702	R30
419-1138	R93	419-2318	R93	440-636	R27	450-703	R30
419-1140	R93	419-2320	R93	440-637	R27	450-706	R30
419-1142	R93	419-2322	R93	440-660	R29	450-707	R30
419-1144	R93	419-2325	R93	440-665	R29	450-708	R29
419-1145	R93	419-2330	R93	440-666	R29	450-732	R29
419-1146	R93	419-5418-08	R93	441-111	R42	450-733	R29
419-1148	R93	419-5418-10	R93	441-113	R42	450-740	R26
419-1150	R93	419-5418-12	R93	441-290	R46	450-741	R26
419-1152	R93	419-5418-14	R93	441-291	R46	451-120	R82
419-1155	R93	419-5418-16	R93	441-292	R46	452-270	R28
419-1160	R93	419-5418-18	R93	441-293	R46	452-271	R28
419-1308	R93	419-5418-20	R93	441-294	R46	453-103	R56
419-1310	R93	419-5418-22	R93	441-295	R46	453-105	R56
419-1312	R93	419-5418-25	R93	441-296	R46	453-113	R56
419-1314	R93	419-5433-08	R93	441-297	R46	453-115	R56
419-1315	R93	419-5433-10	R93				
419-1316	R93	419-5433-12	R93	450		470	
419-1318	R93	419-5433-14	R93	450-302	R54	470-930	R15
419-1320	R93	419-5433-16	R93	450-304	R54		
419-1322	R93	419-5433-18	R93	450-306	R54		
419-1325	R93	419-5433-20	R93	450-308	R54		
419-1330	R93	419-5433-22	R93	450-310	R54		
419-2038	R93	419-5433-25	R93	450-312	R54		
419-2040	R93			450-319	R57		
419-2042	R93	430		450-320	R57		
419-2044	R93	431-480-01	R43	450-321	R57		
419-2045	R93	431-481-01	R43	450-322	R57		
419-2046	R93	431-481-02	R43	450-323	R57		
419-2048	R93	431-481-03	R43	450-324	R57		
419-2050	R93	431-481-04	R43	450-325	R57		
419-2052	R93	431-482-01	R43	450-326	R57		
419-2055	R93	431-515	R30	450-328	R57		
419-2060	R93	431-517	R30	450-330	R57		
419-2138	R93			450-332	R57		
419-2140	R93			450-334	R57		
419-2142	R93	440		450-335	R57		
419-2144	R93	440-500	R54	450-336	R57		
419-2145	R93	440-501	R54	450-337	R57		
419-2146	R93	440-504	R54	450-500	R42		
419-2148	R93	440-530	R56	450-501	R42		
419-2150	R93	440-532	R56	450-510	R41		
419-2152	R93	440-534	R56	450-512	R42		
419-2155	R93	440-536	R56	450-513	R42		
419-2160	R93	440-540	R56	450-518	R41		
419-2208	R93	440-542	R56	450-519	R41		

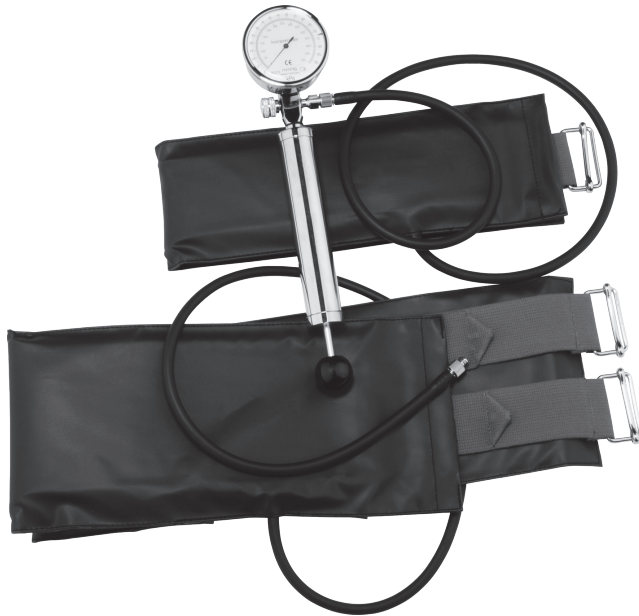

390-100

Komprimeter zur Erzeugung einer Bluteleere in den Extremitäten, Manometer mit Meßbereich bis 700mm Hg. Komplett bestehend aus:

- 390-102 1 Oberarm Manschette
- 390-103 1 Oberschenkel Manschette
- 390-101 1 Luftpumpe
- 390-104 1 Manometer

Comprimeter: Compression apparatus for producing exsanguination in the extremities. Manometer registers up to 700mm Hg. Complete consisting of:

- 390-102 1 Cuff for the arm
- 390-103 1 Cuff for the leg
- 390-101 1 Pump
- 390-104 1 Manometer

Torniquete para producir una isquemia local en las extremidades. Manómetro ajustado hasta 700mm Hg. Completo, compuesto de:

- 390-102 1 Brazaletes para el brazo
- 390-103 1 Brazaletes para el muslo
- 390-101 1 Bomba de aire
- 390-104 1 Manómetro

Appareil compresseur permettant de créer une ischémie dans les extrémités. Manomètre ajusté jusqu'à 700mm Hg. Complet, composé de:

- 390-102 1 Manchette pour las cuisse
- 390-103 1 Manchette pour la bras
- 390-101 1 Pompe à air
- 390-104 1 Manomètre

390-105

Kindermanschette
Cuff for children
Brazaletes para niños
Manchette pour les enfants



ESMARCH 390-120

Staubinde 5m lang und 60mm breit
Compression bandage 5m long and 60mm wide
Venda-compresión 5m largo y 60mm ancho
Bande compressive 5m long et 60mm large



ESMARCH 390-130

Stauschlauch 1m lang
Compression tube 1m long
Tubo-compresión 1m largo
Tube compressive 1m long



**PERCY
390-300**

Griff abnehmbar
Removable handles
Mangos desmontables
Manches démontables

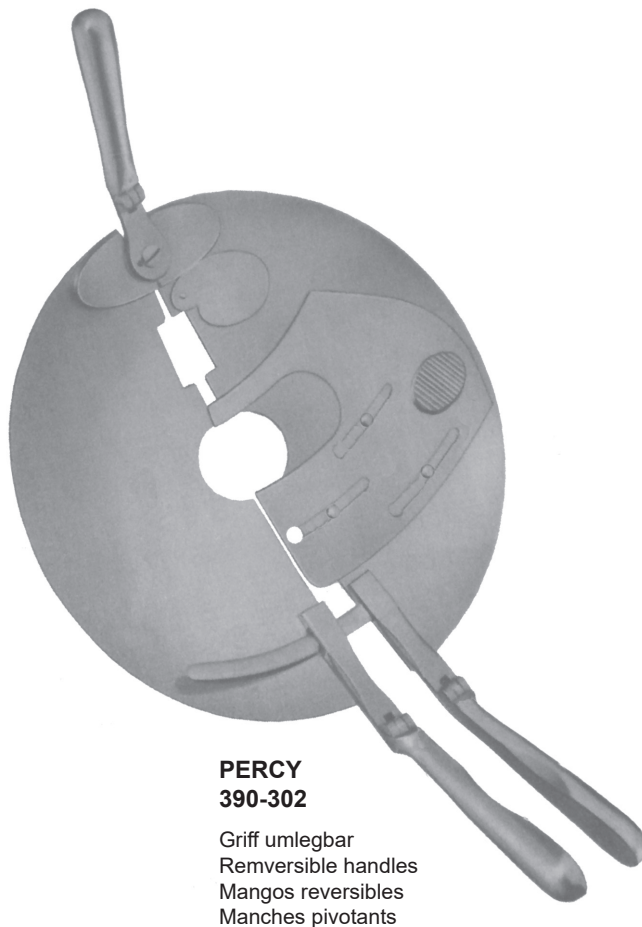

**PERCY
390-302**

Griff umlegbar
Remversible handles
Mangos reversibles
Manches pivotants



390-441 4mm
390-442 6mm
390-443 8mm

Sägeblatt
Saw blade
hoja
lame

**BIER
390-440**
390mm, 15 3/8"

komplett mit je 1 Sägeblatt 4mm, 6mm, 8mm
complete with 1 each saw blade 4mm, 6mm, 8mm
completo con 1 hoja de 4mm, 6mm, 8mm
complet avec 1 lame de 4mm, 6mm, 8mm



LANGENBECK
390-400 235mm, 9 1/2"



CHARRIERE
390-410 270mm, 10 3/4"

390-411

Sägeblatt
Saw blade
hoja
lame

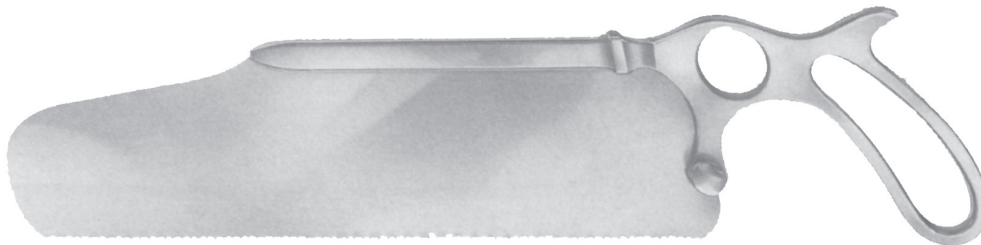

SATTERLEE
390-420 300mm, 12"

390-421

Sägeblatt
Saw blade
hoja
lame



CHARRIERE
390-430 350mm, 13 3/4"

komplett mit je 1 Sägeblatt 12mm, 18mm
complete with 1 each saw blade 12mm, 18mm
completo con 1 hoja de 12mm, 18mm
complet avec 1 lame de 12mm, 18mm

390-431 12mm
390-432 18mm

Sägeblatt
Saw blade
hoja
lame



BAILEY-DEMARTEL
340-835
330mm, 13"

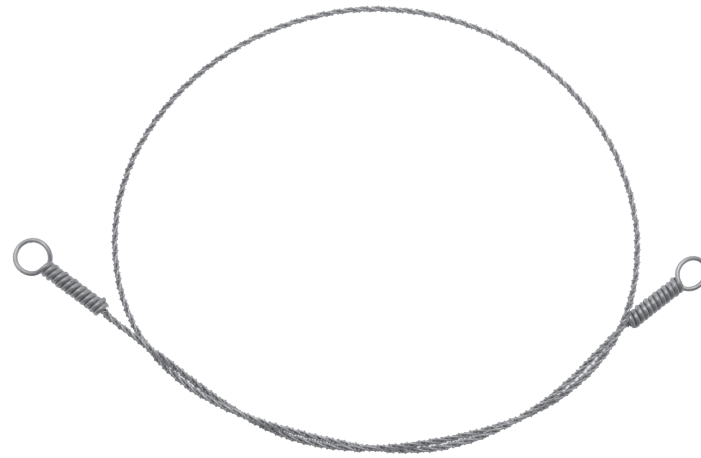

OLIVECRONA

- 390-512** 300mm, 12"
- 390-514** 400mm, 16"
- 390-516** 500mm, 20"
- 390-518** 700mm, 28"

GIGLI

- 390-522** 300mm, 12"
- 390-524** 400mm, 16"
- 390-526** 500mm, 20"

OLIVECRONA

- 390-513** 300mm, 12"
- 390-515** 400mm, 16"
- 390-517** 500mm, 20"
- 390-519** 700mm, 28"

Packung zu 10 Stück
Package of 10 ea
Paquete con 10 pieza
Unité à 10 pieces

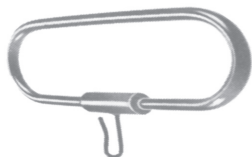

GIGLI
390-501

Paar
pair
paire
par

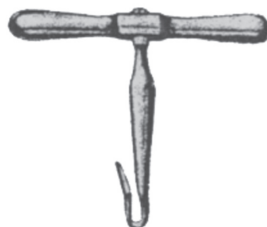

GIGLI
390-500

Paar
pair
paire
par



MARTIN
400-331 210mm, 8 1/4"



ENGEL
400-410 150mm, 6"

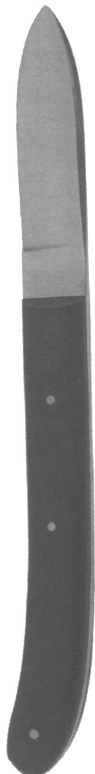

HOPKINS
400-300 200mm, 8"

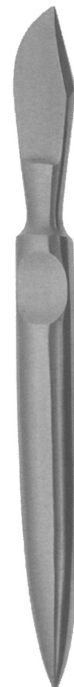

ESMARCH
400-310 180mm, 7"

400-450 Plaster Saw, 230 V / 50-60 Hz

400-452 Plaster Saw, 110 V / 50-60 Hz

complete with:

- 1 x sawblade Ø 50mm for standard plaster (400-460-1)
- 1 x sawblade Ø 65mm (400-461-1)
- 1 x pair of wrenches
- 1 x instruction manual

TECHNICAL DATA

- 500 Watt power
- 6500 bis 24000 oscillations, infinitely variable
- Fully automatic power-compensation
- Slim motor design with silent motor 52 – 77 dB(A)
- Soft Start at switch-on to minimize accident risk and to save all mechanical and electrical components
- Safety ON / OFF switch
- Weight only 1,25 kg without cable
- Vibration- and maintenance-free
- 5 meter cable with EU-connection, 230 Volt
3 meter cable with US-connection, 110 Volt
- Double protection isolation according to class II, medical use of type BF
- Radio and TV suppressed
- CE conformity
- EN 60601-1, EN 60601-1-2, IEC 60601-1,
- 2 years warranty / 1 year guarantee on engine and transmission part (in case of proper use)



400-469 Transport case, plastic

400-450 Sierra de yeso electrica, 230 V / 50-60 Hz

400-452 Sierra de yeso electrica, 110 V / 50-60 Hz

Completo con:

- 1 x hoja Ø 50mm para yeso normal (400-460-1)
- 1 x hoja Ø 65mm para yeso normal (400-461-1)
- 1 x Juego de llaves 11mm / 1 x manual de instrucciones

DATOS TECNICOS

- 500 vatios potencia
- 6500 hasta 24000 oscilaciones, infinitamente regulable
- Compensación de alimentación automática
- Delgado diseño del motor con motor silencioso 52-77 dB(A)
- Nuevo sistema electronica con varias funciones de protección y seguridad
- Conector de seguridad ON / OFF
- Peso solamente 1,25 kg sin cable
- Sin vibraciones y mantenimiento
- 5 metros de cable con conexión EU, 230 voltios
3 metros de cable con conexión US, 110 voltios
- Isolación doble protección según clase II, uso medical del tipo BF
- TV y radio suprimido / Conformidad de CE
- Testado según EN 60601-1, EN 60601-1-2, IEC 60601-1,
- 2 años de garantía / 1 año de garantía al motor & parte de transmisión (en caso de uso adecuado)

400-469 Maleta de transporte, plástica

400-450 Scie à plâtre, 230 V / 50-60 Hz

400-452 Scie à plâtre, 110 V / 50-60 Hz

complète avec :

- 1 x lame de scie Ø 50mm (400-460-1)
- 1 x lame de scie Ø 65mm (400-461-1)
- 1 x paire de clés 11mm / 1 x mode d'emploi

DATES TECHNIQUES

- puissance 500 watt
- 6500 à 24000 oscillations, réglable en continu
- compensation autom. de puissance
- design mince du moteur avc. moteur silencieux 52-77dB(A)
- démarrage doux pour réduire risque d'accident et pour protéger les éléments mécaniques et électroniques
- commutateur de sécurité ON / OFF
- poids seulement 1,25 kg, sans câble
- exempt de vibrations et entretien pas nécessaire
- câble de 5 m avec connexion CE, 230 volt
câble de 3 m avec connexion USA, 110 volt
- protection double d'isolation conformément à classe II, utilisation médicale type BF
- ondes radio et TV supprimées / conformité CE
- conformité EN 60601-1, EN 60601-1-2, IEC 60601-1,
- 2 ans de garantie / 1 an pour moteur et élément de transmission (lors d'utilisation conforme)

400-469 Mallette en plastique, pour transport



400-490 Plaster Saw (400-450) with dust collector, 230 V / 50-60 Hz
400-492 Plaster Saw (400-452) with dust collector, 110 V / 50-60 Hz

complete with:

- 1 x sawblade Ø 50mm for standard plaster (400-460-1)
- 1 x sawblade Ø 65mm (400-461-1)
- 1 x pair of wrenches / 1 x HEPA Filter

TECHNICAL DATA - dust collector

- 400 - 750 Watt power, vacuum motor
- Continuous Power Output max. 1200 Watt,
- Max. Power Output 1450 Watt PT,
- HEPA-Filter 99,97% of all particles which are >= 0,3 micron are filtered
- Automatic turn on/off of the cleaner with the turn on/off of the plaster saw
- When plaster saw is turned off, the cleaner will go off 6-10 sec. later to clean the whole system
- Max. vacuum 2100mm/H2O, vacuum motor
- Max. vacuum 1900mm/H2O, vacuum machine
- Air flow motor 62 lt./sec. in the machine, due to all the filters the air flow goes down to 40 lt./sec.
- Electronic power control 500 W – 1200 W
- Max. total power (system) 1600 Watt, controlled
- Noise level vacuum only, 63 – 69 dB(A)
- Antistatic cleaner tube
- Control lamp for full dust bag
- Cleaner tube is in the pipe and not on the floor

400-495-1 HEPA Filter

400-495-2 Dust Bag

400-495-3 Perfume Stick

400-495-4 Motor Filter

400-490 Sierra de yeso electrica (400-450) con aspirador, 230 V
400-492 Sierra de yeso electrica (400-450) con aspirador, 110 V

Completo con:

- 1 x hoja Ø 50mm para yeso normal (400-460-1)
- 1 x hoja Ø 65mm para yeso normal (400-461-1)
- 1 x Juego de llaves 11mm / 1 x manual de instrucciones

DATOS TECNICOS - con aspirador

- 400 - 750 vatios potencia, motor vacío
- Potencia continua de salida max. 1200 vatios
- Max. potencia de salida 1450 vatios PT
- Filtro HEPA 99,97% de todas las partículas cuales son >= 0,3 micron son filtradas
- Encendido / Apagado automático de la aspiradora junto con encendido / apagado de la sierra de yeso
- Cuando la sierra de yeso esta apagada la aspiradora se apagará 6-10 sec. después para limpiar todo el sistema
- Max. vacío 2100mm/H2O, motor vacío
- Max. vacío 1900mm/H2O, maquina vacío
- Flujo del aire del motor 62 lt./sec. en la maquina debido a los filtros el flujo del aire se baja a 40 litros./sec.
- Control electronico de potencia 500 vatios – 1200 vatios
- Max. potencia total (sistema) 1600 vatios, controlado
- Nivel de ruido solo del vacío 63 – 69 dB(A)
- Tubo del aspirador antiestático
- Lampara de control para bolsa de polvo
- Manguera del aspirador es dentro del tubo y no al suelo

400-495-1 Filtro HEPA

400-495-2 Bolsa de polvo

400-495-3 Palo de perfume

400-495-4 Filtro para el motor

400-469 Maleta de transporte, plástica (solo sierra)

400-490 Scie à plâtre (400-450) avec aspirateur, 230 V / 50-60 Hz
400-492 Scie à plâtre (400-450) avec aspirateur, 110 V / 50-60 Hz

complète avec :

- 1 x lame de scie Ø 50mm (400-460-1)
- 1 x lame de scie Ø 65mm (400-461-1)
- 1 x paire de clés 11mm / 1 x mode d'emploi

DATES TECHNIQUES - aspirateur

- puissance 400 - 750 watt, moteur vacuum
- sortie puissance continue max. 1200 watt
- sortie puissance max. 1450 Watt PT
- filtre HEPA - filtration de 99,97% de tous particles >= 0,3 micron
- démarrage / arrêt automatique de l'aspirateur dépendant du démarrage / de l'arrêt de la scie
- pour nettoyage du système entier, l'aspirateur s'arrête avec une temporisation de 6-10 sec. après arrêt de la scie à plâtre
- construction robuste pour charge élevée
- vacuum max. 2100mm/H2O, moteur vacuum
- vacuum max. 1900mm/H2O, machine vacuum
- débit air moteur 62 lt./sec. dans la machine ; les filtres contenus réduisent ce débit à 40 lt./sec.
- commande puissance électronique 500 W – 1200 W
- puissance max. totale (système) 1600 Watt, contrôlée
- niveau du bruit - seulement vacuum 63 – 69 dB(A)
- lampe de contrôle pour sac collecteur poussière plein

400-495-1 Filtre HEPA

400-495-2 Sac collecteur poussière

400-495-3 Stick perfume

400-495-4 Filtre moteur

400-469 Mallette en plastique, pour transport



Sägeblätter, für standardgips
Saw Blades, for standard plaster
Hojas para yeso normal
Lames de scie, pour plâtre standard

400-462-1	Ø 45mm
400-460-1	Ø 50mm
400-461-1	Ø 65mm

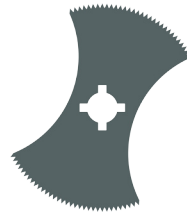

Sägeblätter, für standardgips
Saw Blades, for standard plaster
Hojas para yeso normal
Lames de scie, pour plâtre standard

400-470-1	Ø 65mm
-----------	--------

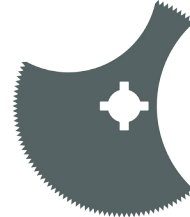

Sägeblätter, für standardgips
Saw Blades, for standard plaster
Hojas para yeso normal
Lames de scie, pour plâtre standard

400-471-1	Ø 65mm
-----------	--------

Sägeblätter, für synthetischengips
Saw Blades, for synthetic casts
HOJAS, para vendajes sintéticos
Lames de scie, pour bandage synthétique

400-462-2	Ø 45mm
400-460-2	Ø 50mm
400-461-2	Ø 65mm

Sägeblätter, für synthetischengips
Saw Blades, for synthetic casts
HOJAS, para vendajes sintéticos
Lames de scie, pour bandage synthétique

400-470-2	Ø 65mm
-----------	--------

Sägeblätter, für synthetischengips
Saw Blades, for synthetic casts
HOJAS, para vendajes sintéticos
Lames de scie, pour bandage synthétique

400-471-2	Ø 65mm
-----------	--------

Sägeblätter, PTFE antihaft beschichtet
Saw Blades, PTFE non-stick coating
HOJAS, antiadherente PTFE
Lames de scie, PTFE, avec revêtement anti-adhérent

400-460-3	Ø 50mm
400-461-3	Ø 65mm

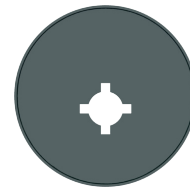

Excentrische Scheibe,
zur Schnitttiefenregulierung
Eccentric disc,
to limit cutting depth
Disco de Excéntrico
para limitar la profundidad del corte
Disque excentrique, pour
limitation de profondeur de coupe

400-478



Sägeblätter, für standardgips
Saw Blades, for standard plaster
Hojas para yeso normal
Lames de scie, pour plâtre standard

400-472-1	8mm
-----------	-----

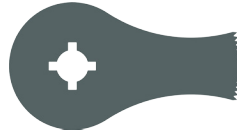

Sägeblätter, für standardgips
Saw Blades, for standard plaster
Hojas para yeso normal
Lames de scie, pour plâtre standard

400-473-1	20mm
-----------	------

Spannschlüssel 11mm
Wrench, pair 11mm
Juego de llaves 11mm
Clés, paire, 11mm



400-468

Sägeblätter, für synthetischengips
Saw Blades, for synthetic casts
HOJAS, para vendajes sintéticos
Lames de scie, pour bandage synthétique

400-472-2	8mm
-----------	-----

Sägeblätter, für synthetischengips
Saw Blades, for synthetic casts
HOJAS, para vendajes sintéticos
Lames de scie, pour bandage synthétique

400-473-2	20mm
-----------	------



ein Blatt gezahnt
one serrated blade
una hoja dentada
une lame dentelée

LISTER EXCENTRIC
124-261
160mm, 6 1/4"



124-251 180mm, 7"
124-253 140mm, 5 1/2"



BERGMANN
124-227
230mm, 9"



ESMARCH
124-321 200mm, 8"
124-323 220mm, 8 3/4"

ELCON 410

VERBANDSCHEREN, GIPSSCHEREN
BANDAGE SCISSORS, PLASTER SHEARS
TIJERAS PARA VENDAJES, TIJERAS PARA YESO
CISEAUX POUR PANSEMENTS, CISEAUX POUR PLÂTRE



LORENZ
124-225
240mm, 9 1/2"



SEUTIN
124-305
230mm, 9"



BRUNS
124-331
240mm, 9 1/2"



BRUNS
124-333
240mm, 9 1/2"



gezahnt
serrated
dentada
dentelée

DRAHTSCHEREN, VERBAND- UND GIPSSCHEREN
WIRE, BANDAGE AND PLASTER SCISSORS
TIJERAS PARA ALAMBRE, VENDAJES Y ENYESADOS
CISEAUX POUR FILS, PANSEMENTS ET PLATRES

ELCON
410

Scheren mit Hartmetallschneiden, Scissors with tungsten carbide edges
Tijeras con filos de carburo tungsteno, Ciseaux avec des lames en tungstène

TUNGSTENCUT



gezahnt
serrated edge
estriada
dentelés

UNIVERSAL
121-099
120mm, 4 3/4"



LISTER
121-905
180mm, 7"



BRUNS
121-917
240mm, 9 1/2"

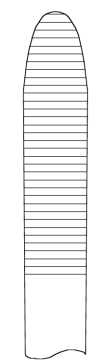
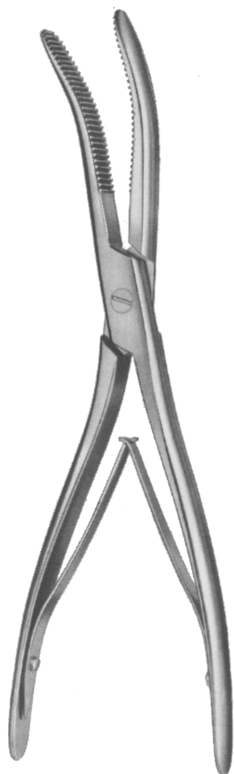

400-500



400-502

WOLF-BÖHLER

400-500 180mm, 7"

400-502 240mm, 9 1/2"

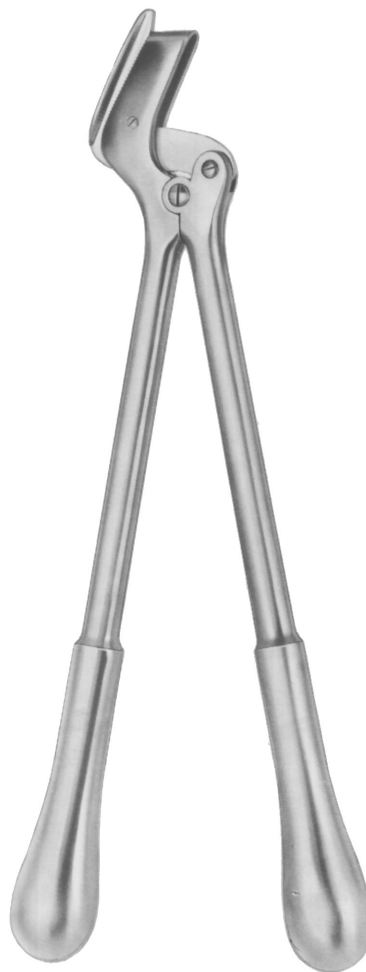

STILLE

400-201 230mm, 9"

400-203 260mm, 10 1/4"

400-211 380mm, 15 1/8"

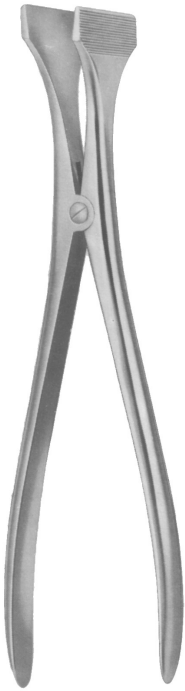

HENNING
400-520 270mm, 10 3/4"

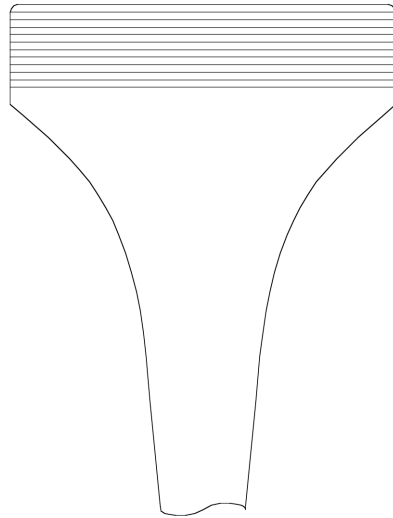

400-520
400-530



BEESON
400-530 300mm, 12"

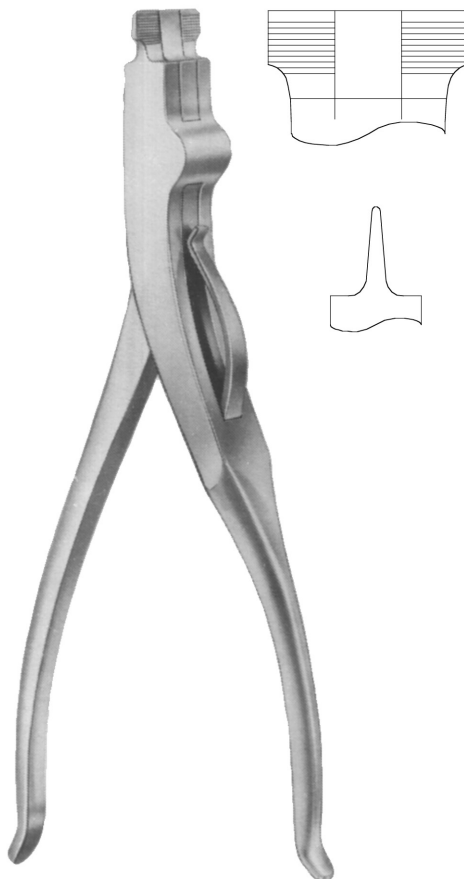

USA
400-515 230mm, 9"



410-090
170mm, 6 3/4"



410-092
160mm, 6 1/4"

5,5mm



**WILLIGER
410-112**
160mm, 6 1/4"

7mm



**WILLIGER
410-114**
160mm, 6 1/4"

5,5mm

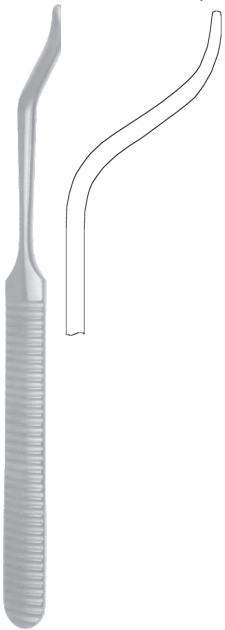

410-119
160mm, 6 1/4"

4,5mm

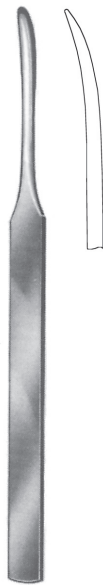

**KOENIG
410-116**
150mm, 6"

4,5mm

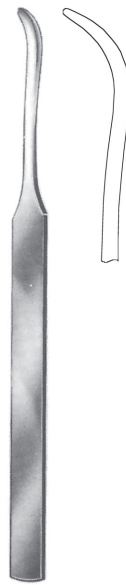

**KOENIG
410-117**
150mm, 6"

5mm



**SEBILEAU
410-120**
170mm, 6 3/4"



Mc DONALD
410-160
 190mm, 7 1/2"



9,5mm

10,5mm

WATSON-CHEYNE
410-165
 175mm, 6 7/8"



6mm



8mm

ALDERDYCE
470-930
 210mm, 8 1/4"



9mm



CAIRNS
410-121
 175mm, 6 3/4"



2mm

2mm



180-450 180-451
 130mm, 190mm,
 5 1/8" 7 1/2"



2,5mm

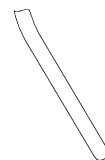

2,7mm

WATSON-CHEYNE
180-450 - 180-451

ELCON 410

ELEVATORIEN
ELEVATORS
ELEVADORES
ELÉVATEURS

6mm

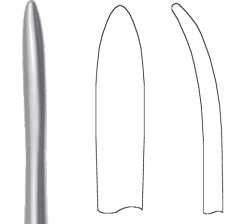

Hohlheft
Hollow Handle
Mango Hueco
Manche Creux



QUERVAIN
410-130
200mm, 8"

8mm

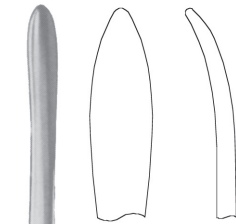

Hohlheft
Hollow Handle
Mango Hueco
Manche Creux



LANGENBECK
410-132
200mm, 8"

10mm

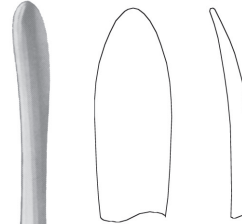

Hohlheft
Hollow Handle
Mango Hueco
Manche Creux



LANGENBECK
410-134
200mm, 8"

11mm



LANGENBECK
410-128
230mm, 9"



6mm

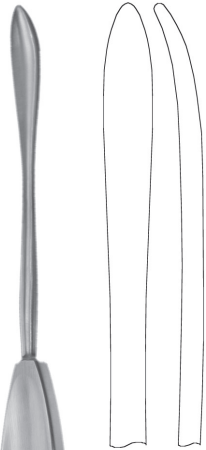

Vollergriff
Solid Handle
Mango Pleno
Manche Massive



QUERVAIN
410-126
200mm, 8"

8mm

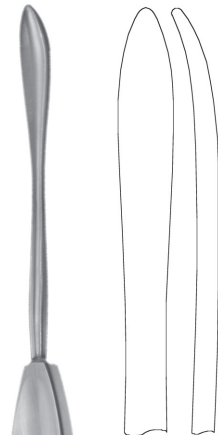

410-122
200mm, 8"



LANGENBECK
410-122 - 410-124

10mm

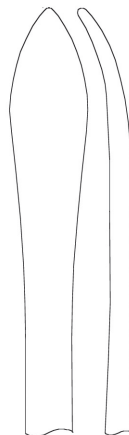

410-124
200mm, 8"

5mm



410-1291
170mm, 6 3/4"



MINI-LANGENBECK
410-1291 - 410-1294

7mm



410-1292
170mm, 6 3/4"

8mm



410-1293
170mm, 6 3/4"

10mm



410-1294
170mm, 6 3/4"

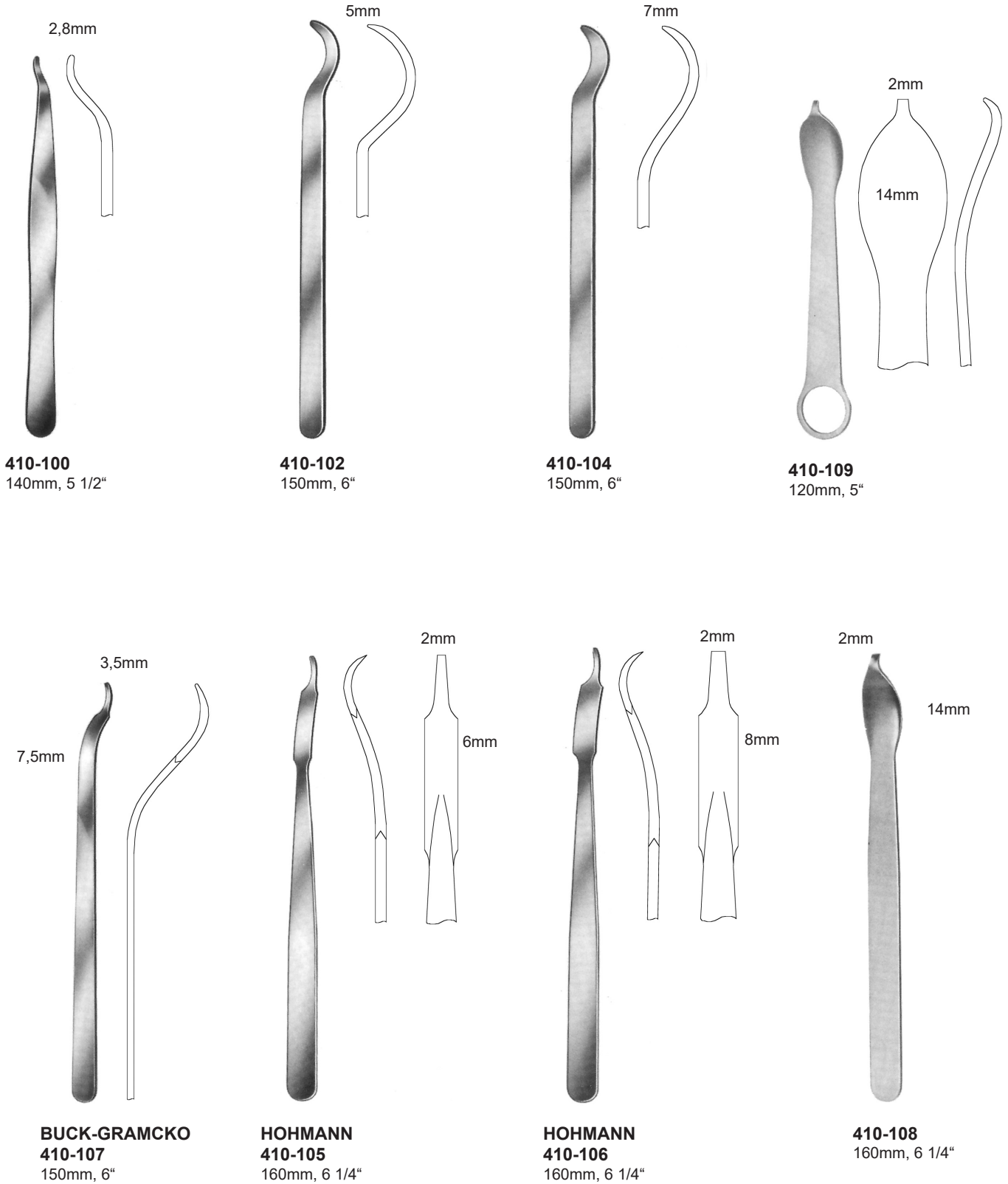

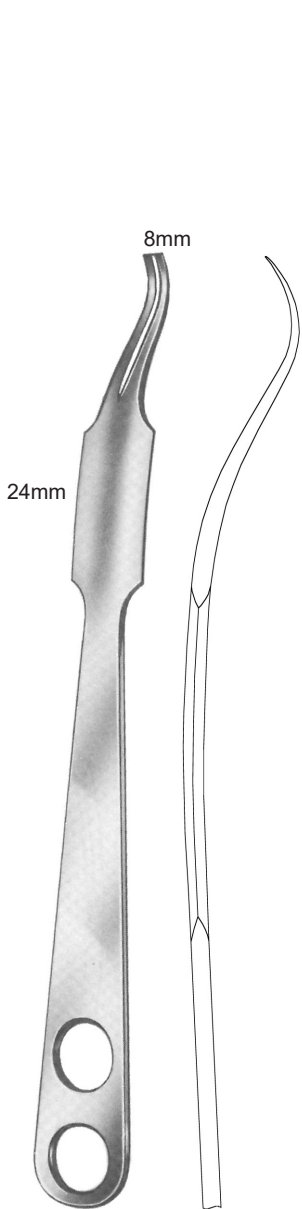

LANGE-HOHMANN
410-200
250mm, 10"

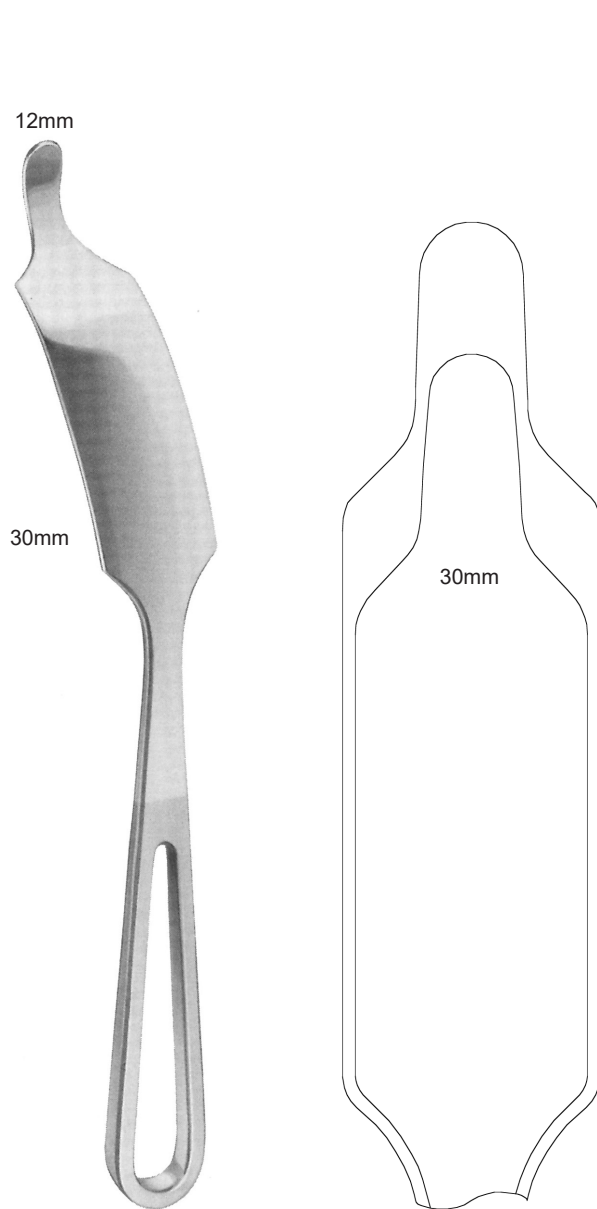

LANGE-HOHMANN
410-202
265mm, 10 1/2"

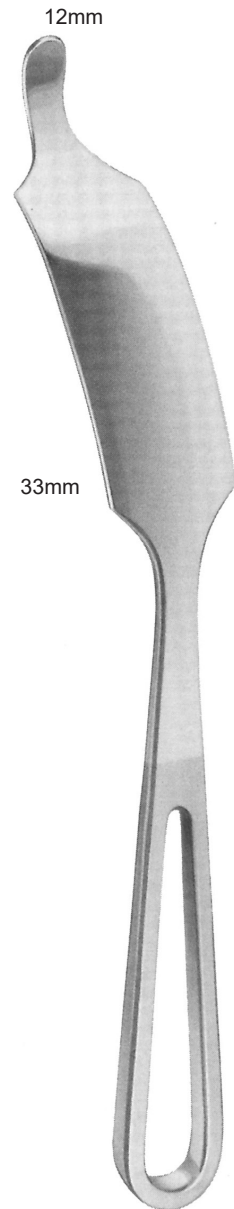

LANGE-HOHMANN
410-204
290mm, 11 1/2"

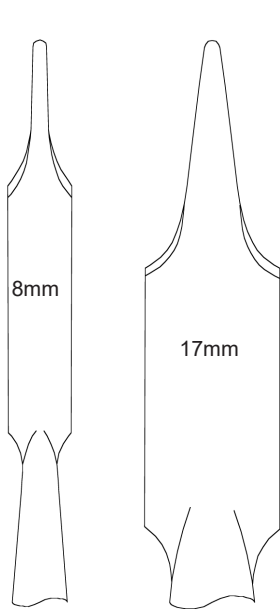

410-219

410-228

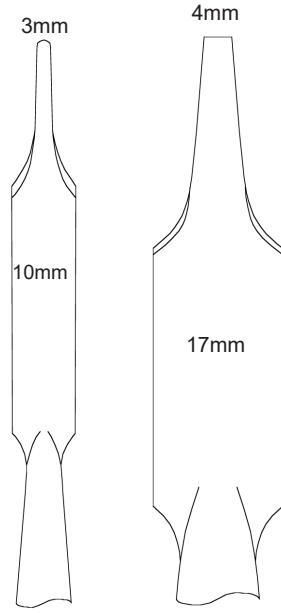

410-220

410-222

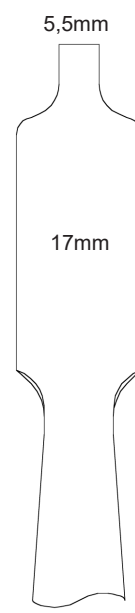

410-206

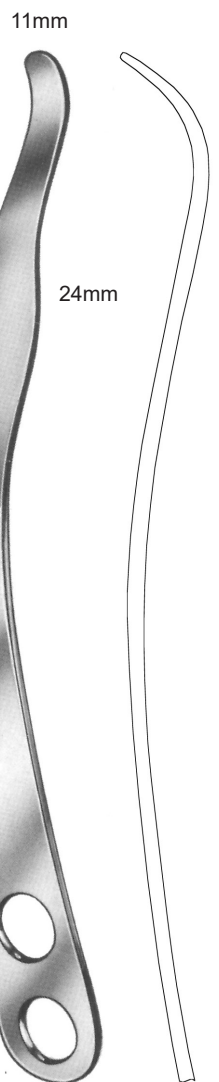

410-226
 270mm, 10 5/8"

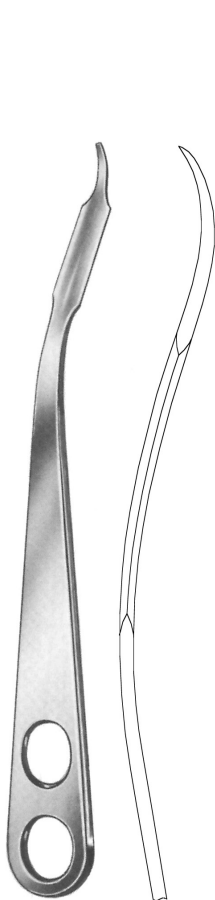

HOHMANN

410-219 220mm, 8 3/4"

410-228 240mm, 9 1/2"

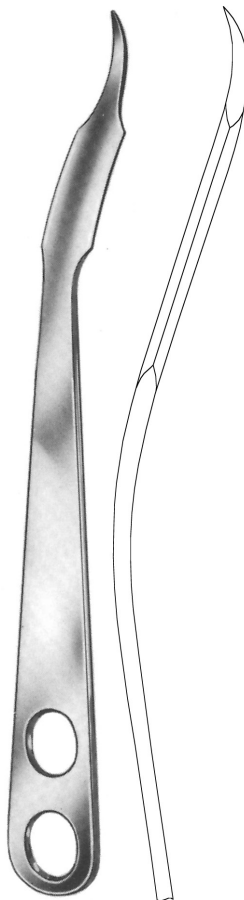

HOHMANN

410-220 220mm, 8 3/4"

410-222 240mm, 9 1/2"

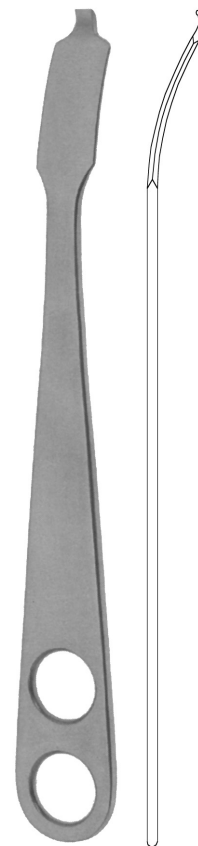

WAGNER

410-206
 220mm, 8 3/4"

ELCON 410

KNOCHENHEBEL
BONE LEVERS
ELEVADORES PARA HUESO
LEVERS À OS

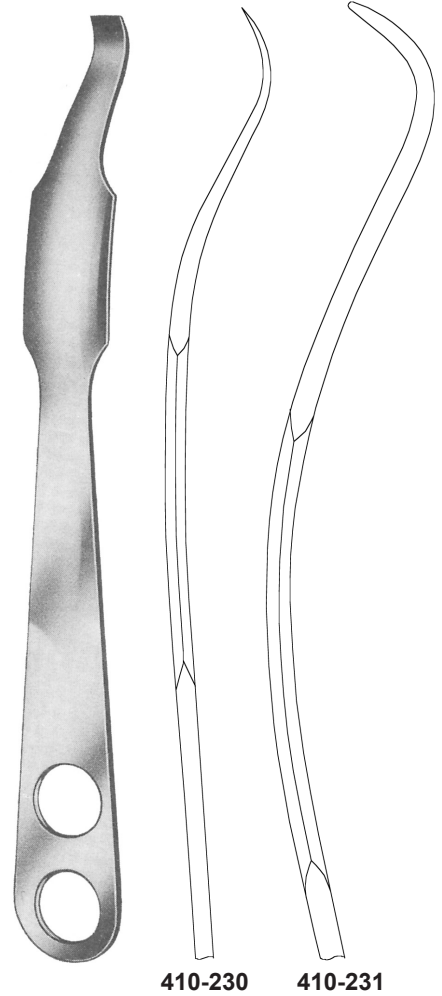
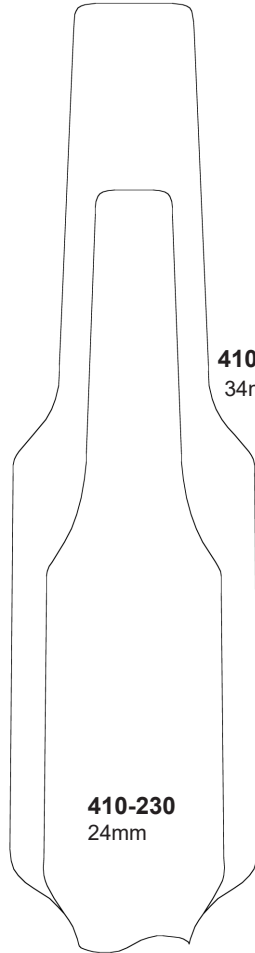
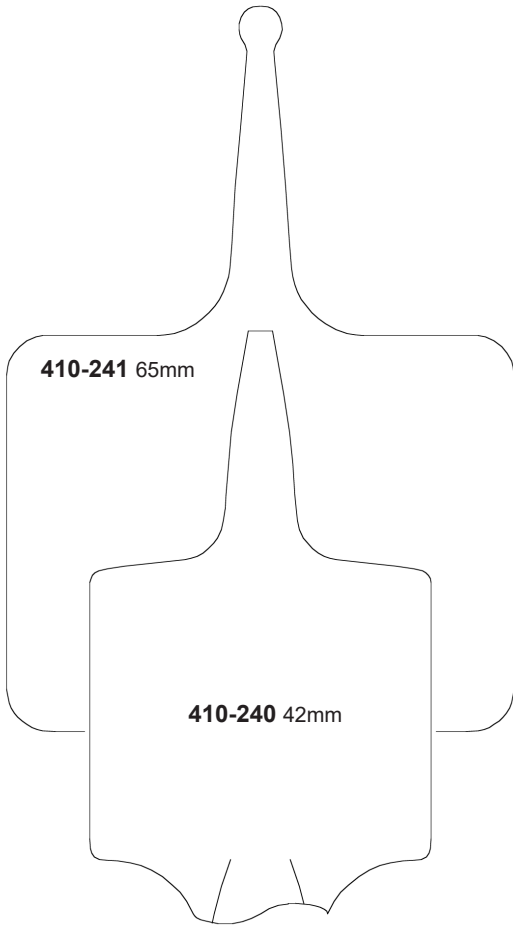

HOHMANN

410-230 260mm, 10 1/4"

410-231 290mm, 11 1/2"

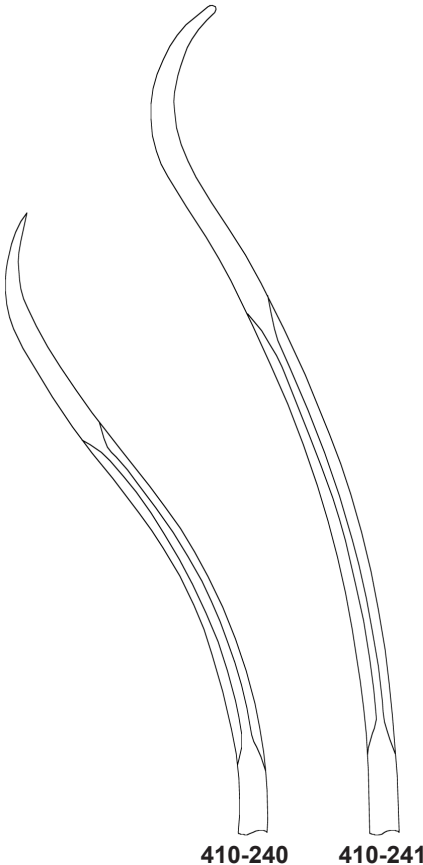
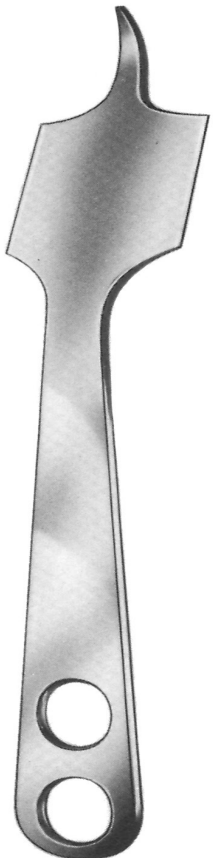

VERBRUGGE

410-240 240mm, 9 1/2"

410-241 255mm, 10"

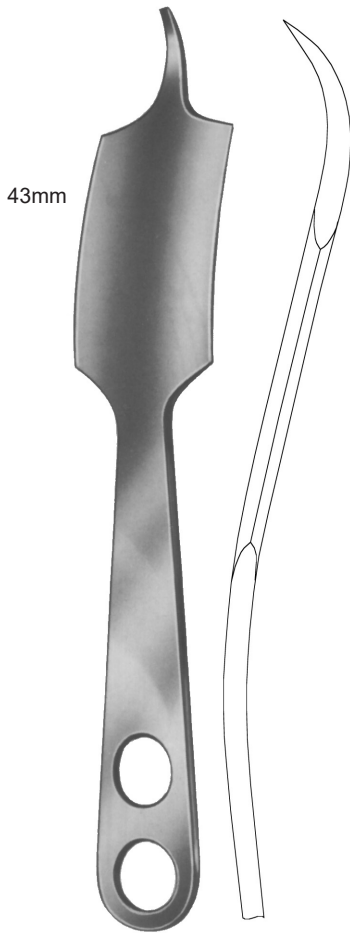

HOHMANN
410-244
245mm, 9 3/4"



HOHMANN
410-210
270mm, 10 3/4"

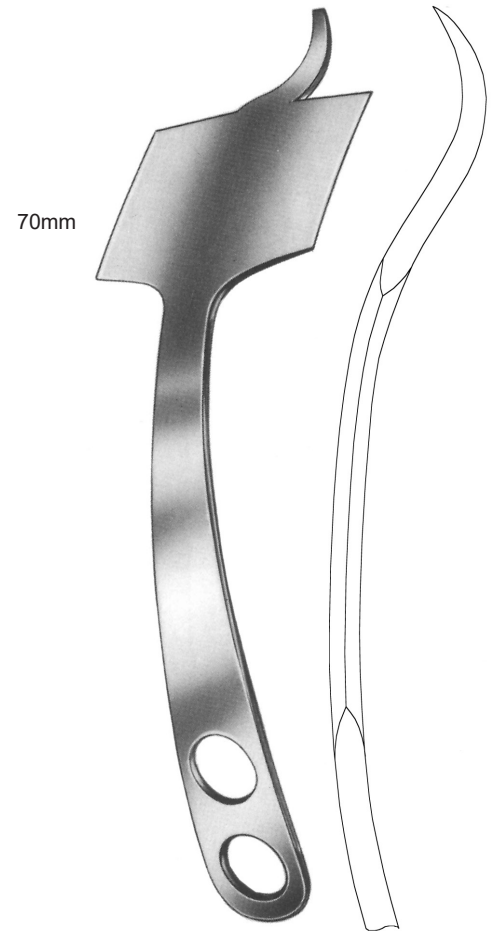
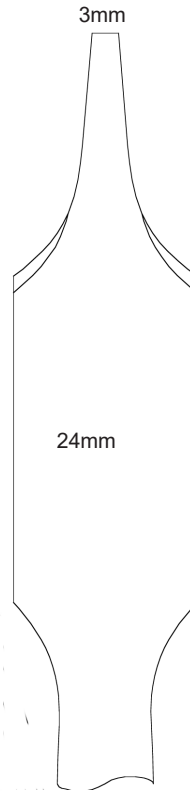

HOHMANN
410-246
250mm, 10"



**LANE-
THRETHOWAN**
410-256
215mm, 8 1/2"

WATSON-JONES
410-251
280mm, 11"

LANE
410-253
265mm, 10 1/2"

LANE
410-254
255mm, 10"

BRISTOW
410-359 180mm, 7"
410-360 230mm, 9"

BLOUNT
410-262
265mm, 10 1/2"

410-285

glatt, smooth, lisa, lisse
 spitz, pointed, agudo, pointu

410-286

gerieft, serrated, estriada, strié
 stumpf, blunt, romo, mousse

410-287

glatt, smooth, lisa, lisse
 stumpf, blunt, romo, mousse

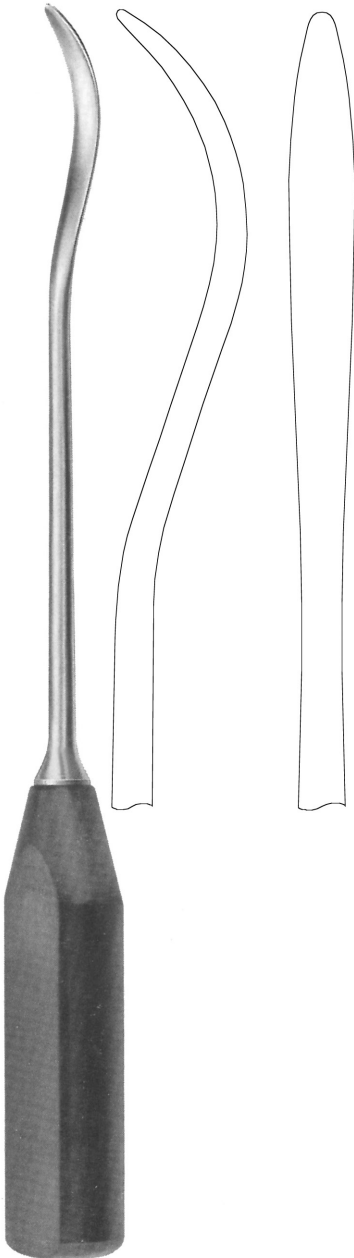

WAGNER
410-265
 330mm, 13"



BENNET
410-270 44mm
410-271 64mm
 255mm



AUFRANC-COBRA
410-285 - 410-287
 280mm, 11"

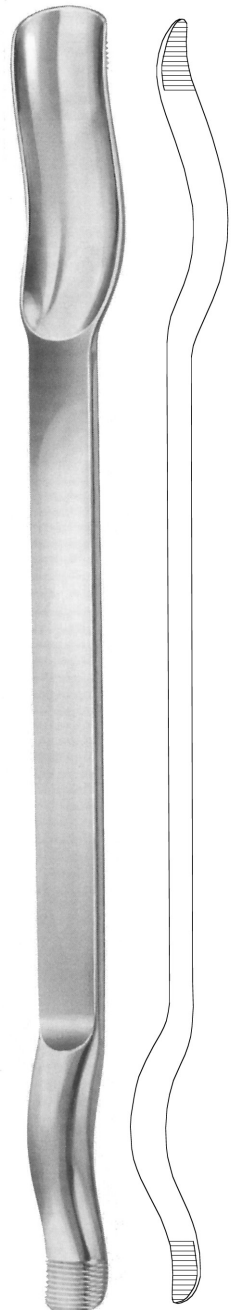

MURPHY-LANE
410-196 30/19mm
410-197 43/36mm
 310mm, 12 1/4"

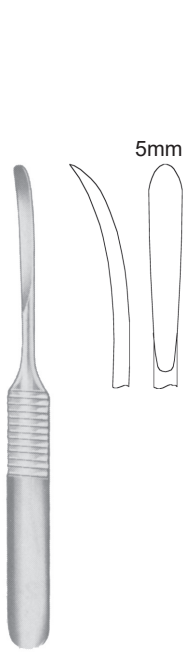

WILLIGER
410-300
130mm, 5"

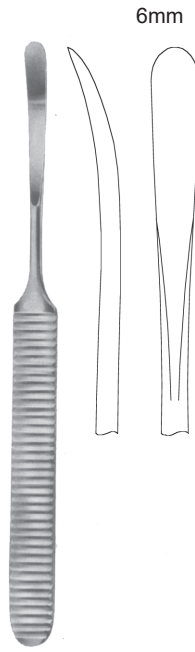

WILLIGER
410-302
160mm, 6 1/4"

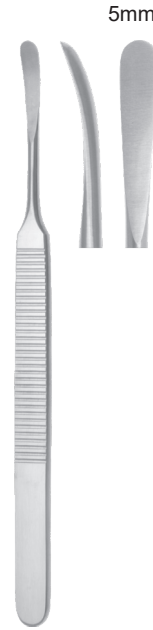

KÖNIG
410-306
155mm, 6"

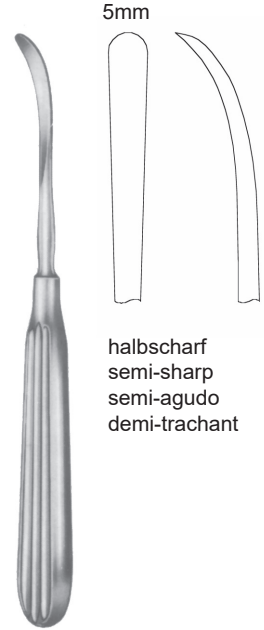

LOVE-ADSON
340-966
170mm, 6 3/4"

halbscharf
semi-sharp
semi-agudo
demi-trachant

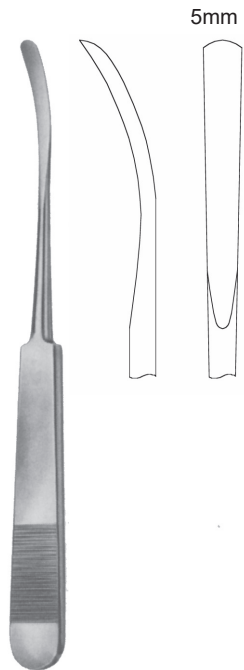

ADSON
340-954
165mm, 6 1/2"



CUSHING
340-912 - 340-915

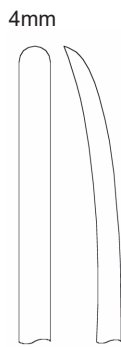

340-912
175mm, 7"

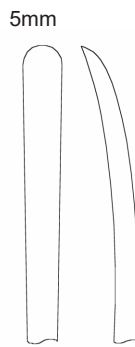

340-913
175mm, 7"



340-914
195mm, 7 3/4"

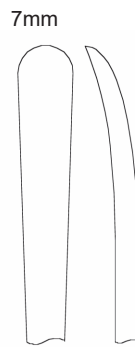

340-915
195mm, 7 3/4"



7mm



340-950
 175mm, 7 1/4"

15mm

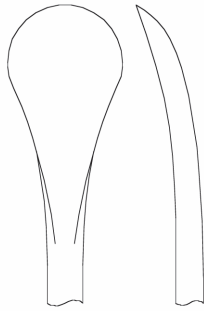

340-951
 185mm, 7 1/4"

20mm

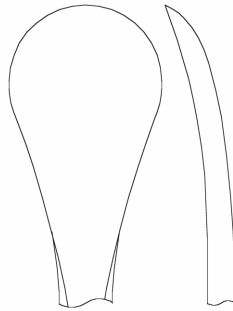

340-952
 190mm, 7 1/2"

voller Griff
 solid handle
 mango pleno
 manche massive

HOEN
340-950 - 340-952



8mm

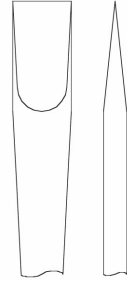

voller Griff
 solid handle
 mango pleno
 manche massive

CUSHING
340-929
 170mm, 6 3/4"

6mm



CUSHING
340-910
 150mm, 6"
 (Little Joker)

6mm

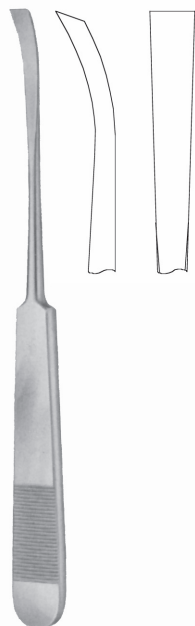

PENNYBAKER
340-935
 165mm, 6 1/2"

8mm

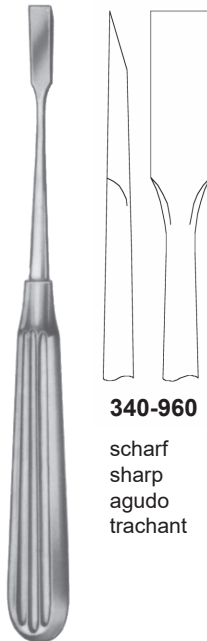

ADSON
340-960 - 340-963
 170mm, 6 3/4"



340-960
 scharf
 sharp
 agudo
 trachant

7mm

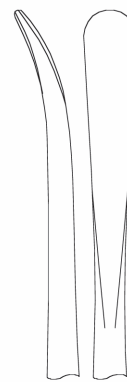

340-961
 stumpf
 blunt
 romo
 mousse

7mm



340-962
 halbscharf
 semi-sharp
 semi-agudo
 demi trachant

7mm



340-963
 halbscharf
 semi-sharp
 semi-agudo
 demi tachant

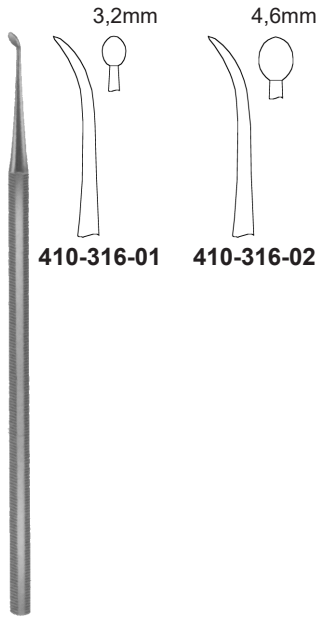

PARTSCH
410-316-01 - 410-316-02
150mm, 6"

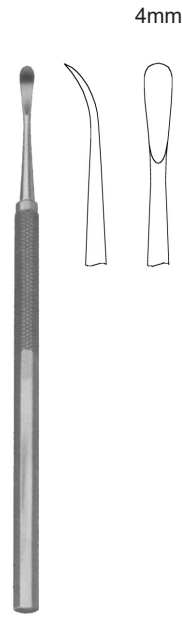

PARTSCH
410-315
145mm, 5 3/4"

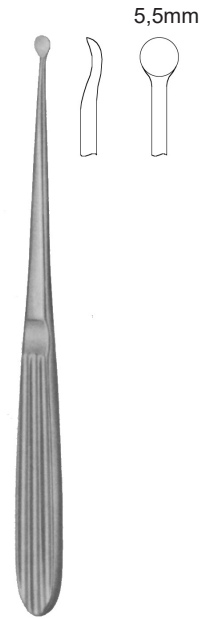

WARD
440-614
170mm, 6 3/4"

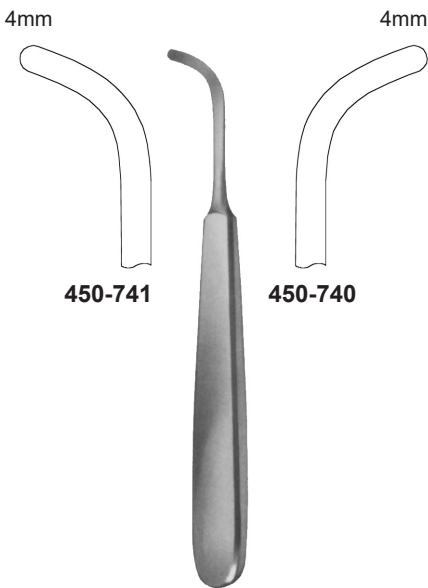

ROSE
450-740 - 450-741
140mm, 5 1/2"

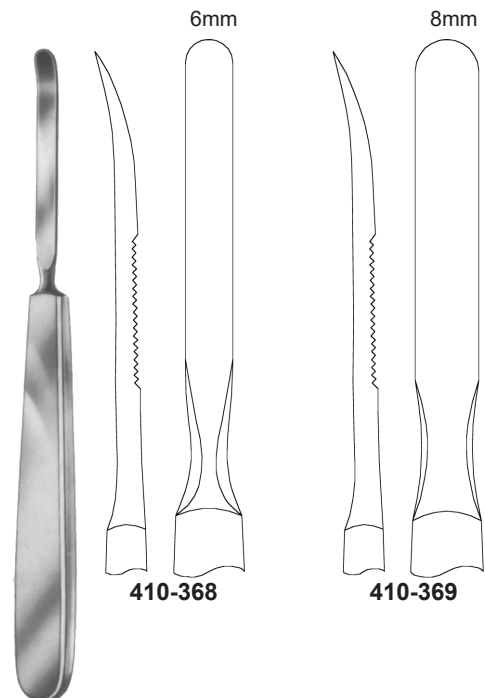

PLESTER
410-368 - 410-369
170mm, 6 3/4"

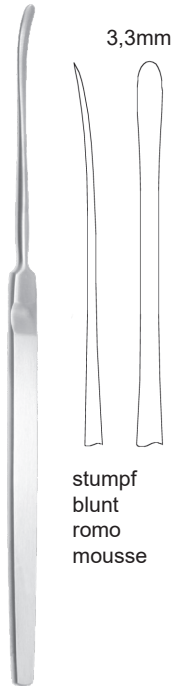

3,3mm

stumpf
 blunt
 romo
 mousse

HALLE
440-611 160mm, 6 1/4"
440-612 180mm, 7"



4mm

ST CLAIR THOMPSON
440-636 160mm, 6 1/4" **440-637**
 scharf
 sharp
 agudo
 trachant

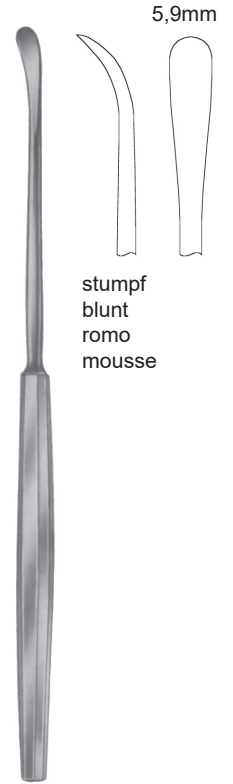

5,9mm

stumpf
 blunt
 romo
 mousse

SEWALL
440-618
 200mm, 8"

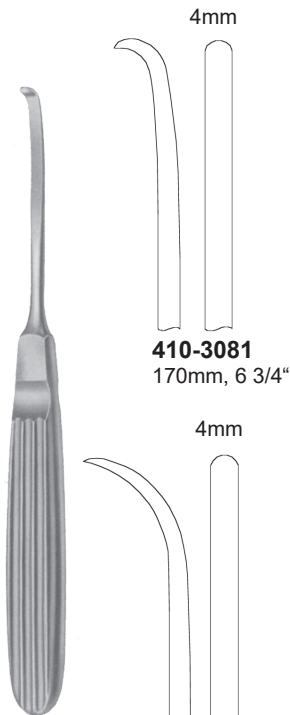

4mm

410-3081
 170mm, 6 3/4"



4mm

410-3082
 170mm, 6 3/4"

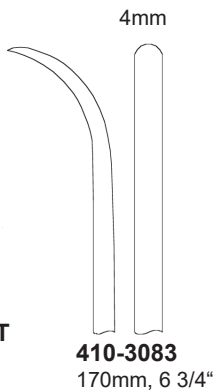

4mm

410-3083
 170mm, 6 3/4"

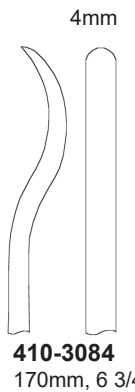

4mm

410-3084
 170mm, 6 3/4"

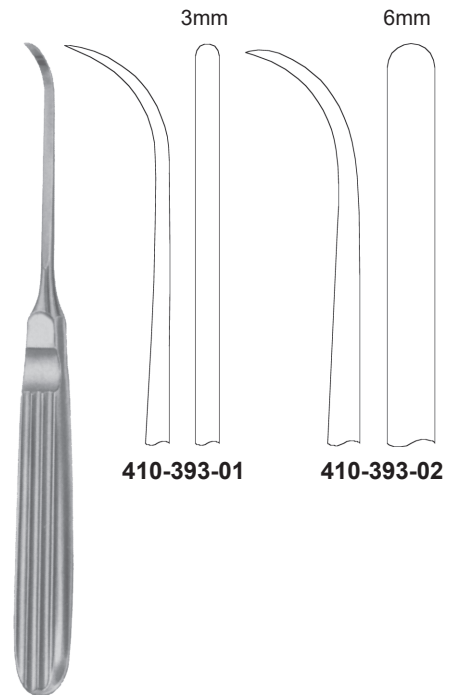

3mm

410-393-01

6mm

410-393-02

410-393-01 - 410-393-02
 170mm, 6 3/4"

LEMPERT

ELCON 410

ELEVATORIEN, RASPATORIEN
ELEVATORS, PERIOSTEAL ELEVATORS
ELEVADORES, PERIOSTOMOS
ELEVATEURS, RUGINE-RASPATOIRES

4,5mm



FREER

440-615

440-616

190mm, 7 1/2"

scharf
sharp
agudo
aigu

stumpf
blunt
romo
mousse

4,5mm



FREER

440-620

185mm, 7 1/4"

440-621

200mm, 8"

stumpf
blunt
romo
mousse
440-620
scharf
sharp
agudo
trachant

6,5mm

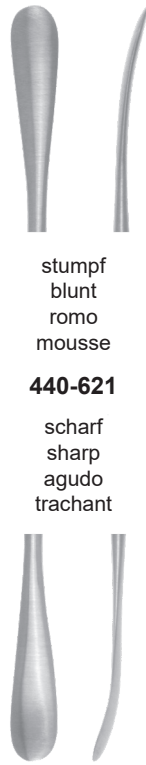

stumpf
blunt
romo
mousse

440-621

scharf
sharp
agudo
trachant



stumpf
blunt
romo
mousse
452-270
stumpf
blunt
romo
mousse

OBWEGGESER-FREER

452-270 210mm, 8 1/4"

452-271 205mm, 8"

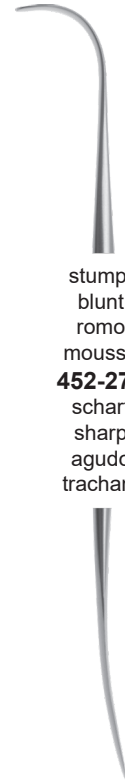

stumpf
blunt
romo
mousse
452-271
scharf
sharp
agudo
trachant

4mm

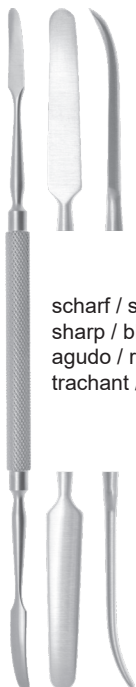

KILLIAN

440-603

180mm, 7"

scharf / stumpf
sharp / blunt
agudo / romo
trachant / mousse

4,5mm

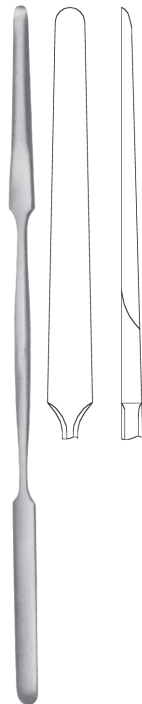

KILLIAN

440-602

185mm, 7 1/4"

scharf / stumpf
sharp / blunt
agudo / romo
trachant / mousse

5,5mm

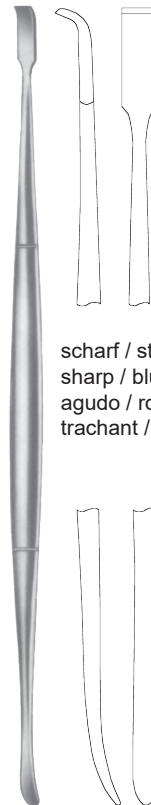

scharf / stumpf
sharp / blunt
agudo / romo
trachant / mousse

HOWARTH

440-626

215mm, 8 1/2"

4,5mm

3mm

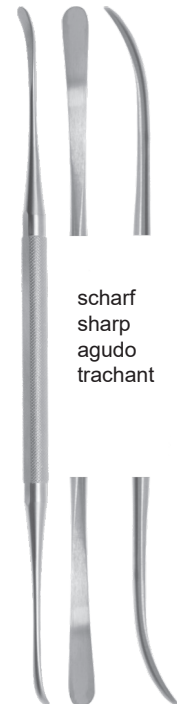

scharf
sharp
agudo
trachant

FREER-YASARGIL

440-627

185mm, 7 1/4"

4,5mm

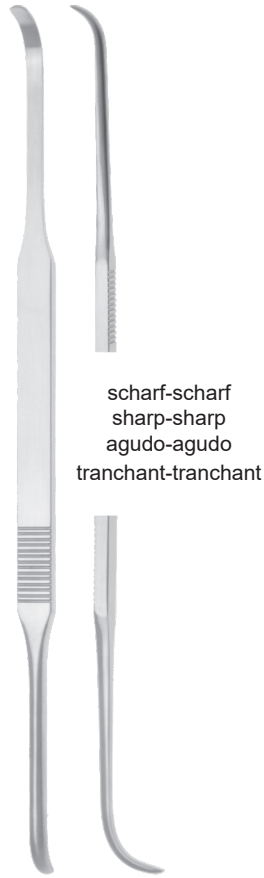

scharf-scharf
 sharp-sharp
 agudo-agudo
 tranchant-tranchant

COTTLE
450-733 230mm, 9"

4mm



COTTLE-McKENTY
450-732 220mm

4mm



stumpf
 blunt
 romo
 mousse

scharf
 sharp
 agudo
 tranchant

5mm

HILL
440-660
 220mm, 8 3/4"

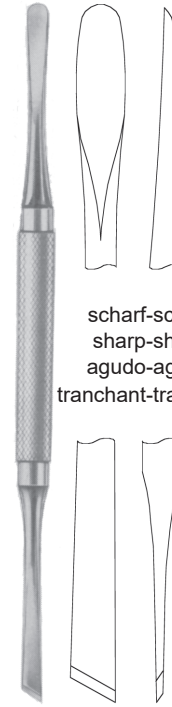

scharf-scharf
 sharp-sharp
 agudo-agudo
 tranchant-tranchant

MEAD
440-666
 165mm, 6 1/4"

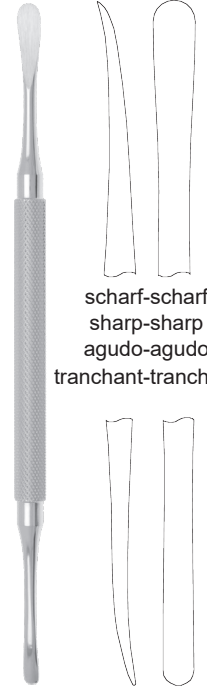

scharf-scharf
 sharp-sharp
 agudo-agudo
 tranchant-tranchant

MOLT
440-665
 180mm, 7"

8mm

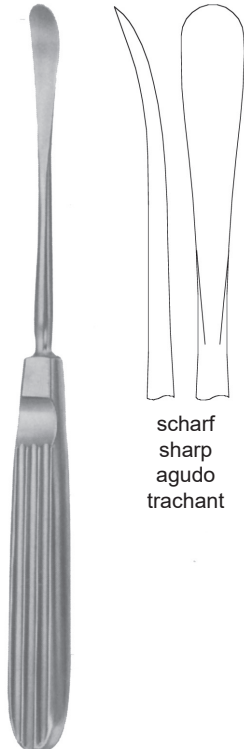

scharf
 sharp
 agudo
 trachant

COTTLE
450-708
 195mm, 7 3/4"

4,7mm

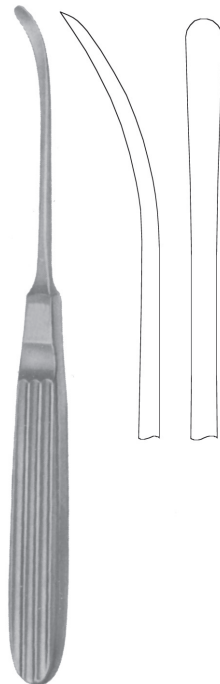

LANDOLT
410-313
 175mm, 7"

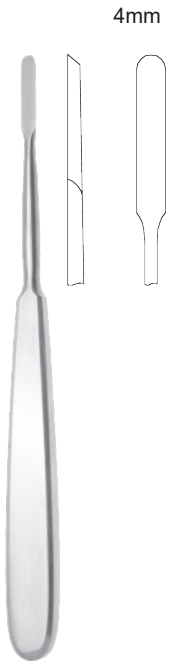

JOSEPH
450-698
160mm, 6 1/4"



JOSEPH
450-706
160mm, 6 1/4"

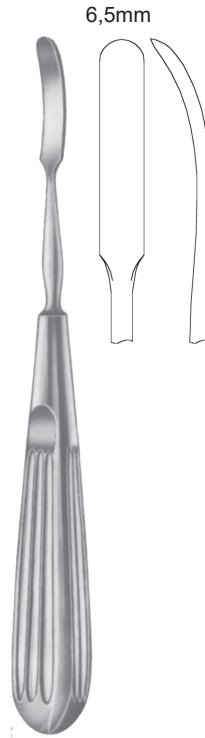

JOSEPH
450-707
180mm, 7"

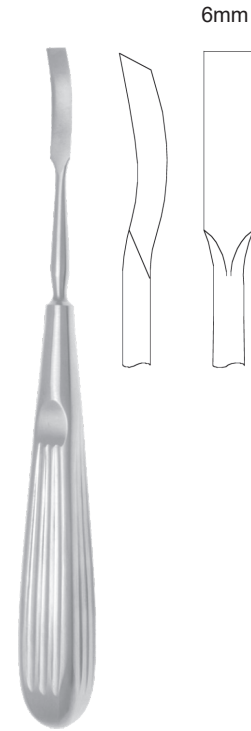

LEMPERT
431-517
180mm, 7"



LEMPERT
431-515
205mm, 8"

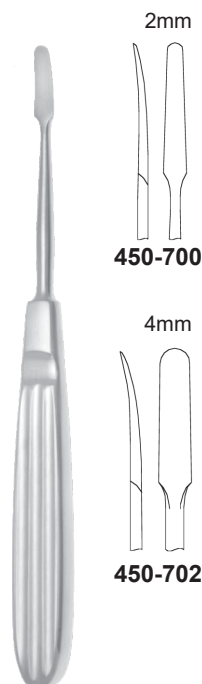

2mm
450-700

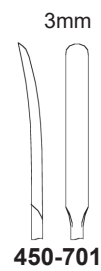

3mm
450-701



4mm
450-702

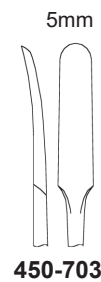

5mm
450-703

LEMPERT
450-700 - 450-703
170mm, 6 3/4"

15mm

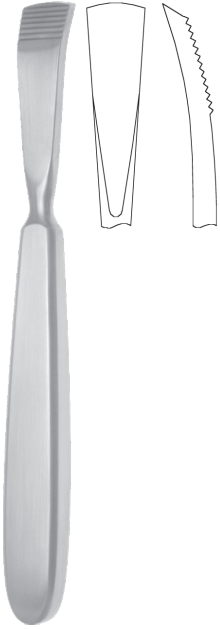

JANSEN
410-324
 165mm, 6 1/2"

13mm

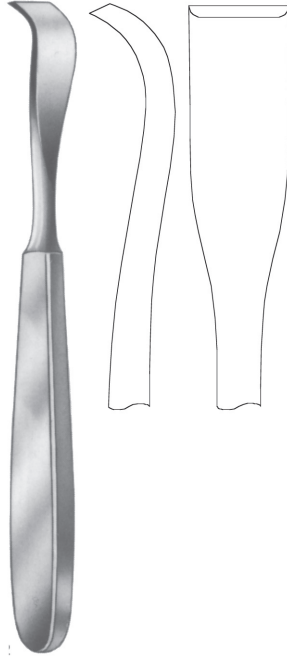

SCHNEIDER
410-325
 175mm, 7"

13mm

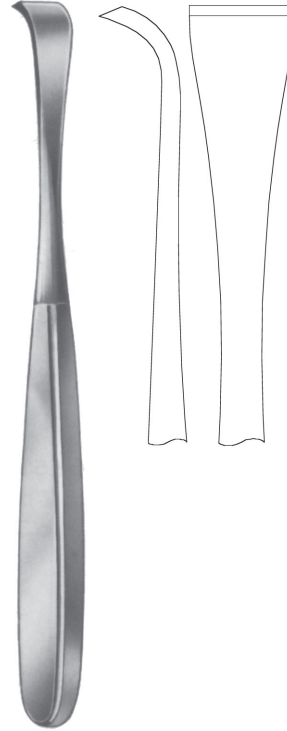

SCHNEIDER-SAUERBRUCH
410-327
 190mm, 7 1/2"

18mm



SEDILLOT
410-345
 185mm, 7 1/4"

14mm

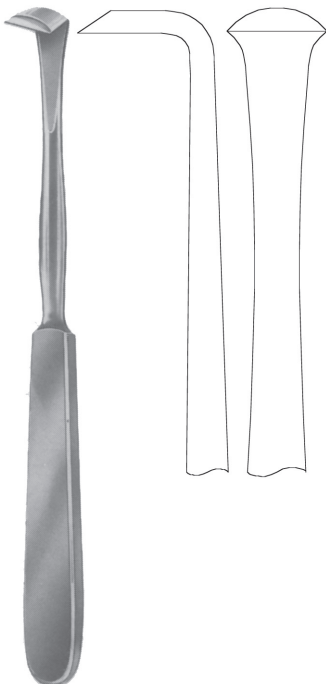

LANGENBECK
410-342
 180mm, 7"

16mm

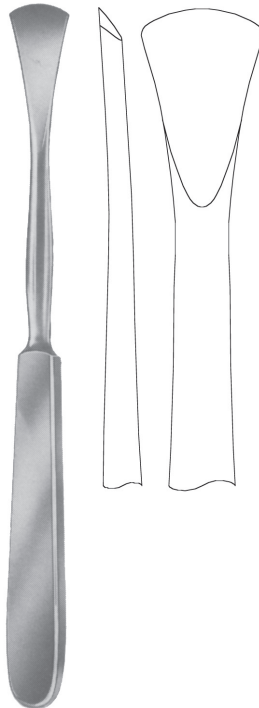

LANGENBECK
410-340
 190mm, 7 1/2"

15mm

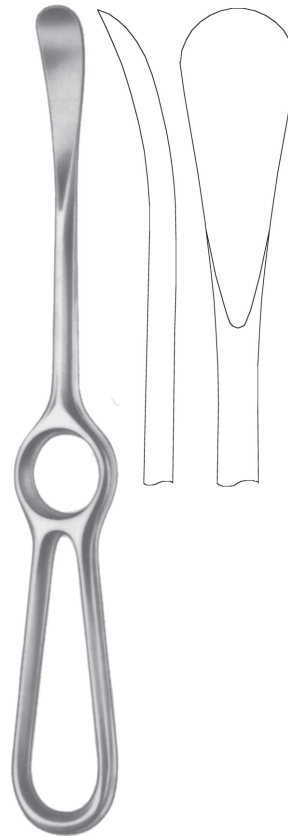

SEDILLOT
410-346
 210mm, 8 1/4"

11mm

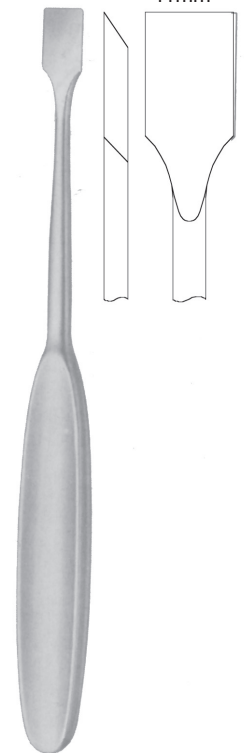

MCKISSOCK
410-395
 195mm, 7 3/4"

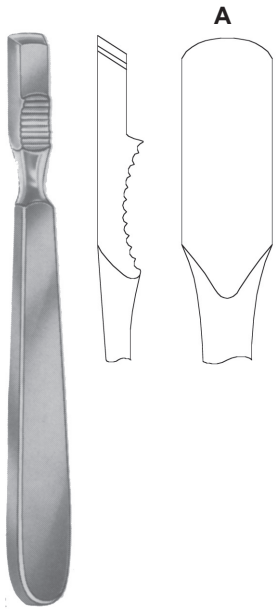

	A mm
410-330-04	4
410-330-06	6
410-330-08	8
410-330-10	10
410-330-12	12
410-330-14	14
410-330-16	16

FARABEU
410-330-04 - 410-330-16
150mm, 6"

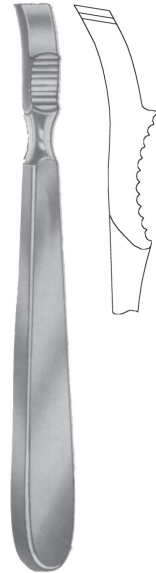

FARABEU
410-331-04 - 410-331-16
150mm, 6"



MITCHELLS
410-318
210mm, 8 1/4"

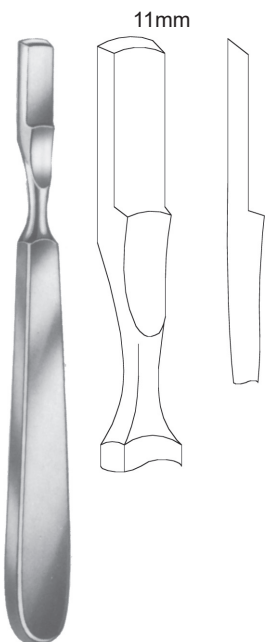

FARABEU-COLLIN
410-336
160mm, 6 1/4"

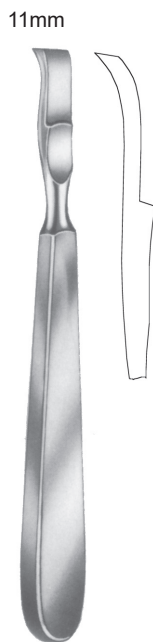

FARABEU-COLLIN
410-337
160mm, 6 1/4"

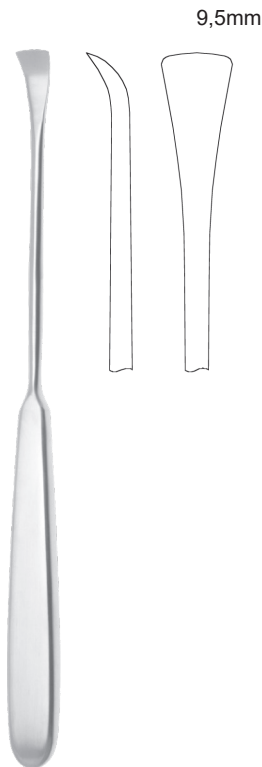

410-320
190mm, 7 1/2"



LAMBOTTE
410-350 5mm
410-351 10mm
410-352 15mm
410-353 20mm
410-354 25mm
215mm, 8 1/2"

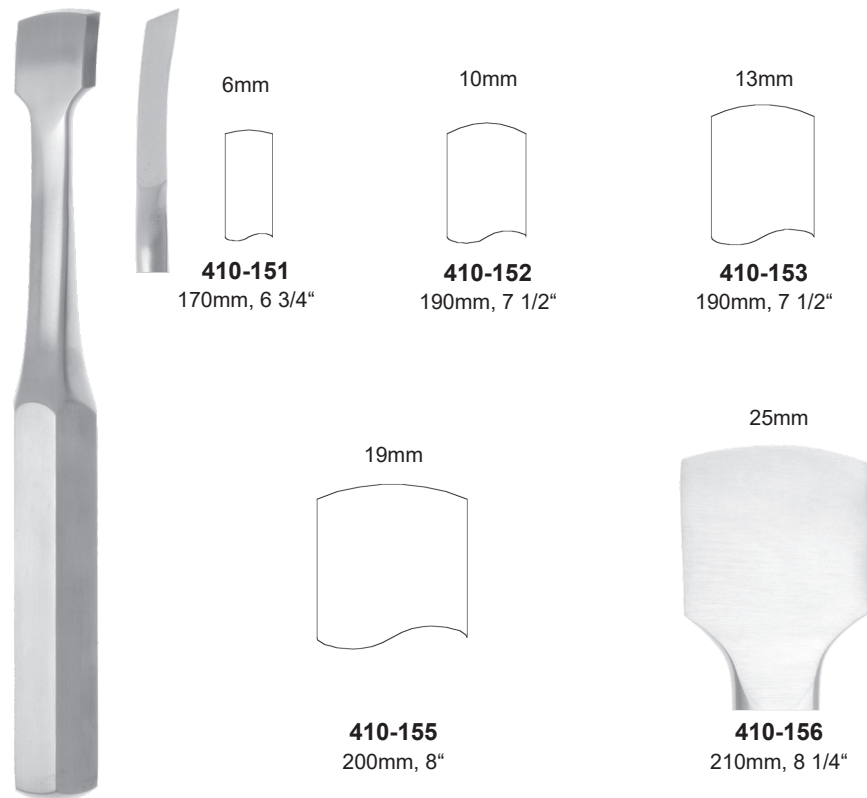

KEY
410-151 - 410-156

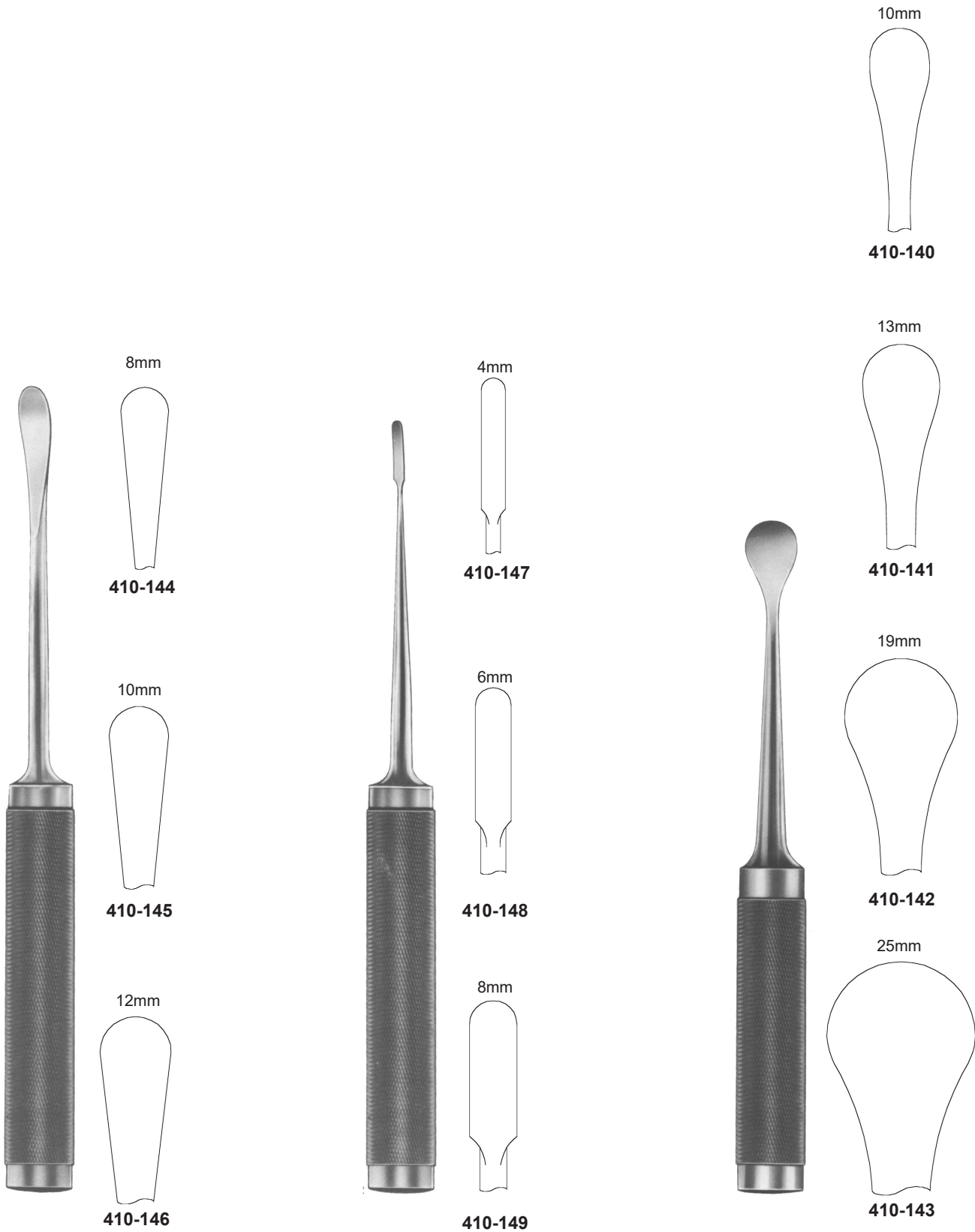

COBB
410-144 8mm
410-145 10mm
410-146 12mm
 280mm, 11"

COBB
410-147 4mm
410-148 6mm
410-149 8mm
 270mm, 10 3/4"

COBB
410-140 10mm
410-141 13mm
410-142 19mm
410-143 25mm
 240mm, 9 1/2"



410-384
 190mm, 7 1/2"



410-385
 185mm, 7 1/4"



410-382
 185mm, 7 1/4"



410-383
 185mm, 7 1/4"



410-388
 190mm, 7 1/2"



410-380
 200mm, 8"

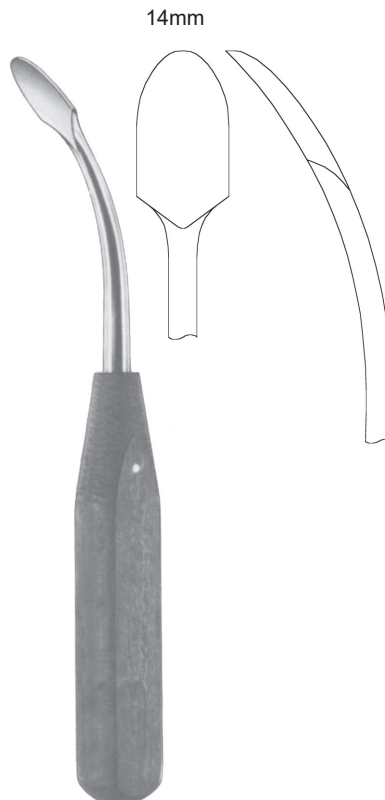

410-381
 190mm, 7 1/2"



410-387
 200mm, 8"



DOYEN
251-136 **251-137**
240mm, 9 1/2"

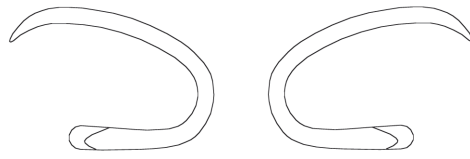

251-132 für Kinder
for children
para niños
pour enfants **251-133**

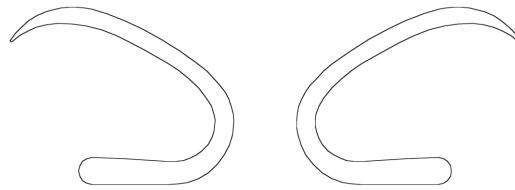

251-134 **251-135**

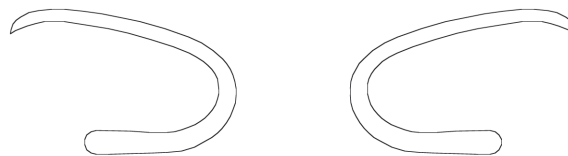

251-136 **251-137**
linksgebogen rechtsgebogen
left curved right curved
curvo a la izquierda curvo a la derecha
courbé à gauche courbé à droite



DOYEN
251-132 **251-133**
251-134 **251-135**
175mm, 7"

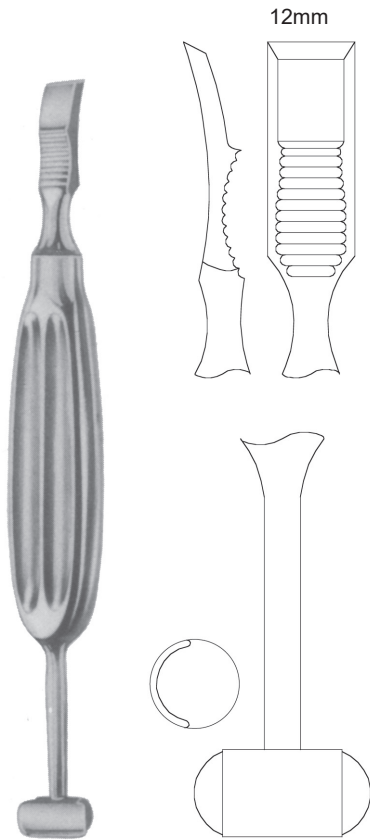

ALEXANDER-FARABEUF
251-122
 210mm, 8 1/4"

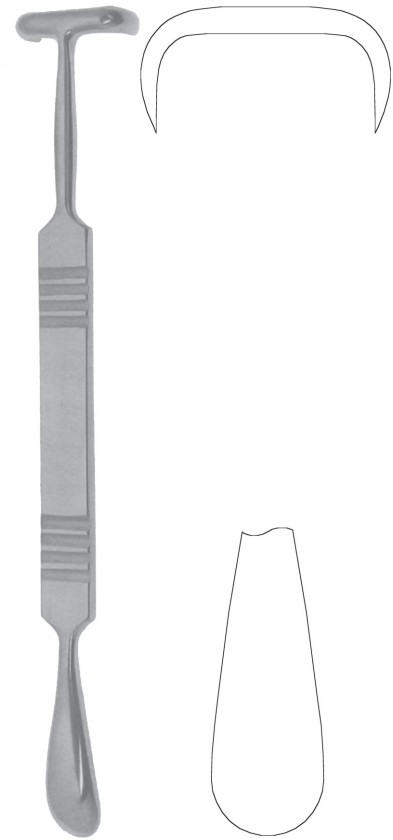

MATSON
251-140
 220mm, 8 3/4"

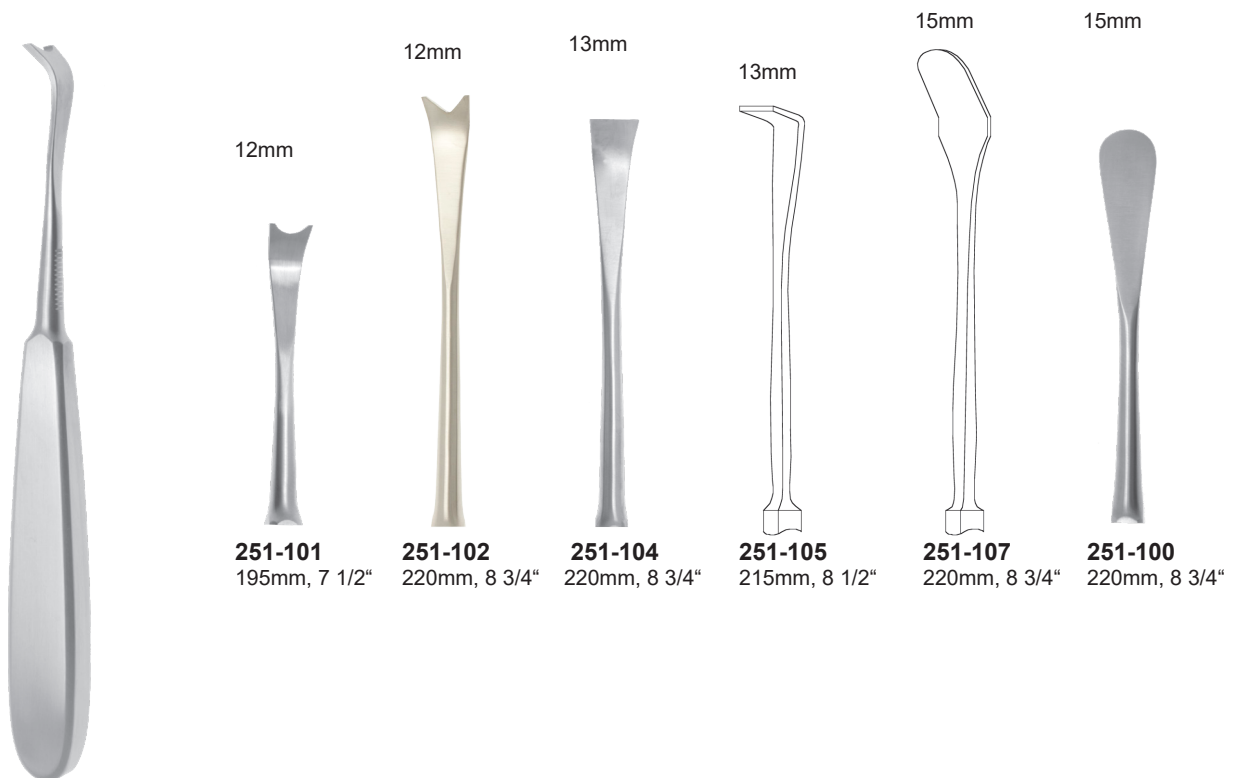

251-101
 195mm, 7 1/2"

251-102
 220mm, 8 3/4"

251-104
 220mm, 8 3/4"

251-105
 215mm, 8 1/2"

251-107
 220mm, 8 3/4"

251-100
 220mm, 8 3/4"

SEMB
251-100 - 251-107

ELCON 410

KNOCHENFEILEN, KNOCHENRASPELN
BONE FILES, BONE RASPS
LIMAS PARA HUESOS, ESCOFINAS PARA HUESO
LIMES A OS, RAPES POUR OS

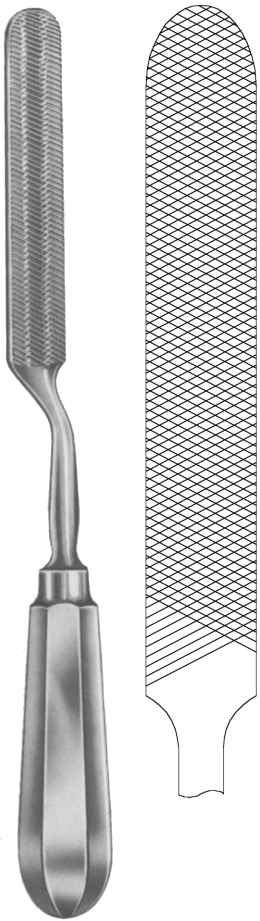

410-400
245mm, 9 5/8"



**PUTTI
410-410**
270mm, 10 5/8"



**PUTTI
410-411**
300mm, 12"

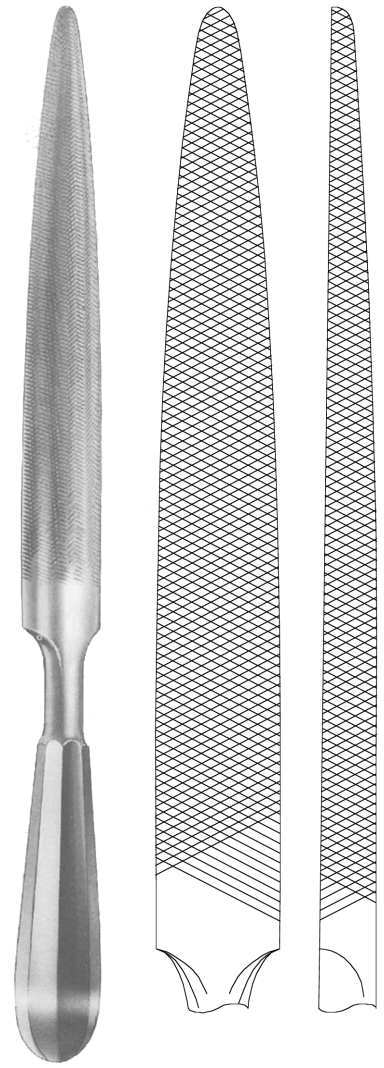

410-420
280mm, 11"

KNOCHENFEILEN, KNOCHENRASPELN
 BONE FILES, BONE RASPS
 LIMAS PARA HUESOS, ESCOFINAS PARA HUESO
 LIMES A OS, RAPES POUR OS

ELCON
410

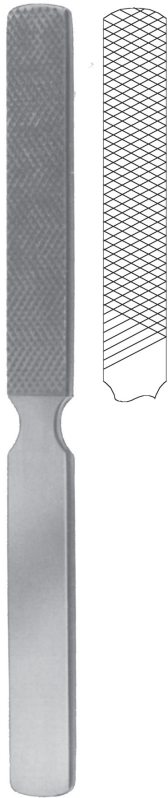

410-402
 220mm, 8 3/4"

8mm

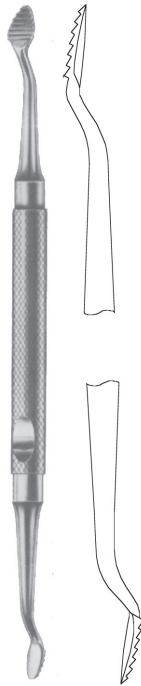

5mm

MILLER
410-432
 180mm, 7"

6mm

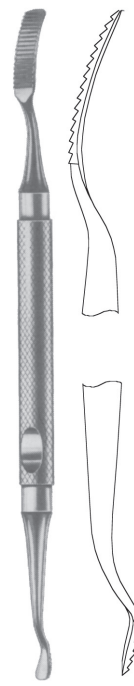

4,3mm

MILLER
410-431
 180mm, 7"

6mm

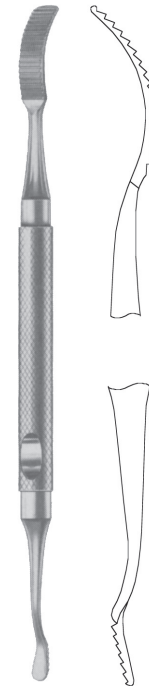

5mm

MILLER
410-430
 180mm, 7"

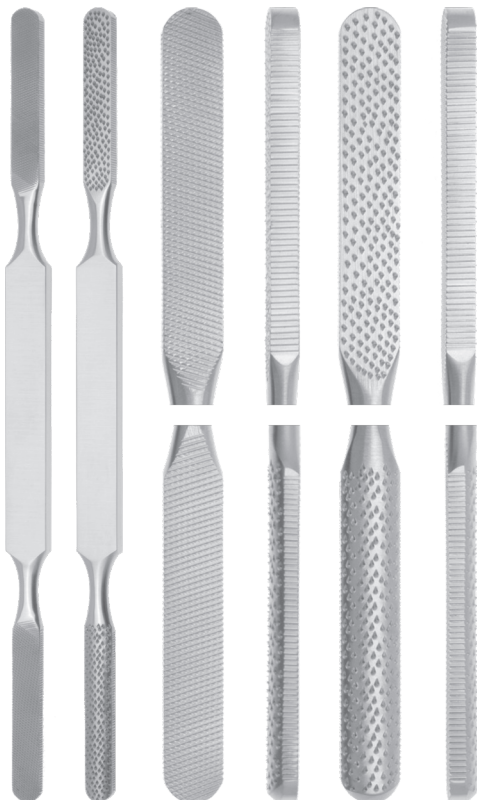

FOMON (KLEINERT KUTZ)
450-548
 210mm, 8 1/4"



FOMON-MASING
450-540
 210mm, 8 1/4"



FOMON-MASING
450-542
 210mm, 8 1/4"



FOMON
450-590 12/14
450-591 16/20
450-592 24/30
450-593 36/44
450-594 52/64
 205mm, 8"

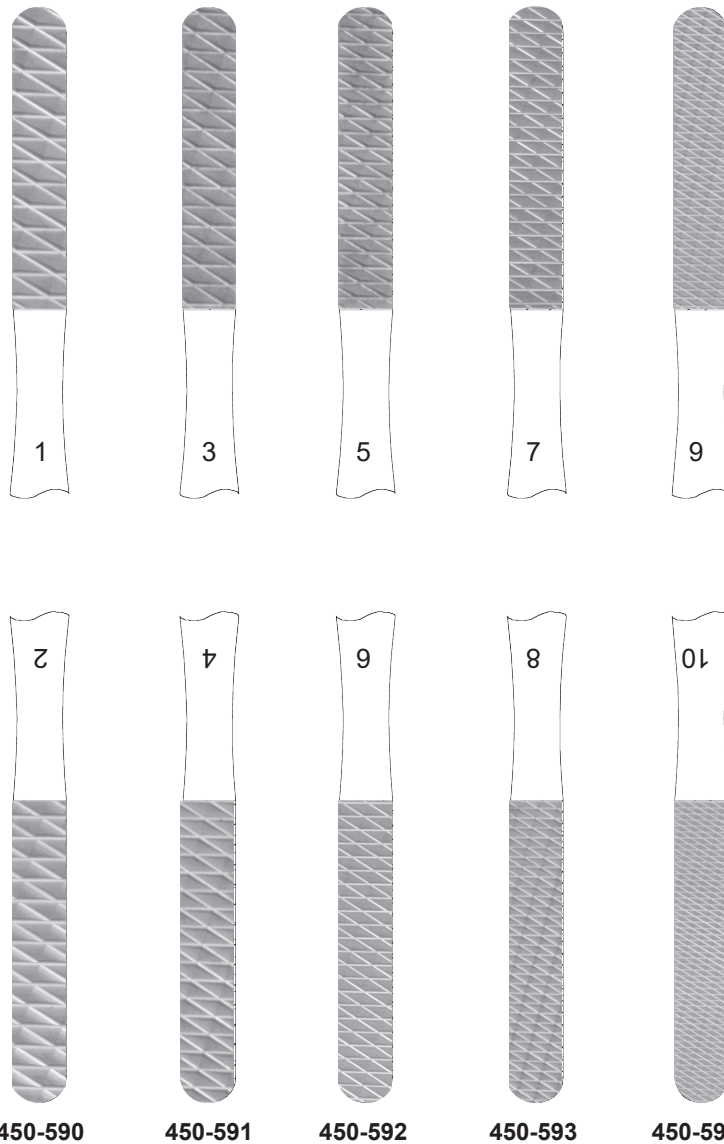

Hartmetalleinlagen
 Tungsten carbide inlays
 Insertos de carburo tungsteno
 Insert de carbure tungstène

- Fig.1 grob / coarse / grueso / grosse
 12 Zähne / 12 teeth / 12 dientes / 12 dents
- Fig.2 grob / coarse / grueso / grosse
 14 Zähne / 14 teeth / 14 dientes / 14 dents
- Fig.3 grob / coarse / grueso / grosse
 16 Zähne / 16 teeth / 16 dientes / 16 dents
- Fig.4 mittel / medium / mediano / moyen
 20 Zähne / 20 teeth / 20 dientes / 20 dents
- Fig.5 mittel / medium / mediano / moyen
 24 Zähne / 24 teeth / 24 dientes / 24 dents

- Fig.6 mittel / medium / mediano / moyen
 30 Zähne / 30teeth / 30 dientes / 30 dents
- Fig.7 fein / fine / fino / fine
 36 Zähne / 36 teeth / 36 dientes / 36 dents
- Fig.8 fein / fine / fino / fine
 44 Zähne / 44 teeth / 44 dientes / 44 dents
- Fig.9 fein / fine / fino / fine
 52 Zähne / 52 teeth / 52 dientes / 52 dents
- Fig.10 fein / fine / fino / fine
 62 Zähne / 62 teeth / 62 dientes / 62 dents

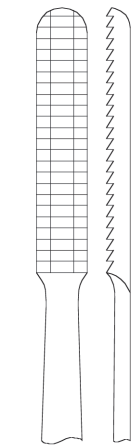

450-518

auf Zug schneidend
 cuts on down stroke
 cortante a tracción
 tranchant à traction

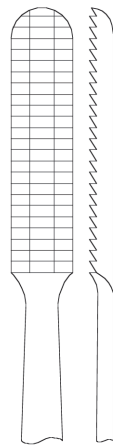

450-519

auf Stoß schneidend
 cuts on up stroke
 cortante a empuje
 tranchant à impact

MALTZ
450-518 - 450-519
 175mm, 7"

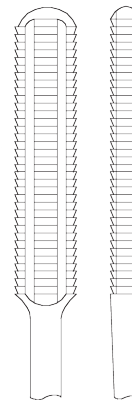

9mm

auf Stoß schneidend
 cuts on up stroke
 cortante a empuje
 tranchant à impact

MALTZ
450-510
 180mm, 7"



9mm



450-530

auf Zug schneidend
 cuts on down stroke
 cortante a tracción
 tranchant à traction

450-531

auf Stoß schneidend
 cuts on up stroke
 cortante a empuje
 tranchant à impact

AUFRIECHT
450-530 210mm, 8 1/4"
450-531 210mm, 8 1/4"



8mm



auf Zug schneidend
 cuts on down stroke
 cortante a tracción
 tranchant à traction

COTTLE
450-520
 210mm, 8 1/4"

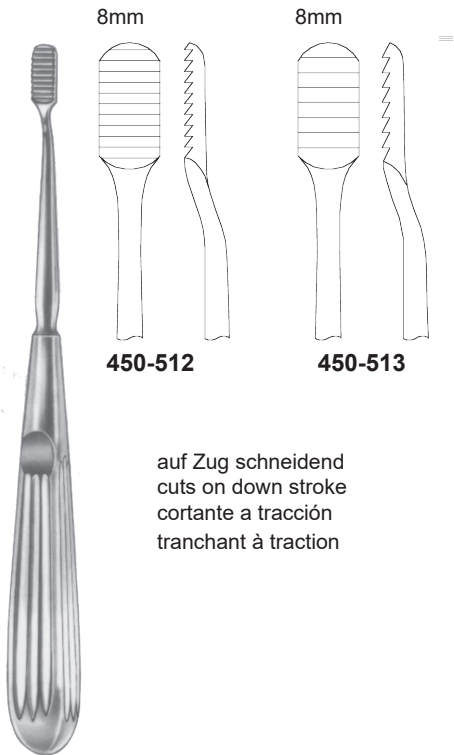

450-512

450-513

auf Zug schneidend
cuts on down stroke
cortante a tracción
tranchant à traction

LEWIS
450-512 - 450-513
180mm, 7"

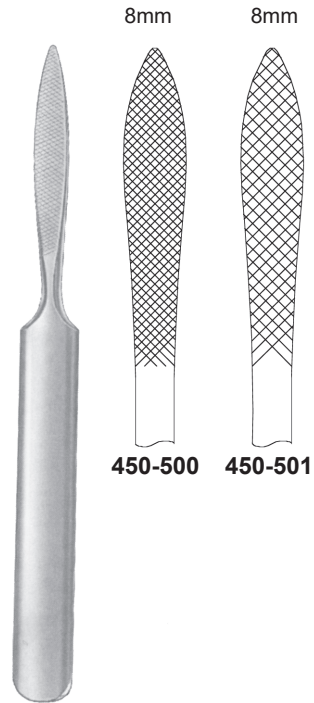

8mm

8mm

450-500

450-501

JOSEPH
450-500 - 450-501
160mm, 6 1/4"

Ø 5mm

Ø 5mm

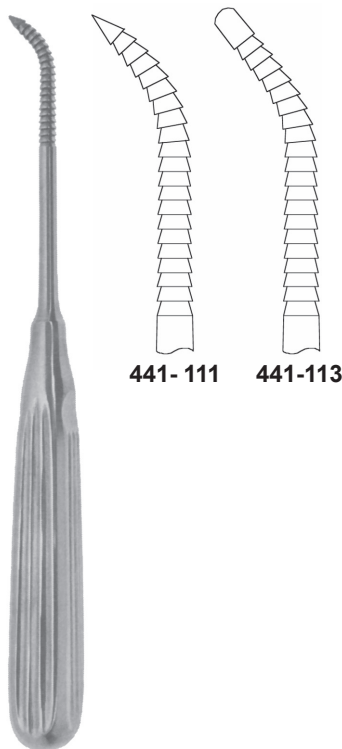

441-111

441-113

WIENER
441-111 - 441-113
180mm, 7"

SCHARFE DOPPELÖFFEL
 BONE CURETTES, DOUBLE ENDED
 CUCHARILLAS DE DOBLE EXTREMO
 CURETTES DOUBLE

ELCON
410

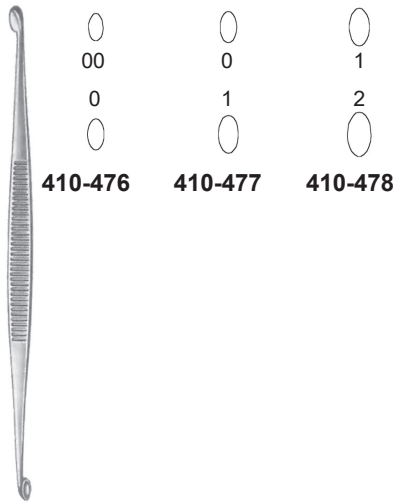

WILLIGER
410-476 Fig. 00/0
410-477 Fig. 0/1
410-478 Fig. 1/2
 135mm, 5 1/4"



HOUSE
 170mm

431-480-01	rund / round / redonda / ronde	Ø1,0mm / Ø1,2mm
431-481-01	oval / oval / oval / ovale	0,8x1,0mm / 1,0x1,2mm
431-481-02	oval / oval / oval / ovale	1,1x1,5mm / 1,3x1,8mm
431-481-03	oval / oval / oval / ovale	1,5x2,2mm / 1,9x2,6mm
431-481-04	oval / oval / oval / ovale	2,3x3,1mm / 2,5x3,3mm
431-482-01	rund / round / redonda / ronde	Ø1,0mm / Ø1,2mm

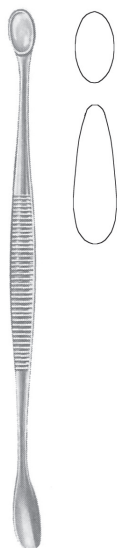

VOLKMANN
410-480 135mm, 5 1/4"
410-481 145mm, 5 3/4"
410-482 170mm, 6 3/4"



VOLKMANN
410-490
 130mm, 5"



VOLKMANN
410-492
 160mm, 6 1/4"



VOLKMANN
410-494
 200mm, 8"



JACOBSON
410-460
140mm, 5 1/2"



JANSEN
410-462
160mm, 6 1/4"



BARTH
410-498
180mm, 7"

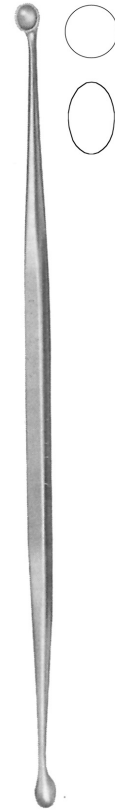

VOLKMANN
410-496
210mm, 8 1/4"



410-485

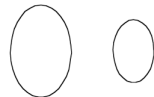

410-486

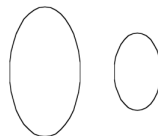

410-487

VOLKMANN
410-485 - 410-487
220mm, 8 5/8"

SCHARFE LÖFFEL
BONE CURETTES
CUCHARILLAS CORTANTES
CURETTES TRANCHANTES

ELCON
410



VOLKMANN
410-540 - 410-549
170mm, 6 3/4"

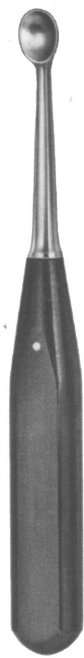

VOLKMANN
410-5740 - 410-5769 170mm, 6 3/4"
410-5770 - 410-5786 270mm, 10 3/4"

2,8mm



0000
410-540
410-5740
410-5770

3,6mm



000
410-541
410-5741
410-5771

4,4mm



00
410-542
410-5742
410-5772

5,2mm



0
410-543
410-5743
410-5773

6,8mm



1
410-544
410-5744
410-5774

8,5mm



2
410-545
410-5745
410-5775

10mm



3
410-546
410-5746
410-5776

11,5mm

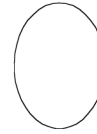

4
410-547
410-5747

13mm

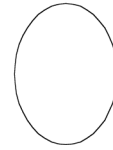

5
410-548
410-5748

14,5mm

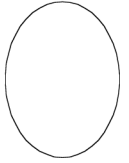

6
410-549
410-5749



BRUNS
410-510 - 410-519
170mm, 6 3/4"

2mm



0000
410-510

3mm



000
410-511

4mm



00
410-512

5mm



0
410-513

6mm



1
410-514

8mm



2
410-515

10mm



3
410-516

12mm

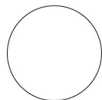

4
410-517

13mm

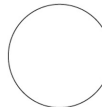

5
410-518

15mm

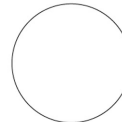

6
410-519

ELCON 410

SCHARFE LÖFFEL
BONE CURETTES
CUCHARILLAS CORTANTES
CURETTES TRANCHANTES



SPRATT
441-290 - 441-297
170mm, 6 3/4"

2,0mm 0000 441-290	2,3mm 000 441-291	3,0mm 00 441-292	3,4mm 0 441-293	4,0mm 1 441-294
	5,5mm 2 441-295	6,2mm 3 441-296	7,0mm 4 441-297	

2,4mm
0000
410-5710

3,2mm
000
410-5711

4,2mm
00
410-5712

5,2mm
0
410-5713

SIMON
410-5711 - 410-5713
240mm, 9 1/2"



2,5mm 000 410-560	3,4mm 00 410-561	4,2mm 0 410-562	5,2mm 1 410-563	6,3mm 2 410-564
7,4mm 3 410-565	8,0mm 4 410-566			

SCHUDE
410-560 - 410-566
170mm, 6 3/4"

2,3mm
00
410-450

3,1mm
0
410-451









4,2mm
1
410-452

5,2mm
2
410-453

WILLIGER
410-450 - 410-453
175mm,

SCHARFE LÖFFEL
BONE CURETTES
CUCHARILLAS CORTANTES
CURETTES TRANCHANTES

ELCON
410

2,5mm	3,0mm	3,5mm	4,0mm	5,0mm	6,0mm	8,0mm	9,0mm	10,5mm
								
000	00	0	1	2	3	4	5	6
410-520	410-521	410-522	410-523	410-524	410-525	410-526	410-527	410-528
410-530	410-531	410-532	410-533	410-534	410-535	410-536	410-537	410-538
341-620	341-621	341-622	341-623	341-624	341-625	341-626	341-627	341-628
341-630	341-631	341-632	341-633	341-634	341-635	341-636	341-637	341-638



SPINAL
341-620 - 341-628
200mm, 8"



SPINAL
341-630 - 341-638
200mm, 8"



BRUNS
410-520 - 410-528
230mm, 9"



BRUNS
410-530 - 410-538
230mm, 9"

ELCON 410

SCHARFE LÖFFEL
BONE CURETTES
CUCHARILLAS CORTANTES
CURETTES TRANCHANTES



CASPAR
414-734 4mm
414-735 5mm
250mm, 10"
mit 1 Zahn
with 1 tooth
con 1 diente
avec 1 dent



CASPAR
414-743 3mm
414-744 4mm
270mm, 10 3/4"
mit 1 Zahn
with 1 tooth
con 1 diente
avec 1 dent



CASPAR
414-754 4mm
414-755 5mm
414-756 6mm
220mm, 8 3/4"
mit 1 Zahn
with 1 tooth
con 1 diente
avec 1 dent



CASPAR
414-643 3,6mm
414-644 4,4mm
414-645 5,2mm
220mm, 8 3/4"



CASPAR
414-653 3,6mm
414-654 4,4mm
414-655 5,2mm
220mm, 8 3/4"

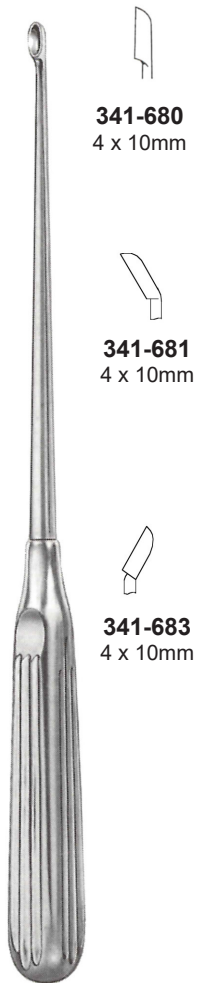

341-680
4 x 10mm

341-681
4 x 10mm

341-683
4 x 10mm

SCOVILLE
341-680 - 341-683
250mm, 10"

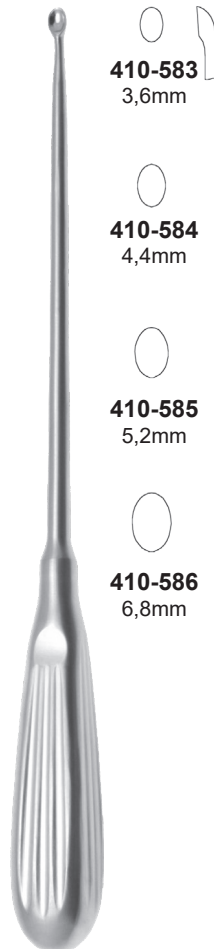

410-583
3,6mm

410-584
4,4mm

410-585
5,2mm

410-586
6,8mm

410-583 - 410-586
250mm, 10"



410-593
3,6mm

410-594
4,4mm

410-595
5,2mm

410-596
6,8mm

410-593 - 410-596
250mm, 10"

ELCON 410

HÄMMER
MALLETS
MARTILLOS
MAILLETS



410-618
200mm, 8"

Kopf Ø 30mm
head Ø 30mm
cabeza Ø 30mm
tete Ø 30mm

Gewicht 220g
weight 220g
peso 220g
poids 220g



LUCAE
410-620
190mm, 7 1/2"

Kopf Ø 19mm
head Ø 19mm
cabeza Ø 19mm
tete Ø 19mm

Gewicht 230g
weight 230g
peso 230g
poids 230g

LUCAE
410-621
190mm, 7 1/2"

Kopf Ø 25mm
head Ø 25mm
cabeza Ø 25mm
tete Ø 25mm

Gewicht 260g
weight 260g
peso 260g
poids 260g



410-623
185mm, 7 1/2"

Kopf Ø 25mm
head Ø 25mm
cabeza Ø 25mm
tete Ø 25mm

Gewicht 185g
weight 185g
peso 185g
poids 185g

410-624

Ersatzbacken (Paar), Kunststoff
Spare Facings (pair), plastic
Tapas de repuesto (par), plastico
Plaques de rechange (paire), plastique



MEAD
410-625
190mm, 7 1/2"

Kopf Ø 27mm
head Ø 27mm
cabeza Ø 27mm
tete Ø 27mm

Gewicht 320g
weight 320g
peso 320g
poids 320g

410-626

Ersatzbacken (Paar), Kunststoff
Spare Facings (pair), plastic
Tapas de repuesto (par), plastico
Plaques de rechange (paire), plastique



DOYEN
410-628
210mm, 8 1/4"

Kopf Ø 30mm
head Ø 30mm
cabeza Ø 30mm
tete Ø 30mm

Gewicht 180g
weight 180g
peso 180g
poids 180g

DOYEN
410-629
210mm, 8 1/4"

Kopf Ø 35mm
head Ø 35mm
cabeza Ø 35mm
tete Ø 35mm

Gewicht 260g
weight 260g
peso 260g
poids 260g



mit Bleifüllung
lead filled
con relleno de plomo
remplissage de plomb

410-604
190mm, 7 1/2"

Kopf Ø 22mm
head Ø 22mm
cabeza Ø 22mm
tete Ø 22mm
Gewicht 165g
weight 165g
peso 165g
poids 165g



HEATH
410-606
185mm, 7 1/4"

Kopf Ø 40mm
head Ø 40mm
cabeza Ø 40mm
tete Ø 40mm
Gewicht 600g
weight 600g
peso 600g
poids 600g

HEATH
410-607
200mm, 8"

Kopf Ø 45mm
head Ø 45mm
cabeza Ø 45mm
tete Ø 45mm
Gewicht 1000g
weight 1000g
peso 1000g
poids 1000g



mit Bleifüllung
lead filled
con relleno de plomo
remplissage de plomb

410-608
165mm, 6 1/2"

Kopf Ø 20mm
head Ø 20mm
cabeza Ø 20mm
tete Ø 20mm
Gewicht 140g
weight 140g
peso 140g
poids 140g



mit Bleifüllung
lead filled
con relleno de plomo
remplissage de plomb

WILLIGER
410-613
240mm, 9 1/2"

Kopf Ø 28mm
head Ø 28mm
cabeza Ø 28mm
tete Ø 28mm
Gewicht 340g
weight 340g
peso 340g
poids 340g



WILLIGER
410-614
240mm, 9 1/2"

Kopf Ø 30mm
head Ø 30mm
cabeza Ø 30mm
tete Ø 30mm
Gewicht 400g
weight 400g
peso 400g
poids 400g



OMBREDANNE
410-660
250mm, 10"

Kopf Ø 40mm
head Ø 40mm
cabeza Ø 40mm
tete Ø 40mm
Gewicht 550g
weight 550g
peso 550g
poids 550g



PARTSCH
410-616
180mm, 7"

Kopf Ø 22mm
head Ø 22mm
cabeza Ø 22mm
tete Ø 22mm
Gewicht 200g
weight 200g
peso 200g
poids 200g



410-632
265mm, 10 1/2"

Kopf Ø 30mm	Gewicht 450g
head Ø 30mm	weight 450g
cabeza Ø 30mm	peso 450g
tete Ø 30mm	poids 450g



410-634
265mm, 10 1/2"

Kopf Ø 50mm	Gewicht 900g
head Ø 50mm	weight 900g
cabeza Ø 50mm	peso 900g
tete Ø 50mm	poids 900g



410-636
240mm, 9 1/2"

Kopf Ø 37mm	Gewicht 370g
head Ø 37mm	weight 370g
cabeza Ø 37mm	peso 370g
tete Ø 37mm	poids 370g



410-637

Ersatzbacken (Paar), Kunststoff
Spare Facings (pair), plastic
Tapas de repuesto (par), plastico
Plaques de rechange (paire), plastique



410-646
260mm, 10 1/4"

Kopf Ø 30mm	Gewicht 450g
head Ø 30mm	weight 450g
cabeza Ø 30mm	peso 450g
tete Ø 30mm	poids 450g



410-648
240mm, 9 1/2"

Kopf Ø 30mm	Gewicht 480g
head Ø 30mm	weight 480g
cabeza Ø 30mm	peso 480g
tete Ø 30mm	poids 480g



410-656
265mm, 10 1/2"

Kopf Ø 30/42mm	Gewicht 650g
head Ø 30/42mm	weight 650g
cabeza Ø 30/42mm	peso 650g
tete Ø 30/42mm	poids 650g



410-670
260mm, 10 1/4"

Kopf Ø 42mm	Gewicht 250g
head Ø 42mm	weight 250g
cabeza Ø 42mm	peso 250g
tete Ø 42mm	poids 250g

410-671

Kopf Ø 42mm	Gewicht 400g
head Ø 42mm	weight 400g
cabeza Ø 42mm	peso 400g
tete Ø 42mm	poids 400g

mit Bleifüllung
lead filled
con relleno de plomo
remplissage de plomb



410-668
180mm, 7"

Kopf Ø 30mm	Gewicht 125g
head Ø 30mm	weight 125g
cabeza Ø 30mm	peso 125g
tete Ø 30mm	poids 125g

ELCON 410

STÖSSEL, FLACHMEISSEL, OSTEOTOME UND HOHLMEISSEL
TAMPERS, CHISELS, OSTEOTOMES, GOUGES
PUNZONES, CINCELES, OSTEOTOMOS Y GUBIAS
PILONS, CISEAUX-BURINS, OSTEOTOMES ET GOUGES

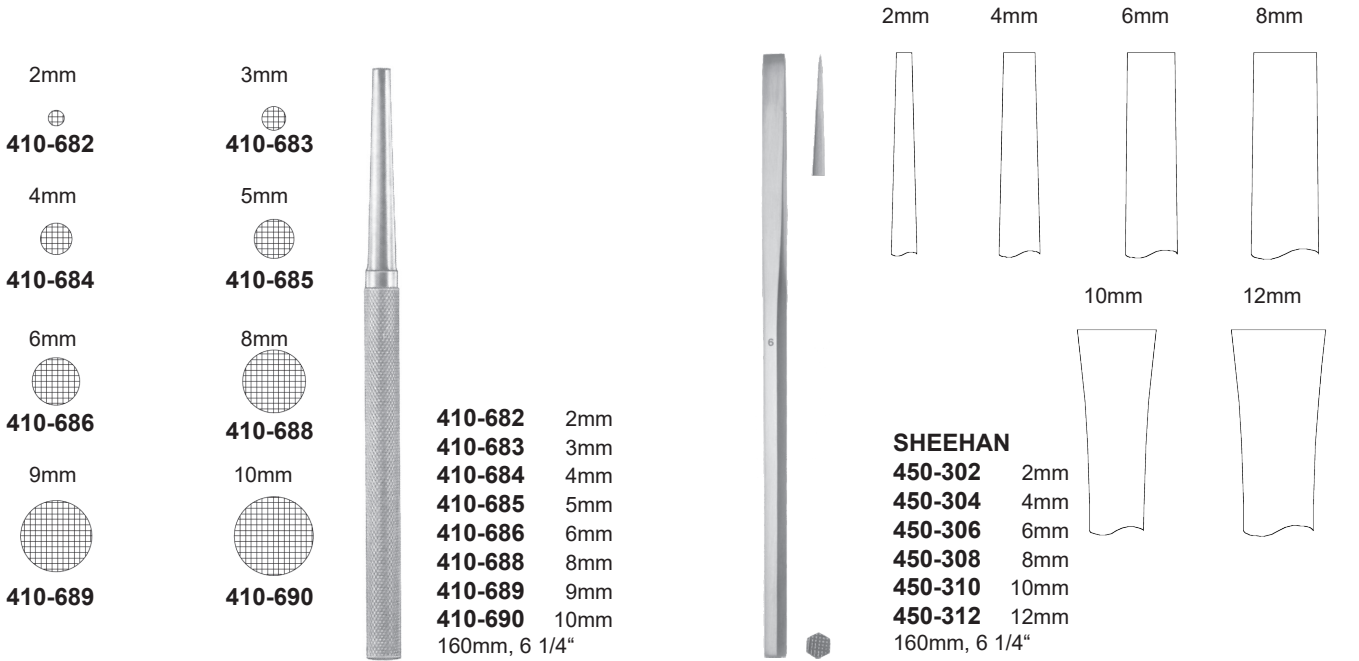

FREER
440-500
165mm, 6 1/2"



FREER
440-501
165mm, 6 1/2"



FREER
440-504
150mm, 6 1/2"



KILLIAN
440-591
160mm, 6 1/4"



KILIAN-CLAUS
440-593
160mm, 6 1/4"

2mm



3mm



4mm



5mm



6mm



PARTSCH

- 410-900** 2mm
 - 410-901** 3mm
 - 410-902** 4mm
 - 410-903** 5mm
 - 410-904** 6mm
- 135mm, 5 1/4"



PARTSCH

- 410-930** 2mm
 - 410-931** 3mm
 - 410-932** 4mm
 - 410-933** 5mm
 - 410-934** 6mm
- 170mm, 6 3/4"

2mm



3mm



4mm



5mm



6mm



PARTSCH

- 410-910** 2mm
 - 410-911** 3mm
 - 410-912** 4mm
 - 410-913** 5mm
 - 410-914** 6mm
- 135mm, 5 1/4"



PARTSCH

- 410-940** 2mm
 - 410-941** 3mm
 - 410-942** 4mm
 - 410-943** 5mm
 - 410-944** 6mm
- 170mm, 6 3/4"



410-960
4mm

410-961
6mm

410-962
8mm

410-963
10mm

410-964
12mm

410-965
14mm

ALEXANDER
410-960 - 410-965
 180mm, 7"



410-970
4mm

410-971
6mm

410-972
8mm

410-973
10mm

410-974
12mm

410-975
14mm

ALEXANDER
410-970 - 410-975
 180mm, 7"

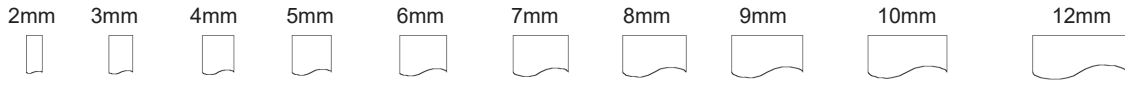

BUCKLEY

411-2612 2mm
411-2613 3mm
411-2614 4mm
160mm, 6 1/4"

Hohlmeißel
GOUGES
GUBIAS
GOUGES



CARROLL

440-530 3mm
440-532 6mm
440-534 10mm
440-536 12mm
140mm, 5 1/2"

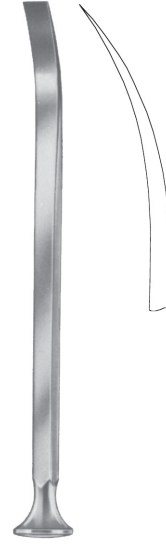

CARROLL

440-540 3mm
440-542 6mm
440-544 10mm
440-546 12mm
140mm, 5 1/2"



LUCAS

410-720-04 4mm
410-720-06 6mm
160mm, 6 1/4"



LUCAS

410-722-03 3mm
410-722-05 5mm
160mm, 6 1/4"



EASTgRINSTEAD

453-103 3mm
453-105 5mm
180mm, 7"



EASTgRINSTEAD

453-113 3mm
453-115 5mm
180mm, 7"

OSTEOTOME
OSTEOTOMES
OSTEOTOMOS
OSTEOTOMES

ELCON 410

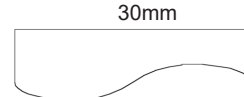
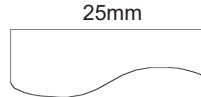
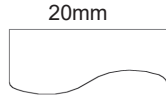
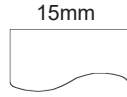
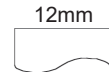

MINI-LAMBOTTE

- 411-200 2mm
- 411-201 3mm
- 411-202 4mm
- 411-203 6mm
- 411-204 8mm
- 411-205 10mm
- 411-206 12mm
- 411-207 15mm
- 125mm, 5"



MINI-LAMBOTTE

- 411-210 2mm
- 411-211 3mm
- 411-212 4mm
- 411-213 6mm
- 411-214 8mm
- 411-215 10mm
- 411-216 12mm
- 411-217 15mm
- 170mm, 6 3/4"



LAMBOTTE

- 411-220 4mm
- 411-221 6mm
- 411-222 8mm
- 411-223 10mm
- 411-224 13mm
- 411-225 16mm
- 411-226 18mm
- 411-227 20mm
- 411-228 25mm
- 411-229 30mm
- 411-230 38mm
- 411-231 44mm
- 411-232 50mm
- 240mm, 9 1/2"



LAMBOTTE

- 411-240 4mm
- 411-241 6mm
- 411-242 8mm
- 411-243 10mm
- 411-244 13mm
- 411-245 16mm
- 411-246 18mm
- 411-247 20mm
- 411-248 25mm
- 411-249 30mm
- 411-250 38mm
- 411-251 44mm
- 411-252 50mm
- 240mm, 9 1/2"



COTTLE

- 450-319 2mm
- 450-320 4mm
- 450-321 5mm
- 450-322 6mm
- 450-323 7mm
- 450-324 8mm
- 450-325 9mm
- 450-326 10mm
- 450-328 12mm
- 180mm, 7"



COTTLE

- 450-330 4mm
- 450-332 6mm
- 180mm, 7"



COTTLE

- 450-334 4mm
- 450-335 7mm
- 450-336 9mm
- 450-337 12mm
- 180mm, 7"

6mm

8mm

10mm

12mm

15mm

20mm

25mm

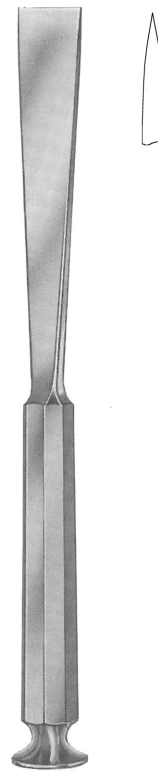
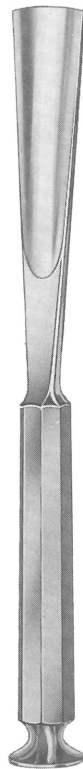
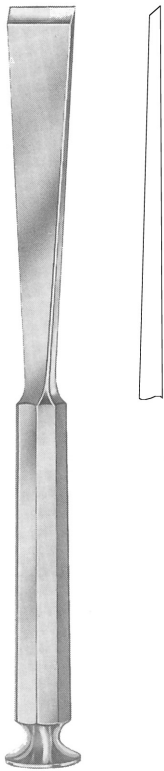
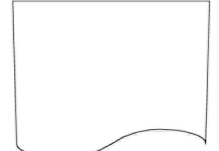
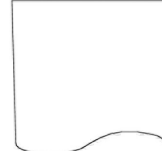

STILLE

410-796 6mm
410-798 8mm
410-800 10mm
410-802 12mm
410-804 15mm
410-806 20mm
410-808 25mm
200mm, 8"

STILLE

410-816 6mm
410-818 8mm
410-820 10mm
410-822 12mm
410-824 15mm
410-826 20mm
410-828 25mm
200mm, 8"

STILLE

410-836 6mm
410-838 8mm
410-840 10mm
410-842 12mm
410-844 15mm
410-846 20mm
410-848 25mm
200mm, 8"

OSTEOTOME, HOHLMEISSEL
 OSTEOTOMES, GOUGES
 OSTEOTOMOS, GUBIAS
 OSTEOTOMES, GOUGES

ELCON
410

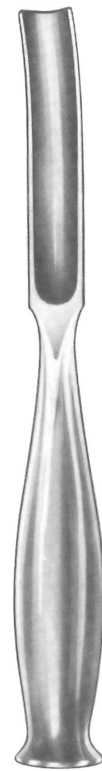
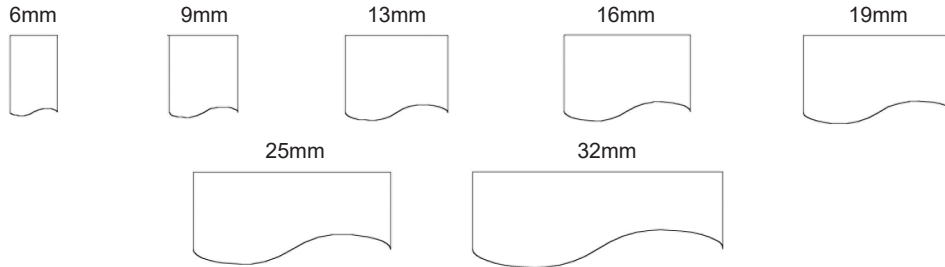

SMITH-PETERSON
411-162-06 6mm
411-162-09 9mm
411-162-13 13mm
411-162-16 16mm
411-162-19 19mm
411-162-25 25mm
411-162-32 32mm
 200mm, 8"

SMITH-PETERSON
411-163-06 6mm
411-163-09 9mm
411-163-13 13mm
411-163-16 16mm
411-163-19 19mm
411-163-25 25mm
411-163-32 32mm
 200mm, 8"

SMITH-PETERSON
411-160-06 6mm
411-160-09 9mm
411-160-13 13mm
411-160-16 16mm
411-160-19 19mm
411-160-25 25mm
411-160-32 32mm
 200mm, 8"

SMITH-PETERSON
411-161-06 6mm
411-161-09 9mm
411-161-13 13mm
411-161-16 16mm
411-161-19 19mm
411-161-25 25mm
411-161-32 32mm
 200mm, 8"

ELCON 410

OSTEOTOME, HOHLMEISSEL
OSTEOTOMES, GOUGES
OSTEOTOMOS, GUBIAS
OSTEOTOMES, GOUGES

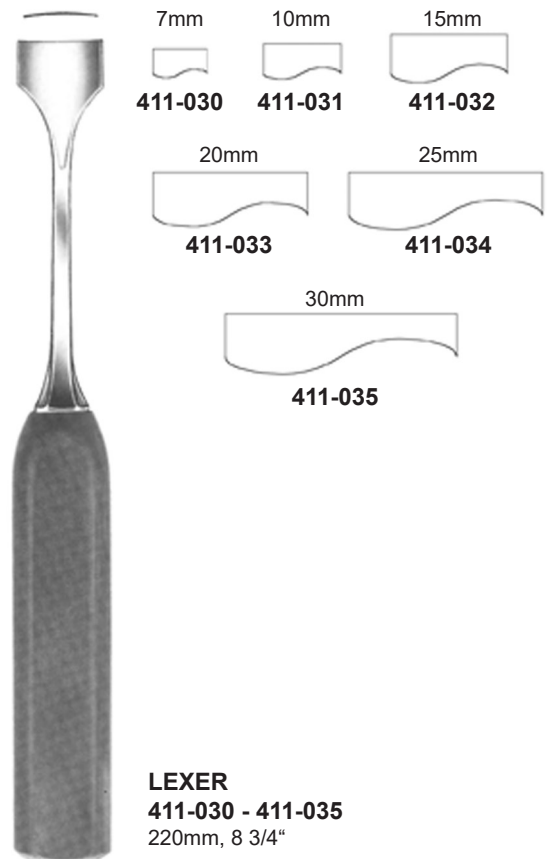
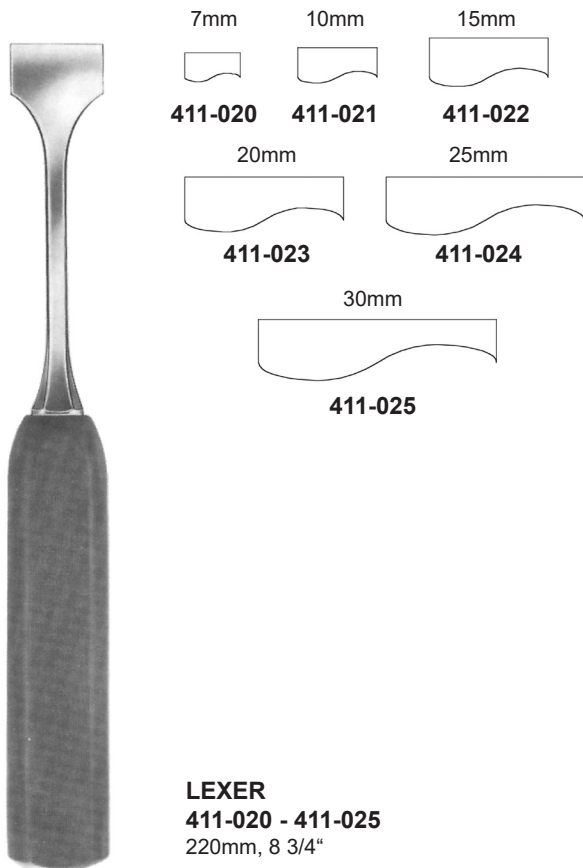
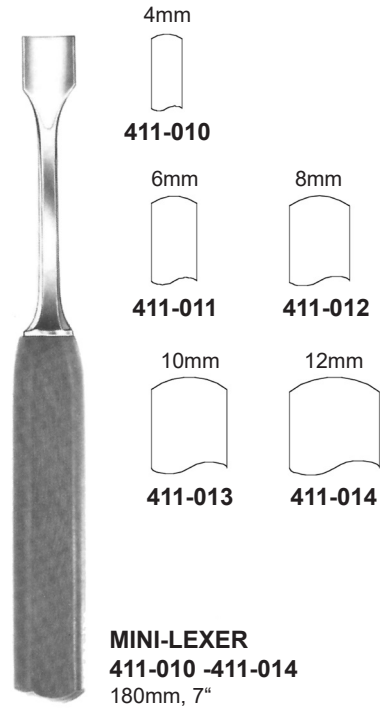
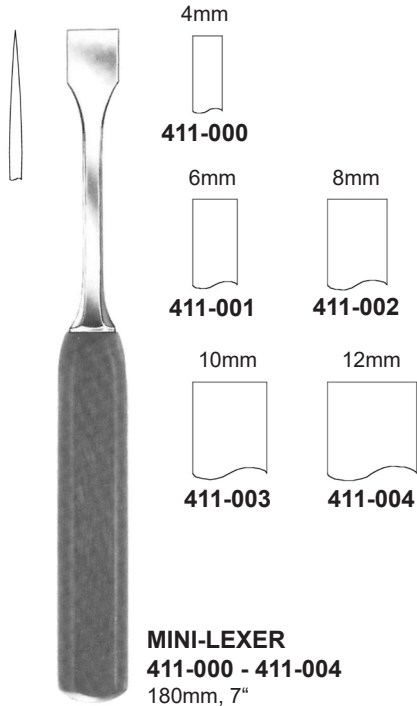

FLACHMEISSEL, HOHLMEISSEL
 CHISELS, GOUGES
 CINCELES, GUBIAS
 CISEAUX-BURIN, GOUGES

ELCON
410

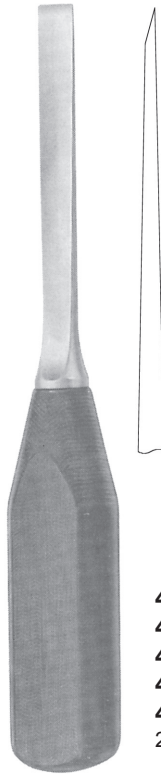

411-2620 4mm
411-2622 6mm
411-2624 10mm
411-2626 15mm
411-2628 20mm,
 200mm,

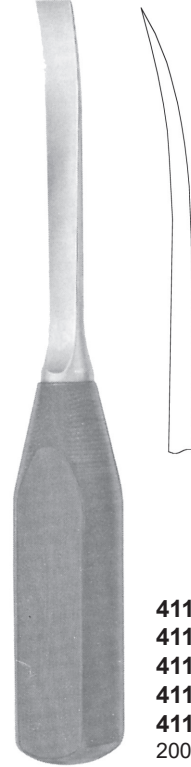

411-2621 4mm
411-2623 6mm
411-2625 10mm
411-2627 15mm
411-2629 20mm,
 200mm,



5mm

411-050

10mm

411-052

15mm

411-054

LEXER
411-050 - 411-054
 250mm, 10"



5mm

411-051

10mm

411-053

15mm

411-055

LEXER
411-051 - 411-055
 250mm, 10"



COBB
411-080
280mm, 11"



COBB
411-081
280mm, 11"



COBB
411-082
280mm, 11"



COBB
411-083
280mm, 11"



411-303
130mm, 5 1/4"



411-307
145mm, 5 3/4"

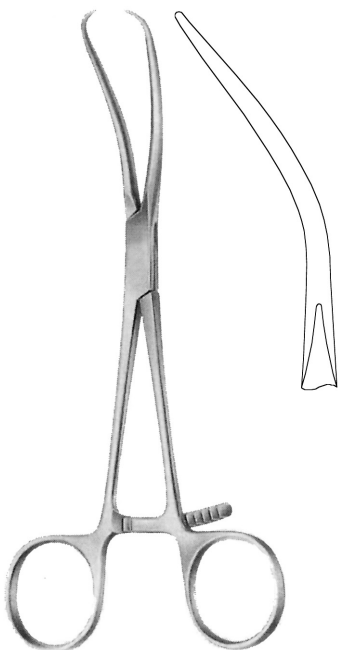

411-308
170mm, 6 3/4"

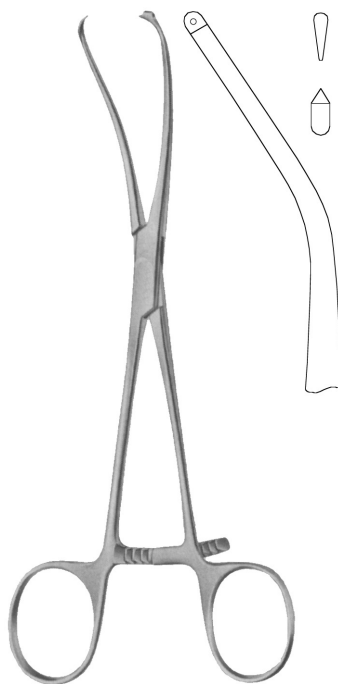

411-3046
170mm, 6 3/4"



411-313
205mm, 8"

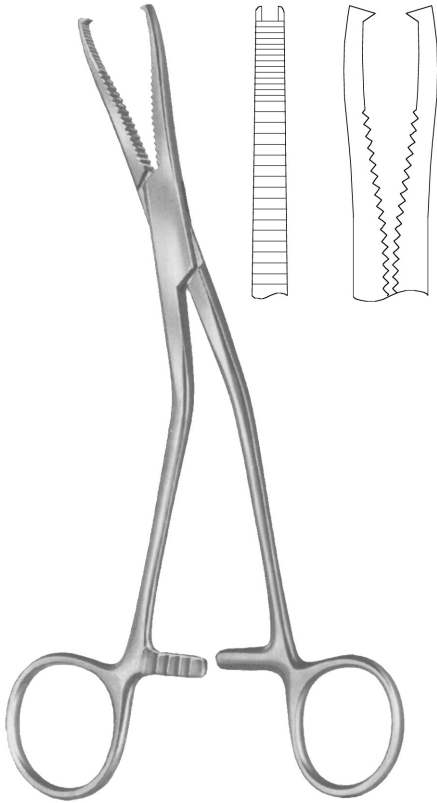

DINGMANN
411-310
190mm, 7 ½"

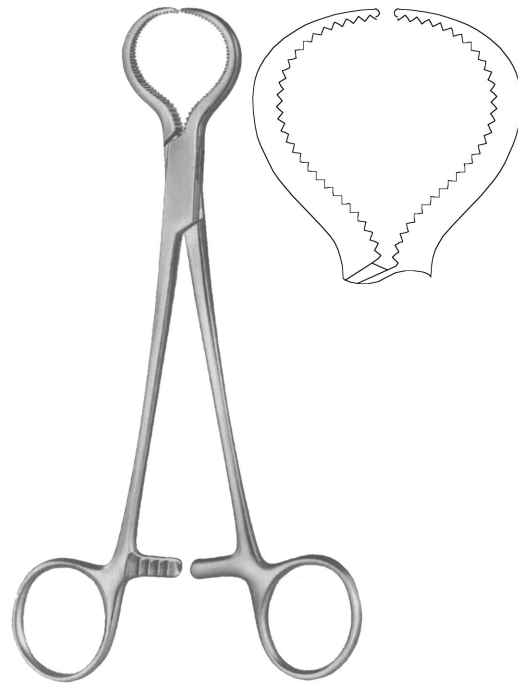

LEWIN
411-330
180mm, 7"



411-309
135mm, 5 ¼"

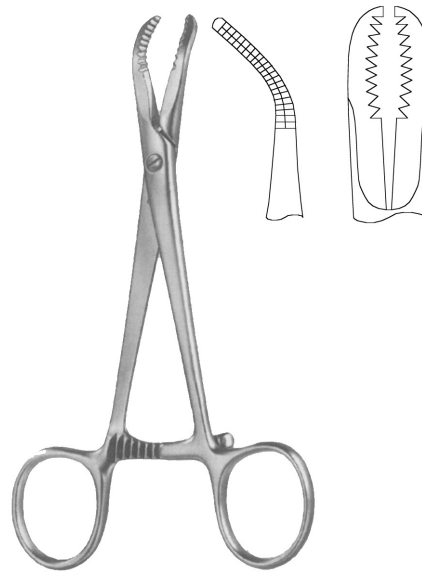

411-319
140mm, 5 ½"



LANGENBECK
411-322
 210mm, 8 1/4"



FERGUSON
411-324
 210mm, 8 1/4"

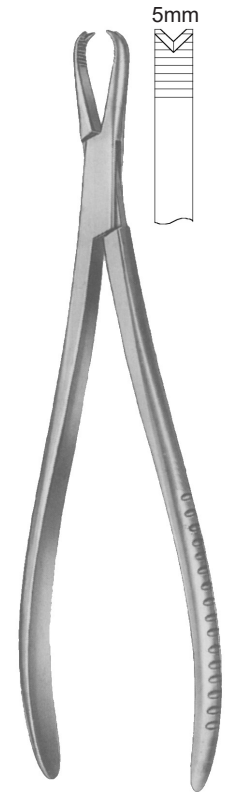

411-320
 200mm, 8"

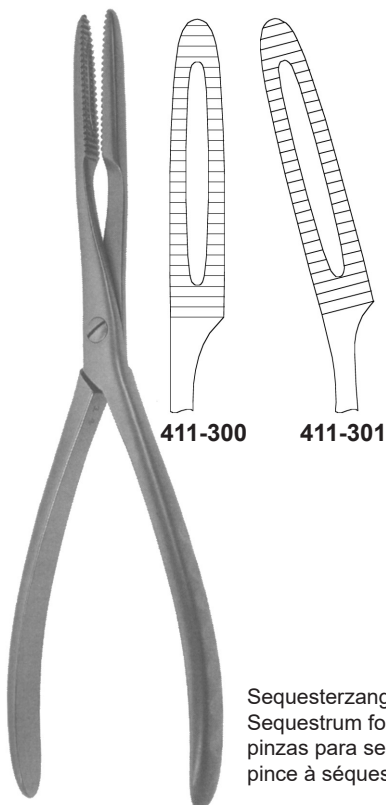

411-300 200mm, 8"
411-301 200mm, 8"

Sequesterzange
 Sequestrum forceps
 pinzas para secuestro
 pince à séquestre

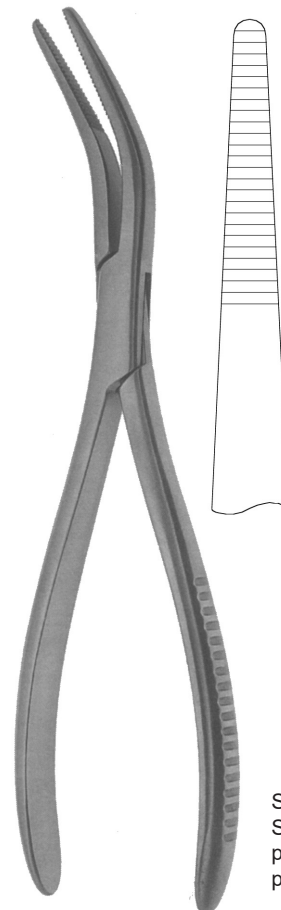

VAN BUREN
411-305
 225mm, 8 3/4"

Sequesterzange
 Sequestrum forceps
 pinzas para secuestro
 pince à séquestre

max. Öffnung 15mm
max. opening 15mm
max. abertura 15mm
max. écartement 15mm



LAHEY
411-316
135mm, 5 ¼"

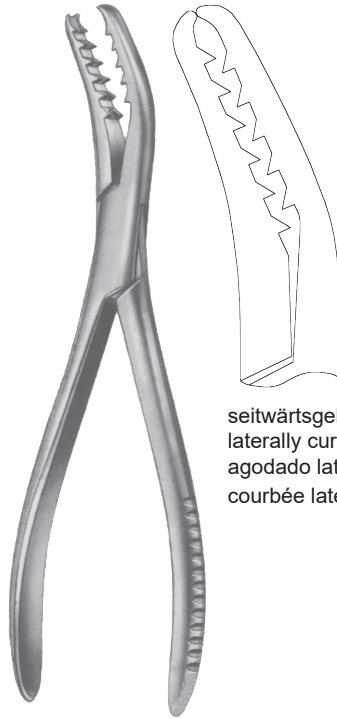

seitwärtsgebogen
laterally curved
agodado lateralmente
courbée latéralement

SEMB
250-900
190mm, 7 ½"



SEMB
250-901
190mm, 7 ½"

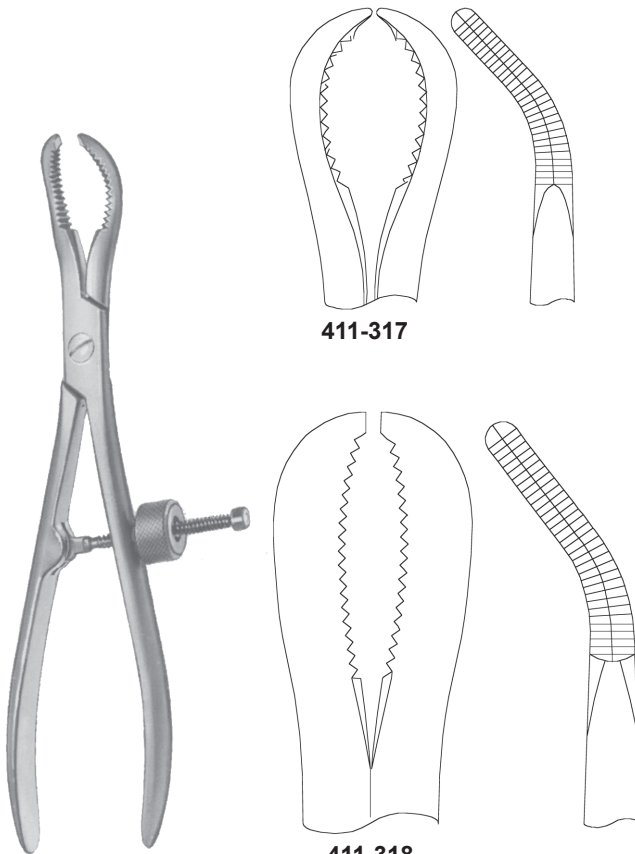

411-317

411-318

411-317 170mm, 6 ¾"
411-318 240mm, 9 ½"

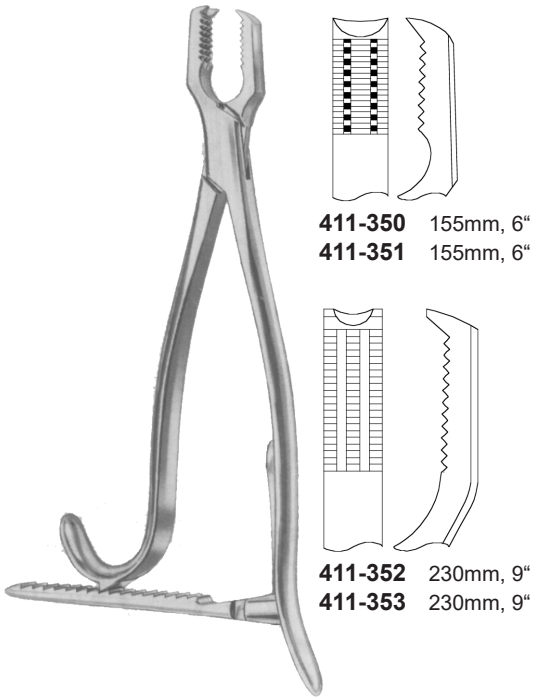

411-350 155mm, 6"

411-351 155mm, 6"

411-352 230mm, 9"

411-353 230mm, 9"

KERN

411-350

411-352

ohne Sperre
 without ratchet
 sin cremallera
 sans crémaillère

411-351

411-353

mit Sperre
 with ratchet
 con cremallera
 avec crémaillère

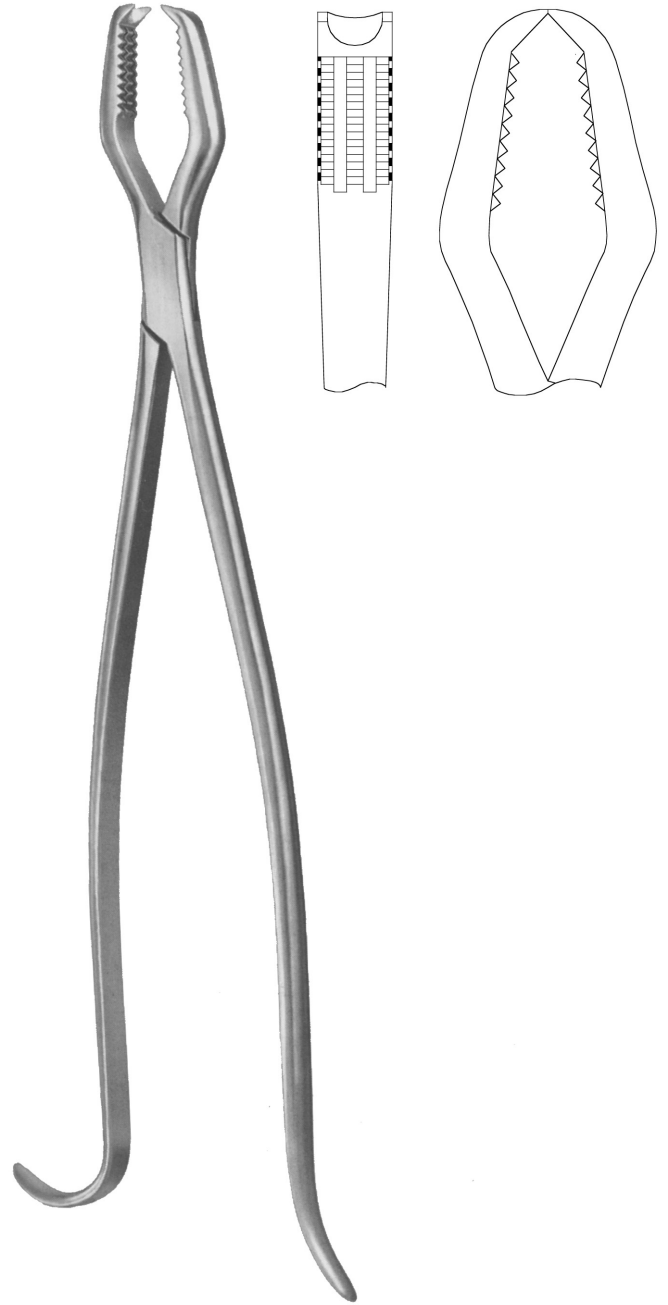

LANE

411-356

330mm, 13"

ohne Sperre
 without ratchet
 sin cremallera
 sans crémaillère

411-357

330mm, 13"

mit Sperre
 with ratchet
 con cremallera
 avec crémaillère

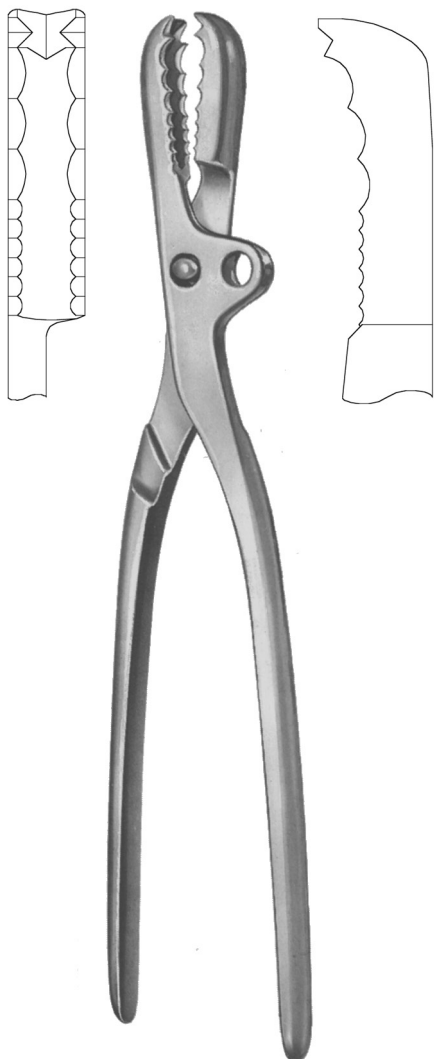

FARABEUF

411-341 230mm, 9"

411-342 260mm, 10 1/4"



FARABEUF-LAMBOTTE

411-340 260mm, 10 1/4"

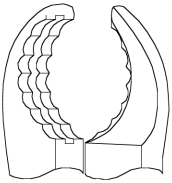

411-390
411-391

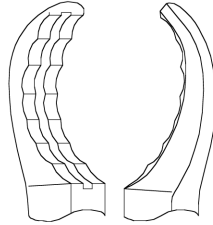

411-392
411-393

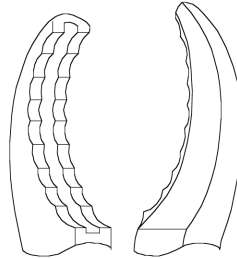

411-394
411-395



ULRICH
411-390 230mm, 9"
411-392 250mm, 10"
411-394 280mm, 11"

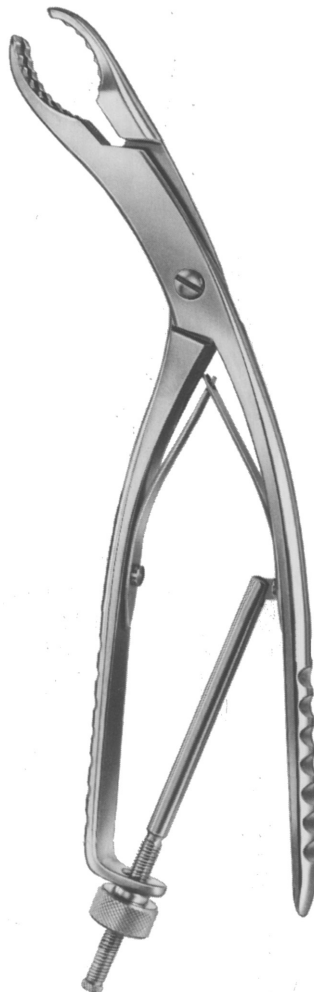

ULRICH
411-391 220mm, 8 3/4"
411-393 240mm, 9 1/2"
411-395 270mm, 10 3/4"

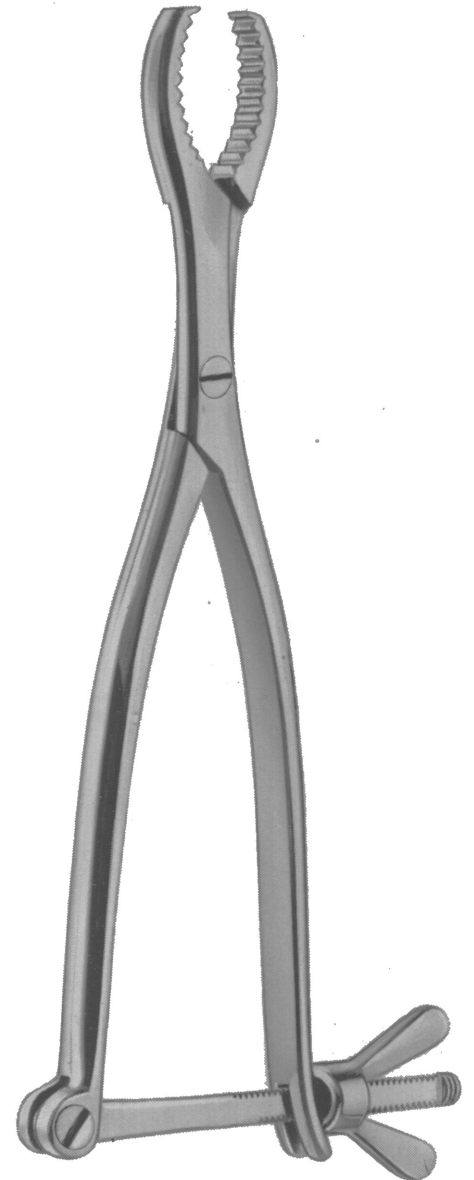

HEY-GROVES
411-345 200mm, 8"
411-346 250mm, 10"
411-347 305mm, 12"

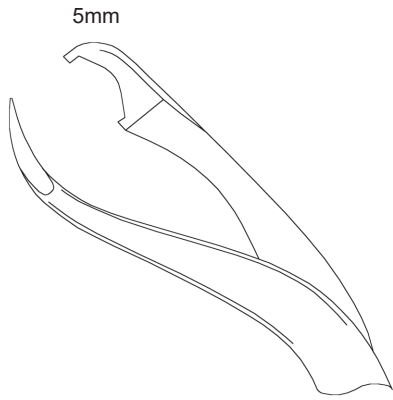

411-370



VERBRUGGE
411-370 175mm, 7"

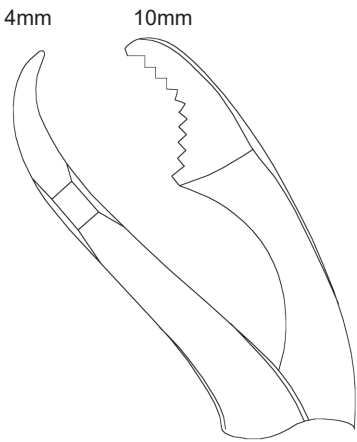

411-371

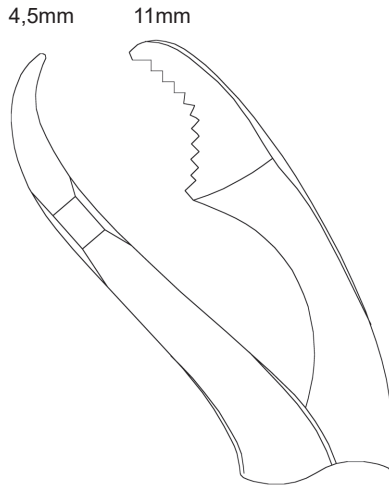

411-372



VERBRUGGE
411-371 255mm, 10"
411-372 265mm, 10 1/2"
411-373 275mm, 10 3/4"

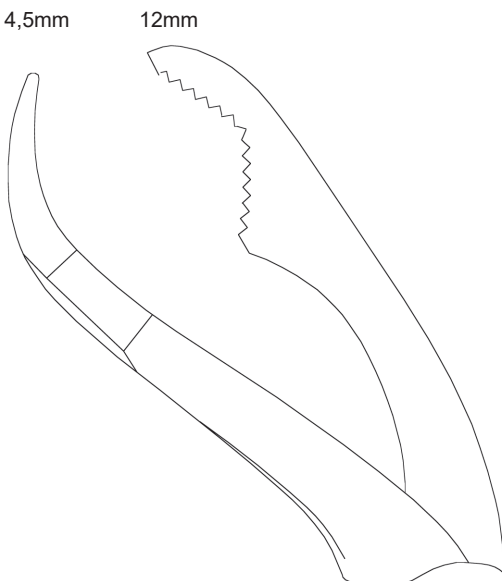

411-373

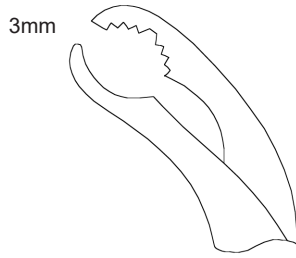

411-375

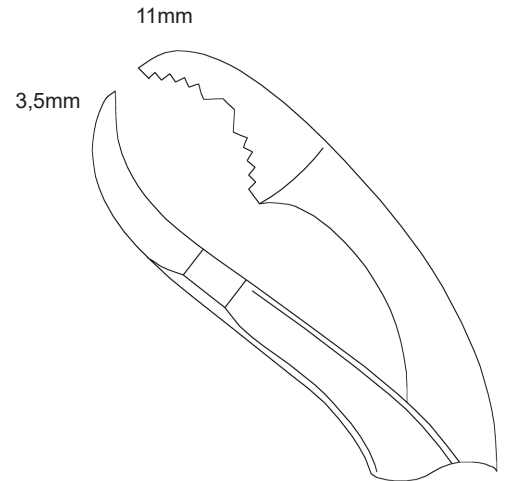

411-378

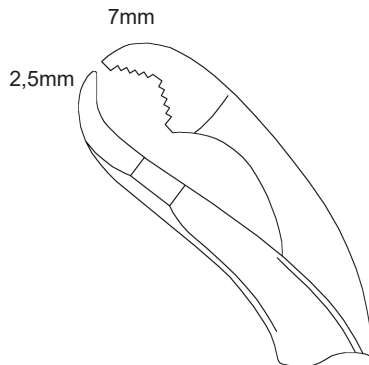

411-376

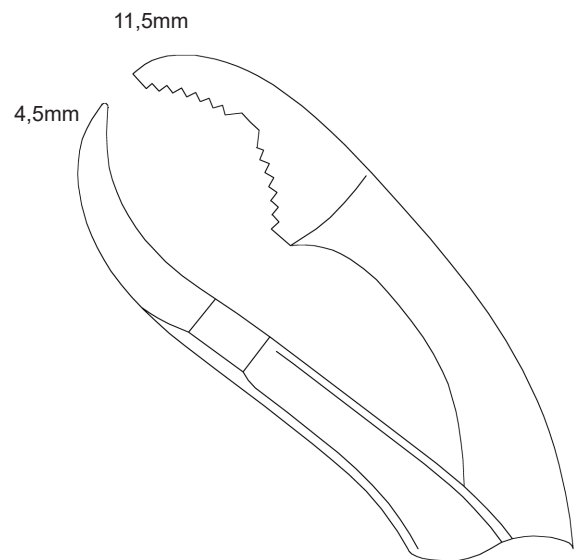

411-379

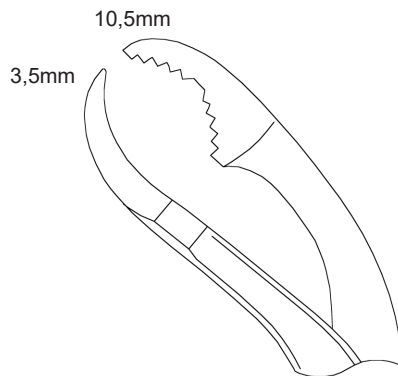

411-377

- 411-375** 150mm, 6"
- 411-376** 190mm, 7 1/2"
- 411-377** 240mm, 9 1/2"
- 411-378** 260mm, 10 1/4"
- 411-379** 280mm, 11"

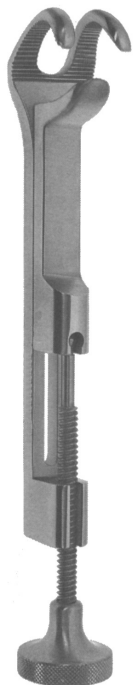

LOWMAN

- 411-400** 120mm, 4 3/4"
- 411-401** 185mm, 7 1/4"
- 411-402** 200mm, 8"
- 411-403** 220mm, 8 3/4"

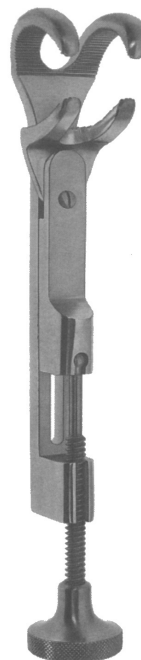

beweglich
movable
movible
mobile

LOWMAN-HOGLUND

- 411-411** 185mm, 7 1/4"
- 411-412** 200mm, 8"

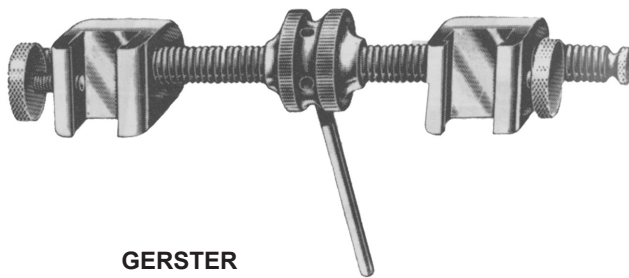

**GERSTER
411-450**

Distraktionsklammer für Knochenklemmen.
Traction bar for Lowman bone clamps.
Barra de tracción para pinzas Lowman.
Tracteur pour daviers Lowman.

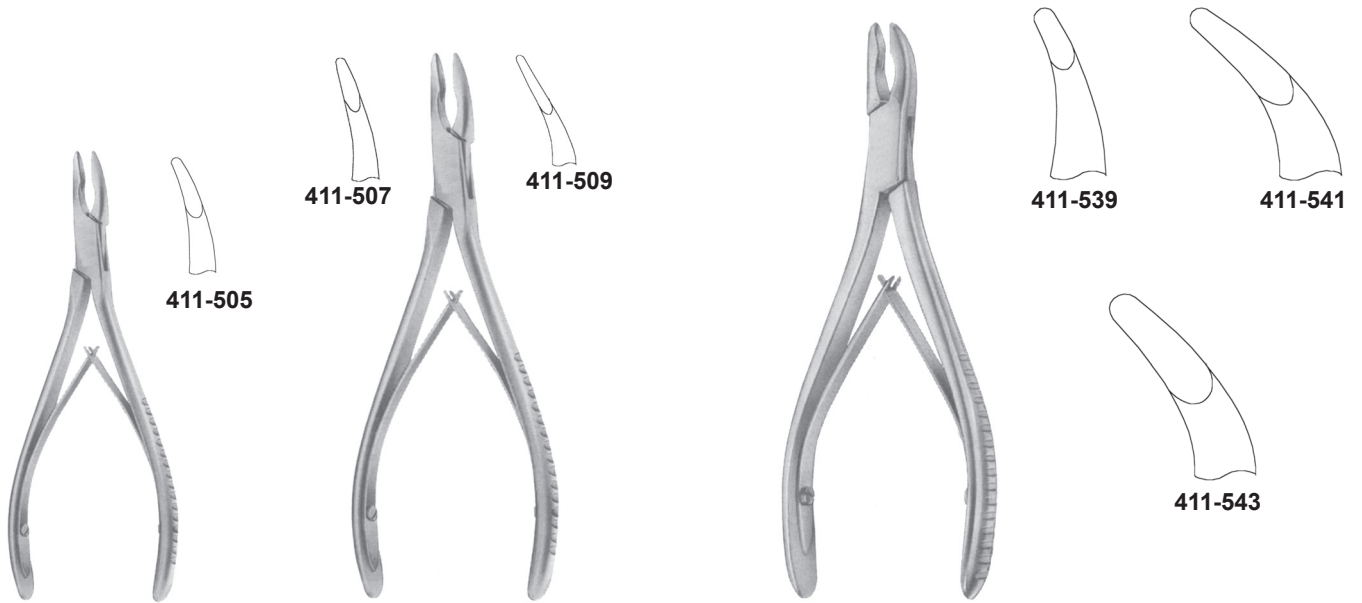

MINI FRIEDMANN
411-505 125mm, 5"

FRIEDMANN
411-507 135mm, 5 1/4"
411-509 135mm, 5 1/4"

LUER
411-539 145mm, 5 3/4"
411-541 145mm, 5 1/4"
411-543 145mm, 5 3/4"

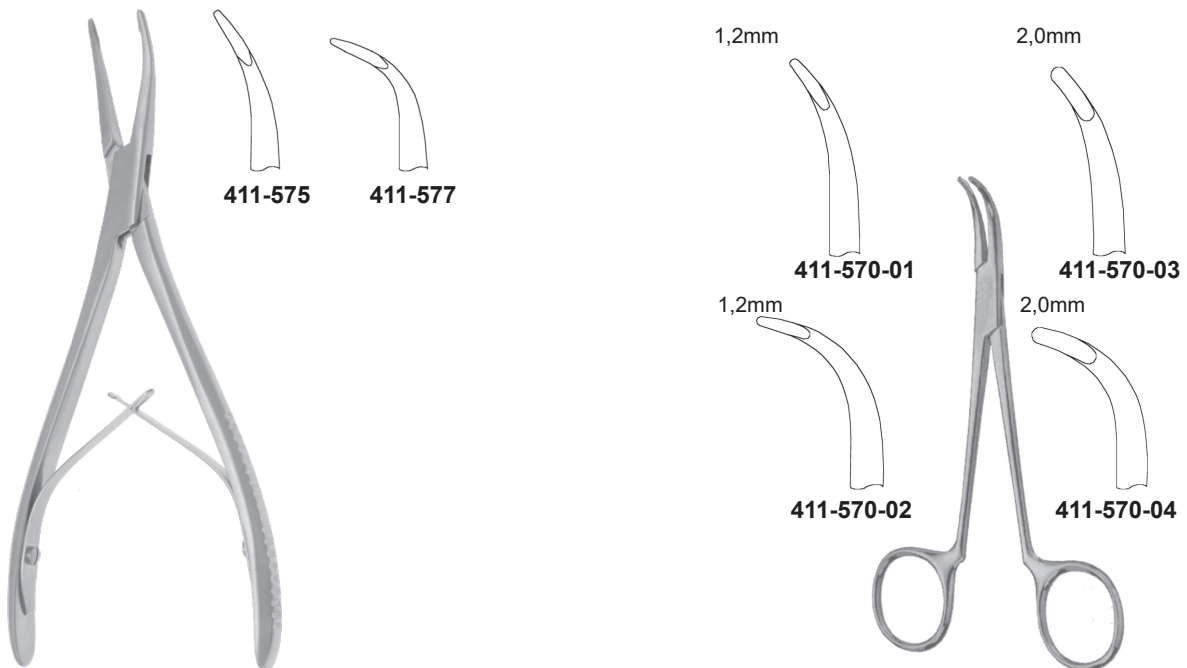

STELLBRINK
411-575 175mm, 6 3/4"
411-577 170mm, 6 3/4"

411-570-01 1,2mm
411-570-02 1,2mm
411-570-03 2,0mm
411-570-04 2,0mm
 130mm, 5 1/8"

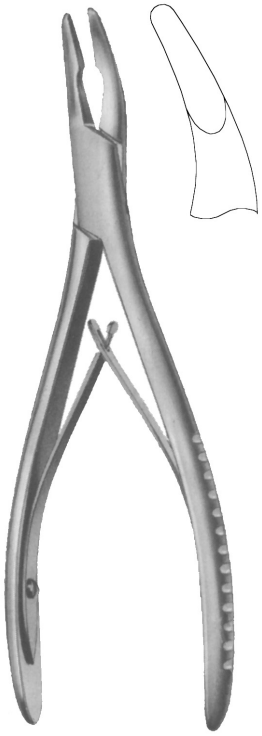

HARTMANN
411-503 175mm, 6 7/8"

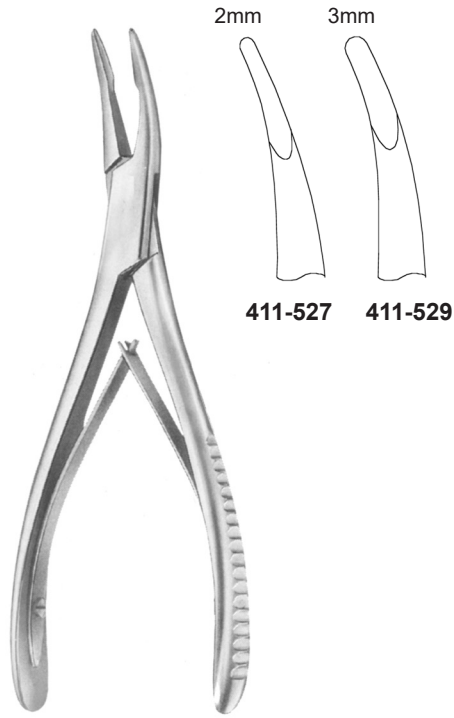

BEYER
411-527 175mm, 6 7/8"
411-529 175mm, 6 7/8"

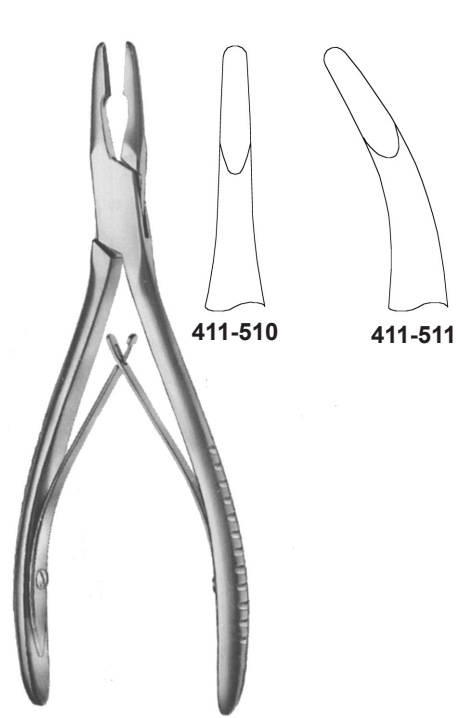

JANSEN
411-510 175mm, 6 7/8"
411-511 175mm, 6 7/8"

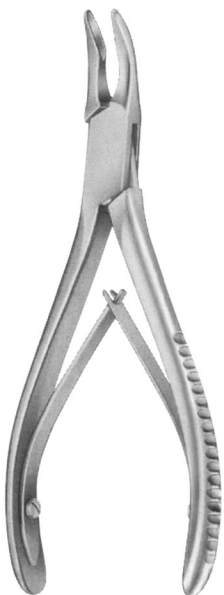

BLUMENTHAL
411-565 - 411-569

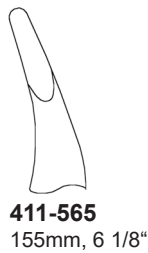

411-565
155mm, 6 1/8"



411-567
150mm, 6"

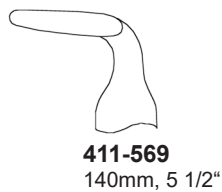

411-569
140mm, 5 1/2"

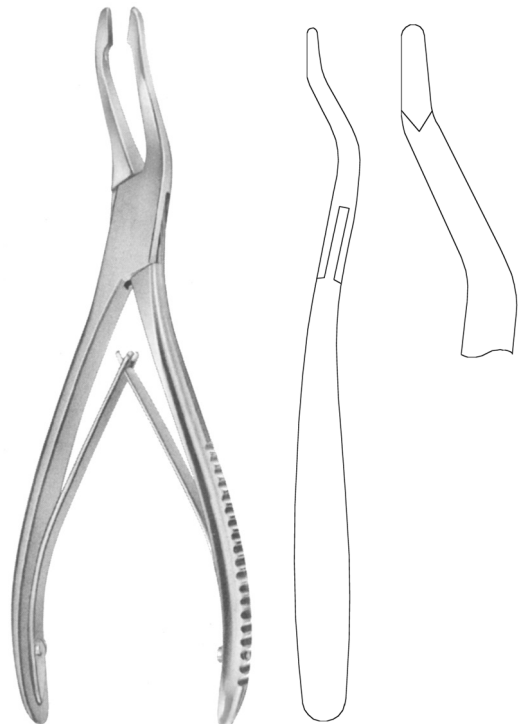

JANSEN
411-513 190mm, 7 1/2"

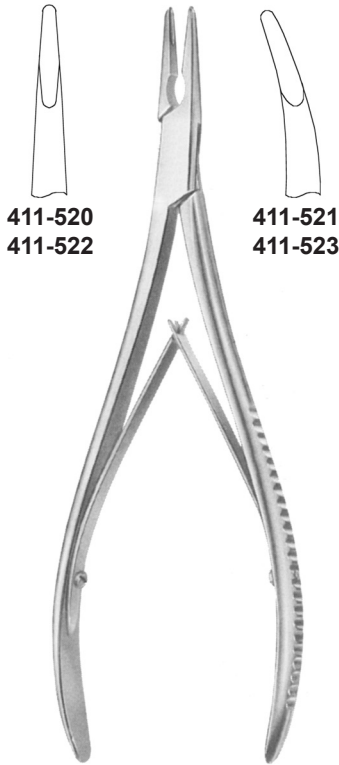

411-520
 411-522

411-521
 411-523

LEMPERT

411-520 160mm, 6 1/4" 411-521
 411-522 190mm, 7 1/2" 411-523

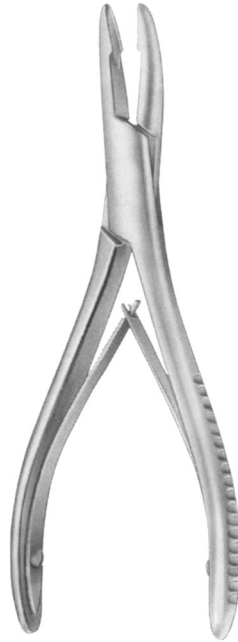

411-583

411-589

MEAD

411-583 165mm, 6 1/2"
 411-589 165mm, 6 1/2"



NORTHFIELD

411-553 210mm, 8 1/4"



8mm

8mm

411-548

411-549

LUER

411-548 175mm, 6 7/8"
 411-549 175mm, 6 7/8"



10mm

10mm

411-546

411-547

LUER

411-546 180mm, 7"
 411-547 180mm, 7"

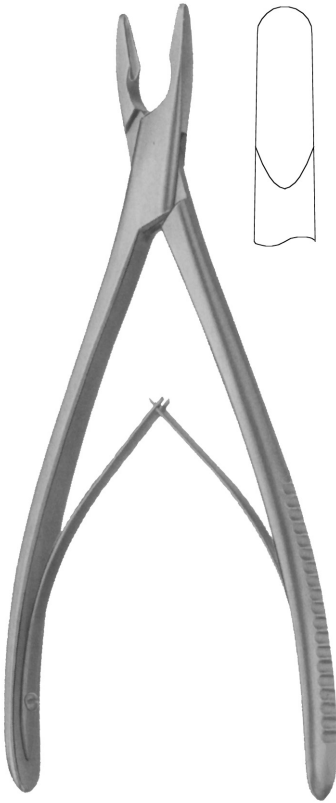

ADSON
343-714 205mm, 8"

Schädel Rongeur
Cranial Rongeur
Gubia craneal
Rongeur cranién

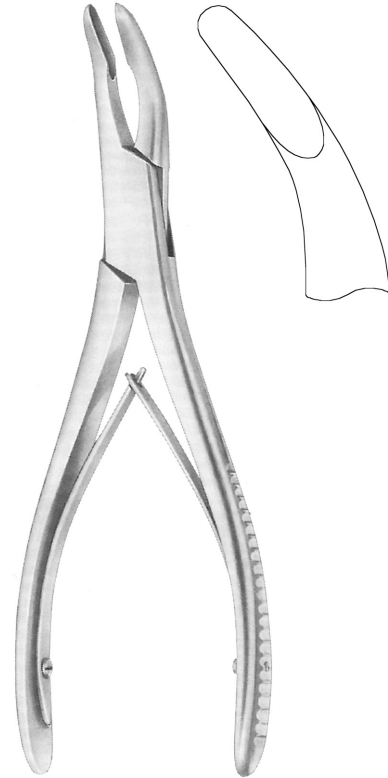

OLIVECRONA
411-535 205mm, 8"

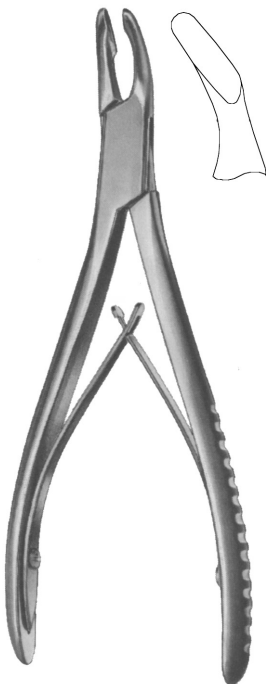

CLEVELAND
411-593 135mm, 5 1/4"
411-595 165mm, 6 1/2"

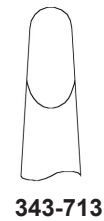
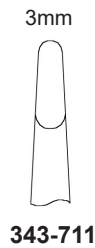

STOOKEY **BACON**
343-711 200mm, 8" **343-713**

Schädel Rongeur
Cranial Rongeur
Gubia craneal
Rongeur cranién

HOHLMEISSELZANGEN
 BONE RONGEURS
 PINZAS GUBIAS
 PINCES GOUGES

ELCON
410

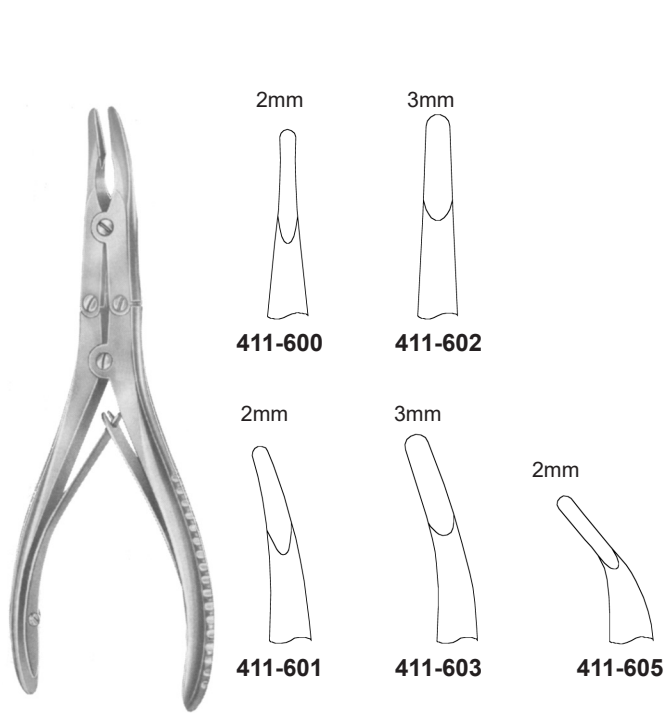

BOEHLER
 411-600 - 411-605
 150mm, 6"



MAYFIELD
 411-611 170mm, 6 3/4"

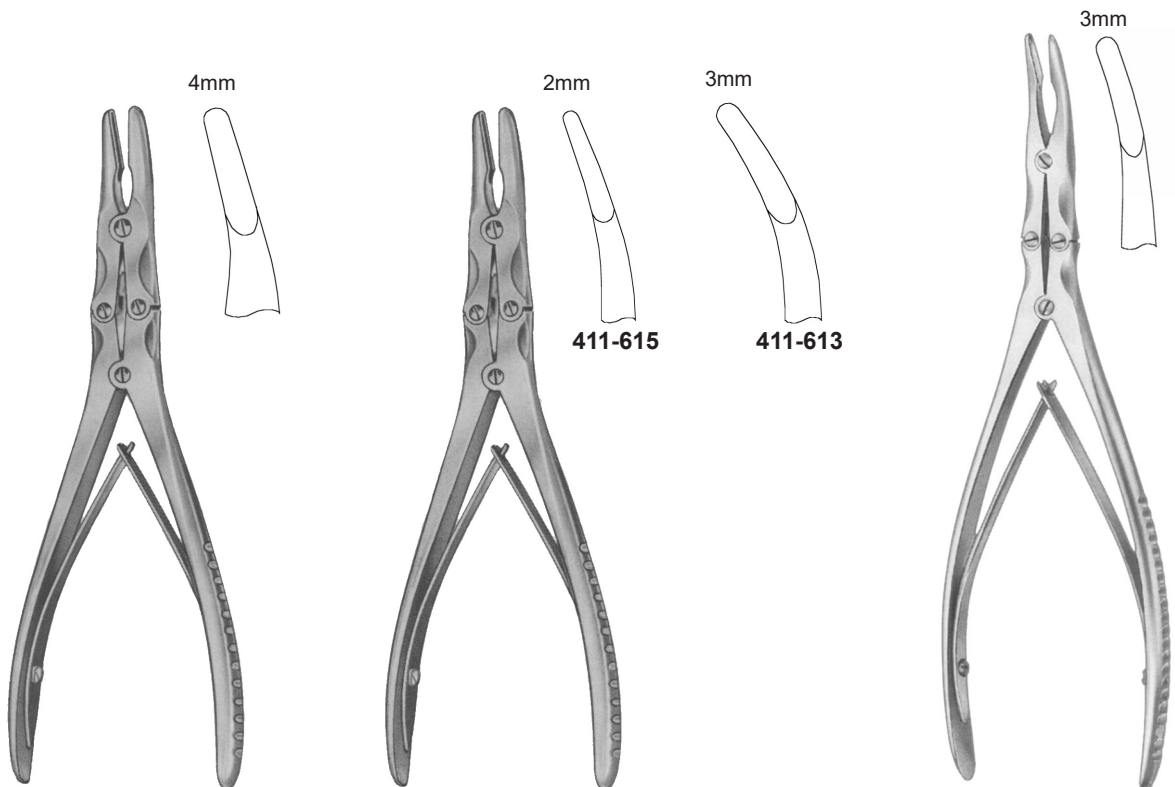

ZAUFAL-JANSEN
 411-617 180mm, 7"

BEYER
 411-613 - 411-615
 180mm, 7"

MARQUART
 411-619 200mm, 8"



4mm



411-620

6mm



411-624

4mm



411-621

6mm



411-625

RUSKIN
411-620 - 411-625
180mm, 7"



5mm



ROETTGEN-RUSKIN
411-631
240mm, 9 1/2"

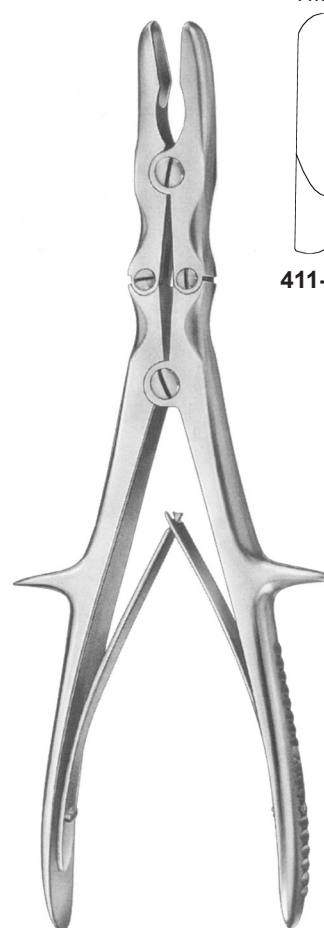

7mm



411-632

7mm



411-633

RUSKIN-STILLE
411-632-411-633
240mm, 9 1/2"

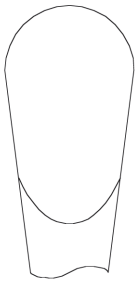

411-670
 411-672



411-671
 411-673

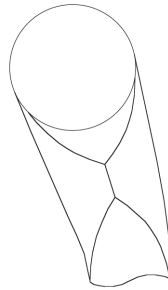

411-681

10mm



411-660

10mm

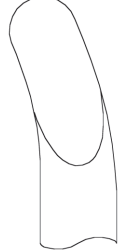

411-661



STILLE LUER
 411-670 230mm, 9" 411-671
 411-672 270mm, 10 1/2" 411-673



SEMB
 411-681 235mm, 9 1/4"



STILLE LUER
 411-660 225mm, 8 3/4" 411-661



STILLE
411-651 230mm, 9"

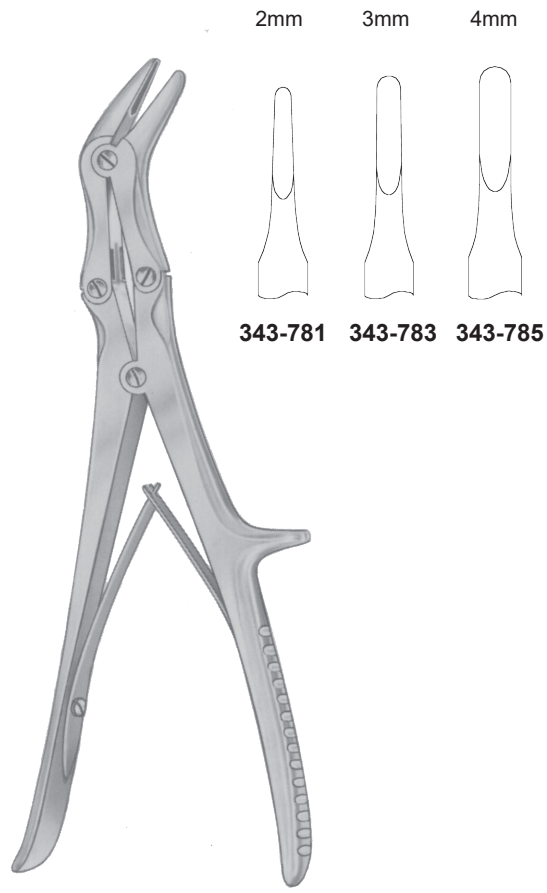

ECHLIN
343-781 - 343-785
230mm, 9"

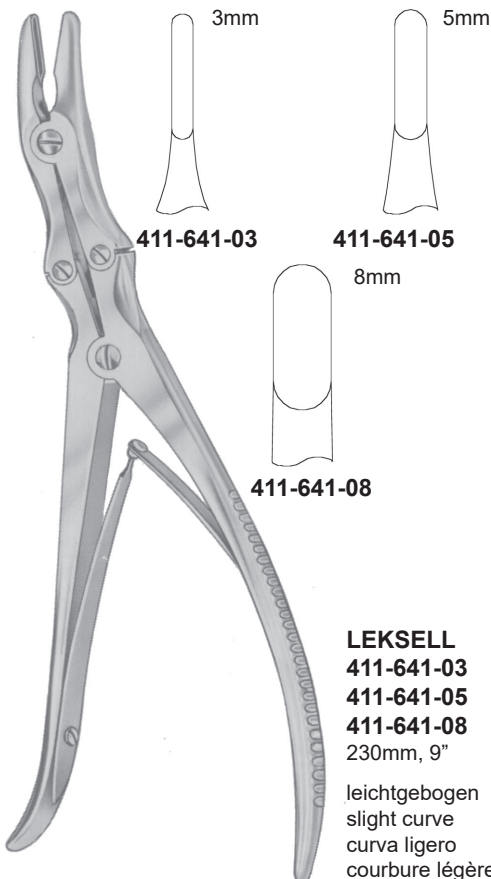

LEKSELL
411-641-03 3mm
411-641-05 5mm
411-641-08 8mm
230mm, 9"
leichtgebogen
slight curve
curva ligero
courbure légère

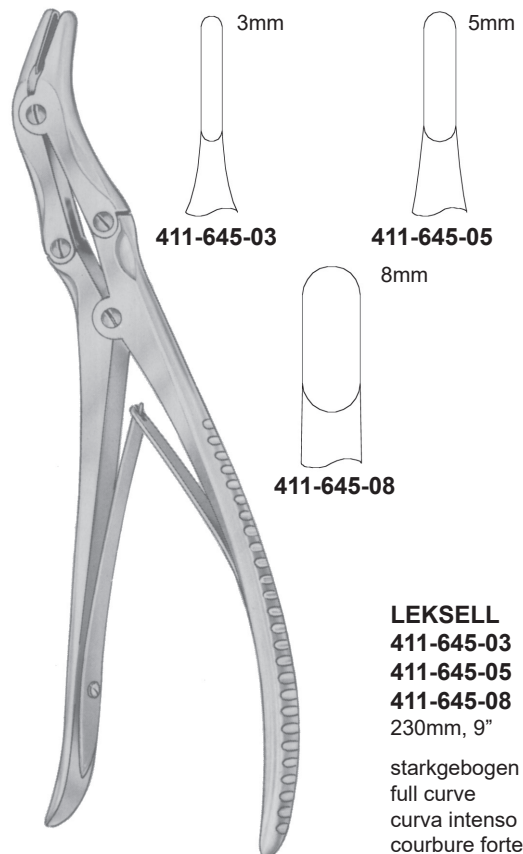

LEKSELL
411-645-03 3mm
411-645-05 5mm
411-645-08 8mm
230mm, 9"
starkgebogen
full curve
curva intenso
courbure forte

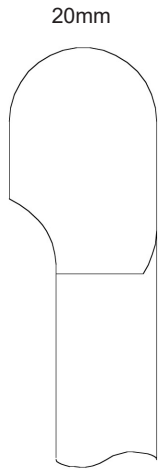

251-002-20

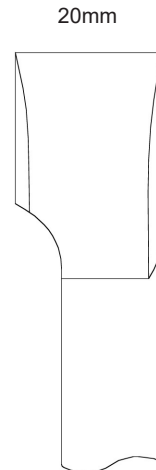

251-004-20



SAUERBRUCH

251-002-20 310mm, 12 1/4" 251-004-20

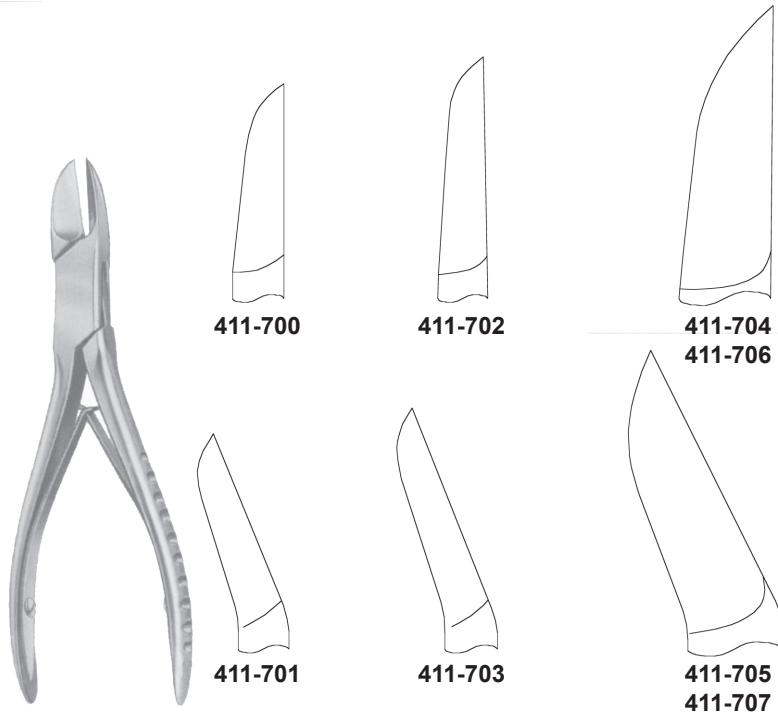

LISTON

- 411-700** 140mm, 5 1/2"
- 411-701** 140mm, 5 1/2"
- 411-702** 170mm, 6 3/4"
- 411-703** 170mm, 6 3/4"
- 411-704** 200mm, 8"
- 411-705** 200mm, 8"
- 411-706** 220mm, 8 3/4"
- 411-707** 220mm, 8 3/4"



LITTAUER-LISTON
411-710
150mm, 6"



CLEVELAND
411-749
150mm, 6"

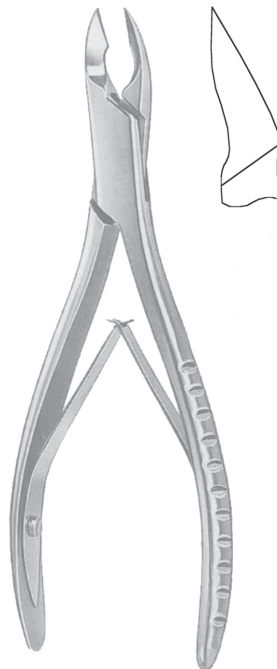

CLEVELAND
411-751
170mm, 6 3/4"



KAZANJIAN
451-120
185mm, 7 1/4"

KNOCHENSPLITTERZANGEN
BONE CUTTING FORCEPS
PINZAS CORTANTES PARA HUESO
PINCES COUPANTES A OS

ELCON
410

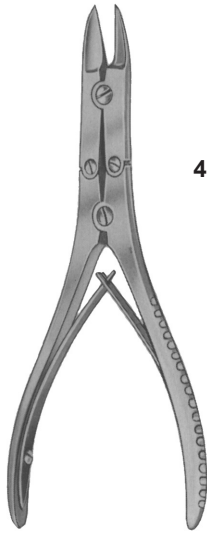

411-800



411-801

BOEHLER
411-800 - 411-801
150mm, 6"



411-810



411-811

MC INDOE
411-810 - 411-811
175mm, 7"

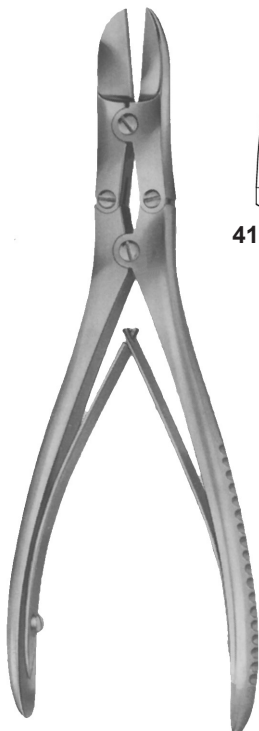

411-822



411-823

RUSKIN-LISTON
411-822 - 411-823
180mm, 7 1/2"



411-820

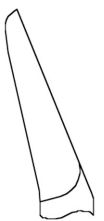

411-821

ROWLAND
411-820 - 411-821
180mm, 7"

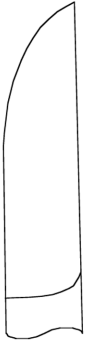

411-830
270mm, 10 3/4"

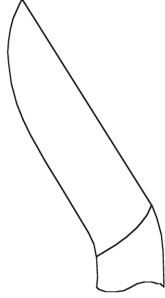

411-829
235mm, 9 1/4"



411-831
270mm, 10 3/4"

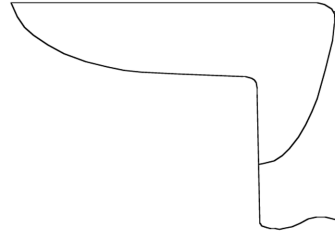

411-833
260mm, 10 1/4"



LISTON
411-829 235mm, 9 1/4"
411-830 270mm, 10 3/4"
411-831 270mm, 10 3/4"

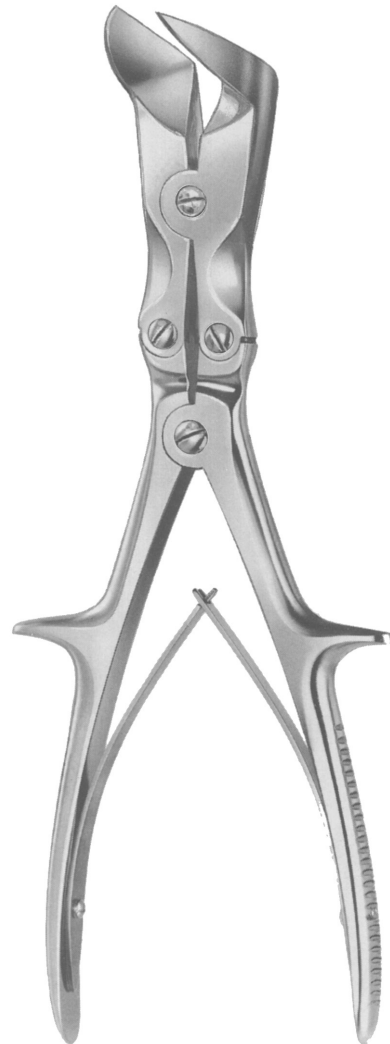

LISTON
411-833
260mm, 10 1/4"

KNOCHENSPLITTERZANGEN
BONE CUTTING FORCEPS
PINZAS CORTANTES PARA HUESO
PINCES COUPANTES A OS

ELCON
410

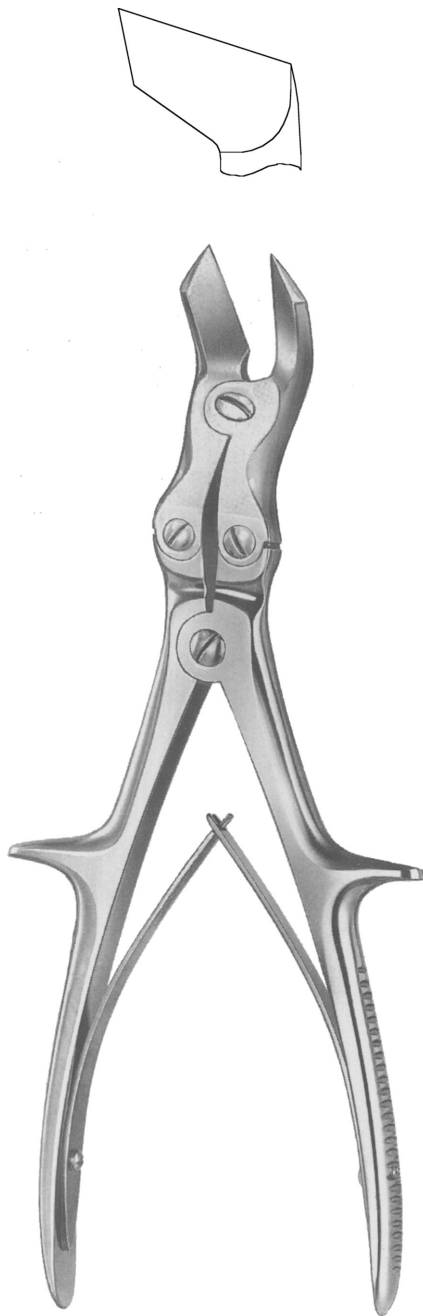

**STILLE-HORSLEY
(TUDOR EDWARDS)**
411-840
260mm, 10 1/4"

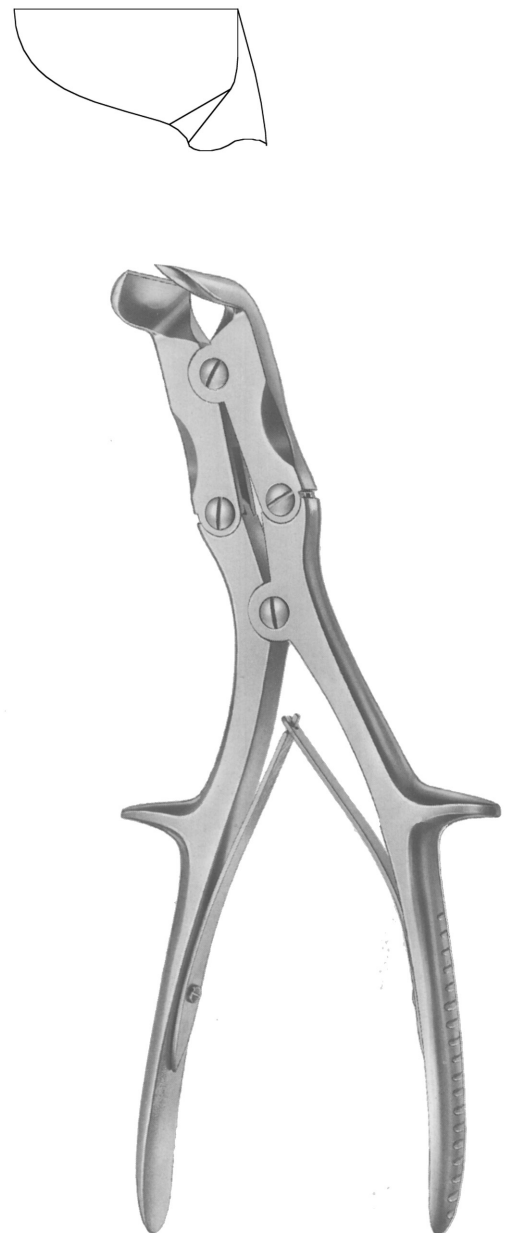

SEMB
411-850
240mm, 9 1/2"

ELCON 410

SEHNENFASSZANGEN, SEHNENFLECHTKLEMMEN
TENDON HOLDING AND INTERLACING FORCEPS,
PINZAS PARA COGER Y ENTRECROZAR TENDONES,
PINCES POUR SAISIR ET POUR ENTRELACER LES TENDONS



412-180 **412-182**

BRAND
412-180 150mm, 6"
412-182 190mm, 7 1/2"

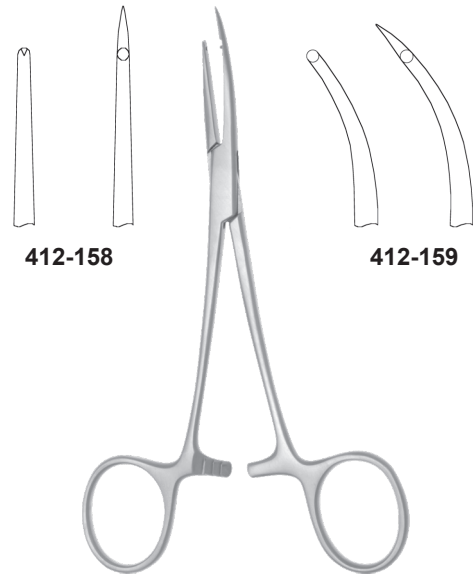

412-158 **412-159**

412-158 – 412-159
150mm, 6"



KLEINERT – KUTZ
412-196 210mm, 8 1/4"



CARROLL
412-127

Nutzlänge 110mm, 4 3/8"
working length 110mm, 4 3/8"
longitud de utilitario 110mm, 4 3/8"
longeur utilitaire 110mm, 4 3/8"



längs durchbohrt
cannulated
barrenado oblongo
perforation axiale

mit Schlüssel
with key
con llave
avec clef

412-540 160mm, 6 1/4"
Spannweite bis Ø 6,35mm
for shanks up to 6,35mm
apertura hasta Ø 6,35mm
passage jusqu'a Ø 6,35mm



412-586 160mm, 6 1/4"



412-588 140mm, 5 4/8"



PERTHES
412-580 180mm, 7"
412-581 215mm, 8 1/2"

ELCON 410

HANDBOHRAPPARATE, SPIRALBOHRER
HAND DRILLS, TWIST DRILLS
PERFORADORES DE MANO, BROCAS ESPIRALES
PERFORATEURS A MAIN, MECHEES ESPIRALES

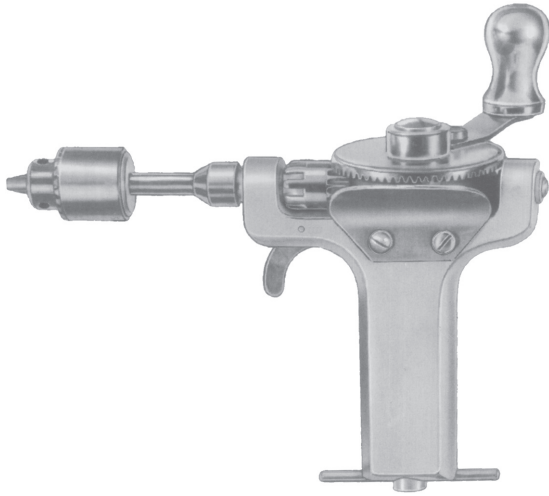

BUNNEL 412-500

längsdurchbohrt, Spannweite bis Ø 4mm mit Schlüssel (412-501)
cannulated for shanks up to 4mm with key (412-501)
barrenado oblongo, apertura hasta Ø 4mm on llave (412-501)
passage jusqu'a Ø 4mm, avec clef (412-501)



RALK 412-520

längsdurchbohrt, Spannweite bis Ø 6,35mm mit Schlüssel (412-521)
cannulated for shanks up to 6,35mm with key (412-521)
barrenado oblongo, apertura hasta Ø 6,35mm con llave (412-521)
passage jusqu'a 6,35mm, avec clef (412-521)

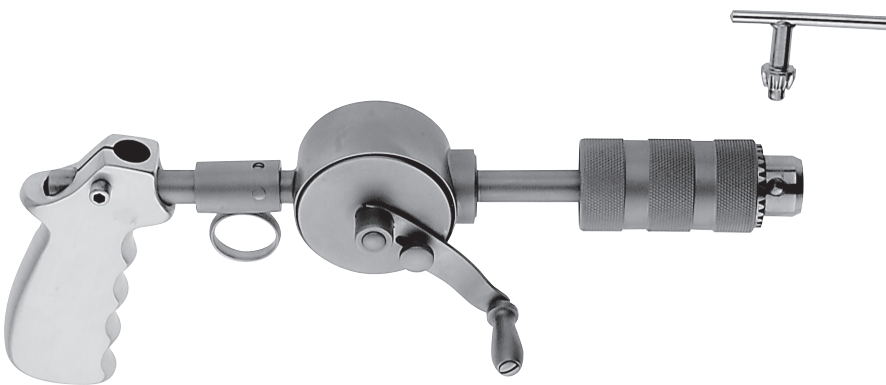

412-510

280mm, 10 1/4"

Spindel längsdurchbohrt, Spannweite bis 6,35mm
Cannulated spindle for shanks up to 6,35mm
huso barrenado oblongo, apertura hasta Ø 6,35mm
passage de fuseau et mâchoire jusqu'a 6,35mm

Spiralbohrer mit Rundschaft Twist drills with round shaft Brocas espirales convástago liso Mèches helicoidales avec tige lisse		
Ø mm	length mm	
1,0	55	412-702-10
1,5	70	412-702-15
2,0	85	412-702-20
2,5	95	412-702-25
2,8	100	412-702-28
3,0	100	412-702-30
3,2	105	412-702-32
3,5	110	412-702-35
4,0	120	412-702-40
4,5	125	412-702-45
5,0	130	412-702-50
6,0	140	412-702-60

2,5mm

3,5mm

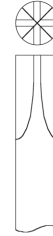

412-604 170mm, 6 3/4"
412-606 250mm, 10"

412-600 250mm, 10"
412-601 200mm, 8"

412-602 250mm, 10"
412-603 200mm, 8"

412-608 250mm, 10"

PHILIPS
412-610 250mm, 10"

ELCON 410

STAHLDRAHT, DRAHTUMFÜHRUNGSINSTRUMENTE, DRAHTSPANNER
BONE WIRE, WIREGUIDES, WIRE TIGHTENER
HILOS DE CERCLAJE, AGUJAS PASA-HILO, TENSOR CIERRA-HILO
FIL POUR CERCLAGE, AIGUILLES PASSE-FILS, TENDEUR SERRE-FIL



gewebeverträglich
tissue compatible
inofensivo para tejido
bien toléré par les tissus

Ømm	Ø gauge	
0,2	31G	413-002
0,3	29G	413-003
0,4	27G	413-004
0,5	25G	413-005
0,6	23G	413-006
0,7	22G	413-007
0,8	21G	413-008
0,9	20G	413-009
1,0	19G	413-010
1,2	18G	413-012
1,5		413-015

Cerclage-Drähte, weich, Ringe zu 10 m
Bone wires, soft, coils of 10 m
Hilos de cerclaje blandos rollos de 10 m
Fil pour cerclage, souple, rouleaux de 10 m



LOUTE
413-100
210mm, 8 1/4"



DEMEL
413-120
280mm, 11"

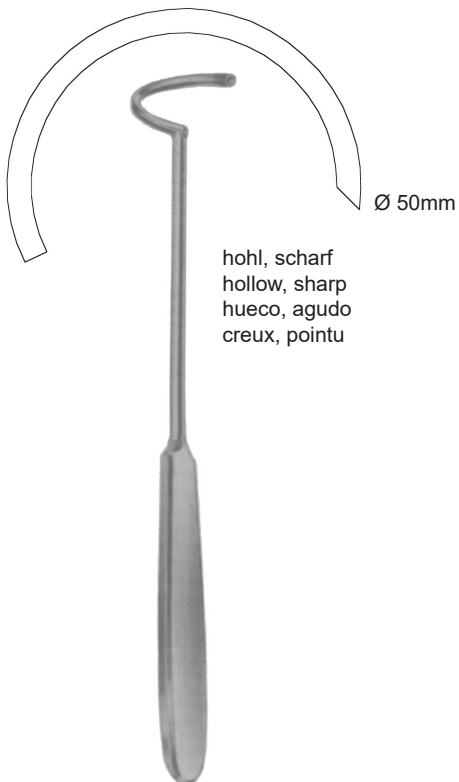

DEMEL
413-072
230mm, 9"

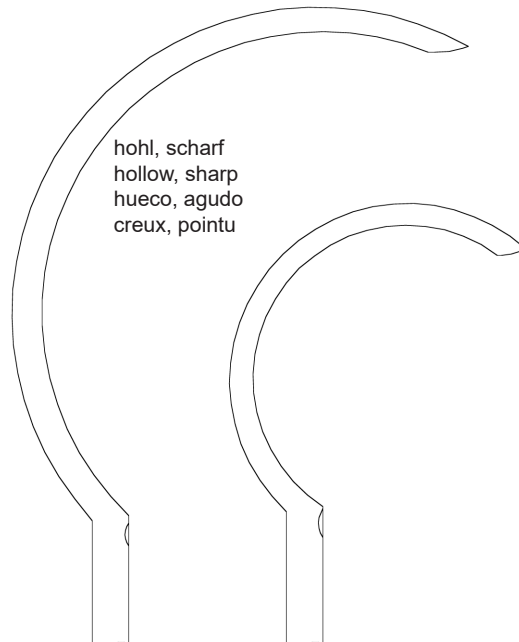

413-065
Ø 80mm

413-062
Ø 45mm

hohl, scharf
hollow, sharp
hueco, agudo
creux, pointu



DEMEL
413-062 240mm, 9 1/2"
413-065 270mm, 10 3/4"

TUNGSTENGRIP DRAHTSPANNZANGE
 TUNGSTENGRIP WIRE TWISTER
 TUNGSTENGRIP PINZAS PARA TORCER ALAMBRE
 TUNGSTENGRIP PINCES A TORCER LE FIL

ELCON
410

TUNGSTENGRIP

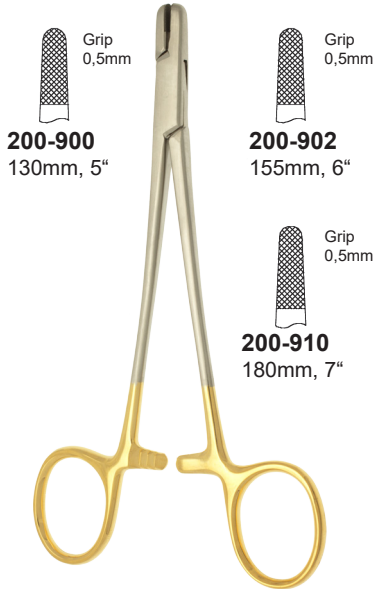

200-900
 130mm, 5"

200-902
 155mm, 6"

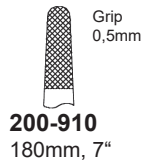

200-910
 180mm, 7"

200-900
200-902
200-910

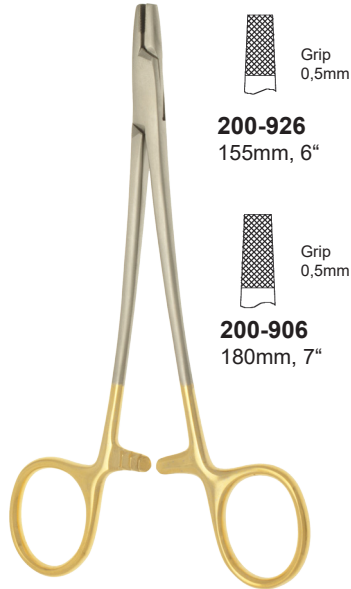

200-926
 155mm, 6"

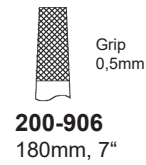

200-906
 180mm, 7"

200-906
200-926



200-904
 155mm, 6"

200-904



200-908
 200mm, 8"

200-908

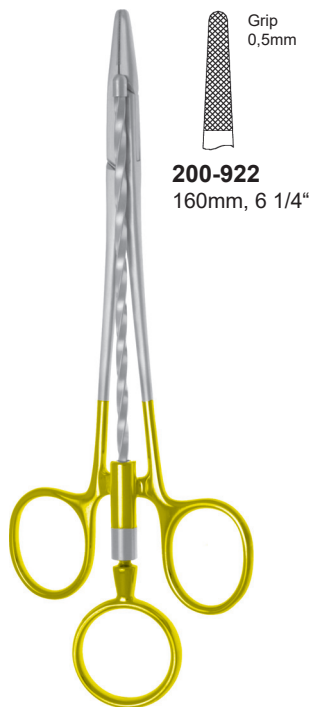

200-922
 160mm, 6 1/4"

CORWIN
200-922 160mm, 6 1/4"

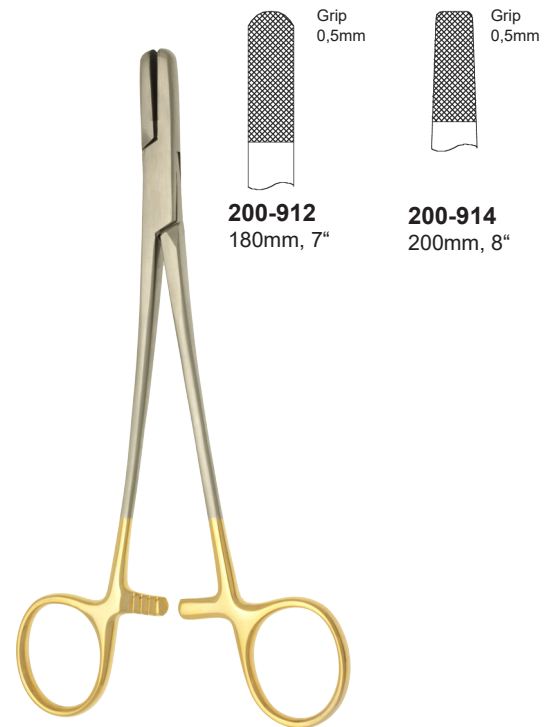

200-912
 180mm, 7"

200-914
 200mm, 8"

200-912 - 200-914

ELCON 410

EXTENSIONSBÜGEL
TRACTION BOWS
EXTRIBOS PARA EXTENSION
EXTRIERIS A EXTENSION

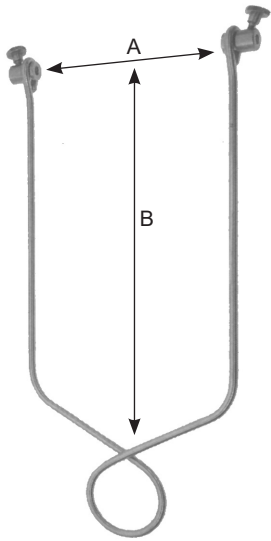

BÖHLER 413-600 90 x 160mm 3 1/2" x 6 1/4" für Arm for arm para brazo pour bras	BÖHLER 413-601 110 x 210mm 4 3/8" x 8 1/4" für Oberschenkel und Knie for thigh and knee para muslo y de la rodilla, pour femur etgenou	BÖHLER 413-602 150 x 210mm 6" x 8 1/4" für Oberschenkel und Knie for thigh and knee para muslo y de la rodilla pour femur etgenou
---	---	--



413-631



413-661 - 413-663

mit 3 Zughaken
with 3 traction hooks
con 3ganchos de tracción
avec 3 crochets de traction



413-650 - 413-651

STEINMANN

mm	Ø 4mm
80	416-0508
100	416-0510
120	416-0512
140	416-0514
150	416-0515
160	416-0516
180	416-0518
200	416-0520
210	416-0521
250	416-0525
300	416-0530

mit Trokarspitze und 3kant Schaft
aus Implantatstahl DIN 17443

with trocar point and triangular shaft,
implant stainless steel to DIN 17443

con punta trocar y vastago triangular,
para acero inoxidable, conforme a DIN 17443

à pointe triangulaire, extrémité triangulaire,
acier inoxydable, à la norme DIN 17443

KIRSCHNER			
	A		A
413-661	65 - 120mm	413-650	40 - 135mm
413-662	90 - 200mm	413-651	70 - 190mm
413-663	90 - 250mm		

für Kirschner Drähte bis Ø 2,5mm; for Kirschner wires up to 2,5mm diam.
para agujas Kirschner hasta Ø 2,5mm; pour broches Kirschner jusqu'à 2,5mm Ø

TROKARSPITZE, TROCAR POINT
PUNTAS DE TROCAR, POINTE DE TROCARTE

Ømm diam.	100mm 4"	150mm 6"	310mm 12 ½"
0,8	419-0038	419-0138	419-0308
1,0	419-0040	419-0140	419-0310
1,2	419-0042	419-0142	419-0312
1,4	419-0044	419-0144	419-0314
1,5	419-0045	419-0145	419-0315
1,6	419-0046	419-0146	419-0316
1,8	419-0048	419-0148	419-0318
2,0	419-0050	419-0150	419-0320
2,2	419-0052	419-0152	419-0322
2,5	419-0055	419-0155	419-0325
3,0	419-0060	419-0160	419-0330

RUNDES ENDE, ROUND SHAFT
CON VASTAGO, REDONDO, A EXTREMITE RONDE

TROKARSPITZE, TROCAR POINT
PUNTAS DE TROCAR, POINTE DE TROCARTE

Ømm diam.	150mm 6"	310mm 12 ½"
0,8	419-1138	419-1308
1,0	419-1140	419-1310
1,2	419-1142	419-1312
1,4	419-1144	419-1314
1,5	419-1145	419-1315
1,6	419-1146	419-1316
1,8	419-1148	419-1318
2,0	419-1150	419-1320
2,2	419-1152	419-1322
2,5	419-1155	419-1325
3,0	419-1160	419-1330

MIT FLACHEM ENDE, WITH FLAT SHAFT
CON TERMINO PLANMO, A EXTREMITE PLATE

Sämtliche Bohrdrähte auch in anderen Längen lieferbar!
On request, available in any other length needed!
Entregable en otras medidas!
Livrables, sur demande, dans toute autre longueur!

Packungen zu je 10 Stück.
packages of 10 pieces.
Paquete de 10 piezas.
Paquets de 10 pièces.

BEIDSEITIG TROKAR, DOUBLE TROCAR POINT
PUNTAS DE TROCAR, DOBLE, POINTE DE TROCARTE, DOUBLE

Ømm diam.	100mm 4"	150mm 6"	230mm 9"	310mm 12 ½"
0,8	419-2038	419-2138	419-2208	419-2308
1,0	419-2040	419-2140	419-2210	419-2310
1,2	419-2042	419-2142	419-2212	419-2312
1,4	419-2044	419-2144	419-2214	419-2314
1,5	419-2045	419-2145	419-2215	419-2315
1,6	419-2046	419-2146	419-2216	419-2316
1,8	419-2048	419-2148	419-2218	419-2318
2,0	419-2050	419-2150	419-2220	419-2320
2,2	419-2052	419-2152	419-2222	419-2322
2,5	419-2055	419-2155	419-2225	419-2325
3,0	419-2060	419-2160	419-2230	419-2330

Bohrdrahtspender für Bohrdrähte Ø x Länge
Wire dispenser for wire drills diam.x length
Dispensador para agujas Ø x longitud
Distributeur pour broches Ø x longueur
Distributore per Ø e lunghezza punta

Ø mm	180mm 7"	330mm 13 ¼"
0,8	419-5418-08	419-5433-08
1,0	419-5418-10	419-5433-10
1,2	419-5418-12	419-5433-12
1,4	419-5418-14	419-5433-14
1,6	419-5418-16	419-5433-16
1,8	419-5418-18	419-5433-18
2,0	419-5418-20	419-5433-20
2,2	419-5418-22	419-5433-22
2,5	419-5418-25	419-5433-25

ELCON 410

FLACH- UND KOMBINATIONSZANGEN, DRAHTKNEIFZANGEN
COMBI- FLAT NOSE PLIERS, WIRE CUTTING PLIERS
ALICATES DE PLANO, ALICATES PARA CORTAR ALAMBRE
COMBI-PINCES ET PINCES PLATES, PINCES A COUPER LE FIL



413-177
180mm, 7"

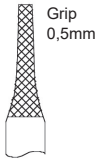

413-178
180mm, 7"

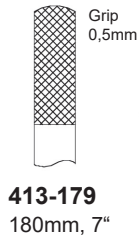
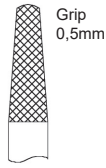

413-179
180mm, 7"



413-170 - 413-174

413-170
145mm, 5 3/4"



413-171
180mm, 7"



413-172
180mm, 7"



413-173
180mm, 7"

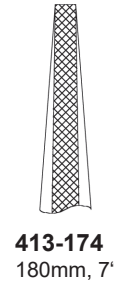

413-174
180mm, 7"

TUNGSTENGRIP 413-177 – 413-179

mit Hartmetalleinlagen,
with tungsten carbide inserts
con capas de carburo tungsteno
avec inserts en carbure de tungstène



413-153 – 413-154

413-153
130mm, 5"

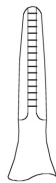

413-154
180mm, 7"

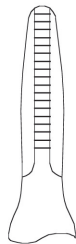

413-150
150mm, 6"



413-152
150mm, 6"



FLACHZANGEN
 FLAT NOSE PLIERS
 ALICATES DE PICO PLANO
 PINCES PLATES

ELCON
410



413-158
 140mm, 5 1/2"

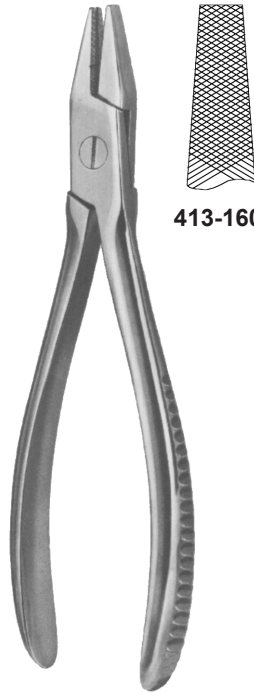

413-160

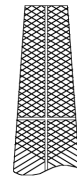

413-161

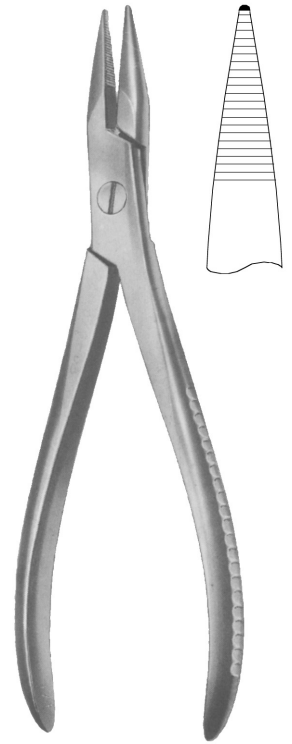

413-165
 190mm, 7 1/2"



413-134
 185mm, 7 1/4"



413-135
 170mm, 6 3/4"

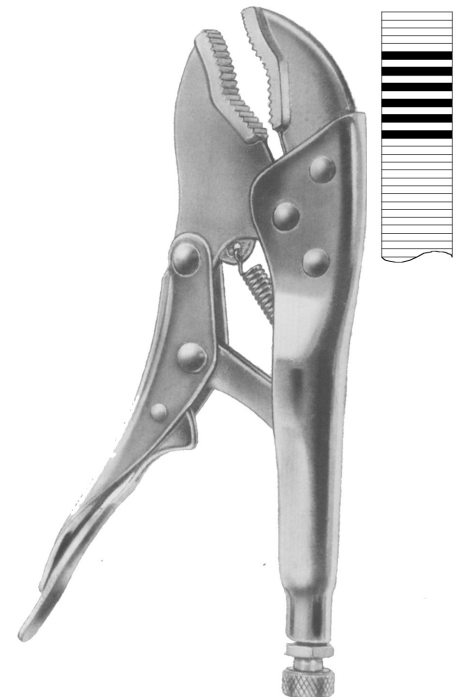

413-130
 185mm, 7 1/4"

TUNGSTENCUT



Kopf- und Seitenschneider
front and lateral cutter
Alicate de corte frontal y lateral
Pince a couper frontale et latérale

$\frac{2,0}{1,5}$

413-192
180mm, 7"

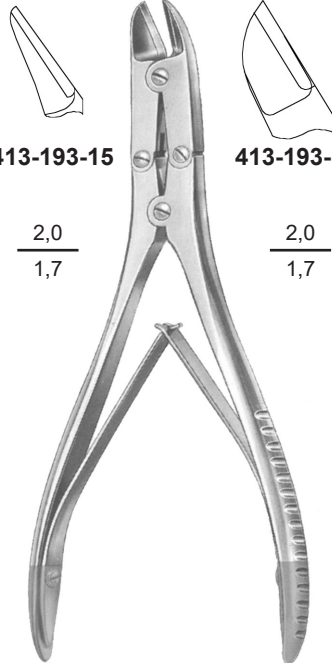

413-193-15

413-193-18

$\frac{2,0}{1,7}$

$\frac{2,0}{1,7}$

413-193-15 155mm, 6 1/4"
413-193-18 180mm, 7"

für weichen Draht bis Ømm
for soft wire up to mm diam.
para blandos hasta Ømm
pour couper les fils doux jusqu'à Ømm

für harten Draht bis Ømm
for hard wire up to mm diam.
para duros hasta Ømm
pour couper les fils durs jusqu'à Ømm



$\frac{0,6}{0,4}$

413-140
125mm, 5"



$\frac{2,0}{1,5}$

413-146
150mm, 6"



$\frac{3,5}{2,5}$

413-186
220mm, 8 3/4"



$\frac{2,8}{2,2}$

413-195
230mm, 8 3/4"

TUNGSTENCUT DRAHTKNEIFZANGEN
TUNGSTENCUT WIRE CUTTING PLIERS
TUNGSTENCUT ALICATES PARA CORTAR ALAMBRE
TUNGSTENCUT PINCES A COUPER LE FIL

ELCON
410

TUNGSTENCUT

Kopfschneider
head cutter
alicate para corte frontal
pince coupante, tranchant frontal



413-202

380mm, 15"

für Kirschner Drähte bis 4mm Ø
for Kirschner wire up to 4mm Ø
para agujas de Kirschner hasta 4mm Ø
pour broches de Kirschner jusqu'à 4mm Ø



413-198 460mm, 18 1/4"

413-199 560mm, 22"

Bolzenschneider zum Abzwicken von Drähten,
Schrauben und Nägel bis 6mm
Cutter for cutting wires, screws and pins up to 6mm
Alicates cortar alambres, tornillos y calvos hasta 6mm
Pince à couper les fils, pivots et clous jusqu'à 6mm

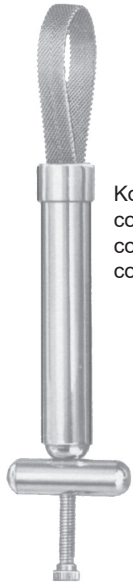

Kompressorium
comprimeter
compressor
compresseur

412-090SS
100mm, 4"

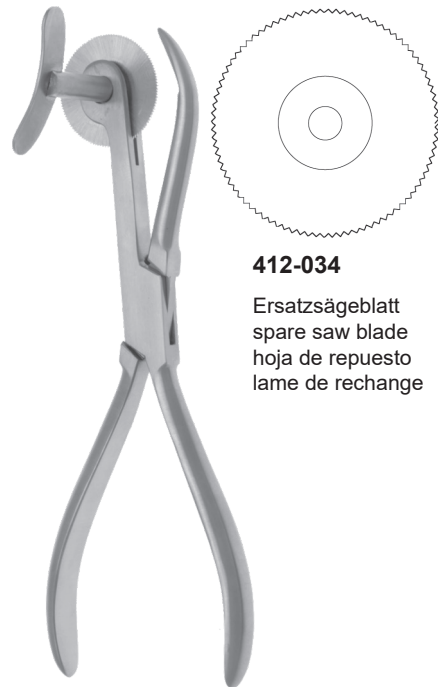

412-034

Ersatzsägeblatt
spare saw blade
hoja de repuesto
lame de rechange

412-033
170mm, 6 3/4"

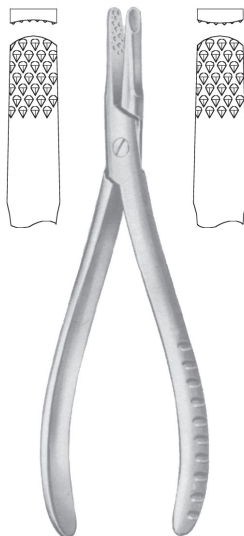

RADOLF
412-010
135mm, 5 1/4"

Nagelausreißzange
nail extracting forceps
pinzas arrance-unas
pince pour arracher les ongles



412-006
130mm, 5 1/4"

Nagelspaltzange
nail splitting forceps
pinzas corta-unas
pince pour fender les ongles

FÜR NOTIZEN
FOR NOTES
PARA NOTAS
POUR NOTES

ELCON
410

Lined area for notes, consisting of multiple horizontal lines.

ELCON

MEDICAL INSTRUMENTS GmbH

D - 78532 Tuttlingen

Dr. Karl-Storz-Str. 26

Tel: +49 7461 9281-0

info@elcon-medical.de

www.elcon-medical.com

