

Diesel Engine Safety Solutions

System Selection Guide

RODADEACO

by AMOT



Diesel engines are a potential source of ignition when used in areas where combustible gas, vapors, or dust may exist. The resulting conflagration can lead to catastrophic consequences for personnel, production, and the environment.



According to OSHA, there have been 36 incidents related to the release of highly hazardous chemicals in just the refining industry between 1992 and 2007, resulting in 52 deaths and 250 injuries. The U.S. Minerals and Management Service, the U.S. Government agency that regulates offshore oil industry, determined there are alarmingly high percentages of fires and explosions resulting in death and property destruction. More than 20 people have been killed and 190 injured in just three accidents.

As a result of this significant risk, various industry regulatory agencies in several countries have established regulations for their industries requiring air intake shutoff devices on diesel engines. Canada, the member countries of the European Union, and the USA are just a few countries that have industries with regulations in place.



Contents

Diesel Engines: A potential source of ignition	4
Diesel Engine Overspeed Safety Solutions	5
Automatic Electric Overspeed Detection Shutdown System	6
Automatic Electric to Pneumatic Overspeed Detection Shutdown System	7
Manual Engine Overspeed Shutdown Systems	8-9
Product Overview	10-11
Contact Information.....	Back cover

Diesel Engines: A potential source of ignition



Diesel engine speed is governed by controlling the amount of fuel fed to the engine through its fuel system and internal speed governor. If a flammable material is drawn into the air intake system of a diesel engine it acts as an additional uncontrolled fuel supply. This additional fuel source can cause the diesel engine to accelerate or overspeed out of control. This condition is referred to as diesel engine runaway. The result of a diesel engine runaway can range from engine damage to a catastrophic explosion.



Turning off the normal shutdown system will only turn off the engine's normal fuel source. Once the flammable material is being drawn into the engine intake it may not be possible to stop the engine using the normal engine shutdown. The most effective way of shutting down a runaway diesel engine is with an air intake shutoff valve. An air intake shutoff system completely blocks the engine intake system, cutting off both the external fuel source and the air required to keep the engine running.



Below are a few industries that operate diesel engines in areas where combustible gas, vapors, or dust can exist:

- Oil & Gas
- Petrochemical
- Mining
- Marine
- Aviation
- Power Generation
- Transportation
- Fire Control
- Distilling
- Agriculture



Roda Deaco has supplied Diesel Engine Overspeed Safety Shutdown solutions for hundreds of applications. A few example applications are listed below:

- Drilling rigs (onshore & offshore)
- Drilling support equipment
- Well servicing equipment
- Refinery support equipment
- Bulk haulers and tankers
- Mining equipment
- Construction equipment
- Fork lift trucks
- Generator sets
- Air compressors
- Emergency response vehicles
- Aircraft support equipment
- Welding sets
- Work boats and barges
- Hydraulic power packs
- Light towers
- Water pumps
- Agriculture equipment
- Rail support equipment
- Locomotive

Diesel Engine Overspeed Safety Solutions

Since 1981, Roda Deaco has been providing complete diesel engine overspeed air intake shutoff systems. Roda Deaco offers a wide selection of sizes and actuation methods to meet the installation requirements of the hundreds of different diesel engine applications in use today.

Roda Deaco has a broad array of fully automatic shutoff systems and manual shutoff systems. Common operating methods include electric, pneumatic, electric/pneumatic, mechanical, or combinations of these mechanisms.

Each system comes complete with the sensors, switches, valves, actuation kits and installation kits specifically designed for your application to help ease the installation of the system onto the engine.

The following pages provide an overview of the most common types of systems used in applications today. The overview includes a description of the solution, a diagram of the components and includes the functional highlights of the components used in each solution. These overviews will provide the information required to help you determine the best type of solution for your application.



Automatic Electric Overspeed Detection Shutdown System

The automatic electric overspeed protection shutdown system is designed to continuously monitor diesel engine RPM to immediately shutdown the engine in the event of an overspeed condition.

The RevGuard Speed Switch monitors engine RPM using either a flywheel mounted magnetic pickup or a signal from the engine

alternator. It will immediately transmit a signal to trigger the shutdown of the Air Intake Shutoff Valve when the engine RPM exceeds a preset limit.

The system also includes a Manual Override Toggle Switch that can be used to trigger a manual emergency closure of the Air Intake Shutoff Valve.

Automatic RPM Overspeed Detection Shutdown System with Manual Override

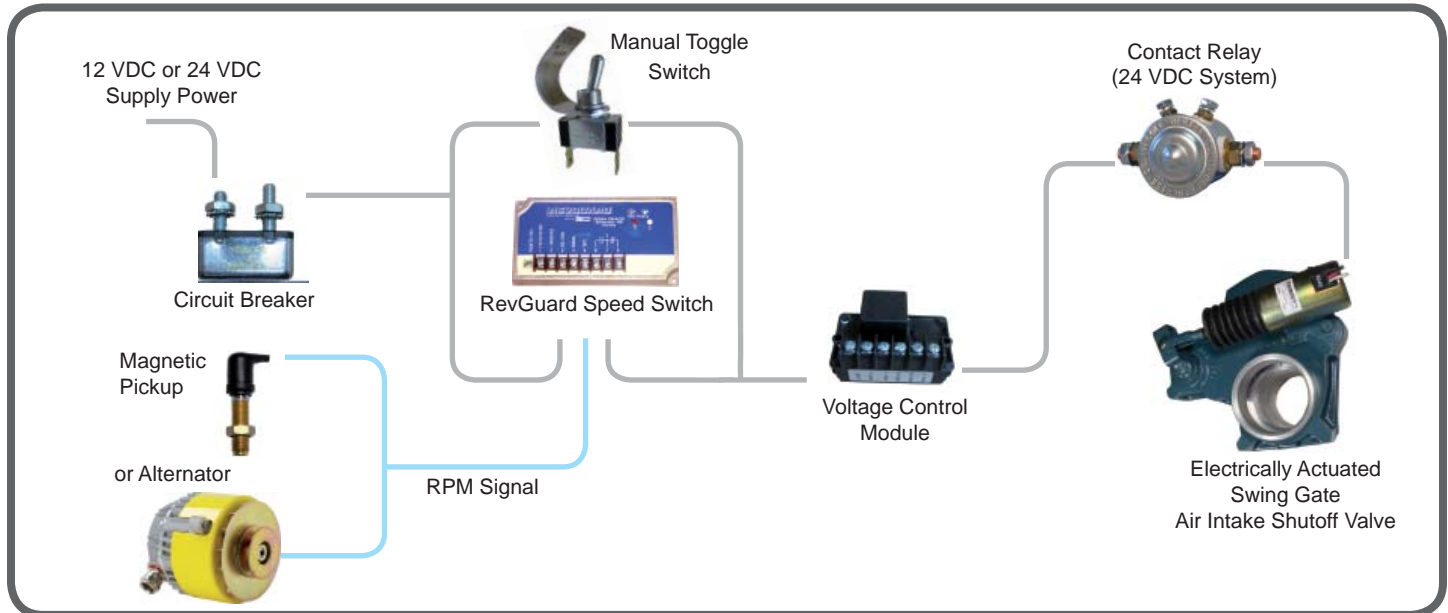

Swing Gate Air Intake Shutoff Valve

Used to seal off intake air to a diesel engine for emergency shutdowns

- Sizes range from 1" to 7"
- Electric versions in 12 or 24 VDC
- Pneumatic version in 90-130 psi (6.2 - 9.0 bar)
- Temperatures from -40°F to +550°F (-40°C to 288°C)
- Position indicator switch available

RevGuard Speed Switch

Monitors engine RPM to shut down a runaway engine at a preset limit

- Operates on 12 or 24 VDC systems
- LED trip indicator
- Built-in 2/3 of RPM test switch to simulate overspeed

Magnetic Pickup RPM Sensor

Sensor measures engine flywheel RPM and sends signal to the RevGuard Speed Switch

- Installs in existing threaded port
- Unaffected by dirt or foreign materials collecting at sensor tip

Manual Override Toggle Switch

Enables an operator to manually close the air intake shutoff valve

- Includes safety thumb guard and decal
- Option for military switch
- Silver contacts for durability

RODADEACO

by AMOT

www.rodadeaco.com

Automatic Electric to Pneumatic Overspeed Detection Shutdown System

The automatic electric to pneumatic overspeed detection shutdown system is designed to continuously monitor diesel engine RPM to immediately shutdown the engine in the event of an overspeed condition.

The RevGuard Speed Switch monitors engine RPM through either a flywheel mounted magnetic pickup or a signal from the

engine alternator. The RevGuard Speed Switch will immediately activate the 3-way pneumatic solenoid when the engine RPM exceeds a preset limit, which pressurizes the Air Intake Shutoff Valve to close.

The system also includes a manual override toggle switch that can be used to manually close the Air Intake Shutoff Valve.

Automatic Electric to Pneumatic RPM Overspeed Detection Shutdown System with Manual Override

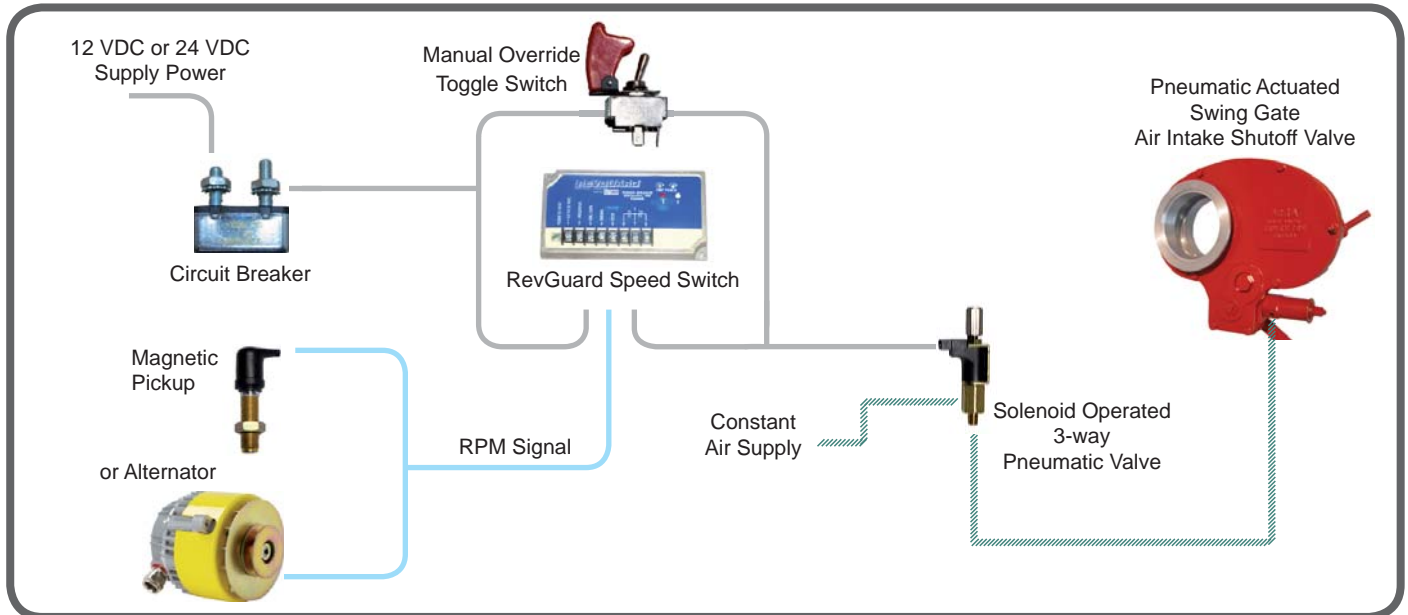

Voltage Control Module

Protects the solenoid from current overload

- Voltage input 10 - 32 VDC
- Maximum current 80 amps
- Actuation time 0.4 - 0.6 seconds

3-Way Solenoid Valve

Uses the trip signal to actuate the air pressure to close the Air Intake Shutoff Valve

- 12 or 24 VDC
- Normally open contacts
- Simple On/Off Circuit

Circuit Breaker

Protects system from over current

- 12 VDC, 30 amps
- 24 VDC, 30 amps

Contact Relay (24 VDC Systems)

Protects the valve solenoid and Voltage Control Module from high current damage

- 24 VDC, 85 amp
- Plated for corrosion resistance

Manual Engine Overspeed Shutdown Systems

Manual Electric Overspeed Shutdown System

The manual electric overspeed protection shutdown system uses a Manual Toggle Switch to trigger a manual closure of the Air Intake Shutoff Valve.

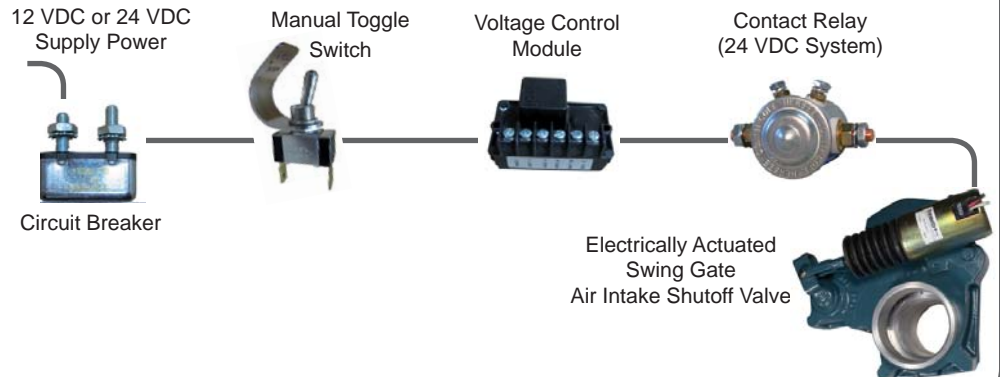

Manual Electric to Pneumatic Shutdown System

The manual electric to pneumatic shutdown system uses the Manual Toggle Switch to activate the 3-way Pneumatic Solenoid which pressurizes the Air Intake Shutoff Valve to close.

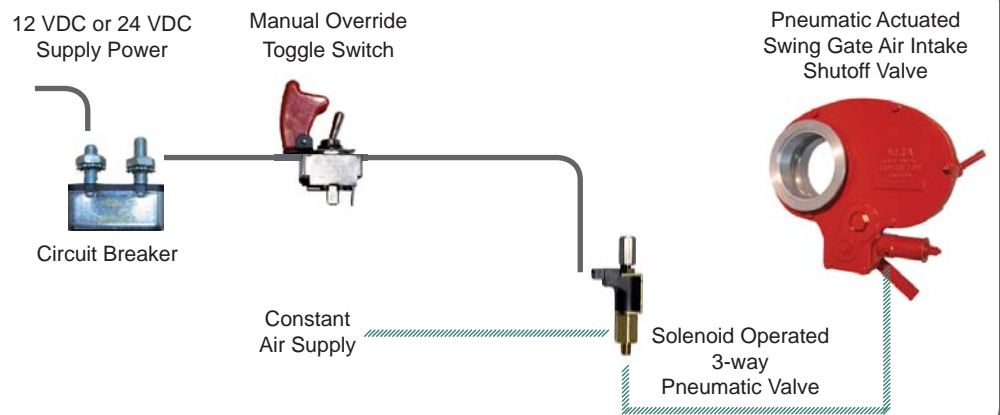

Swing Gate Air Intake Shutoff Valve

Used to seal off intake air to a diesel engine for emergency shutdowns

- Sizes range from 1" to 7"
- Electric versions in 12 or 24 VDC
- Pneumatic version in 90-130 psi (6.2 - 9.0 bar)
- Temperatures from -40°F to +550°F (-40°C to 288°C)
- Position indicator switch available

Manual Toggle Switch

Enables an operator to manually close the air intake shutoff valve

- Includes safety thumb guard and decal
- Option for military switch
- Silver contacts for durability

Voltage Control Module

Protects the solenoid from current overload

- Voltage input 10 - 32 VDC
- Maximum current 80 amps
- Actuation time 0.4 - 0.6 seconds

Circuit Breaker

Protects system from over current

- 12 VDC, 30 amps
- 24 VDC, 30 amps

Contact Relay (24 VDC Systems)

Protects the valve solenoid and Voltage Control Module from high current damage

- 24 VDC, 85 amp
- Plated for corrosion resistance

RODADEACO

by AMOT

www.rodadeaco.com

Manual Engine Overspeed Safety Solutions

Pneumatic Manual Shutdown System

The pneumatic manual shutdown system uses the pneumatic manual toggle valve to pressurize the Air Intake Shutoff Valve to close.

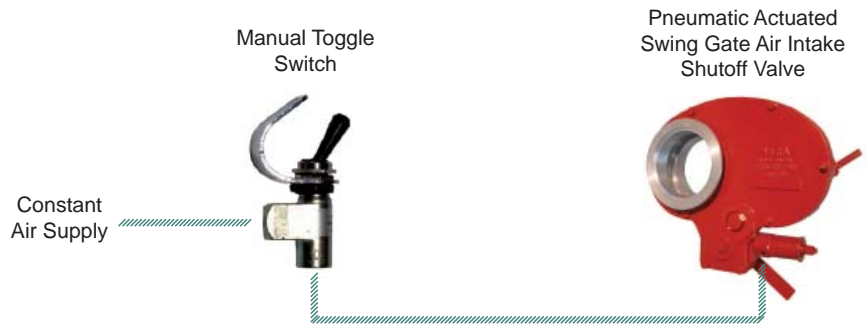

Cable Operated Shutdown System

The cable operated system uses a pull cable with T-handle to manually close the Air Intake Shutoff Valve.

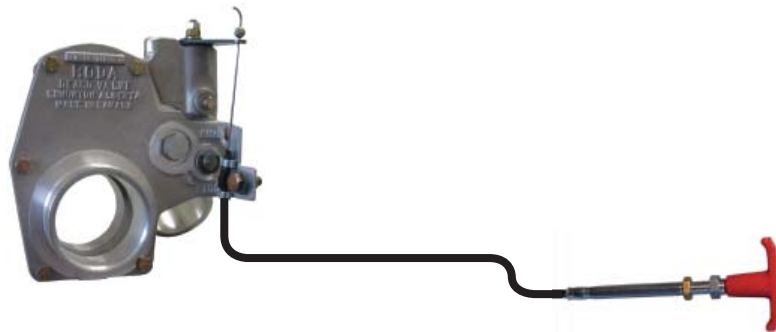

3-Way Solenoid Valve

Uses the trip signal to actuate the air pressure to close the Air Intake Shutoff Valve

- 12 or 24 VDC
- Normally open contacts
- Simple On/Off Circuit

Manual Override Toggle Switch

Enables an operator to manually close the air intake shutoff valve

- Includes safety thumb guard and decal
- Latching for safety
- 1/8" NPT threads

Pull Cable with T-Handle

Enables an operator to pull a red T-handle to manually close the Air Intake Shutoff Valve

- Stainless steel core for corrosion resistance
- Flexible construction allows small radius curves or bends without binding
- Available in lengths up to 30 ft (9.2 m)

Swing Gate Air Intake Shutoff Valves



The Swing Gate Air Intake Shutoff Valve provides emergency shutdown of a diesel engine. When the positive spring actuated valve closes, it starves the diesel engine of air and combustible vapor ingested through the air intake line.

- Compact “swing gate” design
- Sizes from 1/2” to 7”
 - RDS1 valve – 1/2” to 2” intake line sizes
 - RDS2 valve – 1” to 3” intake line sizes
 - RDS3 valve – 3” to 4” intake line sizes
 - RDS5 valve – 4” to 7” intake line sizes
- Electric versions in 12 or 24 VDC
- Pneumatic version 90–130 psi (6.2-9.0 bar)
- Mechanical version
- Temperatures from -40°F to 550°F (-40°C to 288°C)
- Major components manufactured of aluminum, brass, and stainless steel
- The sealing element is a phenolic insert
- Various intake line connections available
 - Hose
 - V-clamp
 - O-ring
 - Flange
 - Others

Swing Gate Valve Optional Equipment



Optional equipment that can be added to the swing gate valve to meet application requirements

- Microswitch position indication
 - Provides indication of valve open or valve closed position
 - Versions available for -40°F to +400°F (-40°C to 204°C)
 - Normally Open or Normally closed contacts options
 - Mounted integrally into valve
- Pneumatic valve reset
 - Provides ability for valve to be remotely reset
 - Air pressure to reset valve

Butterfly Air Intake Shutoff Valve



The Butterfly Air Intake Shutoff Valve provides emergency shutdown of a diesel engine. When the positive spring actuated valve closes, it starves the diesel engine of air and combustible vapor ingested through the air intake line.

- Compact butterfly design
- Sizes from 2-1/2” to 3-1/2” size
- Electric versions in 12 or 24 VDC
- Pneumatic version 90–130 psi (6.2-9.0 bar)
- Mechanical version
- Temperatures from -40°F to +221°F (-40°C to 105°C)
- Major components manufactured of aluminum, plated and stainless steel
- Various intake line connections available
 - Hose
 - V-clamp
 - O-ring
 - Flange
 - Others

Actuation Kits

Actuation kits are provided with each system sold. The actuation kit contains hardware required to properly install and integrate the specified shutdown system into the diesel engine application. The kits, specific for each type of system and application, can include items such as:

- Voltage control module
- Relays
- Circuit breaker
- Toggle switch or valve
- 3-Way pneumatic solenoid
- Pneumatic hose and fittings
- Cable with T-handle

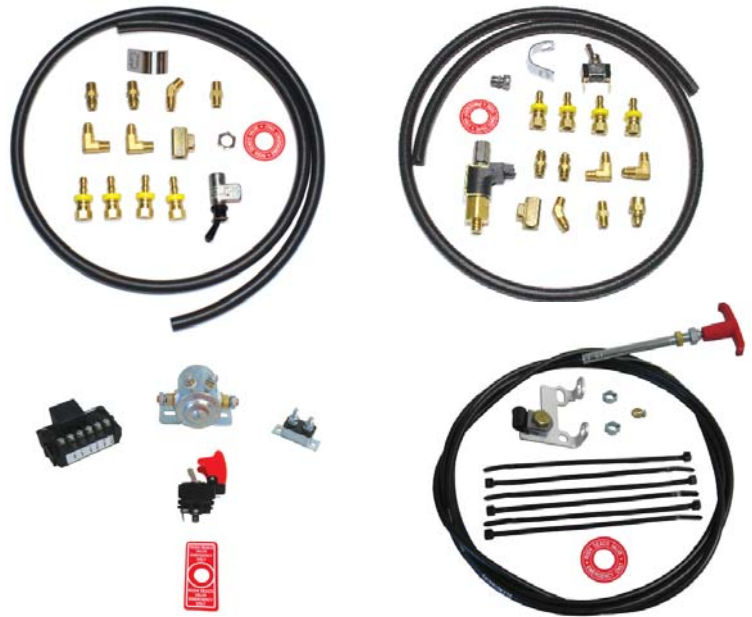

Installation Kits

Installation kits are also provided with each system sold. The installation kit contains the hardware required to ease the installation the Air Intake Shutoff Valve into a diesel engine air intake line. Roda Deaco has hundreds of different kits available to ease the installation process. The installation kits are designed to meet specific engine model and application requirements. The kits can range from hose with clamps to custom intake pipes, elbow, flanges, brackets, etc.



Overspeed Sensors and Switches

Roda Deaco has overspeed sensors and switches, such as magnetic pickups and speed switches, to complete the automatic overspeed detection systems.

- Magnetic pickup
 - Measures engine flywheel RPM
 - Installs in existing threaded port
 - Unaffected by dirt or foreign material
- RevGuard Speed Switch
 - Single and dual setpoint versions
 - Operates on 12 VDC or 24VDC systems
 - LED trip indicator
 - Built-in 2/3 of RPM test switch to simulate overspeed condition



Roda Deaco has a history of over 25 years in manufacturing safety shut down solutions for diesel engines in a wide variety of industries and hundreds of different applications.

In 2007 Roda Deaco was acquired by AMOT, a global manufacturer of valves, controls and monitoring solutions for the protection of engines, compressors, turbines and heavy equipment. AMOT has served a wide variety of markets since 1948 including industrial, marine, oil and gas, power generation and transportation.

Together, the AMOT, Roda Deaco and Chalwyn brands offer an extensive family of engine safety solutions.

Contact us

USA, Latin America

8824 Fallbrook Dr.
Houston, TX 77064
USA

Tel: +1 281 940 1800
Fax: +1 713 559 9419
info@rodadeaco.com

Canada

3230 - 97 Street, Edmonton
Alberta, T6N 1K4
Canada

Tel: +1 780 465 4429
Fax: +1 780 469 6275

Europe, Middle East, Africa

Western Way
Bury St Edmunds
Suffolk, IP33 3SZ
UK

Tel +44 (0) 1284 762222
Fax +44 (0) 1284 760256

Asia Pacific

Rm A308 Building A8
Jiahua Business Center
808 Hongqiao Road
Shanghai 200030
China

Tel +86 (0) 21 6447 9708
Fax +86 (0) 21 6447 9718

