

*The art of  
controlling light*



## ARTec

Alulux external Venetian blind technology



## SolidScreen<sup>®</sup>

Alulux zip textile screens



# ARtec

Alulux Raffstore Technologie

5

Alulux external Venetian blinds are made of high-quality aluminium. Manufactured exclusively by external Venetian blind specialists in Germany. Experience engineering excellence, high-end design, beautiful light control and much more! Discover the five major benefits of ARtec ...

1

FUNCTIONALITY

2

APPEARANCE

3

COMFORT



Variable incident light, privacy and protection from the sun due to infinitely-adjustable slats, energy saving and heat reflective. If desired, functions for individual external Venetian blinds or groups of blinds can be controlled easily via the programmable radio-remote control.



ARtec external Venetian blinds are beautiful, creative statements. They are a distinctive façade design feature and enhance the overall appearance of your home. Additionally enjoy the innovative and high-end design from inside your home.



External Venetian blinds filter sunlight without blocking out all natural light to ensure the perfect match for your rooms. The flexible way to keep prying eyes out whilst stopping the harmful rays of the sun. As precise as you like, whenever you like.

## External Venetian blinds – so many good reasons!



Sun protection

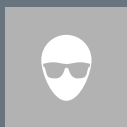

Glare protection

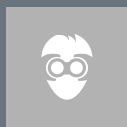

Privacy protection



Light control



Energy saving



Cold and thermal insulation



Façade element



4

## MATERIAL



We only use the very best aluminium – and for good reasons. It is lightweight, robust and extremely durable. It guarantees incredible precision during production, functional reliability and a wonderful appearance. You will never have to worry about corrosion, and it is impervious to wind and weather.

MADE IN GERMANY

5

At our factory in Burgbernheim, experienced industry specialists devote their time to developing and producing high-quality external Venetian blind systems "Made in Germany". ARTec external Venetian blinds from Alulux meet the highest quality requirements. Alulux has specialised in the production of high-quality sun protection systems for more than 50 years.



# ARTec

Alulux Raffstore Technologie

## Precision engineering

A symbol of German engineering excellence: The elements of ARTec external Venetian blinds fit together like the pieces of a puzzle – ensuring reliable operation and ease of use for years to come.



Amazing variety: Aluminium shutter box, visible, available as a flush-mounted or new build version

In this example, Enext®\_RG: Box insulation made of NEOPOR® (registered BASF trade mark)

Aluminium rail or cable guiding (for example for solid glass corners)

Neat stacking due to predetermined bending points

Slimline bottom rail





### The ARTec advantages at a glance

- External Venetian blind system made of high-quality aluminium
- Head rail open on the underside: offers improved access when installed
- Slimline bottom rail: for flat stack heights
- Neat stacking Predetermined bending points, ladder cords with defined positioning
- Robust, riveted metal slat guide pins
- Depth-guided Texband lift tapes with side guide tabs
- Kevlar coated ladder cords
- Longitudinal edge coated slats with deep-drawn, beaded lift tape perforation
- Rail bracket system: less bore holes, exact positioning of guide rails
- Exclusive production in Germany

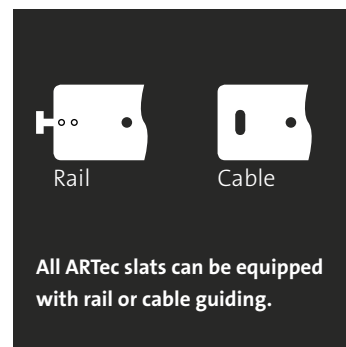
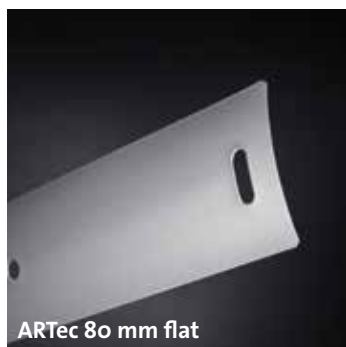
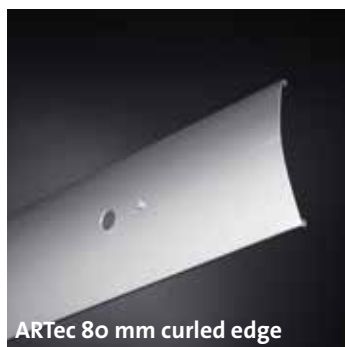
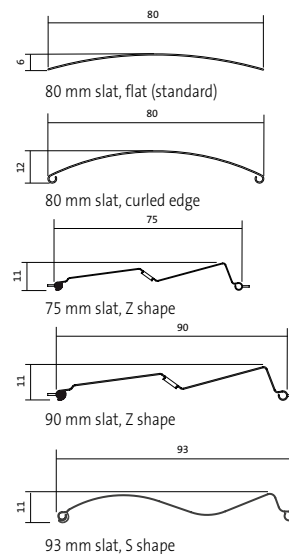



Boxes and covers

**Shutter boxes (aluminium, coated in standard colour White 01)**

Varimaxx® SG 20°

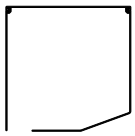

Varimaxx® SG 90°

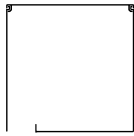

Formado® SGF

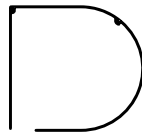

Vivendo® SGR

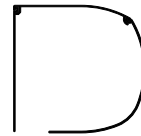

Punext® 20°

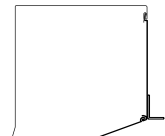

**Visible covers (aluminium, coated)**

Simple cover B1



Angular cover B2

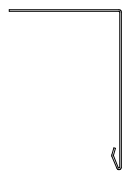

Angular cover B3

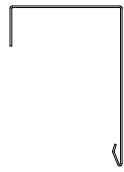

Z-shaped cover B4



U-shaped channel cover B5

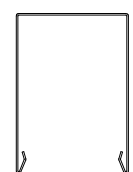

**Covers can be plastered (aluminium, coated in standard colour White 01) | plaster supports available (optional)**

Simple plaster cover P1



Angular plaster cover P2

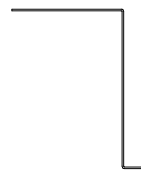

Angular plaster cover P3

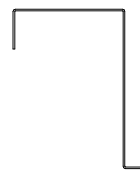

Z-shaped plaster cover P4

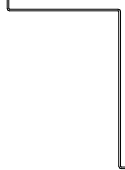

U-shaped channel double plaster cover P5

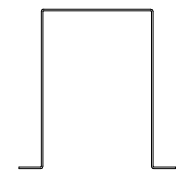

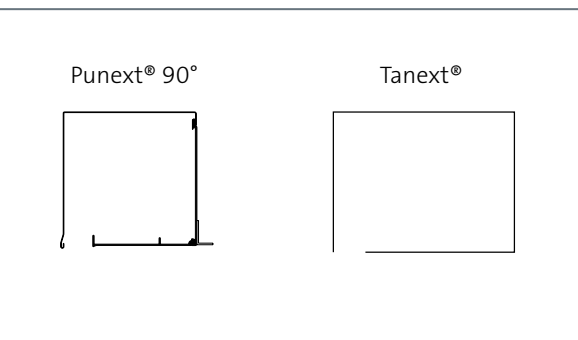
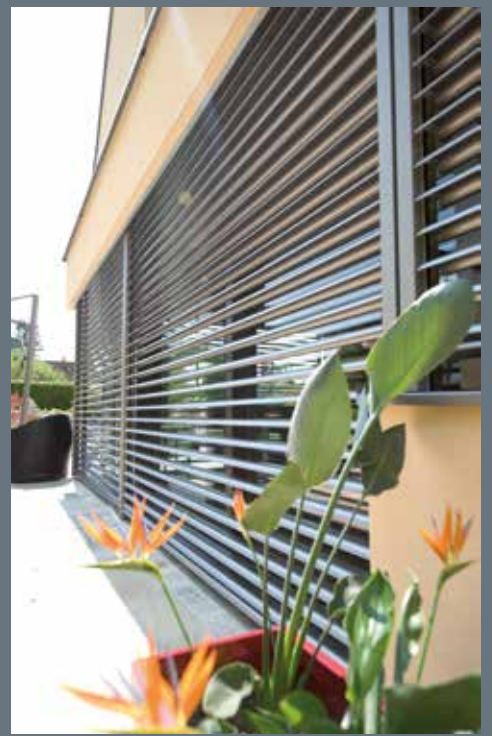

**NEOPOR® shutter box designed for new buildings**

Enext®\_RG

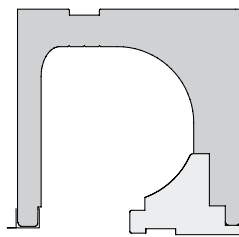

**Slat protection and façade appearance**

You have the opportunity to protect your rolled up slats against the elements with solutions that best fit the exterior of your home and your tastes. Fully enclosed shutter box or cover, virtually invisible when installed as a flush mounted version, or integrated as a design element: Benefit from a huge array of shapes, colours and designs!

U-round channel cover R1

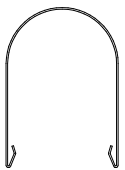

Visible or invisible?

U-shaped channel plaster cover P6

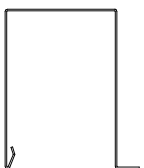



## *The art of controlling daylight*

### **Creating the perfect room ambience**

External Venetian blinds create an individual and stylish look. Natural daylight, precise sun and privacy protection, the ideal room climate: Everything can be controlled precisely with ARTec external Venetian blinds. Create an instant atmosphere to suit your mood. How much light do you want to let in and how much heat do you want to keep out? How much privacy do you require? The flexible and cost effective solution for both your home and the office.

### **The art of controlling daylight**

ARTec external Venetian blinds are sophisticated light control systems. Their slat architecture and guide rails enable precise, unequalled control of daylight entering your home. The result: a flexible, bright and airy space through natural light – without unwanted glare. Outstanding privacy whilst affording a view to the outside.

### **Ultimate privacy**

External Venetian blinds allow you to control the amount of daylight coming into your rooms whilst stopping prying eyes from looking in. ARTec external Venetian blinds allow a greater level of privacy throughout your home. Improved concentration levels in offices, whenever required.

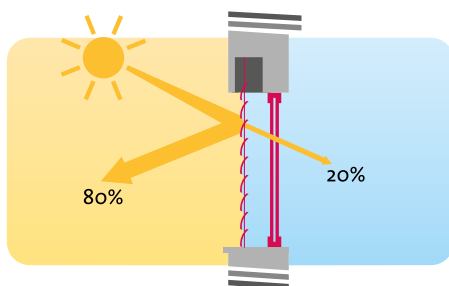

Our aluminium external Venetian blinds are an energy-saving alternative to air conditioning systems. They reflect up to 80% of the sun's rays and thus prevent heat gain in rooms – naturally.







### Programmable light control from Alulux

ARtec Comfort: easy control of individual external Venetian blinds or whole external Venetian blind groups via the programmable remote control. Controlling daylight has never been so easy. ARtec external Venetian blinds can be seamlessly integrated into home automation systems.



## Product range

Support products box system Alulux	Alulux system	Box sizes	Type of slats
			F = flat slat B = curled edge slat Z = Z-shaped slat
Varimaxx® Roller shutter box made of extruded aluminium	SG 20	165	80 F
		180	80 B on request*
		205	75 Z on request*
Formado® 1/2 round roller shutter box made of extruded aluminium	SG 90	165, 165 FG	80 F
		180, 180 FG	80 B on request*
		205, 205 FG	75 Z on request*
Vivendo® Round roller shutter box made of extruded aluminium	SGF	165, 165 FG	80 F
		180, 180 FG	80 B on request*
		205, 205 FG	75 Z on request*
Punext® Roller shutter box made of roll-formed/extruded aluminium	SGR	165	80 F
		180	80 B on request*
		205	75 Z on request*
Tanext® PVC external box system	PSG 20	165, 165 FG	80 F
		180, 180 FG	80 B on request*
		205, 205 FG	75 Z on request*
Enext®_RG External box system for new buildings, sealed on the inward facing side	PSG 90	165, 165 FG	80 F
		180, 180 FG	80 B on request*
		205, 205 FG	75 Z on request*
Covers can be plastered   Complete external Venetian blinds	PVC attachment	175	80 F
		210	80 B on request*
		235	75 Z on request*
Visible covers   Complete external Venetian blinds	RG, sealed on the inward facing side	278, 278 FG	80 F
		300, 300 FG	80 B
		338, 338 FG	75 Z
Exclusive external Venetian blind package	Aluminium covers	360, 360 FG	80 F
			80 B
			75 Z
			90 Z
			93 S
			80 F
			80 B
			75 Z
			90 Z
			93 S
			80 F
			80 B
			75 Z
			90 Z
			93 S
			80 F
			80 B
			75 Z
			90 Z
			93 S
			80 F
			80 B
			75 Z
			90 Z
			93 S
			80 F
			80 B
			75 Z
			90 Z
			93 S

\* Greater stack heights due to the shape of the profile, therefore always check the feasible stack height.





## Colours and additional equipment

### Guidance and operation

ARtec external Venetian blind systems can be fitted with rail or cable guiding. You can also choose between crank or motor operation. Adjacent elements can be coupled.

### Convenient additional equipment

You can remote control your external Venetian blind system with any number of hand sensors. The programmable timer can be used to automatically operate individual external Venetian blinds or whole external Venetian blind groups. The wind sensor ensures your external Venetian blinds are retracted safely if the wind becomes too strong.



### Disclaimer!

We have made every effort to make the colours on the chart as close as possible to the actual colours. Unfortunately, we cannot guarantee an exact colour match and the colour appearing on the chart should not be relied on as being such due to manufacturing methods and pigmentation. The colour chart is, therefore, intended for information only; 100% colour accuracy cannot be guaranteed due to printing techniques.



Wind sensor:



Hand sensor with scroll wheel



Programmable timer



## ***SolidScreen®: Sun protection that combines design and innovation!***

### **Alulux zip textile screens**

SolidScreen from Alulux clearly demonstrates that design flair can be combined with innovative performance. The extensive range of high-quality fabrics allows you to enhance the whole façade with a distinctive, exclusive look. And the functional features are just as sophisticated and impressive: Zip textile screens keep rooms nice and cool and ensure pleasant natural light, as they reduce the direct sunlight entering a room by up to 90%. Besides providing shade from the sun they also offer privacy from prying eyes.

The demands placed on external sun protection systems are increasing all the time, with windproof utilisation and solar shading for larger glazed surfaces being just two of the many basic requirements. The intelligent zip system of the Alulux fabric screens ensures they operate smoothly in a special insert in the guide rail. The zip guide guarantees the screen is held securely and does not distort when exposed to winds of up to 145 km/h, as determined by a wind tunnel test at the Karman Institute. Large surface systems up to 15 m<sup>2</sup> are possible thanks to the zip technology.

The rolled up fabric screen is protected against the elements in the small, unobtrusive aluminium cassette. The use of glass fibres in the fabric screen and the carefully powder coated aluminium profiles and small parts ensure long life and durability of the product. The cassette is assembled simply by connecting the head sections to the guide rails, which are fitted directly to the wall in advance. The zip fabric screen is driven either by a standard motor drive or optionally by a radio-controlled drive.



# ALULUX®

**SolidScreens® offer additional comfort, as well as easy and flexible operation.**

Create the atmosphere you desire for your home. Moreover, protect your furniture from the harmful rays of the sun and your windows against the elements. The extensive range of colours allows you to create the style you want – whether when building a new home or renovating an old one.





**A choice of  
33 different designs.**

Thanks to an extensive range of designs from the Sergé collection, Alulux zip textile screens are the perfect solution for letting light in and keeping prying eyes out.

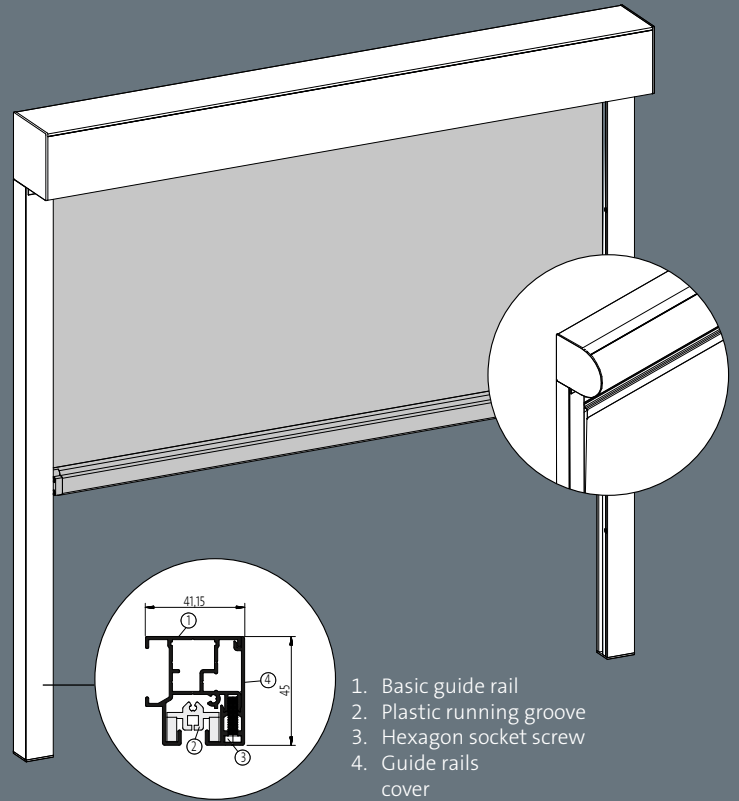
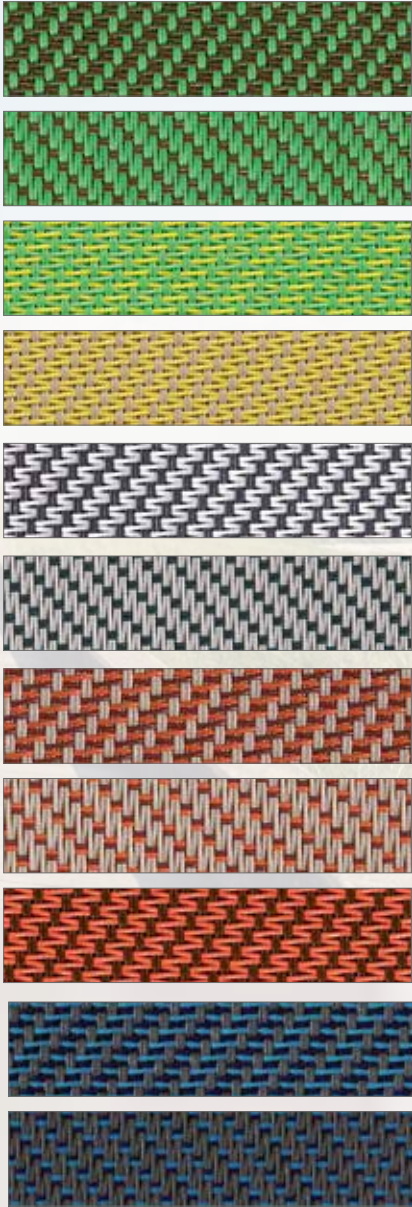

1. Basic guide rail
2. Plastic running groove
3. Hexagon socket screw
4. Guide rails cover

**The square system  
SolidScreen® SG 90**

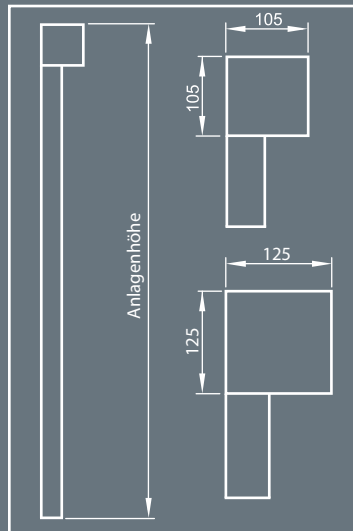

**The round system  
SolidScreen® SGF**

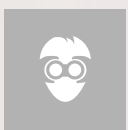
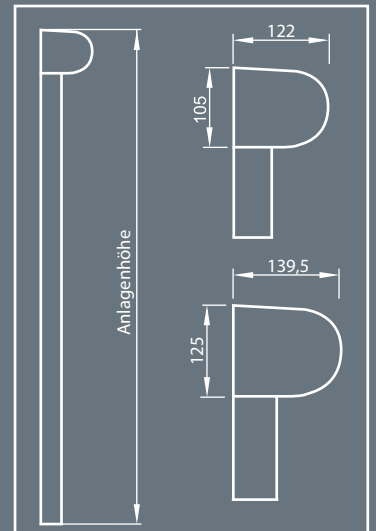

Privacy protection

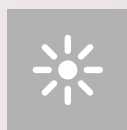

Sun protection



Cold and thermal insulation



Light control

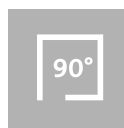

**The square  
90° system:**

The square box made of aluminium is installed in the reveal flush with the façade – without appearing awkward or angular. The 90° version offers a soft uncluttered finish to your windows. The system can also be mounted onto brickwork.



**The round system:**

The round system is fresh and modern in style with a timeless design. It is robust yet exudes an air of lightness. The result is a shape and appearance that blends wonderfully into the architecture – even giving it the finishing touch.







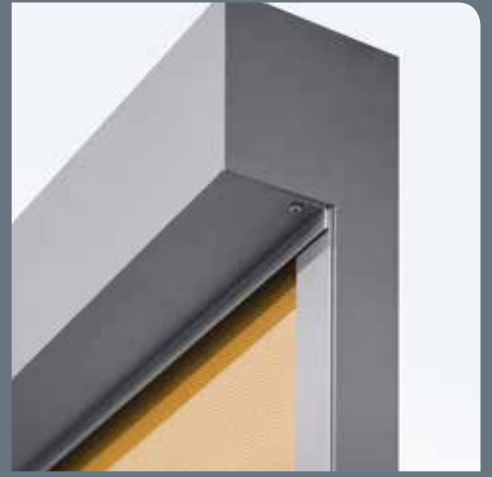

ALULUX®

