

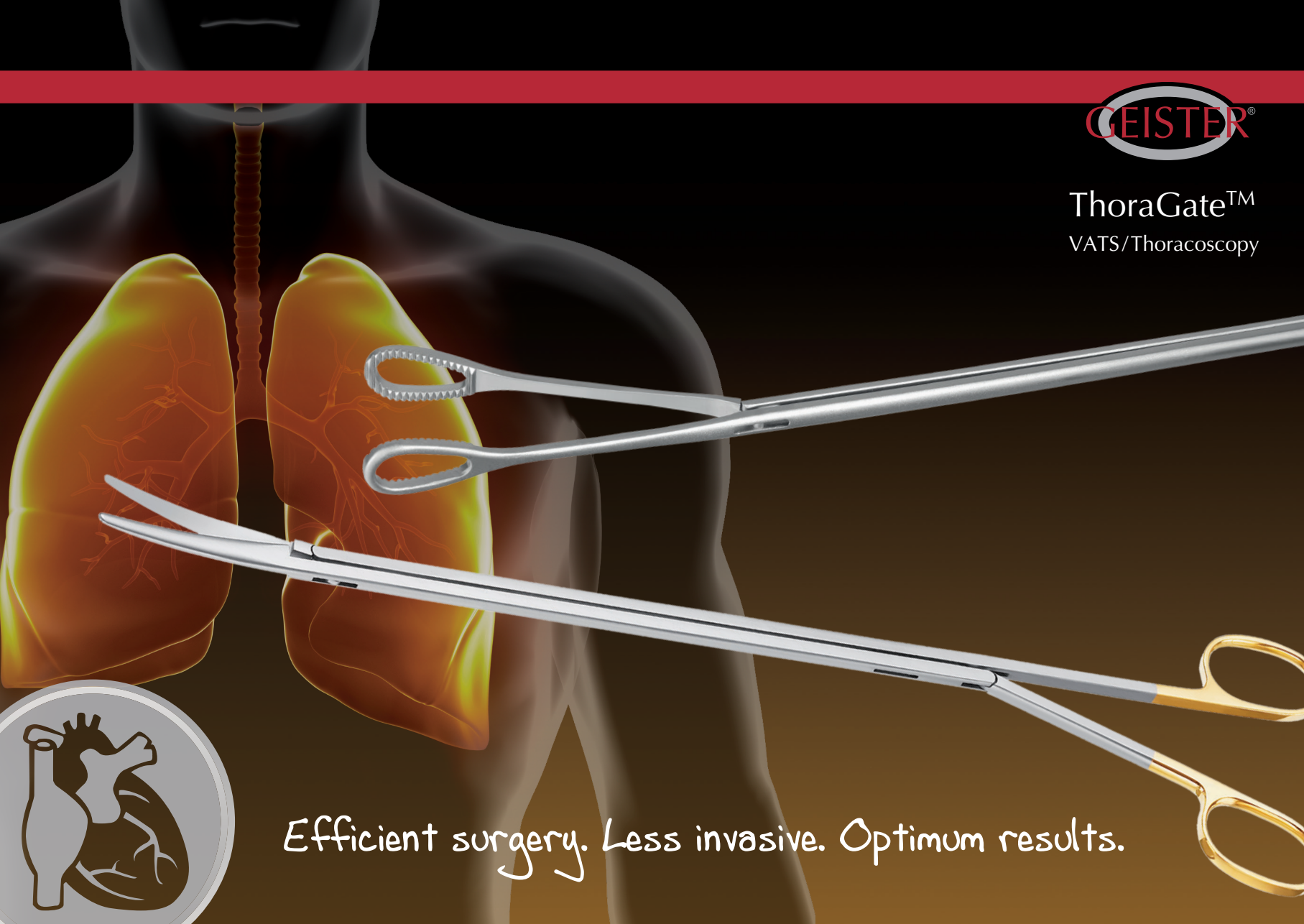

ThoraGate™
VATS/Thoracoscopy

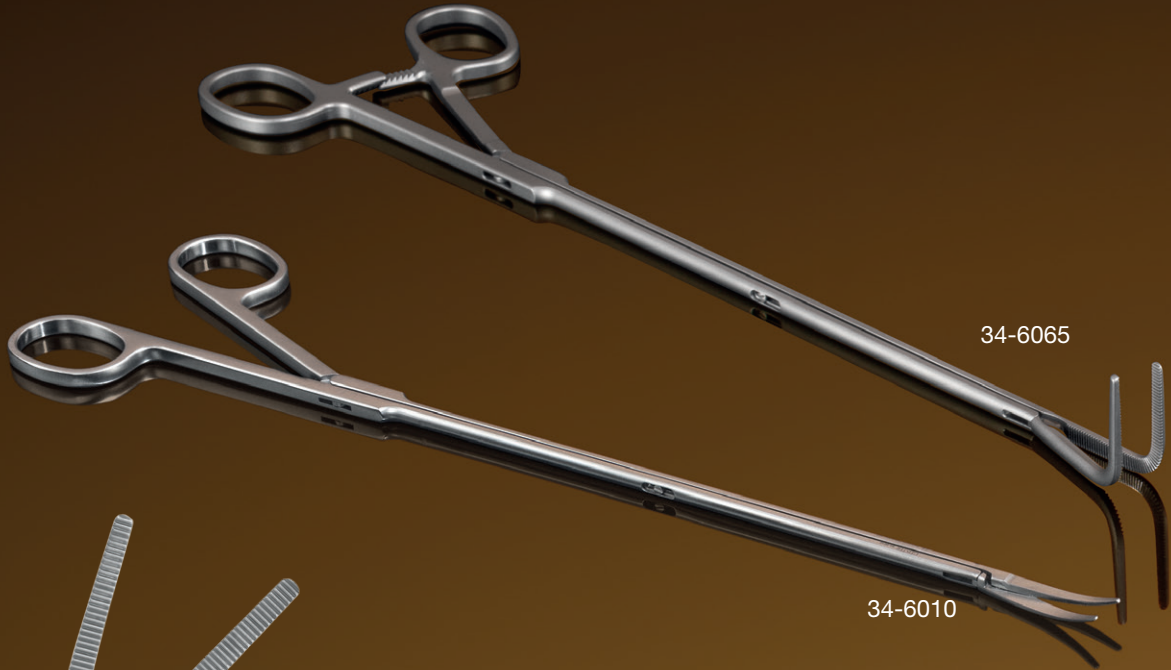

Efficient surgery. Less invasive. Optimum results.



34-6065

34-6010

34-6020

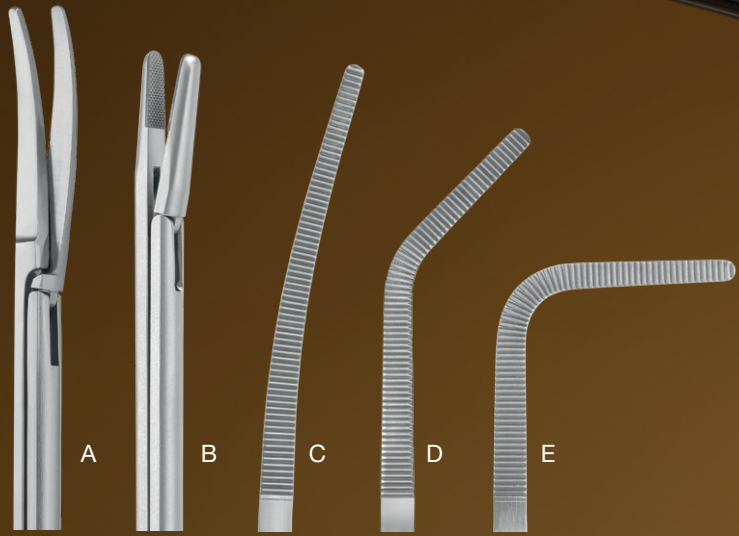

A

B

C

D

E



34-6060

**ThoraGate™ miniVATS Scissors,
sliding shaft 5 mm**

34-6010	A	33 cm	slightly curved
34-6012		33 cm	strongly curved

**ThoraGate™ miniVATS Needle Holders,
sliding shaft 5 mm, with ratchet**

34-6020	B	31.5 cm	straight, strong jaw
34-6021		31.5 cm	curved, strong jaw
34-6025		31.5 cm	straight, delicate jaw
34-6026		31.5 cm	curved, delicate jaw

**ThoraGate™ miniVATS Dissectors,
sliding shaft 5 mm**

34-6060	C	35.5 cm	slightly curved, without ratchet
34-6061	C	35.5 cm	slightly curved, with ratchet
34-6062	D	35 cm	45° curved, without ratchet,
34-6063	D	35 cm	45° curved, with ratchet
34-6064	E	35.5 cm	90° curved, without ratchet
34-6065	E	35.5 cm	90° curved, with ratchet

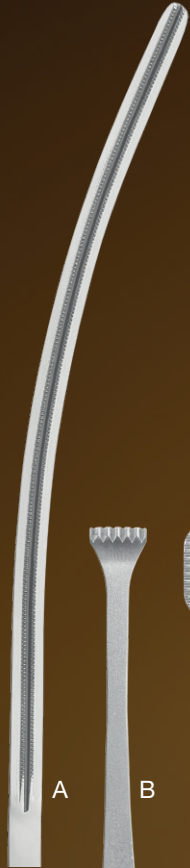

A



B



C



D



E



F



34-6071

34-6070





34-6050

34-6040

**ThoraGate™ miniVATS DeBakey Clamp, regular jaw (1x2)
sliding shaft 5 mm, with ratchet**

34-6100 A 39.5 cm curved, length of jaw 100 mm

**ThoraGate™ miniVATS Allis Grasper,
sliding shaft 5 mm, with ratchet**

34-6040 B 34.5 cm

**ThoraGate™ miniVATS Lymph Node Grasper,
sliding shaft 5 mm, with ratchet**

34-6050 C 34.5 cm straight, jaw 6 mm

34-6051 D 34 cm 45° curved, jaw 6 mm

**ThoraGate™ miniVATS Foerster Lung Grasper,
sliding shaft 5 mm, with ratchet**

34-6070 E 36.5 cm oval ring 13 mm, straight

**ThoraGate™ miniVATS Duval Lung Grasper,
sliding shaft 5 mm, with ratchet**

34-6071 F 34.5 cm 30° curved, jaw 8 mm



Scissors



ValveGate™ PRO

ValveGate™ PRO with their solid modern design are a progressive alternative for thoracic surgery instruments, tried and tested for minimal surgery in different demanding fields and recognized as efficient and reliable in VATS.

Graspers



Needle Holders



Dissecting Forceps



Accessories



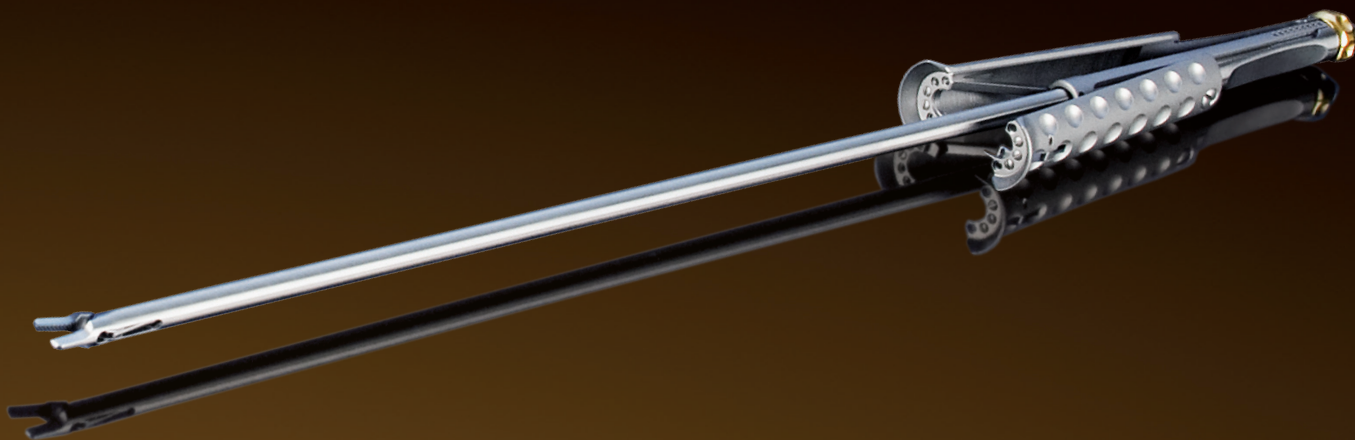

Scissors

Fig.	Art.-No.	Fig.	Art.-No.	Fig.	Art.-No.	Fig.	Art.-No.	Fig.	Art.-No.	Fig.	Art.-No.
1	38-7830	3	38-7832	5	38-7835	7	38-7840	9	38-7860	11	38-7863
2	38-7831	4	38-7833	6	38-7836	8	38-7842	10	38-7862	12	38-7861

Graspers

Fig.	Art.-No.	Fig.	Art.-No.	Fig.	Art.-No.	Fig.	Art.-No.	Fig.	Art.-No.	Fig.	Art.-No.	Fig.	Art.-No.
13	38-7816	15	38-7821	17	38-7824	19	38-7826	21	38-7881	23	38-7918	25	38-7922
14	38-7820	16	38-7822	18	38-7825	20	38-7827	22	38-7917	24	38-7919		

Needle Holders

Fig.	Art.-No.	Fig.	Art.-No.	Fig.	Art.-No.	Fig.	Art.-No.	Fig.	Art.-No.	Fig.	Art.-No.
26	38-7799	28	38-7802	30	38-7804	32	38-7805	34	38-7823	36	38-7878
27	38-7800	29	38-7803	31	38-7806	33	38-7807	35	38-7828		

Dissecting Forceps

Accessories

Fig.	Art.-No.	Fig.	Art.-No.	Fig.	Art.-No.	Fig.	Art.-No.	Fig.	Art.-No.	Fig.	Art.-No.	Fig.	Art.-No.
37	34-7486	39	34-7484	41	34-7480	43	34-7470	45	34-7494	47	34-7496	49	38-7850
38	34-7485	40	34-7475	42	34-7471	44	34-7465	46	34-7495	48	38-7460	50	38-7851



34-7325



34-7330

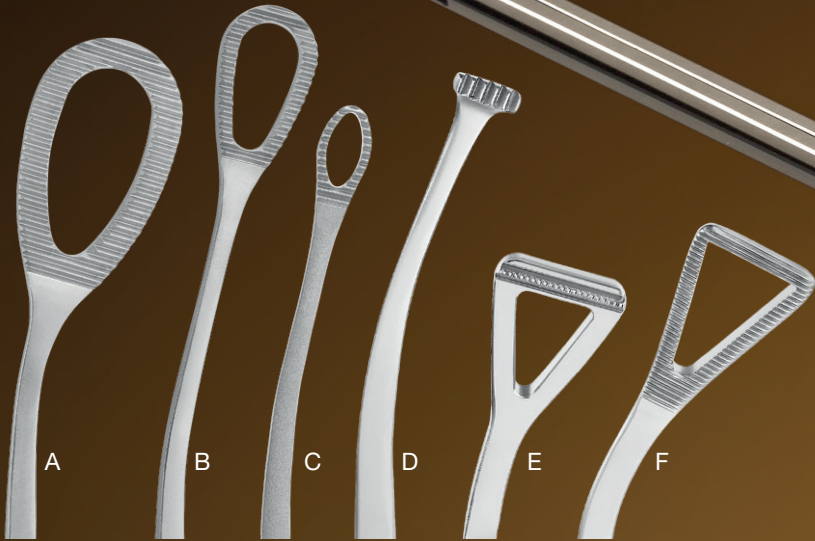

A

B

C

D

E

F

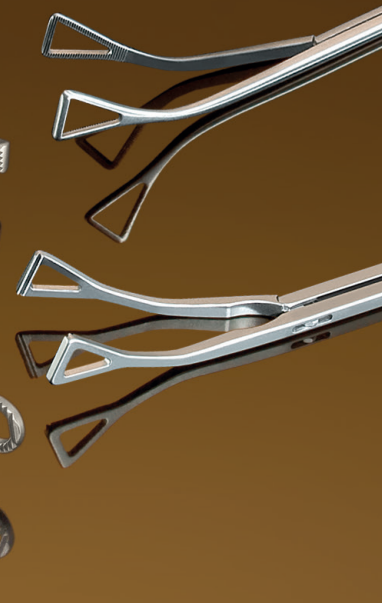

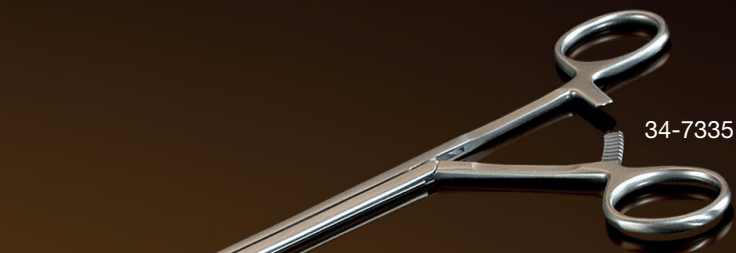

34-7335



34-7336

**ThoraGate™ Foerster Lung Grasper,
with ratchet, sliding shaft,
regular 10 mm**

34-7329	A	33.5 cm	curved, oval ring 20 mm
34-7330	B	33.5 cm	curved, oval ring 13 mm
34-7330R	C	33.5 cm	curved, oval ring 7 mm
slim 7 mm			
34-7328	C	33.5 cm	curved, oval ring 7 mm

ThoraGate™ Allis Grasper, sliding shaft, with ratchet

34-7325	D	34 cm
---------	---	-------

**ThoraGate™ Atraumatic Duval Lung Grasper,
with ratchet, sliding shaft**

34-7336	E	32,5 cm	curved, 14 mm
---------	---	---------	---------------

**ThoraGate™ Duval Lung Grasper,
with ratchet, sliding shaft**

34-7335	F	33,5 cm	curved, 15 mm
34-7334	F	33,5 cm	curved, 25 mm

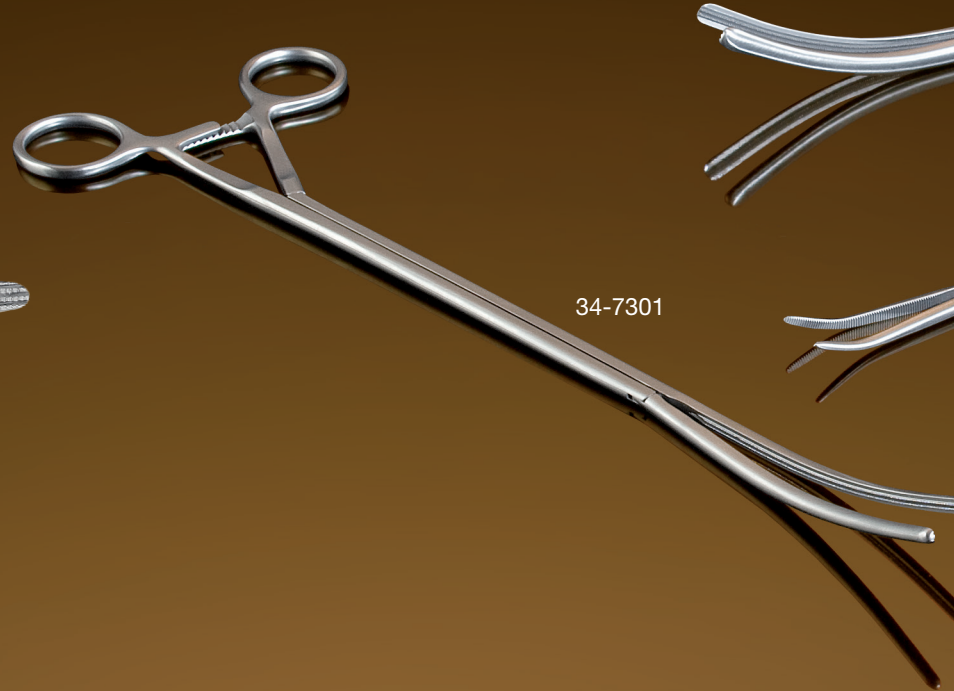
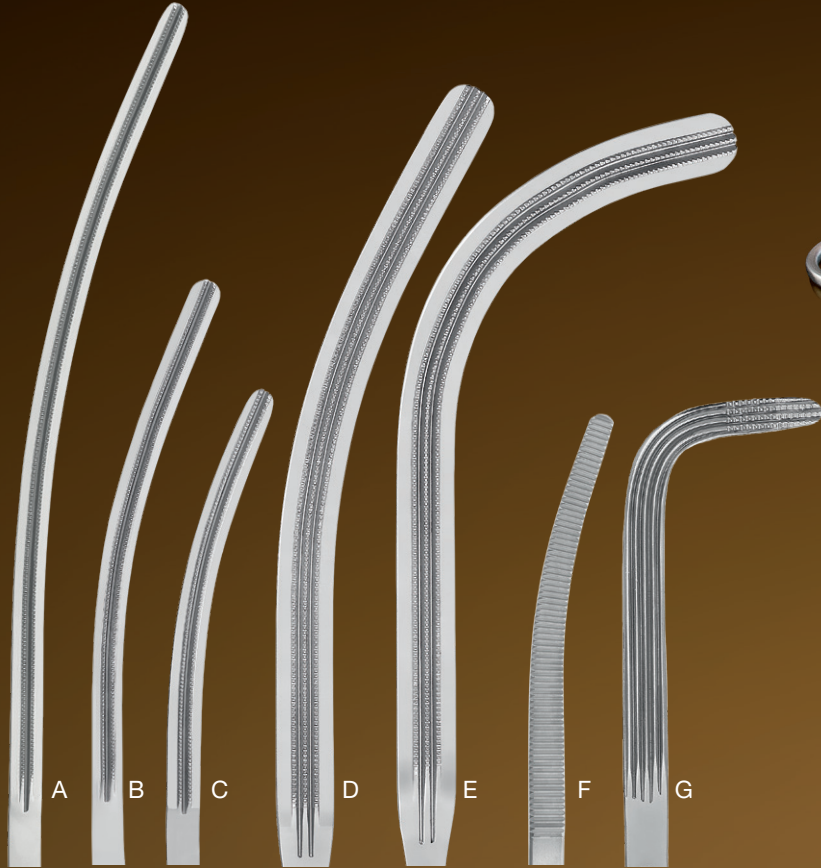

34-7301

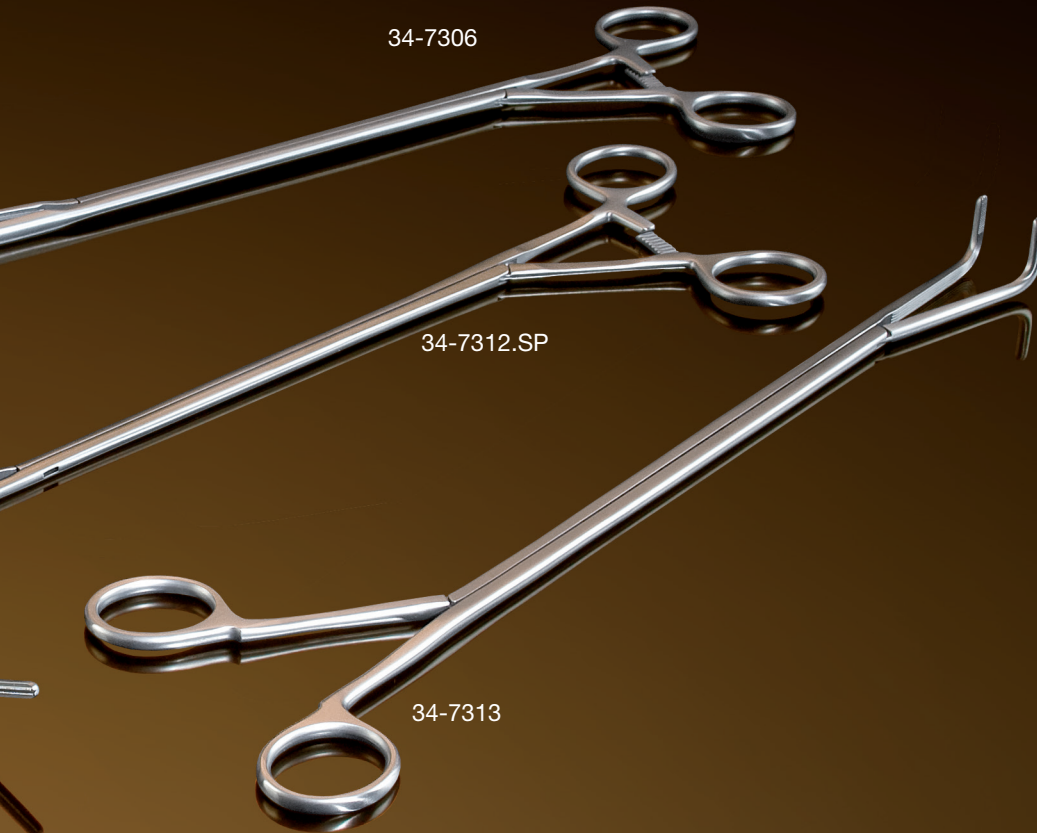

34-7306

34-7312.SP

34-7313

ValveGate™ DeBakey Transthoracic Aortic Clamp, with ratchet, regular jaw (1x2), sliding shaft

34-7301	A	36 cm	100 mm
34-7302	B	34 cm	75 mm
34-7303	C	32 cm	50 mm

ValveGate™ DeBakey Transthoracic Aortic Clamp, with ratchet, wide jaw (2x3), sliding shaft

34-7306	D	36 cm	100 mm
34-7311	E	35 cm	100 mm

ThoraGate™ Dissecting Forceps, sliding shaft, without ratchet

34-7312	F	33.5 cm
34-7312.SP	F	33.5 cm

ThoraGate™ DeBakey-Cooley Forceps, sliding shaft, without ratchet

34-7313	G	35 cm
34-7313.SP	G	35 cm

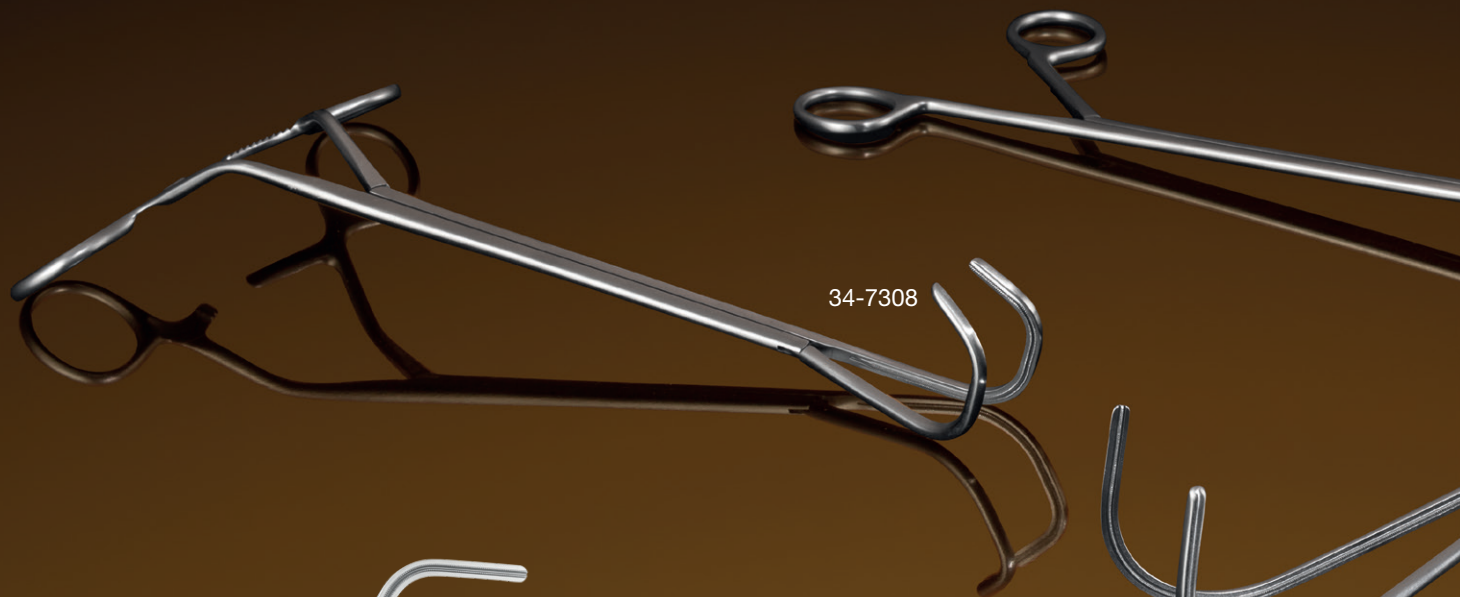

34-7308



A

1/2

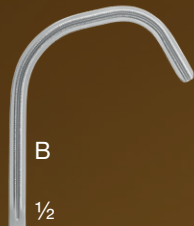

B

1/2

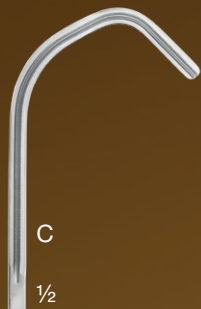

C

1/2



D

1/2

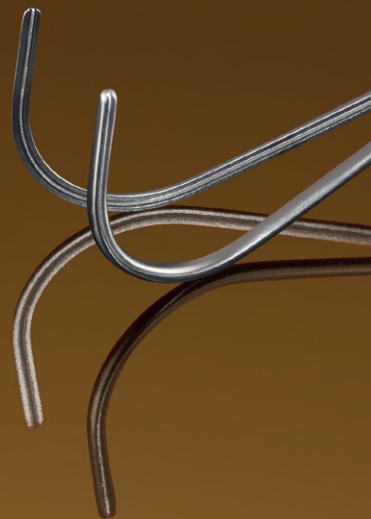

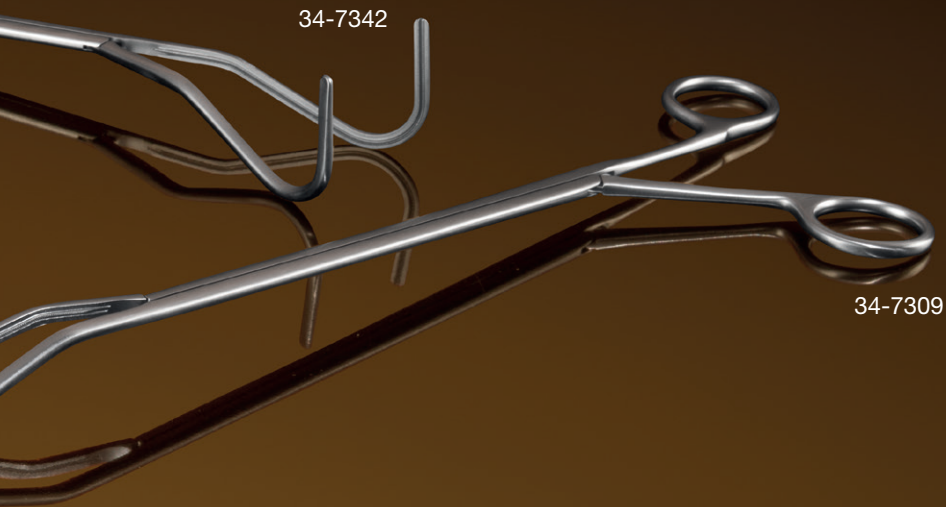

**ThoraGate™ Semb Clamp, sliding shaft
without ratchet**

34-7309 A 39 cm

**ThoraGate™ Lambert-Kay Aortic Clamp
angled handle, ratchet, sliding shaft**

34-7308 B 31 cm

34-7308.BE C 31 cm

**ThoraGate™ You Dissecting Clamp, sliding shaft,
without ratchet**

34-7342 D 35.5 cm

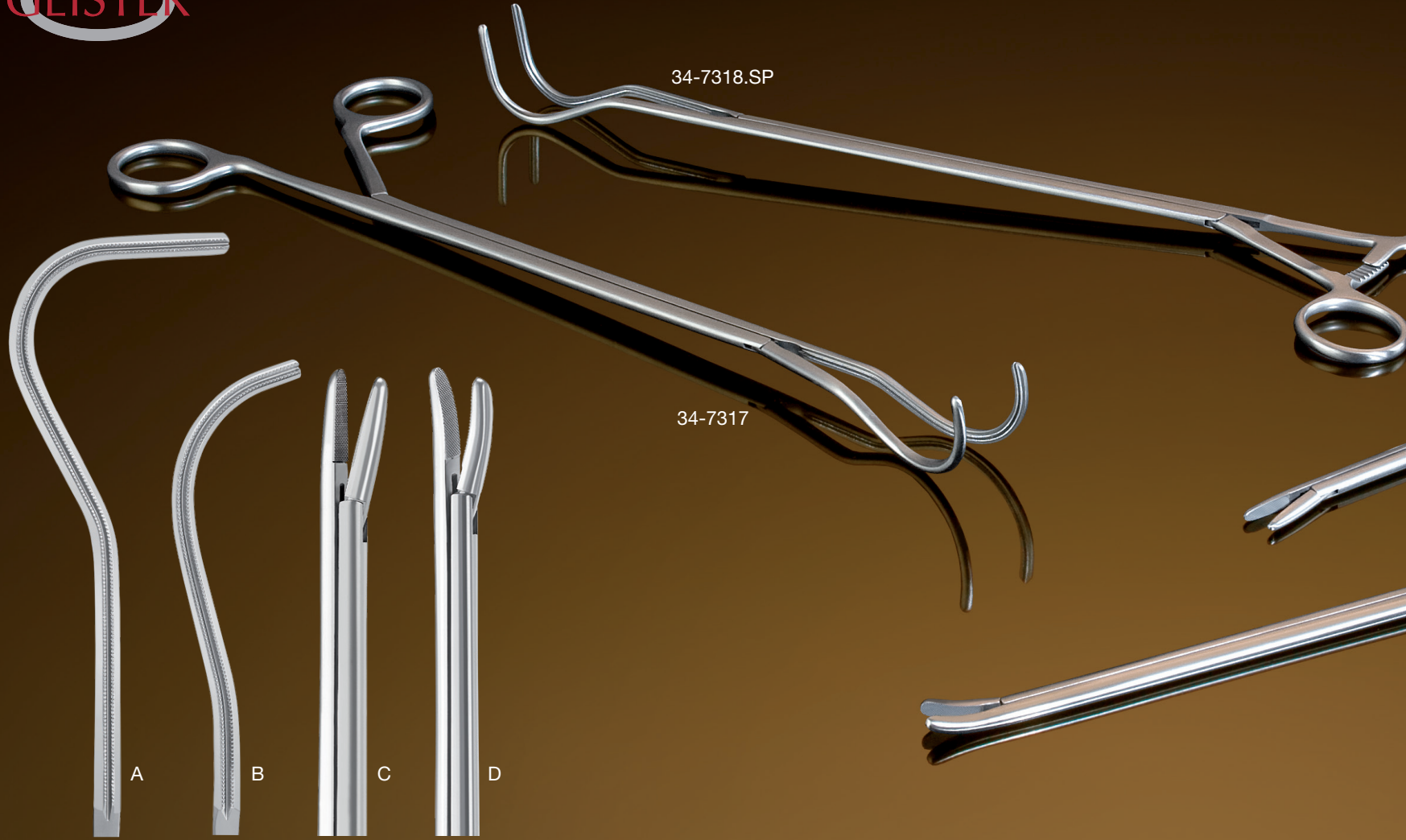

34-7318.SP

34-7317

A

B

C

D



ThoraGate™ Harken #2 Lung Clamp, sliding shaft, without ratchet

34-7318 A 35 cm

with ratchet

34-7318.SP A 35 cm

ThoraGate™ Harken #1 Lung Clamp, sliding shaft, without ratchet

34-7317 B 35 cm

with ratchet

34-7317.SP B 35 cm

ThoraGate™TC Needle Holder with ratchet, regular, sliding shaft

34-7351 C 33.5 cm 10 mm straight

34-7352 D 33.5 cm 10 mm curved

ThoraGate™TC Needle Holder with ratchet, slim, sliding shaft

34-7353 C 33.5 cm 7 mm straight

34-7354 D 33.5 cm 7 mm curved

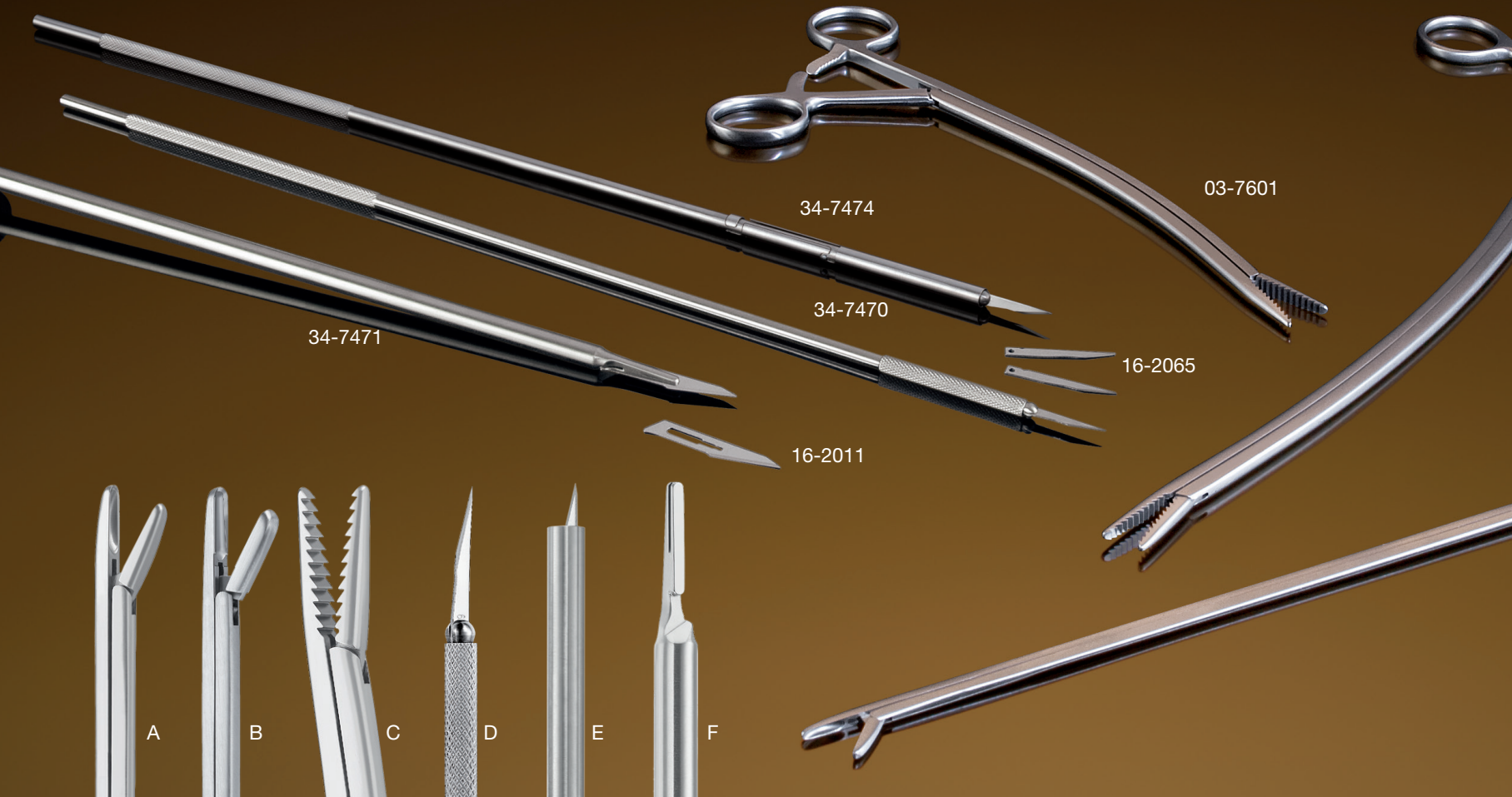



03-7610

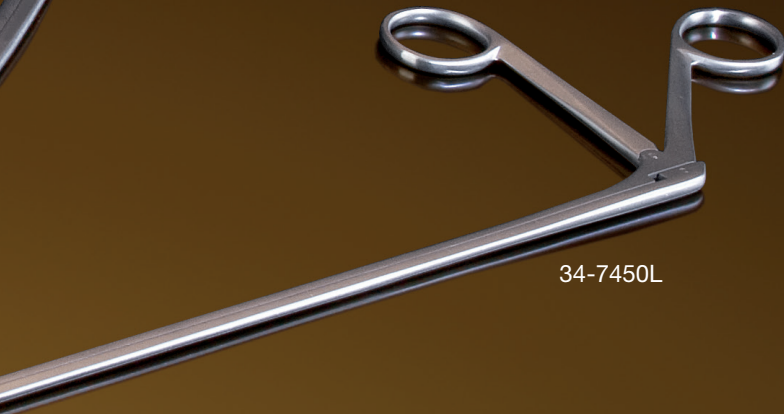

34-7450L



detachable

ValveGate™ Aortic Valve Rongeur/Biopsy Forceps shaft straight

34-7450	A	30 cm	jaw 3 mm, straight
34-7450L	A	40 cm	jaw 3 mm
34-7450S	A	17 cm	jaw 3 mm
34-7451		30 cm	jaw 30° upwards
34-7451S		17 cm	jaw 30° upwards

ValveGate™ Aortic Valve Rongeur/Biopsy Forceps shaft straight, detachable

34-7450.Z	B	30 cm	jaw 3 mm, straight
34-7450L.Z	B	40 cm	jaw 3 mm
34-7450S.Z	B	17 cm	jaw 3 mm
34-7451.Z		30 cm	jaw 30° upwards
34-7451S.Z		17 cm	jaw 30° upwards

**Chest Tube Passer 24 cm
without ratchet**

03-7600	C	24 cm
03-7610	C	35 cm

with ratchet

03-7601	C	24 cm
03-7611	C	35 cm

ValveGate™ Mini Blade Holder and Blades

34-7470	D	37 cm	ValveGate™ Mini Blade Holder
34-7474	D+E	37 cm	ValveGate™ Protected Mini Blade Holder
16-2065			Mini Scalpel Baldes #65 (pack of 10 pcs., sterile)
34-7471	F	35 cm	ValveGate™ Scalpel Handle 35 cm
16-2011			Scalpel Blades #11 (pack of 100 pcs., sterile)



34-7510



34-7511



34-0956



34-0960.AC

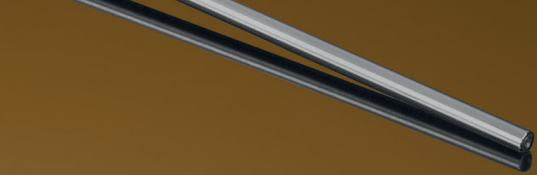

34-0952

**Endoscopes**

Art.No.	Diameter working length	Direction of view:
34-0960.17	Ø 5.0 mm, 17,5 cm	0°
34-0961.17	Ø 5.0 mm, 17,5 cm	30°
34-0961.23	Ø 5.0 mm, 23 cm	30°
34-0960.AC	Ø 5.0 mm, 30 cm	0°
34-0961.AC	Ø 5.0 mm, 30 cm	30°
34-0962.18	Ø 10.0 mm, 18 cm	0°
34-0967.18	Ø 10.0 mm, 18 cm	30°
34-0962.23	Ø 10.0 mm, 23 cm	0°
34-0967.23	Ø 10.0 mm, 18 cm	30°
34-0962.AC	Ø 10.0 mm, 31,5 cm	0°
34-0967.AC	Ø 10.0 mm, 31,5 cm	30°
34-0962.35	Ø 10.0 mm, 35 cm	0°
34-0967.35	Ø 10.0 mm, 35 cm	30°
34-0962.43	Ø 10.0 mm, 43 cm	0°
34-0967.43	Ø 10.0 mm, 43 cm	30°

ACMI-, Wolf- and Storz-lightport adapter, standard eye-piece, autoclavable, S/N, single packed.

Thoracic Trocars with Sleeves

Art.No.		Diameter, Working length
34-0855	rigid	Ø 6 mm, 50 mm
34-0852	rigid	Ø 11 mm, 50 mm
34-0851	rigid	Ø 13 mm, 50 mm
34-7510	flexible	Ø 6 mm, 70 mm
34-7510.ST	flexible Spare Tubes, Pack of 5 pcs.	Ø 6 mm, 70 mm
34-7511	flexible	Ø 6 mm, 100 mm
34-7511.ST	flexible Spare Tubes, Pack of 5 pcs.	Ø 6 mm, 100 mm
34-7500	flexible	Ø 11 mm, 100 mm
34-7500.ST	flexible Spare Tubes, Pack of 5 pcs.	Ø 11 mm, 100 mm
34-7501	flexible	Ø 11 mm, 70 mm
34-7501.ST	flexible Spare Tubes, Pack of 5 pcs.	Ø 11 mm, 70 mm

Trocars for Indroducer Sleeves - metal, smooth pyramidal point

34-0956		Ø 5,5 mm, 160 mm
34-0903		Ø 10 mm, 166 mm
34-0923		Ø 11 mm, 170 mm
34-0925		Ø 13 mm, 167 mm
conical point		
34-0957		Ø 5,5 mm, 160 mm
34-0924		Ø 11 mm, 171 mm

Indroducer Sleeves

34-0952	Metal shaft, smooth	Ø 5,5 mm, 103 mm
34-0952.PL	Plastic shaft, smooth	Ø 5,5 mm, 92 mm
34-0952.WC	White seal for Ø 5,5 mm	
34-0952.VV	Silicone valve, Pack of 5 pieces, for Ø 5,5 mm	
34-0951	Metal shaft smooth	Ø 11 mm, 105 mm
34-0951.PL	Plastic shaft, smooth	Ø 11 mm, 97 mm
34-0951.WC	Blue seal for Ø 11 mm	
34-0950	Metal shaft smooth	Ø 13 mm, 102 mm
34-0950.PL	Plastic shaft, smooth	Ø 13 mm, 94 mm
34-0950.WC	Green seal for Ø 13 mm	
34-0951.VV	Silicone valve, Pack of 5 pieces, for Ø 11 and Ø 13 mm	



34-7323



34-7100



34-7493



A



B



C



D



E



F



G



34-7851

34-7494

ThoraGate™ TC Metzenbaum Scissors
slightly curved, sliding shaft

34-7323 A 36 cm

ThoraGate™ Scissors, slightly curved,
sliding shaft

34-7338 B 29 cm

ValveGate™ Knot Pusher

34-7850 C 25 cm push to close

34-7851 D 25 cm push to open, short jaw

ValveGate™ Knot Pusher with blue silicone handle

34-7493 E 31.5 cm

ValveGate™ Adams-Yozu Knot Pusher, both sided

34-7494 F 35 cm/13¾"

ThoraGate™ Dressing Forceps, curved, 50 degrees,
Axial handle with rings

34-7100 G 42 cm jaw 10x4 mm



18-0371.SU



18-0375

18-0370



18-0376.SU

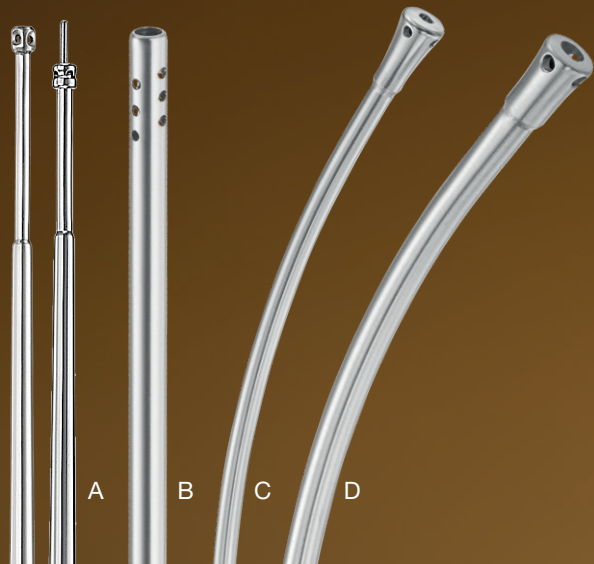

A

B

C

D



18-0380



18-0420

Jamieson Dissection Sucker and Plaque Remover

Art.-No.	Fig.		Ø Hole/Ball	length	
18-0420	A	straight	1,5 mm	27,0 cm	with stylet
18-0420.01		straight	1,0 mm	27,0 cm	with stylet
18-0420.09		straight	0,5 mm	27,0 cm	with stylet
18-0420.10		straight	1,0 mm	21,0 cm	with stylet
18-0420.02		60° angled	1,0 mm	26,0 cm	without stylet
18-0420.03		90° angled	1,5 mm	27,0 cm	without stylet
18-0420.04	Fino	straight	1,5 mm	29,0 cm	without stylet
18-0420.05	Fino	30° angled	1,5 mm	29,0 cm	without stylet
18-0420.06		30° angled	0,5 mm	27,0 cm	with stylet
18-0420.11		15° angled	0,5 mm	27,0 cm	with stylet
18-0420.07		30° angled	1,0 mm	27,0 cm	with stylet
18-0420.12		15° angled	1,0 mm	27,0 cm	with stylet
18-0420.08		30° angled	1,0 mm	27,0 cm	with stylet
18-0420.MA		Mandrin f. Jamieson Dissection Sucker and Plaque Remover			

ThoraGate™ Suction Tube

Art.-No.	Fig.		Ø Shaft	Ø Tip	working length	length	
18-0370	C	Curved	3,2 mm	6,0 mm	17,0 cm	31,0 cm	
18-0370.SU	C	Curved	3,2 mm	6,0 mm	17,0 cm	31,0 cm	variable suction
18-0371	C	Curved	3,2 mm	6,0 mm	22,0 cm	36,0 cm	
18-0371.SU	C	Curved	3,2 mm	6,0 mm	22,0 cm	36,0 cm	variable suction
18-0375	D	Curved	5,0 mm	7,5 mm	22,0 cm	36,0 cm	
18-0375.SU	D	Curved	5,0 mm	7,5 mm	22,0 cm	36,0 cm	variable suction
18-0376	D	Curved	5,0 mm	7,5 mm	32,0 cm	45,5 cm	
18-0376.SU	D	Curved	5,0 mm	7,5 mm	32,0 cm	45,5 cm	variable suction
18-0380	B	straight	5,0 mm	5,0 mm	32,0 cm	45,5 cm	
18-0380.SU	B	straight	5,0 mm	5,0 mm	32,0 cm	45,5 cm	variable suction
18-0381	B	straight	10,0 mm	10,0 mm	32,0 cm	45,5 cm	
18-0381.SU	B	straight	10,0 mm	10,0 mm	32,0 cm	45,5 cm	variable suction



.SU Variable Suction



34-2885



34-2879



34-2877.01

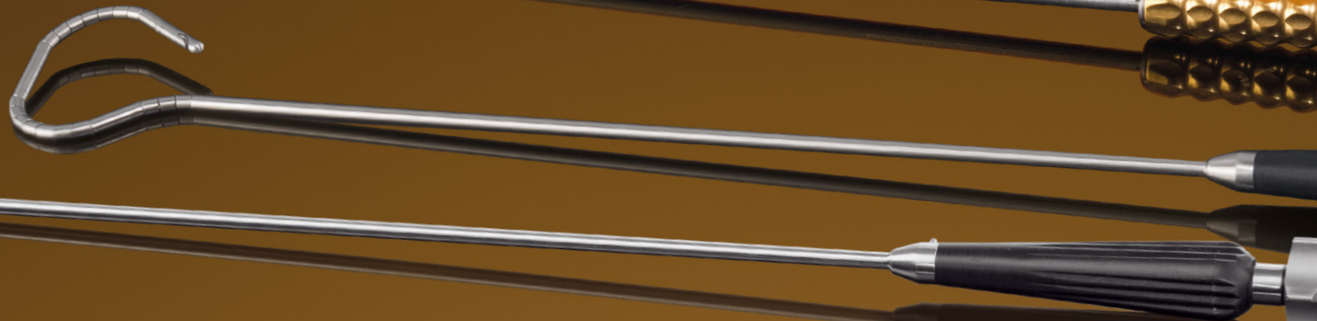

34-2876

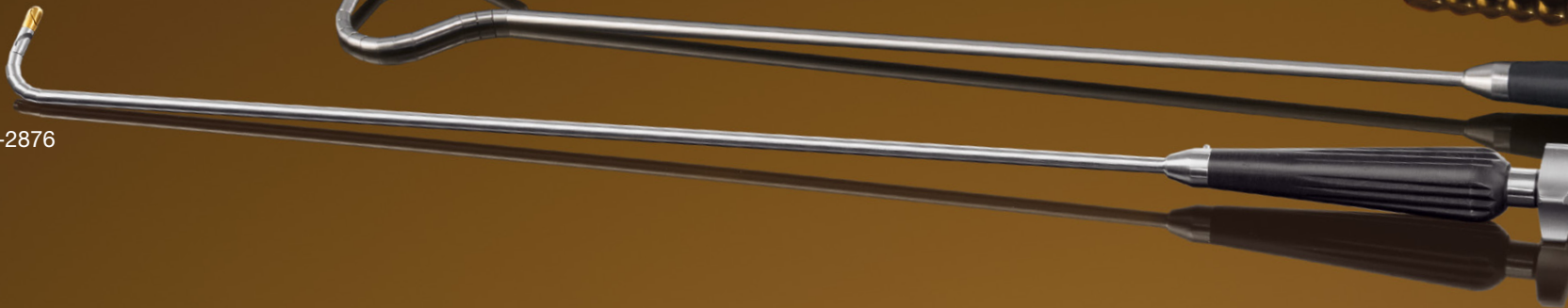



34-2886

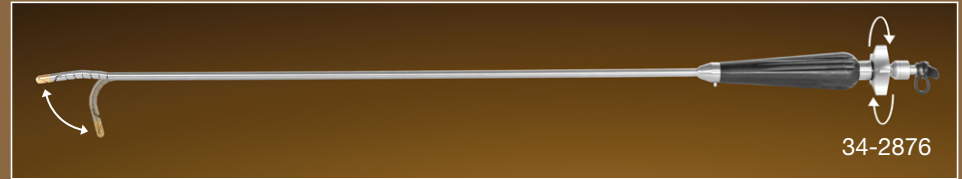

34-2876

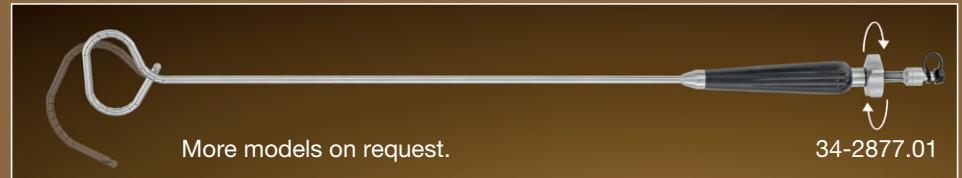

More models on request.

34-2877.01

Articulating Retractor

With flush port aids and actuating knob

Art.No.	Length	Description
34-2876	33 cm	shaft Ø 5 mm, Total length 430 mm
34-2877.01	33 cm	Triangular, leg length 60 mm, shaft Ø 5 mm, Total length 560 mm

Spreading Fan Retractor

Art.No.	Length	Description
34-2879	34 cm	3 fingers, 42 mm spread, Ø 5 mm
34-2885	35 cm	5 fingers, 95 mm spread, Ø 10 mm, working, 45° angleable
34-2886	38 cm	5 fingers, 80 mm spread, Ø 10 mm, working, 0-80° angleable

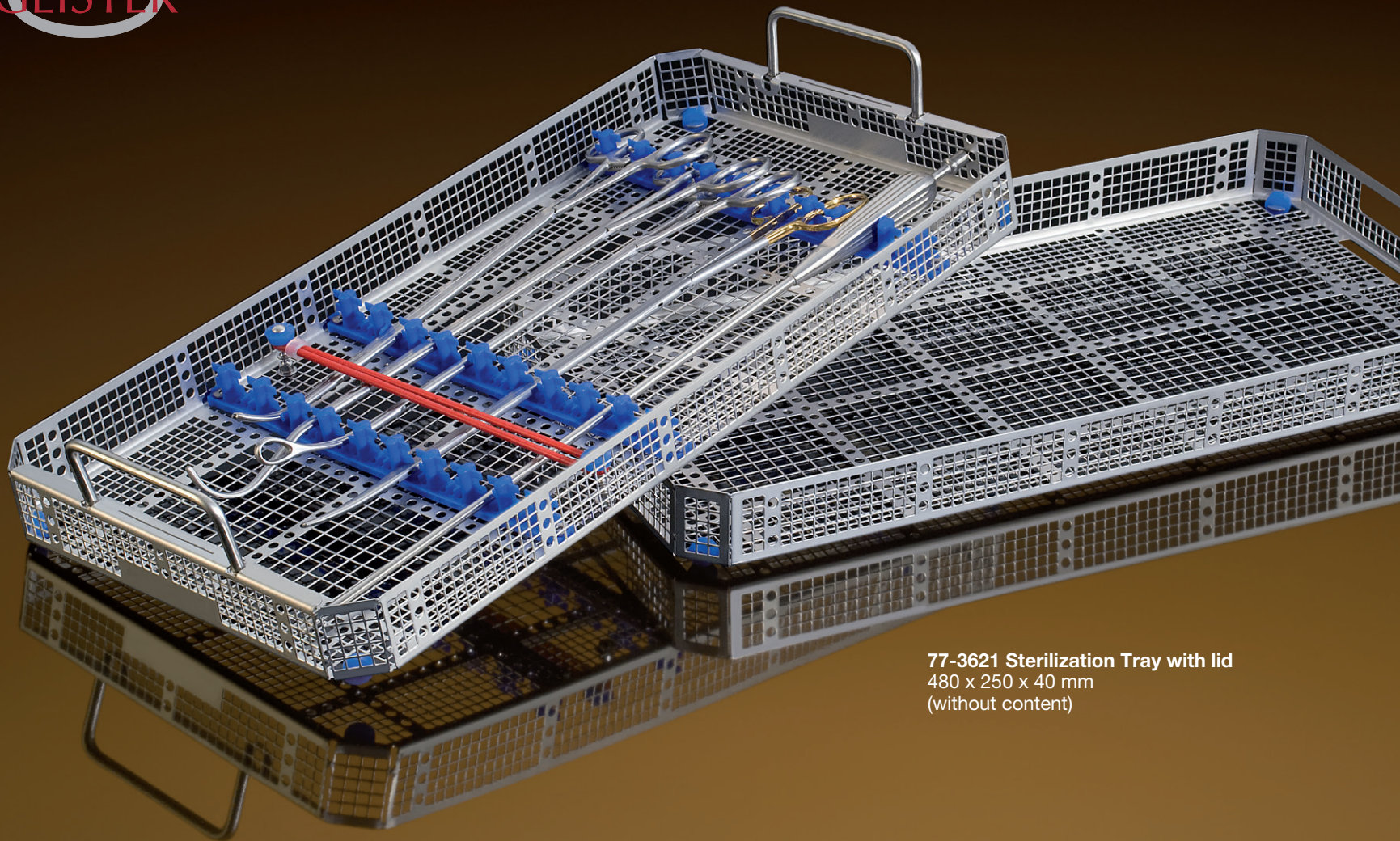

77-3621 Sterilization Tray with lid
480 x 250 x 40 mm
(without content)

Suggested Instrument Kits

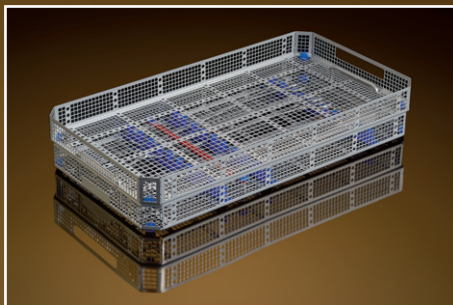
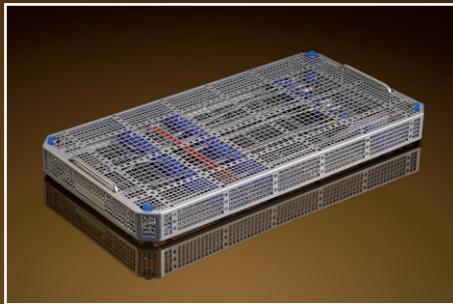
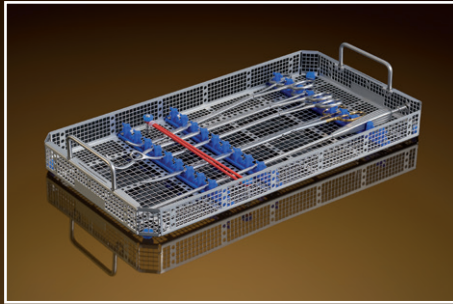
**01-1374 VATS/ThoraGate™ Kit large**

34-7301	1x	Transthoracic Aortic Clamp, 36 cm, 100 mm, curved
34-7302	1x	Transthoracic Aortic Clamp, 32 cm, 50 mm, curved
34-7303	1x	Transthoracic Aortic Clamp, 34 cm, 75 mm, curved
34-7325	1x	ThoraGate™ Allis Forceps, 34 cm, curved, with ratchet
34-7313	1x	ThoraGate™ DeBaKey Cooley Forceps 35 cm, right angled jaws
34-7317	1x	ThoraGate™ Harken #1 Lung Clamp 35 cm, without ratchet
34-7318	1x	ThoraGate™ Harken #2 Lung Clamp 35 cm, without ratchet
34-7330	1x	ThoraGate™ Foerster Lung Grasper 33,5 cm, curved, with ratchet
34-7328	1x	ThoraGate™ Foerster Lung Grasper 33,5 cm, slim, curved, with ratchet
34-7335	1x	ThoraGate™ Duval Lung Grasper 33,5 cm, curved, 15 mm, with ratchet
34-7334	1x	ThoraGate™ Duval Lung Grasper 33,5 cm, curved, 25 mm, with ratchet
34-7323	1x	ThoraGate™ TC Metzenbaum Scissors 36 cm, slightly curved
34-7352	1x	ThoraGate™ TC Needle Holder 33,5 cm, curved, with ratchet
18-0380	1x	ThoraGate™ Suction Tube 45,5 cm, Ø 5 mm, straight
18-0380.SU	1x	ThoraGate™ Suction Tube 45,5 cm, Ø 5 mm, with finger hole, straight
77-3621	2x	ValveGate™PRO Special Tray DIN, 480x250x40 mm, with lid
29-1399	1x	ValveGate™ Soft Tissue Protector, single use, pack of 2, regular size
29-1399S	1x	ValveGate™ Soft Tissue Protector, single use, pack of 2, small size

01-1373 VATS/ThoraGate™ Kit small

34-7301	1x	Transthoracic Aortic Clamp, 36 cm, 100 mm, curved
34-7330	1x	ThoraGate™ Foerster Lung Grasper 33,5 cm, curved, with ratchet
34-7328	1x	ThoraGate™ Foerster Lung Grasper 33,5 cm, slim, curved, with ratchet
34-7336	1x	ThoraGate™ Atraumatic Duval Lung Grasper, 32,5 cm, curved, with ratchet
34-7323	1x	ThoraGate™ TC Metzenbaum Scissors 36 cm, slightly curved
34-7352	1x	ThoraGate™ TC Needle Holder 33,5 cm, curved, with ratchet
18-0380	1x	ThoraGate™ Suction Tube 45,5 cm, Ø 5 mm, straight
77-3621	1x	ValveGate™PRO Special Tray DIN, 480x250x40 mm, with lid
29-1399	1x	ValveGate™ Soft Tissue Protector, single use, pack of 2, regular size
29-1399S	1x	ValveGate™ Soft Tissue Protector, single use, pack of 2, small size

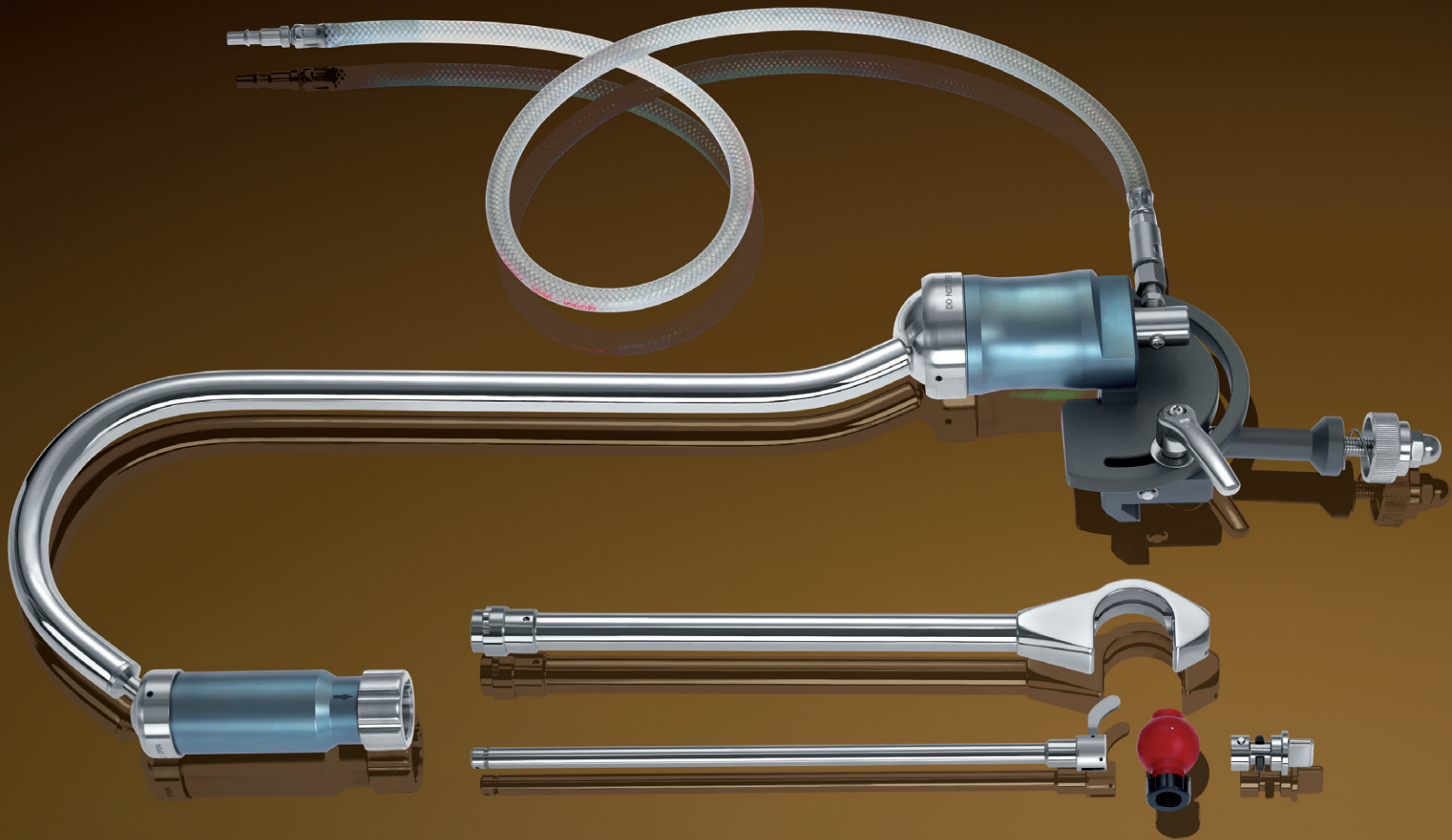



29-5000 Iron-Assistant™ Pneumatic Endoscope Holder

for direct connection with the compressed air supply in the OR (working pressure 5 bar up to 7 bar). Enables instantaneous and unlimited one-hand manipulation of an endoscope or tube shaft instrument within the operating field followed by total steadiness and stability under load once in the „locked“ position. Easy handling and highest reliability due to the one-hand concept with only 3 hinges and the use of titanium components for weight reduction. The pneumatic arm can be easily attached to the OR table rail and is autoclavable completely or partially (if draping is preferred) for quick sterile set-up.

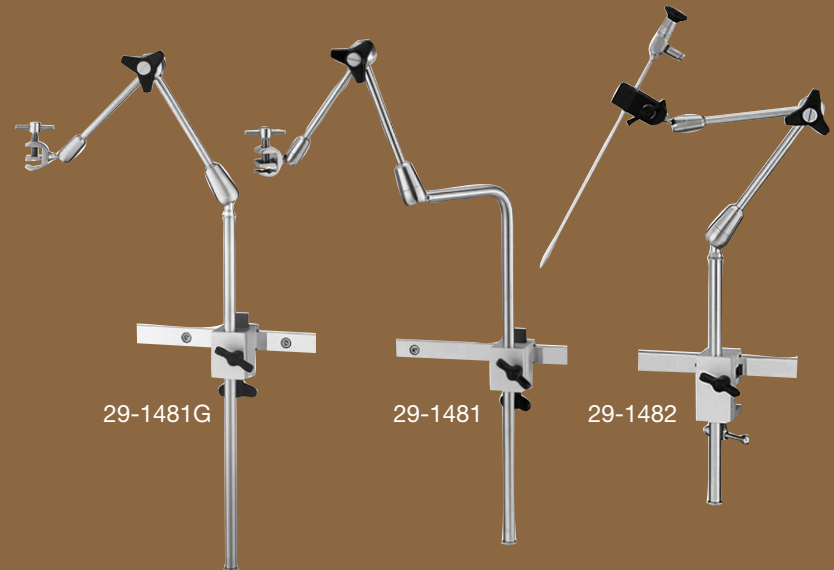

- 29-1481G Iron-Assistant™ Instrument Holder, extra long straight bar
 29-1481 Iron-Assistant™ Instrument Holder, L-shaped bar
 29-1481/I ditto, insulated for use with HF-surgery
 29-1482 Iron-Assistant™ Endoscope Holder, straight bar
 29-1482/I ditto, insulated for use with HF-surgery





ValveGate™ Soft Tissue Protector

The ValveGate™ Soft Tissue Protector for Minimally Invasive Valve Surgery is a sterile, single patient use wall access device consisting of 2 overlaid plastic rings that are interconnected by means of a silicone rubber membrane. The bottom ring is a flexible ring made with a shape memory alloy to be inserted in situ.

The special features are:

- clear and unimpeded access to surgical site in minimally invasive valve or bypass surgery, MIDCAB, V.A.T.S., transcatheter or transapical valve replacement a.o.
- protects wound edge and surrounding tissue
- usable with or without retractor
- can be used in combination with incision foil
- reduces risk of embolic fat particles on instruments, sutures and knot pushers
- improves visibility and exposure
- self-holding, for incisions from 60-90 mm (regular size) 50-80 mm (medium size) and from 30-50 mm (small size)
- very easy to insert in situ
- high flexibility
- latex-free silicone rubber

29-1399	regular size	120x100 mm
29-1399M	medium size	100x100 mm
29-1399S	small size	70x70 mm

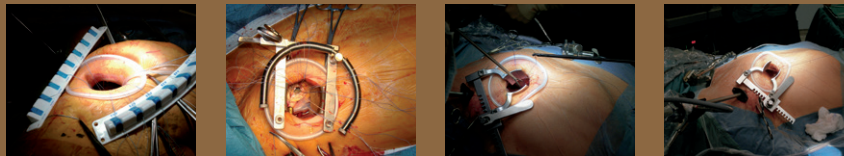

For easy placement simply push the flexible ring downwards as illustrated and insert it into the wound cavity. Then push the reversed portion carefully down as well and expand it. Remove it in the opposite way by inserting some fingers, grabbing a part of the flexible ring, and pulling it out carefully. Dispose after use.





GEISTER Medizintechnik GmbH

Föhrenstrasse 2 | D-78532 Tuttlingen | Germany

☎ +49 7461 / 966240 | ☎ +49 7461 / 9662422

www.geister.com | info@geister.com