



ELECTRONIC COMPONENTS PRODUCT GUIDE 2019



01256 397770
www.tdigroup.co.uk

Introduction

Introduction

We specialise in electro-mechanical products such as Connectors, Mains Powercords, Switches, Cables and Hardware. We offer a broad range of products including premium quality components from World Class manufacturers right through to low cost products from carefully selected Far Eastern partners. This range of products has enabled us to successfully service many different sectors of the electronics industry.

All our products have been carefully selected in response to our customer requests and the range reflects our objective to fulfil your requirements. This has been the key to our success over the past 30 years, working with our customers and offering an efficient and personal service.

You can order whichever way is easiest for you...

By Phone

01256 397770

By Fax

01256 398880

By Email

info@tdigroup.co.uk

By Post

TDI Tremiver Ltd
West Farm
Popham
Winchester
Hampshire
SO21 3BH
UK

Shipping

We normally ship by next day courier service, if you need a timed delivery please contact us for prices.

Carriage cost is £ 7.50 per carton (upto 25KG) for most UK mainland addresses. Subsequent cartons are £3.95. For larger consignments and palletised shipments please contact us for current pricing.

Payment

We accept payment by cheque, BACS, credit card (MasterCard or Visa) or debit cards (Switch or Maestro). To open a 30 day account please contact us for an applications form.

Prices

All prices are in £ sterling and exclude VAT.

Batteries & Holders	4
Connectors Audio & Video - Jacks	6
Connectors Audio & Video - Phonos	10
Connectors Audio & Video - Mini Dins	12
Connectors Audio & Video - Tini QG	13
Connectors Audio & Video - XLR	17
Connectors Audio & Video - Speaker Plates	21
Connectors Audio & Video - Speakon	22
Connectors Mains & Power - Mains Leads	23
Connectors Mains & Power - IEC Lock	28
Connectors Mains & Power - Mains Connectors	30
Connectors Mains & Power - Powercon	33
Connectors Mains & Power - DC Connectors	36
Connectors Multipole - IDC	41
Connectors Multipole - D & HDD	44
Connectors Multipole - Telecom	46
Connectors Multipole - USB / Firewire	47
Connectors Multipole - Harsh Environment	48
Connectors RF	62
Fuses & Protection	66
Potentiometers	70
Power Supplies	71
Switches	73

Batteries & Holders



Zinc Chloride Batteries

BT-1030
AA Zinc Chloride Battery

BT-1040
AAA Zinc Chloride Battery

BT-1050
PP3 9V Zinc Chloride Battery



Procell (Duracell) Alkaline Batteries

BT-3130
AA 1.5V Procell Alkaline Battery (Pack of 10)

BT-3140
AAA 1.5V Procell Alkaline Battery (Pack of 10)

BT-3150
PP3 9V Procell Alkaline Battery (Pack of 10)



Lithium Coin Cell Batteries

BT-4020
CR2016 3V Coin Cell Battery

BT-4030
CR2025 3V Coin Cell Battery

BT-4040
CR2032 3V Coin Cell Battery

Coin Cell Holders Available - Please Contact Us



Battery Holders

BT-5010
1 x AA Holder Flying Lead Connection

BT-6010
1 x AA Holder Press Stud Fixing

BT-7010
1 x AA Holder PCB Pins



BT-5020
2 x AA Holder Flying Lead Connection

BT-6020
2 x AA Holder Press Stud Fixing



BT-5040
4 x AA Holder Flying Lead Connection

BT-6040
4 x AA Holder Press Stud Fixing

BT-5050

4 x AA Square Holder Flying Lead Connection

BT-6050

4 x AA Square Holder Press Stud Fixing

**BT-5060**

6 x AA Holder Flying Lead Connection

BT-6060

6 x AA Holder Press Stud Fixing

**BT-5070**

1 x AAA Holder Flying Lead Connection

BT-6070

1 x AAA Holder Press Stud Fixing

BT-7070

1 x AAA Holder PCB Pins

**BT-5080**

2 x AAA Holder Flying Lead Connection

BT-6080

2 x AAA Holder Press Stud Fixing

BT-7080

2 x AAA Holder PCB Pins

**BT-5005**

1 x N Cell Holder Flying Lead Connection

**BT-6000**

PP3 Battery Snaps 150mm Leads



Custom Battery Holders Available - Please Contact Us

Connectors Audio & Video - Jacks



JS-252A

2.5mm Mono Jack Socket PCB Mount



JS-355A

3.5mm Stereo Jack Socket PCB Mount with Threaded Bush

JS-355B

3.5mm Stereo Jack Socket PCB Mount with Plain Bush



JS-3570

3.5mm Stereo Jack Socket PCB Mount



JS-3560

Jalco 3.5mm Jack Socket R/A Stereo Unswitched

Switchcraft®
GONXALL®



JS-3592

3.5mm Dual Stereo Jack Socket Unscreened
Switchcraft 35RAPC7J

JS-3594

3.5mm Dual Stereo Jack Socket Screened
Switchcraft 35RAPC7JS



JS-3554

3.5mm Mono Jack Socket Vertical PCB Mount
Switchcraft 35RAPC2AV

Connectors Audio & Video - Jacks

Switchcraft
CONXALL

JS-3559

3.5mm Stereo Jack Socket Vertical PCB Mount Switchcraft 35RAPC2BV4

JS-3563

3.5mm Stereo Jack Socket Vertical PCB Mount Switchcraft 35RAPC3BV4

JS-3551

3.5mm Stereo Jack Socket Vertical PCB Mount Switchcraft 35RAPC4BV4



JS-3558

3.5mm Mono Jack Socket Horizontal PCB Mount Switchcraft 35RAPC2AH3

JS-3562

3.5mm Stereo Jack Socket Horizontal PCB Mount Switchcraft 35RAPC3BH3

JS-3549

3.5mm Stereo Jack Socket Horizontal PCB Mount Switchcraft 35RAPC4BH3



Switchcraft Heavy Duty 3.5mm Stereo Plug with Locking Ring to secure any M6 threaded socket.

JP-3600

3.5mm Plug Nickel/Tin 0.25 Inch
Switchcraft 35HDLNN

JP-3605

3.5mm Plug Black/Tin 0.25 Inch
Switchcraft 35HDLBN

JP-3610

3.5mm Plug Nickel/Gold 0.25 Inch
Switchcraft 35HDLNAU

JP-3615

3.5mm Plug Black/Gold 0.25 Inch
Switchcraft 35HDLBAU

JP-3620

3.5mm Plug Nickel/Tin 0.175 Inch
Switchcraft 35HDLNNS

JP-3625

3.5mm Plug Black/Tin 0.175 Inch
Switchcraft 35HDLBNS

JP-3630

3.5mm Plug Nickel/Gold 0.175 Inch
Switchcraft 35HDLNAUS

JP-3635

3.5mm Plug Black/Gold 0.175 Inch
Switchcraft 35HDLBAUS



Switchcraft Heavy Duty 3.5mm stereo inline socket with silver or gold contacts.

JLS-1000

3.5mm Stereo Inline Socket Silver
Upto 0.29 Inch Cable
Switchcraft 35LJN

JLS-1005

3.5mm Stereo Inline Socket Gold
Upto 0.29 Inch Cable
Switchcraft 35LJNAU

JLS-1010

3.5mm Stereo Inline Socket Silver
Upto 0.175 Inch Cable
Switchcraft 35LJBNS

JLS-1015

3.5mm Stereo Inline Socket Gold
Upto 0.175 Inch Cable
Switchcraft 35LJNAUS



Connectors Audio & Video - Jacks

Switchcraft®
GONXALL®



Switchcraft 4.4mm Unijax socket

JS-4442

4.4mm 3 Pole Socket Unijax Unswitched
Switchcraft UJ2B

JS-4444

4.4mm 3 Pole Socket Unijax Switched
Switchcraft UJ4B



Switchcraft Open Frame 6.4mm Jack Sockets

JS-6479

6.4mm Mono Socket Unswitched
Switchcraft 11

JS-6483

6.4mm Mono Socket Unswitched Long Bush
Switchcraft L11

JS-6488

6.4mm Mono Socket Isolated Make Circuit
Switchcraft 13

JS-6484

6.4mm Stereo Socket Open Circuit
Switchcraft 12B

JS-6485

6.4mm Stereo Socket Open Circuit Long Bush
Switchcraft L12B



Switchcraft Enclosed Hi-D Jack 6.4mm Jack Sockets with PCB terminals for vertical mounting

JS-6470

6.4mm Mono Socket Open Circuit Insulated Bush
Switchcraft 112APCX

JS-6472

6.4mm Mono Socket Open Circuit Long Bush
Switchcraft N112APCX

JS-6487

6.4mm Stereo Open Circuit
Switchcraft 112BPCX

JS-64725

6.4mm Stereo Open Circuit Insulated Bush
Switchcraft N112BPCX

Connectors Audio & Video - Jacks

Switchcraft 6.4mm Socket with end pins and long threaded bushes for musical instruments

JS-6478

6.4mm Mono Socket Long Thread
Switchcraft 151

JS-6477

6.4mm Stereo Socket Long Thread
Switchcraft 152B



JS-6455

6.4mm Stereo Jack Socket PCB Socket Narrow Style



JS-6677

6.4mm Stereo Jack Socket PCB Mount with Switched Contacts



Switchcraft 6.4mm Heavy Duty Screened Jack Plugs

JP-6420

6.4mm Mono Plug
Switchcraft 280

JP-6425

6.4mm Stereo Plug
Switchcraft 297

JP-6490

6.4mm Mono Right Angle Plug
Switchcraft 226

JP-6495

6.4mm Stereo Right Angle Plug
Switchcraft 236



JP-6402

6.4mm Mono Jack Plug Professional
ff NP2C

JP-6403

6.4mm Stereo Jack Plug Professional
Neutrik NP3C

NEUTRIK



Connectors Audio & Video - Phonos



Professional Gold Phono Socket chassis mounting

PS-6410

Professional Gold Phono Socket Black

PS-6420

Professional Gold Phono Socket White

PS-6430

Professional Gold Phono Socket Red

PS-6440

Professional Gold Phono Socket Blue

PS-6450

Professional Gold Phono Socket Green

PS-6470

Professional Gold Phono Socket Yellow



Professional Gold Phono Socket PCB mounting

PS-9010

Professional Gold Phono Socket Right Angle PCB Black

PS-9030

Professional Gold Phono Socket Right Angle PCB Red

PS-9110

Professional Gold Phono Socket Vertical PCB Black

PS-9130

Professional Gold Phono Socket Vertical PCB Red



PS-0715

Single Gold Phono Socket Right Angle PCB Black



Jalco Professional Multiple Phono Sockets

PS-3729

Jalco 14x14 range Dual Right Angle PCB Mount Phono Socket Black with Gold Plated Earth Contacts

PS-3284

Jalco 14x14 range Quad Right Angle PCB Mount Phono Socket Black with Gold Plated Earth Contacts

Connectors Audio & Video - Phonos

PS-2200

14x18 Range Dual Right Angle Phono Socket Black Nickel

PS-2205

14x18 Range Dual Right Angle Phono Socket Black Gold



PS-4405

14x18 Range Quad Right Angle Phono Socket Black Gold



PS-2830

Dual Horizontal Right Angle Phono Socket Red/White Nickel



PS-2930

High Stand Off Vertical Phono Socket Red/White Nickel

PS-2935

High Stand Off Vertical Phono Socket Red/White Gold



Connectors Audio & Video - Mini Dins



Right Angle PCB Mount Mini Din Socket with Fully Screened Body

MD-2230

3 Pole Screened Mini Din Socket

MD-2240

4 Pole Screened Mini Din Socket

MD-2250

5 Pole Screened Mini Din Socket

MD-2260

6 Pole Screened Mini Din Socket

MD-2270

7 Pole Screened Mini Din Socket

MD-2280

8 Pole Screened Mini Din Socket

MD-2290

9 Pole Screened Mini Din Socket



Right Angle PCB Mount Power Mini Din Sockets

MD-2530

3 Pole Power Mini Din Socket

MD-2540

4 Pole Power Mini Din Socket



Rewireable Power Mini Din Plugs

MD-5530

3 Pole Power Mini Din Plugs

MD-5540

4 Pole Power Mini Din Plugs

Switchcraft Tini-QG Mini XLR PCB Mount Male Chassis Plug

MX-1530

3 Pole Male R/A PCB Switchcraft TRA3M

MX-1560

6 Pole Male R/A PCB Switchcraft TRA6M

Switchcraft Tini-QG Mini XLR Male Cable Plug

MX-1130

3 Pole Male Cable Plug Switchcraft TA3MX

MX-1140

4 Pole Male Cable Plug Switchcraft TA4MX

MX-1150

5 Pole Male Cable Plug Switchcraft TA5MX

MX-1160

6 Pole Male Cable Plug Switchcraft TA6MLX



Switchcraft Tini-QG Mini XLR Female Cable Socket

MX-1230

3 Pole Female Cable Socket Switchcraft TA3FX

MX-1240

4 Pole Female Cable Socket Switchcraft TA4FX

MX-1250

5 Pole Female Cable Socket Switchcraft TA5FX

MX-1260

6 Pole Female Cable Socket Switchcraft TA6FLX



Switchcraft Tini-QG Mini XLR Male Chassis Mount Plug

MX-1330

3 Pole Male Chassis Plug Switchcraft TB3M

MX-1340

4 Pole Male Chassis Plug Switchcraft TB4M

MX-1350

5 Pole Male Chassis Plug Switchcraft TB5M

MX-1360

6 Pole Male Chassis Plug Switchcraft TB6M



Switchcraft Tini-QG Mini XLR Female Chassis Mount Socket

MX-1430

3 Pole Female Chassis Socket Switchcraft TY3F

MX-1440

4 Pole Female Chassis Socket Switchcraft TY4F

MX-1450

5 Pole Female Chassis Socket Switchcraft TY5F



Connectors Audio & Video - Tini QG

Switchcraft[®]
CONXALL[®]



Switchcraft Tini-QG Mini XLR Shielded Male Cable Plug

MX-3030

3 Pole Male Cable Plug Shielded Switchcraft TA3MSHF

MX-3040

4 Pole Male Cable Plug Shielded Switchcraft TA4MSHF

MX-3050

5 Pole Male Cable Plug Shielded Switchcraft TA5MSHF

MX-3060

6 Pole Male Cable Plug Shielded Switchcraft TA6MSHF

MX-3070

7 Pole Male Cable Plug Shielded Switchcraft TA7MSHF

MX-3080

8 Pole Male Cable Plug Shielded Switchcraft TA8MSHF



Switchcraft Tini-QG Mini XLR Shielded Female Cable Socket

MX-3130

3 Pole Female Cable Socket Shielded Switchcraft TA3FSHF

MX-3140

4 Pole Female Cable Socket Shielded Switchcraft TA4FSHF

MX-3150

5 Pole Female Cable Socket Shielded Switchcraft TA5FSHF

MX-3160

6 Pole Female Cable Socket Shielded Switchcraft TA6FSHF

MX-3170

7 Pole Female Cable Socket Shielded Switchcraft TA7FSHF

MX-3180

8 Pole Female Cable Socket Shielded Switchcraft TA8FSHF



Switchcraft Tini-QG IP50 Dust Caps

MX-1000

Dust Cap for Tini-QG Connectors Switchcraft TINICAP

MX-1005

Dust Cap for Tini-QG Chassis Male TB Series Switchcraft TINICAPTB

Switchcraft Tini-QG Mini XLR Unified EH Female Chassis Socket

MX-5030

3 Pole Female Unified Nickel Switchcraft EHT3F

MX-5040

4 Pole Female Unified Nickel Switchcraft EHT4F

MX-5050

5 Pole Female Unified Nickel Switchcraft EHT5F

MX-5130

3 Pole Female Unified Black Switchcraft EHT3FB

MX-5140

4 Pole Female Unified Black Switchcraft EHT4FB

MX-5150

5 Pole Female Unified Black Switchcraft EHT5FB



Switchcraft Tini-QG Mini XLR Unified EH Male Chassis Plug

MX-4030

3 Pole Male Unified Nickel Switchcraft EHT3M

MX-4040

4 Pole Male Unified Nickel Switchcraft EHT4M

MX-4050

5 Pole Male Unified Nickel Switchcraft EHT5M

MX-4060

6 Pole Male Unified Nickel Switchcraft EHT6M

MX-4070

7 Pole Male Unified Nickel Switchcraft EHT7M

MX-4080

8 Pole Male Unified Nickel Switchcraft EHT8M

MX-4130

3 Pole Male Unified Black Switchcraft EHT3MB

MX-4140

4 Pole Male Unified Black Switchcraft EHT4MB

MX-4150

5 Pole Male Unified Black Switchcraft EHT5MB

MX-4160

6 Pole Male Unified Black Switchcraft EHT6MB

MX-4170

7 Pole Male Unified Black Switchcraft EHT7MB

MX-4180

8 Pole Male Unified Black Switchcraft EHT8MB



Connectors Audio & Video - Tini QG

Switchcraft[®]
CONXALL[®]



Switchcraft IP65/IP66 Sealed Tini-QG Mini XLR Male Cable Plug

MX-6130

3 Pole Male Cable Plug Switchcraft TA3MS

MX-6140

4 Pole Male Cable Plug Switchcraft TA4MS

MX-6150

5 Pole Male Cable Plug Switchcraft TA5MS

MX-6160

6 Pole Male Cable Plug Switchcraft TA6MS

MX-6170

7 Pole Male Cable Plug Switchcraft TA7MS

MX-6180

8 Pole Male Cable Plug Switchcraft TA8MS



Switchcraft IP65/IP66 Sealed Tini-QG Mini XLR Female Cable Socket

MX-6230

3 Pole Female Cable Socket Switchcraft TA3FS

MX-6240

4 Pole Female Cable Socket Switchcraft TA4FS

MX-6250

5 Pole Female Cable Socket Switchcraft TA5FS

MX-6260

6 Pole Female Cable Socket Switchcraft TA6FS

MX-6270

7 Pole Female Cable Socket Switchcraft TA7FS

MX-6280

8 Pole Female Cable Socket Switchcraft TA8FS



Switchcraft IP65/IP66 Sealed Tini-QG Mini XLR Male Panel Plug

MX-6330

3 Pole Male Panel Plug Switchcraft TB3MS

MX-6340

4 Pole Male Panel Plug Switchcraft TB4MS

MX-6350

5 Pole Male Panel Plug Switchcraft TB5MS

MX-6360

6 Pole Male Panel Plug Switchcraft TB6MS

MX-6370

7 Pole Male Panel Plug Switchcraft TB7MS

MX-6380

8 Pole Male Panel Plug Switchcraft TB8MS

Switchcraft Screened D Series XLR Male Chassis Plug

XL-8030

3 Pole Male Chassis Plug Switchcraft D3M

XL-8040

4 Pole Male Chassis Plug Switchcraft D4M

XL-8050

5 Pole Male Chassis Plug Switchcraft D5M



Switchcraft Screened D Series XLR Female Chassis Socket

XL-8130

3 Pole Female Chassis Socket Switchcraft D3F

XL-8140

4 Pole Female Chassis Socket Switchcraft D4F

XL-8150

5 Pole Female Chassis Socket Switchcraft D5F



Switchcraft E Series XLR Unified Housing PCB Mount Satin Finish & Silver Plated Contacts

XL-8230

3 Pole Male R/A PCB Mount
Switchcraft E3MRA

XL-8430

3 Pole Male Vertical PCB Mount
Switchcraft E3MST

XL-8330

3 Pole Female R/A PCB Mount
Switchcraft E3FRA

XL-8530

3 Pole Female Vertical PCB Mount
Switchcraft E3FST



Switchcraft E Series XLR Unified Housing PCB Mount Satin Finish & Silver Plated Contacts M3 Tapped Fixing Holes

XL-8234

3 Pole Male R/A PCB Mount M3
Switchcraft E3MRAM3

XL-8434

3 Pole Male Vertical PCB Mount M3
Switchcraft E3MSTM3

XL-8334

3 Pole Female R/A PCB Mount M3
Switchcraft E3FRAM3

XL-8534

3 Pole Female Vertical PCB Mount M3
Switchcraft E3FSTM3



Switchcraft E Series XLR Unified Housing PCB Mount Black Finish & Gold Plated Contacts

XL-8236

3 Pole Male R/A PCB Mount
Black/Gold
Switchcraft E3MRABAU

XL-8436

3 Pole Male Vertical PCB Mount
Black/Gold
Switchcraft E3MSTBAU

XL-8336

3 Pole Female R/A PCB Mount
Black/Gold
Switchcraft E3FRABAU

XL-8536

3 Pole Female Vertical PCB Mount
Black/Gold
Switchcraft E3FSTBAU



Connectors Audio & Video - XLR

Switchcraft[®]
CONXALL[®]



Switchcraft E Series XLR Unified Housing PCB Mount Black Finish & Gold Plated Contacts M3 Tapped Fixing Holes

XL-8235

3 Pole Male Right Angle PCB Mount Black/Gold M3
Switchcraft E3MRABAUM3

XL-8435

3 Pole Male Vertical PCB Mount Black/Gold M3
Switchcraft E3MSTBAUM3

XL-8335

3 Pole Female Right Angle PCB Mount Black/Gold M3
Switchcraft E3FRABAUM3

XL-8535

3 Pole Female Vertical PCB Mount Black/Gold M3
Switchcraft E3FSTBAUM3



Switchcraft DE Series XLR Unified Housing Male Rugged Metal Construction with Solder Tags

XL-2030

3 Pole Male Nickel Switchcraft DE3M

XL-2040

4 Pole Male Nickel Switchcraft DE4M

XL-2050

5 Pole Male Nickel Switchcraft DE5M

XL-2130

3 Pole Male Black Switchcraft DE3MBAU

XL-2140

4 Pole Male Black Switchcraft DE4MBAU

XL-2150

5 Pole Male Black Switchcraft DE5MBAU



Switchcraft DE Series XLR Unified Housing Female Rugged Metal Construction with Solder Tags

XL-2230

3 Pole Female Nickel Switchcraft DE3F

XL-2240

4 Pole Female Nickel Switchcraft DE4F

XL-2250

5 Pole Female Nickel Switchcraft DE5F

XL-2330

3 Pole Female Black Switchcraft DE3FBAU

XL-2340

4 Pole Female Black Switchcraft DE4FBAU

XL-2350

5 Pole Female Black Switchcraft DE5FBAU

Connectors Audio & Video - XLR

Switchcraft AAA Series Quick Twist Q-G XLR Plastic Rear Shell

XL-9630

3 Pole Male Cable Plug Plastic Shell Switchcraft AAA3MPZ

XL-9640

4 Pole Male Cable Plug Plastic Shell Switchcraft AAA4MPZ

XL-9650

5 Pole Male Cable Plug Plastic Shell Switchcraft AAA5MPZ



XL-9730

3 Pole Female Cable Socket Plastic Shell Switchcraft AAA3FPZ

XL-9740

4 Pole Female Cable Socket Plastic Shell Switchcraft AAA4FPZ

XL-9750

5 Pole Female Cable Socket Plastic Shell Switchcraft AAA5FPZ



Switchcraft AAA Series Quick Twist Q-G XLR Metal Rear Shell

XL-9632

3 Pole Male Cable Plug Metal Shell Switchcraft AAA3M

XL-9642

4 Pole Male Cable Plug Metal Shell Switchcraft AAA4M

XL-9652

5 Pole Male Cable Plug Metal Shell Switchcraft AAA5M



XL-9732

3 Pole Female Cable Socket Metal Shell Switchcraft AAA3F

XL-9742

4 Pole Female Cable Socket Metal Shell Switchcraft AAA4F

XL-9752

5 Pole Female Cable Socket Metal Shell Switchcraft AAA5F



Switchcraft's industry standard AAA series XLR, Tini QG Mini XLR and DE Series Panel Mount XLR are now available in white.

Ideal for application where the connectors need to be unobtrusive such as stage and architectural lighting and for convenient colour coding in studios or on stage.



Connectors Audio & Video - XLR

NEUTRIK

Neutrik A Series Plastic Body XLR Connector



XL-4130

3 Pole Male XLR Right Angle PCB Mount Neutrik NC3MAH



XL-4330

3 Pole Male XLR Vertical PCB Mount Neutrik NC3MAV



XL-4230

3 Pole Female XLR Right Angle PCB Mount Neutrik NC3FAH



XL-4430

3 Pole Female XLR Vertical PCB Mount Neutrik NC3FAV

Neutrik XX Series XLR Cable Connectors



NC3MXX

3 Pole Male Cable Plug Nickel Neutrik

NC3MXX-B

3 Pole Male Cable Plug Black with Gold Contacts Neutrik

NC3MXX-14

3 Pole Male Cable Plug Nickel Large Cable Entry Neutrik

NC4MXX

4 Pole Male Cable Plug Nickel Neutrik

NC5MXX

5 Pole Male Cable Plug Nickel Neutrik



NC3FXX

3 Pole Female Cable Plug Nickel Neutrik

NC3FXX-B

3 Pole Female Cable Plug Black with Gold Contacts Neutrik

NC3FXX-14

3 Pole Female Cable Plug Nickel Large Cable Entry Neutrik

NC4FXX

4 Pole Female Cable Plug Nickel Neutrik

NC5FXX

5 Pole Female Cable Plug Nickel Neutrik



XXR-2

Red Back Shell for XLR Line Plugs & Sockets

Other variants are also available - please contact the Sales Team with your requirements

Connectors Audio & Video - Speaker Plates

Chassis Mounted Speaker Plates

TP-7935

2 Way Speaker Terminal Plate with Gold Plated Terminals
Round Screw Fixing 105mm Diameter



TP-8635

2 Way Speaker Terminal Plate with Gold Plated Terminals
Rectangular Screw Fixing 93 x 79mm



TP-8835G

4 Way Speaker Terminal Plate with Gold Plated Terminals
Rectangular Screw Fixing 120 x 93mm with Gasket



NEUTRIK

Neutrik Speakon Connectors



NE-4000

4 Pole Speakon Chassis Connector 3/16 Flat Tabs
Neutrik NL4MP



NE-4005

4 Pole Speakon Chassis Connector Screw Terminal
Neutrik NL4MP-ST



NE-4200

4 Pole Speakon Cable Connector
Neutrik NL4FX



NE-4300

4 Pole Speakon Right Angle Cable Connector
Neutrik NL4FRX

Connectors Mains & Power - Mains Leads

UK Mains Leads

MC-5580

UK Plug Fused 3 Amp to Straight C7 Figure-8 Connector
2 core x 0.75mm H03VVH2-F Black PVC Cable 2 Metres



MC-5590

UK Plug Fused 5 Amp to Straight C5 Clover Leaf Connector
3 Core x 0.75mm H03VV-F Black PVC Cable 2 Metres



MC-5520

UK Plug Fused 5 Amp to Straight C13 Cold Condition 10 Amp Female IEC
3 core x 0.75mm H05VV-F Black PVC Cable 2 Metres



MC-5560

UK Plug Fused 5 Amp to Straight C13 Cold Condition 10 Amp Female IEC
3 Core x 1mm H05VV-F Black PVC Cable 3 Metres

MC-5524

UK Plug Fused 10 Amp to Straight C13 Cold Condition 10 Amp Female IEC
3 Core x 1mm H05VV-F Black PVC Cable 2 Metres

MC-5500

UK Plug Fused 5 Amp To Stripped End
3 Core x 0.75mm H05VV-F Black PVC Cable 2 Metres



MC-5102

UK Plug Fused 13 Amp to Stripped End
3 Core x 1.5mm H05VV-F Black PVC Cable 2 Metres

MC-5106

UK Plug Fused 13 Amp to Stripped End
3 Core x 1.5mm H05VV-F Black PVC Cable 3 Metres

MC-5535

UK Plug Fused 5 Amp to Right Angle C13 Cold Condition 10 Amp Female IEC
3 Core x 0.75mm H05VV-F Black PVC Cable 2 Metres



MC-5227

UK Plug Fused 13 Amp Y Junction to
2 x Straight C13 Cold Condition 10 Amp Female IEC
3 core x 1mm H05VV-F Black PVC Cable 2 Metres



Connectors Mains & Power - Mains Leads



MC-5625

UK plug Fused 13 Amp to Straight C19 Cold Condition 16 Amp Female IEC
3 core x 1.5mm H05VV-F Black PVC Cable 2.5 Metres



European Mains Leads

MC-4088

2 Pin Flat Euro Plug to Straight C7 Figure-8 Connector
2 Core x 0.75mm Black PVC Cable 2 Metres



MC-3295

Right Angle Schuko to Straight C5 Clover Leaf Connector
3 Core x 0.75mm Black PVC Cable 2 Metres



MC-3120

Right Angle Schuko to Straight C13 Cold Condition Female IEC
3 Core x 0.75mm Black PVC Cable 2 Metres

MC-3160

Right Angle Schuko to Straight C13 Cold Condition Female IEC
3 Core x 1mm Black PVC Cable 3 Metres



MC-3000

Right Angle Schuko to Stripped End
3 Core x 0.75mm Black PVC Cable 2 Metres



MC-3619

Right Angle Schuko to Straight C19 Cold Condition 16 Amp Female IEC
3 Core x 1.5mm Black PVC Cable 2.5 Metres

Connectors Mains & Power - Mains Leads

Danish Mains Leads

MC-3520

Danish 3 Pin Plug to Straight C5 Clover Leaf Connector
3 Core x 1mm Black PVC Cable 2 Metres

MC-3525

Danish 3 Pin Plug to Straight C13 Cold Condition Female IEC
3 Core x 1mm Black PVC Cable 2 Metres



Italian Mains Leads

MC-9590

Italian 3 Pin Plug to Straight C5 Clover Leaf Connector
3 Core x 0.75mm Black PVC Cable 2 Metres

MC-9525

Italian 3 Pin Plug to Straight C13 Cold Condition Female IEC
3 Core x 0.75mm Black PVC Cable 2 Metres



Swiss Mains Leads

MC-8590

Swiss 3 Pin Plug to Straight C5 Clover Leaf Connector
3 Core x 0.75mm Black PVC Cable 2 Metres

MC-8520

Swiss 3 Pin Plug to Straight C13 Cold Condition Female IEC
3 Core x 0.75mm Black PVC Cable 2 Metres



USA Mains Leads

MC-2088

USA 3 Pin NEMA 1-15P to Straight C7 Figure-8 Connector
2 Core x 18 AWG Black SPT-2 PVC Cable 2 Metres



MC-1190

USA 3 Pin NEMA 5-15P to Straight C5 Clover Leaf Connector
3 Core x 18 AWG Black SVT PVC Cable 2 Metres



MC-1120

USA 3 Pin NEMA 5-15P to Straight C13 Cold Condition Female IEC
3 Core x 18 AWG Black SVT PVC Cable 2 Metres

MC-1035

USA 3 Pin NEMA 5-15P to Straight C13 Cold Condition Female IEC
3 Core x 16 AWG Black SJT PVC Cable 2 Metres

MC-1170

USA 3 Pin NEMA 5-15P to Straight C13 Cold Condition Female IEC
3 Core x 18 AWG Black SVT PVC Cable 3 Metres



Connectors Mains & Power - Mains Leads



MC-1000

USA 3 Pin NEMA 5-15P to Stripped End
3 Core x 18 AWG Black SVT PVC Cable 2 Metres



MC-1175

USA 3 Pin NEMA 5-15P to Straight C19 Cold Condition Female IEC
3 Core x 14 AWG Black SJT PVC Cable 2.5 Metres



Australian Mains Leads

MC-4580

Australian 2 Pin Plug to Straight C7 Figure-8 Connector
2 Core x 0.75mm Black PVC Cable 2 Metres

MC-9010

Australian 3 Pin Plug to Straight C5 Clover Leaf Connector
3 Core x 0.75mm Black PVC Cable 2 Metres



MC-9020

Australian 3 Pin Plug to Straight C13 Cold Condition Female IEC
3 Core x 0.75mm Black PVC Cable 2 Metres



South African / Indian Mains Leads

MC-7580

South African/Indian 3 Pin 15 Amp Plug to Straight C7 Figure-8 Connector
2 Core x 0.75mm Black PVC Cable 2 Metres

MC-7625

South African/Indian 3 Pin 15 Amp Plug to Straight C13 Cold Condition Female IEC
3 Core x 1mm Black PVC Cable 2.5 Metres

Connectors Mains & Power - Mains Leads

IEC Mains Leads

MC-7000

Straight C14 Male Shrouded IEC to Stripped End
3 Core x 0.75mm Black PVC Cable 2 Metres



MC-0026

Straight C13 Cold Condition Female IEC to Stripped End
3 Core x 0.75mm Black PVC Cable 2 Metres



MC-0126

Right Angle C13 Cold Condition Female IEC to Bare End
3 Core x 0.75mm Black PVC Cable 2 Metres

MC-0130

Straight C13 Cold Condition Female IEC to Stripped End
3 Core x 1mm Black PVC Cable 3 Metres



MC-7410

Straight C14 Male Shrouded IEC to Straight C13 Cold Condition Female IEC
3 Core x 0.75mm Black PVC Cable 1 Metre

MC-7420

Straight C14 Male Shrouded IEC to Straight C13 Cold Condition Female IEC
3 Core x 0.75mm Black PVC Cable 2 Metres

MC-7021

Straight C14 Male Shrouded IEC to Straight C13 Cold Condition Female IEC
3 Core x 1mm Black PVC Cable 2 Metres

MC-7430

Straight C14 Male Shrouded IEC to Straight C13 Cold Condition Female IEC
3 Core x 1mm Black PVC Cable 3 Metres

MC-7450

Straight C14 Male Shrouded IEC to Straight C13 Cold Condition Female IEC
3 Core x 1mm Black PVC Cable 5 Metres

MC-7125

Straight C20 Male Shrouded IEC to Straight C19 Cold Condition Female IEC
3 Core x 1.5mm Black PVC Cable 2.5 Metres



Other Mains Leads

MC-0085

Straight C7 Figure-8 Connector to Stripped End
2 Core x 0.75mm Black PVC Cable 2 Metres

MC-0092

Straight C5 Clover Leaf Connector to Stripped End
3 Core x 0.75mm Black PVC Cable 2 Metres



Connectors Mains & Power - IEC Lock

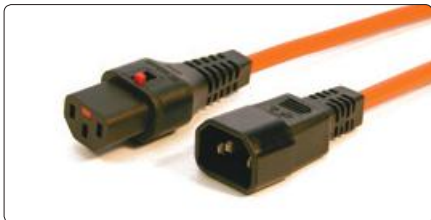

IEC Lock Mains Cables

Unique Lockable Female C13 & C19 IEC Connectors and Outlets. The IEC Lock range can be used with any standard IEC inlets & Guards against accidental disconnection of Computers, PDU's, Servers & most Network Devices.

MC-0075

Straight C13 IEC Lock Female to Bare End
3 Core x 1mm Black PVC Cable 2 Metre

MC-0230

Straight C13 IEC Lock Female to Bare End
3 Core x 1mm Black PVC Cable 3 Metres

MC-0240

Straight C13 IEC Lock Female to Bare End
3 Core x 1mm Black PVC Cable 4 Metres

MC-7310

Straight C14 Male Shrouded IEC to Straight C13 IEC Lock Female
3 Core x 1mm Orange PVC Cable 1 Metre

MC-7320

Straight C14 Male Shrouded IEC to Straight C13 IEC Lock Female
3 Core x 1mm Orange PVC Cable 2 Metres

MC-7330

Straight C14 Male Shrouded IEC to Straight C13 IEC Lock Female
3 Core x 1mm Orange PVC Cable 3 Metres

MC-7340

Straight C14 Male Shrouded IEC to Straight C13 IEC Lock Female
3 Core x 1mm Orange PVC Cable 4 Metres

MC-7312

Straight C14 Male Shrouded IEC to Straight C13 IEC Lock Female
3 Core x 1mm Black PVC Cable 1 Metre

MC-7322

Straight C14 Male Shrouded IEC to Straight C13 IEC Lock Female
3 Core x 1mm Black PVC Cable 2 Metres

MC-7332

Straight C14 Male Shrouded IEC to Straight C13 IEC Lock Female
3 Core x 1mm Black PVC Cable 3 Metres

MC-7315

Straight C14 Male Shrouded IEC to Straight C13 IEC Lock Female
3 Core x 1mm White PVC Cable 1 Metre

MC-7325

Straight C14 Male Shrouded IEC to Straight C13 IEC Lock Female
3 Core x 1mm White PVC Cable 2 Metres

MC-7335

Straight C14 Male Shrouded IEC to Straight C13 IEC Lock Female
3 Core x 1mm White PVC Cable 3 Metres

Connectors Mains & Power - IEC Lock

MC-5375

UK Plug Fused 5 Amp to Straight C13 IEC Lock Female
3 Core x 1mm H05VV-F Black PVC Cable 2 Metres

MC-5385

UK Plug Fused 5 Amp to Straight C13 IEC Lock Female
3 Core x 1mm H05VV-F Black PVC Cable 3 Metres

MC-5620

UK Plug Fused 5 Amp to Straight C19 IEC Lock Female
3 Core x 1.5mm H05VV-F Black PVC Cable 2 Metres



MC-3820

Right Angle Schuko to Straight C13 IEC Lock Female
3 Core x 1mm H05VV-F Black PVC Cable 2 Metres

MC-3830

Right Angle Schuko to Straight C13 IEC Lock Female
3 Core x 1mm H05VV-F Black PVC Cable 3 Metres

MC-3625

Right Angle Schuko to Straight C19 IEC Lock Female
3 Core x 1.5mm H05VV-F Black PVC Cable 2 Metres



MC-1320

USA 3 Pin NEMA 5-15P to Straight C13 IEC Lock Female
3 Core x 18 AWG Black SVT PVC Cable 2 Metres



MC-7910

Straight C20 Male Shrouded IEC to Straight C19 IEC Lock Female
3 Core x 1.5mm Black PVC Cable 1 Metre

MC-7920

Straight C20 Male Shrouded IEC to Straight C19 IEC Lock Female
3 Core x 1.5mm Black PVC Cable 2 Metres

MC-7930

Straight C20 Male Shrouded IEC to Straight C19 IEC Lock Female
3 Core x 1.5mm Black PVC Cable 3 Metres

CM-7830

Re-wireable C13 IEC Lock Female Cable Socket



Connectors Mains & Power - Mains Connectors

**CM-0207**

Re-wireable Straight C13 Female Cold Condition IEC Black

CM-0237

Re-wireable Straight C14 Male Shrouded IEC Black

CM-0257

Re-wireable Right Angle C13 Female Cold Condition IEC Black

CM-0258

Re-wireable Right Angle C14 Male Shrouded IEC Black

**CM-9030**

Re-wireable Straight C19 Female Cold Condition IEC Black

CM-9040

Re-wireable Straight C20 Male Shrouded IEC Black

**CM-0348**

IEC Chassis Plug Screw Fix with 4.8mm Blade Terminals Black

CM-0363

IEC Chassis Plug Screw Fix with 6.3mm Blade Terminals Black

**CM-4048**

IEC Chassis Plug Snap Fit with 4.8mm Blade Terminals
Variable Panel Thickness (0.8mm to 2.0mm) Black

CM-4063

IEC Chassis Plug Snap Fit with 6.3mm Blade Terminals
Variable Panel Thickness (0.8mm to 2.0mm) Black

**CM-3300**

IEC Plug PCB Mount 7mm Pitch Black

**CM-3648**

IEC Chassis Plug with Fuseholder Screw Fix with 4.8mm Terminals Black

**CM-3748**

IEC Chassis Plug with Fuseholder Snap Fit with 4.8mm Terminals Black

CM-3963

IEC Chassis Plug with Fuseholder Snap Fit with 6.3mm Terminals Black

Connectors Mains & Power - Mains Connectors

CM-3148

IEC Chassis Socket Screw Fix with 4.8mm Blade Terminals Black

CM-3363

IEC Chassis Socket Screw Fix with 6.3mm Blade Terminals Black



CM-4248

IEC Chassis Socket Snap Fit with 4.8mm Blade Terminals Black

CM-4163

IEC Chassis Socket Snap Fit with 6.3mm Blade Terminals Black



MF-2000

IEC Snap Fit Filtered IEC Inlet Black



MF-3000

IEC with Fuseholder Screw Fix Filtered IEC Inlet Black



CM-2005

Figure-8 Chassis Plug Screw Fix with Solder Tags Black

CM-2035

Figure-8 Chassis Plug Snap Fit with Solder Tags Black



CM-3830

C5 Inlet PCB Mounting Black



Multiple IEC socket arrays are available - please contact us



Connectors Mains & Power - Mains Connectors



CM-9010

IEC Chassis Plug Screw Fix with 6.3mm Tabs Black

CM-9020

IEC Chassis Socket Screw Fix with 6.3mm Tabs Black



Re-wireable UK Plug

CM-6503

3 Pin Plug Fused 3 Amp Black

CM-6603

3 Pin Plug Fused 3 Amp White

CM-6505

3 Pin Plug Fused 5 Amp Black

CM-6605

3 Pin Plug Fused 5 Amp White

CM-6513

3 pin Plug Fused 13 Amp Black

CM-6613

3 pin Plug Fused 13 Amp White



CM-7000

Re-wireable Straight European Schuko Plug Black

CM-7020

Re-wireable Straight European Schuko Plug White



CM-7200

Re-wireable Straight 2.5 Amp 2 Pin Flat European Plug Black



CM-8000

Re-wireable Straight USA 3 Pin NEMA 5-15P Plug Black/White



CM-9000

Re-wireable Australian 3 Pin Plug Black

CM-9002

Re-wireable Australian 3 Pin Plug White

NEUTRIK

NE-1000

Powercon 16A Chassis Mount Outlet Screw Terminals
Neutrik NAC3FPX-ST



NE-1005

Powercon 16A Chassis Mount Outlet 1/4 Flat Tab Terminals
Neutrik NAC3FPX



NE-1010

Powercon 16A Chassis Mount Inlet 1/4 Flat Tab Terminals
Neutrik NAC3MPX



NE-1015

Powercon 16A Inlet / Outlet Combination 1/4 Flat Tab Terminals
Neutrik NAC3PX



NE-1020

Powercon 16A Locking Male Power Out Cable Connector Screw Terminals
Neutrik NAC3MX



NE-1025

Powercon 16A Locking Female Power In Cable Connector Screw Terminals
Neutrik NAC3FX



Connectors Mains & Power - Powercon



NE-2000

Lockable Cable Connector Power In Screw Terminals Blue
Neutrik NAC3FCA



NE-2500

Chassis Connector Power In 3/16 Flat Tab Terminals Blue
Neutrik NAC3MPA-1



NE-2100

Lockable Cable Connector Power Out Screw Terminals Grey
Neutrik NAC3FCB



NE-2200

32A Powercon Cable Connector Power Out
Neutrik NAC3FC-HC



NE-2300

32A Powercon Chassis Connector Power In
Neutrik NAC3MP-HC



EH-1015

Hinged Cover for all Unified (Neutrik D Size) Chassis Connectors
Neutrik SCDX



EH-1020

Dust protection cover for most Speakon and powerCON chassis connectors
Neutrik SCL



EH-1025

The SCDP-* sealing gasket provides a dust and water resistant assembly for all D-shape chassis connectors to front panels. Black Standard, but also available in 2-red / 4-yellow / 5-green / 6-blue / 9-white
Neutrik SCDP-0 (Black)

Connectors Mains & Power - Powercon

EH-1030

Soft plastic cover for the rear ends of several D-size chassis connectors
Neutrik SCDR



EH-1035

The dummyPLUG NDL for all 4 pole Neutrik Speakon and powerCON chassis enables you to simplify cabling
Neutrik NDL



EH-1010

Sealing cover for powerCON TRUE1 duplex chassis connector
Neutrik SCNAC-PX



EH-1005

Sealing cover for powerCON TRUE1 chassis connector
Neutrik SCNAC-MPX



EH-1000

Sealing cover for powerCON TRUE1 chassis connector
Neutrik SCNAC-FPX



EH-1045

Weather resistant drip boot for NL4FC, NAC3FCA and NAC3FCB
Neutrik BSL-WR



CP-0015

M3 Mounting Frame for Unified (D Size) Connectors
Neutrik MFD



EH-1040

Faston receptacle for tabs with 'positive lock'. Tab Fit 4.75 x 0.51 mm (0.187 x 0.02 in). Equivalent to AMP, pack of 100 pieces.
Neutrik NLFASSTON



Connectors Mains & Power - DC Connectors



DC-003A
2.1mm DC Socket PCB Mount



DC-003B
2.5mm DC Socket PCB Mount



DC-008C
1.3mm DC Socket PCB Mount

DC-038A
2.1mm DC Chassis Mount Socket Solder Tags

DC-038B
2.5mm DC Chassis Mount Socket Solder Tags

DC-038C
1.3mm DC Chassis Mount Socket Solder Tags

DC-039A
2.1mm DC Chassis Mount Socket PCB Terminals

DC-039B
2.5mm DC Chassis Mount Socket PCB Terminals

DC-039C
1.3mm DC Chassis Mount Socket PCB Terminals



DC Power Plugs & Line Sockets

DCP-001
2.1mm DC Plug with 10mm Barrel

DCP-002
2.1mm DC Plug with 14mm Barrel

DCP-003
2.5mm DC Plug with 10mm Barrel

DCP-004
2.5mm DC Plug with 14mm Barrel

DCP-006
1.3mm DC Plug Miniature Type



DCP-010
2.1mm DC Plug Right Angled

DCP-008
2.5mm DC Plug Right Angled

Connectors Mains & Power - DC Connectors

DCLP-001

2.1mm DC Line Socket

DCLP-002

2.5mm DC Line Socket



DC Moulded Leads

DM-2110

2.1 x 5.5 x 10mm DC Plug to Free End with 1.8m Black Figure-8 Cable

DM-2140

2.1 x 5.5 x 14mm DC Plug to Free End with 1.8m Black Figure-8 Cable

DM-2510

2.5 x 5.5 x 10mm DC Plug to Free End with 1.8m Black Figure-8 Cable

DM-2540

2.5 x 5.5 x 14mm DC Plug to Free End with 1.8m Black Figure-8 Cable



We can supply custom made moulded DC leads to your specification.

Switchcraft Right Angled PCB DC Sockets

DC-013A

2.1mm DC Socket Through Hole PCB Mount Switchcraft RAPC722X

DC-013B

2.5mm DC Socket Through Hole PCB Mount Switchcraft RAPC712X

DC-013C

1.3mm DC Socket Through Hole PCB Mount Switchcraft RAPC732X

DC-014A

2.1mm DC Socket Hybrid SMD/PCB Mount Switchcraft RASH722X

DC-014B

2.5mm DC Socket Hybrid SMD/PCB Mount Switchcraft RASH712X

DC-014C

1.3mm DC Socket Hybrid SMD/PCB Mount Switchcraft RASH732X

DC-015A

2.1mm DC Socket Surface Mount Switchcraft RASM722X

DC-015B

2.5mm DC Socket Surface Mount Switchcraft RASM712X

DC-015C

1.3mm DC Socket Surface Mount Switchcraft RASM732X

Switchcraft
CONXALL





Switchcraft DC Chassis Mount Sockets

DC-016A
2.1mm DC Socket Solder Tags
Switchcraft 722A

DC-016B
2.5mm DC Socket Solder Tags
Switchcraft 712A

DC-016C
1.3mm DC Socket Solder Tags
Switchcraft 732A

DC-018A
2.1mm DC Socket Right Angle PCB Pins
Switchcraft 722RA

DC-018B
2.5mm DC Socket Right Angle PCB Pins
Switchcraft 712RA

DC-018C
1.3mm DC Socket Right Angle PCB Pins
Switchcraft 732RA

DC-019A
2.1mm DC Socket Straight PCB Pins
Switchcraft PC722A

DC-019B
2.5mm DC Socket Straight PCB Pins
Switchcraft PC712A

DC-019C
1.3mm DC Socket Straight PCB Pins
Switchcraft PC732A



Switchcraft DC Plugs

DCP-005
2.1mm DC Plug Black Handle
Switchcraft S760

DCP-013
2.5mm DC Plug Black Handle
Switchcraft 760

DCP-011
2.1mm DC Plug Red Handle
Switchcraft S765

DCP-014
2.5mm DC Plug Red Handle
Switchcraft 765

DCP-015
2.1mm DC Plug with Locking Ring
Switchcraft S760K

DCP-012
2.5mm DC Plug with Locking Ring
Switchcraft 760K

Connectors Mains & Power - DC Connectors

High Amperage Non-Sealed Power Jacks and Plugs

Available in locking or non-locking versions.
24 Volt upto 11 Amp carry current rating. 2.1mm size centre pins.

DC-2000

High Amperage Socket Through Hole Mount
Switchcraft RAPC10

DC-2005

High Amperage Socket Through Hole Mount with Locating Post
Switchcraft RAPC10P

DC-2010

High Amperage Socket Hybrid Mount
Switchcraft RASH10

DC-2015

High Amperage Socket Hybrid Mount with Locating Post
Switchcraft RASH10P

DC-2020

High Amperage Socket Surface Mount
Switchcraft RASM10

DC-2025

High Amperage Socket Surface Mount with Locating Post
Switchcraft RASM10P



DGP-2030

High Amperage Power Plug
Switchcraft S10

DGP-2035

High Amperage Power Plug with Locking Ring
Switchcraft S10K



Connectors Mains & Power - DC Connectors

Switchcraft Sealed Power Jacks and Plugs

A great waterproof alternative to the standard power plug and jack. With an IP 68/ NEMA 250 (6P) rating this series of product is perfect for any type of environment.



DC-3010

2.1mm Sealed Power Jack Solder Lugs
Switchcraft L722AS

DC-3000

2.5mm Sealed Power Jack Solder Lugs
Switchcraft L712AS

DC-3025

2.1mm Sealed Power Jack Straight PCB Terminals
Switchcraft PCL722AS

DC-3020

2.5mm Sealed Power Jack Straight PCB Terminals
Switchcraft PCL712AS

DC-3015

2.1mm Sealed Power Jack Right Angle PCB Terminals
Switchcraft L722RAS

DC-3005

2.5mm Sealed Power Jack Right Angle PCB Terminals
Switchcraft L712RAS



DC-3030

Power Jack Sealed Cap
Switchcraft JCAP

DC-3035

Insulating Washer Kit
Switchcraft P3818



DCP-3045

2.1mm Sealed Power Plug
Switchcraft S761KS12

DCP-3040

2.5mm Sealed Power Plug
Switchcraft 761KS12

Ribbon Cable suitable for IDC Connectors

CH-0510

10 Way Grey Ribbon Cable 100ft

CH-0514

14 Way Grey Ribbon Cable 100ft

CH-0516

16 Way Grey Ribbon Cable 100ft

CH-0526

26 way Grey Ribbon Cable 100ft

CH-0534

34 Way Grey Ribbon Cable 100ft

CH-0540

40 Way Grey Ribbon Cable 100ft

CH-0550

50 Way Grey Ribbon Cable 100ft

CH-0560

60 Way Grey Ribbon Cable 100ft

CH-0710

10 way Rainbow Ribbon Cable 100ft

CH-0720

20 Way Rainbow Ribbon Cable 100ft



Custom Ribbon Cables available -
please contact us with your requirements

IDC Cable Mounted Socket with Strain Relief and Gold Plated Contacts

CH-1010

10 Way Cable Mounted Socket

CH-1014

14 Way Cable Mounted Socket

CH-1016

16 Way Cable Mounted Socket

CH-1020

20 Way Cable Mounted Socket

CH-1024

24 Way Cable Mounted Socket

CH-1026

26 Way Cable Mounted Socket

CH-1030

30 Way Cable Mounted Socket

CH-1034

34 Way Cable Mounted Socket

CH-1040

40 Way Cable Mounted Socket

CH-1050

50 Way Cable Mounted Socket

CH-1060

60 Way Cable Mounted Socket

CH-1064

64 Way Cable Mounted Socket



IDC Header Straight PCB Mounting Latching

CH-3010

10 Way Straight Latching Header

CH-3014

14 Way Straight Latching Header

CH-3016

16 Way Straight Latching Header

CH-3020

20 Way Straight Latching Header

CH-3024

24 Way Straight Latching Header

CH-3026

26 Way Straight Latching Header

CH-3030

30 Way Straight Latching Header

CH-3034

34 Way Straight Latching Header

CH-3040

40 Way Straight Latching Header

CH-3050

50 Way Straight Latching Header

CH-3060

60 Way Straight Latching Header

CH-3064

64 Way Straight Latching Header



Connectors Multipole - IDC



IDC Header Straight PCB Mounting

CH-5010
10 Way Straight Header

CH-5014
14 Way Straight Header

CH-5016
16 Way Straight Header

CH-5020
20 Way Straight Header

CH-5024
24 Way Straight Header

CH-5026
26 Way Straight Header

CH-5030
30 Way Straight Header

CH-5034
34 Way Straight Header

CH-5040
40 Way Straight Header

CH-5050
50 Way Straight Header

CH-5060
60 Way Straight Header

CH-5064
64 Way Straight Header

IDC Header Right Angle PCB Mounting Latching

CH-2010
10 Way R/A Latching Header

CH-2014
14 Way R/A Latching Header

CH-2016
16 Way R/A Latching Header

CH-2020
20 Way R/A Latching Header

CH-2024
24 Way R/A Latching Header

CH-2026
26 Way R/A Latching Header

CH-2030
30 Way R/A Latching Header

CH-2034
34 Way R/A Latching Header

CH-2040
40 Way R/A Latching Header

CH-2050
50 Way R/A Latching Header

CH-2060
60 Way R/A Latching Header

CH-2064
64 Way R/A Latching Header

IDC Header Right Angle PCB Mounting

CH-4010
10 Way R/A Header

CH-4014
14 Way R/A Header

CH-4016
16 Way R/A Header

CH-4020
20 Way R/A Header

CH-4024
24 Way R/A Header

CH-4026
26 Way R/A Header

CH-4030
30 Way R/A Header

CH-4034
34 Way R/A Header

CH-4040
40 Way R/A Header

CH-4050
50 Way R/A Header

CH-4060
60 Way R/A Header

CH-4064
64 Way R/A Header

CH-6010

10 Way Transition Connector

CH-6014

14 Way Transition Connector

CH-6016

16 Way Transition Connector

CH-6020

20 Way Transition Connector

CH-6024

24 Way Transition Connector

CH-6026

26 Way Transition Connector

CH-6030

30 Way Transition Connector

CH-6034

34 Way Transition Connector

CH-6040

40 Way Transition Connector

CH-6050

50 Way Transition Connector

CH-6060

60 Way Transition Connector

CH-6064

64 Way Transition Connector

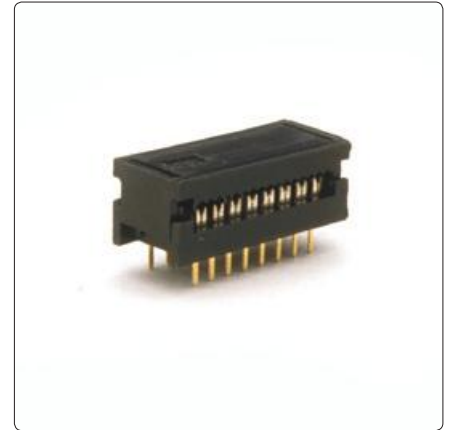

CH-7008

8 Way DIL Transition Connector

CH-7010

10 Way DIL Transition Connector

CH-7014

14 Way DIL Transition Connector

CH-7016

16 Way DIL Transition Connector

CH-7018

18 Way DIL Transition Connector

CH-7020

20 Way DIL Transition Connector

CH-7024

24 Way DIL Transition Connector

CH-7028

28 Way DIL Transition Connector

CH-7032

32 Way DIL Transition Connector

CH-7036

36 Way DIL Transition Connector

CH-7040

40 Way DIL Transition Connector

CH-7042

42 Way DIL Transition Connector



Connectors Multipole - D & HDD



D Connectors Solder Bucket

DD-1009
9 Way Male

DD-1015
15 Way Male

DD-1025
25 Way Male

DD-1037
37 Way Male

DD-1509
9 Way Female

DD-1515
15 Way Female

DD-1525
25 Way Female

DD-1537
37 Way Female



D Connectors Straight PCB Pins

DD-2009
9 Way Male

DD-2015
15 Way Male

DD-2025
25 Way Male

DD-2037
37 Way Male

DD-2509
9 Way Female

DD-2515
15 Way Female

DD-2525
25 Way Female

DD-2537
37 Way Female



D Connectors Right Angle PCB Mounting

DD-3009
9 Way Male

DD-3015
15 Way Male

DD-3025
25 Way Male

DD-3037
37 Way Male

DD-3509
9 Way Female

DD-3515
15 Way Female

DD-3525
25 Way Female

DD-3537
37 Way Female



High Density D Connectors Solder Bucket

HD-1015
15 Way High Density Male

HD-1026
26 Way High Density Male

HD-1044
44 Way High Density Male

HD-1515
15 Way High Density Female

HD-1526
26 Way High Density Female

HD-1544
44 Way High Density Female



High Density D Connectors Straight PCB Pins

HD-2015
15 Way High Density Male

HD-2026
26 Way High Density Male

HD-2044
44 Way High Density Male

HD-2515
15 Way High Density Female

HD-2526
26 Way High Density Female

HD-2544
44 way High Density Female

Connectors Multipole - D & HDD

High Density D Connectors Right Angle PCB Mounting

HD-3015

15 Way High Density Male

HD-3026

26 Way High Density Male

HD-3044

44 Way High Density Male

HD-3515

15 Way High Density Female

HD-3526

26 Way High Density Female

HD-3544

44 Way High Density Female



Plastic D Connector Hoods

DD-6009

9 Pin Plastic Hood

DD-6015

15 Pin Plastic Hood

DD-6025

25 Pin Plastic Hood

DD-6037

37 Pin Plastic Hood



Metallised Plastic D Connector Hoods

DD-7009

9 Pin Metallised Plastic Hood

DD-7015

15 Pin Metallised Plastic Hood

DD-7025

25 Pin Metallised Plastic Hood

DD-7037

37 Pin Metallised Plastic Hood



One Piece Snap Fit D Connector Hoods

DD-7509

9 Pin D Hood Snap Fit

DD-7515

15 Pin D Hood Snap Fit

DD-7525

25 Pin D Hood Snap Fit

DD-7537

37 Pin D Hood Snap Fit



D Type Hardware

DH-2308

8mm Length Pair of Hex Posts each with a Spring Washer and Fixing Nut

DH-2313

13mm Length Pair of Hex Posts each with a Spring Washer and Fixing Nut



Connectors Multipole - Telecom



TC-1395
Easy Wire Crimp Tool



TC-1385
RJ45 Cat 5e Easy Wire Plug

TC-1390
RJ45 Cat 6 Easy Wire Plug

TC-1370
RJ45 Cat 5e & Cat 6 Easy Wire Screened Plug



TC-1440
4/4 Handset Plug

TC-1640
6/4 RJ11 Plug

TC-1660
6/6 RJ12 Plug

TC-1881
8/8 RJ45 Round Cable Plug



TC-0810
RJ45 Boot Black

TC-0830
RJ45 Boot Red

TC-0840
RJ45 Boot Blue

TC-0850
RJ45 Boot Green

TC-0860
RJ45 Boot Grey

TC-0870
RJ45 Boot Yellow



Coloured Boots for use with RJ45 8P8C Plugs

TC-2440
4P4C PCB R/A Socket

TC-2660
6P6C PCB R/A Socket

TC-2880
8P8C PCB R/A Socket

TC-9880
8P8C R/A PCB socket with LEDs



TC-5440
4P4C PCB Vertical Socket

TC-5660
6P6C PCB Vertical Socket

TC-5880
8P8C PCB Vertical Socket

We also stock a full range of Cat 5e & Cat 6 Patch leads together with boxes of cable and a wide selection of tools and accessories for Cat cables.

Connectors Multipole - USB / Firewire

USB Universal Serial Bus Connectors

US-4000

Single A PCB Mount Socket

US-4020

Dual A PCB Mount Socket

US-4030

Single B PCB Mount Socket



USB 2.0 Cables Black

US-7205

USB A Male to B Male 0.5 Metre

US-7210

USB A Male to B Male 1 Metre

US-7220

USB A Male to B Male 2 Metres

US-7230

USB A Male to B Male 3 Metres

US-7250

USB A Male to B Male 5 Metres

US-7305

USB A Male to A Male 0.5 Metre

US-7310

USB A Male to A Male 1 Metre

US-7320

USB A Male to A Male 2 Metres

US-7330

USB A Male to A Male 3 Metres

US-7350

USB A Male to A Male 5 Metres



Firewire IEEE1394 Connectors

FW-1060

6 Pole PCB Mount Firewire Socket Side Profile

FW-2060

6 Pole PCB Mount Firewire Socket

FW-2040

4 Pole PCB Mount Firewire Socket

FW-1000

Firewire IEEE1394B (800mbps) Male 9 Pin to Male 9 Pin 2 Metres Long Black

FW-1010

Firewire IEEE1394B (800mbps) Male 9 Pin to Male 6 Pin 2 Metres Long Black



Connectors Multipole - Weathertight

Switchcraft®
GONXALL®



Switchcraft IP68 EN3 Weathertight Connectors - Male Cable Plugs

WT-1120
EN3C2MX 2 Pole

WT-1130
EN3C3MX 3 Pole

WT-1140
EN3C4MX 4 Pole

WT-1150
EN3C5MX 5 Pole

WT-1160
EN3C6MX 6 Pole

WT-1190
EN3C9M26SX 9 Pole

WT-1110
EN3C10M26SX 10 Pole

WT-1111
EN3C11M26SX 11 Pole

WT-1112
EN3C12M26SX 12 Pole

WT-1113
EN3C13M26SX 13 Pole

WT-1114
EN3C14M26SX 14 Pole

WT-1115
EN3C15M26SX 15 Pole

WT-1116
EN3C16M26SX 16 Pole

WT-1117
EN3C17M26SX 17 Pole

WT-1118
EN3C18M26SX 18 Pole



Switchcraft IP68 EN3 Weathertight Connectors - Female Cable Socket

WT-1220
EN3C2FX 2 Pole

WT-1230
EN3C3FX 3 Pole

WT-1240
EN3C4FX 4 Pole

WT-1250
EN3C5FX 5 Pole

WT-1260
EN3C6FX 6 Pole

WT-1270
EN3C7FX 7 Pole

WT-1280
EN3C8FX 8 Pole

WT-1290
EN3C9F26SX 9 Pole

WT-1210
EN3C10F26SX 10 Pole

WT-1211
EN3C11F26SX 11 Pole

WT-1212
EN3C12F26SX 12 Pole

WT-1213
EN3C13F26SX 13 Pole

WT-1214
EN3C14F26SX 14 Pole

WT-1215
EN3C15F26SX 15 Pole

WT-1216
EN3C16F26SX 16 Pole

WT-1217
EN3C17F26SX 17 Pole

WT-1218
EN3C18F26SX 18 Pole

Connectors Multipole - Weathertight

Switchcraft IP68 EN3 Weathertight Connectors - Male Cable Line Connector (Mates with Female Cable Socket)

WT-1520
EN3L2MX 2 Pole

WT-1530
EN3L3MX 3 Pole

WT-1540
EN3L4MX 4 Pole

WT-1550
EN3L5MX 5 Pole

WT-1560
EN3L6MX 6 Pole

WT-1570
EN3L7MX 7 Pole

WT-1580
EN3L8MX 8 Pole



Switchcraft IP68 EN3 Weathertight Connectors - Female Cable Line Connector (Mates with Male Cable Plug)

WT-1620
EN3L2FX 2 Pole

WT-1630
EN3L3FX 3 Pole

WT-1640
EN3L4FX 4 Pole

WT-1650
EN3L5FX 5 Pole

WT-1660
EN3L6FX 6 Pole



Connectors Multipole - Weathertight

Switchcraft®
GONXALL®



Switchcraft IP68 EN3 Weathertight Connectors - Male Chassis Plug

WT-1320
EN3P2MX 2 Pole

WT-1330
EN3P3MX 3 Pole

WT-1340
EN3P4MX 4 Pole

WT-1350
EN3P5MX 5 Pole

WT-1360
EN3P6MX 6 Pole

WT-1370
EN3P7MX 7 Pole

WT-1380
EN3P8MX 8 Pole

WT-1390
EN3P9M26X 9 Pole

WT-1310
EN3P10M26X 10 Pole

WT-1311
EN3P11M26X 11 Pole

WT-1312
EN3P12M26X 12 Pole

WT-1313
EN3P13M26X 13 Pole

WT-1314
EN3P14M26X 14 Pole

WT-1315
EN3P15M26X 15 Pole

WT-1316
EN3P16M26X 16 Pole

WT-1317
EN3P17M26X 17 Pole

WT-1318
EN3P18M26X 18 Pole

Switchcraft IP68 EN3 Weathertight Connectors - Female Chassis Socket

WT-1420
EN3P2FX 2 Pole

WT-1430
EN3P3FX 3 Pole

WT-1440
EN3P4FX 4 Pole

WT-1450
EN3P5FX 5 Pole

WT-1460
EN3P6FX 6 Pole

WT-1490
EN3P9F26X 9 Pole

WT-1410
EN3P10F26X 10 Pole

WT-1411
EN3P11F26X 11 Pole

WT-1412
EN3P12F26X 12 Pole

WT-1413
EN3P13F26X 13 Pole

WT-1414
EN3P14F26X 14 Pole

WT-1415
EN3P15F26X 15 Pole

WT-1416
EN3P16F26X 16 Pole

WT-1417
EN3P17F26X 17 Pole

WT-1418
EN3P18F26X 18 Pole

Connectors Multipole - Weathertight

Switchcraft IP68 EN3 Weathertight Right Angle PCB Mount Female Connectors

WT-1820

EN3P2FRAPCX 2 Pole

WT-1830

EN3P3FRAPCX 3 Pole

WT-1840

EN3P4FRAPCX 4 Pole

WT-1850

EN3P5FRAPCX 5 Pole

WT-1860

EN3P6FRAPCX 6 Pole



Switchcraft IP68 EN3 Weathertight Right Angle PCB Mount Male Connectors

WT-1720

EN3P2MRAPCX 2 Pole

WT-1730

EN3P3MRAPCX 3 Pole

WT-1740

EN3P4MRAPCX 4 Pole

WT-1750

EN3P5MRAPCX 5 Pole

WT-1760

EN3P6MRAPCX 6 Pole

WT-1770

EN3P7MRAPCX 7 Pole

WT-1780

EN3P8MRAPCX 8 Pole

Switchcraft Weathertight Dust Caps

EN3CAP

Dust Cap for Chassis Connector

EN3CAPC

Dust Cap for Cord Connector



Connectors Multipole - Weathertight

Switchcraft[®]
GONXALL[®]



Switchcraft IP68 EN3 Weathertight Right Angle PCB Mount Male Connectors Wide PCB Style

WT-2002

EN3P2MRAPCBW 2 Pole

WT-2003

EN3P3MRAPCBW 3 Pole

WT-2004

EN3P4MRAPCBW 4 Pole

WT-2005

EN3P5MRAPCBW 5 Pole

WT-2006

EN3P6MRAPCBW 6 Pole

WT-2007

EN3P7MRAPCBW 7 Pole

WT-2008

EN3P8MRAPCBW 8 Pole

WT-2009

EN3P9MRAPCBW 9 Pole

WT-2010

EN3P10MRAPCBW 10 Pole

WT-2011

EN3P11MRAPCBW 11 Pole

WT-2012

EN3P12MRAPCBW 12 Pole

WT-2013

EN3P13MRAPCBW 13 Pole

WT-2014

EN3P14MRAPCBW 14 Pole

WT-2015

EN3P15MRAPCBW 15 Pole

WT-2016

EN3P16MRAPCBW 16 Pole

WT-2017

EN3P17MRAPCBW 17 Pole

WT-2018

EN3P18MRAPCBW 18 Pole

Switchcraft IP68 EN3 Weathertight Right Angle PCB Mount Female Connectors Wide PCB Style

WT-3002

EN3P2FRAPCBW 2 Pole

WT-3003

EN3P3FRAPCBW 3 Pole

WT-3004

EN3P4FRAPCBW 4 Pole

WT-3005

EN3P5FRAPCBW 5 Pole

WT-3006

EN3P6FRAPCBW 6 Pole

WT-3009

EN3P9FRAPCBW 9 Pole

WT-3010

EN3P10FRAPCBW 10 Pole

WT-3011

EN3P11FRAPCBW 11 Pole

WT-3012

EN3P12FRAPCBW 12 Pole

WT-3013

EN3P13FRAPCBW 13 Pole

WT-3014

EN3P14FRAPCBW 14 Pole

WT-3015

EN3P15FRAPCBW 15 Pole

WT-3016

EN3P16FRAPCBW 16 Pole

WT-3017

EN3P17FRAPCBW 17 Pole

WT-3018

EN3P18FRAPCBW 18 Pole

Connectors Multipole - Weathertight

Switchcraft IP68 EN3 Weathertight Right Angle PCB Mount Male Connectors Narrow PCB Style

WT-2102

EN3P2MRAPCBN 2 Pole

WT-2103

EN3P3MRAPCBN 3 Pole

WT-2104

EN3P4MRAPCBN 4 Pole

WT-2105

EN3P5MRAPCBN 5 Pole

WT-2106

EN3P6MRAPCBN 6 Pole

WT-2107

EN3P7MRAPCBN 7 Pole

WT-2108

EN3P8MRAPCBN 8 Pole

WT-2109

EN3P9MRAPCBN 9 Pole

WT-2110

EN3P10MRAPCBN 10 Pole

WT-2111

EN3P11MRAPCBN 11 Pole

WT-2112

EN3P12MRAPCBN 12 Pole

WT-2113

EN3P13MRAPCBN 13 Pole

WT-2114

EN3P14MRAPCBN 14 Pole

WT-2115

EN3P15MRAPCBN 15 Pole

WT-2116

EN3P16MRAPCBN 16 Pole

WT-2117

EN3P17MRAPCBN 17 Pole

WT-2118

EN3P18MRAPCBN 18 Pole



Switchcraft IP68 EN3 Weathertight Right Angle PCB Mount Female Connectors Narrow PCB Style

WT-3102

EN3P2FRAPCBN 2 Pole

WT-3103

EN3P3FRAPCBN 3 Pole

WT-3104

EN3P4FRAPCBN 4 Pole

WT-3105

EN3P5FRAPCBN 5 Pole

WT-3106

EN3P6FRAPCBN 6 Pole

WT-3109

EN3P9FRAPCBN 9 Pole

WT-3110

EN3P10FRAPCBN 10 Pole

WT-3111

EN3P11FRAPCBN 11 Pole

WT-3112

EN3P12FRAPCBN 12 Pole

WT-3113

EN3P13FRAPCBN 13 Pole

WT-3114

EN3P14FRAPCBN 14 Pole

WT-3115

EN3P15FRAPCBN 15 Pole

WT-3116

EN3P16FRAPCBN 16 Pole

WT-3117

EN3P17FRAPCBN 17 Pole

WT-3118

EN3P18FRAPCBN 18 Pole

Connectors Multipole - Micro-Con-X



Micro-Con-X
 2 - 7 Contacts
 13mm Diameter
 600V / Upto 7.5A



PART NUMBER TO ORDER

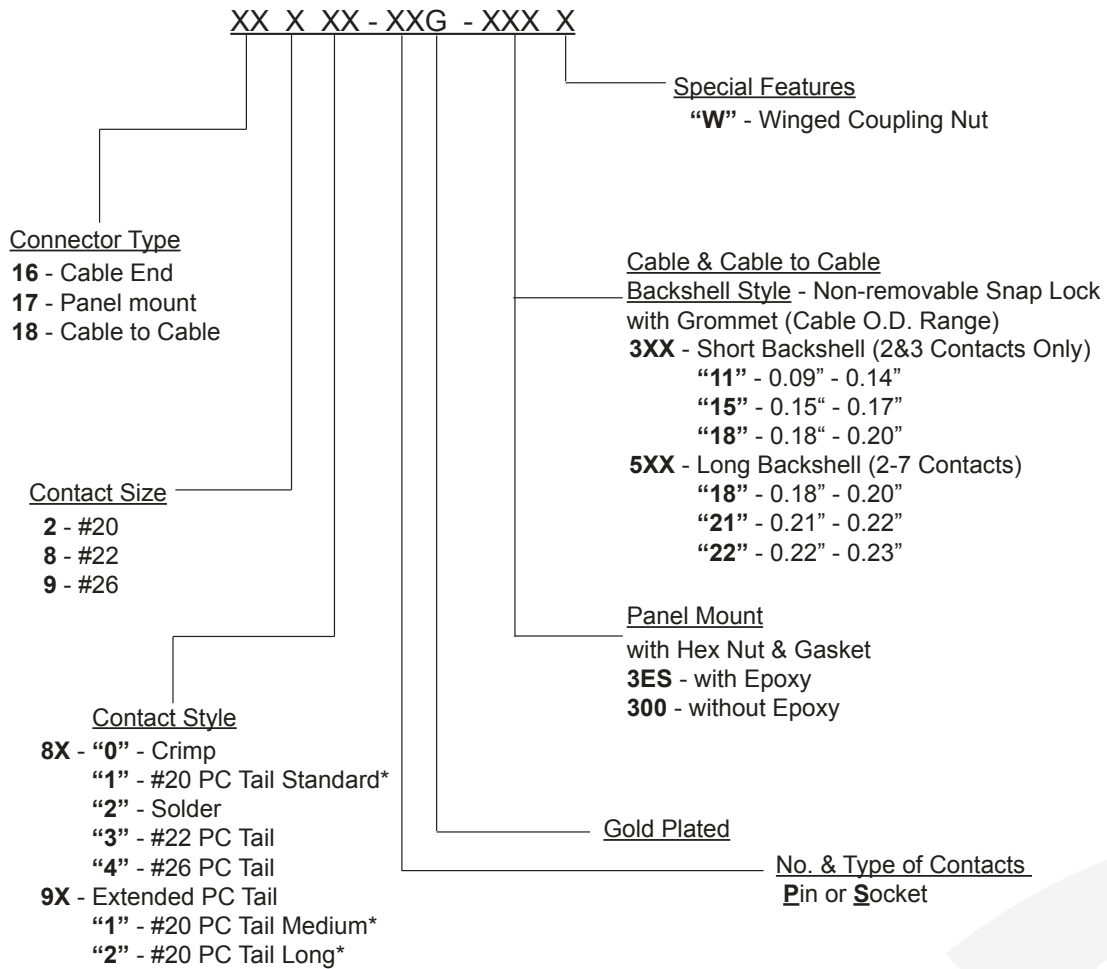

*Consult factory for length and diameter of PC Tail. Additionally, alternative colors and materials are available.

Connectors Multipole - Mini-Con-X



Switchcraft®
CONXALL®

Mini-Con-X
2 - 8 Contacts
18mm Diameter
600V / Upto 13A

PART NUMBER TO ORDER

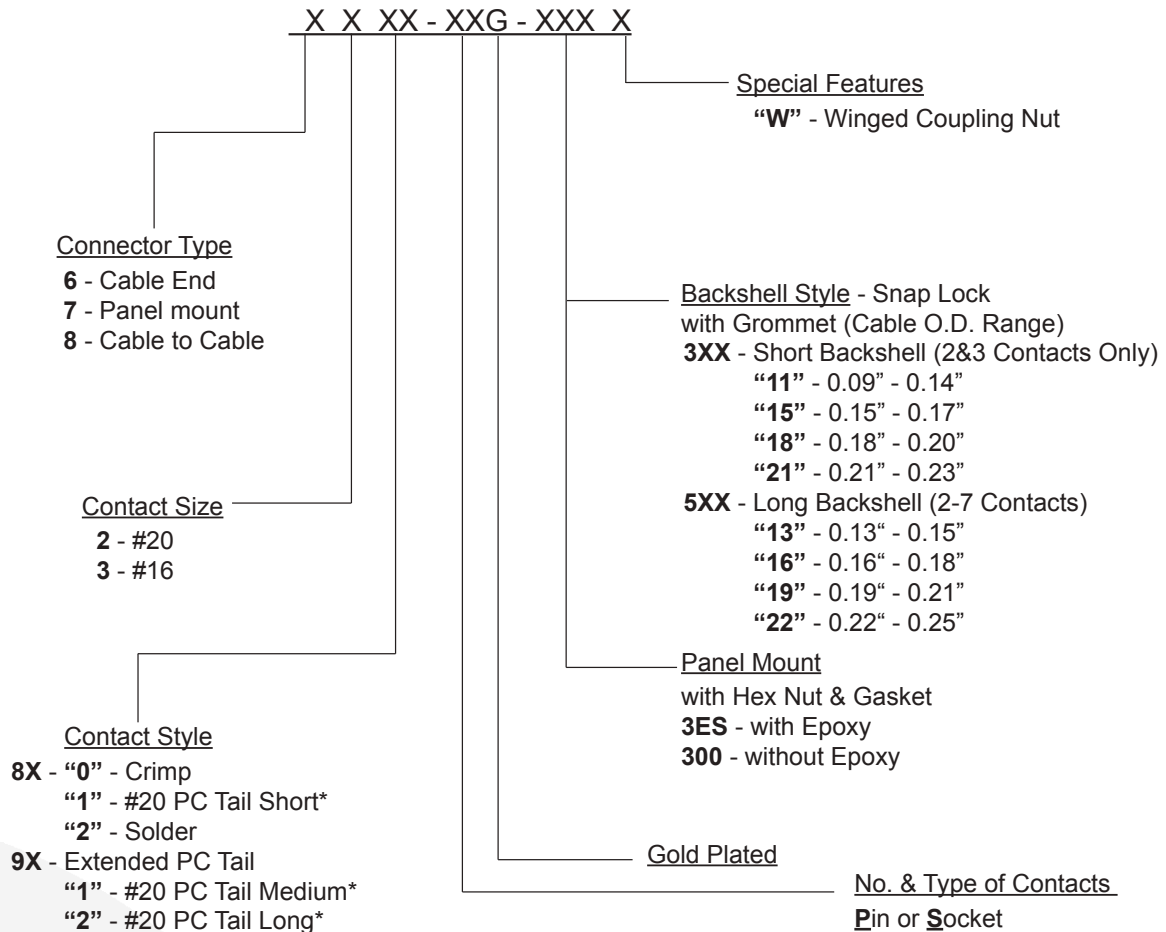

*Consult factory for length and diameter of PC Tail. Additionally, alternative colors and materials are available.

Connectors Multipole - Shielded Mini-Con-X



Shielded Mini-Con-X

2 - 8 Contacts
19mm Diameter
600V / Upto 13A



PART NUMBER TO ORDER

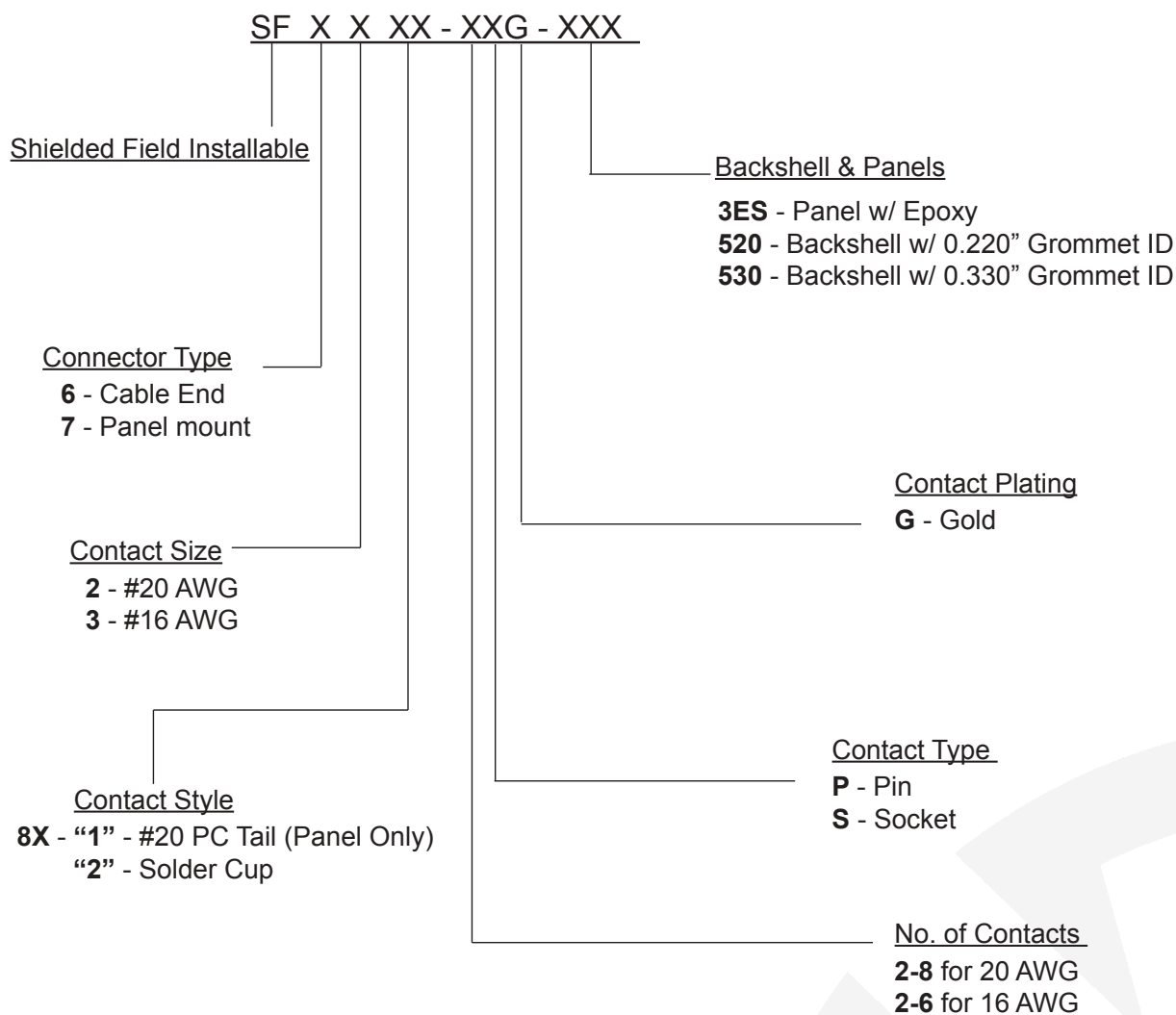

Connectors Multipole - Multi-Con-X



Switchcraft®
CONXALL®

Multi-Con-X
2 - 9 Contacts
22mm Diameter
600V / Upto 17A

PART NUMBER TO ORDER

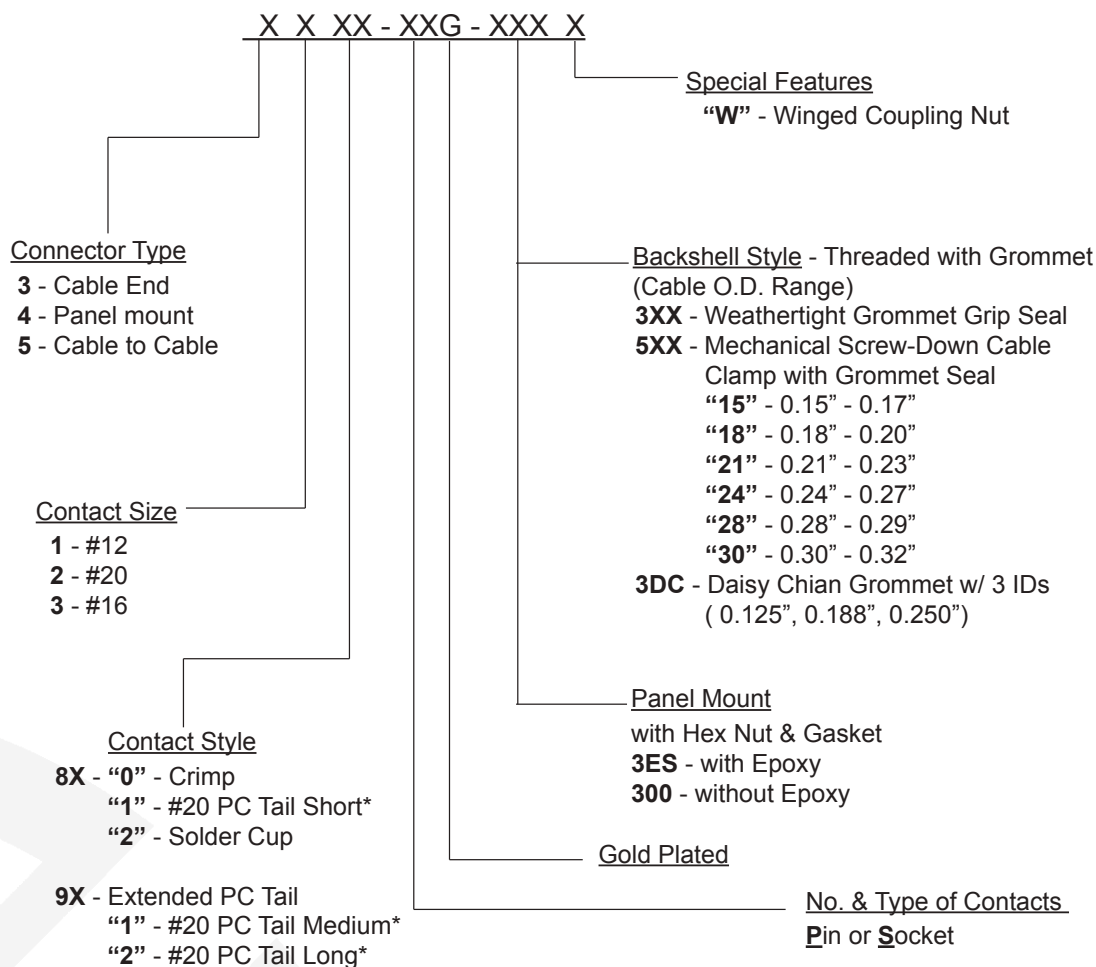

*Consult factory for length and diameter of PC Tail. Additionally, alternative colors and materials are available.

Connectors Multipole - Shielded Multi-Con-X



Shielded Multi-Con-X

2 - 12 Contacts
25mm Diameter
600V / Upto 17A

PART NUMBER TO ORDER

SF X X XX X - XX X XG - XXX

Shielded Field Installable

Connector Type

3 - Cable End
4 - Panel mount

Contact Size

2 - #20 AWG
3 - #16 AWG

Contact Style

8X - "1" - #20 PC Tail (Panel Only)
"2" - Solder Cup

Insert & Shell Material Only

Blank - Thermoplastic Insert
(Cable End Only)
Blank - Nickel Plated Copper Alloy Panel Mount
Shell with an Engineered Polyester Resin Insert
(Panel Only)
V - One Piece Thermoplastic
Panel Mount Shell

Backshell & Panels

3ES - Panel w/ Epoxy
520 - Backshell w/ 0.200" Grommet ID
540 - Backshell w/ 0.400" Grommet ID

Contact Plating

G - Gold

Contact Type

P - Pin (Panel Mount)
S - Socket (Cable End)

Keying

A-D - (2 -9 #20 Contacts)
E - (2 -12 #20 Contacts)
F - (2 -4 #16 Contacts)

No. of Contacts

2-12

Connectors Multipole - Maxi-Con-X



Switchcraft®
GONXALL®

Maxi-Con-X

7, 10, 18 & 20 Contacts
29mm Diameter
600VDC / 480VAC / Upto 23A

PART NUMBER TO ORDER

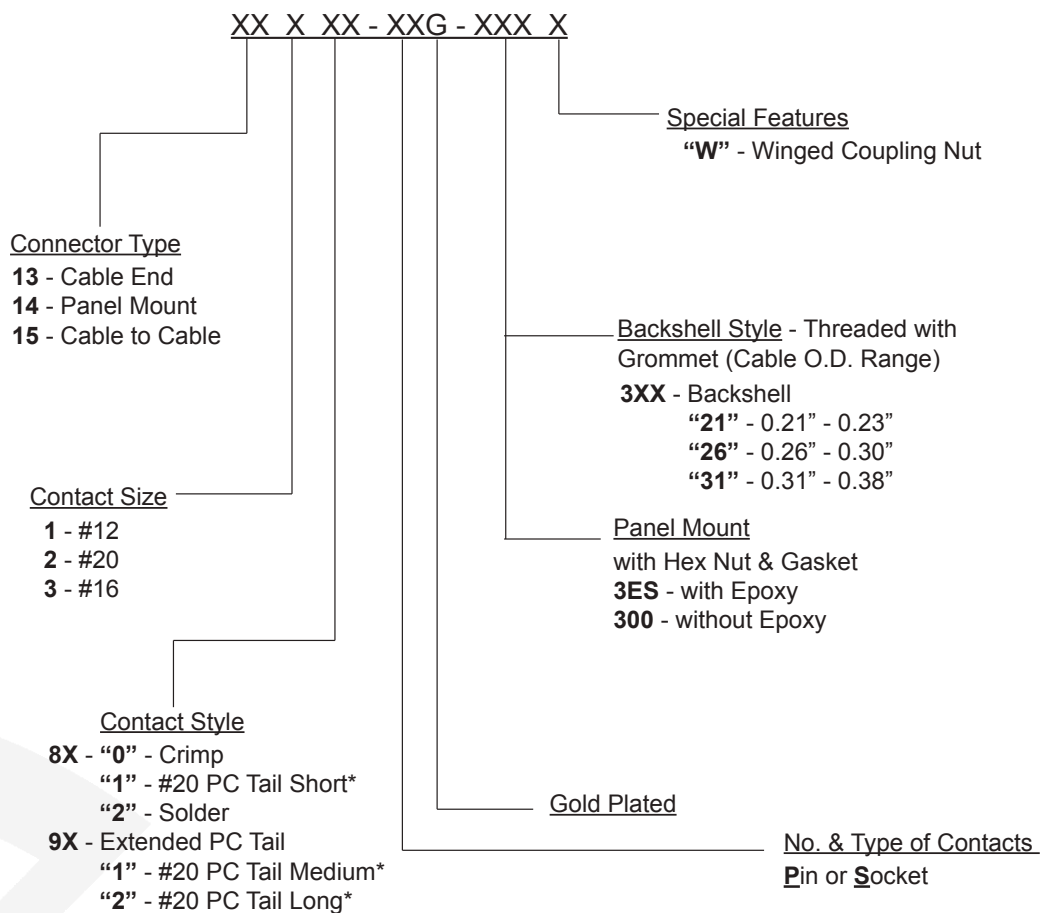

*Consult factory for length and diameter of PC Tail. Additionally, alternative colors and materials are available.

Connectors Multipole - Mega-Con-X



Mega-Con-X
 31 Contacts
 32mm Diameter
 600VAC / 2.3A



PART NUMBER TO ORDER

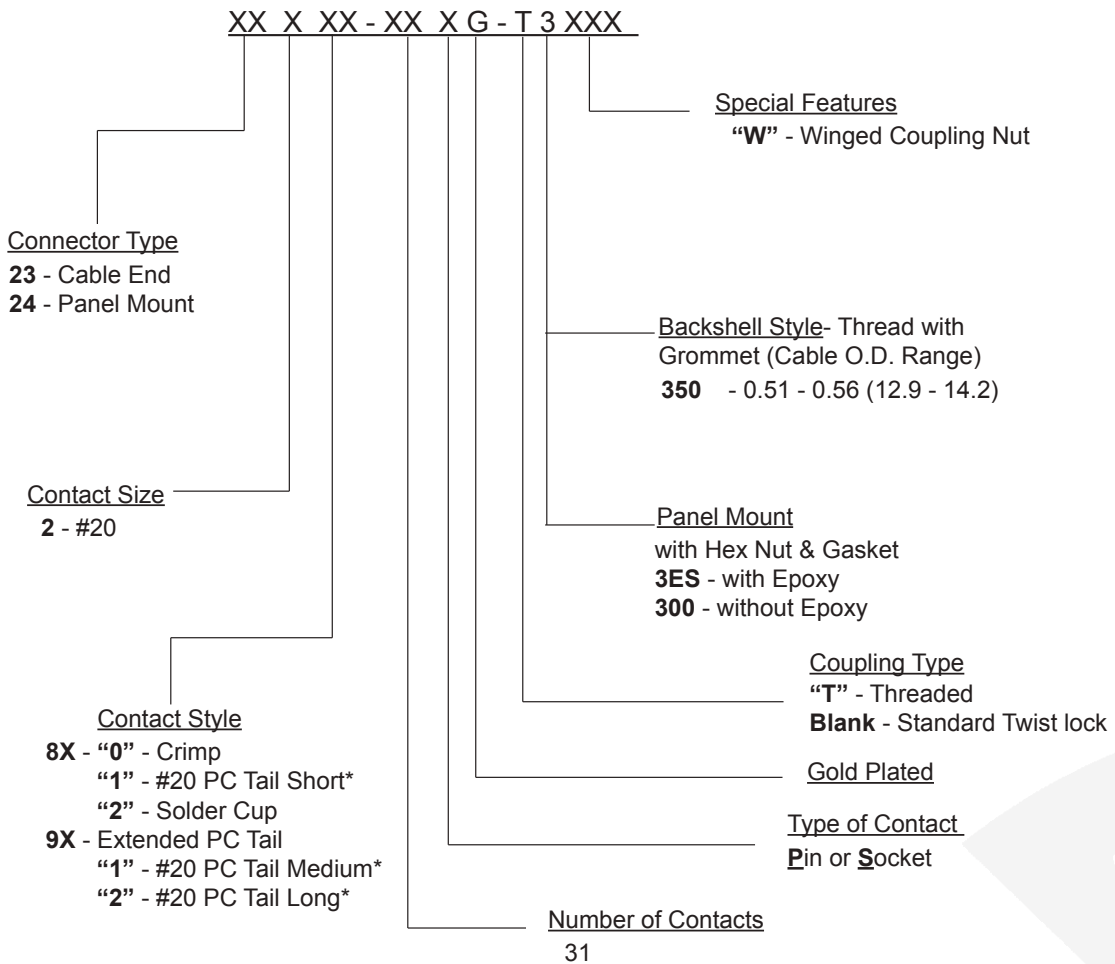

*Consult factory for length and diameter of PC Tail. Additionally, alternative colors and materials are available.

Connectors Multipole - Mil-E-Qual



Switchcraft
CONXALL

Mil-E-Qual

MIL-C-5015 Equivalent
2 - 37 Contacts
9 Sizes
Upto 600VAC / 23A

PART NUMBER TO ORDER

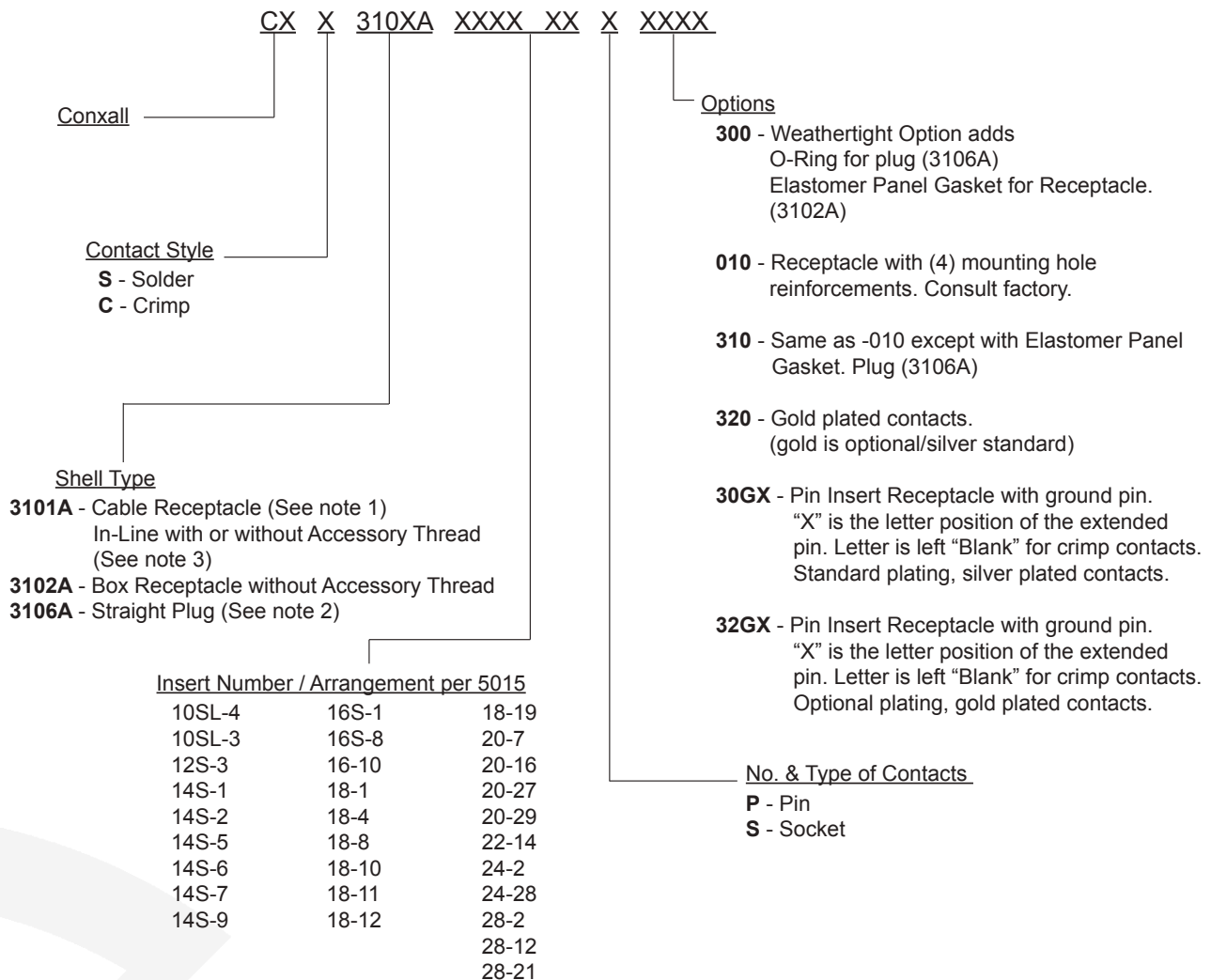

Complete P/N contains no spaces or dashes.
Consult factory for optional colors and materials

Note 1: All Plugs, Box Mount Receptacles and In-Line Receptacles include
Crimp or Solder Contacts specified.

Note 2: Straight Plugs include Backshell Assembly with Cable Clamp and Bushing.

Note 3: In-Line Receptacles can be with or without Accessory Thread. Consult factory for
availability. In-Line Receptacles without Accessory Thread can be overmolded.



BNC Plugs

BN-1100
50Ω BNC Plug RG58 Crimp Type

BN-1200
75Ω BNC Plug RG59 Crimp Type

BN-1179
75Ω BNC Plug RG179 Crimp Type



BN-1300
50Ω BNC Plug RG58 Clamp type

BN-1400
75Ω BNC Plug RG59 Clamp type



Insulated Boots for Crimp Type BNC Plugs

BN-0110 RG58 Boot Black

BN-0130 RG58 Boot Red

BN-0140 RG58 Boot Blue

BN-0150 RG58 Boot Green

BN-0170 RG58 Boot Yellow

BN-0210 RG59 Boot Black

BN-0230 RG59 Boot Red

BN-0240 RG59 Boot Blue

BN-0250 RG59 Boot Green

BN-0270 RG59 Boot Yellow

BN-0310 RG179 Boot Black

BN-0330 RG179 Boot Red

BN-0340 RG179 Boot Blue

BN-0350 RG179 Boot Green

BN-0370 RG179 Boot Yellow

Chassis Mounting BNC Sockets

BN-1800

50Ω BNC Socket Chassis Mount Uninsulated

BN-1870

75Ω BNC Socket Chassis Mount Uninsulated



BN-1900

50Ω BNC Socket Chassis Mount Insulated

BN-1970

75Ω BNC Socket Chassis Mount Insulated



BN-1637

75Ω BNC Socket/Socket Chassis Mount Coupler



PCB Mounting BNC Sockets

BN-2300

50Ω BNC Socket Vertical PCB Mount

BN-2301

75Ω BNC Socket Vertical PCB Mount



BN-6170

75Ω BNC Socket Ultra Low Profile R/A PCB Mount



BN-2100

50Ω BNC Socket R/A PCB Mount

BN-2170

75Ω BNC Socket R/A PCB Mount





BN-2110
50Ω BNC Socket R/A PCB Mount Screened

BN-2177
75Ω BNC Socket R/A PCB Mount Screened



BN-2215
50Ω BNC Socket Vertical PCB Mount Screened

BN-2275
75Ω BNC Socket Vertical PCB Mount Screened



BN-2555
50Ω Dual Port BNC Right Angle PCB Mount

BN-2575
75Ω Dual Port BNC Right Angle PCB Mount



BN-2355
50Ω Dual Port BNC Right Angle PCB Mount Screened

BN-2375
75Ω Dual Port BNC Right Angle PCB Mount Screened

BN-5110

75Ω BNC Socket R/A PCB Mount Screened



Multipole BNC Sockets**BN-4075**

1 x 4 75Ω BNC Multipole Socket

BN-4275

2 x 1 75Ω BNC Multipole Socket

BN-4475

2 x 2 75Ω BNC Multipole Socket

BN-4675

2 x 3 75Ω BNC Multipole Socket

BN-4875

2 x 4 75Ω BNC Multipole Socket



SMB Connectors**SM-1010**

50Ω SMB Socket Right Angled PCB Mounted
Gold Plated Throughout



SM-1020

50Ω SMB Socket Vertical PCB Mounted
Gold Plated Throughout



SM-1030

50Ω SMB Plug RG174A/U Crimp Type
Gold Plated Throughout





20x5mm Fuses - Time Delay or Quick Blow Options

FT-2502
250mA Time Delay

FF-2502
250mA Quick Blow

FT-2503
315mA Time Delay

FF-2503
315mA Quick Blow

FT-2505
500mA Time Delay

FF-2505
500mA Quick Blow

FT-2506
630mA Time Delay

FF-2506
630mA Quick Blow

FT-2508
800mA Time Delay

FF-2508
800mA Quick Blow

FT-2510
1A Time Delay

FF-2510
1A Quick Blow

FT-2512
1.25A Time Delay

FF-2512
1.25A Quick Blow

FT-2515
1.5A Time Delay

FF-2515
1.5A Quick Blow

FT-2520
2A Time Delay

FF-2520
2A Quick Blow

FT-1525
2.5A Time Delay

FF-2525
2.5A Quick Blow

FT-2530
3.15A Time Delay

FF-2530
3.15A Quick Blow

FT-2540
4A Time Delay

FF-2540
4A Quick Blow

FT-2550
5A Time Delay

FF-2550
5A Quick Blow

FT-2563
6.3A Time Delay

FF-2563
6.3A Quick Blow

FT-2580
8A Time Delay

FF-2580
8A Quick Blow

FT-2500
10A Time Delay

FF-2500
10A Quick Blow



1" x 1/4" Ceramic Mains Plug Fuses

FF-1303
3 Amp Mains Plug Fuse

FF-1305
5 Amp Mains Plug Fuse

FF-1307
7 Amp Mains Plug Fuse

FF-1310
10 Amp Mains Plug Fuse

FF-1313
13 Amp Mains Plug Fuse

20x5mm Fuseholders

FH-2500

Low Profile Chassis Mounting Fuseholder

FC-2510

Clear PVC Insulation Boot for Fuseholder FH-2500



FH-2520

Economy PCB Mounting Fuseholder

FC-2520

Fuseholder Cover for FH-2520



FH-2530

Open Frame Fuseholder with Screw Fixing to Chassis and Solder Tag Terminals



FH-2540

Open Frame PCB Mounting Fuseholder

FC-2540

Clear Cover for FH-2540 Fuseholder



FH-2550

Vertical PCB Mounting Fuseholder

FH-2560

Horizontal PCB Mounting Fuseholder



FH-2580

PCB Mounting Fuseclips





Automotive Blade Fuses

FB-0003
3 Amp Violet

FB-0005
5 Amp Tan

FB-0075
7.5 Amp Brown

FB-0010
10 Amp Red

FB-0015
15 Amp Blue

FB-0020
20 Amp Yellow

FB-0025
25 Amp Clear

FB-0030
30 Amp Green



FB-2000
Blade Fuseholder Vertical PCB Mount



FB-3000
Blade Fuseholder In-Line Cable Mount



Auto Reset Circuit Breaker

AR-1010
PCB Mount Auto Reset Cutout Trip Current 1.0A

AR-1016
PCB Mount Auto Reset Cutout Trip Current 1.6A

AR-1022
PCB Mount Auto Reset Cutout Trip Current 2.2A

AR-1030
PCB Mount Auto Reset Cutout Trip Current 3.0A

AR-1050
PCB Mount Auto Reset Cutout Trip Current 5.0A

Thermal Trips

TT-3060

60°C Normally Open

TT-3070

70°C Normally Open

TT-3075

75°C Normally Open

TT-3080

80°C Normally Open

TT-3085

85°C Normally Open

TT-3090

90°C Normally Open

TT-3095

95°C Normally Open

TT-3100

100°C Normally Open

TT-3105

105°C Normally Open

TT-3110

110°C Normally Open

TT-3115

115°C Normally Open

TT-3120

120°C Normally Open

TT-3130

130°C Normally Open

TT-3140

140°C Normally Open

TT-3145

145°C Normally Open

TT-4060

60°C Normally Closed

TT-4070

70°C Normally Closed

TT-4075

75°C Normally Closed

TT-4080

80°C Normally Closed

TT-4085

85°C Normally Closed

TT-4090

90°C Normally Closed

TT-4095

95°C Normally Closed

TT-4100

100°C Normally Closed

TT-4105

105°C Normally Closed

TT-4110

110°C Normally Closed

TT-4115

115°C Normally Closed

TT-4120

120°C Normally Closed

TT-4130

130°C Normally Closed

TT-4140

140°C Normally Closed

TT-4145

145°C Normally Closed



Potentiometers



9mm Rotary Pot

RP-0940

9mm 10K Dual Log Splined Shaft 25mm

RP-0950

9mm 20K Dual Log Splined Shaft 25mm

RP-0960

9mm 50K Dual Log Splined Shaft 25mm



16mm Rotary Pot

RP-1610

16mm 10K Dual Log Plain Round Shaft 25mm

RP-1615

16mm 20K Dual Log Plain Round Shaft 25mm

RP-1630

16mm 50K Dual Log Plain Round Shaft 25mm

RP-1650

16mm 50K Dual Log Motorised Pot 25mm



27mm Rotary Pot

RP-2725

27mm 20K Dual Log Plain Round Shaft 25mm

RP-2735

27mm 50K Dual Log Plain Round Shaft 25mm

RP-2825

27mm 20K Dual Log Plain Round Motorised Shaft 20mm

RP-2836

27mm 50K Dual Log Plain Round Motorised Shaft 20mm



Custom Potentiometers

To assist us when quoting for custom Potentiometers, please specify the following:

- Resistance Value and Taper or other configurations
- Shaft length & style
- Height from top of PCB to centre of shaft
- Option of detent – centre detent, 21 detent or 41 detent type

6 Watt Switchmode Power Supply

Interchangeable AC pin. Supplied with UK / Europe / USA / Australia type noses. 90-264VAC Input range. Output via 2.1x5.5x12mm DC plug on 1.8 metre cable.

PT-1055

6W Power Supply Output 5 VDC / 1.2 Amp

PT-1060

6W Power Supply Output 6 VDC / 1 Amp

PT-1065

6W Power Supply Output 7.5 VDC / 0.8 Amp

PT-1070

6W Power Supply Output 9 VDC / 0.67 Amp

PT-1075

6W Power Supply Output 12 VDC / 0.5 Amp

PT-1080

6W Power Supply Output 15 VDC / 0.4 Amp

PT-1085

6W Power Supply Output 24 VDC / 0.25 Amp



15 Watt Switchmode Power Supply

Interchangeable AC pin. Supplied with UK / Europe / USA / Australia type noses. 90-264VAC Input range. Output via 2.1x5.5x12mm DC plug on 1.8 metre cable.

PT-1020

15W Power Supply Output 5 VDC / 2.5 Amp

PT-1025

15W Power Supply Output 6 VDC / 2.5 Amp

PT-1030

15W Power Supply Output 7.5 VDC / 2 Amp

PT-1035

15W Power Supply Output 9 VDC / 1.67 Amp

PT-1040

15W Power Supply Output 12 VDC / 1.25 Amp

PT-1045

15W Power Supply Output 15 VDC / 1 Amp

PT-1050

15W Power Supply Output 24 VDC / 0.63 Amp



24 Watt UK Plug Top Switchmode Power Supply.

90-264VAC Input range. Output via either 2.1x5.5x12mm DC plug or 2.5x5.5x12mm DC Plug on 1.8 metre cable.

PT-1090

24W UK Power Supply Output 12 VDC / 2 Amp 2.1mm Plug

PT-1095

24W UK Power Supply Output 12 VDC / 2 Amp 2.5mm Plug





5 Watt International USB Power Supply

Interchangeable AC pin. Supplied with UK / Europe / USA / Australia type noses. 90-264VAC Input range. Output 5 VDC 1 Amp via USB Socket.

PT-1015

5W USB Power Supply Output 5 VDC / 1 Amp



14 Watt UK USB Power Supply

90-264VAC Input range. Output 5 VDC 2.1 Amp via USB Socket.

PT-1005

14W USB UK Power Supply Output 5 VDC / 2.1 Amp



14 Watt International USB Power Supply

Interchangeable AC pin. Supplied with UK / Europe / USA / Australia type noses. 90-264VAC Input range. Output 5 VDC 2.1 Amp via USB Socket.

PT-1000

14W USB Power Supply Output 5 VDC / 2.1 Amp



5 Watt UK Micro USB Power Supply

90-264VAC Input range. Output 5 VDC 1 Amp via Micro USB. Plug on 1.8 metre cable.

PT-1010

5W Micro USB UK Power Supply Output 5 VDC / 1 Amp

Sub Miniature PCB Push Switches

SW-1200

2 Pole Latching Switch

SW-1220

2 Pole Momentary Switch

SW-1400

4 Pole Latching Switch

SW-1420

4 Pole Momentary Switch



PCB Mounted Push Switches

SW-0200

2 Pole Latching Switch

SW-0220

2 Pole Momentary Switch

SW-0400

4 Pole Latching Switch

SW-0420

4 Pole Momentary Switch



Non-Illuminated Rocker Switches

SW-2100

Single Pole Plain Rocker Switch SPST

SW-2120

Single Pole 1/0 Legend Rocker Switch SPST

SW-2200

Double Pole 1/0 Legend Rocker Switch DPST



Double Pole Rocker Switches with Neon Illumination

SW-2330

Double Pole Rocker Switch DPST Red

SW-2350

Double Pole Rocker Switch DPST Green

SW-2370

Double Pole Rocker Switch DPST Yellow





PCB Mount Push Mains Switches

SW-8011

Mains Power Switch PCB Mount with Bracket
Buttons for Push Switches



KB-5510

5mm Round Button for 2.8mm Shaft Black

Other colours are available - please contact us



KB-1510

8.8mm Round Button for 3.3mm Shaft Black



SW-7010

D6 SPST Switch Round Black

SW-7110

D6 SPST Switch Square Black

SW-7020

D6 SPST Switch Round White

SW-7120

D6 SPST Switch Square White

SW-7030

D6 SPST Switch Round Red

SW-7130

D6 SPST Switch Square Red

SW-7040

D6 SPST Switch Round Blue

SW-7140

D6 SPST Switch Square Blue

SW-7050

D6 SPST Switch Round Green

SW-7150

D6 SPST Switch Square Green

SW-7060

D6 SPST Switch Round Grey

SW-7160

D6 SPST Switch Square Grey

SW-7070

D6 SPST Switch Round Yellow

SW-7170

D6 SPST Switch Square Yellow



Tact Switches with through hole or surface mount terminals.

TS-0110

Tact Switch Surface Mount with Actuator Height 2.5mm

TS-0120

Tact Switch Surface Mount with Actuator Height 3.1mm

TS-0010

Tact Switch Right Angle PCB Mount

TS-0080

Tact Switch PCB Mount with Actuator Height 4.3mm

TS-0090

Tact Switch PCB Mount with Actuator Height 7.4mm

TDI have been supplying the UK electronics manufacturing and retail industries with quality components for more than 30 years.

If you can't find what you are looking for, please check with our sales team to see if its something we can find for you. We have suppliers around the world and are experienced in locating special parts for our customers.

Our philosophy has always been to offer great service, quality products and competitive prices. We don't run our business from a shiny new building with hundreds of staff driving expensive new cars - we like to keep our overheads low so that we can keep our prices low and we work hard to ensure that dealing with TDI is simple and straightforward for our customers.

A range of cables, connectors and accessories selected for the AV and Custom Install industries.

Contact us for a copy of the catalogue and Trade Price List.

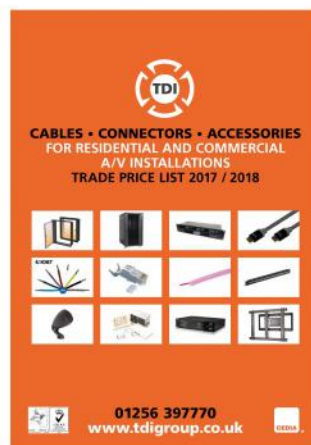

Also available from TDI :

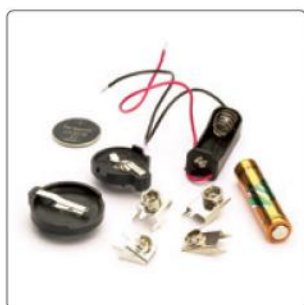

Batteries & Holders

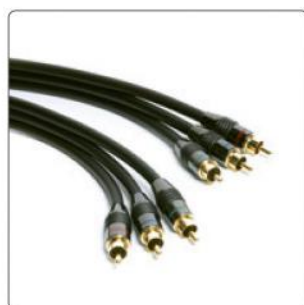

Phono Leads

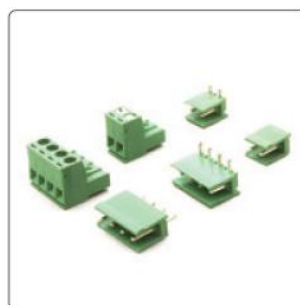

Screw Terminals



Single Pole Connectors



Hardware



Power Supplies



Switchcraft Switches



Dip Switches & Push Switches



TDI TREMIVER LIMITED

West Farm
Popham
Winchester
Hampshire
SO21 3BH
UK

01256 397770

info@tdigroup.co.uk

www.tdigroup.co.uk