

# UCLA **INVENTS**

*Driving Innovation to Market*



**OFFICE OF INTELLECTUAL PROPERTY**

Volume VI 2011

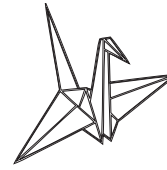
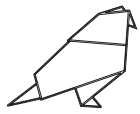

## CONTENTS

- 1 Letter From the Vice Provost**  
Creativity abounds at UCLA through new technologies, spurring new products, new companies, new industries.
- 2 To Market, To Market**  
The road from lab to marketplace can be short and straight, or long and full of detours.
- 6 Pioneer and Hometown Hero**  
After growing up in East L.A. and an internment camp, Paul Terasaki earned three UCLA degrees and revolutionized organ transplantation.
- 7 Through a Child's Eyes**  
A special index assesses children's reactions to trauma, using ideas and concepts they understand.
- 8 Turning to Technology**  
Advanced sensing detects chronic wounds such as bedsores very early, as underlying skin damage.
- 10 Band-Aid for the Brain**  
Physicians can use ultrathin sheets of a substance made from nickel and titanium throughout the vascular system.
- 11 Not All in One Basket**  
NeuroSigma's key to success is a portfolio of technologies at various stages of development.
- 12 Fixing a Broken Switch**  
This drug may "unstick" a mutant gene that can signal the spread of melanoma.
- 13 Cancer's Clues**  
Assessing the threat of lung cancer by measuring levels of blood proteins could spare some patients invasive procedures.
- 14 Atom by Atom**  
UCLA researchers are using quantum dots and nanowires to discover new materials and develop revolutionary devices.
- 15 The Business of Science**  
This program involves management, law and engineering students in the commercialization of UCLA technology.
- 16 Bridge to Success**  
As an undergraduate, Tanuj Thapliyal started a program to help students learn the path to commercialization.



**With the U.S. economy in a serious slump,**

President Obama and many others believe that the solution lies in the creation of new companies that generate jobs and manufacture products to export.

If so, then certainly

UCLA is doing its part. Creativity abounds on our campus as we develop a wide range of new technologies, spurring new products, new companies, even new industries.

This issue of UCLAInvents showcases some of these remarkable innovations. For example, in a number of cases, our faculty clinicians are parlaying their clinical concern over unsuccessful treatments for disease into new technologies that hold great promise. Multidisciplinary teams of engineers, nurses and physicians are collaborating to bring the wonders of wireless technologies to important new uses.

In the current economic climate, these entrepreneurs must be, and are, resourceful in finding funding. While the venture community may be shying away from early-stage investment, our creative faculty, students and researchers demonstrate that there are many sources of capital to commercialize UCLA's technology. These

include small business innovation grants, strategic partnerships with investors, and private resources. The persistence and determination of those who are spawning innovative startups reminds us of the resilience and tenacity of the American pioneers—the early builders of our nation. The articles in this issue also demonstrate that interest in innovation and creative enterprise exists across the lifespan—from students to emeriti faculty and distinguished senior alumni. Students increasingly participate in creating an entrepreneurial curriculum, developing novel courses to meet their needs. Across campus, our student leaders are bringing entrepreneurship training to a number of our professional schools to ensure access to this type of learning in many forms. Meanwhile, our faculty continue to invent technology while conducting basic, translational and clinical research. And our alumni and emeriti play a mentoring role, confirming that today's seedling companies can indeed grow up to be tomorrow's major employers.

Through all of these avenues, every day, UCLA is leading the way in rebuilding California and the nation.

*Kathryn Atchison, D.D.S., M.P.H.*

# To Market, To Market



**CHANG-JIN “CJ” KIM** has developed several micro-electro-mechanical-system (MEMS) courses since

joining the UCLA faculty in 1993. He has also established a MEMS Ph.D. major in the Mechanical & Aerospace Engineering Department. Directing the Micro and Nano Manufacturing Laboratory, he is a founding member of the California NanoSystems Institute (CNSI) at UCLA.

His research interests are in MEMS and nanotechnology, including design and fabrication of micro/nano structures, actuators and systems, with a focus on the use of surface tension. An ASME Fellow, he received the Graduate Research Excellence Award from Iowa State University, the 1995 TRW Outstanding Young Teacher Award, the 1997 NSF Career Award, the 2002 ALA Achievement Award and the 2008 Samuelli Outstanding Teaching Award.

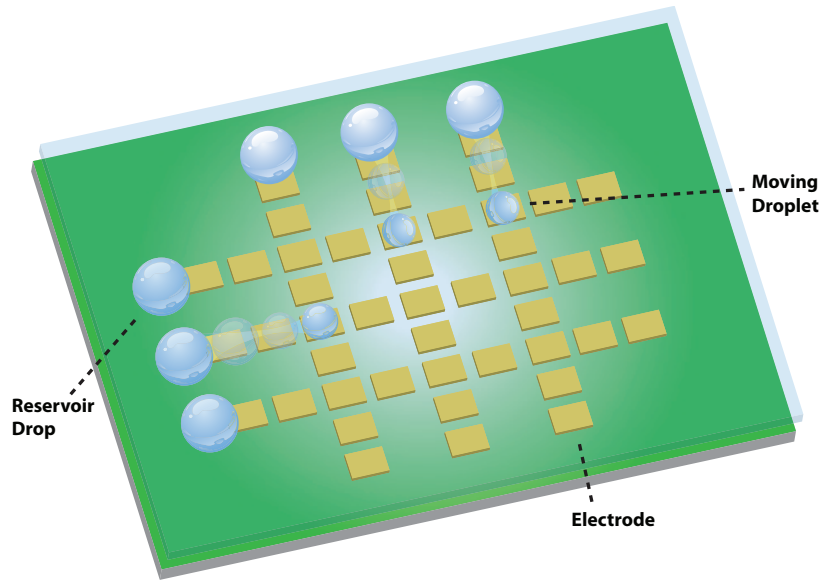

Water and other fluids, if broken down into small enough droplets, can be moved with the application of electrical signals. Consuming little power and requiring no pumps or valves, this microfluidic technology is attractive to many applications, ranging from biochemical analyzers to optical displays.

**Just as there is no simple formula for innovation and discovery**, there is no single road map that charts the successful journey from laboratory to marketplace. For some researchers, the route is short and straightforward. For others, however, it is long and circuitous, with plenty of detours and construction zones along the way.

In the university setting, where federal grants are the lifeblood of so many research projects, aspiring entrepreneurs often turn first to federal SBIR (Small Business Innovation Research) and STTR (Small Business Technology Transfer) grants to fund their commercialization efforts. Combined with personal funds and a bit of sweat equity, these grants allow faculty members to “bootstrap” their business, building from the ground up while retaining control over their own destiny. These grants are also attractive because they represent nondiluting equity.

“It’s money that comes in, but nobody is asking for a piece of the company,” notes Kathryn Atchison, vice provost, Intellectual Property and Industry Relations. “The federal government doesn’t say, we’ll give you this SBIR but in return we want some equity from your company. So it’s almost like having access to free money.”

Chang-Jin “CJ” Kim took advantage of SBIR grants when he and an associate founded Core Microsolutions in 2002.

## Core Microsolutions

The notion of moving water and other fluids around without the use of pumps, pipes, valves and other familiar components might seem unimaginable to most of us. But if the fluids are broken down into small enough droplets—on the order of 1 millimeter in diameter—they can be moved or manipulated with the application of electrical signals.

Having discovered that this was possible in 1997, Kim, professor of mechanical and aerospace engineering and member of the California NanoSystems Institute at UCLA, has spent much of the last decade developing new technologies based on the phenomenon.

In 2002, Kim and one of his graduate students, Peter-Patrick de Guzman, applied for a Small Business Innovation Research (SBIR) grant and used the money to found Core Microsolutions. They planned first to develop a line of optical switches based on Kim’s technology. These switches,

intended for use in fiber-optic systems, used water droplets to replace the mirrors and mechanical assemblies that are ordinarily used to direct light pulses to their destination. Kim planned to use the revenue generated through the sale of these switches to finance the development of biomedical instruments.

“In the long run, I thought biomedical applications should be the major focus of the company,” Kim recalls. “But at that time, optical applications were abundant, and optical applications were much easier to design and bring to market. So my strategy was to start the company with optical applications first, because the market was there.”

But then the dot-com bust hit, and the market for optical switches collapsed. With the SBIR grant in hand and the company already formed, however, Kim had no choice but to move forward without the income stream he had anticipated. Fortunately, he and his associates were successful in obtaining a succession of SBIR grants. The grant money, supplemented with personal funds, allowed the two researchers to “bootstrap” the company and sustain it while they developed the biomedical applications that had originally motivated them to found the company.

In 2009, the founders sold the company to North Carolina-based Advanced Liquid Logic. Kim looks back on the experience with mixed feelings.

“Having a company is exciting,” he says. “It’s all about taking the technology you have envisioned and developed, and eventually seeing it become a product. That’s exciting. But as faculty members we may be very good at doing research, but we have never learned how to do business. There are a lot of human relationships involved, and human relationships are the source of the most frustration. I learned that people can be very different when there’s money involved.”

Still, Kim’s groundbreaking research continues to attract the attention of colleagues and entrepreneurs from around the world, and he fully expects to start another company in one or two years. The lessons he learned at Core Microsystems, he believes, will serve him well as he contemplates the opportunities ahead.

Although SBIRs and STTRs represent an appealing source of funding, other options are available. Angel investment is one of the more popular alternatives. Angels bring not only funding,

but they also come with their own considerable expertise, experience and business connections. Unlike venture capitalists, who tend to focus on milestones and deliverables, angels often roll up their sleeves and play an active role in getting the company up and on its feet.

NeuroSigma, which is featured in the “Startups” section of this publication, is a good example of a company that was able to get on its feet thanks to the backing of angel investor Lodwick Cook.

Another source of funding that is often overlooked is institutional investment. When a large company takes an interest in a new technology, there are many advantages for the researcher. The organization’s deep pockets, of course, are a major attraction. But there are other, less obvious, benefits.

“Someone is already envisioning your market,” notes Atchison. “So it’s not like the company is starting from scratch and has to find a market. The market’s already there. It’s built in through the corporate sponsor. And the sponsor can provide insight through its own experiences with this market. They’ve got a good sense of how the product will be received, what the need for it is, who is the likely user.”

Wenyuan Shi chose this route to market when he developed a new and novel approach to fighting tooth decay.

### C3 Jian

With the advent of modern antibiotics, killing bacteria is easy. Unfortunately, most antibiotics are indiscriminate killers, destroying the benign and even helpful bacteria along with the bad.

“Ninety percent of all bacteria in our bodies are not harmful,” says Wenyuan Shi, professor of oral biology and medicine at the UCLA School of Dentistry. “We rely on bacteria, for example, to do our digestion for us. If you take a lot of antibiotics for a toothache, you wind up upsetting a lot of other normal flora.”

Shi’s answer to this problem was the development of an antimicrobial agent that targets specific bacteria, destroying the “bad guys” while allowing the safe and helpful microbes to go about their business. The technology employs a biological homing device derived from molecules that the targeted bacteria use to communicate with each other. When these “smart bombs” reach their



**WENYUAN SHI** is department chair and professor of oral biology at the UCLA School of Dentistry; professor of microbiology

and molecular genetics at the David Geffen School of Medicine; and the founding scientist and chairman of the scientific advisory board of C3 Jian Inc.

His laboratory has been using multidisciplinary approaches to the study of oral microbial pathogenesis, with a specific focus on microbial biofilm, interspecies interaction and signal transduction. The lab also is actively involved in developing next-generation diagnostic and therapeutic tools to fight oral microbial infections, including instant chair-side detection of oral pathogens and peptide-based targeted antimicrobial therapeutics. He is co-author and co-inventor of more than 130 scientific articles and patents.

continued on page 4



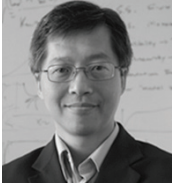

**JAMES LIAO** is a chancellor's professor, vice chair of the Chemical and Biomolecular Engineering Department at

the UCLA Henry Samueli School of Engineering and Applied Science, and a member of the California NanoSystems Institute at UCLA. His research focuses on metabolic genomics in microbial and human systems, as well as the development of more efficient biofuels.

In 2002, he was named fellow of the American Institute for Medical and Biological Engineering. He has received many awards, including the Presidential Green Chemistry Challenge Award in 2010 from the U.S. Environmental Protection Agency for his development of technology to convert carbon dioxide into alternative fuel.

targets, they deliver a destructive peptide that disrupts the cell membrane.

"So while the bacteria thinks it is signaling," explains Shi, "it is actually calling in the bomb that will destroy it."

Shi published a paper that described this new, selective approach to combating tooth decay, and it attracted the interest of executives at Delta Dental, an association of 39 independent member companies that have come together to form the largest dental benefits carrier in the United States. They agreed to underwrite his research and, encouraged by the results, they made the initial investment that allowed Shi to found a company to further develop and market the technology. That company—C3 Jian—is now developing a mouth rinse and diagnostic tool based on his technology. Targeted initially for use with juvenile patients, the product is currently going through the FDA approval process.

Because it is a "platform" technology, Shi is confident that this technique can be adapted for use in a wide variety of medical applications.

"For the moment, we are focusing on the tooth decay application," he says. "But in the long run, this technology could be applied to any part of the

body that has bacteria. And almost every part of our bodies has bacteria."

Delta Dental remains the major stockholder, but C3 Jian stands as an independent company. Shi, who served as Chief Scientific Consultant when the company was organized, has taken a partial leave of absence from his duties at UCLA to serve as a part-time Chief Scientific Officer. This, he says, is indicative of the support he has received from UCLA.

"When it comes to commercializing the school's intellectual property," he says, "the university leadership understands the importance of getting this done. They have been very supportive. We could not have come this far without university support."

Compared to the Bay Area, Los Angeles is not known for having a large and active community of venture capitalists. Still, venture capital is available, and it represents yet another source of funding for startups.

"Venture capitalists are not necessarily as helpful as angels," says Atchison. "They want to get a return on their investment in a specific time frame. So they tend to be more interested in making sure that you have your monthly board meetings, that you're staying on top of your deliverables and your milestones. Still, I think people should be open to all sources of money."

Gevo, Inc., a company that has licensed James Liao's technology for producing the biofuel isobutanol from sugar, used venture capital to lay the groundwork for a successful IPO in 2011.

#### Gevo, Inc.

In the world of biofuels, ethanol might well be considered the reigning superstar. Better known, perhaps, as alcohol, this simple carbon compound is plentiful—being derived from the fermentation of sugars in such common crops as corn, potatoes and sugar cane. Unfortunately, every drop of ethanol that goes into a gallon of gasoline represents biomass that cannot be utilized in food production.

The C3 Jian technology employs the use of an antimicrobial agent that utilizes bacterial extracellular signaling molecules to selectively target harmful, pathogenic bacteria while preserving normal and beneficial bacteria.



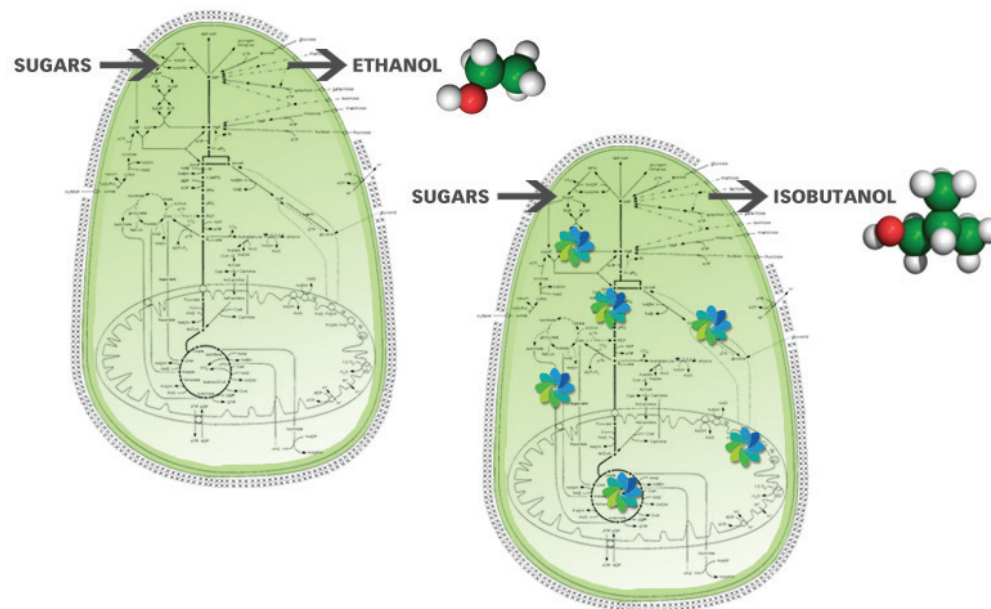

Gevo is currently using Liao's technology in a process that employs genetically modified yeast to convert sugar into isobutanol.

And this simple fact is reflected in rising food prices around the world.

Because of ethanol's limitations, James Liao, Chancellor's Professor of Chemical and Biomolecular Engineering at the UCLA Henry Samueli School of Engineering and Applied Science, believes it is time to end our dependence on not only fossil fuels, but ethanol as well. According to Liao, isobutanol is a superior alternative, and he and his colleagues are developing technologies that promise to make large-scale production of isobutanol practical.

"Isobutanol is a four-carbon alcohol that has a higher energy content than ethanol," explains Liao. "And significantly, it has chemical properties that are compatible with the existing energy infrastructure. It can be shipped using our current pipelines. And it can be used in all kinds of ratios in internal combustion engines without modifications."

Liao's technology enables him to genetically alter certain strains of microorganisms, inducing them to convert sugar into isobutanol.

"We do a surgical change in the bacterial chromosome," he elaborates. "We cut and paste DNA in and out of the bacterial chromosome. We can move the DNA in and out of the cell very precisely. Therefore, we can reprogram the chemical reaction sequence in the bacteria."

The yields are high, which is important when working with a relatively expensive commodity like sugar. But Liao has demonstrated that it is also possible to produce isobutanol from both cellulose and carbon dioxide. In the near-term, he believes, the ability to convert cellulose to isobutanol will alleviate many of the problems associated with ethanol.

"Cellulose is better because it's cheaper," he explains. "The

ultimate goal is to use cellulose to convert to fuel. Sugar can be a food. Sugar is only an intermediate-term solution. Cellulose is the long-term solution."

Although the technology for converting cellulose to isobutanol is still in the development stage, UCLA has licensed Liao's sugar-to-isobutanol technology to Gevo, Inc., a high-tech startup based in Englewood, Colorado. The company, which went public with an IPO in February 2011, is currently using Liao's technology as the basis for a process that produces isobutanol using genetically altered yeast.

Having worked in the fields of metabolic engineering and synthetic biology for 20 years, Liao is confident that his current research will result in a variety of breakthroughs in the development of clean energy alternatives.

"It is time to focus on the energy issue," he says. "Four or five years ago, we decided to align our efforts to energy problems. And today, we are developing multiple technologies, addressing multiple problems, and developing ways to use a wider range of raw materials that will ultimately lead to the production of more efficient biofuels."

As these examples illustrate, the important thing is to remain flexible and seize any opportunity that presents itself.

"A big part of what's required is creativity," explains Atchison. "People shouldn't be looking at only one route. They need to be open. They need to explore all of their options for funding. And they need to be able to say, 'If this route isn't taking me anywhere, OK, I'm going to take a different route.'" The three companies highlighted in this section and elsewhere in this year's edition of UCLAInvents represent different routes to commercialization that have been successful for startups that have come out of UCLA technologies.

## Pioneer and Hometown Hero

**In the mid-1960s, Paul Terasaki and his colleagues at UCLA** developed the first reliable test for typing human tissue. It was a breakthrough: This test made it possible for the first time to match potential organ donors with recipients. And without it, the organ transplants that we now take for granted today would never have been possible.

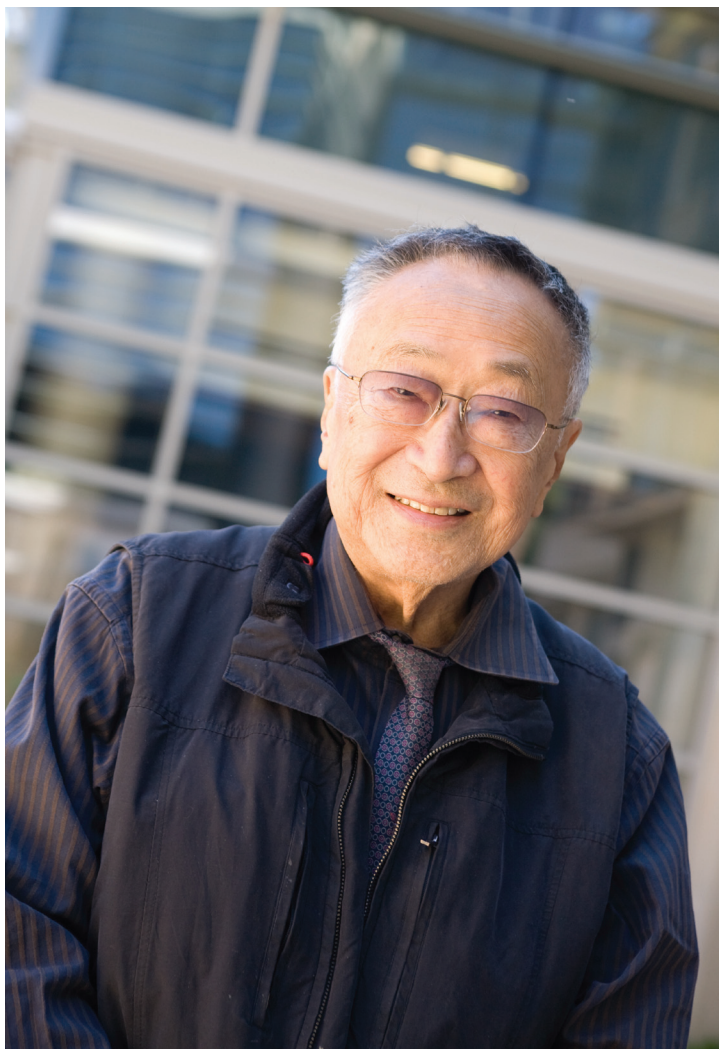

Paul Terasaki, Ph.D.

Terasaki was born in 1929 to an immigrant family in the Boyle Heights section of Los Angeles. After spending part of World War II in an internment camp, the family eventually returned to Los Angeles. Terasaki then enrolled at UCLA and worked his way through school, earning a bachelor's degree, a master's degree and a Ph.D. in the process. Following a year of postdoctoral work in London, Terasaki returned to Los Angeles and UCLA. The city and the university have been home ever since.

In 1984, Terasaki and seven former students took their tissue-typing technology into the marketplace with the founding of One Lambda, a company that is still based in West Los Angeles.

"For 13 years, we had been selling the tissue-typing trays from our lab at UCLA," Terasaki recalls. "There was no other source for these trays, and we were selling them for \$10 a tray."

Eventually, a group of potential competitors complained that UCLA was in effect running a business out of a research lab. So Terasaki went to university officials and received permission to take a management position in the newly formed One Lambda.

"I did not have a patent because the university patent application was not approved," says Terasaki. "The university also said they did not believe the idea had commercial potential. Because there was no university patent to license, they said if I wanted to commercialize the technology and start a company outside I could go ahead. So seven of my technicians left UCLA and started this company in West LA. The company paid UCLA half a million dollars for the customer list."

Although he remained on the faculty at UCLA until 1999, Terasaki also served as chairman of the board at One Lambda, a position he holds to this day. And even in retirement, he remains committed to his research, having founded the Terasaki Foundation Laboratory, where Terasaki and his colleagues continue to refine our understanding of transplants and tissue typing. Despite the great strides that have been made since he developed his first test in 1964, Terasaki notes that much work remains to be done.

"Transplants are now 95 percent successful at one year," he notes. "But at 10 years it's 50 percent. And this problem has been with us for the last 40 years. We believe that we now know the solution: that antibodies to the human leukocyte antigen—HLA—are the cause of chronic rejection."

After a lifetime of achieving the seemingly impossible, Terasaki sees no reason to stop now.





# Through a Child's Eyes



**ALAN M. STEINBERG** is an associate director of the National Center for Child Traumatic Stress and a recognized

authority in public mental health approaches to post-disaster recovery programs for children and families. He has extensive experience in assisting community and school-based programs in instituting rigorous assessment, treatment and outcome protocols after natural disasters.

He has worked extensively with the Centers for Disease Control and Prevention to enhance community leadership in promoting national preparedness and response to terrorism and disaster. He has served as a long-term consultant to UNICEF and has worked in Turkey, Bosnia-Herzegovina, Greece, Nicaragua and Taiwan to assist in the development and implementation of post-war and post-disaster mental health recovery programs.

**When disaster strikes**, one of the first concerns is always the safety of the children who might have been caught in the mayhem. But after the crisis passes, it is difficult to assess the long-term effect of the trauma on the children involved. All too often, they lack the words and conceptual framework to express their feelings in ways that adults can understand.

In an effort to simplify the difficult process of diagnosing post traumatic stress disorder (PTSD) in children and adolescents, Alan Steinberg, Robert Pynoos and their colleagues at the National Center for Child Traumatic Stress at UCLA have created the UCLA PTSD Index for DSM-IV (UPID). Designed to provide information regarding trauma exposure and PTSD symptoms, the Index is a semistructured interview that assesses reactions to trauma in both school-age children and adolescents.

Each of the 48 items on the questionnaire requires a numerical answer in the range of 0 to 4. The child's responses generate an overall score, as well as scores in the three categories of PTSD symptoms—re-experiencing symptoms, avoidance symptoms and physiological symptoms. The instrument can be used to establish an initial diagnosis of PTSD and then, administered repeatedly over time, it can be used to assess the results of the intervention.

Most importantly, however, the questions are put to the children using ideas and concepts that make sense to them.

“You can't use the same questions that you'd ask an adult,” explains Steinberg, who serves as associate director of the UCLA Neuropsychiatric Institute. “For example, one of the criteria for PTSD is a numbing of responsiveness. But you can't ask a 7-year-old, ‘Do you feel numb?’ Or another of the criteria is a restricted range of affect. Your range of affect is restricted in the sense that your lows aren't as low as they usually go and your highs aren't as high. So with a kid you ask, ‘When something good happens do you have trouble feeling good?’ Kids like words like good and bad.”

The university, which maintains the copyright for the Index, has negotiated agreements with mental health and human services organizations around the world, allowing them to use the instrument and translate it into languages ranging from Spanish and French to Japanese and Serbo-Croatian. Steinberg is particularly happy to note that the Los Angeles County Department of Mental Health recently adopted the Index as its primary instrument for measuring childhood PTSD at mental health clinics throughout the county.

“It's very gratifying to see that we're helping out here in our own city,” he says. “It shows that we're not just in some ivory tower here at the university. We're supposed to benefit our neighbors. And we're trying to do that, not just in the local community but statewide and nationally.”



# Turning to Technology



**BARBARA BATES-JENSEN** is an associate professor of nursing and medicine at the UCLA School of Nursing and the

David Geffen School of Medicine, division of geriatrics. Her research is focused on improving the quality of pressure-ulcer and related care for vulnerable populations, translating and maintaining effective research interventions into daily nursing practice.

In 2010, she was inducted as a fellow into the American Academy of Nursing. She received the 2010 Journal of Wound Ostomy Continence Nursing Research Award, the 2011 Founder's Award for outstanding contributions to wound care from the Symposium on Advanced Wound Care, and the 2011 Association for the Advancement of Wound Care Achievement Award.



Development of a wireless health network, using wireless sensors and systems, allows individuals to be monitored by health professionals at all times to ensure success of treatment and validate treatment outcomes. Data transmission from wearable sensor devices to smartphones and central health systems allows patients to receive medical feedback from clinicians or caregivers, even miles away.

**Chronic wounds such as bedsores, diabetic foot ulcers and leg ulcers** associated with vascular disease constitute something of a silent epidemic in this country.

“The incidence rate of chronic wounds in the United States is higher than the incidence of cancer,” notes Barbara Bates-Jensen, associate professor at the UCLA School of Nursing. “And these wounds are a serious problem. If you have a diabetic foot ulcer, for example, your five-year survival rate is less than the five-year survival rate for a breast cancer patient or a prostate cancer patient.”

Chronic wounds can be prevented. But the current gold standard for early detection is a visual inspection of the skin. Besides being time consuming, a visual inspection only detects a problem sometime after the underlying damage has occurred, and the telltale redness associated with the damage is difficult to detect in dark-skinned people.

“So you have a whole population of individuals with dark skin tones for whom the gold standard is completely inadequate,” says Bates-Jensen.

Bates-Jensen—acknowledging freely that one of her persistent nicknames is “gadget gal”—started searching for a technological answer to the problem, and she found it at UCLA's Wireless Health Institute (WHI).

That answer, the SEM Scanner, is a device that uses advanced sensor technology to detect underlying skin damage in its early stages. Using wireless technology, that information can then be

transmitted to a physician, a wound center or a clinic—even miles away—where it can be acted on before the condition becomes a problem.

“Prevention is far cheaper than intervention,” says Bates-Jensen. “If you can prevent one wound from occurring, that's a significant cost savings overall.”

To a large extent, this statement describes the mission of the WHI.

WHI Co-Director William Kaiser traces the origins of the institute back to the mid-1990s when he began his pioneering work in the field of sensor networks. Using a combination of sensor and wireless communications technology, Kaiser and his associates believed they could gather meaningful data from virtually any device or individual anywhere in the world. And as the technology evolved, they became increasingly interested in how it could be used in biomedical applications.

This required a new way of looking at problems, one that emphasized an unprecedented degree of cooperation across both scientific and academic disciplines.

“We quickly realized that we needed to coordinate our activities across our entire campus,” recalls Kaiser. “So several years ago, we formed the Wireless Health Institute. It is campuswide and it involves individuals from medicine, from public health, from nursing and from engineering. And what ties all this together is the fact that wireless health offers for the first time an opportunity to monitor individuals at all times in their daily

environment and to ensure the success of treatment and to validate outcomes of treatment in the field.”

The SEM Scanner is a great example of how the WHI works. Bates-Jensen approached the researchers at the WHI and described a problem. Kaiser and his colleagues accepted the challenge and spent two years developing a technological solution that met the medical need as described by the nursing professional. Funding was provided by a group of investors who have since founded the company Bruin Biometrics. That company has licensed the technology and will market the scanner following a series of trials and studies being conducted with at-risk patient populations.

Ani Nahapetian, an assistant adjunct professor of computer science at UCLA, serves as an affiliated faculty member at the WHI. She is also a co-founder of Bruin Biometrics, where she currently serves as a technical advisor. She notes that in her experience this is not the way things are usually done.

“As a computer scientist,” explains Nahapetian, “you formulate computer science problems and you solve them using algorithms and approaches that are accepted as standards in the field. Then you look for application areas. With the Wireless Health Institute, what happens is quite the reverse. We start with real-life applications that come from the nursing, public health and medical fields, and then we go all the way to the computer science side. All along, there is an awareness that these are tools or systems that are going to be applied in the real world for real health applications. That is quite exciting.”

Another product currently under development at the WHI is a system dubbed the UCFit. This is an inexpensive device that is designed to help patients avoid the loss of muscle mass while they are confined to bed, whether in the hospital, a nursing facility or even at home.

“If a person is confined to bed,” explains Kaiser, “they typically lose muscle mass at a rate of about 1 percent per day for the first two weeks. That adds up to about one-sixth of their muscle mass. And they may already be frail. The UCFit system allows that individual in the hospital bed to regain or maintain a level of conditioning.”

Consisting of two bicycle-style pedals, the UCFit also has sensors that measure the speed of motion and the torque required to move the pedals. The patient’s energy expenditure can then be calculated. This information is sent wirelessly through a smartphone to a central computer server, where a

clinician or caregiver can use the data to monitor the patient’s progress. The device has already passed one safety test conducted at Ronald Reagan UCLA Medical Center, and a second phase of testing has begun.

Development of the UCFit system is being funded by a private company that eventually plans to license the technology and market the device.

Ani Nahapetian believes this emphasis on getting technology out of the laboratory and into the marketplace is a key motivating factor for everyone affiliated with the WHI.

“I think that this is an excellent place to be looking into the future,” she says. “There’s a satisfaction that you get not just from the science, but also the satisfaction that you’re helping improve the quality of people’s lives. It’s extremely exciting from my perspective because there’s a huge potential for advancing computer science by bridging it to another large field.”

William Kaiser agrees, and he notes that this emphasis on shepherding new technologies into the marketplace is a central part of the institute’s mission.

“Commercialization is a very strong motivating factor here,” he says. “We believe that enabling industry partners to work with us and for us to develop products on their behalf, that they can introduce rapidly, will lead to the largest impact in the shortest time.”



**WILLIAM KAISER** is a professor in the Electrical Engineering Department at UCLA, where he initiated

the distributed networked embedded sensor field via many large collaborative programs across several departments. These combined research activities led to the creation of programs within the Defense Advanced Research Projects Agency, the National Science Foundation, NASA and commercial technology corporations.

He has more than 100 publications, 100 invited presentations and 21 patents. He has received the Allied Signal Faculty Research Award, the Peter Mark Award of the American Vacuum Society, the NASA Medal for Exceptional Scientific Achievement, the Arch Colwell Best Paper Award of the Society of Automotive Engineers and two R&D 100 awards.



**ANI NAHAPETIAN** is an assistant adjunct professor with the UCLA Computer Science

Department. She received her Ph.D. and M.S. degrees in computer science and her B.S. in computer science and engineering from UCLA. She has been a visiting researcher at the Micrel Lab at the University of Bologna and is an affiliated faculty member at the UCLA Wireless Health Institute.

Her research interests include hardware security, wireless health systems and computer science education. She has more than 25 peer-reviewed publications in the areas of wireless health, embedded systems and hardware security.



# Band-Aid for the Brain



**GREG CARMAN** is a professor in the Mechanical and Aerospace Engineering Department at UCLA. His

research focuses on developing and understanding the combined electro-magneto-thermo-mechanical response of active material systems (smart structures), including biological applications.

He was named fellow of the American Society of Mechanical Engineers (ASME) in 2003, and his awards include the Best Paper Award from the Adaptive Structures Material Systems Committee of the ASME Aerospace Division in 1996, 2001 and 2007 and the ASME Adaptive Structures and Material Systems Prize in 2004. He also was a member of the Boeing team that won the American Helicopter Society Howard Hughes Award in 2009.

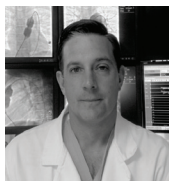

**DANIEL S. LEVI, M.D.** is presently a tenured associate professor on faculty at the Mattel Children's Hospital at

UCLA. His clinical subspecialty is interventional pediatric cardiac catheterization, and his research focuses on the design of new devices to help children with heart disease avoid surgery. He is head of Interventional Pediatric Cardiology at UCLA and director of Interventional Adult Congenital Cardiology.

Dr. Levi routinely performs transcatheter valve replacements, stent based procedures, valvuloplasties, angioplasties, and ASD, PDA and VSD closures at UCLA. The UCLA pediatric catheterization program has grown to over 500 cases per year. Dr. Levi is chair of the Congenital Program for SCAI and is active in both early and late stage development of new devices for children with congenital heart disease.



**Nitinol**—a material whose name is derived from an amalgamation of the words nickel, titanium and Naval Ordnance Laboratory—does not sound like the sort of substance you'd want to find anywhere near your body, let alone somewhere inside it. But as it turns out, Nitinol is strong, biologically inert, and it tends to “remember” its shape even after having been twisted or compressed. These properties make it a uniquely useful material in a variety of biomedical applications.

Greg Carman and his team of researchers at UCLA have dramatically increased the range of applications for Nitinol by developing a process that allows them to produce Nitinol in ultrathin sheets. At a thickness of only 5 to 6 microns—one-tenth the thickness of a normal human hair—these sheets are thin enough to cover medical devices that can reach virtually any location in the human vascular system.

To give some sense of what a breakthrough this is, Carman, a professor in UCLA's Mechanical & Aerospace Engineering Department and co-director of the Center of Advanced Surgical and Interventional Technologies (CASIT), uses the example of a brain aneurysm.

“To get to the aneurysm with a catheter, you have to go down a narrow, fairly tortuous highway in the neurovascular system,” he explains. “What you would like to do is put a Band-Aid over that aneurysm to prevent blood from flowing into it. But the problem is getting a Band-Aid device that is sufficiently small to navigate that narrow, tortuous highway. This is challenging, if not impossible, with current technology. With the development of our new thin film Nitinol, however, we can produce a Band-Aid device small enough to traverse that highway and patch that brain aneurysm, sort of like patching a flat tire.”

Carman's work was initially funded by the Air Force Office of Scientific Research and other

Department of Defense research offices, and was focused on nonmedical applications such as large, space-based antenna arrays. These arrays had to be large—on the order of 50 meters in diameter. So in order to get them into orbit, Carman and his team proposed using their fabrication technology to produce an antenna that could be packaged in a tube, launched in a standard launch vehicle, then deployed once in space.

When a student told Dan Levi about Carman's work, Levi immediately recognized that this same principle could be applied in medical applications, specifically to brain aneurysms.

“As soon as I met Dr. Carman, I saw a lot of vascular implications for his technology,” says Levi, who serves as co-director of the Diagnostic and Interventional Catheterization Program at the David Geffen School of Medicine at UCLA. “We realized that probably the ideal application would be using it to treat brain aneurysms.”

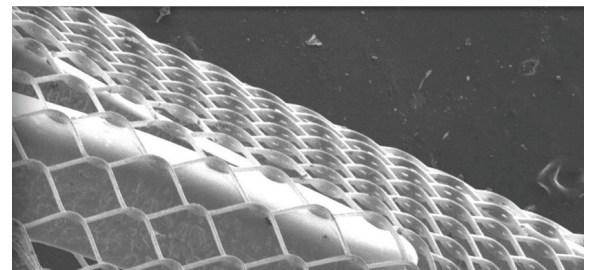

A hyperelastic thin film Nitinol (HE-TFN) covered stent has been shown to promote aneurysm occlusion by helping to divert blood flow from a brain aneurysm.

Levi and Carman called in Fernando Vinuela, professor of radiology at Ronald Reagan UCLA Medical Center and one of the world's acknowledged experts on treating brain aneurysms, and together they helped form a company now known as NSVascular Inc. The researchers have already completed a successful animal study and hope to begin work soon on a final prototype.



# Not All in One Basket

**Leon Ekchian knows a good idea** when he sees one. And that uncanny ability to identify promising technologies has sustained his career from his early days at Lockheed Martin through a series of successful high-tech startups.

“I was very much involved with that at Lockheed Martin, trying to identify promising technologies that could be commercialized,” he says. “And I realized early on that there’s an enormous opportunity for mining the technologies being developed here at UCLA.”

Interested in particular in the field of neuromodulation, Ekchian and angel investor Lodwick Cook formed the company NeuroSigma and set about licensing several promising technologies being developed by UCLA researchers. The first of these was a treatment for obesity based on a technique known as deep brain stimulation (DBS). The technique showed considerable promise in the long run, but Ekchian and Cook understood that if NeuroSigma was to survive, they needed to balance the company’s portfolio with technologies they could bring to market quickly.

“Deep Brain Stimulation is a fascinating and promising technology,” says Ekchian. “But the biggest challenge one faces with DBS is that it’s very invasive. And because it’s invasive, we understood that getting FDA approval could take a very long time.”

The search for technologies they could bring to market in the meantime led the two entrepreneurs to the work being done by UCLA researchers Chris DeGiorgio and Ian Cook. DeGiorgio and Cook’s research focused on the trigeminal nerve, a nerve that emerges just below the brow and runs below the surface of the skin to the mouth and other sensitive areas of the face.

“The trigeminal nerve projects to some areas of the brain that are important for regulating mood and emotion,” explains Dr. Cook, who is a professor-in-residence in the Department of Psychiatry and Biobehavioral Sciences at the David Geffen School of Medicine.

DeGiorgio had successfully used electrical stimulation of the trigeminal nerve (TNS) to control seizures in patients suffering from epilepsy. He suggested to Dr. Cook that the approach might work for treating depression as well. The results thus far have been promising.

Because stimulation of this nerve can be accomplished using conductive pads applied to the

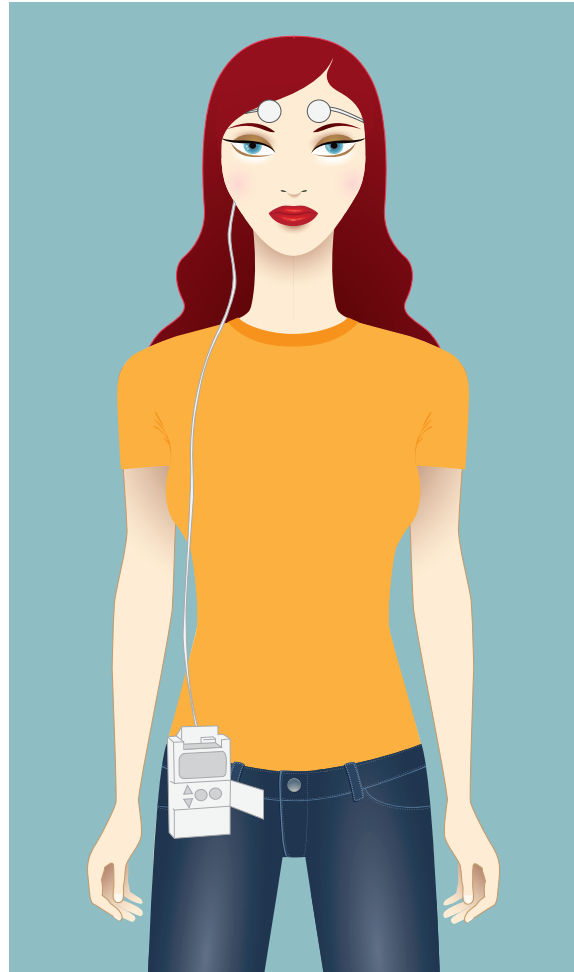

Mild electrical stimulation of the trigeminal nerve using a neurostimulator connected to noninvasive conductive pads placed on the forehead has been shown to control seizures in patients suffering from epilepsy.

surface of the skin or by microelectrodes placed adjacent to the nerve just below the skin’s surface, these technologies are minimally invasive and face fewer regulatory hurdles than DBS technology. This fits well within Ekchian’s long-term strategy for NeuroSigma.

“We are focused on developing a portfolio of technologies instead of a single technology,” he says. “We want some things that are in the early stage, and we want to have some things that are further along in terms of development and clinical trials. And right now we have both with these two platforms—DBS and TNS.”



**IAN COOK** is a professor-in-residence of psychiatry and biobehavioral sciences in the David Geffen School of

Medicine and director of the UCLA Depression Research & Clinic Program. He holds the Joanne and George Miller and Family Endowed Chair in Depression Research at the UCLA Brain Research Institute.

His research focuses on the development of methods to use existing treatments more effectively, such as the discovery and refinement of biomarkers that can guide treatment selection, and the development of new treatments for psychiatric conditions, including innovative brain stimulation and neuromodulation methods. He received his bachelor’s degree from Princeton University and his medical degree from the Yale University School of Medicine. He is a distinguished fellow of the American Psychiatric Association.

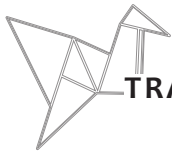

# Fixing a Broken Switch



**ANTONI RIBAS** is associate professor of medicine, surgery, and molecular and medical pharmacology

at UCLA. He was trained at the University of Barcelona, Spain, with postdoctoral research and clinical fellowship at UCLA. He is the director of the Tumor Immunology Program at the UCLA Jonsson Comprehensive Cancer Center, a permanent committee member of the National Cancer Institute's grant review panels and an elected member of the American Society of Clinical Investigation.

A physician-scientist, he conducts laboratory and clinical research focused on malignant melanoma, including adoptive cell transfer with T cell receptor engineered lymphocytes, anti-CTLA4 antibodies, targeted therapies for melanoma oncogenes and nanoparticle-siRNA.



A mutation in the BRAF gene, which plays a role in the signaling pathway important for regulating cell growth, is found in 50 percent of melanomas. BRAF mutations can leave the gene constantly active, altering the proper function of this pathway.

**Melanoma is a form of skin cancer** that, after it has metastasized, is virtually untreatable. In 2002, however, researchers found that 50 percent of melanomas have a mutation in a gene called BRAF. This gene is located in an important signaling pathway that is believed to regulate cell growth. When the mutation occurs, BRAF is like a switch stuck in the “on” position.

“Instead of switching on or off depending on the needs of the cell, it’s stuck in the ‘on’ position,” explains Antoni Ribas, director of the JCCC Tumor Immunology Program at UCLA’s David Geffen School of Medicine. “This means the BRAF gene functions as a cancer driver gene.”

Vemurafenib (PLX4032), a drug candidate currently being tested in clinical trials by Berkeley-based Plexikon Inc., in partnership with Roche-Genentech, might well be the key to “unsticking”

this faulty switch.

When Ribas and his colleagues first learned that PLX4032 was going into these trials, they contacted Plexikon and expressed their desire to participate in the Phase One testing.

“We believed that it might be beneficial for our patients if we could participate in the early stages of the testing,” Ribas says. “But we also wanted to understand what the drug is doing, using our own panel of melanoma cell lines that we had established and had been studying for several years.”

Working through the Office of Intellectual Property, Ribas and his colleagues negotiated a material transfer agreement (MTA) with Plexikon. This agreement allowed the researchers at UCLA to use the drug from Plexikon for their experiments, while determining which party would own any intellectual property resulting from the experiments. According to Plexikon President Kathleen Sereda Glaub, arrangements like this produce tangible benefits for both parties.

“We get feedback from their research and from key opinion leaders in the field,” she explains. “Dr. Ribas is a good example of a thought leader in melanoma research. We didn’t know at the time that we started our relationship that we had a drug that we could eventually bring to market. But if we were able to determine that we did, having Toni involved as a key opinion leader would be really important to the ongoing progress of clinical trials.”

At the same time, Ribas and his colleagues were able to advance their own research and publish their findings. A key paper—based on work done in collaboration with Roger Lo, assistant professor of dermatology at UCLA—appeared in the journal *Nature*. The current focus of their research, according to Ribas, is an attempt to understand the mechanisms by which cancer cells develop resistance to treatment.

“We know now that PLX4032 works in patients who have this particular mutation,” says Ribas. “The next step is understanding how the cancer cell overcomes the PLX4032 blockage and finding a way to disrupt these mechanisms. That will allow us to formulate even more effective drugs in the future.”

Through a series of new MTAs, Ribas and his colleagues continue their search for compounds that will complement PLX4032, hoping to develop new treatments for this deadly form of cancer.

# Cancer's Clues

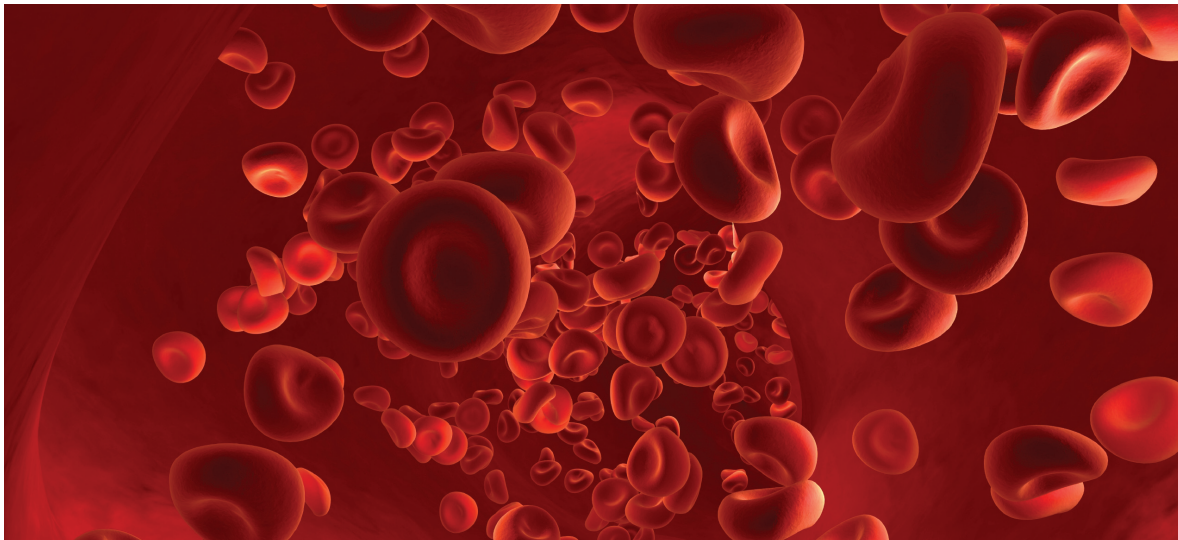

A blood test that measures the level of certain proteins in the blood, particularly those associated with lung cancer, may help to earlier diagnose and treat patients with the disease.

**With early detection**, the odds of effective cancer treatment increase tremendously. Unfortunately, early detection is difficult in many forms of cancer. Undiagnosed patients go untreated, claiming lives that might otherwise have been saved.

Lung cancer is notoriously difficult to detect in its early stages, and Steven Dubinett has dedicated much of his research to finding new ways to diagnose and understand this deadly form of cancer.

“Lung cancer is the leading cause of cancer death in the world,” says Dubinett. “Achieving a better understanding of inflammation in the context of lung cancer development will enable us to both design new ways to detect lung cancer earlier, and treat it in new and more effective ways.”

Currently serving as director of UCLA’s Clinical and Translational Science Institute (CTSI) and associate vice chancellor for translational research, Dubinett is advancing his crusade against lung cancer on a number of fronts. Among the most promising is a blood test, or marker panel, for proteins that are commonly associated with lung cancer.

Based on a recently published landmark study led by UCLA professor Denise Aberle, the National Lung Screening Trial determined that CT Scans could reduce lung cancer mortality by 20 percent in high-risk individuals.

“If CT scan abnormalities are detected,”

Dubinett says, “it’s not always clear whether or not they’re cancer. So the clinicians are left with the decision of how to deal with imaging studies that may, or may not, represent cancer.”

Rather than force patients to undergo invasive procedures and biopsies, Dubinett’s test would allow clinicians to assess the cancer threat by measuring the levels of certain proteins in the patient’s blood. The challenge, he notes, has been identifying the proteins specifically associated with lung cancer.

“Some of the inflammatory proteins that are exaggerated in the context of lung cancer are also present in the lungs and peripheral blood of patients who suffer from emphysema and chronic lung diseases that result from smoking,” explains Dubinett. “Therefore, it takes a lot of time, a lot of patients, and a lot of work to actually identify those proteins that are associated with early cancer development. And it is very important to evaluate patients in the clinical situation in which the tests will actually be utilized.”

Dubinett and his colleagues are currently attempting to narrow the number of markers in the panel in order to make the test more clinically useful. And supported in part by funding by the National Cancer Institute Early Detection Research Network, they are also evaluating the utility of the test in larger patient populations.



**STEVEN DUBINETT** is program director of the Clinical and Translational Science Institute and associate vice chancellor for translational

science at UCLA. He is chief of the Division of Pulmonary and Critical Care Medicine and director of the Jonsson Comprehensive Cancer Center Lung Cancer Research Program. He holds joint faculty appointments in medicine, pathology and laboratory medicine, and molecular and medical pharmacology.

At UCLA since 1988, he is a member of the Institute of Molecular Medicine, the Molecular Biology Institute and the California NanoSystems Institute. Building on original discoveries relevant to inflammation in the pathogenesis of lung cancer, he has developed a translational research program that now employs these laboratory-based discoveries in the translational research and clinical environment.



## Atom by Atom



**DIANA HUFFAKER** is a professor in the Electrical Engineering Department, director of the Integrated

NanoMaterials Core Lab at the California NanoSystems Institute, and director and principal investigator for the National Science Foundation Integrative Graduate Education Research Traineeship on Clean Energy for Green Industry at UCLA. Her research interests cover nanodot-based optoelectronic devices, including III-V/Si photonics, lasers, single-photon emitters, III-V nanotransistors, solar cells and electronic characterization of biomaterials.

In 2008, she was named a National Security Science and Engineering Faculty Fellow by the Department of Defense and a fellow of the Institute of Electrical and Electronics Engineers for development of optoelectronic materials and processing. In 2010, she received the Nanotechnology Innovation Award from SPIE.

**The ability to synthesize new, nanoscale materials**—atom-by-atom—is the foundation of nanotechnology. And at UCLA, Diana Huffaker and her research group are working hard to find new solutions to the world’s energy needs by using nanotechnology to harvest energy one atom at a time.

“At a basic level, nanotechnology typically involves manipulation of a small number of atoms and exploiting the new atomic arrangement,” explains Huffaker, who serves as director of the Integrated NanoMaterials Core Lab (INML) at UCLA’s California NanoSystems Institute. “At the nano level, materials have a much larger surface-to-volume ratio, so they interact with electricity and light in a very different way. Furthermore, they are more reactive than larger particles. And this opens up new areas of study merging chemistry, physics and biology.”

Huffaker’s laboratory specializes in quantum dots and nanowires—tiny, energy-efficient semiconductors. The researchers are particularly interested in the interaction between organic and inorganic matter for new materials discovery and revolutionary device development.

“This approach to research results in highly interdisciplinary, collaborative work,” notes Huffaker. “The research environment within CNSI has been very rich in this respect, as many extremely talented professors from across campus really enjoy working together to solve important societal problems.”

Huffaker’s interest in nanotechnology dates back to her days as a postdoctoral student at the University of Texas, where she first encountered quantum dots. Today, using both quantum dots

and nanowires, Huffaker is synthesizing materials using assembly methods that she believes can be incorporated into new generations of solar cells. If she and her colleagues are successful, these cells will be able harness the energy of the sun far more efficiently than has heretofore been possible.

“We’ve got a couple of patented processes,” she says, “that will perhaps allow us to create very high efficiency, low-cost, flexible, large-area solar cells. That’s one of the main thrusts of our work right now.”

In addition to her work at CNSI, Huffaker also serves as a principle investigator and director of UCLA’s Integrative Graduate Education Research Traineeship (IGERT) on Clean Energy for Green Industry. Funded by the National Science Foundation and the Economic Recovery Act, the IGERT at UCLA is a three-year, cross-disciplinary fellowship program focused on developing future leaders in environmental energy through integrated research and coursework in the science, business and policies of clean technology.

“The NSF sponsors IGERTs all around the country,” explains Huffaker. “Some are focused on environmental studies, others on biology and medical research and so on. Ours happens to study clean energy because we have a lot of professors here at UCLA who are already doing research in these areas. So the IGERT serves as a way to centralize these efforts and bring in money to support students.”

Ending the world’s reliance on fossil fuels is no small challenge. But Huffaker’s work in nanotechnology might well lead to the breakthroughs that will make it possible to finally achieve that goal.

The development of new nanoscale materials through atom manipulation and atomic arrangement can be incorporated into new generations of solar cells that can harness the sun’s energy with higher efficiency.





# The Business of Science



**ARASH SAFAEI** is a senior research scientist and business development professional with more than 10 years experience

in biotechnology research. He leads and contributes to cross-functional teams. With extensive knowledge and hands-on experience with bench-top and small animal experiments, his quantitative and qualitative research has led to four peer-reviewed publications and four scientific presentations.

He received his Ph.D. in molecular and medical pharmacology from UCLA in 2007 and expects to receive his M.B.A. from the UCLA Anderson School of Management in 2012.

**Arash Safaei** comes from a long line of entrepreneurs. Business, he says, is in his blood.

It is not surprising then, that after earning his Ph.D. in molecular and medical pharmacology, Safaei left the laboratory to take a job in the private sector.

“I had a good sense of what occurs at the bench side and developed a passion not only for the science but for bringing therapeutics to market,” he recalls. “So I went out into the business world and worked as a business development scientist for almost two years.”

After getting this first taste of life in the business world, Safaei returned to UCLA to get his MBA. And in the 2009-2010 school year, he discovered a program that dovetailed perfectly with his twin passions for science and business. Having completed the program himself, Safaei returned to serve as a teaching assistant in 2010-2011, the second year the program was offered.

Sponsored by the Anderson School of Management and co-offered through the Law School, the Technology and Innovation Partners Program (TIPP) gives management, law school, and science and engineering students an opportunity to participate in the commercialization of technology actually being developed at UCLA. The program combines classroom learning, seminars and feasibility studies that consider the technical, legal, market and financial dimensions of bringing new technologies to market. Students have access to the resources of the Anderson School, the Office of Intellectual Property, the Price Center and the graduate schools at UCLA, as well as experts from the local business community. And using these

resources, the students get a chance to not only learn about the commercialization process, but also actually get a chance to start businesses of their own.

“For those projects that are deemed worthy of moving forward,” notes Safaei, “there is a class that focuses on business plan development within the business school. Ideally, the student teams are gearing their projects up for the Knapp Business Plan Competition and a chance to pitch them in front of VCs and angel investors. We’re really trying to start these businesses. It is an effort to actually get these technologies out into the marketplace.”

The Office of Intellectual Property, which has a broad overview of the work being done by the university’s on-campus inventors, handpicks the technologies that are presented to the students. So the inventors, as well as the students, have a stake in the outcome.

“That’s one of the strengths of the program,” says Safaei. “We actually have access to patented or patentable technologies developed at UCLA. And there’s a definite advantage to having the expertise available to conduct feasibility studies and create business plans working with students who are enrolled in top-tier professional schools throughout UCLA. On top of that, you also have access to the school’s world-leading scholars and scientists. This is an unbelievable opportunity.”

Safaei’s personal goal is “to have a hand in economic development within the Los Angeles region, bringing these technologies to market and saving lives eventually.” He believes TIPP has put him on a trajectory that will make this possible.

## Bridge to Success



**TANUJ THAPLIYAL** earned his B.S. degree in electrical engineering from UCLA in 2011, *summa*

*cum laude*. As a student, he worked as a research scientist in the bioengineering department, where he helped successfully develop novel systems enabling the automated measurement and study of proteins.

Tanuj co-founded the TEC Assessment Group, which teaches engineers how to determine the marketability and commercial potential of early-stage technology. He has several summers of industry experience through a series of technical and nontechnical internships.

For most students in the scientific and technical disciplines, the academic experience is largely focused on mastering the basics of the student's chosen field. The daunting challenge of bringing a great idea out of the laboratory and into the marketplace is rarely discussed. So when students move on to begin their careers, they are often ill prepared to turn promising discoveries into commercially viable products and services.

In 2008, after a chance meeting with the Office of Intellectual Property's Kathryn Atchison, Tanuj Thapliyal—an undergraduate student in UCLA's electrical engineering program—decided that the time had come to address this problem.

"I had a lot of questions about the development of technology and what you do after something is invented," recalls the 2011 UCLA graduate. "What is the path to commercialization? What kind of questions do you ask to evaluate a technology's commercial prospects from a technical, legal and marketing standpoint? All of these were questions that I had, and I felt that these were questions other students had as well."

Since he couldn't find the answers to these questions in the classroom, Thapliyal decided to create a program that would help his fellow engineering students understand how to evaluate whether early stage technology is likely to succeed in the marketplace. Drawing on the talents of several like-minded students, Thapliyal organized the program and inaugurated it in the 2009-2010 school year.

Dubbed the Technology Assessment Group

—TAG—the program is offered through UCLA's Technical Entrepreneurial Community (TEC) and consists of three parts. The first is a seminar series where industry experts come in to lecture on a variety of topics including market analysis, legal and patent analysis, and technical analysis and business plans. During the second phase, the students form teams and—with the assistance of industry mentors—they write feasibility reports on commercializing specific technologies that have been selected for them by the program administrators with the help of OIP. Finally, the teams present these reports to a panel of angel investors who rank the teams and provide an oral critique of the presentations.

"I think it was pretty successful for the first year," says Thapliyal. "We got good feedback from the participants, and we got good feedback and commitments from our speakers and mentors. They liked it. Ten out of the 12 students who participated in the first year completed the program, and for the second year the number of applicants was in the mid 40s."

As the founder of this innovative program looks ahead to life after graduation, he feels that his participation in TAG will serve him well as he evaluates his options in the private sector.

"I learned a lot about how people analyze technologies for commercial feasibility," he says. "Clearly, there's no crystal ball. If there was, there'd be a lot of rich, successful people out there. There's an art to it, and there's a little bit of luck. But through TAG, I learned at least what questions to ask."



# OIP AT A GLANCE

---

**533** Number of inventions optioned or licensed

---

TOTAL INVENTION PORTFOLIO	<b>1837</b>
TOTAL ACTIVE U.S. PATENTS	<b>590</b>
TOTAL ACTIVE FOREIGN PATENTS	<b>604</b>
TOTAL ACTIVE LICENSE AGREEMENTS	<b>243</b>

---

<b>379</b>	Invention disclosures
<b>153</b>	New U.S. patent filings
<b>164</b>	Secondary filings
<b>47</b>	Issued U.S. patents
<b>78</b>	First foreign filings — PCT's
<b>52</b>	License and option agreements
<b>25</b>	Amendments with new IP matter
<b>50</b>	Letter agreements
<b>18</b>	Interinstitutional agreements

## LICENSED PRODUCTS

**THERASTRIDE** SOLD BY INNOVENTOR, IT IS A REHABILITATION DEVICE FOR SPINAL CORD INJURIES.

**POMELLA** POMELLA IS A BLEND OF POMEGRANATE POLYPHENOLS FOR USE IN CAPSULES OR LIQUIDS, SO THAT THE HEART-HEALTHY BENEFITS OF POMEGRANATE CAN BE INCORPORATED INTO MORE FOOD AND BEVERAGE PRODUCTS. LICENSED BY BLAZE.

**GDC AND MATRIX COILS** BOTH COILS ARE USED IN THE TREATMENT OF BRAIN ANEURYSMS: GDC IS A BARE-PLATINUM COIL, WHILE MATRIX2 COILS ARE COVERED WITH A BIOPOLYMER. LICENSED BY BOSTON SCIENTIFIC.

**SURVIVORSHIP/BREAST CANCER VIDEO** AN EFFECTIVE TOOL FOR HELPING BREAST CANCER SURVIVORS RECOVER FROM THEIR COURSE OF TREATMENT.

**MERCI EMBOLISM RETRIEVER DEVICE** MERCI STANDS FOR MECHANICAL EMBOLUS REMOVAL IN CEREBRAL ISCHEMIA. IN LAY TERMS, IT'S A DEVICE USED TO REMOVE BLOCKAGES FROM THE ARTERIES THAT SUPPLY THE BRAIN. LICENSED BY CONCENTRIC MEDICAL.

**PROMETHEUS IBD SEROLOGY 7** A BLOOD TEST FOR DIAGNOSING IRRITABLE BOWEL SYNDROME.

**NICOTINE PATCH** BECAUSE A NICOTINE PATCH RELEASES NICOTINE INTO THE BODY THROUGH THE SKIN, SMOKERS CAN USE IT TO GRADUALLY REDUCE THE AMOUNT OF NICOTINE THEY RECEIVE INSTEAD OF TRYING TO QUIT "COLD TURKEY." LICENSED BY NOVARTIS.

## COPYRIGHT TECHNOLOGIES

**CALIBRATED PEER REVIEW (CPR)** PEER REVIEW PLAYS A PROMINENT ROLE IN THE PROGRESS OF SCIENCE: PROPOSALS, RESEARCH AND MANUSCRIPTS ARE ALL PEER REVIEWED. THE WEB-BASED CPR PROGRAM TEACHES STUDENTS HOW TO REVIEW DISCIPLINE-BASED WRITING.

**COOL TOOLS** LESSON PLANS AND PHYSICAL PROPS IN COOL TOOLS ARE DESIGNED FOR TEACHERS TO HELP YOUNG CHILDREN UNDERSTAND COMPLEX IDEAS ABOUT BEHAVIOR.

**DIGITAL MODELS OF ROME 400 A.D.** DIGITAL MODELS ALLOW SCHOLARS AND VISITORS TO VISUALIZE ANCIENT ROME AS SEEN AT A PARTICULAR MOMENT IN TIME.

45

COMPANIES THAT LICENSED  
UCLA TECHNOLOGY

23 STARTUPS

*on-campus inventors*

538

**TWENTY-FOUR**

STATES WITH UCLA LICENSEES

**17** *countries with UCLA licensees*

**UCLA**

Office of Intellectual Property & Industry Sponsored Research  
[www.oip.ucla.edu](http://www.oip.ucla.edu)