

Display System Price Guide

edition 5



GGS

Exhibitions

Photography

Design

BANNER STANDS

A widely used, fast and simple to set up promotion medium. Ideal for point of sale and exhibitions. Easy to transport and cost effective. Available in a wide range of sizes.



Buzz

Our Bargain lightweight economy roller banner stand for short term use. Supplied with carry bag.

Single Sided	Premium
2000 x 850	£45.00



Grasshopper

Lightweight economy roller banner stand, lightweight and ideal for point of sale. Supplied with carry bag.

Single Sided	Premium
2000 x 800	£80.00



Greenwich

Premium print economy banner stand, lightweight and ideal for point of sale. Supplied with carry bag.

Single Sided	Premium
2000 x 800	£115.00
2000 x 1000	£160.00



Orient

Lightweight but robust roller banner stand with floor to rail graphic visibility. Supplied with carry bag.

Single Sided	Premium
2110 x 800	£140.00
2110 x 1000	£170.00



Merlin

Single sided interchangeable cassette banner stand with wide base unit for stability. Supplied with carry bag. Spare cassettes available individually.

Single Sided	Premium	Spare Cassette
2000 x 850	£160.00	£100.00
2000 x 1000	£195.00	£130.00



Original Banner 2

Single sided roller banner stand with wide base unit for stability. Available in a range of sizes to help you make a bigger impact. Supplied with carry bag.

Single Sided	Premium	Budget
2145 x 1200	£225.00	-
2145 x 1500	£245.00	-
2145 x 2000	-	£305.00
2145 x 2400	-	£365.00



Mini Breeze

Table Top Roller Banner Stand

Single Sided	Budget
302 x 420	£30.00



Barracuda

Our most popular premium quality, robust roller banner stand. Ideal for long term displays and frequent use. Supplied with carry bag.

Single Sided	Premium
2130 x 800	£175.00
2130 x 1000	£215.00



Revolution

Our tallest premium roller banner! Stylish, glossy white injection moulded base unit. Supplied with premium, padded carry case.

Single Sided	Premium
2200 x 850	£195.00



Edge 2

Double sided premium, robust banner stand. Ideal for displaying twice the message in one go. Supplied with carry bag.

Double Sided	Premium
2000 x 850	£225.00
2000 x 1000	£285.00



Twist

Tension banner stand which allows multiple graphics to be used with one system. Integral light and carry bag included with all stands.

Single Sided	Premium
2000 x 800	£350.00
2000 x 1000	£375.00



Twist Flexi Link Kit

Linkable banner stand with clever flexi link panel enabling you to create different shape configurations. Supplied with integral lighting and wheeled carry case for transportation.

Single Sided	Premium
2000 x 800	£930.00 (2 x 800 wide banners & link graphic)
2000 x 1000	£980.00 (2 x 1000 wide banners & link graphic)



DL Plus

Linkable roller banner stand, ideal for creating larger walls of graphics. Supplied with carry bag.

Single Sided	Premium
2000 x 850	£190.00

Linking Kit £15.00

All banner systems come supplied with full colour printed graphics. Cost is exclusive of design time. GGS offers a full design service if this is something you may require.

Premium graphics are produced on hard wearing layflat polyester with an opaque backing.

Budget graphics are intended for short-term use. Produced on 450 gsm banner vinyl.

Replacement Graphics

Premium	
800mm wide	£80.00
850mm wide	£80.00
1000mm wide	£105.00

Twist Graphics - Premium

800mm wide	£110.00
1000mm wide	£135.00
550mm linking	£60.00



Banner Lighting

PS800
50 watt low voltage spotlight for use with banner stand
Silver £35.00

EVOLUTION & IMPACT POP-UP SYSTEMS

Our reliable systems are tried and tested. They are available with high quality printed graphics or fabric panels in a variety of different configurations to suit your exhibition space. All systems can be linked together to create larger stands.



Straight

Evolution
Lifetime
Equipment
Guarantee

Impact
1 Year
Equipment
Guarantee



Curved

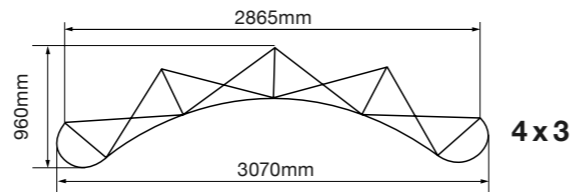
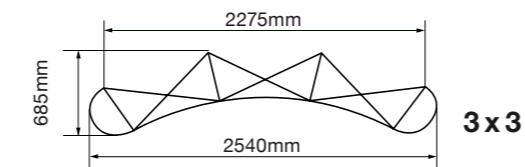
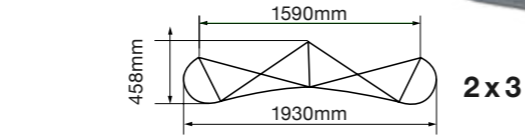
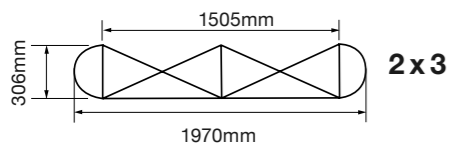
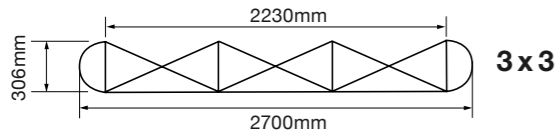
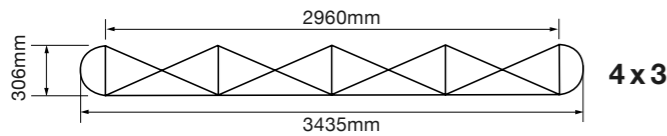

Price Guide - Curved

	Impact	Evolution
1 x 3*	---	£540.00
2 x 3*	---	£705.00
3 x 3	£795.00	£885.00
4 x 3	£935.00	£1030.00
5 x 3	---	£1305.00

Price Guide - Straight

	Impact	Evolution
1 x 3*	---	£540.00
2 x 3*	---	£705.00
3 x 3	£860.00	£925.00
4 x 3	£995.00	£1080.00
5 x 3	---	£1305.00

*These systems come with a small, lightweight wheeled case. Lights can be supplied at additional cost if required.

All other systems supplied with a large, wheeled carry case and a folding Birch effect table top.

Lighting - Evolution 2 x PS1000 120 Watt
- Impact 2 x PS950 150 Watt

Pop-up stand graphics are produced in full colour on premium polyester Stoplight media with an additional hard-wearing anti-scuff laminate. Each graphic will be supplied in polytubing for additional protection during transportation and storage.

Accessories

Case Conversion Graphic	£110.00 each	Zeus Wheeled Carry Case	£135.00 each
Replacement Graphics	£110.00 each	Hinged Table Top for Zeus	£45.00 each
120 Watt Lamps - Powerspot 1000	£60.00 each	LCD Monitor Bracket	£60.00 each
20 Watt LED - Powerspot 1060	£75.00 each	Stabilising Feet (pair)	£30.00 each
Spare Ø400mm Graphics Drum	£60.00 each	Internal Aperture Set	£215.00 each

CUSTOMISABLE POPUP STANDS

Pop-up stands can be customised to add additional features and height. Create additional impact at your exhibition and stand out from the crowd.

How will you use yours?

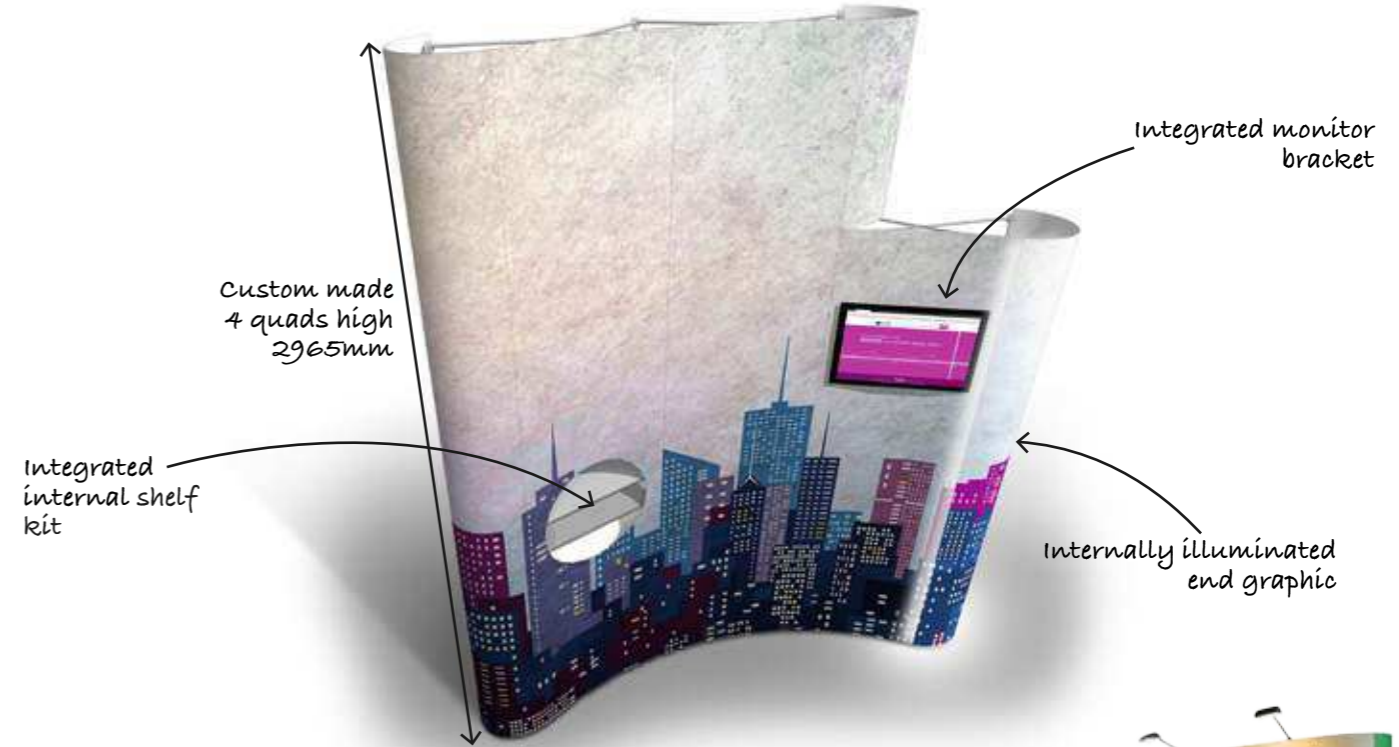

Pop-up Counta

The Counta is quick and easy to assemble, supplied complete with full colour graphic wrap and Beech effect counter top.

The 2x1 Counta has 2 internal shelves and the 2x2 has 4 internal shelves. Also supplied with a reinforced, wheeled, D shaped carry case for transportation.



Pop-up Counta 2x1
£300.00



Pop-up Counta 2x2
£345.00



Linked Pop-ups

Pop-up stands can be linked together to create bigger impact and fill larger stand spaces.

Above Example - linked 3x3 & 2x3 curved stands complete with carry cases and all lighting - **£1875.00**

VARIO D400 POP-UP SYSTEMS

The 'ultimate' stylish Pop-up solution. Pop-ups have reached a new level of simplicity and sophistication in this innovative new design.



Price Guide

Curved Systems

VA 5813	1 x 3	£1070.00
VA 5823	2 x 3	£1250.00
VA 5833	3 x 3	£1590.00
VA 5843	4 x 3	£1870.00

Straight Systems

VA 5713	1 x 3	£1095.00
VA 5723	2 x 3	£1270.00
VA 5733	3 x 3	£1615.00
VA 5743	4 x 3	£1895.00

Attractive satin finish anodised aluminium posts have replaced curved end panels, so a single-sided 3x3 system only requires 3 graphics rather than 5. This makes the Vario quicker to assemble and also saves you money when you come to re-print your graphics. And, best of all, you can add a selection of accessories to the structure to individualise your stand, including product shelves, literature holders, lighting and even flat screen monitors.

The 1x3 and 2x3 are supplied with one PS1000 light.
The 3x3 and 4x3 are supplied with a pair of PS1000 lights.

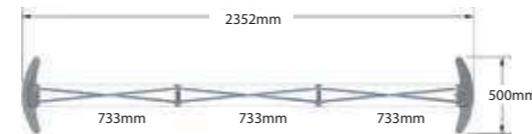
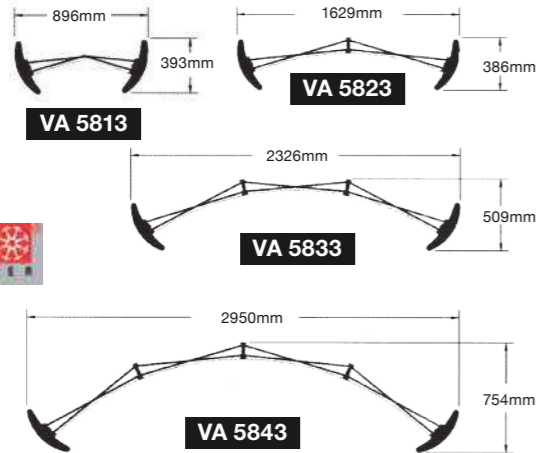

Accessories

PS1000 120 Watt Halogen	£65.00
PS1060 20 Watt LED	£80.00
Vario Universal Literature Holder	£60.00
Paddle Shelf Right/Left	£110.00
E275 Bag Holder	£10.00
Replacement Graphics (each)	£110.00
Carry Case Conversion Graphic	£110.00
Birch Hinged Table Top for Wheeled Carry Case	£45.00
Monitor Fixing Kit (max weight 4kg)	£130.00

HOP-UP POP-UP SYSTEMS

The next generation in large format displays. Light, portable and easy to set-up, offering maximum impact with minimal fuss.



Tension fabric systems are the next generation in large format graphic displays. Lightweight and easy to set up, the Hop-Up is available in straight format only. Size Options 1 x 3, 2 x 3, 3 x 3, 4 x 3. All systems supplied with wheeled carry bag

Price Guide

1 x 3	£470.00
2 x 3	£540.00
3 x 3	£675.00
4 x 3	£845.00

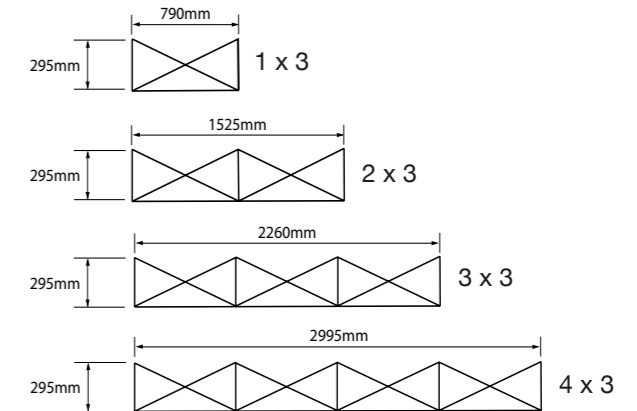

Hop-up Counta

A durable, lightweight hop-up counter; quick and easy to assemble with a single wrap-around fabric graphic. Includes single shelf and carry bag.

1020 x 1060 x 360mm

£330.00



Hop-Up Accessories

150 watt lamps - PS1000	£60.00 each
Hop-Up Light Fitting	£2.50 each
Stabilising Feet	£50.00 (pair)

FORMULATE FABRIC DISPLAYS

Formulate Fabric Displays are a practical, lightweight solution for creating large backdrops at exhibitions. The single one piece graphic looks stunning with no visible joins. Easy to assemble and transport, Formulate Displays are an alternative to conventional pop-up stands.

Formulate Displays are a new addition to the GGS portable display equipment range. Quick and easy to assemble the Formulate Displays are manufactured from strong 30mm aluminium tubing. Labelled with numbers, you simply match number to number with a 'push-lock' fitting. The full colour printed stretch fabric graphic then pulls over the framework and zips closed at the bottom. The system packs away into a supplied fabric carry bag and the graphics are machine washable. A wide range of sizes and shapes are available.



Slant (h) x (w) x (d)
£310.00 2280 x 915 x 650 mm



Curl (h) x (w) x (d)
£350.00 2280 x 915 x 480 mm



Monolith (h) x (w) x (d)
600mm **£300.00** 2300 x 650 x 250 mm
900mm **£340.00** 2300 x 955 x 250 mm
1200mm **£390.00** 2300 x 1240 x 250 mm
1500mm **£430.00** 2300 x 1544 x 250 mm

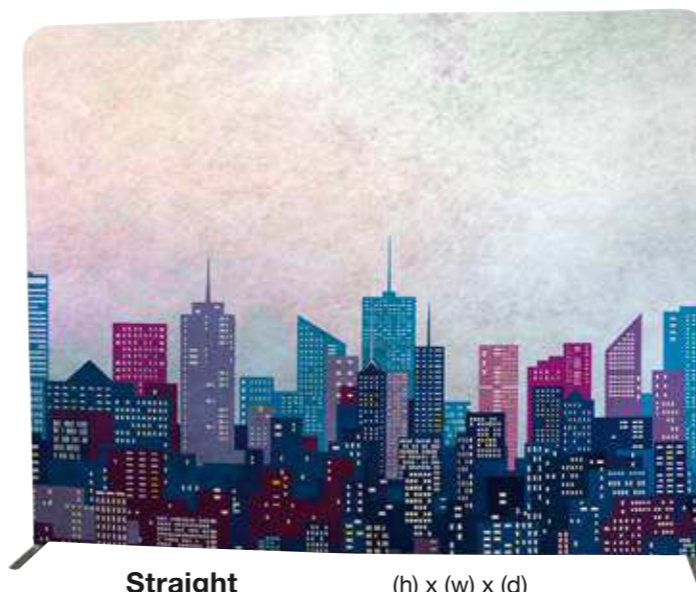

Straight (h) x (w) x (d)
2.4m **£530.00** 2380 x 2350 x 400 mm
3m **£595.00** 2380 x 2950 x 400 mm
6m **£1135.00** 2380 x 5950 x 400 mm



Horizontal Curve (h) x (w) x (d)
2.4m **£490.00** 2340 x 2350 x 500 mm
3m **£570.00** 2340 x 2950 x 500 mm
6m **£1100.00** 2340 x 5950 x 600 mm



Vertical Curve (h) x (w) x (d)
£550.00 2280 x 3048 x 583 mm



Formulate Hanging Structures Available

OUTDOOR DISPLAY EQUIPMENT

A large range of outdoor display equipment is now available. Come rain or shine you can always make an impact at County Shows & Exhibitions



Sierra

Outdoor all weather double sided roller banner, comes with large base that can be filled with water or sand for stability. Wheeled carry bag included.

800mm x 2000mm - **£360.00**
Replacement Graphic - **£75.00**



Adventurer

Outdoor banner stand comes complete with carry bag and heavy duty base to fill with water or sand.

700mm x 2000mm - **£175.00**
Replacement Graphic - **£65.00**



Wind Dancer

Outdoor fabric flag banner with large base unit to fill with water for stability, overall flag pole height of 5m with a 3.5m x 1m fabric graphic.

Premium Fabric - **£310.00**
Replacement flag - **£150.00**
Optional carry bags - **£60.00**

Monsoon

Monsoon banner frames are supplied single or double sided and come complete with frame carry bag and guide pegs.



2500 x 1000

Single Sided - **£210.00**
Double Sided - **£300.00**
Replacement Graphic - **£90.00**

3000 x 1250

Single Sided - **£265.00**
Double Sided - **£395.00**
Replacement Graphic - **£130.00**

Wall Mountable Frames Available



Whirlwind

A heavy duty double sided outdoor advertising swing sign. Weather resistant and can be flat packed for easy transportation.

A1 Hardware only - **£140.00**
A1 Polyester Poster - **£25.00 each**
A0 Hardware only - **£205.00**
A0 Polyester Poster - **£40.00 each**



A-Sign Board

A double sided, easy front loading sign board for both indoor and outdoor use.

A1 Hardware only - **£75.00**
A2 Hardware only - **£60.00**
A1 Polyester Poster - **£25.00 each**
A2 Polyester Poster - **£15.00 each**

FORMULATE FLAGS

Formulate Flags create a simple yet stunning outdoor display. Ideal for event signage, they can be sited on many different terrains with one of our many base options.

Built with the same popular Formulate aluminium tubing design, the Formulate flag simply connects one numbered 25mm aluminium tube to another for fast assembly. The fabric graphic is then threaded directly onto the pole and secured with a toggle. Available in 3 different designs and a range of heights the Formulate flags are popular for outdoor events. A variety of base options are also available for using the flags in different locations.

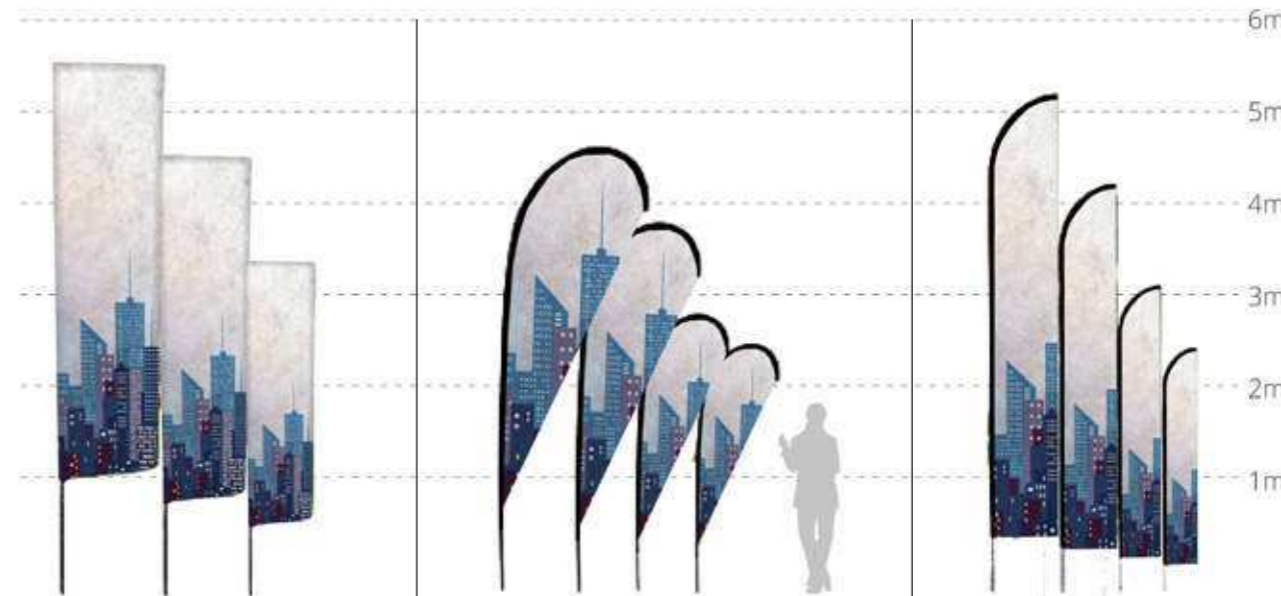

RECTANGLE

Size	(h) x (w) mm	Price
Xtra Large	5510 x 820 mm	£200.00
Large	4505 x 820 mm	£170.00
Medium	3505 x 720 mm	£140.00

QUILL

Size	(h) x (w) mm	Price
Xtra Large	4580 x 930 mm	£170.00
Large	3710 x 836 mm	£150.00
Medium	2860 x 734 mm	£130.00
Small	2300 x 620 mm	£100.00

FEATHER

Size	(h) x (w) mm	Price
Xtra Large	5135 x 725 mm	£170.00
Large	4195 x 675 mm	£150.00
Medium	3245 x 625 mm	£130.00
Small	2475 x 575 mm	£100.00



Small Water Base **£20.00**
(Small water base is only suitable for small and medium height flags)



Large Water Base **£35.00**



Drive-on Car Foot **£20.00**



Ground Spike **£20.00**

Other Base Options Available

'Actual' Banner Sizes

2500x1000mm frame = 2340mm x 840mm
3000x1250mm frame = 2840mm x 1090mm

Accessories

400mm Diameter Graphic Drum **£60.00 each**
1050mm Graphic Banner Tube **£30.00 each**
1250mm Graphic Banner Tube **£40.00 each**

ZOOM TENTS

There's plenty of room to shelter rain or shine underneath the Zoom Tent. Made from lightweight aluminium, it's very easy to assemble and packs into a strong and sturdy wheeled bag.



Zoom Tent Weights
£12.50 each.

Fully Printed Tent Prices

Tent Size	Hardware Cost	Printed Canopy Cost	Printed Full Side Wall Cost	Printed 1/2 Side Wall Cost	1/2 Wall Mount Bars
2 x 2m	£170.00	£430.00	£150.00	£75.00	£35.00
3 x 3m	£230.00	£525.00	£190.00	£100.00	£35.00
3 x 6m	£420.00	£685.00	3m Wall - £190.00 6m Wall - £380.00 (two 3 x 3m graphics)	3m Wall - £100.00 6m Wall - £200.00 (two 3m 1/2 wall graphics)	3m Wall - £35.00 6m Wall - £70.00 (two 3m mount bars)

Plain Fabric Tent Prices

Tent Size	Hardware Cost	Plain Fabric Canopy	Plain Fabric Full Side Wall Cost	Plain Fabric 1/2 Side Wall Cost	1/2 Wall Mount Bars
2 x 2m	£170.00	£35.00	£20.00	£12.50	£35.00
3 x 3m	£230.00	£50.00	£35.00	£20.00	£35.00
3 x 6m	£420.00	£90.00	3m Wall - £35.00 6m Wall - £70.00 (two 3m x 3m graphics)	3m Wall - £20.00 6m Wall - £40.00 (two 3m 1/2 wall graphics)	3m Wall - £35.00 6m Wall - £70.00 (two 3m mount bars)

Fabric colour options - Red, White, Black and Blue

SPIRAL SHOW-TOWERS

Show-towers can serve both to protect and draw attention to your products, as well as giving you additional branding space at an exhibition or in reception areas.

Replacement graphics panels
Only £25.00 each

Show-Tower

Size: 2065(h) x 565(Ø)mm
Finish: Silver
Weight: 20Kg
Graphic size: 507(h) x 396(w)mm
All designs inclusive of integral lighting and carry case.

Show-Counter

Size: 1070(h) x 580(Ø)mm
Finish: Silver with Beech Counter Top
Weight: 15Kg
Graphic size: 507(h) x 396(w)mm
Inclusive of carry case.



Show Counter
Plinth Top with iPad Holder
£115.00



Show Counter
System inclusive of:-
6 Graphic Panels
(open on reverse)
£405.00

Design 1



Design 1
System inclusive of:-
16 clear acrylic panels
(no graphic panels)
£375.00

Design 2



Design 2
System inclusive of:-
12 clear acrylic panels
4 graphic panels
£475.00

Design 3



Design 3
System inclusive of:-
8 clear acrylic panels
8 graphic panels
£575.00



LIGHT BOXES

Brighten up your exhibition or office space with our wide range of freestanding and wall mounted LED light box solutions.

WALL MOUNTED ULTRA SLIM LIGHT BOXES

These ultra slim light boxes are cutting edge technology which produces an outstanding product for you to be able to display images and offers effortlessly. The backlit LED technology gives an incredibly even white light illumination and as an added bonus is energy saving.

Super slim 12mm construction depth gives this light box it's modern appearance and with the straightforward snap open frame graphics can be easily replaced allowing your products and offers to be updated and changed with ease.



12mm Deep Profile

Cost includes one printed backlit graphic.

	A3	A2	A1	A0
Single Sided	297x420	350x500	420x594	500x700
	£155.00	£145.00	£240.00	£290.00
			594x840	700x1000
			£345.00	£395.00
				840x1188
				£525.00

WALL MOUNTED FABRIC LIGHT BOXES

The Vector LED range of wall mounted lightboxes come in 3 standard sizes with a single sided fabric graphic. The system includes a stylish 75mm silver aluminium extrusion with edgelit LED lights. The Fabric graphics push fit into the extrusion recess allowing for them to be updated regularly.

75mm Deep Profile

	(h) x (w) mm	
Single Sided	2000 x 1000	£460.00
Single Sided	2000 x 2000	£780.00
Single Sided	2000 x 3000	£1200.00



FREE STANDING FABRIC LIGHT BOXES

The Vector LED range of freestanding lightboxes offers a number of extrusion choices and is supplied in a range of standard sizes. Each profile has a smooth exterior, finished in silver aluminium, creating the perfect look for exhibition, retail or showroom environments. Frames are supplied flat packed. Each unit is powered by edgelit LED plug and play lights and is finished off with a full colour printed fabric graphic that pushes into the perimeter of the frame creating a seamless vibrant lightbox.



100mm Deep Profile

	(h) x (w) mm	
Single Sided	2000 x 1000	£570.00
Double Sided	2000 x 1000	£670.00
Single Sided	2000 x 2000	£990.00
Double Sided	2000 x 2000	£1190.00
Single Sided	2000 x 3000	£1490.00
Double Sided	2000 x 3000	£1790.00

125mm Deep Profile

	(h) x (w) mm	
Single Sided	2000 x 1000	£610.00
Double Sided	2000 x 1000	£710.00
Single Sided	2000 x 2000	£1000.00
Double Sided	2000 x 2000	£1200.00
Single Sided	2000 x 3000	£1510.00
Double Sided	2000 x 3000	£1810.00

150mm Deep Profile

	(h) x (w) mm	
Single Sided	2000 x 1000	£650.00
Double Sided	2000 x 1000	£750.00
Single Sided	2000 x 2000	£1050.00
Double Sided	2000 x 2000	£1250.00
Single Sided	2000 x 3000	£1550.00
Double Sided	2000 x 3000	£1850.00



PORTABLE FURNITURE & LITERATURE STANDS

Our range of portable furniture is extensive. Flexible MDF counters to fully printed fabric graphic counters are available in a number of shapes and sizes.



Other Styles Available

Eclipse Counter

Eclipse Counter available in Birch effect or coloured fabric wrap. Counter tops available in Birch, White, Black or Silver.

1000(h) x 1000(w) x 500(d)mm **£245.00**
 Full printed graphic wrap **£150.00**
 Black Canvas Carry Bag **£45.00**



Other Styles Available

Formulate Rectangle Counter

The Formulate Rectangle Counter has a base and top supported by four poles. Tensioned fabric sock is then attached using silicone edged material. Fully printed

1015(h) x 800(w) x 530(d)mm **£310.00**



Other Styles Available

Vario Counter

Vario counter inclusive of fully printed and laminated magnetic changeable graphic panel and carry bag. Compatible with D400 accessories.

£545.00



Zed Up Lite

A5 - **£105.00** Silver
 A4 - **£115.00** Silver
 A3 - **£155.00** Silver
 Includes Alloy Case



Zed Up

A4 - **£99.00** Silver
 Includes Carry Bag



Quantum

A4 - **£105.00** Black
 Includes Carry Bag



iPad Freestanding

The Freestanding iPad holder is smart and sleek for use with iPad 2, 3, 4, Air and Air 2. The secure housing comes supplied with security screws and Allen key, and can be positioned portrait or landscape. For extra security the base can be bolted to the floor or stand. Available in Silver, Black or White.

£120.00



D400 iPad Holder

Secure iPad holder for use with your D400 Pop-up stand. Holder locks into the system slot of your stand, allowing vertical and horizontal positioning. Finished in a matt anodised aluminium to complement the stand endcaps.

£240.00

iPad Counter

Secure iPad holder with continuous power that can be mounted on desk tops. Contemporary styling with robust steel holder. Available in textured Black or White finish. Holder rotates and swivels 350° and tilts 90°.

£120.00



iPad Curve

The iPad Curve is a free standing unit and enclosure designed for quick and easy utilisation where power may not be available, designed to be versatile and practical whilst safely securing your iPads. Overall height of 1210mm.

£180.00



iPad Wall Mount

iPad holder and Vesa mount tilting bracket with security locking screws supplied. Available in textured Black or White finish. Holder can be mounted portrait or landscape with an Easy tilt adjustment +17° to -10° No rotation or swivel movement.

£130.00



DID YOU KNOW...

GGs also offer a range of equipment for hire. Additionally we design, build and install complete exhibition stands at all UK and European venues.

Drawing on experience and imagination, our dynamic stand designs have won 'best stand awards', increased client profiles and generated maximum results even with the smallest of stand spaces.

We can also take care of any photography and design requirements for your stand graphics and design and produce your marketing literature to use at shows.

From conception to completion our creative team are here to help you every step of the way.



Contact our Exhibitions Director Duncan Smith to discuss your requirements. duncan@ggs.co.uk



Please recycle after use

www.ggs.co.uk
enquire@ggs.co.uk
Tel. 01603 622500

1 White Lodge Business Park, Hall Road, Norwich, NR4 6DG

Prices are exclusive of VAT
We reserve the right to change prices without notice