



# Marine

High speed propulsion engines

**MAN Engines**





# Contents

## **MAN Marine Engines**

Customer Benefits . . . . .	4
Light, medium and heavy duty operation . . . . .	4
MAN Service: Competent and motivated . . . . .	5
MAN Warranty: Relaxing and calculable. . . . .	5
MAN Environmental Awareness: Future-oriented and ecofriendly . . . . .	5

## **Description of engines – Light duty**

D2676 . . . . .	7
D2868 . . . . .	10
D2862 . . . . .	13

## **Description of engines – Medium duty**

D2676 . . . . .	19
D2868 . . . . .	23
D2862 . . . . .	27

## **Description of engines – Heavy duty**

D2676 . . . . .	35
D2868 . . . . .	42
D2862 . . . . .	46



# MAN Marine Engines

## A reliable driving force

At sea, ships and boats have to contend with elemental forces, while harbours require them to navigate precisely through the narrowest of corridors.

### Customer Benefits

- Maximum torque at the most fuel efficient point of operation
- Maximum torque across a large range of engine speed for a powerful and steady acceleration
- Class-leading compactness for a space-saving design
- Best fuel consumption values and long service intervals minimizing the TCO
- Low acoustics and low vibrations
- World-wide service network with rapid spare parts supply

### Light duty operation

In light duty operation (730–1,900 hp), MAN Engines offer exceptional dynamics accompanied by maximum economic efficiency. And by the way: their pathbreaking technology for adhering to emission guidelines means that they easily take up a leading position on patrol boats, sea-rescue boats and coastguard boats.



### Medium duty operation

In medium duty operation (560–1,400 hp), the fuel-saving MAN engines ensure maximum efficiency on accompanying boats, pilot boats and deep-sea patrol boats, on fishing boats, ferries and on passenger ships. A long service life with low lifecycle costs and also quick supply of spare parts through the world-wide servicing network make the MAN engines profit earners in professional navigation.



### Heavy duty operation

MAN Engines offer a perfectly coordinated power spectrum for heavy duty (200–1,000 hp) operation with powerful acceleration and high tractive force. They are the ultimate in terms of reliability and efficiency in freight and passenger shipping as well as in trawlers, tugs and push boats.





### **MAN Service**

#### **Competent and motivated**

MAN is there for you from the outset. Where qualified guidance is needed for the installation, our experts are at your side with advice and practical assistance. Of course you can always rely on our worldwide service. Qualified service centres provide you with fast and skilled servicing and repairs. Worldwide partners ensure a service network for marine engines. As you can see we are there whenever and wherever you need us.

### **MAN Warranty**

#### **Relaxing and calculable**

With MAN engines for work boats you are on the safe side since MAN Engines goes one step further. With the **“Work Plus”** Warranty you do not only extend the warranty for your engine, but it also gives you the certainty and peace of mind that you have made the right decision. In practice this means an additional year of safety for you and your engine plus attractive pricing which makes this offer even more appealing.

### **MAN Environmental Awareness**

#### **Future-oriented and eco-friendly**

At MAN, we attach very great importance indeed to eco-friendliness. Every day, our engineers do their utmost to develop eco-friendly engines which comply with current emission standards worldwide.

With their particularly low fuel consumption, MAN engines not only ensure high economy, but also protect our environment. And your ears: this means that the quiet yet very powerful engine makes every trip a unique experience. Real recreation – both for the customer and the environment.



# Light duty operation

## Definition of application type

### Characteristics

- Annual operating hours:  $\leq 1,000$
- Percentage of time at full load:  $\leq 20\%$
- Average load application:  $\leq 50\%$

### Typical applications

- Season fishing
- Escort boats and patrol boats
- Ambulance boats
- Police boats

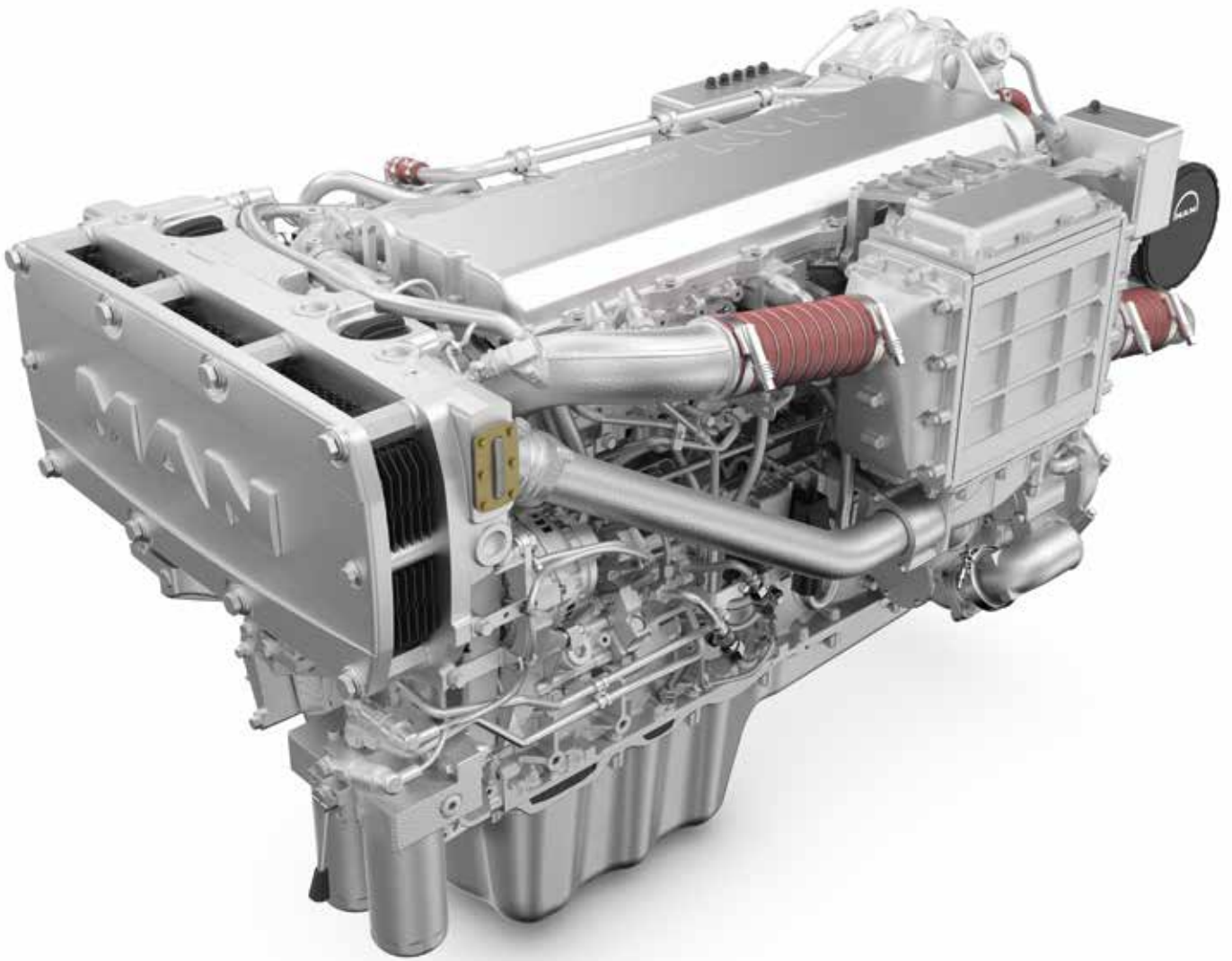

# D2676

## Engine description

### Characteristics

- Cylinders and arrangement: 6 cylinders in-line
- Operation mode: 4-stroke diesel engine, watercooled
- Turbocharging: Turbocharger with charge air intercooler and waste gate
- Number of valves: 4 valves per cylinder
- Fuel system: Common Rail direct fuel injection with electronic control
- Engine lubrication: Closed system with forced feeding, oil cooling and filtering
- Type of cooling: Heat exchanger with engine and seawater circuit
- Engine control: Electronic injection control (EDC)  
Electronic engine monitoring including diagnostic unit
- Fuel: DIN EN 590

# D2676

## Technical data

### Technical features D2676

Type designation		LE 443	LE 423
Displacement	l	12.42	12.42
Maximum output to DIN ISO 3046-1	kW (hp)	537 (730)	588 (800)
Rated speed	rpm	2,300	2,300
Maximum torque	Nm	2,450	2,674
at speed	rpm	1,300–2,100	1,400–2,000
Lowest specific fuel consumption <sup>1)</sup>	g/kWh	199	213
Classifiable		✓	–
Exhaust gas status		IMO Tier II, EPA Tier 3 RCD 2013/53/EC, RCD 94/25/EC, 97/68/EC	IMO Tier II, EPA Tier 3 <sup>2)</sup> , RCD 2013/53/EC, RCD 94/25/EC, 97/68/EC

1) Tolerance +5% according to DIN ISO 3046-1

2) For private use only

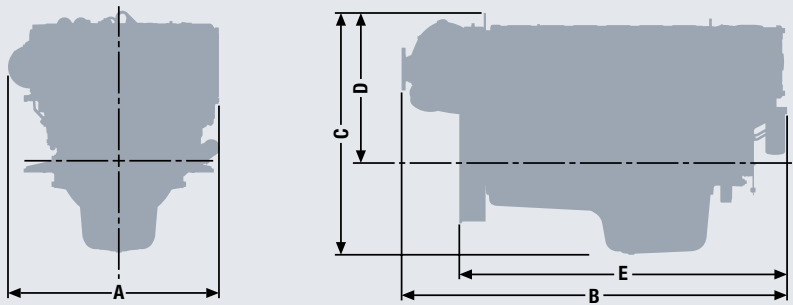

### Dimensions D2676

Type designation		LE 443/ LE 423
A-Overall width	mm	986
B-Overall length	mm	1,795
C-Overall height – standard oil pan	mm	1,096
D-Top of engine to crankshaft centre	mm	674
E-Length of engine from front end to edge of flywheel housing	mm	1,527
Average weight of engine ready for installation (dry)	kg	1,215

For detailed examinations of installation dimensions, please order drawings from our factory.



# D2676

## Power charts

D2676 LE 443

D2676 LE 423

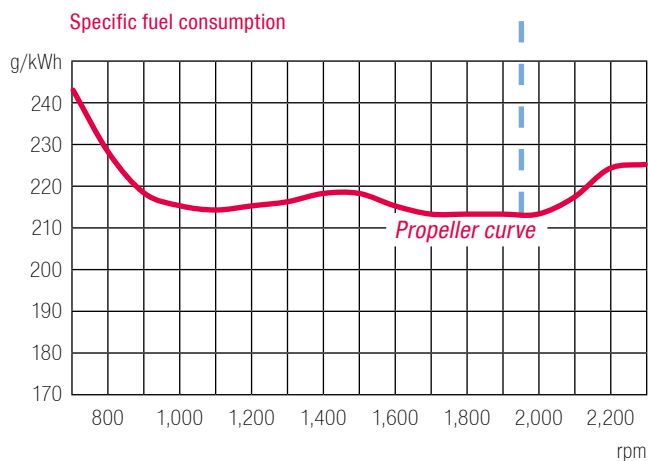
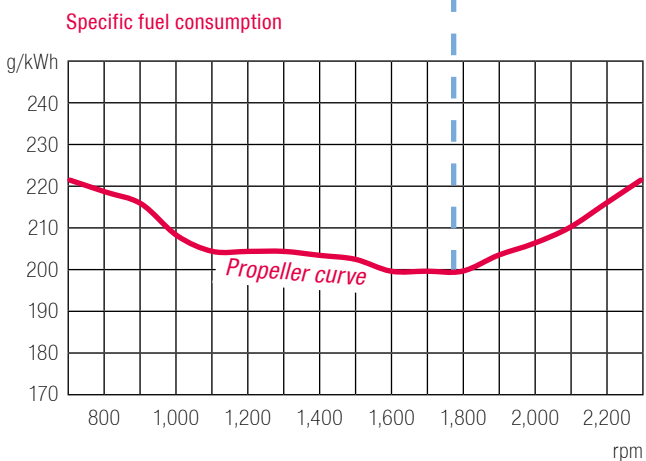
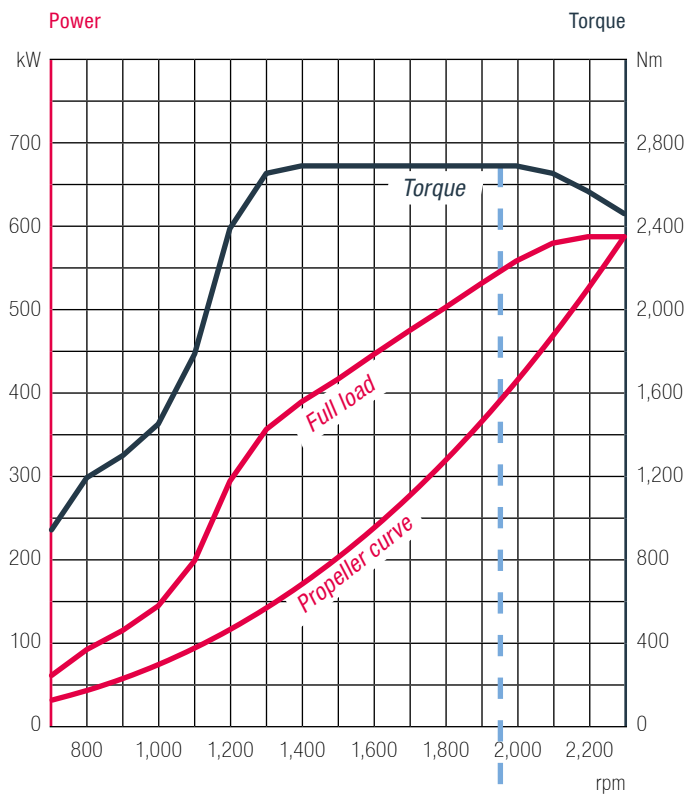
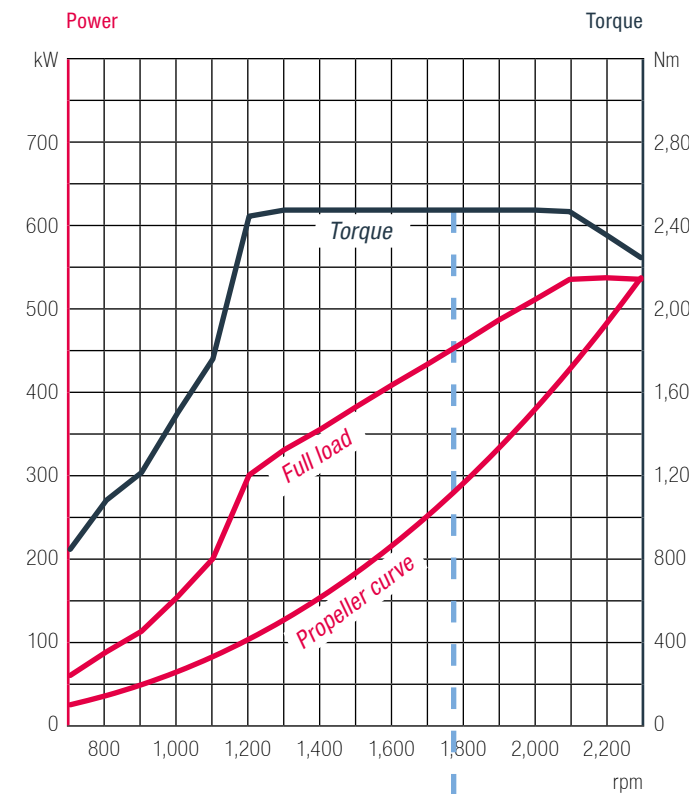

--- Maximum torque at most fuel efficient operating point

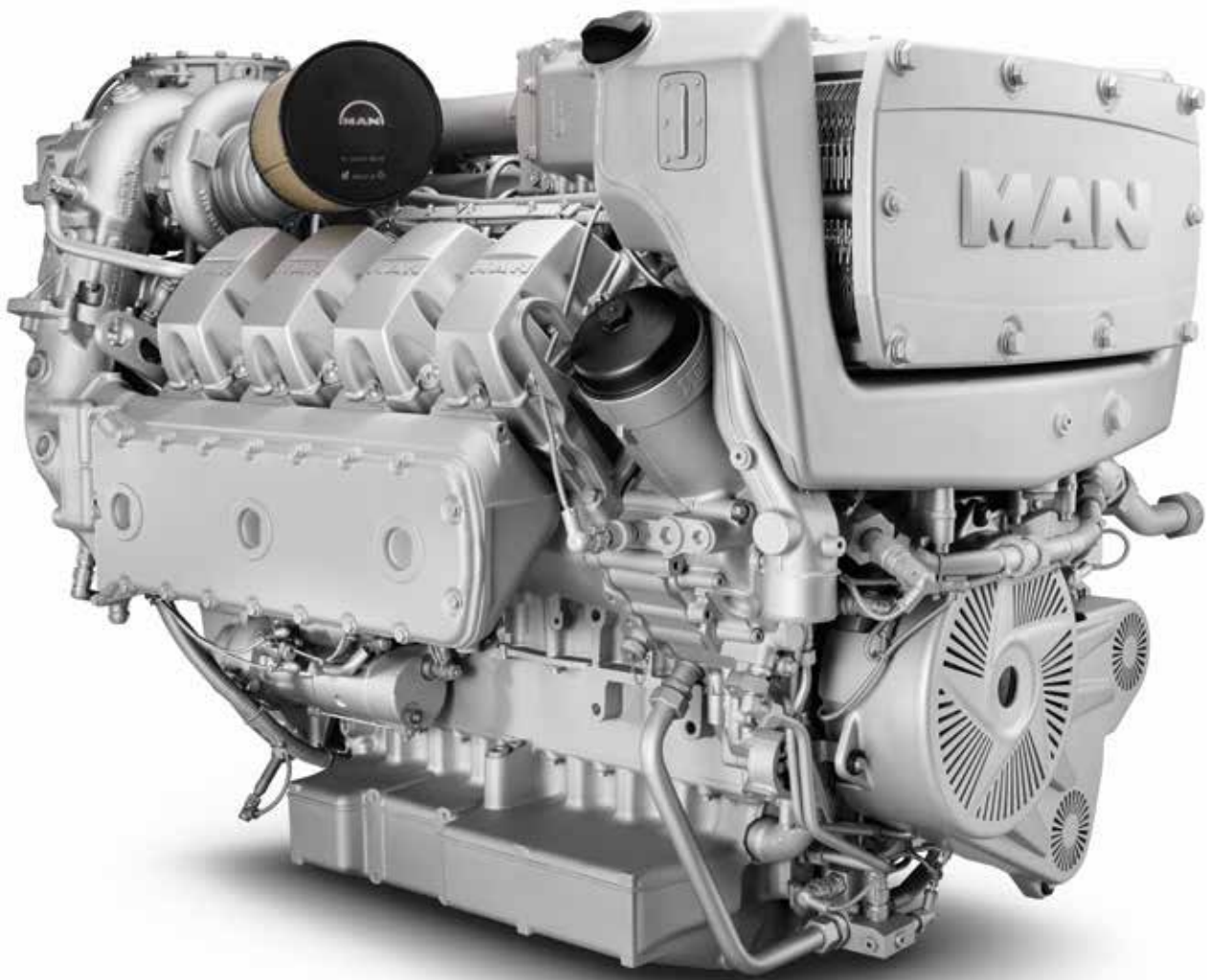

# D2868

## Engine description

### Characteristics

- Cylinders and arrangement: 8 cylinders in 90° V arrangement
- Operation mode: 4-stroke diesel engine, watercooled
- Turbocharging: Turbocharger with charge air intercooler and waste gate (1-stage: D2686 LE 426, 2-stage: D2868 LE 436)
- Number of valves: 4 valves per cylinder
- Fuel system: Common Rail direct fuel injection with electronic control
- Engine lubrication: Closed system with forced feeding, oil cooling and filtering
- Type of cooling: Plate heat exchanger, seawater cooled
- Engine control: Electronic injection control (EDC)  
Electronic engine monitoring including diagnostic unit
- Fuel: DIN EN 590

# D2868

## Technical data

### Technical features D2868

Type designation		LE 426	LE 436
Displacement	l	16.16	16.16
Maximum output to DIN ISO 3046-1	kW (hp)	735 (1,000)	882 (1,200)
Rated speed	rpm	2,300	2,300
Maximum torque	Nm	3,340	4,010
at speed	rpm	1,300–2,100	1,200–2,100
Lowest specific fuel consumption <sup>1)</sup>	g/kWh	209	205
Classifiable		–	–
Exhaust gas status		IMO Tier II, EPA Tier 3, RCD 2013/53/EC, RCD 94/25/EC, 97/68/EC	IMO Tier II, EPA Tier 3 <sup>2)</sup> , RCD 2013/53/EC, RCD 94/25/EC, 97/68/EC

1) Tolerance +5% according to DIN ISO 3046-1

2) For private use only

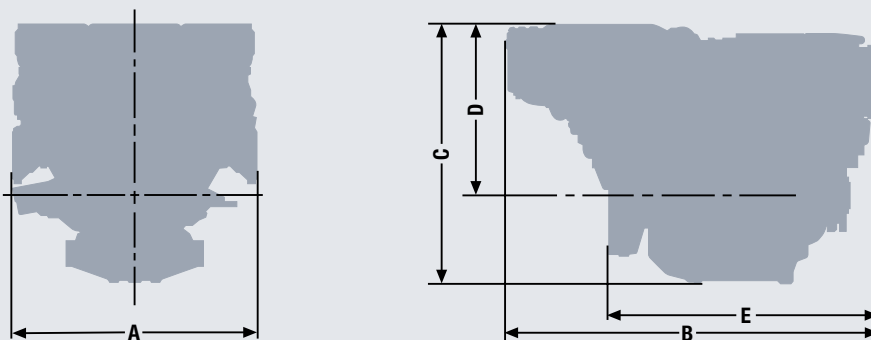

### Dimensions D2868

Type designation		LE 426	LE 436
A-Overall width	mm	1,153	1,153
B-Overall length	mm	1,745	1,745
C-Overall height	mm	1,177	1,222
D-Top of engine to crankshaft centre	mm	765	811
E-Length of engine from front end to edge of flywheel housing	mm	1,243	1,262
Average weight of engine ready for installation (dry)	kg	1,780	1,880

For detailed examinations of installation dimensions, please order drawings from our factory.

# D2868

## Power charts

**LE 426**

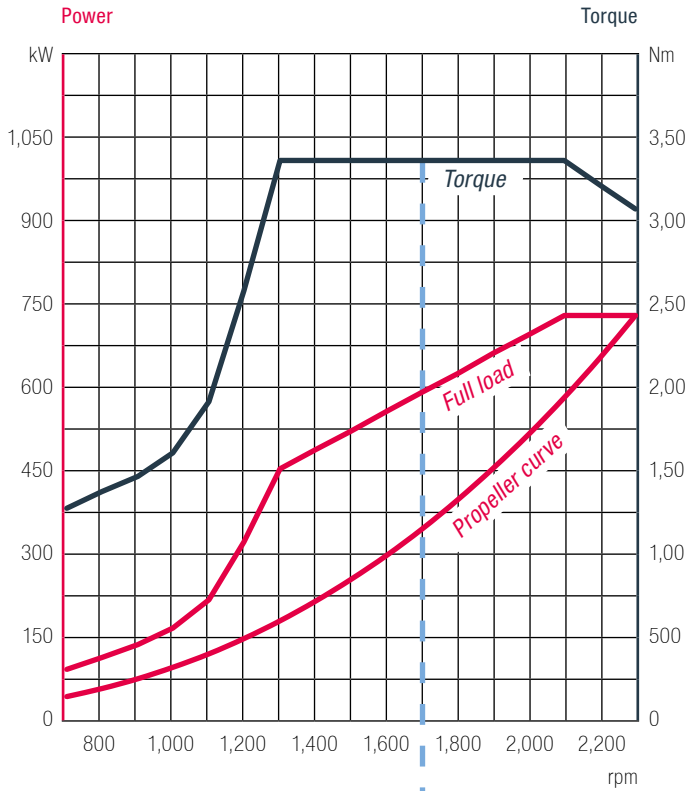

**LE 436**

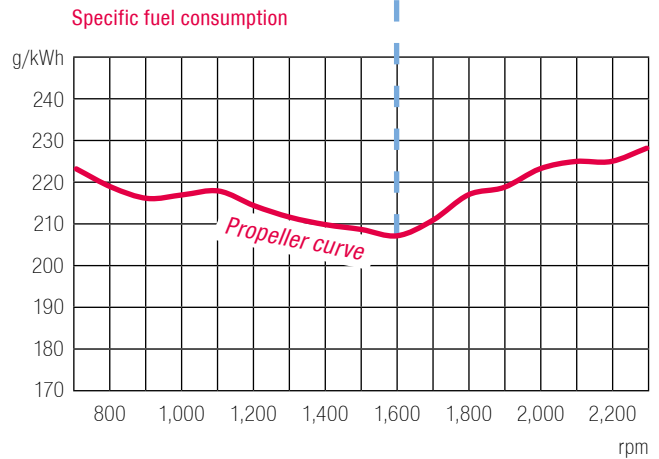
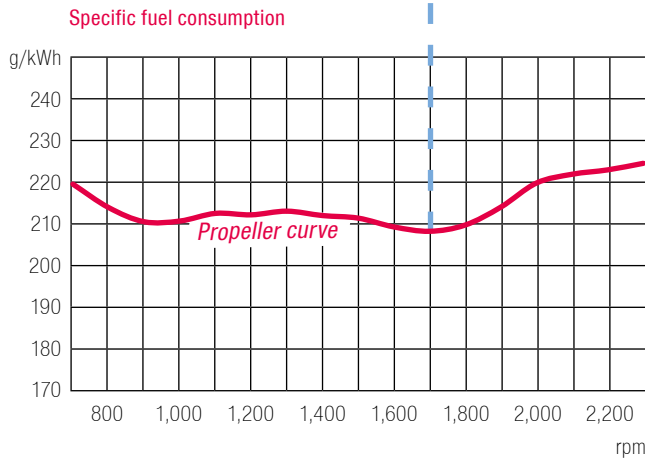
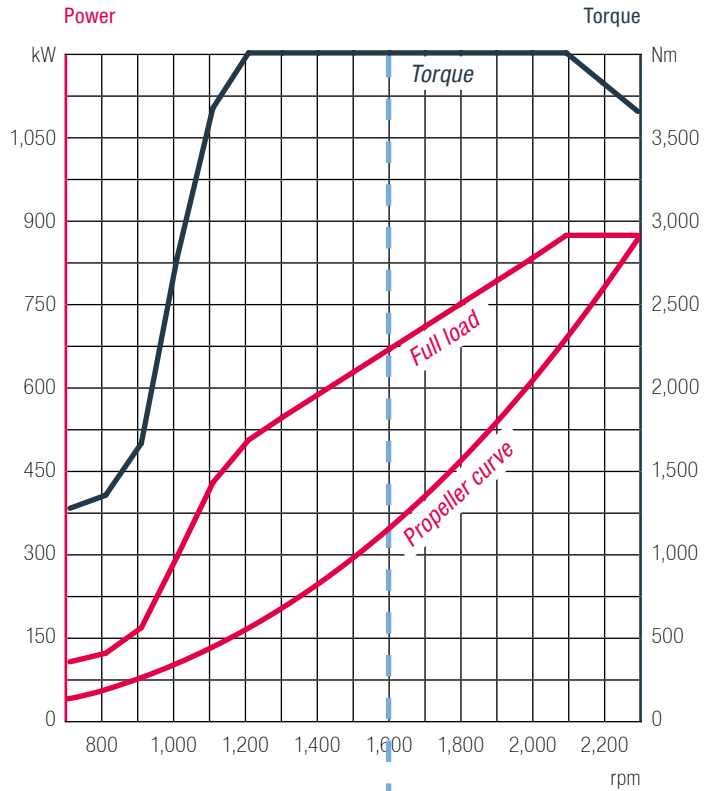

--- Maximum torque at most fuel efficient operating point



# D2862

## Engine description

### Characteristics

- Cylinders and arrangement: 12 cylinders in 90° V arrangement
- Operation mode: 4-stroke diesel engine, watercooled
- Turbocharging: Turbocharger with charge air intercooler and waste gate (1-stage: D2862 LE 446/426, 2-stage: D2862 LE 456/436)
- Number of valves: 4 valves per cylinder
- Fuel system: Common Rail direct fuel injection with electronic control
- Engine lubrication: Closed system with forced feeding, oil cooling and filtering
- Type of cooling: Plate heat exchanger, seawater cooled
- Engine control: Electronic injection control (EDC)  
Electronic engine monitoring including diagnostic unit
- Fuel: DIN EN 590

# D2862

## Technical data

### Technical features D2862

Type designation		LE 446	LE 426	LE 456	LE 436
Displacement	l	24.24	24.24	24.24	24.24
Maximum output to DIN ISO 3046-1	kW (hp)	1,029 (1,400)	1,140 (1,550)	1,213 (1,650)	1,324 (1,800)
Rated speed	rpm	2,300	2,300	2,300	2,300
Maximum torque	Nm	4,680	5,180	5,510	6,010
at speed	rpm	1,200–2,100	1,200–2,100	1,200–2,100	1,200–2,100
Lowest specific fuel consumption <sup>1)</sup>	g/kWh	203	203	195	200
Classifiable		✓	–	✓	–
Exhaust gas status		IMO Tier II, EPA Tier 3 <sup>2)</sup> , RCD 2013/53/EC, RCD 94/25/EC, 97/68/EC	IMO Tier II, EPA Tier 3 <sup>2)</sup> , RCD 2013/53/EC, RCD 94/25/EC, 97/68/EC	IMO Tier II, EPA Tier 3 <sup>2)</sup> , RCD 2013/53/EC, RCD 94/25/EC, 97/68/EC	IMO Tier II, EPA Tier 3 <sup>2)</sup> , RCD 2013/53/EC, RCD 94/25/EC, 97/68/EC

1) Tolerance +5% according to DIN ISO 3046-1

2) For private use only

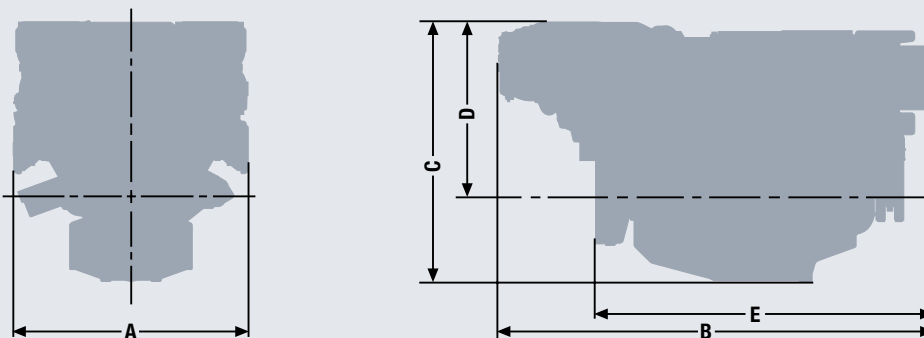

### Dimensions D2862

Type designation		LE 446/426	LE 456/436
A-Overall width	mm	1,153	1,153
B-Overall length	mm	2,130	2,139
C-Overall height	mm	1,230	1,272
D-Top of engine to crankshaft centre	mm	765	808
E-Length of engine from front end to edge of flywheel housing	mm	1,630	1,658
Average weight of engine ready for installation (dry)	kg	2,270	2,380

For detailed examinations of installation dimensions, please order drawings from our factory.

# D2862

## Power charts

LE 446

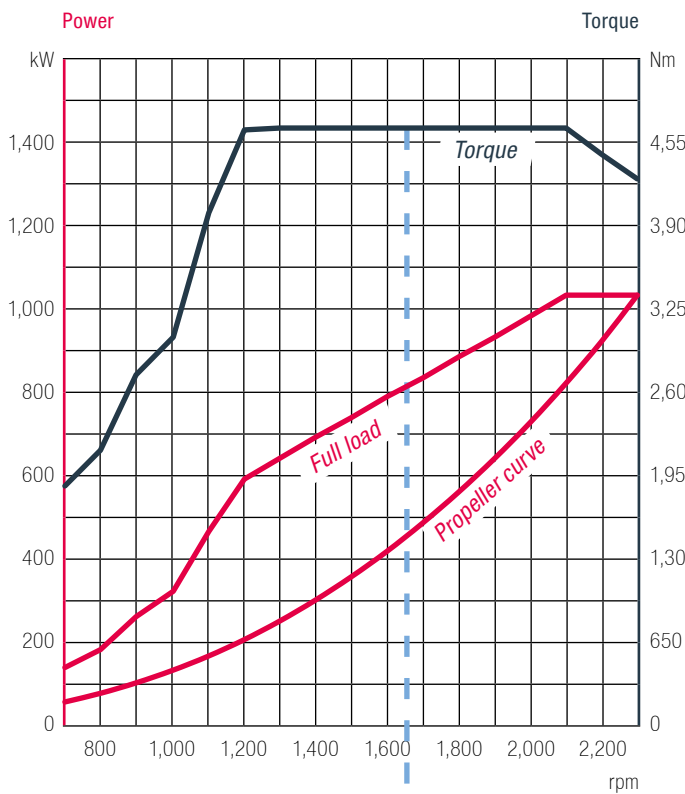

LE 426

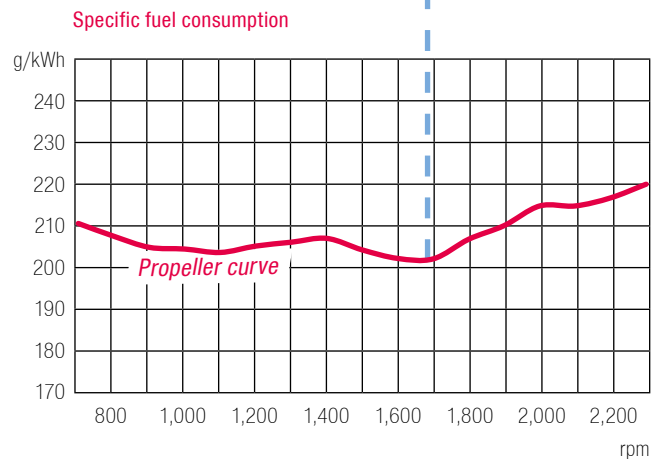
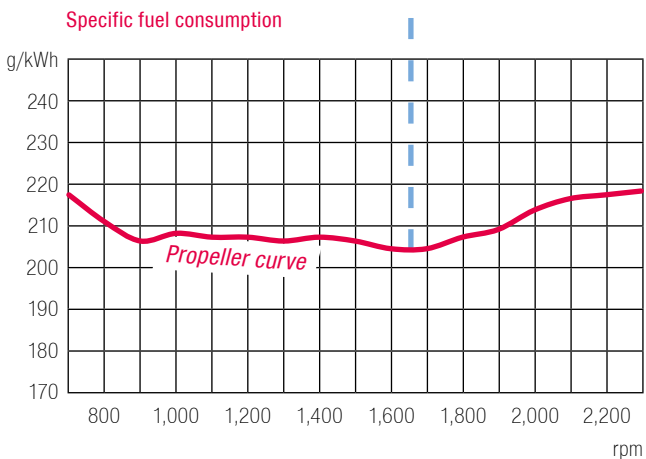
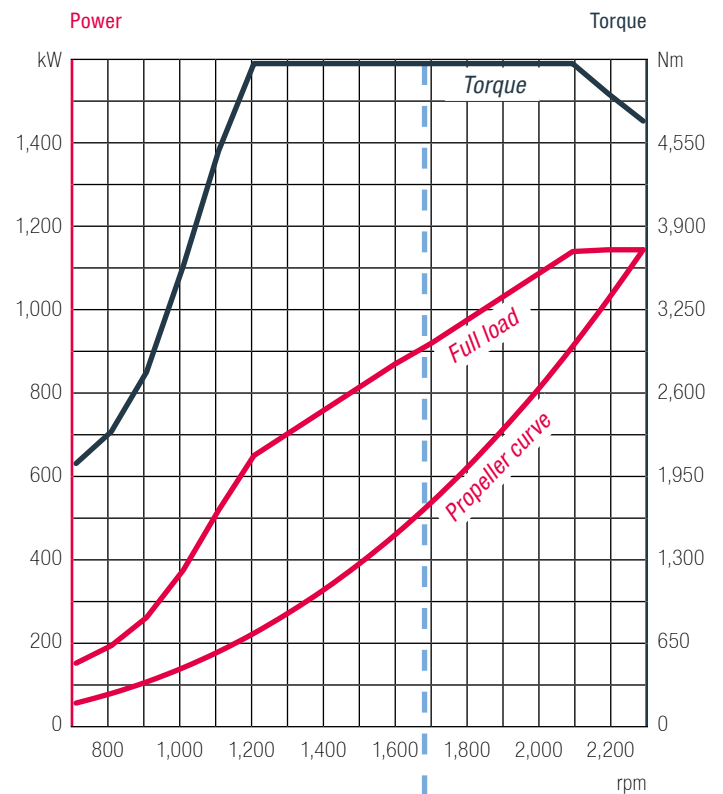

--- Maximum torque at most fuel efficient operating point

# D2862

## Power charts

LE 456

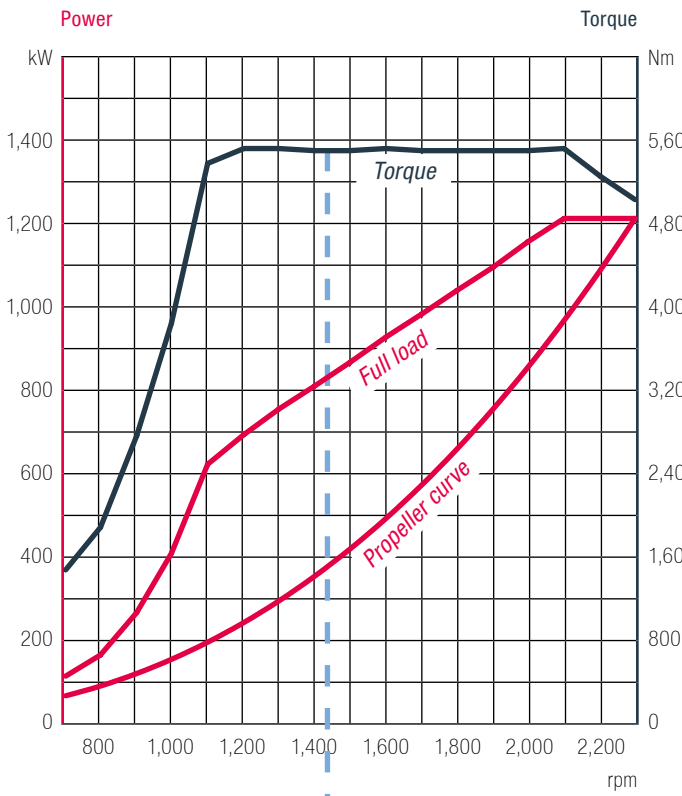

LE 436

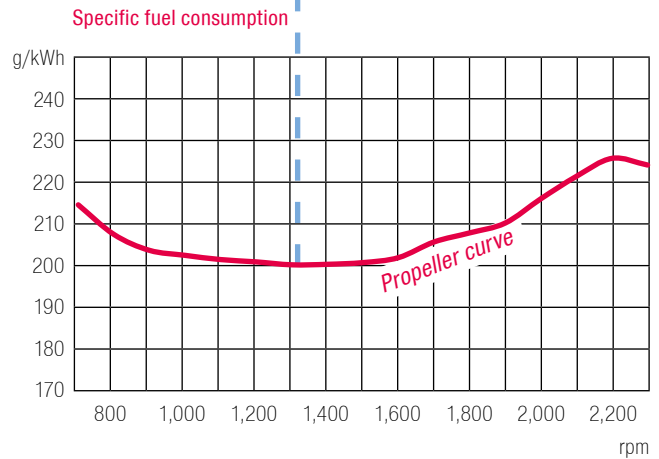
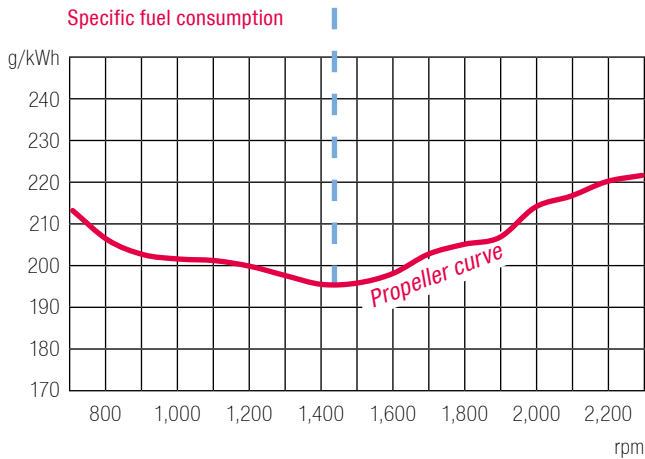
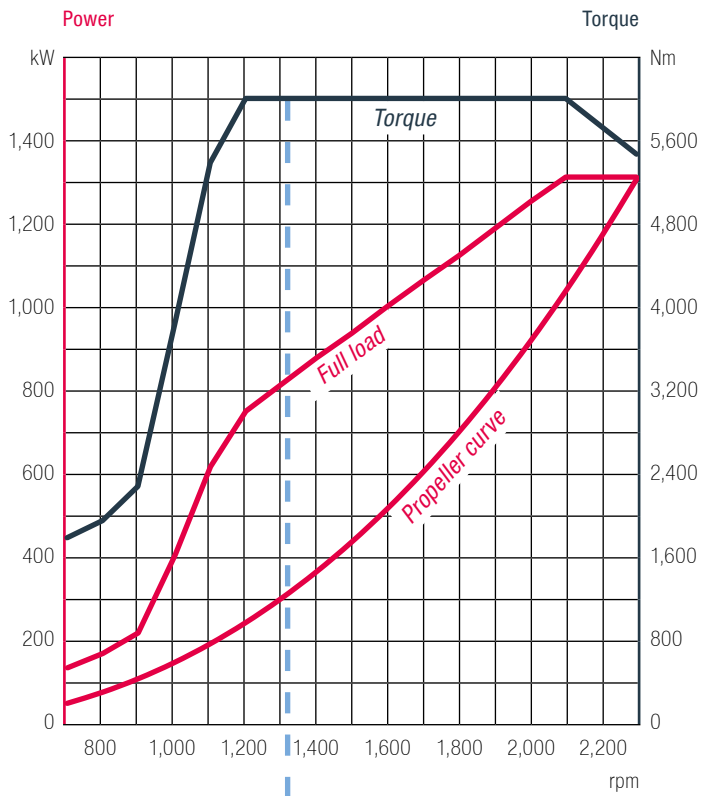

--- Maximum torque at most fuel efficient operating point



# Notes

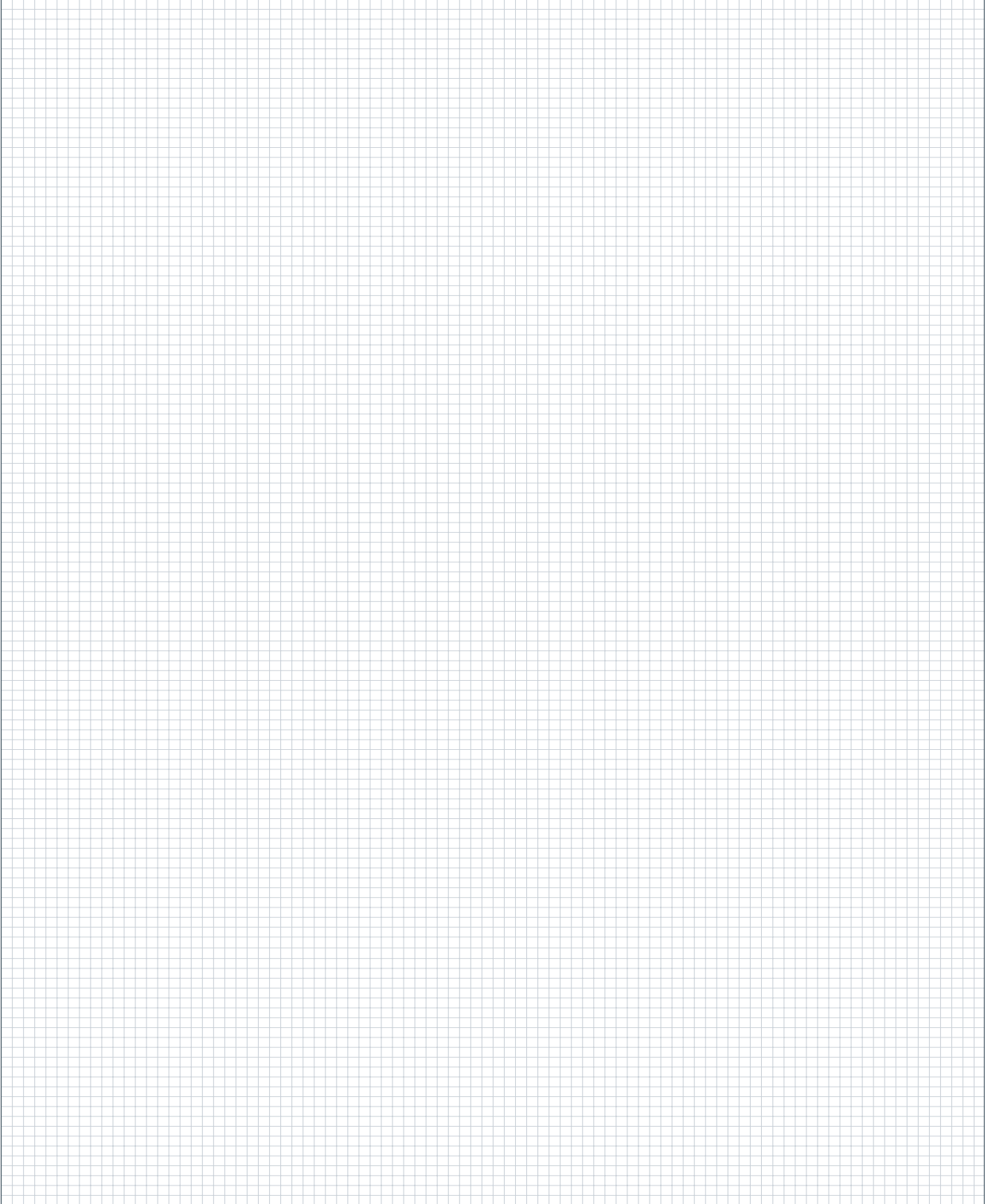



# Medium duty operation

## Definition of application type

### Characteristics

	<b>D2676</b> LE 422/LE 425 LE 432/LE 435	<b>D2862</b> LE 463/LE 466	<b>D2862</b> LE 425 LE 432/LE 435 <b>D2868</b> LE 422/LE 425/LE 443
■ Annual operating hours:	≤ 3,000	≤ 3,000	≤ 4,000
■ Percentage of time at full load:	≤ 50 %	≤ 20 %	
■ Average load application:	≤ 70 %	≤ 50 %	≤ 60 %

### Typical applications

- Escort boats and pilot boats
- Fishing boats
- Passenger boats and ferries
- Cruising vessels
- Seagoing patrol boats



# D2676

## Engine description

### Characteristics

- Cylinders and arrangement: 6 cylinders in-line
- Operation mode: 4-stroke diesel engine, watercooled
- Turbocharging: Turbocharger with charge air intercooler and wastegate
- Number of valves: 4 valves per cylinder
- Fuel system: Common rail injection with high pressure pump
- Engine block: High-strength casting with integrated oil and water ducts and replaceable cylinder liners
- Engine lubrication: Force-feed lubrication, lubrication oil cooler in cooling water circuit of the engine
- Type of cooling: Seawater cooled charge air cooler, plate heat exchanger by rubber impeller pump
- Engine control: Electronic injection control, electronic engine monitoring including diagnostic unit
- Fuel: DIN EN 590

# D2676

## Technical data

### Technical features D2676

Type designation		LE 432	LE 435	LE 422	LE 425
Displacement	l	12.42	12.42	12.42	12.42
Nominal rating <sup>1)</sup>	kW (hp)	412 (560)	412 (560)	478 (650)	478 (650)
Rated speed	rpm	2,100	2,100	2,100	2,100
Torque at rated speed	Nm	1,869	1,869	2,174	2,174
Maximum torque	Nm	2,065	2,065	2,402	2,402
at speed	rpm	1,200–1,900	1,200–1,900	1,200–1,900	1,200–1,900
Lowest specific fuel consumption	g/kWh	196	204	197	205
Classifiable		✓	✓	✓	✓
Exhaust gas status		IMO Tier II, RCD 94/25/EC, 97/68/EC	IMO Tier II, EPA Tier 3, RCD 2013/53/EC, RCD 94/25/EC, 97/68/EC	IMO Tier II, RCD 94/25/EC, 97/68/EC	IMO Tier II, EPA Tier 3, RCD 2013/53/EC, RCD 94/25/EC, 97/68/EC

1) Rating according to DIN 3046-1

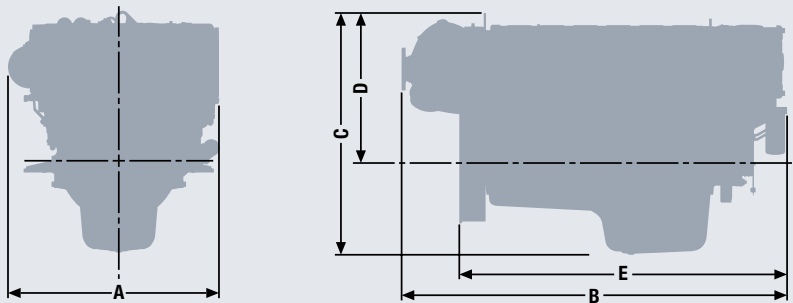

### Dimensions D2676

Type designation		LE 432/LE435/LE422/LE425
A-Overall width	mm	986
B-Overall length	mm	1,795
C-Overall height	mm	1,096
D-Top of engine to crankshaft centre	mm	674
E-Length of engine from front end to edge of flywheel housing	mm	1,527
Average weight of engine ready for installation (dry)	kg	1,215

For detailed examinations of installation dimensions, please order drawings from our factory.

# D2676

## Power charts

**D2676 LE 432**

**D2676 LE 435**

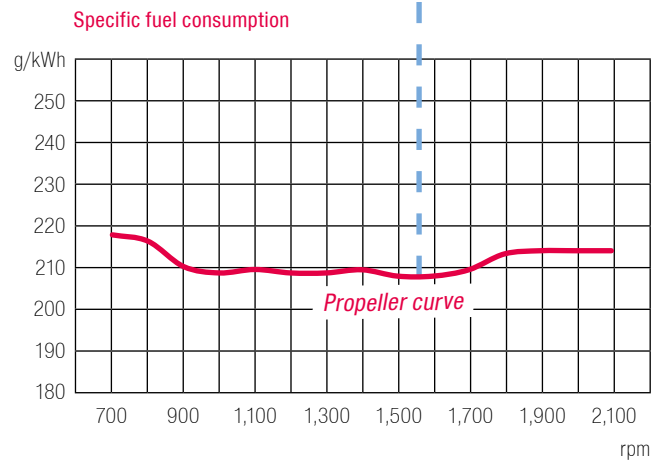
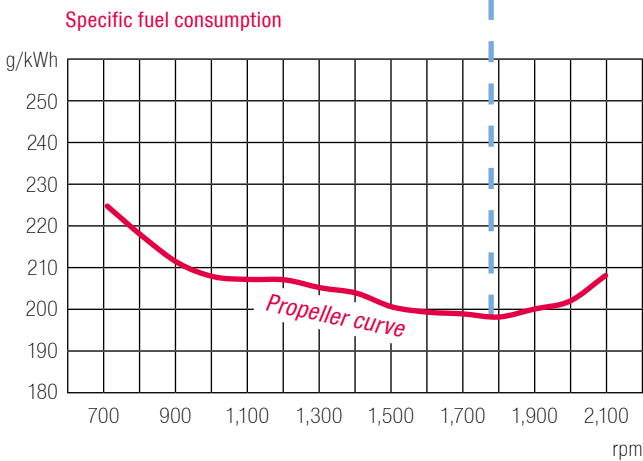
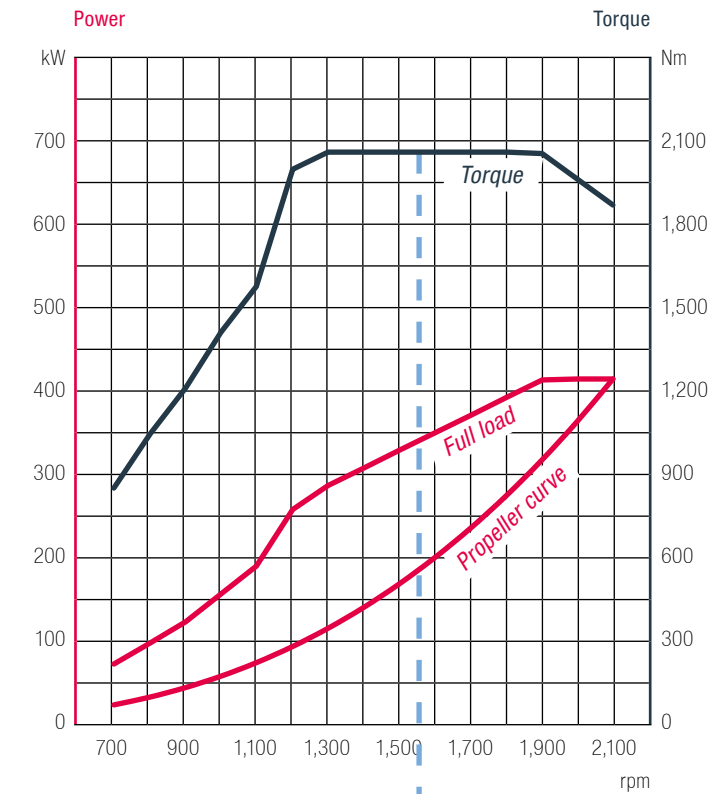
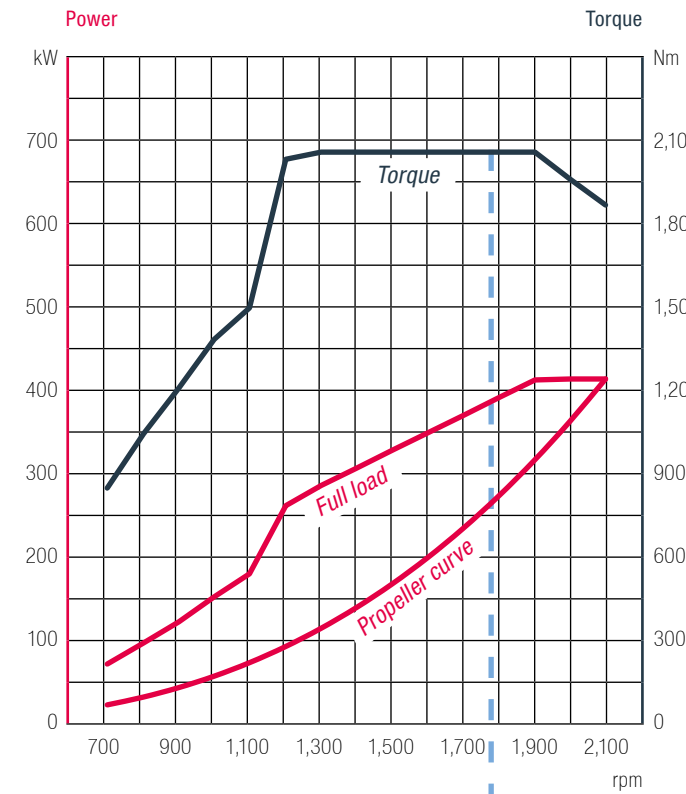

--- Maximum torque at most fuel efficient operating point

# D2676

## Power charts

D2676 LE 422

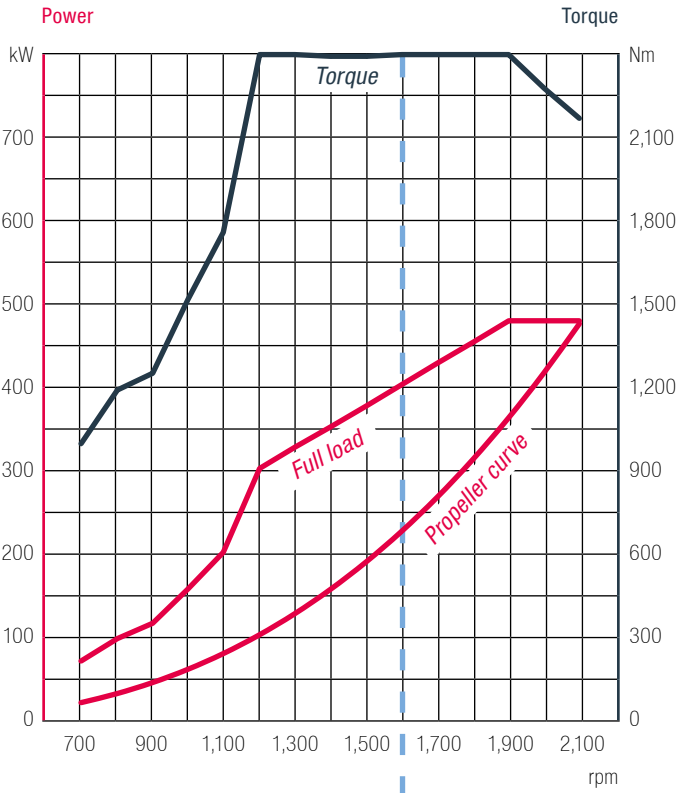

D2676 LE 425

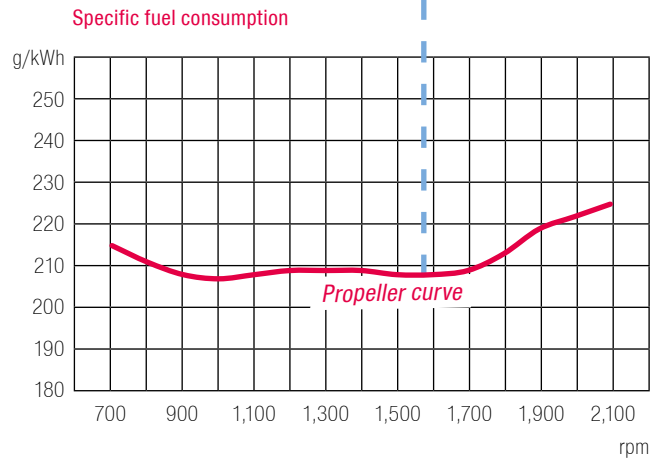
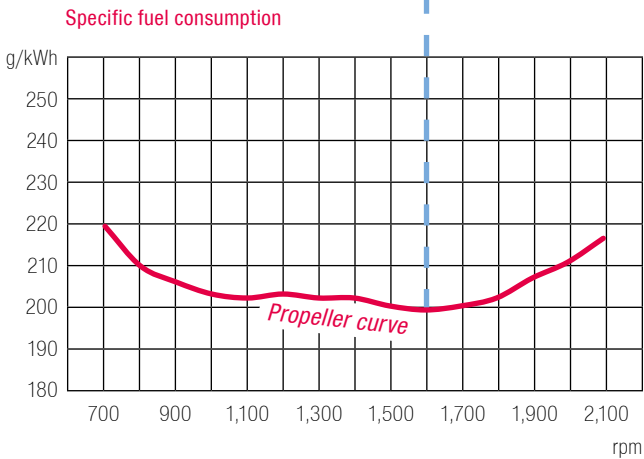
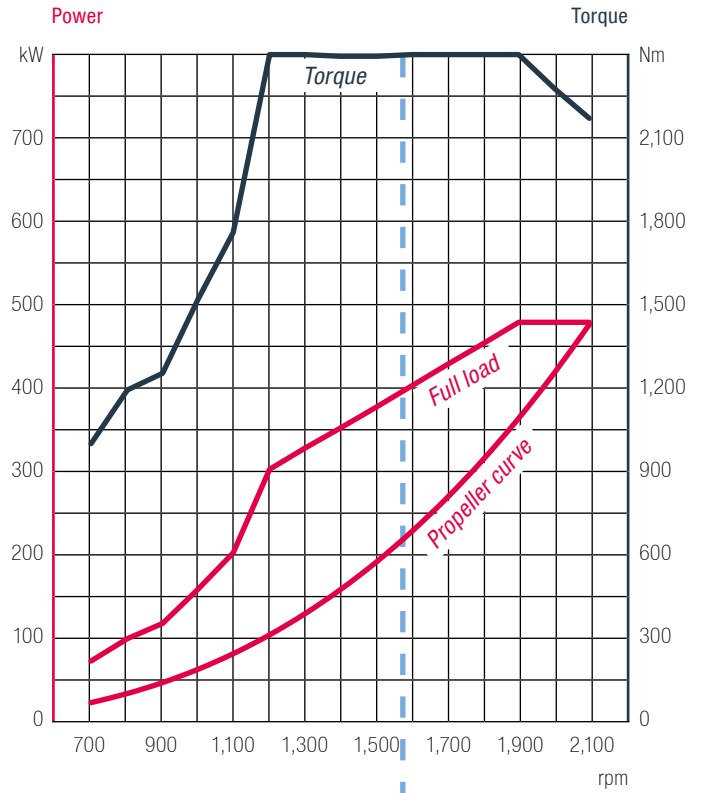

--- Maximum torque at most fuel efficient operating point

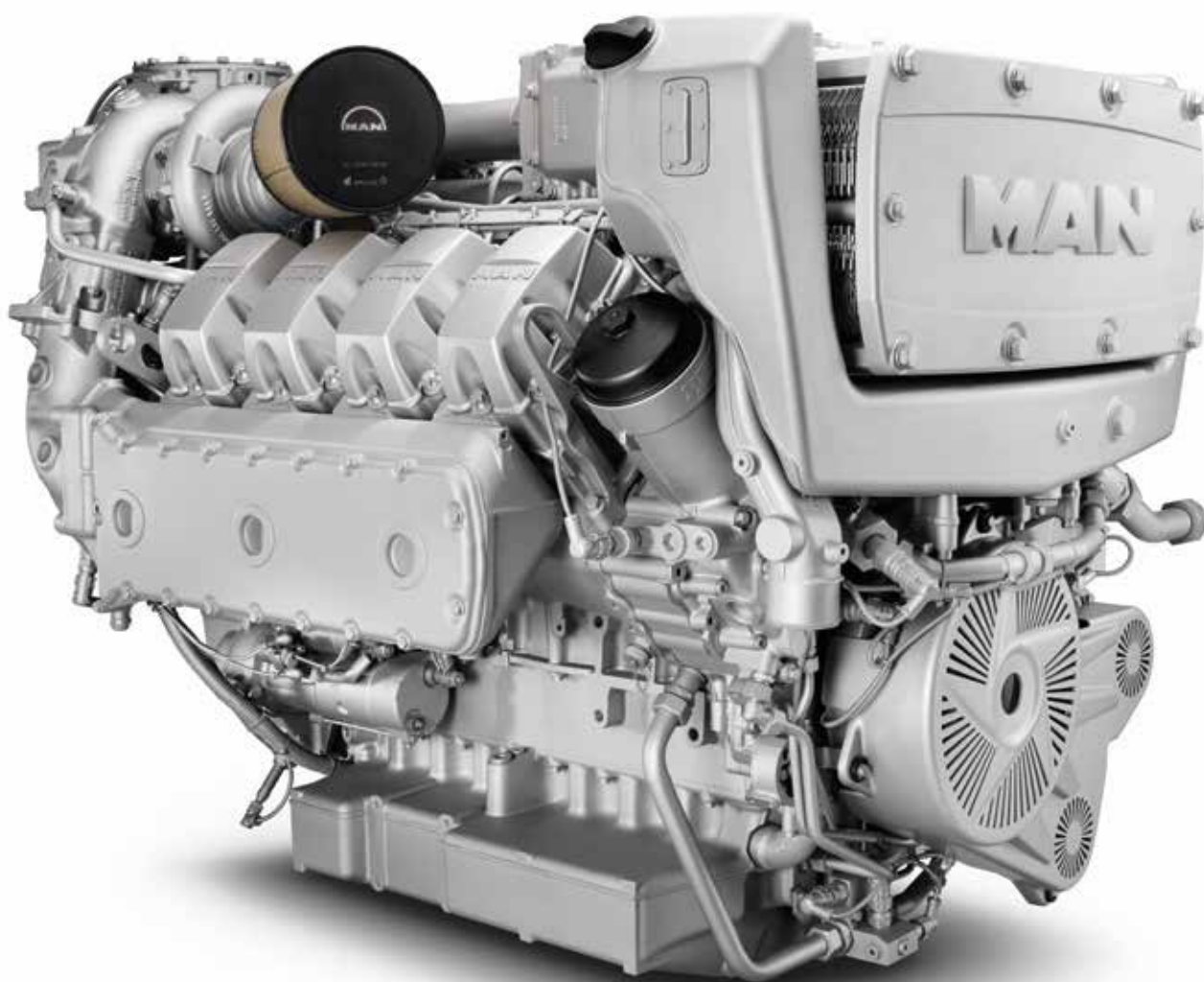

# D2868

## Engine description

### Characteristics

- Cylinders and arrangement: 8 cylinders in V arrangement
- Operation mode: 4-stroke diesel engine, watercooled
- Turbocharging: Turbocharger with charge air intercooler and wastegate
- Number of valves: 4 valves per cylinder
- Fuel system: Common Rail direct fuel injection
- Engine block: High-strength casting with integrated oil and water ducts and replaceable cylinder liners
- Engine Lubrication: Closed system with forced feeding, oil cooling and filtering
- Type of cooling: Plate heat exchanger, seawater cooled
- Engine control: Electronic injection control, Electronic engine monitoring including diagnostic unit
- Fuel: DIN EN 590

# D2868

## Technical data

### Technical features D2868

Type designation		LE 422	LE 425	LE 443
Displacement	l	16.16	16.16	16.16
Maximum output <sup>1)</sup>	kW (hp)	588 (800)	588 (800)	662 (900)
Rated speed	rpm	2,100	2,100	2,100
Torque at rated speed	Nm	2,674	2,674	3,010
Maximum torque	Nm	2,950	2,980	3,327
at speed	rpm	1,300–1,900	1,400–1,900	1,400–1,900
Lowest specific fuel consumption	g/kWh	198	209	207
Classifiable		✓	✓	–
Exhaust gas status		IMO Tier II, RCD 94/25/EC, 97/68/EC	IMO Tier II, EPA Tier 3, RCD 2013/53/EC, RCD 94/25/EC, 97/68/EC	IMO Tier II

1) Rating according to DIN 3046-1

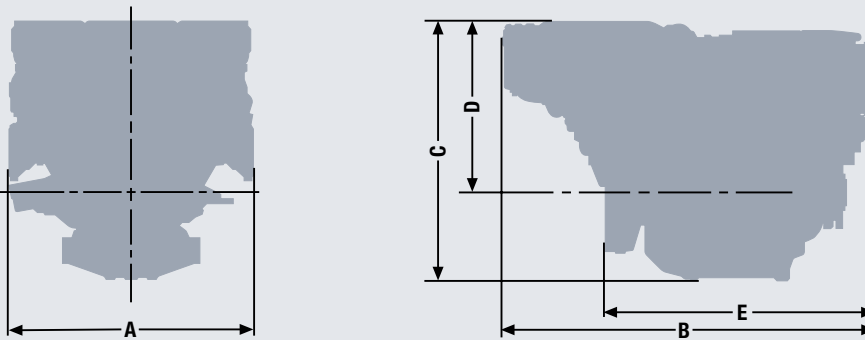

### Dimensions D2868

Type designation		LE 422/LE 425/LE 432
A-Overall width	mm	1,153
B-Overall length	mm	1,745
C-Overall height	mm	1,243
D-Top of engine to crankshaft centre	mm	765
E-Length of engine from front end to edge of flywheel housing	mm	1,177
Average weight of engine ready for installation (dry)	kg	1,780

For detailed examinations of installation dimensions, please order drawings from our factory.



# D2868

## Power charts

medium duty

D2868 LE 422

D2868 LE 425

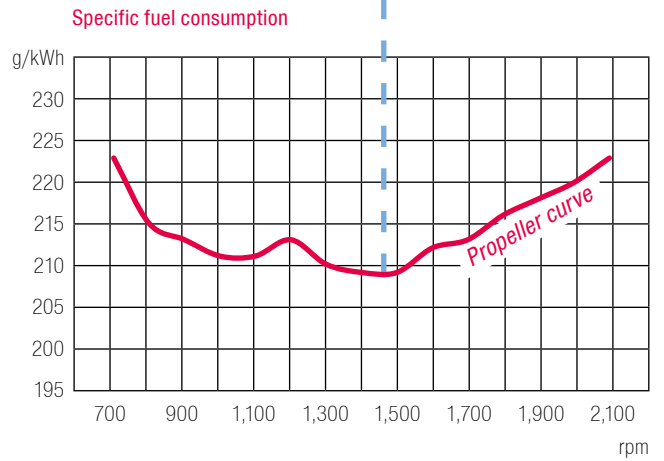
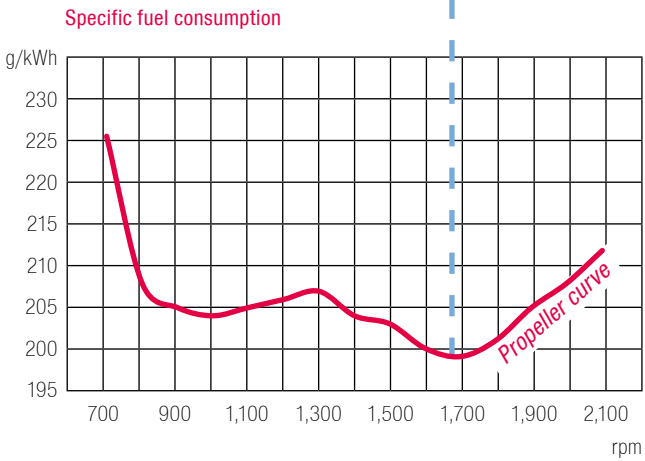
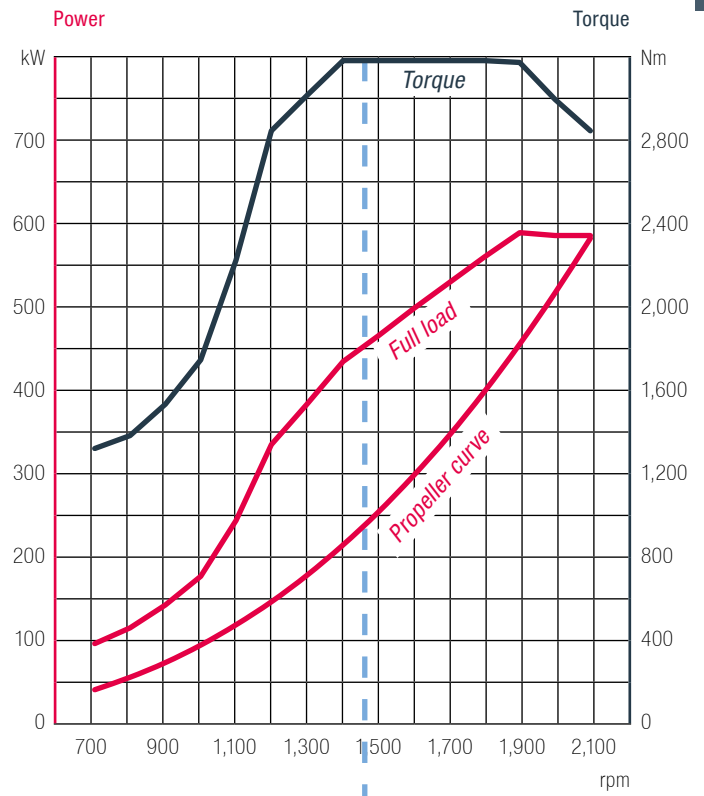
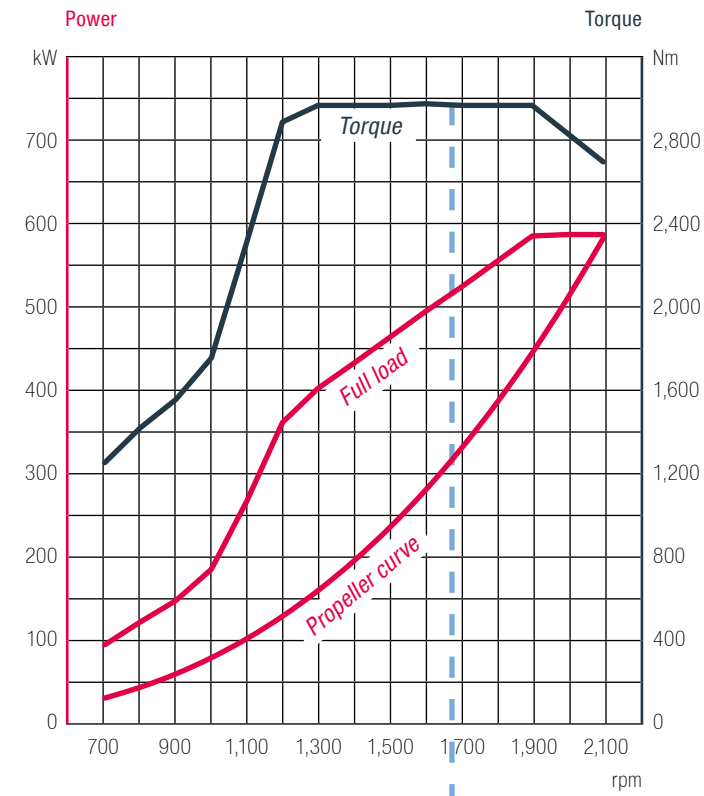

--- Maximum torque at most fuel efficient operating point

# D2868

## Power charts

### D2868 LE 443

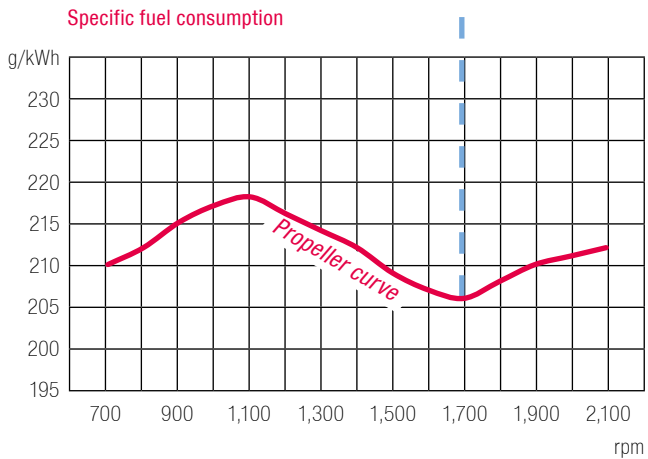
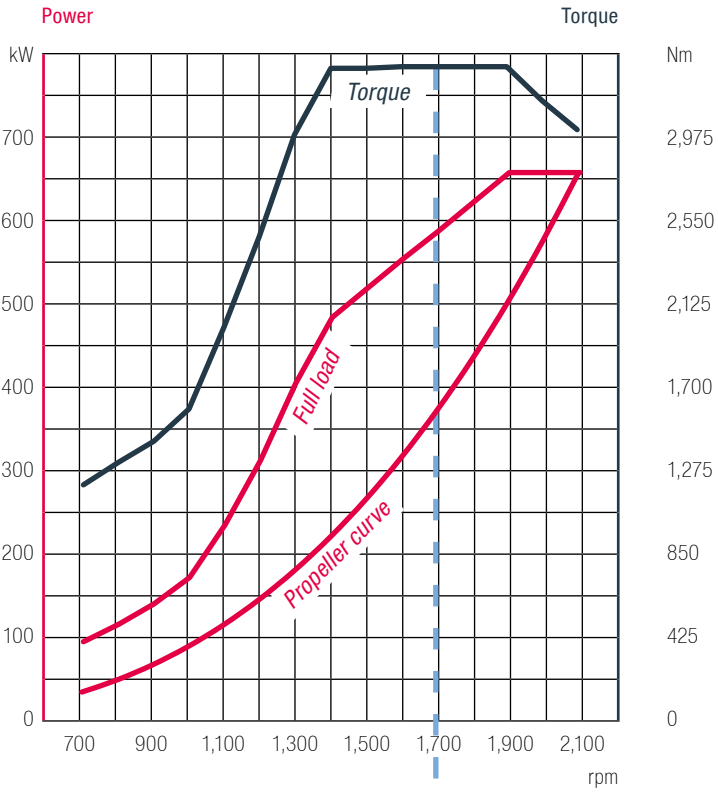

--- Maximum torque at most fuel efficient operating point



# D2862

## Engine description

### Characteristics

- Cylinders and arrangement: 12 cylinders in V arrangement
- Operation mode: 4-stroke diesel engine, watercooled
- Turbocharging: Turbocharger with charge air intercooler and wastegate
- Number of valves: 4 valves per cylinder
- Fuel system: Common Rail direct fuel injection with electronic control
- Engine block: High-strength casting with integrated oil and water ducts and replaceable cylinder liners
- Engine lubrication: Closed system with forced feeding, oil cooling and filtering
- Type of cooling: Plate heat exchanger seawater cooled
- Engine control: Electronic injection control (EDC)  
Electronic engine monitoring including diagnostic unit
- Fuel: DIN EN 590

# D2862

## Technical data

### Technical features D2862

Type designation		LE 425
Displacement	l	24,24
Nominal rating <sup>1)</sup>	kW (hp)	749 (1,019)
Rated speed	rpm	2,100
Torque at rated speed	Nm	3,406
Maximum torque	Nm	3,770
at speed	rpm	1,100–1,900
Lowest specific fuel consumption	g/kWh	200
Classifiable		✓
Exhaust gas status		IMO Tier II, EPA Tier 3, RCD 2013/53/EC , RCD 94/25/EC, 97/68/EC

1) Rating according to DIN 3046-1

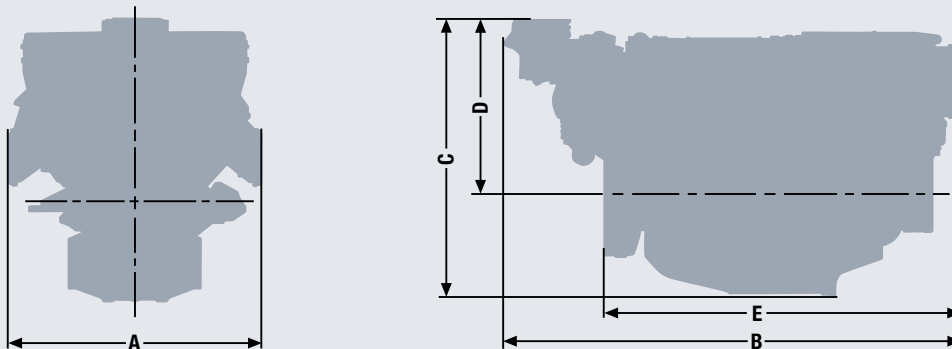

### Dimensions D2862

Type designation		LE 425
A-Overall width	mm	1,153
B-Overall length	mm	2,130
C-Overall height	mm	1,230
D-Top of engine to crankshaft centre	mm	765
E-Length of engine from front end to edge of flywheel housing	mm	1,630
Average weight of engine ready for installation (dry)	kg	2,270

For detailed examinations of installation dimensions, please order drawings from our factory.

# D2862

## Power charts

### D2862 LE 425

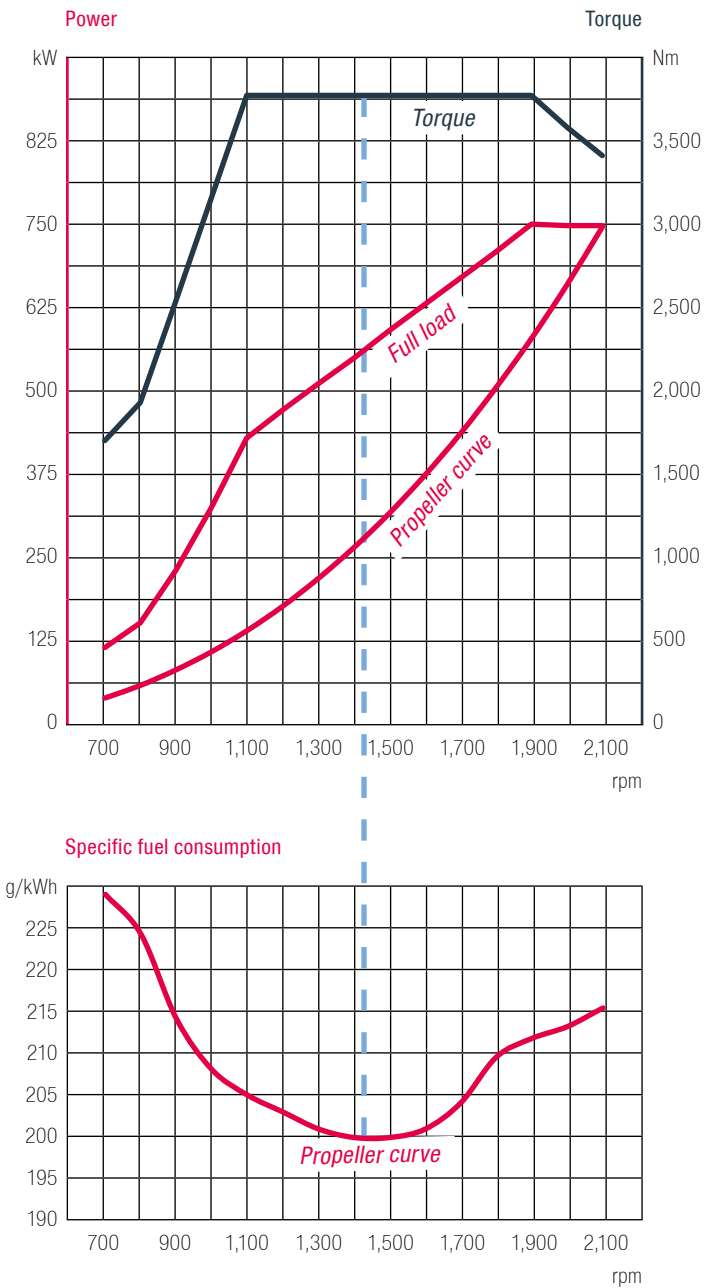

--- Maximum torque at most fuel efficient operating point

# D2862

## Technical data

### Technical features D2862

Type designation		LE 432	LE 435
Displacement	l	24.24	24.24
Nominal rating <sup>1)</sup>	kW (hp)	882 (1,200)	882 (1,200)
Rated speed	rpm	2,100	2,100
Torque at rated speed	Nm	4,010	4,010
Maximum torque	Nm	4,450	4,450
at speed	rpm	1,300–1,900	1,400–1,900
Lowest specific fuel consumption	g/kWh	198	203
Classifiable		✓	✓
Exhaust gas status		IMO Tier II, RCD 94/25/EC, 97/68/EC	IMO Tier II, EPA Tier 3, RCD 2013/53/EC, RCD 94/25/EC, 97/68/EC

1) Rating according to DIN 3046-1

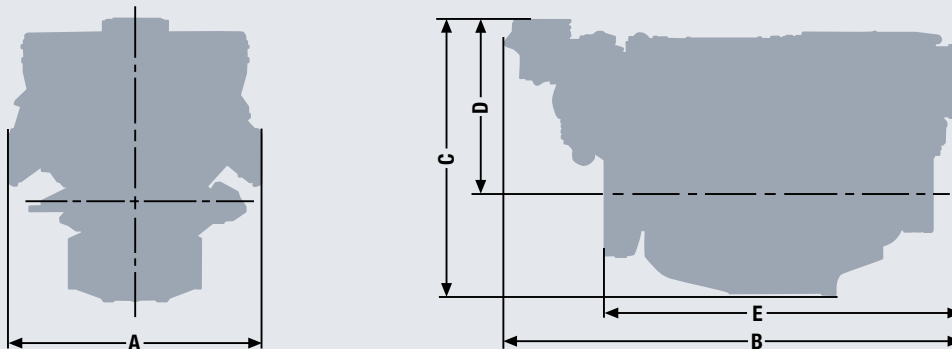

### Dimensions D2862

Type designation		LE 432/435
A-Overall width	mm	1,153
B-Overall length	mm	2,130
C-Overall height	mm	1,230
D-Top of engine to crankshaft centre	mm	765
E-Length of engine from front end to edge of flywheel housing	mm	1,630
Average weight of engine ready for installation (dry)	kg	2,270

For detailed examinations of installation dimensions, please order drawings from our factory.

# D2862

## Power charts

D2862 LE 432

D2862 LE 435

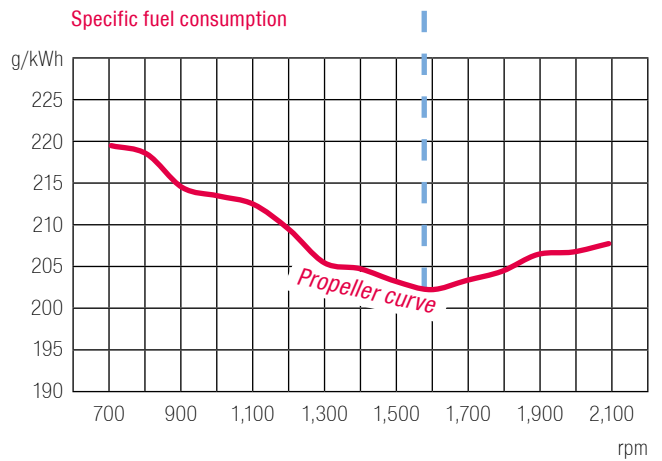
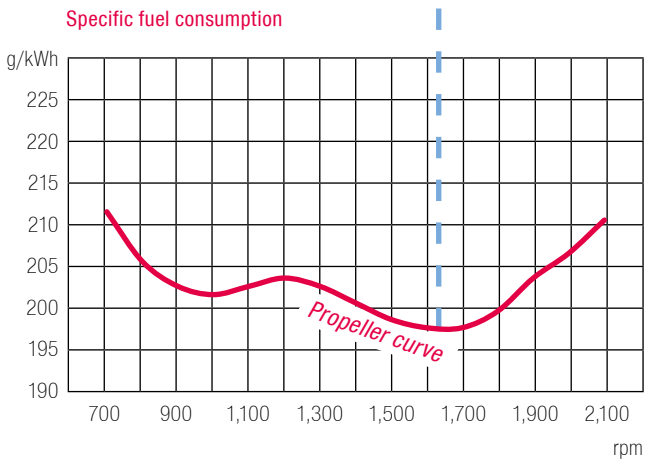
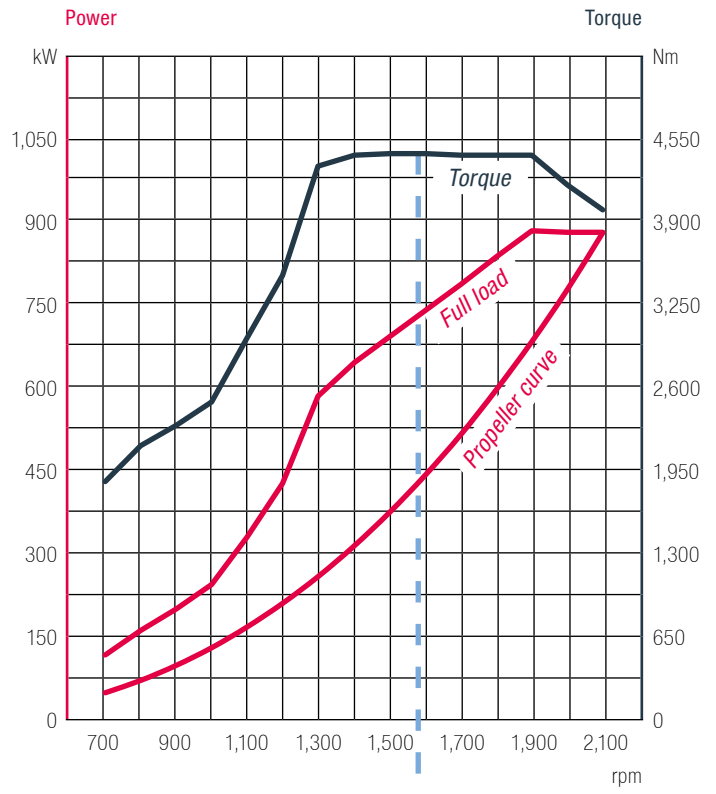
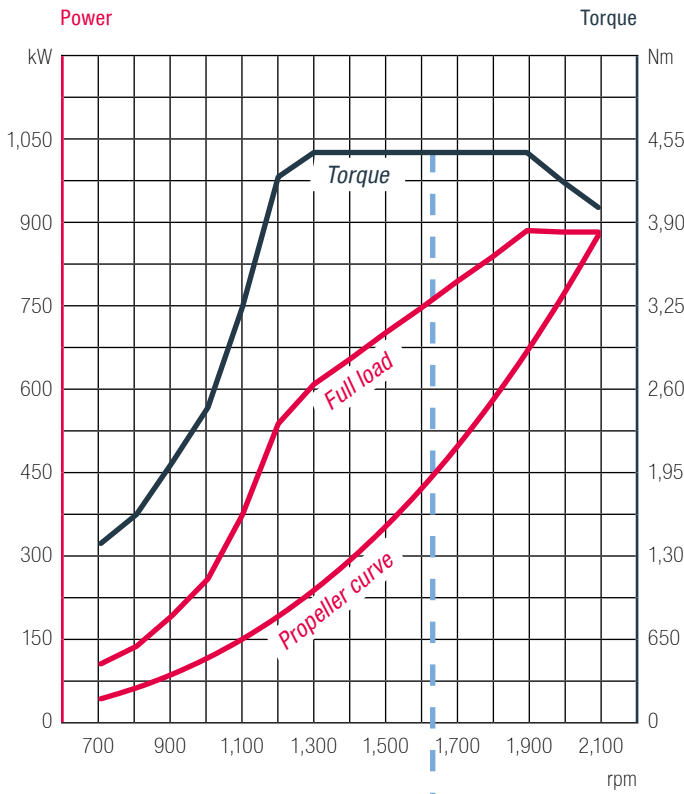

--- Maximum torque at most fuel efficient operating point

# D2862

## Technical data

### Technical features D2862

Type designation		LE 463	LE 466
Displacement	l	24.24	24.24
Nominal rating <sup>1)</sup>	kW (hp)	1,029 (1,400)	1,029 (1,400)
Rated speed	rpm	2,100	2,100
Torque at rated speed	Nm	4,680	4,680
Maximum torque	Nm	5,120	5,180
at speed	rpm	1,300–1,900	1,300–1,900
Lowest specific fuel consumption	g/kWh	200	203
Classifiable		✓	✓
Exhaust gas status		IMO Tier II, RCD 94/25/EC, 97/68/EC	IMO Tier II, EPA Tier 3 <sup>2)</sup> , RCD 2013/53/EC, RCD 94/25/EC, 97/68/EC

1) Rating according to DIN 3046-1

2) Only in 2016

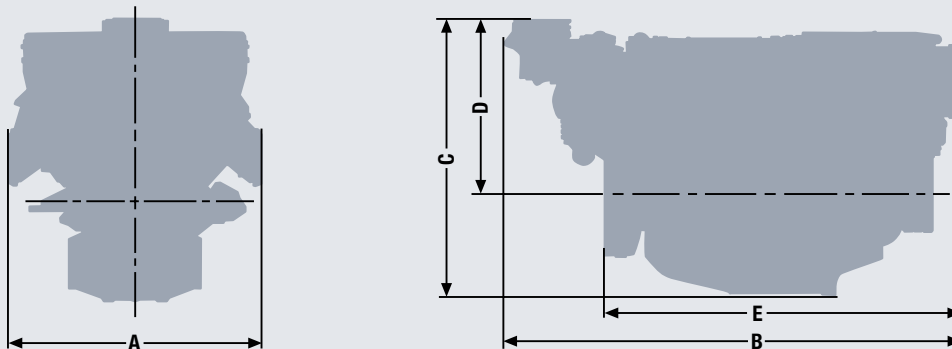

### Dimensions D2862

Type designation		LE 463/466
A-Overall width	mm	1,153
B-Overall length	mm	2,130
C-Overall height	mm	1,230
D-Top of engine to crankshaft centre	mm	765
E-Length of engine from front end to edge of flywheel housing	mm	1,630
Average weight of engine ready for installation (dry)	kg	2,270

For detailed examinations of installation dimensions, please order drawings from our factory.



# D2862

## Power charts

**D2862 LE 463**

**D2862 LE 466**

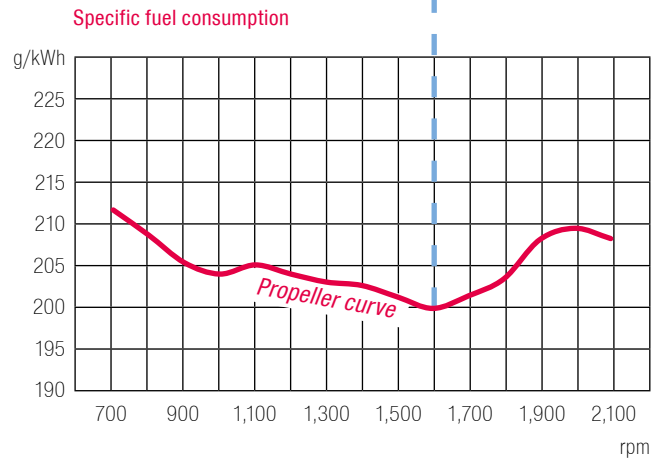
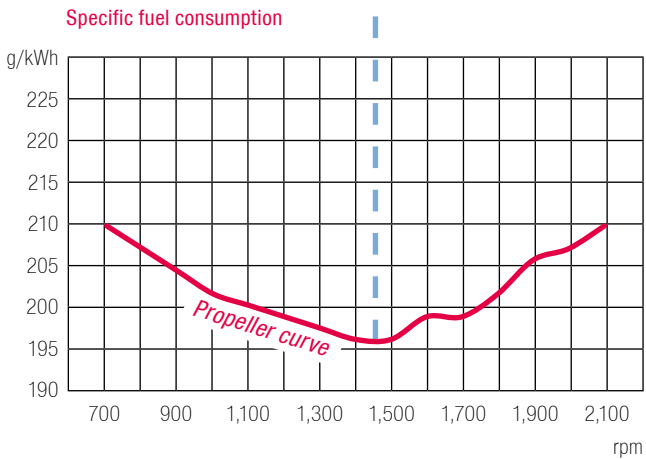
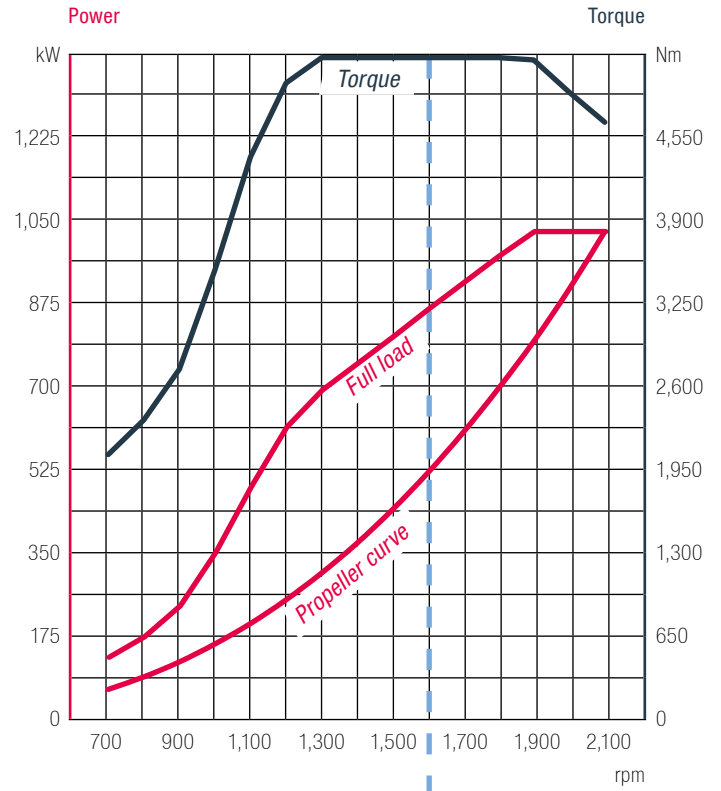
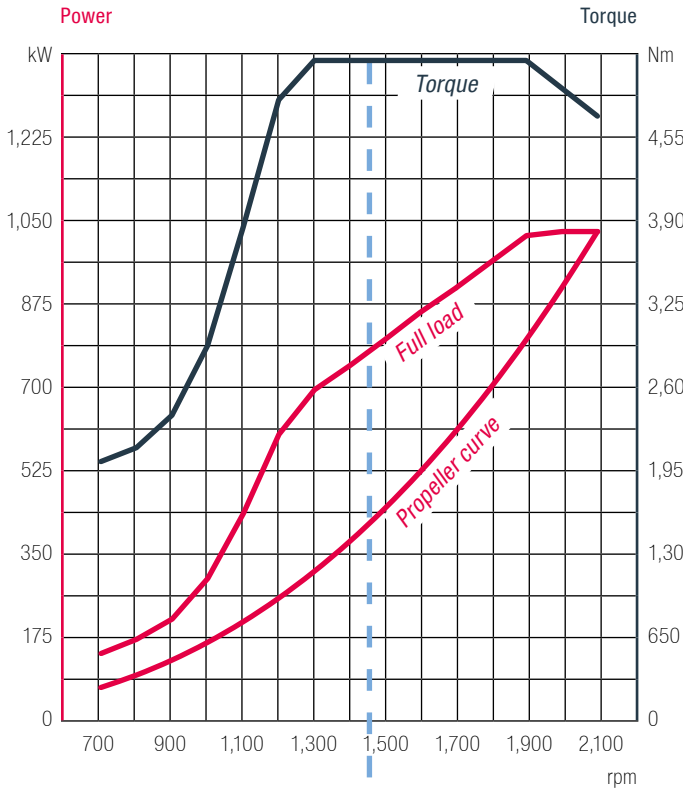

--- Maximum torque at most fuel efficient operating point



# Heavy duty operation

## Definition of application type

### Characteristics

- Annual operating hours: unlimited
- Percentage of time at full load:  $\leq 100\%$
- Average load application:  $\leq 100\%$

### Typical applications

- Trawlers
- Tugs and pushboats
- Freight barges and freighters
- Ferries
- Dredgers



# D2676

## Engine description

### Characteristics

- **Cylinders and arrangement:** 6 cylinders in-line
- **Operation mode:** 4-stroke diesel engine, watercooled
- **Turbocharging:** Turbocharger with charge air intercooler and wastegate
- **Number of valves:** 4 valves per cylinder
- **Fuel system:** Common rail injection with high pressure pump
- **Engine block:** High-strength casting with integrated oil and water ducts and replaceable cylinder liners
- **Engine lubrication:** Force-feed lubrication, lubrication oil cooler in cooling water circuit of the engine
- **Type of cooling:** Seawater cooled charge air cooler, plate heat exchanger by rubber impeller pump
- **Engine control:** Electronic injection control, electronic engine monitoring including diagnostic unit
- **Fuel:** DIN EN 590

# D2676

## Technical data

### Technical features D2676

Type designation		LE 461	LE 451	LE 441
Displacement	l	12.42	12.42	12.42
Nominal rating <sup>1)</sup>	kW (hp)	147 (200)	210 (286)	270 (367)
Rated speed	rpm	1,800	1,800	1,800
Torque at rated speed	Nm	780	1,114	1,432
Maximum torque	Nm	880	1,250	1,616
at speed	rpm	1,200–1,600	1,200–1,600	1,200–1,600
Lowest specific fuel consumption	g/kWh	221	214	212
Classifiable		✓	✓	✓
Exhaust gas status		IMO Tier II, 97/68/EC	IMO Tier II, 97/68/EC	IMO Tier II, 97/68/EC

1) The rating is according to DIN 3046/1

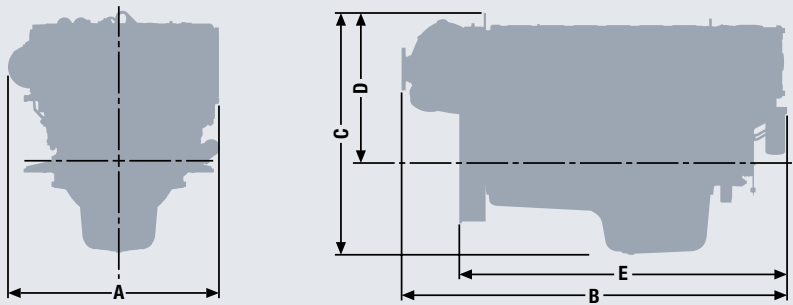

### Dimensions D2676

Type designation		LE 461/LE 451 /LE 441
A-Overall width	mm	986
B-Overall length	mm	1,795
C-Overall height	mm	1,096
D-Top of engine to crankshaft centre	mm	674
E-Length of engine from front end to edge of flywheel housing	mm	1,527
Average weight of engine ready for installation (dry)	kg	1,215

For detailed examinations of installation dimensions, please order drawings from our factory.

# D2676

## Power charts

D2676 LE 461

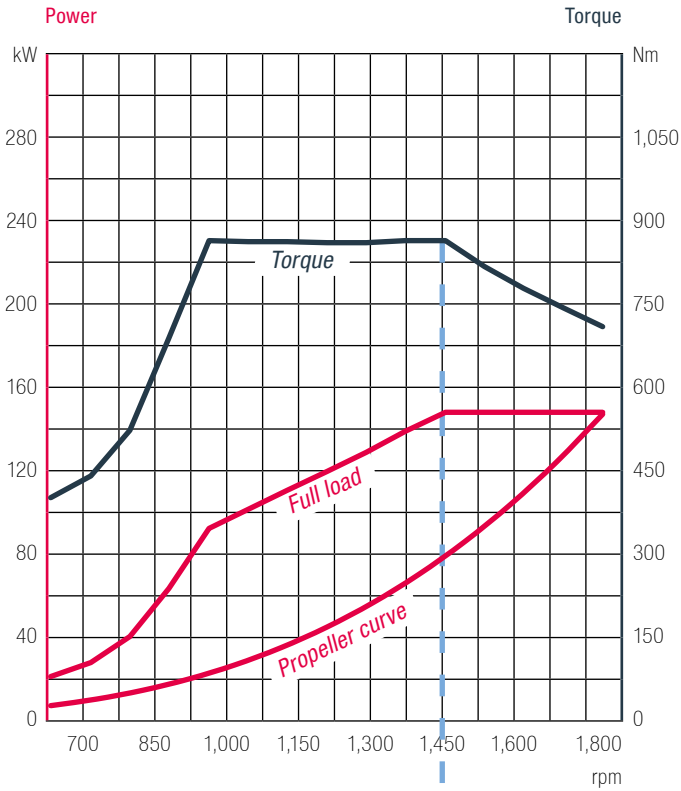

D2676 LE 451

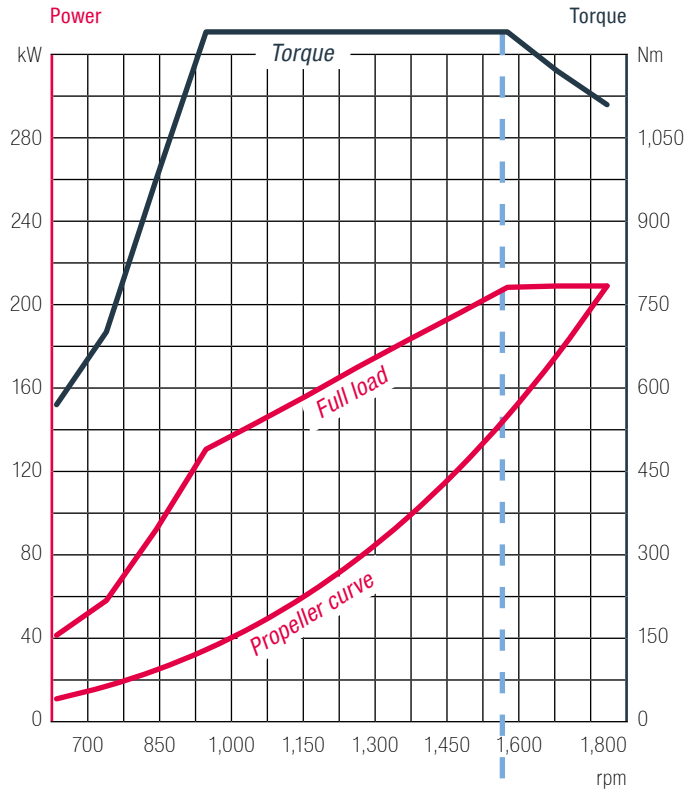

Specific fuel consumption

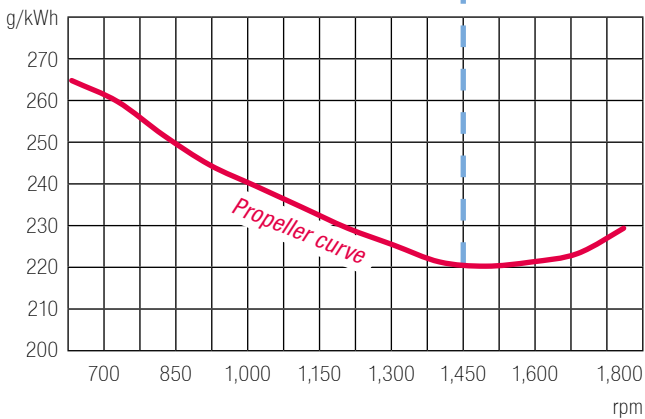

Specific fuel consumption

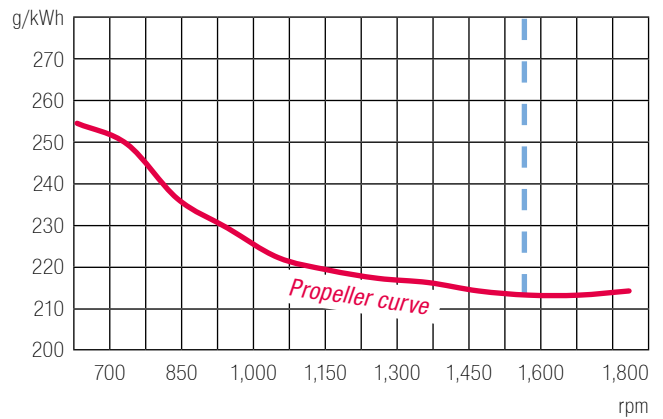

--- Maximum torque at most fuel efficient operating point

# D2676

## Power charts

### D2676 LE 441

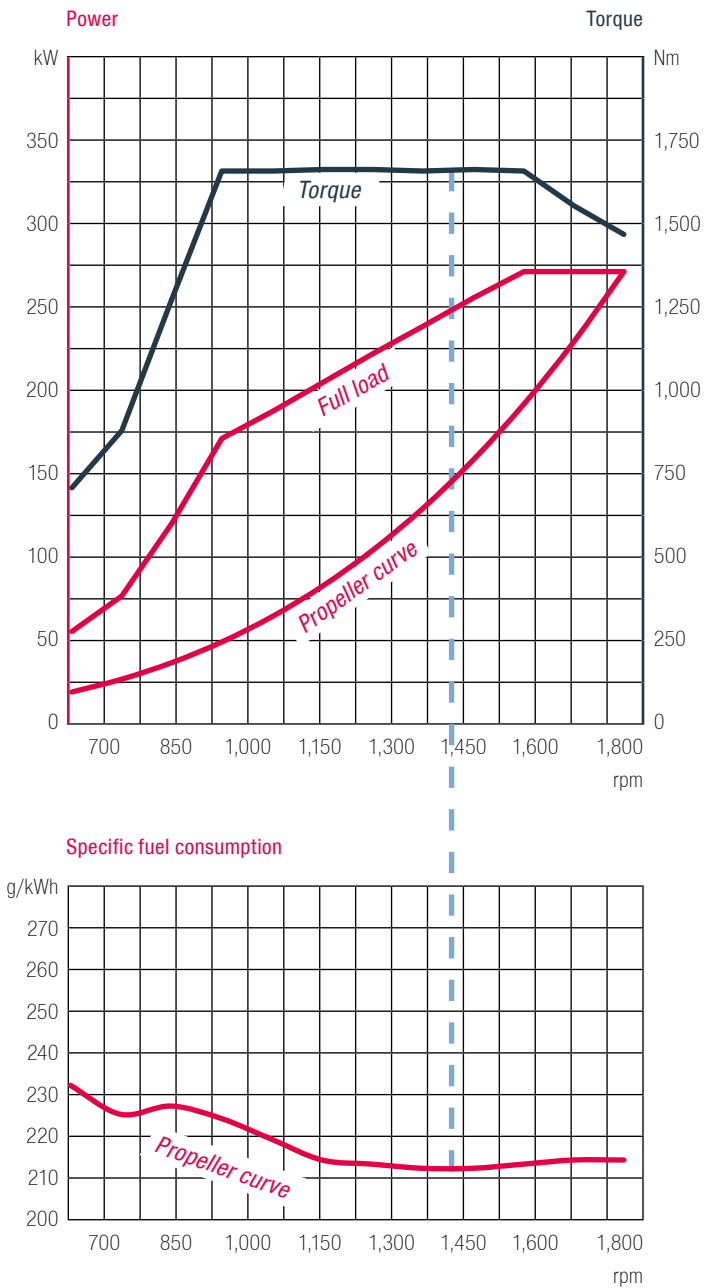

--- Maximum torque at most fuel efficient operating point

# D2676

## Technical data

### Technical features D2676

Type designation		LE 431	LE 434	LE 421	LE 424
Displacement	l	12.42	12.42	12.42	12.42
Nominal rating <sup>1)</sup>	kW (hp)	324 (440)	324 (440)	382 (520)	382 (520)
Rated speed	rpm	1,800	1,800	1,800	1,800
Torque at rated speed	Nm	1,719	1,719	2,027	2,027
Maximum torque	Nm	1,925	1,925	2,275	2,270
at speed	rpm	1,200–1,600	1,200–1,600	1,200–1,600	1,200–1,600
Specific fuel consumption <sup>2)</sup>	g/kWh	205	210	207	212
Classifiable		✓	✓	✓	✓
Exhaust gas status		IMO Tier II, RCD 94/25/EC, 97/68/EC	IMO Tier II, EPA Tier 3, RCD 2013/53/EC, RCD 94/25/EC, 97/68/EC	IMO Tier II, RCD 94/25/EC, 97/68/EC	IMO Tier II, EPA Tier 3, RCD 2013/53/EC, RCD 94/25/EC, 97/68/EC

1) The rating is according to DIN 3046/1

2) Consumption at rated power

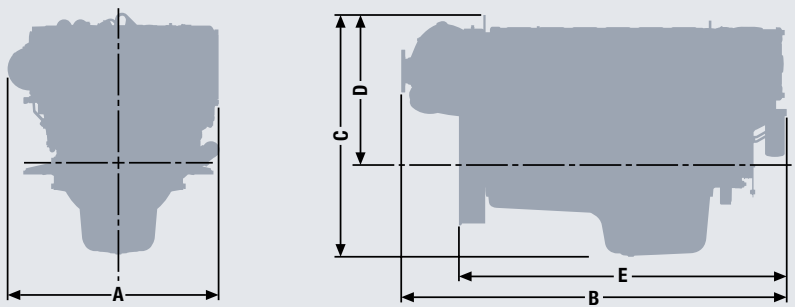

### Dimensions D2676

Type designation		LE 431/LE 434 /LE 421/LE 424
A-Overall width	mm	986
B-Overall length	mm	1,795
C-Overall height	mm	1,096
D-Top of engine to crankshaft centre	mm	674
E-Length of engine from front end to edge of flywheel housing	mm	1,527
Average weight of engine ready for installation (dry)	kg	1,215

For detailed examinations of installation dimensions, please order drawings from our factory.

# D2676

## Power charts

**D2676 LE 431**

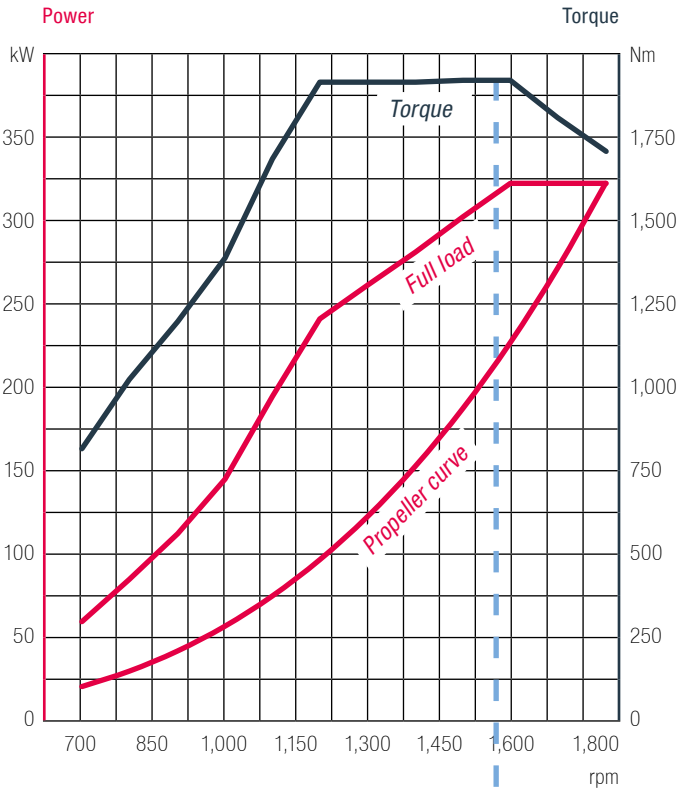

**D2676 LE 434**

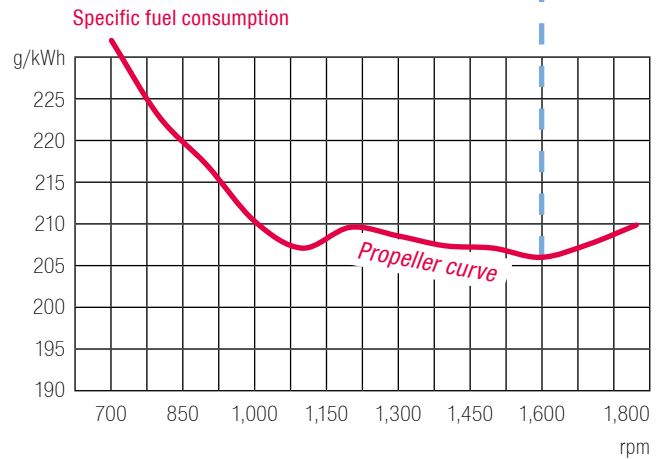
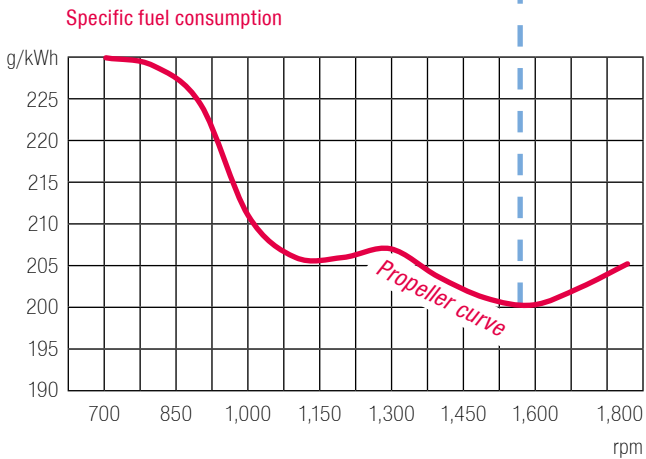
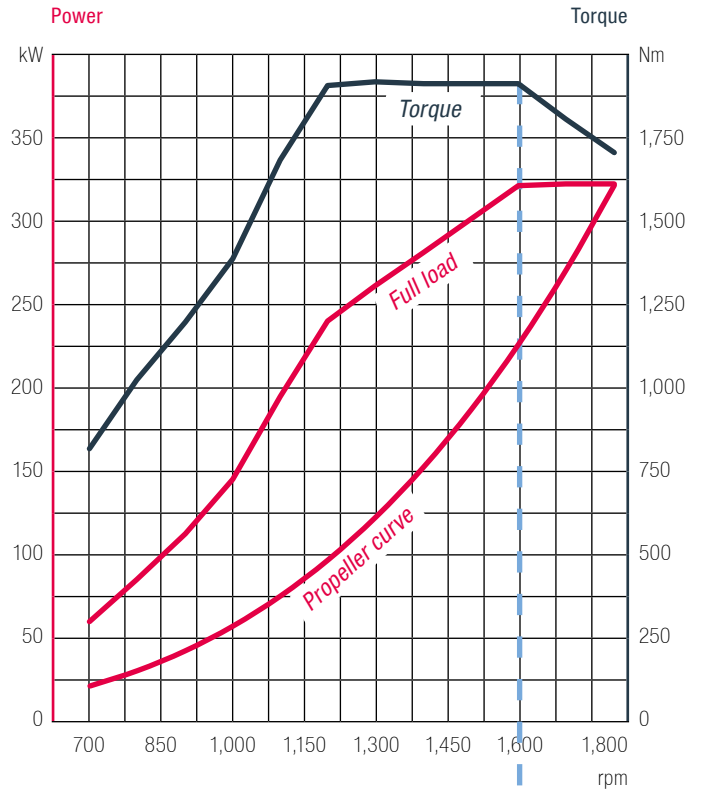

--- Maximum torque at most fuel efficient operating point



# D2676

## Power charts

D2676 LE 421

D2676 LE 424

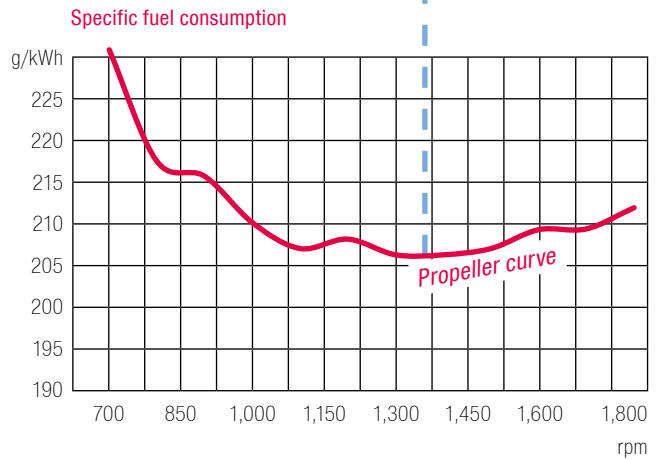
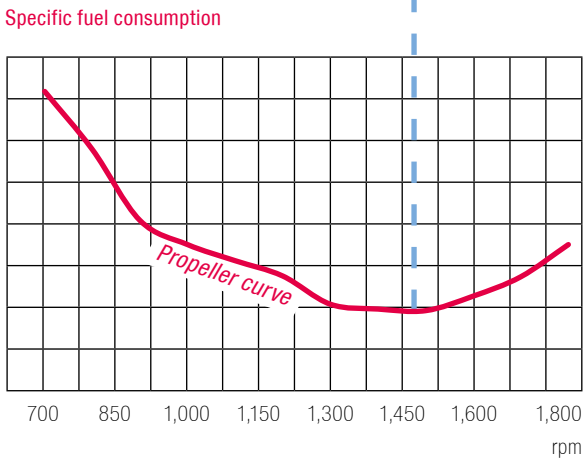
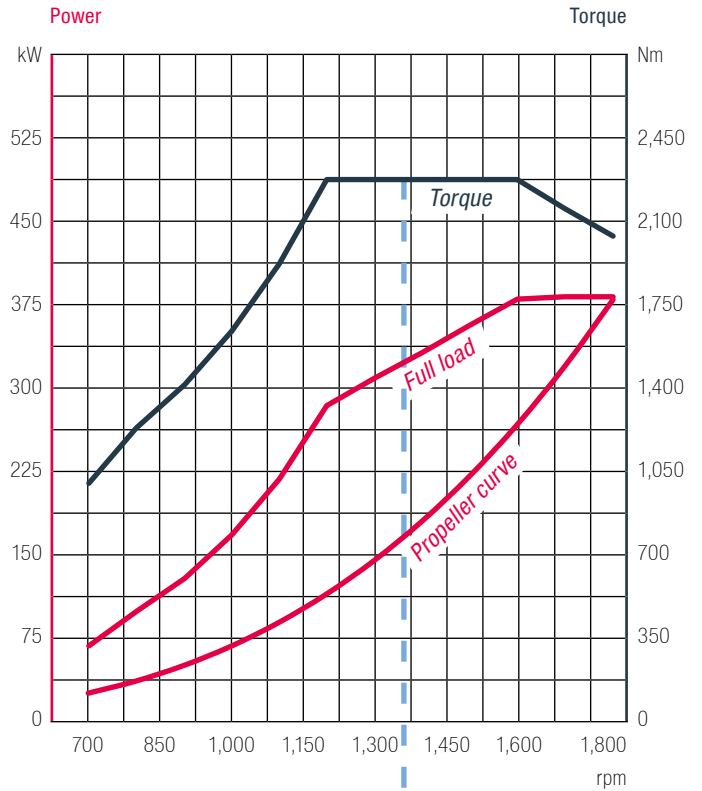
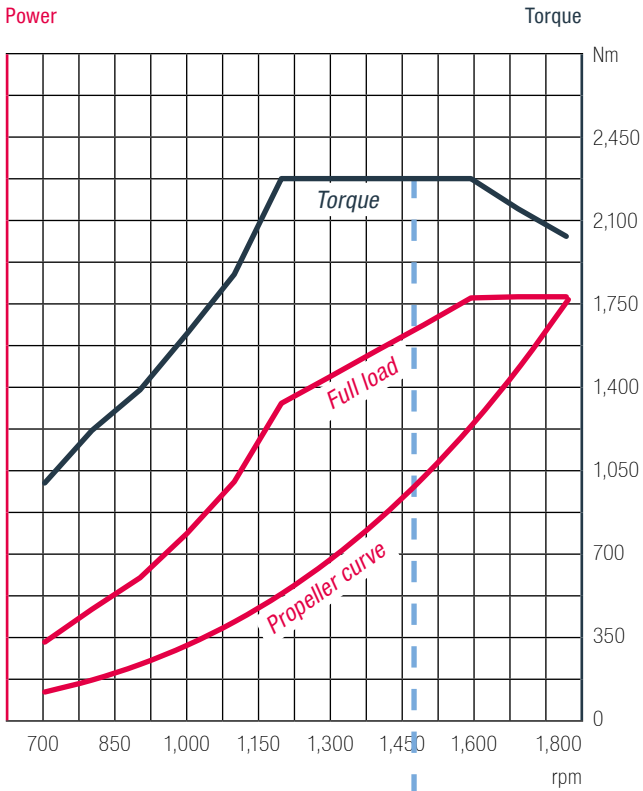

--- Maximum torque at most fuel efficient operating point

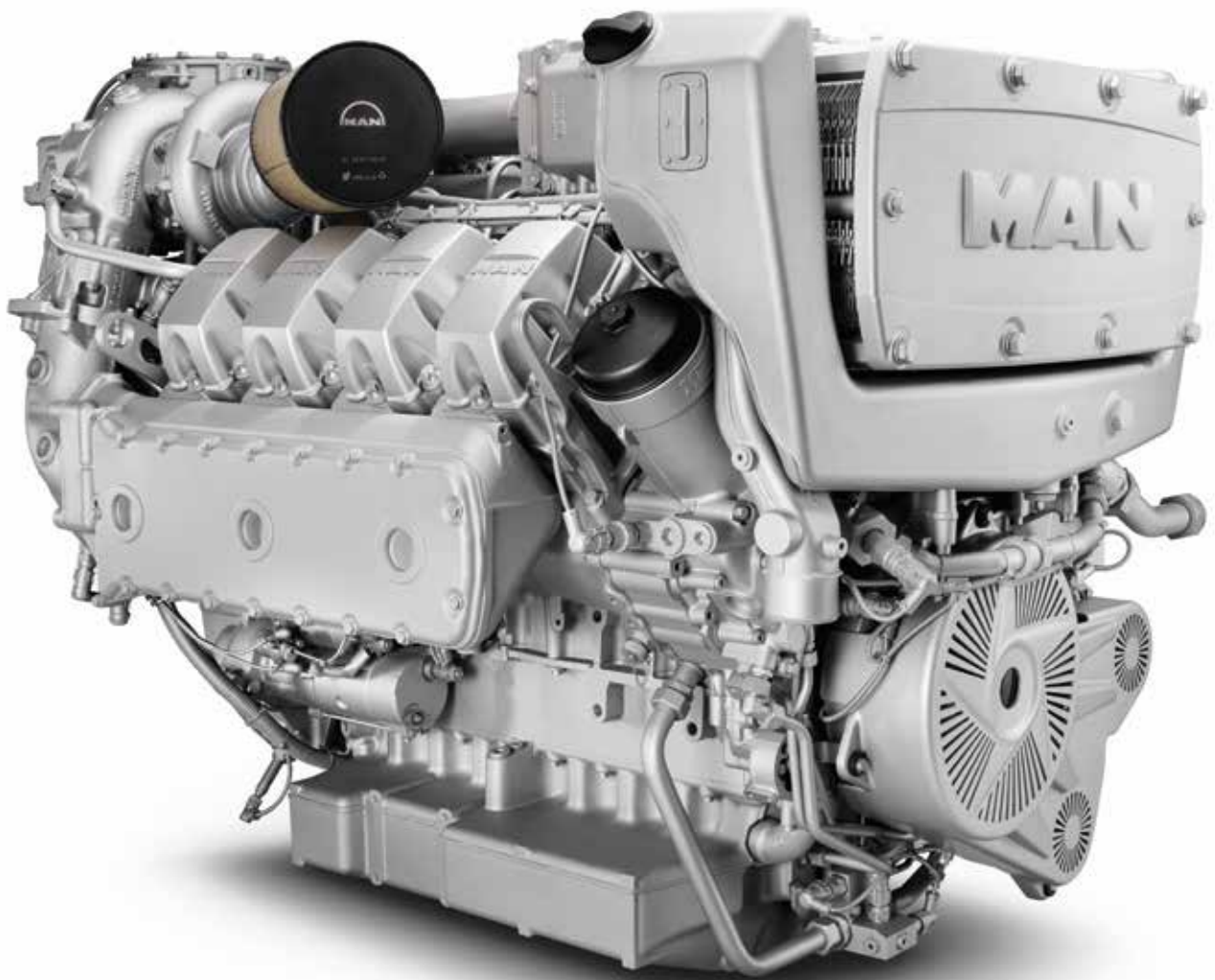

# D2868

## Engine description

### Characteristics

- Cylinders and arrangement: 8 cylinders in V arrangement
- Operation mode: 4-stroke diesel engine, watercooled
- Turbocharging: Turbocharger with charge air intercooler and waste gate
- Number of valves: 4 valves per cylinder
- Fuel system: Common Rail direct fuel injection
- Engine block: High-strength casting with integrated oil and water ducts and replaceable cylinder liners
- Engine Lubrication: Closed system with forced feeding, oil cooling and filtering
- Type of cooling: Plate heat exchanger, seawater cooled
- Engine control: Electronic injection control  
Electronic engine monitoring including diagnostic unit
- Fuel: DIN EN 590

# D2868

## Technical data

### Technical features D2868

Type designation		LE 421	LE 424	LE 431
Displacement	l	16.16	16.16	16.16
Nominal rating <sup>1)</sup>	kW (hp)	441 (600)	441 (600)	500 (680)
Rated speed	rpm	1,800	1,800	1,800
Torque at rated speed	Nm	2,340	2,340	2,653
Maximum torque	Nm	2,630	2,630	2,985
at speed	rpm	1,100–1,600	1,100–1,600	1,100–1,600
Lowest specific fuel consumption	g/kWh	197	206	199
Classifiable		✓	✓	✓
Exhaust gas status		IMO Tier II, RCD 94/25/EC, 97/68/EC	IMO Tier II, EPA Tier 3, RCD 2013/53/EC, RCD 94/25/EC, 97/68/EC	IMO Tier II, RCD 94/25/EC, 97/68/EC

1) The rating is according to DIN 3046/1

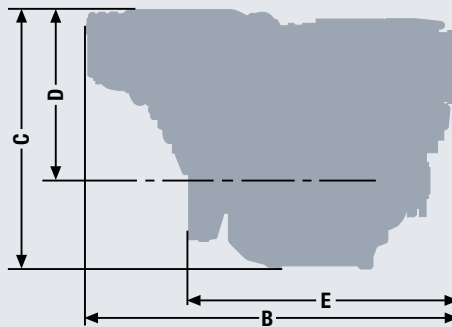
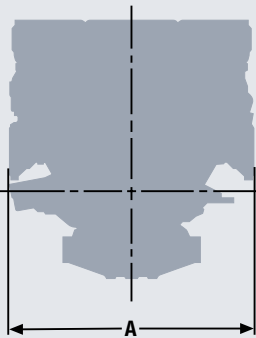

### Dimensions D2868

Type designation		LE 421/LE 424/LE 431
A-Overall width	mm	1,153
B-Overall length	mm	1,745
C-Overall height	mm	1,243
D-Top of engine to crankshaft centre	mm	765
E-Length of engine from front end to edge of flywheel housing	mm	1,243
Average weight of engine ready for installation (dry)	kg	1,780

For detailed examinations of installation dimensions, please order drawings from our factory.

# D2868

## Power charts

D2868 LE 421

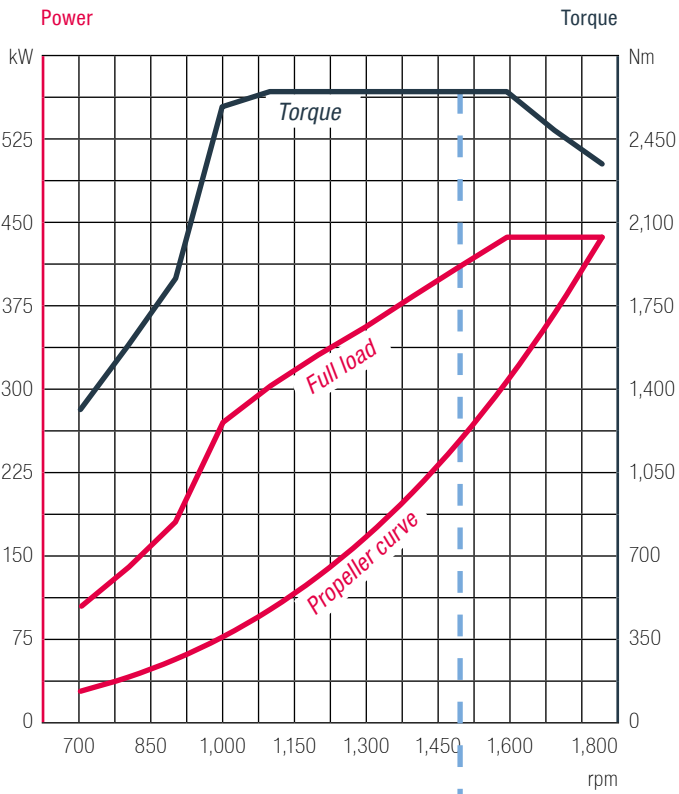

D2868 LE 424

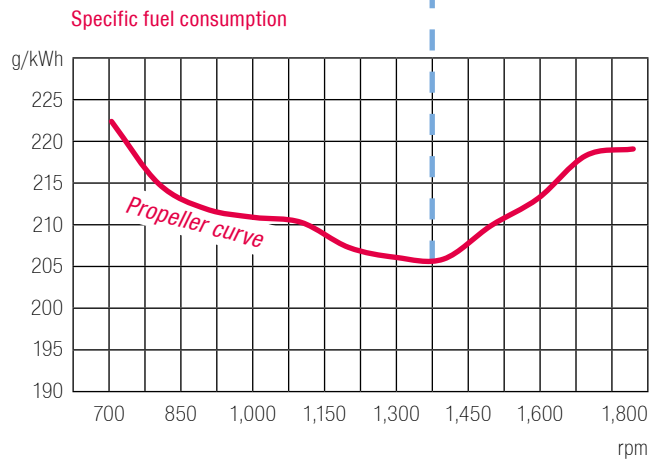
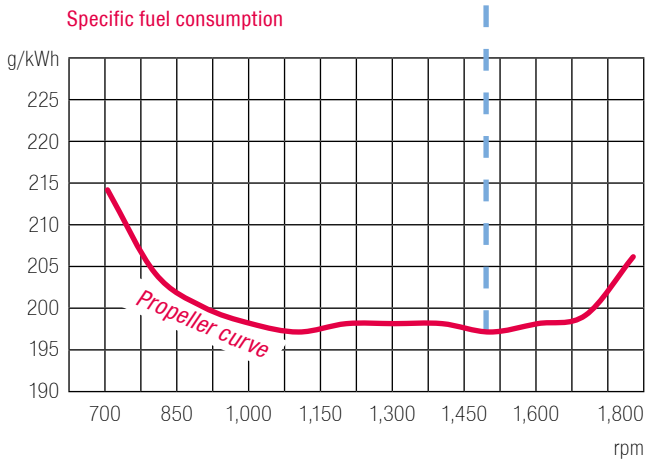
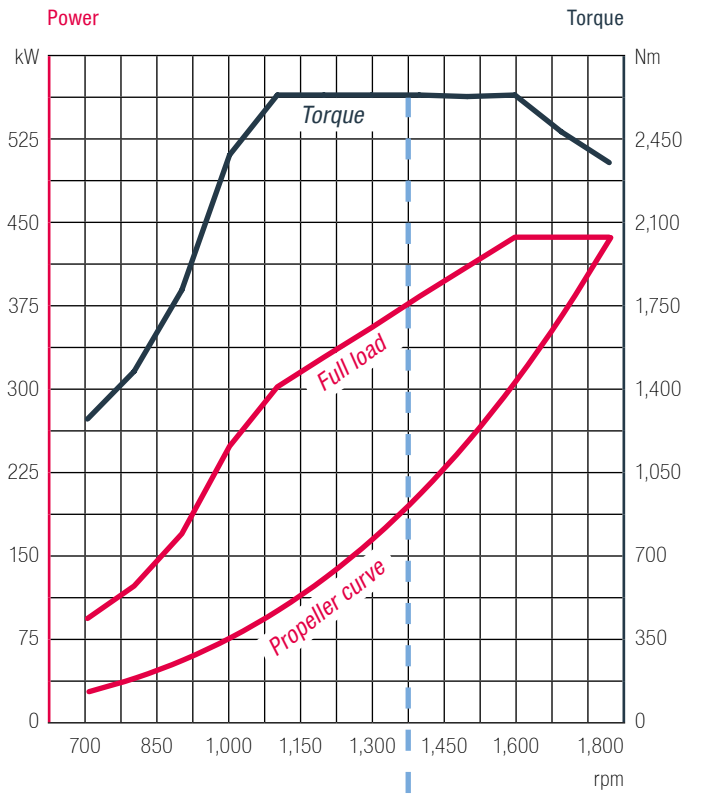

--- Maximum torque at most fuel efficient operating point

# D2868

## Power charts

### D2868 LE 431

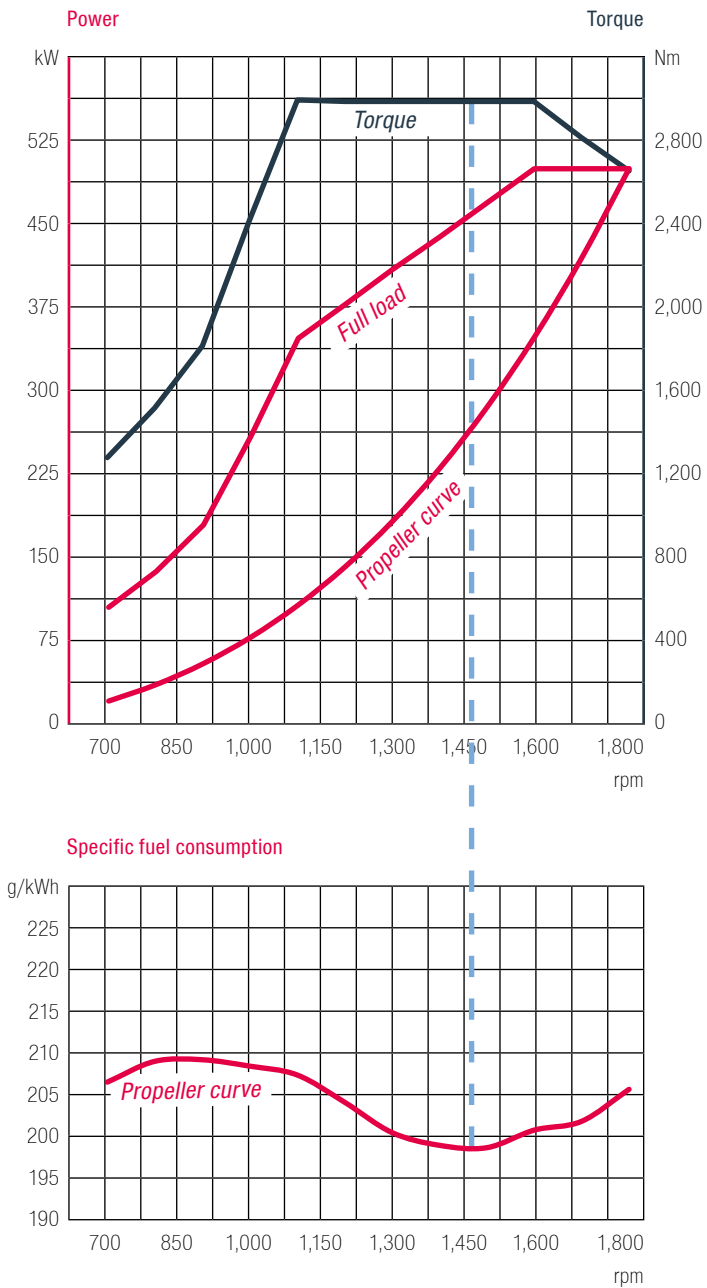

--- Maximum torque at most fuel efficient operating point



# D2862

## Engine description

### Characteristics

- Cylinders and arrangement: 12 cylinders in V arrangement
- Operation mode: 4-stroke diesel engine, watercooled
- Turbocharging: Turbocharger charge air intercooler and waste gate
- Number of valves: 4 valves per cylinder
- Fuel system: Common Rail direct fuel injection with electronic control
- Engine block: High-strength casting with integrated oil and water ducts and replaceable cylinder liners
- Engine lubrication: Closed system with forced feeding, oil cooling and filtering
- Type of cooling: Plate heat exchanger seawater cooled
- Engine control: Electronic injection control (EDC)  
Electronic engine monitoring including diagnostic unit
- Fuel: DIN EN 590

# D2862

## Technical data

### Technical features D2862

Type designation		LE 431	LE 434
Displacement	l	24.24	24.24
Nominal rating <sup>1)</sup>	kW (hp)	551 (749)	551 (749)
Rated speed	rpm	1,800	1,800
Torque at rated speed	Nm	2,923	2,923
Maximum torque	Nm	3,305	3,305
at speed	rpm	1,000–1,600	1,000–1,600
Lowest specific fuel consumption	g/kWh	198	202
Classifiable		✓	✓
Exhaust gas status		IMO Tier II, RCD 94/25/EC, 97/68/EC	IMO Tier II, EPA Tier 3, RCD 2013/53/EC, RCD 94/25/EC, 97/68/EC

1) The rating is according to DIN 3046/1

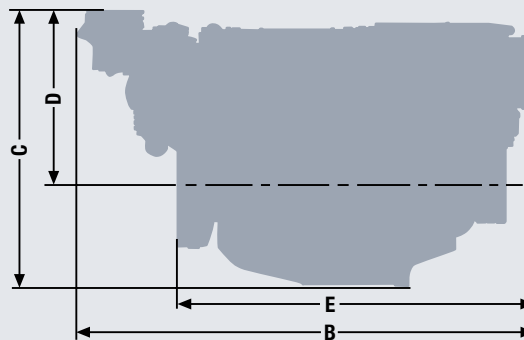
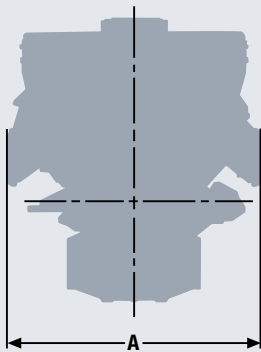

### Dimensions D2862

Type designation		LE 431/434
A-Overall width	mm	1,153
B-Overall length	mm	2,130
C-Overall height	mm	1,230
D-Top of engine to crankshaft centre	mm	765
E-Length of engine from front end to edge of flywheel housing	mm	1,630
Average weight of engine ready for installation (dry)	kg	2,270

For detailed examinations of installation dimensions, please order drawings from our factory.

# D2862

## Power charts

**D2862 LE 431**

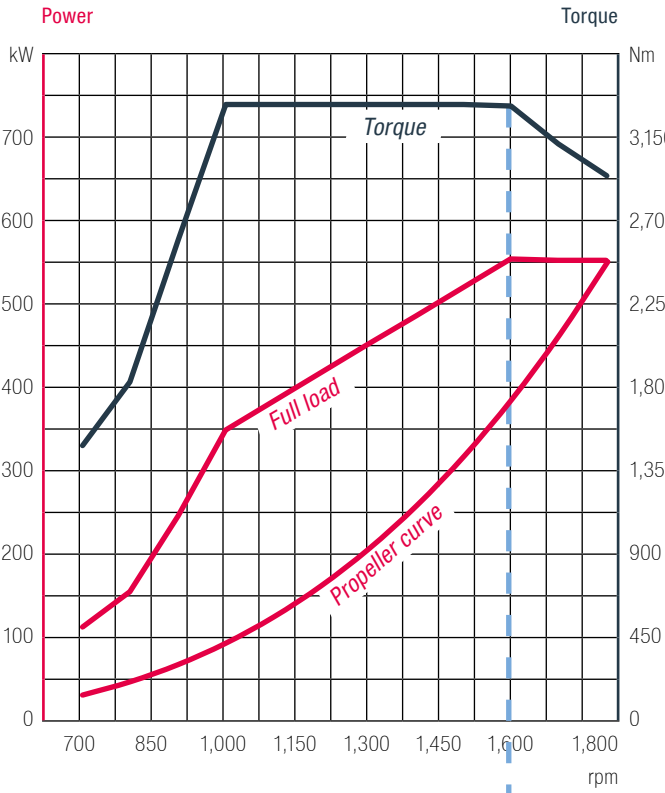

**D2862 LE 434**

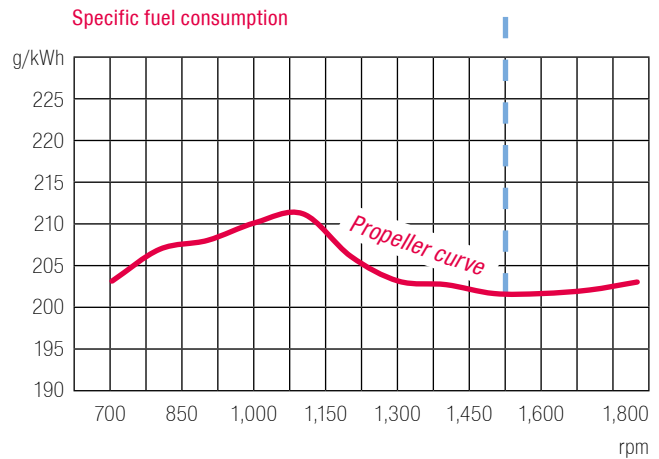
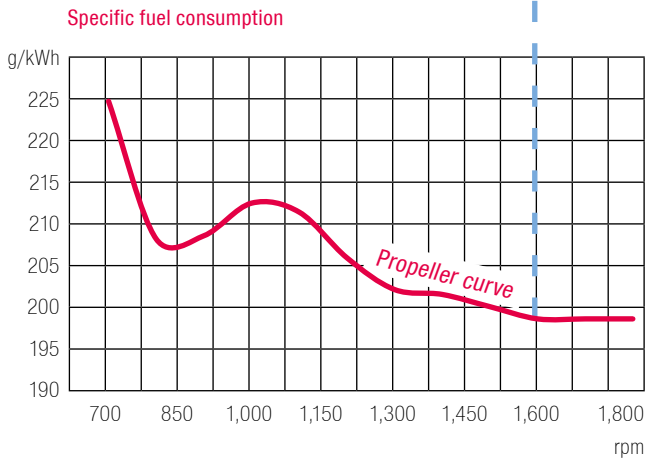
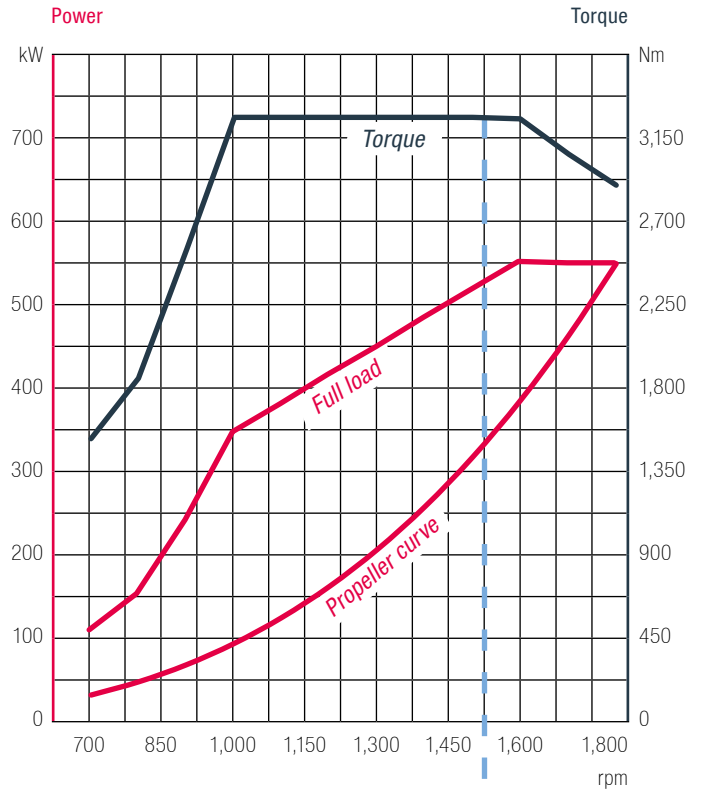

--- Maximum torque at most fuel efficient operating point



# D2862

## Technical data

### Technical features D2862

Type designation		LE 421	LE 441
Displacement	l	24.24	24.24
Nominal rating <sup>1)</sup>	kW (hp)	662 (900)	735 (1,000)
Rated speed	rpm	1,800	1,800
Torque at rated speed	Nm	3,512	3,900
Maximum torque	Nm	3,955	4,380
at speed	rpm	1,100–1,600	1,100–1,600
Lowest specific fuel consumption	g/kWh	195	193
Classifiable		✓	✓
Exhaust gas status		IMO Tier II, RCD 94/25/EC, 97/68/EC	IMO Tier II, RCD 94/25/EC

1) The rating is according to DIN 3046/1

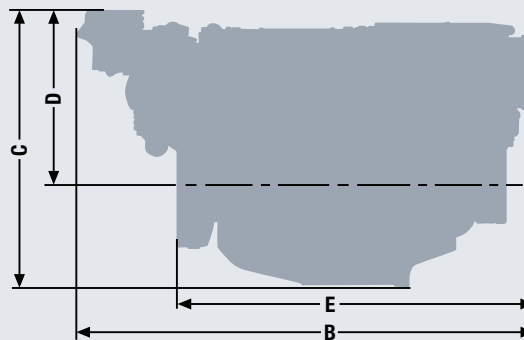
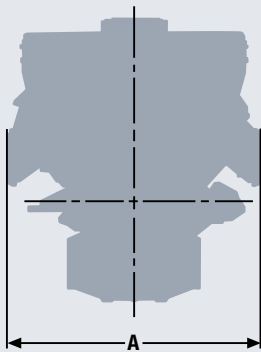

### Dimensions D2862

Type designation		LE 421/441
A-Overall width	mm	1,153
B-Overall length	mm	2,130
C-Overall height	mm	1,230
D-Top of engine to crankshaft centre	mm	765
E-Length of engine from front end to edge of flywheel housing	mm	1,630
Average weight of engine ready for installation (dry)	kg	2,270

For detailed examinations of installation dimensions, please order drawings from our factory.

# D2862

## Power charts

**D2862 LE 421**

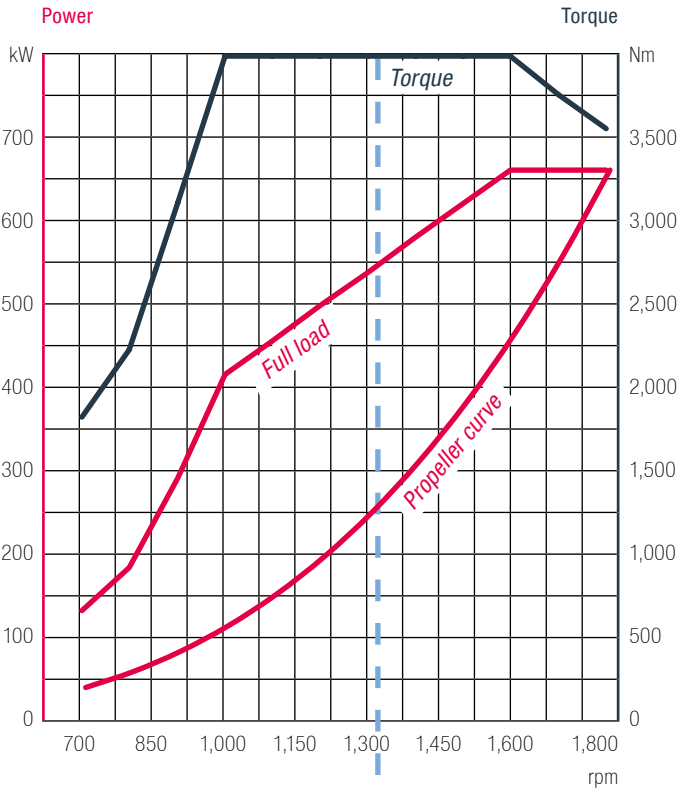

**D2862 LE 441**

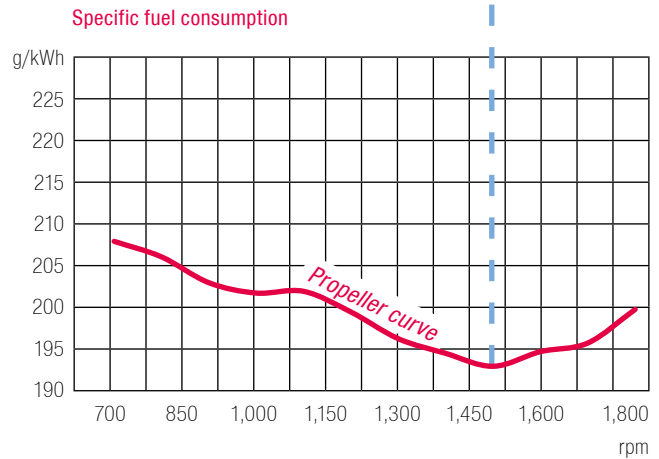
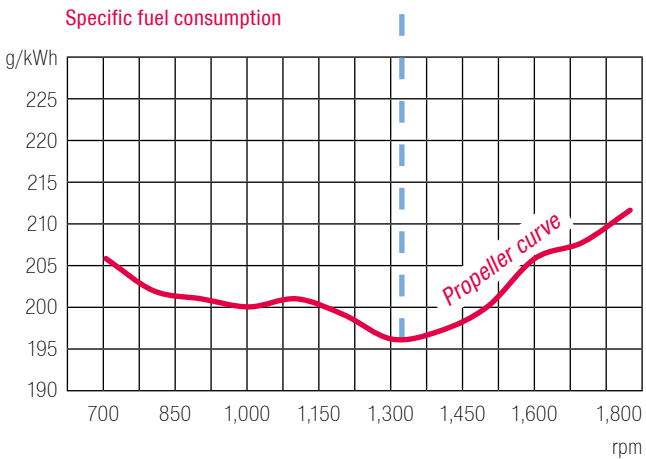
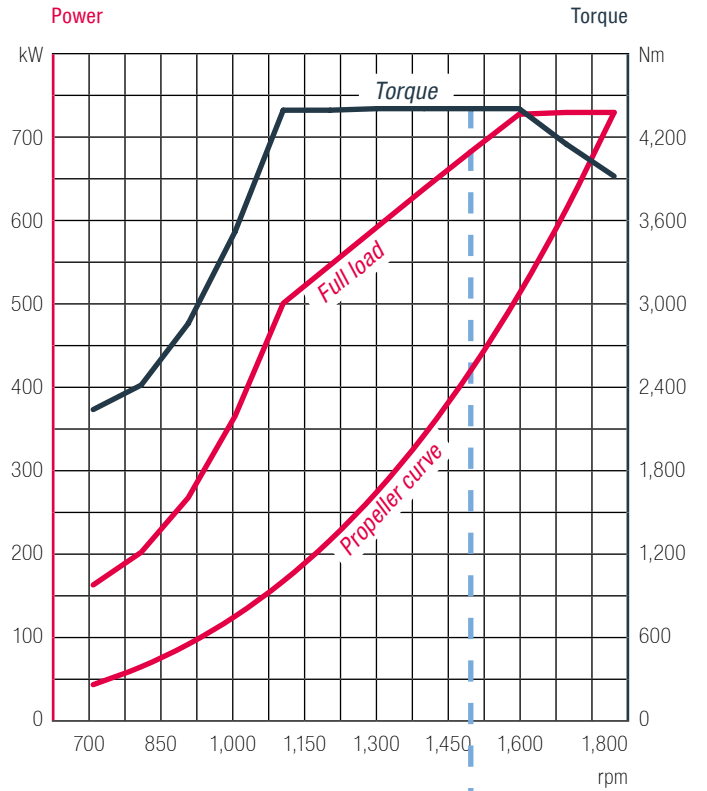

--- Maximum torque at most fuel efficient operating point

# Engine range

## Light duty

### 6 inline and V8 engines

Characteristics	Unit	D2676		D2868	
		LE 443	LE 423	LE 426	LE 436
Type designation		R6	R6	V8	V8
Arrangement and number of cylinders					
Nominal rating	hp	730	800	1,000	1,200
Maximum torque	Nm	2,450	2,674	3,340	4,010
Engine classifiable		✓	-	-	-
Rated speed	rpm	2,300	2,300	2,300	2,300
Lowest specific fuel consumption	g/kWh	199	213	209	205
Bore/Stroke	mm	126/166	126/166	128/157	128/157
Displacement	l	12.42	12.42	16.16	16.16
Length of engine from front end to edge of flywheel housing	mm	1,527	1,527	1,243	1,262
Width	mm	986	986	1,153	1,153
Height	mm	1,096	1,096	1,177	1,222
Dry weight	kg	1,215	1,215	1,780	1,880
Exhaust gas status		A	B	A	B

### V12 engines

Characteristics	Unit	D2862			
		LE 446	LE 426	LE 456	LE 436
Type designation		V12	V12	V12	V12
Arrangement and number of cylinders					
Nominal rating	hp	1,400	1,550	1,650	1,800
Maximum torque	Nm	4,680	5,180	5,510	6,010
Engine classifiable		✓	-	✓	-
Rated speed	rpm	2,300	2,300	2,300	2,300
Lowest specific fuel consumption	g/kWh	203	203	195	200
Bore/Stroke	mm	128/157	128/157	128/157	128/157
Displacement	l	24.24	24.24	24.24	24.24
Length of engine from front end to edge of flywheel housing	mm	1,630	1,630	1,667	1,667
Width	mm	1,153	1,153	1,150	1,150
Height	mm	1,230	1,230	1,350	1,350
Dry weight	kg	2,270	2,270	2,365	2,365
Exhaust gas status		B	B	B	B

A IMO Tier II, EPA Tier 3, RCD 2013/53/EC, RCD 94/25/EC, 97/68/EC

B IMO Tier II, EPA Tier 3 for private use only, RCD 2013/53/EC, RCD 94/25/EC, 97/68/EC

# Notes

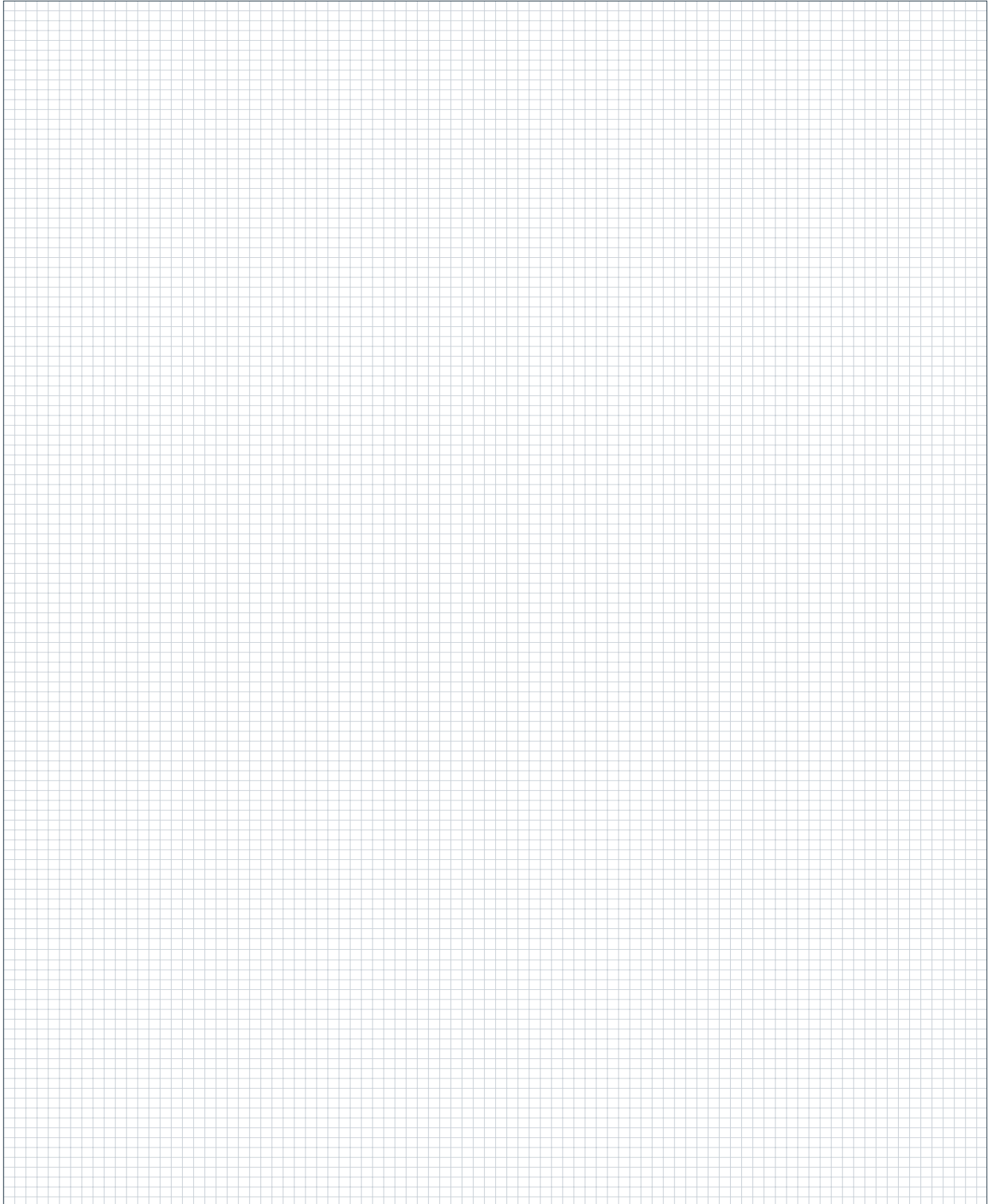

# Engine range

## Medium duty

### 6 inline and V8 engines

Characteristics	Unit	D2676				D2868		
		LE 432	LE 435	LE 422	LE 425	LE422	LE425	LE432
Type designation								
Arrangement and number of cylinders		R6	R6	R6	R6	V8	V8	V8
Nominal rating	hp	560	560	650	650	800	800	900
Maximum torque	Nm	2,065	2,065	2,402	2,402	2,950	2,980	3,327
Engine classifiable		✓	✓	✓	✓	✓	✓	-
Rated speed	rpm	2,100	2,100	2,100	2,100	2,100	2,100	2,100
Lowest specific fuel consumption	g/kWh	196	204	197	205	198	209	207
Bore/Stroke	mm	126/166	126/166	126/166	126/166	128/157	128/157	128/157
Displacement	l	12.42	12.42	12.42	12.42	16.16	16.16	16.16
Length of engine from front end to edge of flywheel housing	mm	1,527	1,527	1,527	1,527	1,177	1,177	1,177
Width	mm	986	986	986	986	1,153	1,153	1,153
Height	mm	1,096	1,096	1,096	1,096	1,243	1,243	1,243
Dry weight	kg	1,215	1,215	1,215	1,215	1,780	1,780	1,780
Exhaust gas status		C	B	C	B	C	B	A

### V12 engines

Characteristics	Unit	D2862				
		LE 425	LE 432	LE 435	LE 463	LE 466
Type designation						
Arrangement and number of cylinders		V12	V12	V12	V12	V12
Nominal rating	hp	1,019	1,200	1,200	1,400	1,400
Maximum torque	Nm	3,770	4,450	4,450	5,120	5,180
Engine classifiable		✓	✓	✓	✓	✓
Rated speed	rpm	2,100	2,100	2,100	2,100	2,100
Lowest specific fuel consumption	g/kWh	200	198	203	200	203
Bore/Stroke	mm	128/157	128/157	128/157	128/157	128/157
Displacement	l	24.24	24.24	24.24	24.24	24.24
Length of engine from front end to edge of flywheel housing	mm	1,630	1,630	1,630	1,630	1,630
Width	mm	1,153	1,153	1,153	1,153	1,153
Height	mm	1,230	1,230	1,230	1,230	1,230
Dry weight	kg	2,270	2,270	2,270	2,270	2,270
Exhaust gas status		B	C	B	C	B

- A IMO Tier II
- B IMO Tier II, EPA Tier 3, RCD 2013/53/EC, RCD 94/25/EC, 97/68/EC
- C IMO Tier II, RCD 94/25/EC, 97/68/EC

# Notes

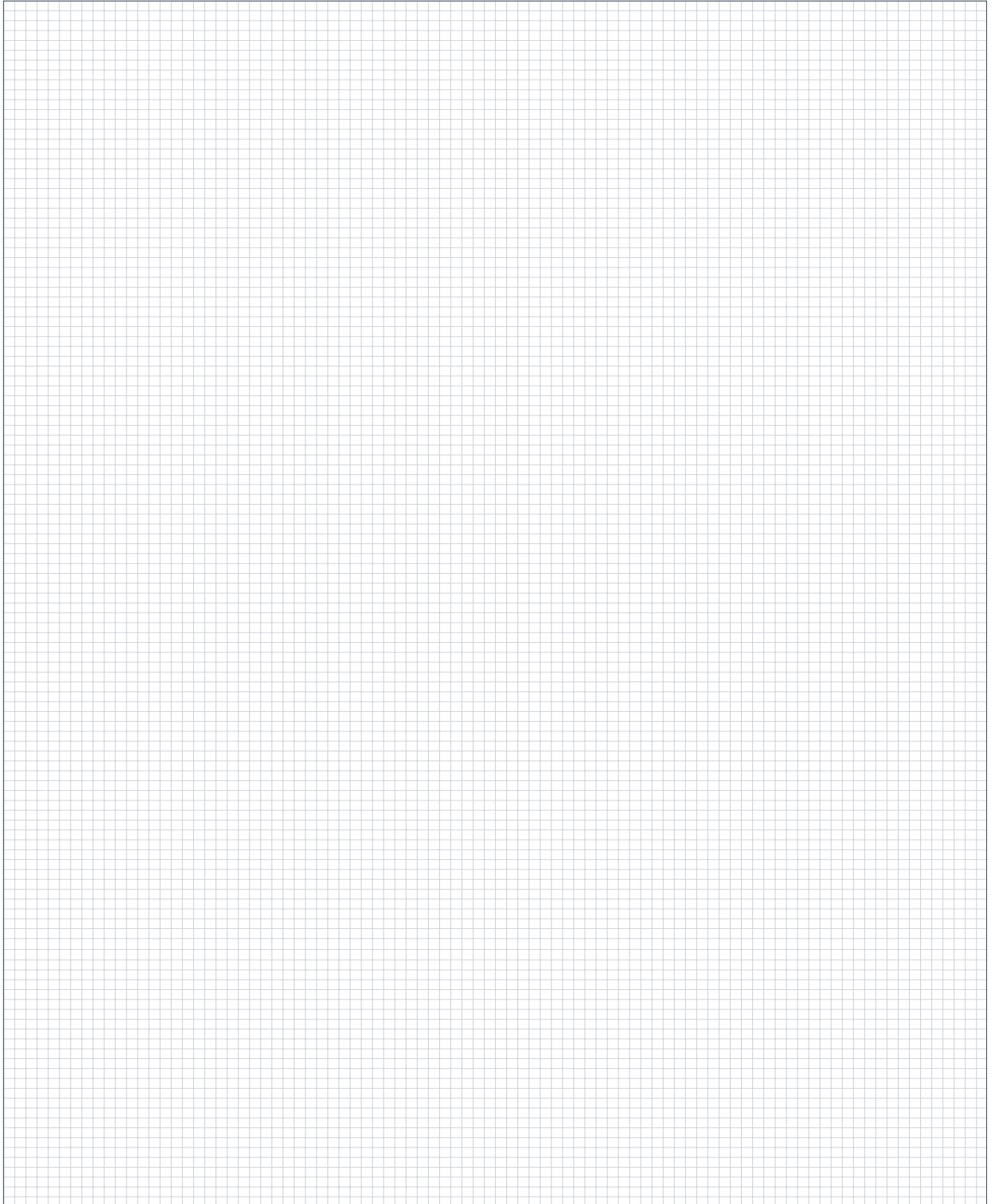

# Engine range

## Heavy duty

### 6 inline engines

Characteristics	Unit	D2676						
		LE 461	LE 452	LE 441	LE 431	LE 434	LE 421	LE 424
Type designation								
Arrangement and number of cylinders		R6	R6	R6	R6	R6	R6	R6
Nominal rating	hp	200	286	367	440	440	520	520
Maximum torque	Nm	880	1,250	1,616	1,925	1,925	2,275	2,270
Engine classifiable		✓	✓	✓	✓	✓	✓	✓
Rated speed	rpm	1,800	1,800	1,800	1,800	1,800	1,800	1,800
Lowest specific fuel consumption	g/kWh	221	214	212	198	204	197	204
Bore/Stroke	mm	126/166	126/166	126/166	126/166	126/166	126/166	126/166
Displacement	l	12.42	12.42	12.42	12.42	12.42	12.42	12.42
Length of engine from front end to edge of flywheel housing	mm	1,527	1,527	1,527	1,527	1,527	1,527	1,527
Width	mm	986	986	986	986	986	986	986
Height	mm	1,096	1,096	1,096	1,096	1,096	1,096	1,096
Dry weight	kg	1,215	1,215	1,215	1,215	1,215	1,215	1,215
Exhaust gas status		A	A	A	C	B	C	B

### V8 and V12 engines

Characteristics	Unit	D2868			D2862			
		LE 421	LE 424	LE 431	LE 431	LE 434	LE 421	LE 441
Type designation								
Arrangement and number of cylinders		V8	V8	V8	V12	V12	V12	V12
Nominal rating	hp	600	600	680	749	749	900	1,000
Maximum torque	Nm	2,630	2,630	2,985	3,305	3,305	3,955	4,380
Engine classifiable		✓	✓	✓	✓	✓	✓	✓
Rated speed	rpm	1,800	1,800	1,800	1,800	1,800	1,800	1,800
Lowest specific fuel consumption	g/kWh	197	206	199	198	202	195	193
Bore/Stroke	mm	128/157	128/157	128/157	128/157	128/157	128/157	128/157
Displacement	l	16.16	16.16	16.16	24.24	24.24	24.24	24.24
Length of engine from front end to edge of flywheel housing	mm	1,243	1,243	1,243	1,630	1,630	1,630	1,630
Width	mm	1,153	1,153	1,153	1,153	1,153	1,153	1,153
Height	mm	1,243	1,243	1,243	1,230	1,230	1,230	1,230
Dry weight	kg	1,780	1,780	1,780	2,270	2,270	2,270	2,270
Exhaust gas status		C	B	C	C	B	C	D

A IMO Tier II, 97/68/EC

B IMO Tier II, EPA Tier 3, RCD 2013/53/EC, RCD 94/25/EC, 97/68/EC

C IMO Tier II, RCD 94/25/EC, 97/68/EC

D IMO Tier II, RCD 94/25/EC







**MAN Truck & Bus AG**

Vogelweiherstr. 33  
90441 Nuremberg, Germany  
man-engines@man.eu  
www.man-engines.com

---

D 114.602 · mu 09164 · Printed in Germany

All data provided in this document is non-binding. This data serves informational purposes only and is especially not guaranteed in any way. Depending upon the subsequent specific individual projects, the relevant data may be subject to changes and will be assessed and determined individually for each project. This will depend on the particular characteristics of each individual project, especially specific site and operational conditions.

MAN Truck & Bus – a member of the MAN Group