











3055 AIRCONDITIONING

STANDARD BARRIER HOSE
NYLON BRAIDED REINFORCEMENT
TYPE C CLASS 1













Burgaflex

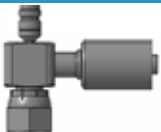

SCHLAUCH HOSE TUYAUX	Umschreibung description description	Seite page page
	3055 Airconditioning hose Type C Class II/SAE J2064	4

VERPRESSUNG CRIMP SERTI	Teilnummer part no. référence	Umschreibung description description	Seite page page
	52701	SAE 45° flare swivel	6
	52702	45° elbow	6
	52703	90° elbow	6
	52704	O-ring female swivel	7
	52705	45° elbow	8
	52706	90° elbow	9
	52717	O-ring female swivel - R134a valve	7
	52718	45° elbow	8
	52719	90° elbow	9
	52724	O-ring without nut	7
	52725	45° elbow	8
	52726	90° elbow	9
	52710	O-ring female swivel - pressure sensor 7/16-20	10
	52711	45° elbow	10
	52712	90° elbow	10
	52751	O-ring TXV connection	11
	52752	45° elbow	11
	52753	90° elbow	11
	52729	O-ring female swivel - without nut - with R134a valve, 90° elbow	12
	52747	Quick disconnect connection	12
	52304	O-ring TXV connection incl. TXV plate	13
	52305	45° elbow	13
	52306	90° elbow	13

INHALTSVERZEICHNIS
TABLE OF CONTENTS
INDEX

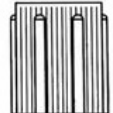

Teilnummer part no. référance	Beschreibung description déscription	Seite page page	VERPRESSUG CRIMP SERTI
52707 52708 52709	Tube-O compressor fitting 45° elbow 90° elbow block type	14 14 14	
52733 52734 52735	Tube-O compressor fitting / R134a valve 45° elbow 90° elbow	15 15 15	
52450 52451 52453	Tube-O HEX block 90° Tube-O HEX block 90° - R134a valve - top Tube-O HEXblock 90° - R134a valve - 120°	16 16 16	
52454 52455 52740	Tube-O HEX block 90° - R134a valve - forward Tube-O HEX block 90° - R134a valve - 240° O-ring swivel block type - 90°	17 17 17	
52741 52742 52412	O-ring swivel block type - pressure sensor 7/16-20 O-ring swivel block type - R134a valve - top O-ring swivel block type - R134a valve - forward	18 18 18	
52425 52426 52427	O-ring HEX block 90° O-ring HEX block 90° - R134a valve - top O-ring HEX block 90° - R134a valve - forward	19 19 19	
52420 52421 52422	O-ring swivel 90° block - R134a valve top, short drop O-ring swivel 90° block type, short drop O-ring swivel 90° block - R134a valve forward, short drop	20 20 20	
52428 52771 52217	O-ring HEX block 90° - pressure sensor 7/16-20 - top O-ring swivel 180° O-ring male swivel 90° - R134a valve	21 21 21	
52213 52214 52215	O-ring male swivel, short pilot 45° elbow 90° elbow	22 22 22	
52206 52207 52208	O-ring male insert straight 45° elbow 90° elbow	23 23 23	
52617 52618 52619	O-ring female swivel - switch adaptor M10x1.25 45° elbow 90° elbow	24 24 24	
52758 52759 52760	Bulkhead male insert O-ring 90° elbow 45° elbow	25 25 25	

VERPRESSUNG CRIMP SERTI	Teilnummer part no. référance	Umschreibung description description	Seite page page
	(52)8007	Inline splicer	26
	(52)8097	Inline T-splicer	26
	(52)8008	Inline splicer - R134a valve	26
	(52)7020	Inline splicer - pressure sensor 7/16-2	27
	7042	Protection cap 7/16-20 presure sensor connection	28
	7037	Protection cap 7034/7036	28
	7038	Protection cap 7035	28
	7039	Valve core 7035	28
	7028	O-ring	28

DEFINITION RUN AND DROP

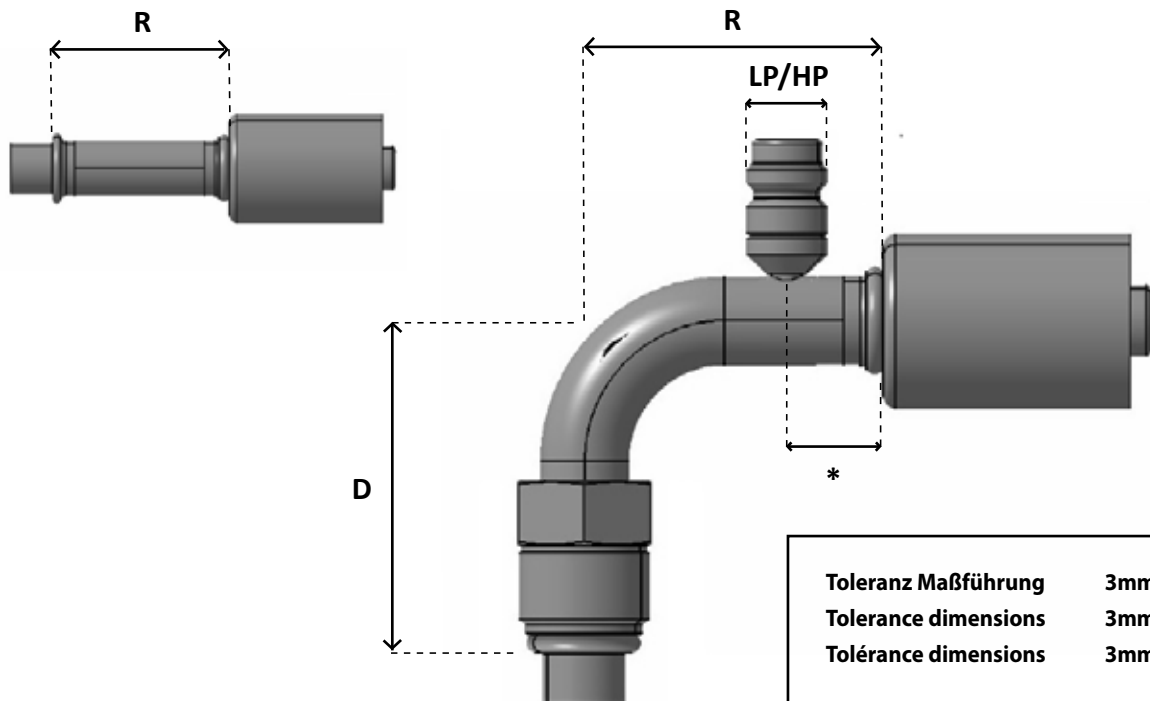

* Dimension related to partnumber between 20-25 mm.

**KLIMASCHLAUCH
AIRCONDITIONING HOSE
TUYAUX AIRCONDITIONNE**



Teilnr. part no. référence	Slauch- durchmesser hose size module	Inner- durchmesser hose I.D. diamètre intérieur	Ausen- durchmesser hose O.D. diamètre extérieur	min. Berst- druck min. burst press pres. minimum d'éclatement	Arbeits- druck work press pres. d'uti- lisation	min. Biegen Radius min. bend radius rayon mini de courbure	SCHLAUCH HOSE TUYAU
----------------------------------	---	---	---	--	--	---	------------------------------------

		mm	mm	bar	bar	mm
3055-06	-6 5/16"	7.90	18.30	121	24	102
3055-08	-8 13/32"	10.30	22.40	121	24	114
3055-10	-10 1/2"	12.70	24.60	121	24	127
3055-12	-12 5/8"	15.90	27.70	86	17	165



Hose construction: Seamless synthetic rubber (CR) innertube, covered with a nylon layer and reinforced with one braid. Hose has a weather, oil and abrasion resistant rubber cover (Butyl), which is perforated.

Identification: Hose is identified by partnumber and size.

Uses: Designed specifically for automotive and off highway applications for refrigerants R134a and for many others. Please contact the Burgaflex team for advise and test data.

Temperatures: -35 °C thru +125 °C

ARMATUR FÜR KLIMASCHLAUCH
HOSE FITTINGS
RACCORDS POUR TUYAUX AIRCONDITIONNE

ARMATUREN FITTINGS RACCORDS	Teilnummer part no. référence	Anschluß fitt.conn. size module du filetage	Schlauch- durchmesser hose size module du tuyau	Gewinde thread filetage	Ventil valve valve	D	R
	52701-04-06S	-4	-6	9/16-20			30
	52701-06-06S	-6	-6	5/8-18			45
	52701-06-08S	-6	-8	5/8-18			45
	52701-08-06S	-8	-6	3/4-16			50
	52701-08-08S	-8	-8	3/4-16			50
	52701-08-10S	-8	-10	1 1/16-14			50
	52701-10-08S	-10	-8	7/8-14			58
	52701-10-10S	-10	-10	7/8-14			58
	52701-10-12S	-10	-12	7/8-14			58
	52701-12-12S	-12	-12	1 1/16-14			65

SAE 45° swivel

	52702-04-06S	-4	-6	9/16-20		10	30
	52702-06-06S	-6	-6	5/8-18		15	35
	52702-06-08S	-6	-8	5/8-18		15	35
	52702-08-06S	-8	-6	3/4-16		15	40
	52702-08-10S	-8	-10	1 1/16-14		15	47
	52702-08-08S	-8	-8	3/4-16		15	40
	52702-10-08S	-10	-8	7/8-14		32	64
	52702-10-10S	-10	-10	7/8-14		32	64
	52702-10-12S	-10	-12	7/8-14		32	70
	52702-12-12S	-12	-12	1 1/16-14		38	83

SAE 45° swivel - 45° ellbow

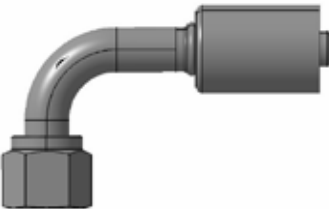
	52703-04-06S	-4	-6	9/16-20		19	26
	52703-06-06S	-6	-6	5/8-18		30	30
	52703-06-08S	-6	-8	5/8-18		30	30
	52703-08-06S	-8	-6	3/4-16		30	42
	52703-08-08S	-8	-8	3/4-16		30	42
	52703-08-10S	-8	-10	1 1/16-14		30	42
	52703-10-08S	-10	-8	7/8-14		45	42
	52703-10-10S	-10	-10	7/8-14		45	42
	52703-10-12S	-10	-12	7/8-14		45	50
	52703-12-12S	-12	-12	1 1/16-14		55	60

SAE 45° swivel - 90° ellbow

Sonder Armaturen auf Anfrage
Special fittings on request
Raccords spécifiques sur demande

ARMATUR FÜR KLIMASCHLAUCH
HOSE FITTINGS
RACCORDS POUR TUYAUX AIRCONDITIONNE



Teilnummer part no. référence	Anschluß fitt.conn. size module du filetage	Schlauch- durchmesser hose size module du tuyau	Gewinde thread filetage	Ventil valve valve	D	R	ARMATUREN FITTINGS RACCORDS
52704-06-06S	-6	-6	5/8-18			38	
52704-06-08S	-6	-8	5/4-16			40	
52704-08-06S	-8	-6	3/4-16			40	
52704-08-08S	-8	-8	3/4-16			40	
52704-08-10S	-8	-10	3/4-16			45	
52704-10-08S	-10	-8	7/8-14			45	
52704-10-10S	-10	-10	7/8-14			45	
52704-10-12S	-10	-12	7/8-14			48	
52704-12-12S	-12	-12	1 1/16-14			55	

Long pilot
O-ring female swivel

52717-06-06S	-6	-6	5/8-18	16 (HP)		50
52717-08-08S	-8	-8	3/4-16	16 (HP)		50
52717-08-10S	-8	-10	3/4-16	13 (LP)		45
52717-10-10S	-10	-10	7/8-14	13 (LP)		55
52717-10-12S	-10	-12	7/8-14	13 (LP)		58
52717-12-12S	-12	-12	1 1/16-14	13 (LP)		58



O-ring female swivel - R134a valve

52724-06-06S	-6	-6				38
52724-06-08S	-6	-8				42
52724-08-06S	-8	-6				40
52724-08-08S	-8	-8				40
52724-10-10S	-10	-10				45
52724-10-12S	-10	-12				48
52724-12-10S	-12	-10				48
52724-12-12S	-12	-12				48



O-ring - tube connection

Sonder Armaturen auf Anfrage
Special fittings on request
Raccords spécifiques sur demande

ARMATUR FÜR KLIMASCHLAUCH
HOSE FITTINGS
RACCORDS POUR TUYAUX AIRCONDITIONNE

ARMATUREN FITTINGS RACCORDS	Teilnummer part no. référence	Anschluß fitt.conn. size module du filetage	Schlauch- durchmesser hose size module du tuyau	Gewinde thread filetage	Ventil valve valve	D	R
	52705-06-06S	-6	-6	5/8-18		15	35
	52705-06-08S	-6	-8	5/8-14		15	42
	52705-08-08S	-8	-8	3/4-16		16	42
	52705-08-10S	-8	-10	3/4-16		20	48
	52705-10-10S	-10	-10	7/8-14		22	54
	52705-10-12S	-10	-12	7/8-14		24	62
	52705-12-12S	-12	-12	1 1/16-14		27	69

Long pilot
O-ring female swivel - tube connection - 45° elbow

	52718-06-06S	-6	-6	5/8-18	16 (HP)	15	55
	52718-08-08S	-8	-8	3/4-16	16 (HP)	15	55
	52718-10-10S	-10	-10	7/8-14	13 (LP)	22	67
	52718-10-12S	-10	-12	7/8-14	13 (LP)	22	70
	52718-12-12S	-12	-12	1 1/16-14	13 (LP)	25	73

O-ring female swivel - R134a valve - 45° elbow

	52725-06-06S	-6	-6			15	35
	52725-08-08S	-8	-8			15	41
	52725-10-12S	-10	-12			24	62
	52725-12-10S	-12	-10			24	62
	52725-12-12S	-12	-12			24	62

O-ring - tube connection, without nut - 45° elbow

Sonder Armaturen auf Anfrage
Special fittings on request
Raccords spécifiques sur demande

ARMATUR FÜR KLIMASCHLAUCH
HOSE FITTINGS
RACCORDS POUR TUYAUX AIRCONDITIONNE

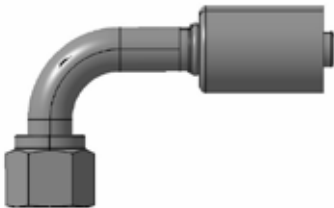

Teilnummer part no. référence	Anschluß fitt.conn. size module du filetage	Schlauch- durchmesser hose size module du tuyau	Gewinde thread filetage	Ventil valve valve	D	R	ARMATUREN FITTINGS RACCORDS	
52706-06-06S	-6	-6	5/8-18		30	30		
52706-06-08S	-6	-8	6/8-18		36	50		
52706-08-08S	-8	-8	3/4-16		35	35		
52706-08-10S	-8	-10	3/4-16		35	40		
52706-10-08S	-10	-8	7/8-14		35	35		
52706-10-10S	-10	-10	7/8-14		40	40		
52706-10-12S	-10	-12	7/8-14		43	43		
52706-10-14S	-10	-14	7/8-14		48	48		
52706-12-10S	-12	-10	1 1/16-14		48	46		
52706-12-12S	-12	-12	1 1/16-14		48	48		

O-ring female swivel - tube connection - 90° elbow

52719-06-06S	-6	-6	5/8-18	16 (HP)	30	50	
52719-08-08S	-8	-8	3/4-16	16 (HP)	35	55	
52719-10-10S	-10	-10	7/8-14	13 (LP)	40	60	
52719-10-12S	-10	-12	7/8-14	13 (LP)	45	65	
52719-12-12S	-12	-12	1 1/16-14	13 (LP)	48	70	

O-ring female swivel - R134a valve - 90° elbow

52726-06-06S	-6	-6			33	33	
52726-08-08S	-8	-8			35	35	
52726-10-10S	-10	-10			40	47	
52726-10-12S	-10	-12			50	47	
52726-12-10S	-12	-10			50	47	
52726-12-12S	-12	-12			50	47	

O-ring - tube connection, without nut, 90° elbow

Sonder Armaturen auf Anfrage
Special fittings on request
Raccords spécifiques sur demande

ARMATUR FÜR KLIMASCHLAUCH
HOSE FITTINGS
RACCORDS POUR TUYAUX AIRCONDITIONNE



Teilnummer part no. référence	Anschluß fitt.conn. size module du filetage	Schlauch- durchmesser hose size module du tuyau	Gewinde thread filetage	Ventil valve valve	D	R	ARMATUREN FITTINGS RACCORDS
-------------------------------------	---	---	-------------------------------	--------------------------	---	---	-----------------------------------

52710-06-06S	-6	-6	5/8-18	7/16-20		50	
52710-08-08S	-8	-8	3/4-16	7/16-20		50	
52710-10-10S	-10	-10	7/8-14	7/16-20		55	
52710-12-12S	-12	-12	1 1/16-14	7/16-20		58	

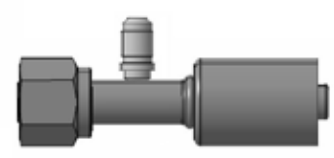

O-ring female swivel - pressure sensor 7/16-20

52711-06-06S	-6	-6	5/8-18	7/16-20	15	55	
52711-08-08S	-8	-8	3/4-16	7/16-20	15	55	
52711-10-10S	-10	-10	7/8-14	7/16-20	22	67	
52711-12-12S	-12	-12	1 1/16-14	7/16-20	25	73	

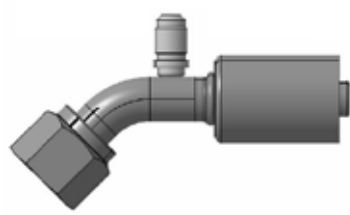

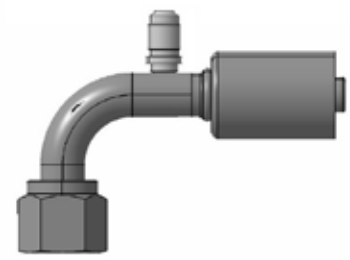

O-ring female swivel - pressure sensor 7/16-20 - 45° elbow

52712-06-06S	-6	-6	5/8-18	7/16-20	30	50	
52712-08-08S	-8	-8	3/4-16	7/16-20	35	55	
52712-10-10S	-10	-10	7/8-14	7/16-20	45	60	
52712-12-12S	-12	-12	1 1/16-14	7/16-20	48	70	



O-ring female swivel - pressure sensor 7/16-20 - 90° elbow

Sonder Armaturen auf Anfrage
Special fittings on request
Raccords spécifiques sur demande

ARMATUREN FITTINGS RACCORDS	Teilnummer part no. référence	Anschluß fitt.conn. size module du filetage	Schlauch- durchmesser hose size module du tuyau	Gewinde thread filetage	Ventil valve valve	D	R
 Long pilot O-ring TXV connection	52751-12-10S	-12	-10				51
 Long pilot O-ring, TXV connection - 45° elbow	52752-12-10S	-12	-10			22	59
 Long pilot O-ring, TXV connection - 90° elbow	52753-12-10S	-12	-10			47	52

Sonder Armaturen auf Anfrage
Special fittings on request
Raccords spécifiques sur demande

**ARMATUR FÜR KLIMASCHLAUCH
HOSE FITTINGS
RACCORDS POUR TUYAUX AIRCONDITIONNE**



Teilnummer part no. référence	Anschluß fitt.conn. size module du filetage	Schlauch- durchmesser hose size module du tuyau	Gewinde thread filetage	Ventil valve valve	D	R	ARMATUREN FITTINGS RACCORDS
52729-06-06S	-6	-6		16 (HP)	30	50	 <p>Long pilot O-ring - without nut - with R134a valve 90° elbow</p>
52729-08-08S	-8	-8		16 (HP)	35	55	
52729-10-10S	-10	-10		13 (LP)	40	60	
52729-10-12S	-10	-10		13 (LP)	45	65	
52729-12-12S	-12	-12		13 (LP)	48	17	



52747-08-06S	-8	-6	7/8-20			25
52747-08-08S	-10	-8	7/8-20			25
52747-12-10S	-12	-10	1 1/4-18			25



Quick disconnect connect

**Sonder Armaturen auf Anfrage
Special fittings on request
Raccords spécifiques sur demande**

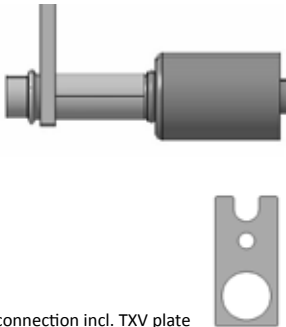
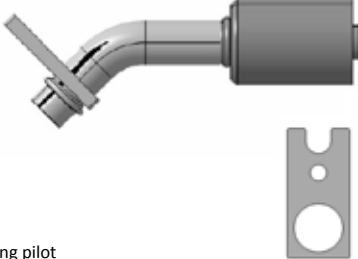
ARMATUR FÜR KLIMASCHLAUCH
HOSE FITTINGS
RACCORDS POUR TUYAUX AIRCONDITIONNE

ARMATUREN FITTINGS RACCORDS	Teilnummer part no. référence	Anschluß fitt.conn. size module du filetage	Schlauch- durchmesser hose size module du tuyau	Gewinde thread filetage	Ventil valve valve	D	R
 <p>Long pilot O-ring TXV connection incl. TXV plate</p>	52304-12-10S	-12	-10				51
	52304-12-12S	-12	-12				52
 <p>Long pilot O-ring, TXV connection incl. TXV plate - 45° elbow</p>	52305-12-10S	-12	-10			21	69
	52305-12-12S	-12	-12			24	74
 <p>Long pilot O-ring, TXV connection incl. TXV plate - 90° elbow</p>	52306-12-10S	-12	-10			44	45
	52306-12-12S	-12	-12			46	51

Sonder Armaturen auf Anfrage
Special fittings on request
Raccords spécifiques sur demande

**ARMATUR FÜR KLIMASCHLAUCH
HOSE FITTINGS
RACCORDS POUR TUYAUX AIRCONDITIONNE**



Teilnummer part no. référence	Anschluß fitt.conn. size module du filetage	Schlauch- durchmesser hose size module du tuyau	Gewinde thread filetage	Ventil valve valve	D	R	ARMATUREN FITTINGS RACCORDS
-------------------------------------	---	---	-------------------------------	--------------------------	---	---	-----------------------------------

52707-10-08S	-10	-8	1-14			58	
52707-10-10S	-10	-10	1-14			65	
52707-10-12S	-10	-12	1-14			72	



Tube-O compressor fitting

52708-10-08S	-10	-8	1-14		16	65	
52708-10-10S	-10	-10	1-14		16	65	
52708-10-12S	-10	-12	1-14		16	65	



Tube-O compressor fitting - 45° elbow

52709-10-08S	-10	-8	1-14		18	25	
52709-10-10S	-10	-10	1-14		18	25	
52709-10-12S	-10	-12	1-14		18	25	

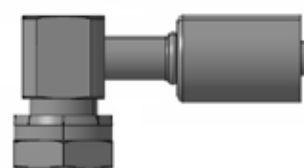

Tube-O compressor fitting - 90° elbow

**Sonder Armaturen auf Anfrage
Special fittings on request
Raccords spécifiques sur demande**

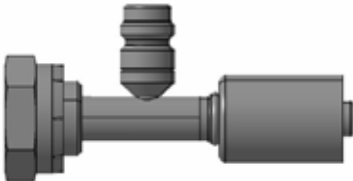
ARMATUREN FITTINGS RACCORDS	Teilnummer part no. référence	Anschluß fitt.conn. size module du filetage	Schlauch- durchmesser hose size module du tuyau	Gewinde thread filetage	Ventil valve valve	D	R
	52733-10-08S	-10	-8	1-14	16 (HP)		58
	52733-10-10S	-10	-10	1-14	13 (LP)		65
	52733-10-12S	-10	-12	1-14	13 (LP)		72

Tube-O compressor fitting - R134a valve

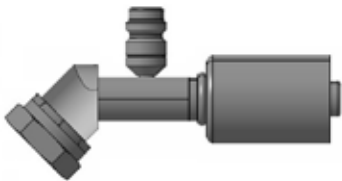
	52734-10-08S	-10	-8	1-14	16 (HP)	16	65
	52734-10-10S	-10	-10	1-14	13 (LP)	16	65
	52734-10-12S	-10	-12	1-14	13 (LP)	16	65

Tube-O compressor fitting, 45° elbow - R134a valve

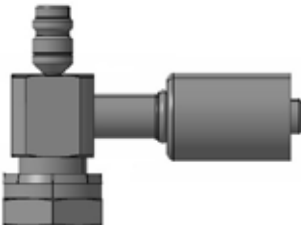
	52735-10-08S	-10	-8	1-14	16 (HP)	18	25
	52735-10-10S	-10	-10	1-14	13 (LP)	18	25
	52735-10-12S	-10	-12	1-14	13 (LP)	18	25

Tube-O compressor fitting, 90° elbow - R134a valve

Sonder Armaturen auf Anfrage
Special fittings on request
Raccords spécifiques sur demande

**ARMATUR FÜR KLIMASCHLAUCH
HOSE FITTINGS
RACCORDS POUR TUYAUX AIRCONDITIONNE**



Teilnummer part no. référence	Anschluß fitt.conn. size module du filetage	Schlauch- durchmesser hose size module du tuyau	Gewinde thread filetage	Ventil valve valve	D	R	ARMATUREN FITTINGS RACCORDS
-------------------------------------	---	---	-------------------------------	--------------------------	---	---	-----------------------------------

52450-10-08S	-10	-8	1-14		18	28	
52450-10-10S	-10	-10	1-14		18	28	
52450-10-12S	-10	-12	1-14		18	28	



Tube-O HEX block 90°

52451-10-08S	-10	-8	1-14	16 (HP)	18	28	
52451-10-10S	-10	-10	1-14	13 (LP)	18	28	
52451-10-12S	-10	-12	1-14	13 (LP)	18	28	

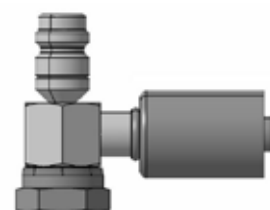

Tube-O HEX block 90° / R134a valve - top

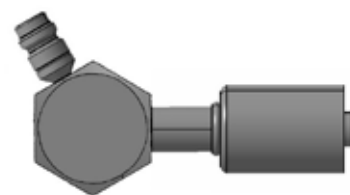

52453-10-08S	-10	-8	1-14	16 (HP)	18	28	
52453-10-10S	-10	-10	1-14	13 (LP)	18	28	
52453-10-12S	-10	-12	1-14	13 (LP)	18	28	



Tube-O HEX block 90° / R134a valve - 120°

**Sonder Armaturen auf Anfrage
Special fittings on request
Raccords spécifiques sur demande**

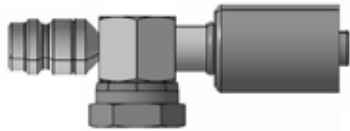
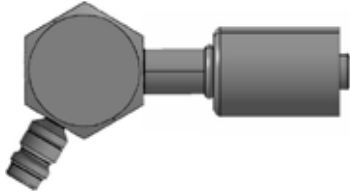
ARMATUR FÜR KLIMASCHLAUCH
HOSE FITTINGS
RACCORDS POUR TUYAUX AIRCONDITIONNE

ARMATUREN FITTINGS RACCORDS	Teilnummer part no. référence	Anschluß fitt.conn. size module du filetage	Schlauch- durchmesser hose size module du tuyau	Gewinde thread filetage	Ventil valve valve	D	R
	52454-10-08S	-10	-8	1-14	16 (HP)	18	28
	52454-10-10S	-10	-10	1-14	13 (LP)	18	28
	52454-10-12S	-10	-12	1-14	13 (LP)	18	28
<p>Tube-O HEX block 90°/ R134a valve - forward</p>							
	52455-10-08S	-10	-8	1-14	16 (HP)	18	28
	52455-10-10S	-10	-10	1-14	13 (LP)	18	28
	52455-10-12S	-10	-12	1-14	13 (LP)	18	28
<p>Tube-O HEX block 90°/ R134a valve - 240°</p>							
	52740-06-06S	-6	-6	5/8-18	16 (HP)	24	25
	52740-08-08S	-8	-8	3/4-16	16 (HP)	23	25
	52740-10-10S	-10	-10	7/8-14	13 (LP)	26	25
	52740-12-12S	-12	-12	1 1/16-14	13 (LP)	28	25
<p>O-ring swivel block type - 90°</p>							

Sonder Armaturen auf Anfrage
Special fittings on request
Raccords spécifiques sur demande

**ARMATUR FÜR KLIMASCHLAUCH
HOSE FITTINGS
RACCORDS POUR TUYAUX AIRCONDITIONNE**



Teilnummer part no. référence	Anschluß fitt.conn. size module du filetage	Schlauch- durchmesser hose size module du tuyau	Gewinde thread filetage	Ventil valve valve	D	R	ARMATUREN FITTINGS RACCORDS
-------------------------------------	---	---	-------------------------------	--------------------------	---	---	-----------------------------------

52741-06-06S	-6	-6	5/8-18	7/16-20	24	25	
52741-08-08S	-8	-8	3/4-16	7/16-20	24	25	
52741-10-10S	-10	-10	7/8-14	7/16-20	26	25	
52741-12-12S	-12	-12	1 1/16-14	7/16-20	27	25	

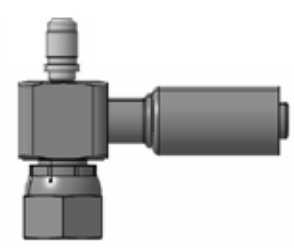

O-ring swivel block type - pressure sensor 7/16-20

52742-06-06S	-6	-6	5/8-18	16 (HP)	24	25	
52742-08-08S	-8	-8	3/4-16	16 (HP)	24	25	
52742-10-10S	-10	-10	7/8-14	13 (LP)	26	25	
52742-12-12S	-12	-12	1 1/16-14	13 (LP)	27	25	

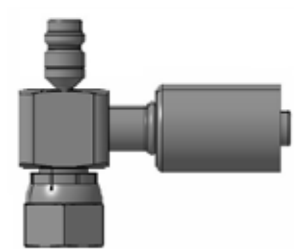

O-ring swivel block type - 90° - R134a valve - top

52412-06-06S	-6	-6	5/8-18	16 (HP)	24	25	
52412-08-08S	-8	-8	3/4-16	16 (HP)	24	25	
52412-10-10S	-10	-10	7/8-14	13 (LP)	26	25	
52412-12-12S	-12	-12	1 1/16-14	13 (LP)	27	25	

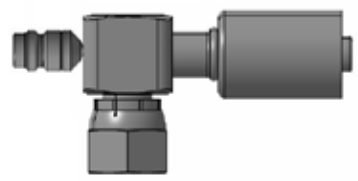

O-ring swivel block type- R134a valve - forward

**Sonder Armaturen auf Anfrage
Special fittings on request
Raccords spécifiques sur demande**

ARMATUR FÜR KLIMASCHLAUCH
HOSE FITTINGS
RACCORDS POUR TUYAUX AIRCONDITIONNE

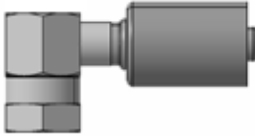
ARMATUREN FITTINGS RACCORDS	Teilnummer part no. référence	Anschluß fitt.conn. size module du filetage	Schlauch- durchmesser hose size module du tuyau	Gewinde thread filetage	Ventil valve valve	D	R
	52425-06-06S	-6	-6	5/8-18		13	25
	52425-08-08S	-8	-8	3/4-16		16	25
	52425-10-10S	-10	-10	7/8-14		16	25
O-ring HEX block - 90°							

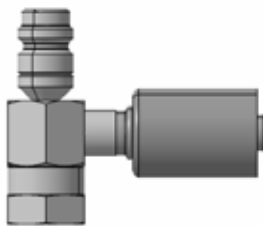
	52426-06-06S	-6	-6	5/8-18	16 (HP)	13	25
	52426-08-08S	-8	-8	3/4-16	16 (HP)	16	25
	52426-10-10S	-10	-10	7/8-14	13 (LP)	16	25
O-ring HEX block - 90° - R134a valve - top							

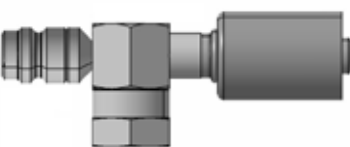
	52427-06-06S	-6	-6	5/8-18	16 (HP)	13	25
	52427-08-08S	-8	-8	3/4-16	16 (HP)	16	25
	52427-10-10S	-10	-10	7/8-14	13 (LP)	16	25
O-ring HEX block - 90° - R134a valve - forward							

Sonder Armaturen auf Anfrage
Special fittings on request
Raccords spécifiques sur demande

ARMATUR FÜR KLIMASCHLAUCH
HOSE FITTINGS
RACCORDS POUR TUYAUX AIRCONDITIONNE



Teilnummer part no. référence	Anschluß fitt.conn. size module du filetage	Schlauch- durchmesser hose size module du tuyau	Gewinde thread filetage	Ventil valve valve	D	R	ARMATUREN FITTINGS RACCORDS
-------------------------------------	---	---	-------------------------------	--------------------------	---	---	-----------------------------------

52420-06-06S	-6	-6	5/8-18	16 (HP)	13	25	
52420-08-08S	-8	-8	3/4-16	16 (HP)	16	25	
52420-10-10S	-10	-10	7/8-14	13 (LP)	16	25	

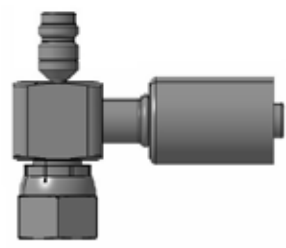

Short drop
O-ring swivel - 90° block type - R134a valve - top

52421-06-06S	-6	-6	5/8-18		13	25	
52421-08-08S	-8	-8	3/4-16		16	25	
52421-10-10S	-10	-10	7/8-14		16	25	

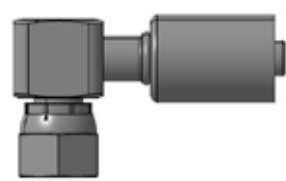

Short drop
O-ring swivel - 90° block type

52422-06-06S	-6	-6	5/8-18	16 (HP)	13	25	
52422-08-08S	-8	-8	3/4-16	16 (HP)	16	25	
52422-10-10S	-10	-10	7/8-14	13 (LP)	16	25	

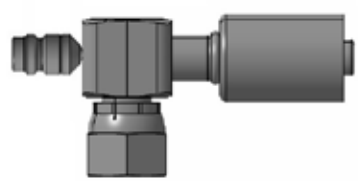

Short drop
O-ring swivel - 90° block type - R134a valve - forward

Sonder Armaturen auf Anfrage
Special fittings on request
Raccords spécifiques sur demande

ARMATUR FÜR KLIMASCHLAUCH
HOSE FITTINGS
RACCORDS POUR TUYAUX AIRCONDITIONNE

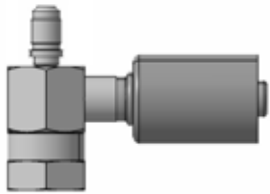
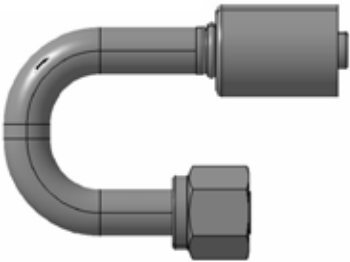
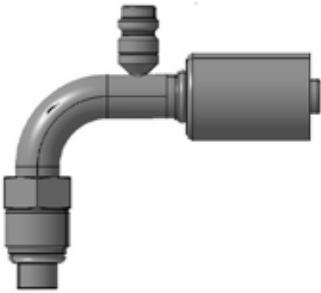
ARMATUREN FITTINGS RACCORDS	Teilnummer part no. référence	Anschluß fitt.conn. size module du filetage	Schlauch- durchmesser hose size module du tuyau	Gewinde thread filetage	Ventil valve valve	D	R
	52428-06-06S	-6	-6	5/8-18	7/16-20	13	25
	52428-08-08S	-8	-8	3/4-16	7/16-20	16	25
	52428-10-10S	-10	-10	7/8-14	7/16-20	16	25
	52428-12-12S	-12	-12	1 1/16-14	7/16-20	28	25
O-ring HEX block 90° - pressure sensor 7/16-20 - top							
	52771-06-06S	-6	-6	5/8-18		52	65/42
	52771-08-08S	-8	-8	3/4-16		60	72/50
	52771-10-10S	-10	-10	7/8-14		65	60/85
	52771-12-12S	-12	-12	1 1/16-14		75	65/92
Long pilot O-ring swivel - tube connection, 180°							
	52217-06-06S	-6	-6	5/8-18	16 (HP)	40	30
	52217-08-08S	-8	-8	3/4-16	16 (HP)	48	32
	52217-10-10S	-10	-10	7/8-14	13 (LP)	50	47
	52217-12-12S	-12	-12	1 1/16-14	13 (LP)	60	50
O-ring male swivel 90° - R134a valve							

Sonder Armaturen auf Anfrage
Special fittings on request
Raccords spécifiques sur demande

**ARMATUR FÜR KLIMASCHLAUCH
HOSE FITTINGS
RACCORDS POUR TUYAUX AIRCONDITIONNE**



Teilnummer part no. référence	Anschluß fitt.conn. size module du filetage	Schlauch- durchmesser hose size module du tuyau	Gewinde thread filetage	Ventil valve valve	D	R	ARMATUREN FITTINGS RACCORDS
-------------------------------------	---	---	-------------------------------	--------------------------	---	---	-----------------------------------

52213-06-06S	-6	-6	5/8-18			40	
52213-08-08S	-8	-8	3/4-18			45	
52213-10-10S	-10	-10	7/8-18			52	
52213-10-12S	-10	-12	7/8-18			55	
52213-12-12S	-12	-12	1 1/16-16			64	



Short pilot
O-ring male swivel

52215-06-06S	-6	-6	5/8-18		20	45	
52215-08-08S	-8	-8	3/4-18		25	50	
52215-10-10S	-10	-10	7/8-18		25	57	
52215-12-12S	-12	-12	1 1/16-16		40	72	



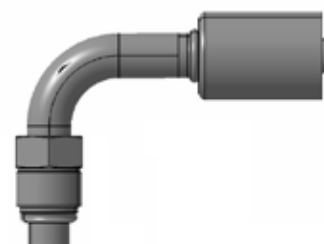

Short pilot
O-ring male swivel, 45° elbow

52214-06-06S	-6	-6	5/8-18		40	30	
52214-08-08S	-8	-8	3/4-18		48	32	
52214-10-10S	-10	-10	7/8-18		50	47	
52214-10-12S	-10	-12	7/8-18		55	47	
52214-12-12S	-12	-12	1 1/16-16		60	50	



Short pilot
O-ring male swivel, 90° elbow

**Sonder Armaturen auf Anfrage
Special fittings on request
Raccords spécifiques sur demande**

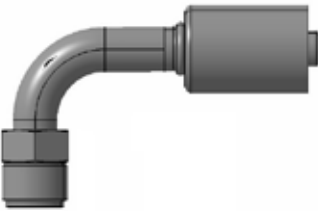
ARMATUREN	Teilnummer	Anschluß	Schlauch- durchmesser	Gewinde	Ventil	D	R
FITTINGS	part no.	fitt.conn. size	hose size	thread	valve		
RACCORDS	référence	module du filetage	module du tuyau	filetage	valve		
	52206-06-06S	-6	-6	5/8-18			38
	52206-08-08S	-8	-8	3/4-16			41
	52206-10-10S	-10	-10	7/8-14			54
	52206-12-12S	-12	-12	1 1/16-14			60
O-ring male insert straight							
	52207-06-06S	-6	-6	5/8-18		22	42
	52207-08-08S	-8	-8	3/4-16		32	57
	52207-10-10S	-10	-10	7/8-14		35	67
	52207-12-12S	-12	-12	1 1/16-14		35	80
O-ring male insert, 45° elbow							
	52208-06-06S	-6	-6	5/8-18		42	30
	52208-08-08S	-8	-8	3/4-16		55	42
	52208-10-10S	-10	-10	7/8-14		62	42
	52208-12-12S	-12	-12	1 1/16-14		45	50
O-ring male insert, 90° elbow							

Sonder Armaturen auf Anfrage
Special fittings on request
Raccords spécifiques sur demande

**ARMATUR FÜR KLIMASCHLAUCH
HOSE FITTINGS
RACCORDS POUR TUYAUX AIRCONDITIONNE**



Teilnummer part no. référence	Anschluß fitt.conn. size module du filetage	Schlauch- durchmesser hose size module du tuyau	Gewinde thread filetage	Ventil valve valve	D	R	ARMATUREN FITTINGS RACCORDS
-------------------------------------	---	---	-------------------------------	--------------------------	---	---	-----------------------------------

52617-06-06S	-6	-6	5/8-18	M10x1.25		50	
52617-08-08S	-8	-8	3/4-16	M10x1.25		50	
52617-10-10S	-10	-10	7/8-14	M10x1.25		55	
52617-12-12S	-12	-12	1 1/16-14	M10x1.25		58	

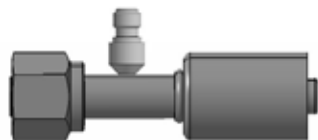

O-ring female swivel - switch adapter M10x1.25

52618-06-06S	-6	-6	5/8-18	M10x1.25	15	55	
52618-08-08S	-8	-8	3/4-16	M10x1.25	15	55	
52618-10-10S	-10	-10	7/8-14	M10x1.25	22	67	
52618-12-12S	-12	-12	1 1/16-14	M10x1.25	25	73	

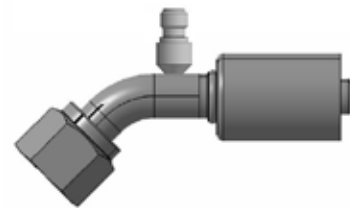

O-ring female swivel - switch adapter M10x1.25, 45° elbow

52619-06-06S	-6	-6	5/8-18	M10x1.25	30	50	
52619-08-08S	-8	-8	3/4-16	M10x1.25	35	55	
52619-10-10S	-10	-10	7/8-14	M10x1.25	45	60	
52619-12-12S	-12	-12	1 1/16-14	M10x1.25	48	70	

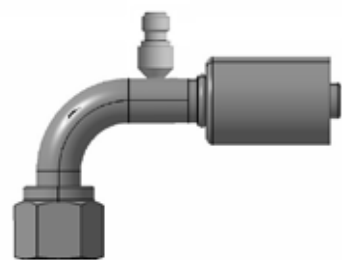

O-ring female swivel - switch adapter M10x1.25, 90° elbow

**Sonder Armaturen auf Anfrage
Special fittings on request
Raccords spécifiques sur demande**

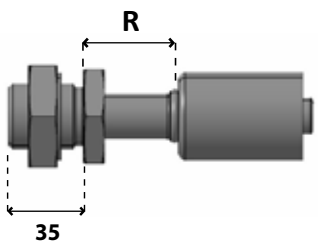
ARMATUREN FITTINGS RACCORDS	Teilnummer part no. référence	Anschluß fitt.conn. size module du filetage	Schlauch- durchmesser hose size module du tuyau	Gewinde thread filetage	Ventil valve valve	D	R
	52758-06-06S	-6	-6	5/8-18			25
	52758-08-08S	-8	-8	3/4-16			25
	52758-10-10S	-10	-10	7/8-14			32
	52758-12-12S	-12	-12	1 1/16-14			32
Bulkhead male insert O-ring, straight							

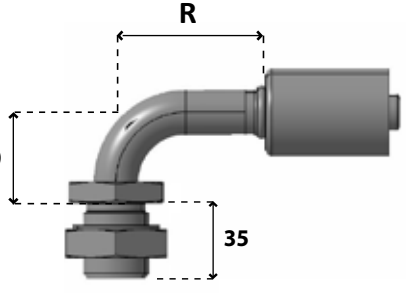
	52759-06-06S	-6	-6	5/8-18		32	30
	52759-08-08S	-8	-8	3/4-16		42	42
	52759-10-10S	-10	-10	7/8-14		52	52
	52759-12-12S	-12	-12	1 1/16-14		52	52
Bulkhead male insert O-ring, , 90° elbow							

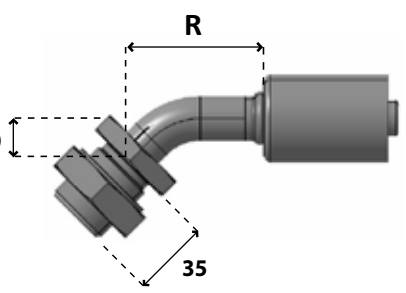
	52760-06-06S	-6	-6	5/8-18		25	50
	52760-08-08S	-8	-8	3/4-16		25	55
	52760-10-10S	-10	-10	7/8-14		25	60
	52760-12-12S	-12	-12	1 1/16-14		30	60
Bulkhead male insert O-ring, , 45° elbow							

Sonder Armaturen auf Anfrage
Special fittings on request
Raccords spécifiques sur demande

**ARMATUR FÜR KLIMASCHLAUCH
HOSE FITTINGS
RACCORDS POUR TUYAUX AIRCONDITIONNE**



Teilnummer part no. référence	Schlauch- durchmesser hose size module du tuyau	Gewinde thread filetage	Ventil valve valve	D	R	ARMATUREN FITTINGS RACCORDS
-------------------------------------	---	-------------------------------	--------------------------	---	---	-----------------------------------

(52) 7087-06-06S	-6				60	
(52) 7087-08-08S	-8				60	
(52) 7087-10-10S	-10				60	
(52) 7087-12-12S	-12				60	



Inline splicer

(52) 7097-06-06S	-6			22	50	
(52) 7097-08-08S	-8			24	50	
(52) 7097-10-10S	-10			25	50	
(52) 7097-12-12S	-12			28	50	

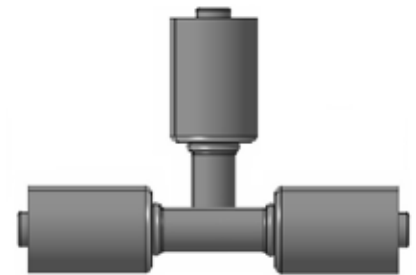

Inline T-splicer

(52) 7024-06-06S	-6		16 (HP)		50	
(52) 7024-08-08S	-8		16 (HP)		50	
(52) 7024-10-10S	-10		13 (LP)		50	
(52) 7024-12-12S	-12		13 (LP)		50	



Inline splicer - R134a valve

**Sonder Armaturen auf Anfrage
Special fittings on request
Raccords spécifiques sur demande**

ARMATUREN	Teilnummer	Schlauch- durchmesser	Gewinde	Ventil	D	R
FITTINGS	part no.	hose size	thread	valve		
RACCORDS	référence	module du tuyau	filetage	valve		

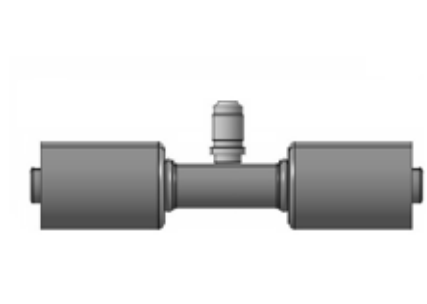

Inline splicer - pressure sensor 7/16-20

(52) 7020-06-06S	-6			17 (HP)		50
(52) 7020-08-08S	-8			17 (HP)		50
(52) 7020-10-10S	-10			14 (LP)		50
(52) 7020-12-12S	-12			14 (LP)		50

Maatvoering, afbeeldingen en teksten in deze folder zijn niet bindend.
 Dimensions, pictures and text in this leaflet are not binding.
 Ce document n'est pas contractuel et peut être modifié à tout moment.
 Maßzahlen, Bilder und Text in dieser Katalog sind nicht bindend.
 retici firma ölçüler, resimler ve tanımlamalar üzerinde değişiklik yapma hakkını saklı tutar.

Sonder Armaturen auf Anfrage
Special fittings on request
Raccords spécifiques sur demande

KAPPE
PROTECTION CAP
CAPUCHON

O-RING
O-RING
O-RING

part no.



7042

protection cap 7/16 - 201/4



52XXX-X-XS
52XXX = Bestell nr., part no., référence
X = Schlauchgröße, fitt.conn.size, module du filetage
X = Schlauchmaß, hoze size, module du tuyau,
S = Stahl, staal, steel

part no.	I.D. (mm)	width (mm)	proposed torque (Nm)
7028-06	7.65	1.78	13,6-20,3
7028-08	10.82	1.78	32,5-42,0
7028-10	14.00	1.78	35,3-42,0
7028-12	17.17	1.78	40,7-47,5

SCHLUSSKAPPE
PROTECTION CAP VALVES + CORE
CAPUCHON

RUN AND DROP

part no.

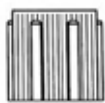

7037

protection cap (red) (HP)

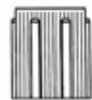

7038

protection cap (blue) (LP)



7039

valve core

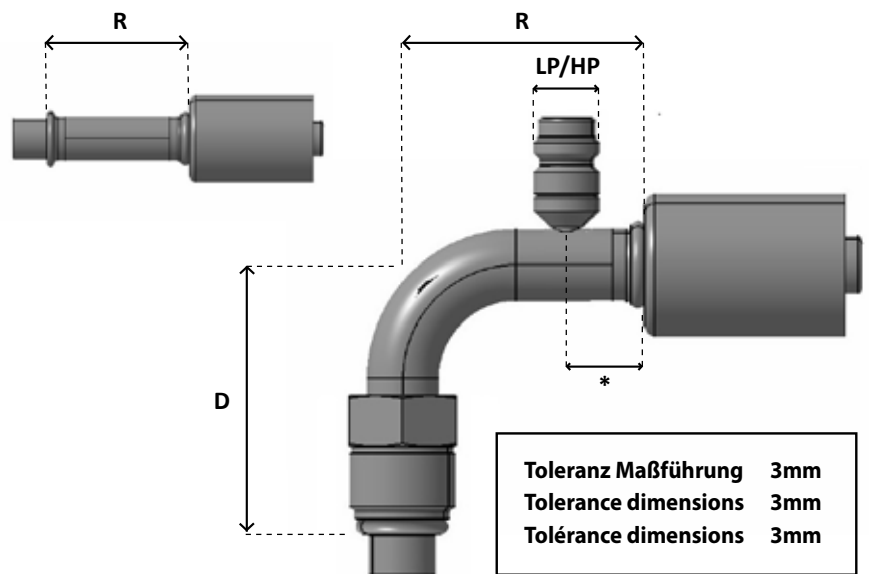

Toleranz Maßführung	3mm
Tolerance dimensions	3mm
Tolérance dimensions	3mm

* Dimension related to partnumber between 20-25 mm.

Burgaflex BV Holland

Mon Plaisir 112
4879 AT Etten-Leur
Tel. +31(0)76 503 5000
E-mail info@burgaflex.nl

Burgaflex UK Ltd.

Unit 1.03 Phoenix Park Industrial Estate
Phoenix Close
Heywood, Lancs. OL10 2JG
Tel. +44(0)1706 620 220
E-mail info@burgaflex.co.uk

Burgaflex Turkey Ltd.

Orta Olcekli San. Sit., 14.Sokak No. 10
Muradiye Mah., Yunusemre 45140
Manisa Turkey
Tel. +90(0)236 2140520 - 21
E-mail info@burgaflex.com.tr

Burgaflex Poland SP. Z.o.o.

ul. Plonów 24
41-200 Sosnowiec
Tel. +48(0)720 873 405
E-mail info@burgaflex.com

Burgaflex France SAS

Z.A. De Perriers, 82-84 Route de Cor
78505 SARTROUVILLE CEDEXmeilles
Tel. +33(0)1 3962 83 67
E-mail info@burgaflex.fr

Burgaflex Asia Pacific

14 Motorway Circuit
Ormeau, Queensland 4208
Tel. +61(0)7 5549 4022
E-mail info@burgaflex.com.au

Burgaflex China Limited

Unit 1109, 11/F, Manhattan Center
8 Kwai Cheong Road, Kwai Chung, N.T.
Hong Kong
Tel. +852(0)2422 0180

Burgaflex



www.burgaflex.com