

mocom[®]
Sistemi innovativi di sterilizzazione



**STEAM
STERILIZER**

millennium[®] S

OPERATING MANUAL

mocom[®]
Sistemi innovativi di sterilizzazione

Quality System certified by



CE 93/42 CEE
MEDICAL DEVICES
0051

REVISIONS

The following table lists subsequent editions/revisions of the manual.
The "Description" field brief explains the subject of the latest revision.

Ed.	Rev.	Date	Description
1	0	06-2007	First issue

TABLE OF CONTENTS

1 - INTRODUCTION	1
APPLICABLE EUROPEAN DIRECTIVES	1
INTENDED USE	1
PURPOSE OF THE MANUAL	2
GENERAL WARNINGS	2
2 - CONTENTS OF THE PACKAGE	3
DIMENSIONS AND WEIGHT	3
DESCRIPTION OF THE CONTENTS	3
HANDLING THE PRODUCT	4
3 - PRODUCT INTRODUCTION	5
INTRODUCTION	5
GENERAL CHARACTERISTICS	5
FRONT	6
REAR	7
CONTROL PANEL	8
LCD DISPLAY	8
OPERATING CYCLE EXAMPLE	9
4 - INSTALLATION	10
INTRODUCTION	10
COMPARTMENT DIMENSIONS FOR BUILT-IN INSTALLATIONS	10
GENERAL INSTALLATION PRECAUTIONS	11
ELECTRICAL CONNECTIONS	11
CONNECTING THE DATA RECORDING MILLFLASH	11
CONNECTING AN EXTERNAL WATER FILLING TANK	12
CONNECTING THE MILLDROP	12
DIRECT CONNECTION TO A CENTRALIZED DRAINING POINT	13

5 - FIRST START-UP	14
TURNING ON THE EQUIPMENT	14
INITIAL AUTOMATIC TEST	14
ACQUISITION AND UPDATING OF THE AMBIENT PRESSURE VALUES	14
STAND-BY MODE	15
FILLING DISTILLED WATER.....	16
Manual filling	16
Automatic filling (option).....	16
MAX LEVEL OF USED WATER.....	17
6 - CONFIGURATION	18
INTRODUCTION.....	18
STARTING AND ENTERING THE SETUP MODE	18
MEANING OF THE KEYS IN SETUP MODE.....	18
DESCRIPTION OF THE MENU ITEMS	20
DEFAULTS SETTINGS.....	22
ACTIVATING CONFIGURATION OPTIONS.....	22
Setting the language	22
Setting the date.....	22
Setting the time	23
Setting the password	23
Setting the sterilization programs.....	24
Setting the STAND-BY mode.....	26
Setting the printing mode	27
Setting the tank filling mode.....	29
Acquisition of the ambient pressure.....	29
Adjusting the contrast of the liquid crystal display.....	30
EXIT THE CONFIGURATION MODE	30
7 - PREPARING THE MATERIAL	31
INTRODUCTION.....	31
TREATING THE MATERIAL BEFORE STERILIZATION.....	31
ARRANGING THE LOAD.....	32
8 - PROGRAM SELECTION	34
INTRODUCTION.....	34
PROCEDURE	34
9 - RUNNING THE CYCLE	36
INTRODUCTION.....	36
STARTING THE CYCLE	36
PROGRAM EXECUTION.....	37
RESULT OF THE CYCLE	40
CHECK OF THE CYCLE DATA REPORT (OPTION)	41
MANUAL CYCLE INTERRUPTION.....	42
10 - STORING STERILIZED MATERIALS	43
INTRODUCTION.....	43
HANDLING.....	43
STORAGE.....	43
11 - TEST PROGRAMS	44
INTRODUCTION.....	44
VACUUM TEST.....	44

APPENDIX A – TECHNICAL CHARACTERISTICS 46
 SUMMARY TABLE 46
 SAFETY DEVICES 47
 WATER SUPPLY CHARACTERISTICS 48

APPENDIX B – PROGRAMS 49
 INTRODUCTION 49
 PROGRAM SUMMARY TABLE 50
 STERILIZATION PROGRAM DIAGRAMS 51
 TEST PROGRAM DIAGRAM 54
 EXAMPLES OF PRINTED REPORTS 55

APPENDIX C – MAINTENANCE 56
 INTRODUCTION 56
 ORDINARY MAINTENANCE PROGRAM 56
 MAINTENANCE DESCRIPTION 57
 Clean gasket and porthole 57
 Clean external surfaces 57
 Clean sterilization chamber and accessories 57
 Disinfect external surfaces 57
 Clean internal distilled water tank 58
 Safety valve maintenance 58
 Clean/replace the drain filter 58
 Replace bacteriological filter 59
 Replacing the paper in the printer (option) 59
 PERIODIC STERILIZER VALIDATION 60
 RECYCLING / DISPOSAL INSTRUCTIONS 60

APPENDIX D – GENERAL PROBLEMS 61
 INTRODUCTION 61
 ANALYSIS AND RESOLUTION OF PROBLEMS 61

APPENDIX E – ALARMS 64
 INTRODUCTION 64
 ALARM INTERVENTION 64
 Alarm during a cycle 64
 Alarm outside the cycle 65
 RESETTING THE SYSTEM 66
 ALARM CODES 67
 ANALYSIS AND RESOLUTION OF PROBLEMS 69

APPENDIX F – DIAGRAMS 73
 ELECTRICAL DIAGRAM (BOARD TYPE “T”) 73
 PLUMBING DIAGRAM 74

APPENDIX G – DECLARATION OF CONFORMITY 75

APPENDIX H – NOTES PER THE OPERATOR 76

APPENDIX Z – TECHNICAL SUPPORT 77

INTRODUCTION





Dear Customer

Thank you for choosing a product from M.O.COM. Srl. We hope that you will find it completely satisfactory.

This manual describes all procedures for the correct use of the device and instructions for deriving the full benefit from its features.

In any case, we will be available to provide explanations and to receive any suggestions you may have for improving our products or services.

Symbols used in the manual

<u>NOTE</u>	
	PAY SPECIAL ATTENTION TO PARAGRAPHS INDICATED BY THE POINTING FINGER.
<u>WARNING</u>	
	THIS SYMBOL INDICATES A POTENTIAL DANGER OF INJURY. FOLLOW THE PROCEDURES DESCRIBED IN THE MANUAL TO AVOID INJURING THE USER AND/OR OTHERS.
<u>DANGER</u>	
	THIS SYMBOL INDICATES A POTENTIAL DANGER OF PROPERTY DAMAGE. FOLLOWS THE INSTRUCTIONS IN THE MANUAL TO PREVENT POTENTIAL DAMAGE TO MATERIALS, EQUIPMENT OR OTHER PROPERTY.
<u>DANGER</u>	
	THIS SYMBOL INDICATES A POTENTIAL DANGER DUE TO HIGH TEMPERATURE.
	THE MATERIAL THE STERILIZER IS COMPOSED OF MUST BE DISPOSED ACCORDING TO THE DIRECTIVE 2002/96/CEE





APPLICABLE EUROPEAN DIRECTIVES

The product described in this manual is manufactured in accordance with the highest safety standards and doesn't represent any danger for the operator if used according to the following instructions. The product is in accordance with the following European Directive as applicable:

- 73/23/CEE,** for the approximation to the legislation of the Members States related to low voltage equipment (and following modifications).
- 89/336/CEE,** for the approximation to the legislation of the Members States related to the electromagnetic compatibility (and following modifications);
- 93/42/CEE,** concerning the medical devices (and following modifications).

INTENDED USE

The product described in this manual is exclusively intended for the sterilization of re-usable instruments.

<u>WARNING</u>	
	THE DEVICE MUST ONLY BE USED BY QUALIFIED PERSONNEL. IT MAY NOT BE USED OR HANDLED BY INEXPERT AND/OR UNAUTHORIZED PERSONNEL FOR ANY REASON. THIS DEVICE MUST NOT BE USED FOR THE STERILIZATION OF FLUIDS, LIQUIDS OR PHARMACEUTICAL PRODUCTS.
<u>NOTE</u>	
	THE MANUAL INFORMATION ARE SUBJECT TO CHANGES WITHOUT ANY NOTICE. MO.COM. LTD. Co. WON'T BE RESPONSIBLE FOR DIRECT, INDIRECT, ACCIDENTAL, CONSEQUENT DAMAGES OR OTHER DAMAGES RELATED TO THE SUPPLY OR THE USE OF SUCH INFORMATION. THIS DOCUMENT MAY NOT BE REPRODUCED, ADAPTED OR TRANSLATED, IN WHOLE OR IN PART, WITHOUT THE PRIOR, WRITTEN AUTHORIZATION OF M.O.COM. SRL  AND  ARE REGISTERED TRADEMARKS OF M.O.COM. SRL

PURPOSE OF THE MANUAL

The purpose of this manual is to provide instructions for:

- becoming generally familiar with the product;
- its correct installation and configuration;
- its safe, efficient use;
- handling materials before and after sterilization.

Its appendices also provide:

- the product's general technical specifications;
- sterilization program specifications;
- maintenance;
- troubleshooting;
- a variety of other documentation.

GENERAL WARNINGS

When using this product, always follow the instructions in the manual and never use for anything other than its intended purpose.

WARNING



THE USER IS RESPONSIBLE FOR ALL LEGAL REQUIREMENTS RELATED TO THE INSTALLATION AND USE OF THIS PRODUCT. THE MANUFACTURER WILL NOT BE RESPONSIBLE FOR ANY BREAKAGE, MALFUNCTIONS, PROPERTY DAMAGE OR INJURY IN THE EVENT THAT THE PRODUCT IS NOT INSTALLED OR USED CORRECTLY.

Please observe the following precautions in order to avoid injury or property damage:

- Use **ONLY** distilled water of high quality.

WARNING



THE USE OF WATER OF INADEQUATE QUALITY CAN SEVERELY DAMAGE THE DEVICE. SEE APPENDIX A, TECHNICAL CHARACTERISTICS IN THIS REGARD .

- **Do not** pour water or other liquids on the device;
- **Do not** pour inflammable substances on the device;
- **Do not** use the device in the presence of gas or explosive or inflammable vapors;
- Before performing any maintenance or cleaning, **ALWAYS DISCONNECT** the electricity.

DANGER



WHENEVER IT IS NOT POSSIBLE TO DISCONNECT THE ELECTRICITY TO THE DEVICE, OR IF THE EXTERNAL POWER GRID SWITCH IS FAR AWAY OR, AT ANY RATE, NOT VISIBLE TO THE MAINTAINER, PLACE A WORK IN PROGRESS SIGN ON THE EXTERNAL POWER GRID SWITCH AFTER TURNING IT OFF

- Make sure the electrical system is **grounded** conforming to current laws and/or standards;
- **Do not** remove any label or nameplate from the device; request new ones, if necessary.
- Use **only** original replacement parts.

WARNING



THE FAILURE TO OBSERVE THE ABOVE, RELEASES THE MANUFACTURER FROM ALL LIABILITY.

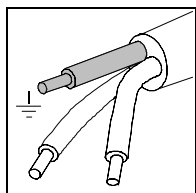
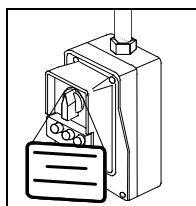

CONTENTS OF THE PACKAGE

DIMENSIONS AND WEIGHT

Total weight about 65 kg

NOTE

CHECK THE INTEGRITY OF THE PACKAGE UPON RECEIPT.

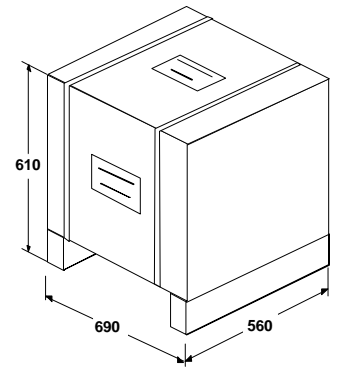

- Once the package is opened, check that:
- the supply matches the specifications of the order (see the accompanying document);
 - that there is no obvious product damage;

NOTE

IN THE CASE OF A WRONG PRODUCT, MISSING PARTS OR ANY TYPE OF DAMAGE, IMMEDIATELY PROVIDE A DETAILED DESCRIPTION TO THE RESELLER AND THE TRANSPORTER THAT MADE THE DELIVERY.

DESCRIPTION OF THE CONTENTS

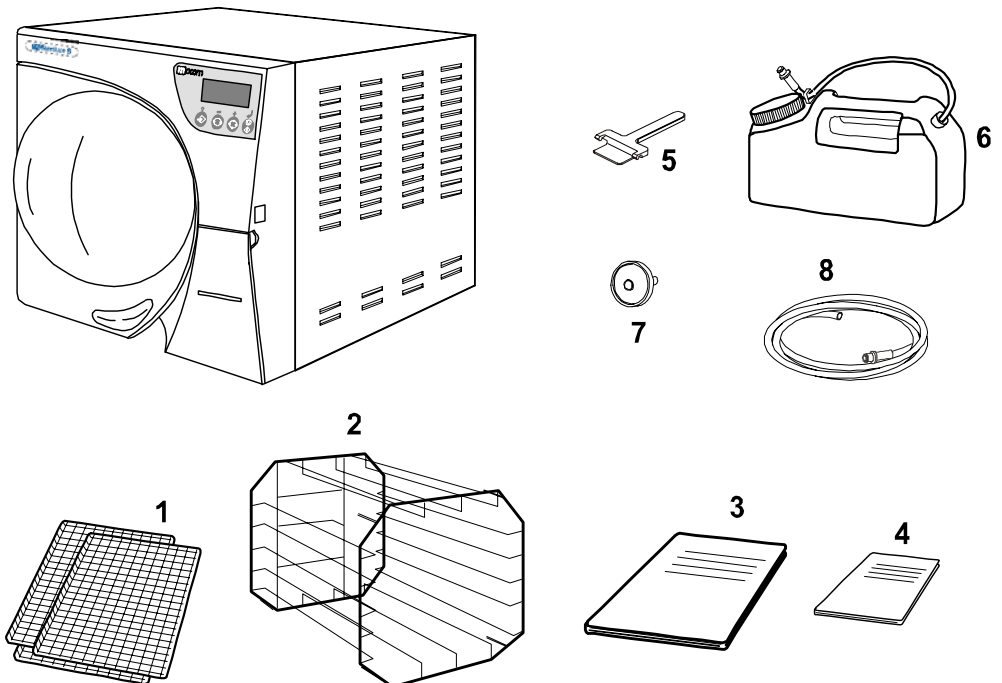

The package contains:

- Steam sterilizer
- Stainless steel wire instrument tray (3 pcs.) (Ref. 1);
- Stainless steel wire tray support (Ref. 2);
- Instruction manual (Ref. 3);
- Warranty certificate (Ref. 4) (*see note*).
- Tray extractor (Ref. 5);
- Container with quick connector for adding distilled water (about 2 l) (Ref. 6);
- Extra bacteriological filter (Ref. 7)
- Silicone tube (2 m) for draining water, with quick connector (Ref. 8).

NOTE

THE CUSTOMER MUST KEEP THE WARRANTY CERTIFICATE TOGETHER WITH THE RECEIPT.

HANDLING THE PRODUCT

Where possible, the packaged product must be handled using suitable mechanical means (forklift truck, transpallet, etc.) and following the instructions shown on the package. In the case of manual handling, the product must be lifted by two persons using the handles cut in the side of the box.

Once removed from the box, the sterilizer must be lifted by two persons and transported on a cart or other similar device.

WARNING



WE RECOMMEND THAT THE DEVICE BE TRANSPORTED AND STORED AT A TEMPERATURE NO LOWER THAN 5 °C. PROLONGED EXPOSURE TO LOW TEMPERATURE AN DAMAGE THE PRODUCT.

NOTE



KEEP THE ORIGINAL PACKAGING AND USE IT WHENEVER THE DEVICE IS TO BE TRANSPORTED. THE USE OF DIFFERENT PACKAGING COULD DAMAGE THE PRODUCT DURING SHIPMENT.

DANGER



BEFORE TRANSPORT, LEAVE THE DEVICE TURNED-OFF FOR ABOUT 30 MINUTES AFTER THE LAST PROGRAM FINISHES AND DRAIN THE DISTILLED WATER AND USED WATER TANKS SO THAT THE ALL THE HOT INTERNAL PARTS WILL HAVE TIME TO COOL.

PRODUCT INTRODUCTION

INTRODUCTION

Millennium S is MO.COM.'s revolutionary type S (EN 13060) small steam sterilizer and a new de facto standard for safety, performance, flexibility and ease of use.

It is a sophisticated but, at the same time, easy to use device that, thanks to its wide range of configuration options and patented operating devices, satisfies every need for sterilizing medical devices, guaranteeing the maximum performance under all conditions.

It also features a better way of relating to users who, rather than having to adapt to the machine and its characteristics, are able to "converse" with it and configure it to meet their own needs.

Thanks to its remarkable ease of use, small size and pleasant appearance, it is the ideal partner for all professional who demand the maximum sterilization safety.

GENERAL CHARACTERISTICS

Millennium S is a completely microprocessor-controlled steam sterilizer with a large (17-liter) sterilization chamber made of stamped stainless steel.

It is characterized by an advanced single vacuum system for the complete removal of air, even from wrapped materials, and an effective final vacuum drying phase capable of eliminating all traces of humidity from the load.

Its exclusive steam generation system, effective plumbing circuit and electronic management (supplemented by high-precision sensors) guarantees a fast process and excellent stability of the thermodynamic parameters.

Moreover, its Process Evaluation System constantly monitors all the machine's "vital" parameters in real-time, guaranteeing absolute safety and a perfect result.

It offers users **6** sterilization programs, all equipped with customizable, optimized drying for the fast, effective sterilization of the various types of loads (instruments and materials) used in a medical environment.

Four of these can be selected directly from the control panel, which has a new simplified, design.

And then, there are interesting options for configuring the preheating mode (based on the sterilizer's use rate, and the automatic filling of the internal distilled water tank via an external tank or Milldrop equipment (optional feature).

Please refer to the chapters "**Installation**" and "**Configuration**" for more details.

Finally, **Millennium S** has one of the most complete, sophisticated and advanced safety systems available today to protect users in the case of any electrical, mechanical, thermal or biological operating anomaly.

NOTE



PLEASE REFER TO APPENDIX A (TECHNICAL CHARACTERISTICS) FOR A DESCRIPTION OF THE SAFETY DEVICES.

FRONT

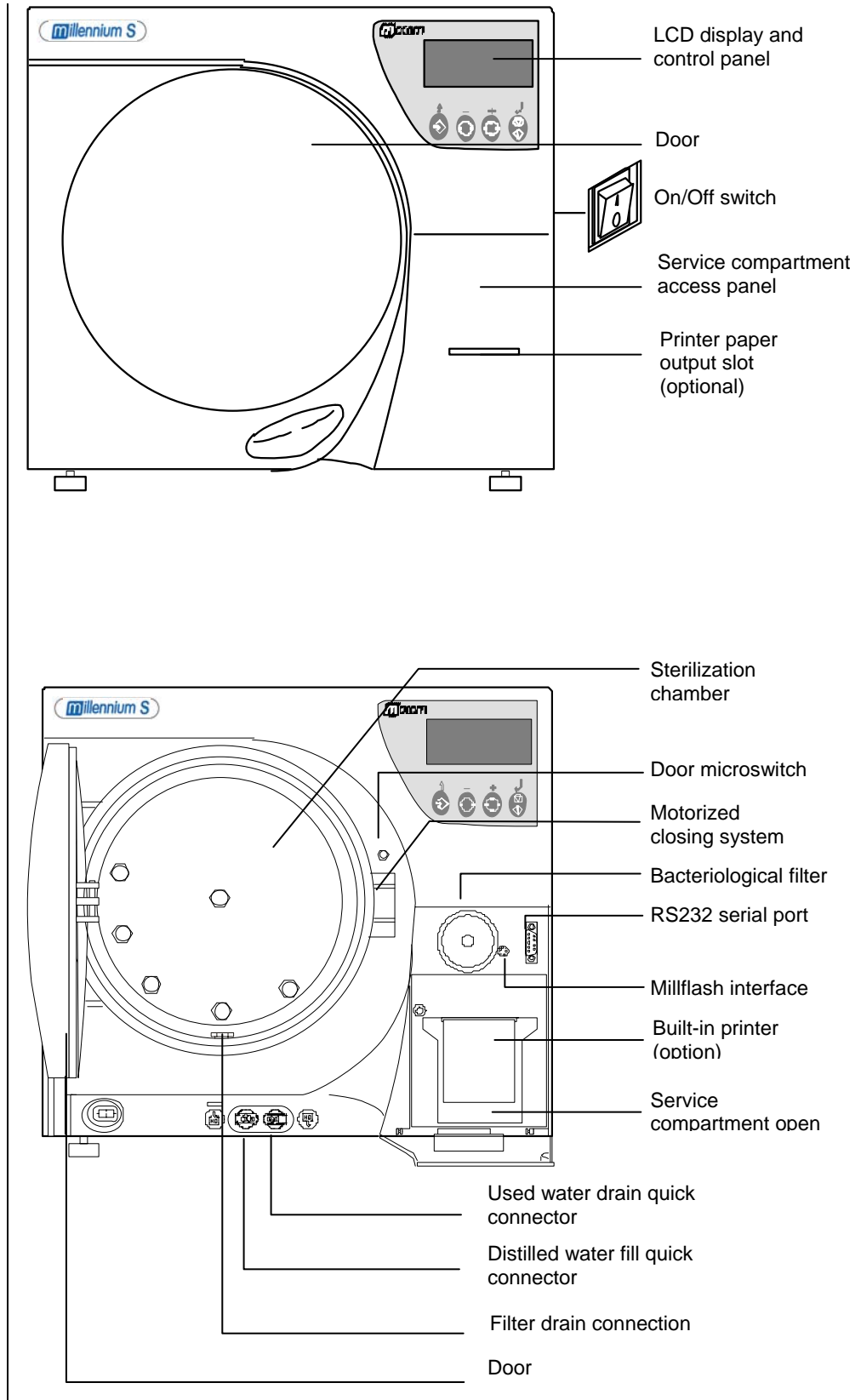

REAR

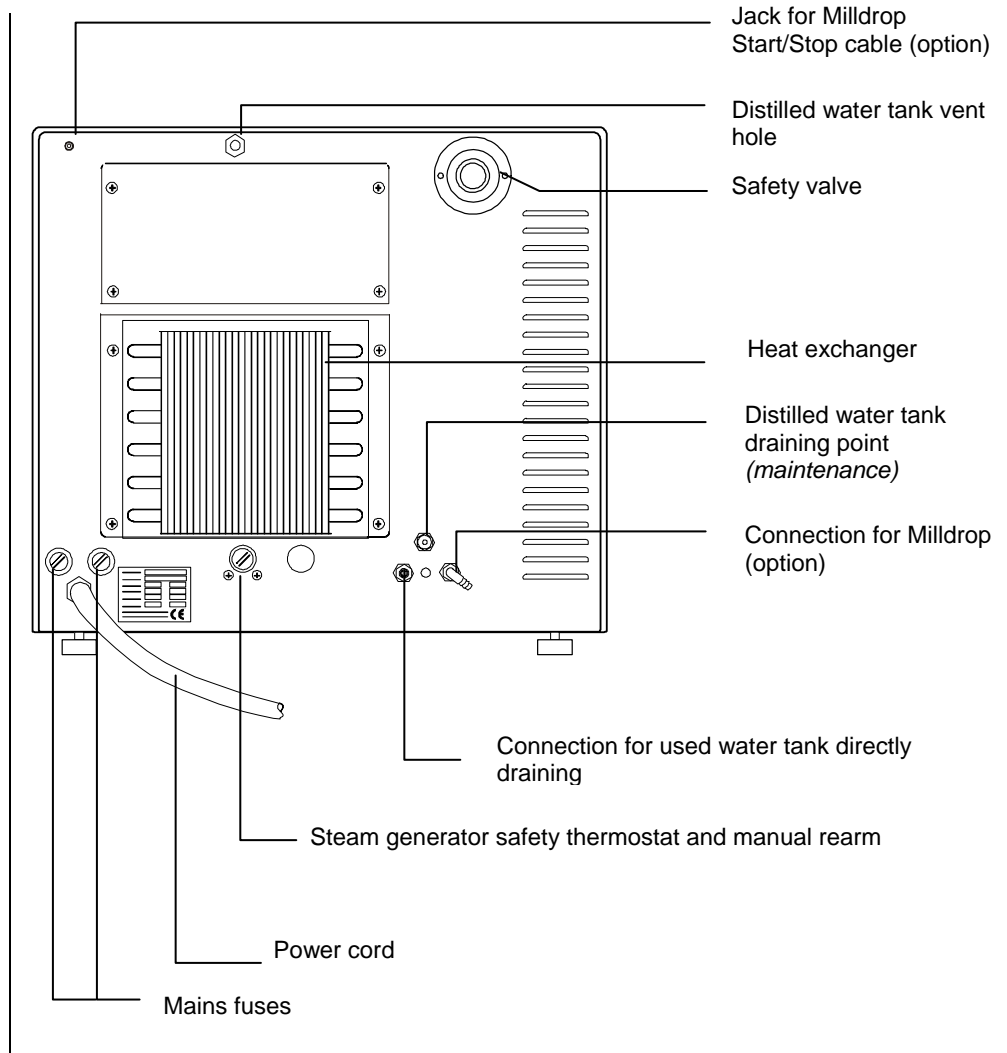

CONTROL PANEL

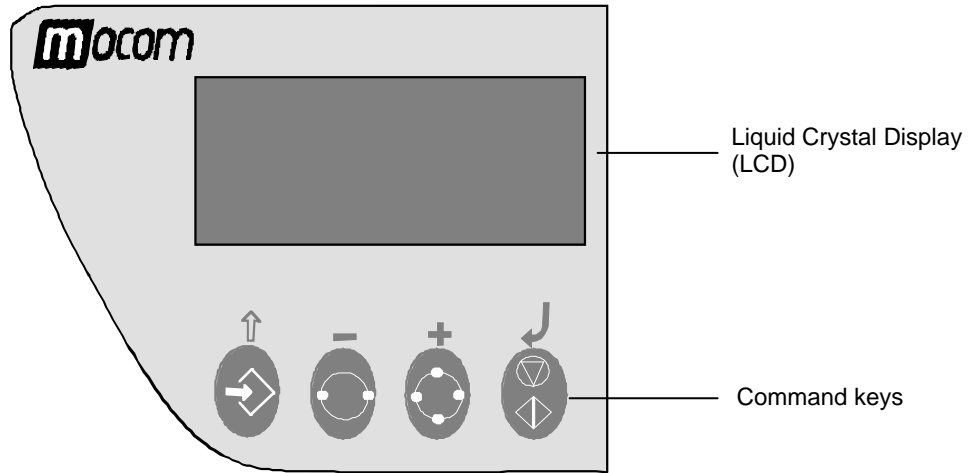

The function of the command keys differ according to operating mode of the equipment.

Key	NORMAL mode	SETUP mode
	Cycle Start/Stop	Enter , confirmation of the value/option selected
	Sterilization cycle selection	Value increment / Forward scroll of the menu options
	Test cycle selection	Value decrement / Backward scroll of the menu options
	Enter Setup mode	ESC , quit the current menu

LCD DISPLAY

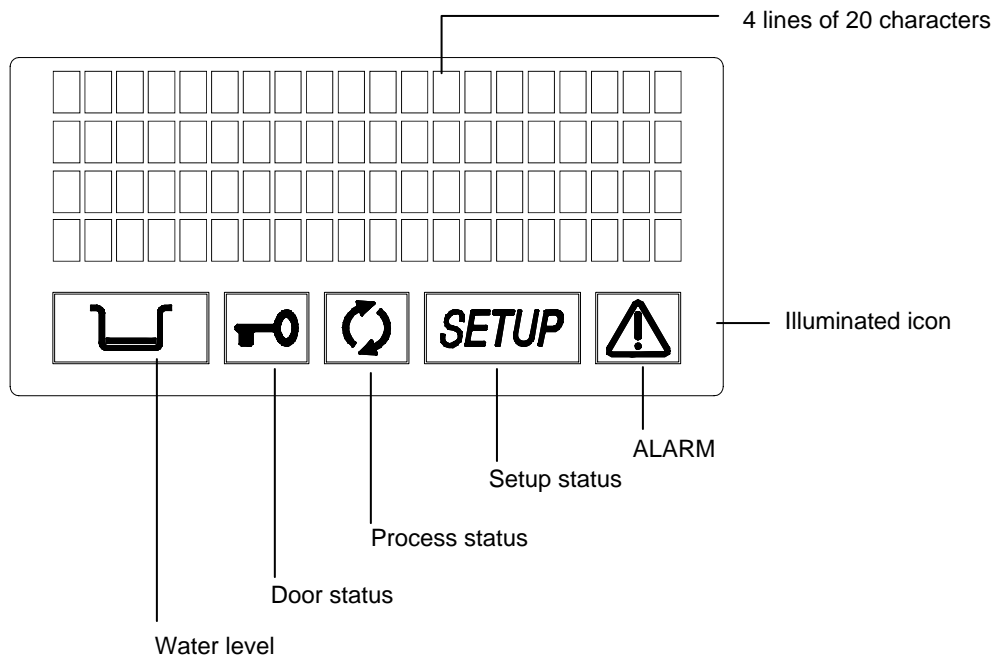

**OPERATING
CYCLE EXAMPLE**

The Millennium S sterilization program can be described as a succession of phases, each with a specific purpose.

For example, the standard program (for wrapped materials, 134 °C - 4'), after loading the material in the chamber, closing the door, selecting the program and starting the cycle (and the consequent locking of the door opening mechanism), offers the following sequence (see chart, below):

1. preheating the generator and sterilization chamber;
2. removing the air through a single vacuum phase (extraction of the fluid from the sterilization chamber);
3. raising the pressure, with the consequent increase in the temperature of the steam, until reaching the conditions required for sterilization (in the example, **134 °C**);
4. stabilizing the pressure and temperature;
5. sterilizing for the required time (in the example, **4 minutes**);
6. depressurizing the sterilization chamber;
7. vacuum-drying phase;
8. ventilating the load with sterile air;
9. bringing the pressure of the sterilization chamber back to the atmospheric level.

After reaching atmospheric pressure, the door is automatically unlocked and it can be opened to remove the load from the sterilization chamber.

It should be emphasized that phases 1, 2, 3, 4, 6 and 9 are identical in all cycles, with slight variations of duration that are solely dependent on the quantity and consistency of the load and the heating conditions of the sterilizer while phases 5, 7 and 8 clearly vary their configuration and/or duration on the basis of the cycle selected (and, as a consequence, the type of load) and the choices made by the user.

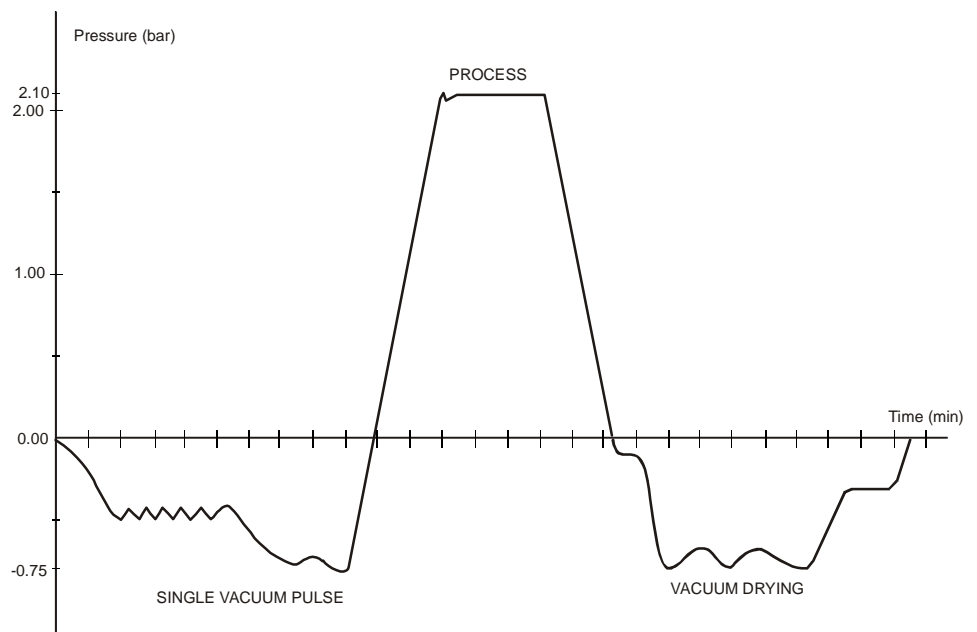

NOTE

PLEASE REFER TO APPENDIX B (PROGRAMS) FOR MORE DETAIL.

**INSTALLATION
INTRODUCTION**

The first and fundamental step in achieving good sterilizer operation, long life and complete use of its features is a correct, careful installation. Moreover, this precaution will avoid the danger of physical injury or property damage, not to mention malfunctions and damage to the machine. So, please follow the instructions in this chapter scrupulously.

NOTE

M.O.COM. CUSTOMER SUPPORT (SEE APPENDIX Z) WILL ANSWER YOUR QUESTIONS AND PROVIDE ADDITIONAL INFORMATION. THE STERILIZER HAS PASSED ALL REQUIRED INSPECTIONS BEFORE BEING PLACED ON THE MARKET. IT DOES NOT REQUIRE ANY ADDITIONAL CALIBRATION BEFORE BEING PLACED IN SERVICE.

Dimensions and weight

- Height (total) 420 mm
- Width (total) 480 mm
- Depth (excluding rear connections) 560 mm
- Total weight 53 kg

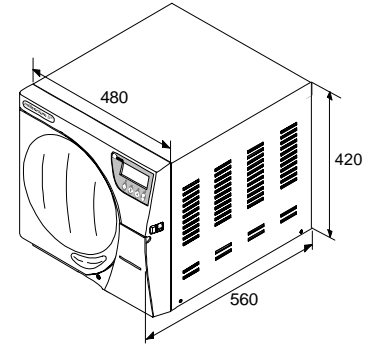

Electricity

The electrical system to which the sterilizer will be connected must be suitably dimensioned based on the electrical characteristics of the device. This information is shown on the **back of the machine**.

COMPARTMENT DIMENSIONS FOR BUILT-IN INSTALLATIONS

When installing the sterilizer inside a cabinet, you must provide adequate space all around the device (> 10cm, specially on the rear side) to provide effective ventilation as well as a large enough opening in the back that, in addition to allowing the passage of the power cord will also provide an adequate air flow and the consequent optimum cooling of the heat exchanger. It is indispensable that the built-in compartment have the following minimum dimensions shown in the figure.

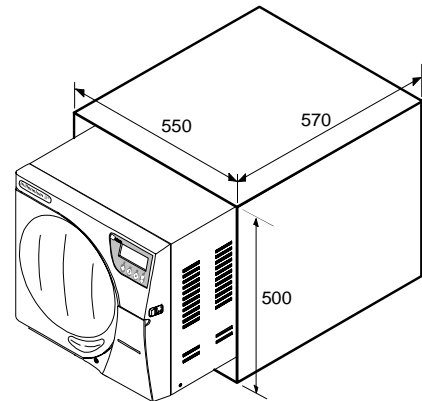

WARNING

COMPARTMENT DIMENSIONS LESS THAN THOSE SHOWN MAY COMPROMISE THE CORRECT CIRCULATION OF AIR AROUND THE DEVICE AND MAY NOT PROVIDE ADEQUATE COOLING, WITH THE CONSEQUENT DETERIORATION OF PERFORMANCE AND/OR POSSIBLE DAMAGE.

NOTE

IF THE MAIN SWITCH IS INACCESSIBLE WHEN INSTALLED IN THE COMPARTMENT, USE AN ELECTRIC PLUG THAT INCORPORATES AN ON/OFF SWITCH. DO NOT REMOVE THE UPPER COVER OR ANY OTHER EXTERNAL PART. WHEN INSTALLED IN THE COMPARTMENT, THE DEVICE MUST BE COMPLETE WITH ALL ITS PARTS. PLEASE REFER TO APPENDIX A (TECHNICAL CHARACTERISTICS) FOR COMPLETE TECHNICAL DATA.

**GENERAL
INSTALLATION
PRECAUTIONS**

Obey the following warnings for the correct operation of the device and/or to avoid **risky situations**:

- Install the sterilizer on a **flat surface**; adjust the rear leveling feet to compensate for an irregular surface as necessary, and to lower tilt slightly the front side of the machine. Make sure that the support surface is **strong enough** to support the weight of the fully equipped and loaded device (about 60 kg);
- Leave **adequate space for ventilation (at least 10 cm on each side) all around the sterilizer, especially in back.** **If the device is built-in to a cabinet, be sure to respect the warnings in the preceding paragraph, avoiding an obstructions to the air intake;**
- Do not install the sterilizer near tubs, sinks or similar places, to **avoid contact with water or liquids.** This could cause short circuits and/or potentially dangerous situations for the operator;
- Do not install the sterilizer in a place that is **excessively humid** or **poorly ventilated**;
- Do not install the machine where there is **gas** or inflammable and/or explosive **vapors**;
- Install the device so that the power cord is **not bent** or **crushed**. It must run freely all the way to the socket.
- Install the device that any external pipe is **not bent** or **crushed**.

**ELECTRICAL
CONNECTIONS**

The sterilizer's must be connected to a socket of the electrical system of adequate capacity for the device's absorption and ground provided, in conformity with current laws and/or standards. The socket must be suitably protected by a breaker having the following characteristics:

- Nominal current I_n **16 A**
- Differential current $I_{\Delta n}$ **0.03 A**

WARNING



THE MANUFACTURER WILL NOT BE LIABLE FOR DAMAGES CAUSED BY INSTALLING THE STERILIZER ON AN INADEQUATE ELECTRICAL SYSTEM AND/OR NOT EQUIPPED WITH A GROUND.

If it is necessary to replace the plug on the power cord, use one with equal characteristics or, at any rate, adequate to the device's electrical characteristics. The user is entirely responsible for the selection and replacement of the plug.

NOTE



ALWAYS CONNECT THE POWER CORD DIRECTLY TO THE SOCKET.
Do NOT USE EXTENSION CORDS, ADAPTERS OR OTHER ACCESSORIES.

**CONNECTING THE
DATA RECORDING
MILLFLASH**

The sterilizer can be connected to MILLFLASH allowing the recording of the cycle data in .txt format file and its management by PC.

The connectors of the service box are used for interfacing; refer to MILLFLASH Operating Manual for the installation instructions.

CONNECTING AN EXTERNAL WATER FILLING TANK

(OPTIONAL, automatic filling function)

To avoid having to periodically fill the water tank (see **Chapter 5, “First Start-Up”**), it is possible, where this feature is provided, to connect the sterilizer to an external filling tank (supplied as an option), that the user will periodically fill, or to a commercially-available, reverse-osmosis water purification system with accumulation tank.

In that case, when the internal water tank reaches the MIN level, the autoclave activates a pump that automatically fills the internal tank.

Follow the instructions below for the correct connection of the external tank:

- Install the tap provided on the filling tank; use Teflon tape or connector sealant for a perfect seal.

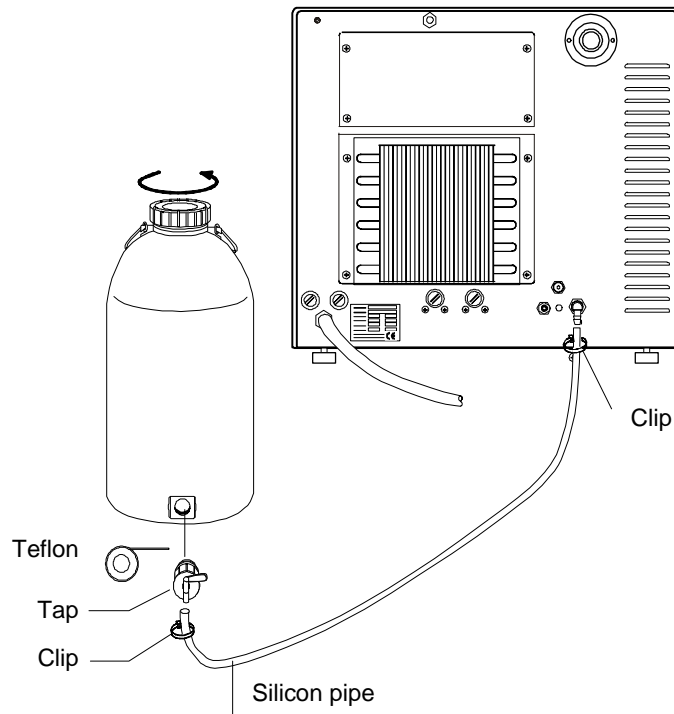

- Use the filling tanks silicone tube (or other suitable tube, length 2m) and insert it on the filling connector taking care to push it completely on.
- Lock the tube to connector with the plastic tie provided.
- Insert the other end of the tube on the tap of the filling tank.
- Make sure that the tube runs freely from the device to the filling tank, without being bent, crushed or obstructed in any way.
- Loosen the upper plug to facilitate the flow of water (also remove any gasket or under-plug);
- Open the tap on the filling tank.

NOTE

REFER TO THE CHAPTER, “CONFIGURING THE DEVICE – AUTOMATIC FILLING OPTION”.

CONNECTING THE MILLDROP

(OPTIONAL, automatic filling function)

If provided, this feature allows the sterilizer to be connected to MILLDROP (water treatment system by reverse osmosis) warranting the automatic reservoir filling with high quality demineralized water. Refer to MILLDROP operating manual for the installation instructions.

NOTE

REFER TO THE CHAPTER, “CONFIGURING THE DEVICE – AUTOMATIC FILLING OPTION”.

For additional information and advice about the correct connection of the sterilizer to the various water purification systems, contact M.O.COM. customer support (see **Appendix Z**).

DIRECT CONNECTION TO A CENTRALIZED DRAINING POINT

To avoid having to periodically empty the internal used water tank, it is possible to connect it directly to a central drain.

- Insert the silicone tube (provided) or other suitable plastic tube on hose union A; push the tube all the way on and lock with the plastic tie or other means;
- Cut the tube to measure, push the free end on the connection provided on the centralized draining point and lock with the plastic tie or other means;

NOTE

MAKE SURE THE TUBE IS NOT BENT, CRUSHED OR OBSTRUCTED IN ANY WAY.

The following diagram provides an indicative arrangement of the components:

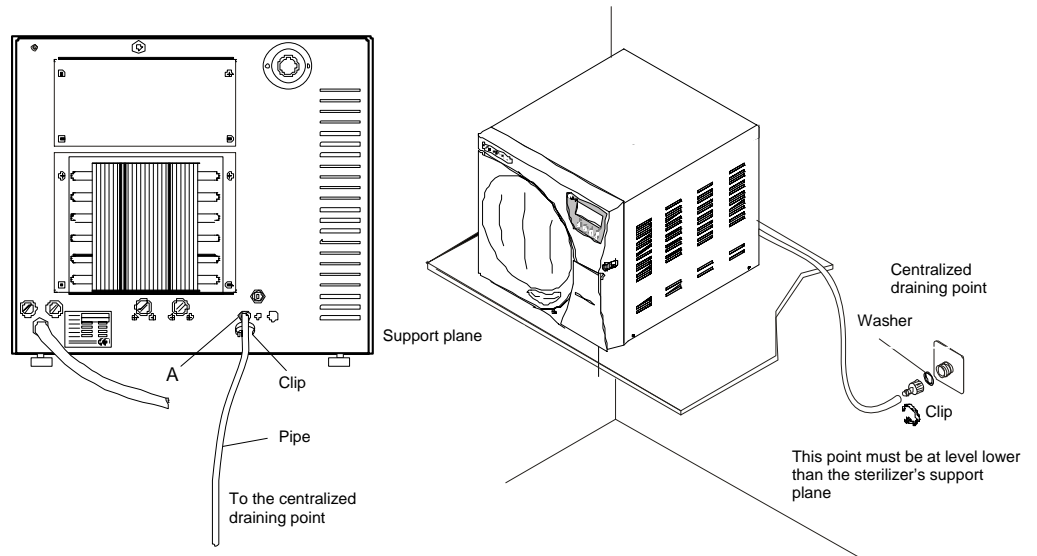

NOTE

THE CONNECTION POINT TO THE CENTRAL DRAIN MUST BE LOWER THAN THE STERILIZER'S SUPPORT SURFACE. OTHERWISE, THE TANK MAY NOT EMPTY CORRECTLY.

FIRST START-UP

Once the sterilizer has been correctly installed, it may be turned on and prepared for use.

TURNING ON THE EQUIPMENT

Turn on the equipment by the main (luminous) switch located on the right side of the machine.

NOTE

DO THIS WITH THE STERILIZER'S DOOR OPEN.

INITIAL AUTOMATIC TEST

When turned on, the control panel lights up and beeps so you can visually check its correct operation. The panel then displays this message:

M I L L E N N I U M S
R . E x x x x / B H y y y y y

D E V I C E C H E C K - U P

NOTE

IF THE DOOR IS CLOSED, THE TEST IS INTERRUPTED. THE PANEL THEN BEEPS AND DISPLAYS THE FOLLOWING MESSAGE.

O P E N D O O R
T O C O N T I N U E

Open the door to allow the test to continue. At the end of the test you will see:

M I L L E N N I U M S
R . E x x x x / B H y y y y y

C H E C K - U P C O M P L E T E

ACQUISITION AND UPDATING OF THE AMBIENT PRESSURE VALUES

The sterilizer measures the ambient pressure for the correct operation of several auxiliary devices. Whenever the difference between the value read and that previously stored (see the Chapter, “**Configuring the Device - Acquisition the ambient pressure**”) is **higher** than a set value, the system **automatically** updates the stored value after a brief delay. Otherwise, the data remains unchanged without updating.

After updating, the device performs the initial automatic test procedure (see the preceding paragraph). At the end, the display shows the following **notice** (accompanied by a beep):

A M B I E N T P R E S S U R E
V A L U E U P D A T E D
- 0 . 0 1 b a r

↵ t o c o n t i n u e

When ↵ is pressed, the device goes to STAND-BY mode (see the following paragraph).

STAND-BY MODE

After the initial test, the sterilizer goes to **STAND-BY** mode and the display shows:

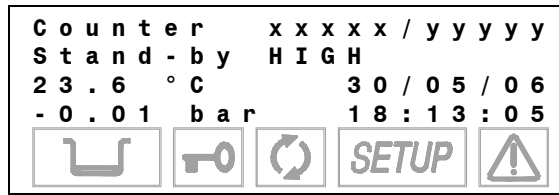

The upper line is the **cycle counter** for sterilizations performed, with the number of correctly completed cycles on the **left** and the total number started on the **right**. The line below shows the Stand-by status and the preheating mode (High-Low-Off). The two lower lines show the temperature and pressure of the sterilization chamber on the left and current **date** and **time** on the right.

NOTE

A CYCLE BEGINS WITH THE START OF THE STERILIZATION CYCLE (FIRST VACUUM PHASE), EXCLUDING THE PREHEATING PHASE. A CYCLE ENDS AT THE END OF THE PROGRAM (SEE THE CHAPTER, "PROGRAM EXECUTION").

TO SET THE DATE AND TIME AS WELL AS THE PREHEATING MODE AND DATA PRINTOUT, PLEASE REFER TO THE CHAPTER, "CONFIGURATION".

At regular intervals, the first two lines on the display alternate with the modes set for printing (OFF/ON) and filling (Manual):

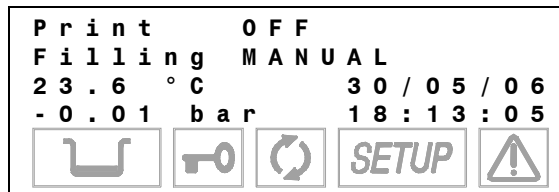

The icons in the lower part of the LCD screen remain off with the exception of the door status and/or water level indicators, which light-up if the door is closed and/or the level in the filling tank reaches its MIN or MAX values (or the MAX value in the drain tank).

During the first start-up, the MIN water level icon in the filing tank is normally on.

The device waits for the selection of the desired sterilization program (see the Chapter, "**Program Selection**").

DANGER

WHEN THE DOOR IS OPEN IN STAND-BY MODE, A 30-SECONDS BEEP INDICATES THAT THE SURFACES INSIDE THE DEVICE ARE HOT. TO AVOID BURNS, TAKE CARE NOT TO TOUCH THE STERILIZATION CHAMBER, THE SUPPORTS PROVIDED OR THE INSIDE OF THE DOOR WITH YOUR BARE HANDS.

FILLING DISTILLED WATER

Manual filling

The first time the sterilizer is used, and later when the MIN water level indicator comes on, you will have to fill, or top-off, the internal distilled water tank.

With reference to the figure (and with the door open), proceed as follows:

1. Fill the manual container (2 l) with distilled water, keeping it horizontal;
2. Connect the tube's quick connector to the corresponding female connector under the chamber entrance (marked ) , pushing until you hear a click;
3. Place the container in a vertical position, at the same time, loosening the plug and taking care not to spill water on the machine.
4. The water will begin to flow into the tank;
5. Continue filling until the MIN level indicator turns off.
6. Continue until the water is drained from the container;
7. At this point, lower the connector below the connection point, keeping it horizontal;
8. While pinching the tube with your fingers, press the metal lever located on the side of the connector and detach the quick connector;
9. Refill the container (2 l) and repeat the operations described in points 2, 3 and 4 a second time;
10. When the MAX level icon comes on (accompanied by a beep), stop filling and detach the quick connector as described in points 7 and 8.

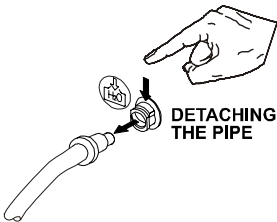
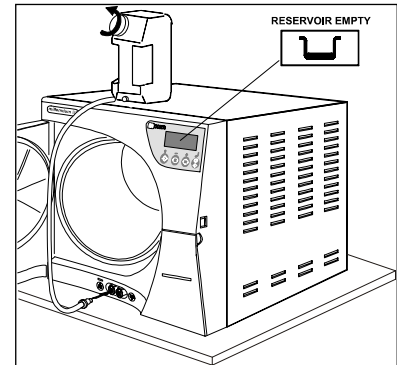

NOTE

 **THE ICON MAX DOES NOT HAVE TO BE ON IN ORDER TO START A STERILIZATION PROGRAM. THE ICON MIN INDICATOR OFF IS SUFFICIENT.**

Automatic filling (option)

In the event of installation for automatic filling from an external tank or demineralizer Milldrop (see the Chapter, "**Installation**"), the filling will occur automatically after the automatic filling option has been selected. Obviously, for the correct operation, the user must fill the external tank or switch on the Milldrop in advance.

NOTE

 **USE ONLY HIGH QUALITY DISTILLED WATER. FOR THE SPECIFICATIONS OF THE WATER SUPPLY, SEE APPENDIX A (TECHNICAL CHARACTERISTICS).**

To set the automatic filling option, please refer to the Chapter, "**Configuring the Device**".

WARNING

 **THE AUTOMATICALLY FILLING SYSTEM MUST NEVER RUN DRY; THIS CAUSES PREMATURE WEAR TO THE AUXILIARY WATER-INJECTION PUMP. PERIODICALLY CHECK THE WATER LEVEL IN THE EXTERNAL TANK.**

MAX LEVEL OF USED WATER

When the water level in the used water tank reaches the MAX level, the LCD display alternatively lights the MAX and MIN icons.

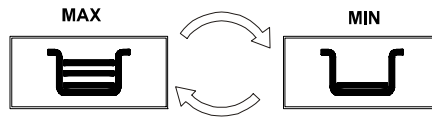

NOTE

IN THIS CONDITION THE UNIT WILL GENERATE AN ALARM INDICATION (SEE APPENDIX E - ALARM) AS YOU ATTEMPT TO LAUNCH A STERILIZATION CYCLE.

Emptying the internal used water tank

Empty the internal used water tank.

Open the door and operate in the following way:

1. Arrange an empty tank on the floor near the sterilizer and put the free end of the supplied tube into the tank;
2. Connect the quick connector to the corresponding female connector under the chamber entrance (marked), pushing until you hear a click;
3. Wait for the complete empty of the internal tank; then while pinching the tube with your fingers, press the metal lever located on the side of the connector and detach the quick connector.

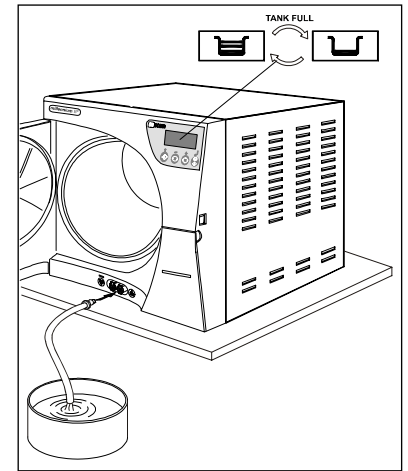
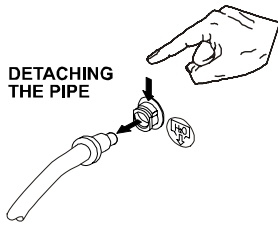

CONFIGURATION

INTRODUCTION

Millennium S offers personalization options never previously seen on any steam sterilizer. Users may configure the device to meet their own needs. For example, the device's performance may be adapted on the basis of the type of activity, the type of material to be sterilized or its frequency of use.

The **SETUP** program allows selecting from numerous options that users activate through an intuitive, easy-to-use menu.

NOTE



USE THE SETUP PROGRAM WHENEVER NECESSARY. A CORRECTLY PERSONALIZED DEVICE PROVIDES THE BEST PERFORMANCE AND THE MOST SATISFACTORY USE. M.O.COM. CUSTOMER SUPPORT (SEE APPENDIX Z) IS AVAILABLE TO HELP USERS BY PROVIDING SUGGESTIONS OR ADVICE ON THE BEST WAY TO USES THE OPTIONS IN THE SETUP PROGRAM

STARTING AND ENTERING THE SETUP MODE

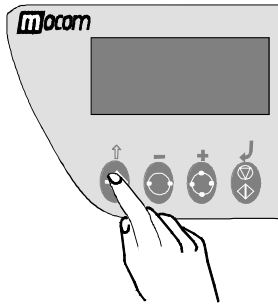

To start the **SETUP** program, hold down the \uparrow key on the control panel for several seconds, until the display shows:

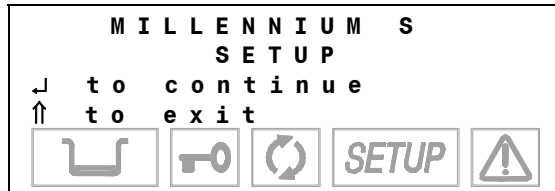

NOTE



ICON **SETUP ON THE DISPLAY LIGHTS-UP AND STAYS ON OR THE ENTIRE CONFIGURATION PHASE.**

When you press the \downarrow key, you enter the **SETUP** mode. The screen shows the first-level menu items (see the paragraph, **SETUP flowchart**).

Pressing the **ESC** key \uparrow quits the **SETUP** program and takes you back to normal operation (stand-by mode).

NOTE



THE SETUP PROGRAM CAN ONLY BE STARTED IN STAND-BY MODE. IT IS NOT ACCESSIBLE DURING STERILIZATION OR TEST CYCLES.

MEANING OF THE KEYS IN SETUP MODE

In **SETUP** mode the control panel keys have different functions than in normal mode.

Key	SETUP mode
\downarrow	function ENTER , confirm the selected option or value
+	Increase the value /scroll down
-	Decrease the value /scroll up the menu items
\uparrow	ESC , exit the selected menu option

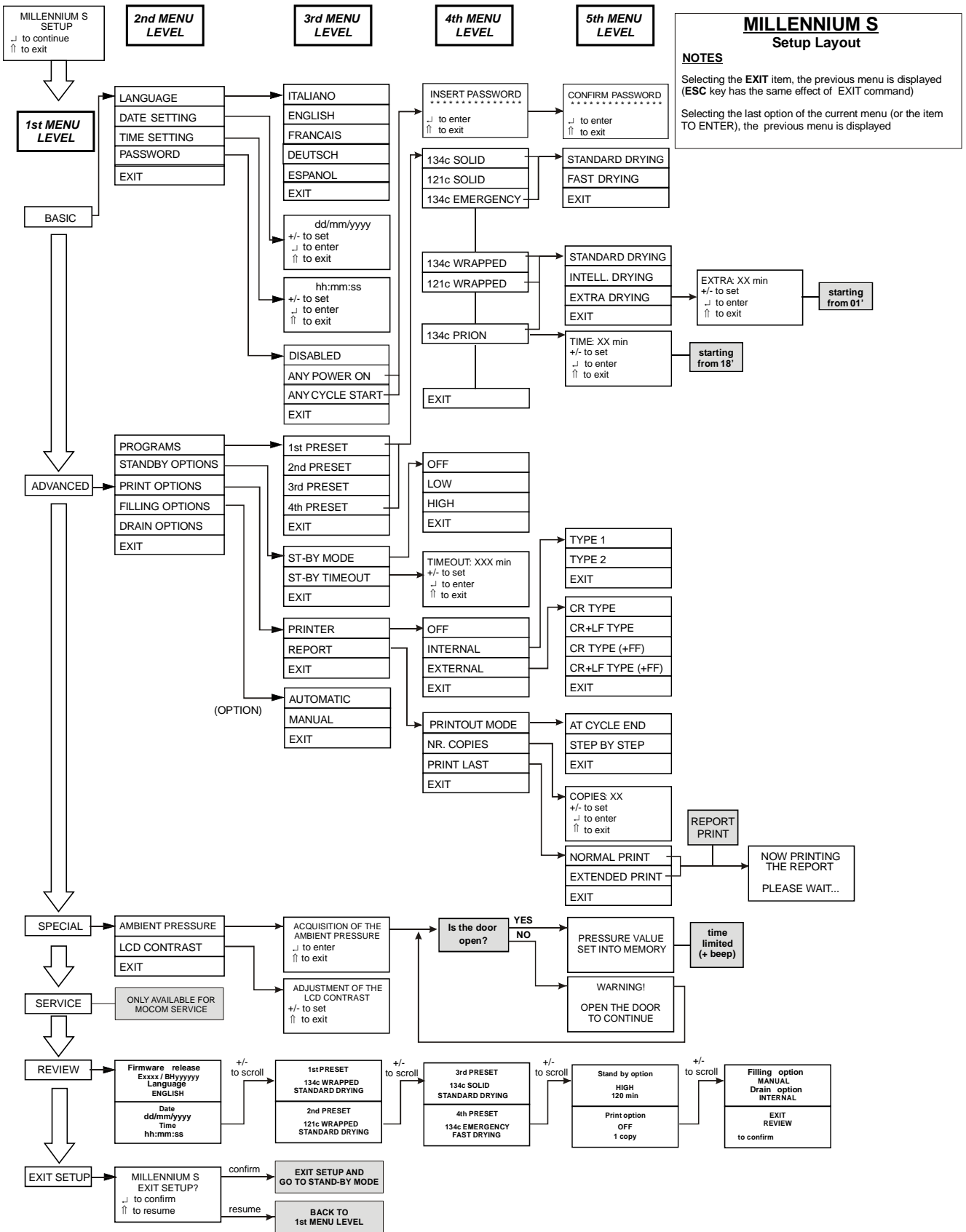

DESCRIPTION OF THE MENU ITEMS

Now, we describe the meaning of the various main menu and second-level menu items.

MAIN MENU

The main menu has 6 entries that open additional (second-level) menus:

BASIC	(basic options)
ADVANCED	(advanced options)
SPECIAL	(special options)
SERVICE	(menu not accessible to users)
DATA REVIEW	(summary of options selected)
EXIT SETUP	(exit the SETUP program and return to normal operation. <i>In this regard, see the paragraph, Exiting the SETUP program</i>)

NOTE	
	THE METHODS FOR CHANGING THE VARIOUS ITEM SETTINGS ARE FOUND IN THE PARAGRAPH, ACTIVATING CONFIGURATION OPTIONS.

BASIC Menu

The Basic menu (basic options) consists of the items:

LANGUAGE	(language setting)
DATE SETTING	(setting the current date);
TIME SETTING	(setting the current time)
PASSWORD	(setting the password)
EXIT	(exit the BASIC menu and return to the main menu)

ADVANCED Menu

The Advanced menu (advanced options) consists of the items:

PROGRAMMES	(setting preselected sterilization programs , shown on the LCD display)
STAND-BY OPTIONS	(stand-by mode settings)
PRINT OPTIONS	(setting printer and printing options)
FILLING OPTIONS	(available on request)
DRAIN OPTIONS	(not available)
EXIT	(exit the ADVANCED menu and return to the main menu)

SPECIAL Menu

The Special menu (special options) consists of the following items:

AMBIENT PRESSURE	(acquisition of the ambient pressure)
LCD CONTRAST	(adjusting the contrast of the Liquid Crystal Display)
EXIT	(exit the SPECIAL menu and return to the main menu)

SERVICE Menu

The Service menu can **ONLY** be accessed by the Service department.

DATA REVIEW Menu

The Data Review displays a summary of the device's **current settings**, allowing users to verify their correctness.

It has the following screens (shown by way of example):

```

MILLENNIUM S
R . E x x x x / B H y y y y y
    L A N G U A G E
    E N G L I S H
  
```

Firmware version

```

DATE
d d / m m / y y y y
TIME
h h : m m : s s
  
```

Use the keys + / - to scroll through the menu

```

1 s t P R E S E T
1 3 4 ° C W R A P P E D
S T A N D A R D D R Y I N G
  
```

```

2 n d P R E S E T
1 2 1 ° C W R A P P E D
S T A N D A R D D R Y I N G
  
```

Use the keys + / - to scroll through the menu

```

3 r d P R E S E T
1 3 4 ° C S O L I D
S T A N D A R D D R Y I N G
  
```

```

4 t h P R E S E T
1 3 4 ° C E M E R G E N C Y
F A S T D R Y I N G
  
```

Use the keys + / - to scroll through the menu

```

S t a n d - b y o p t i o n
H I G H
1 2 0 m i n
  
```

```

P r i n t o p t i o n
O F F
1 C O P Y ( i e s )
  
```

Use the keys + / - to scroll through the menu

```

F i l l i n g o p t i o n
M A N U A L
D r a i n o p t i o n
I N T E R N A L
  
```

Use the keys + / - to scroll through the menu

```

E X I T
D A T A R E V I E W
↓ t o c o n t i n u e
  
```

Press ↓ to confirm

NOTE

FOR THE MEANING OF THE TERMS SHOWN, SEE THE PARAGRAPH, ACTIVATING CONFIGURATION OPTIONS.

**DEFAULTS
SETTINGS**

The sterilizer leaves the factory with the following settings:

DATE: *current date*
TIME: *current time*

PROGRAMS: Preset 1: **134°C WRAPPED** (*standard* drying)
 Preset 2: **121°C WRAPPED** (*standard* drying)
 Preset 3: **134°C SOLID** (*standard* drying)
 Preset 4: **134°C EMERGENCY**

NOTE

THE PROGRAMS INDICATED SHOULD BE CONSIDERED AS PREFERENTIAL SETTINGS. HOWEVER, OTHER COMBINATIONS ARE POSSIBLE BASED ON THE DESTINATION MARKET.

ST-BY MODE: *HIGH* (preheating)
PRINT OPTIONS: *OFF*
1 copy
FILLING OPTIONS: *MANUAL*
DRAIN OPTIONS: *INTERNAL*

**ACTIVATING
CONFIGURATION
OPTIONS**

Setting the language
 (LANGUAGE on the BASIC Menu)

Now, we provide a detailed explanation of how to select the various available options, proceeding in the shown in the previous paragraph.

Select **LANGUAGE** using the ↵ key. The following screen will appear:

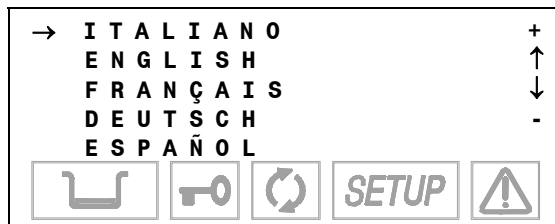

Select the desired language. Move using the + or – keys and confirm using the ↵ key to store the selection. After the data is confirmed, you return to the second-level menu.

NOTE

AS SOON AS THE SELECTION IS CONFIRMED, ALL THE MENUS OF THE **SETUP** PROGRAM WILL BE DISPLAYED IN THE LANGUAGE SET.

Setting the date
 (DATE SETTING on the BASIC Menu)

When **DATE SETTING** is selected with the ↵ key, you will see:

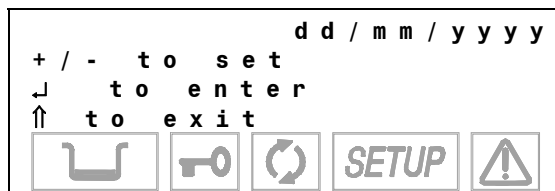

Proceed as follows:

- The day **flashes**: set the current date with the + and - keys. Confirm with ↵.
- The month **flashes**: set the current month with the + and - keys. Confirm with ↵.
- The year **flashes**: set the current year with the + and - keys. Confirm with ↵.

The date is stored. Once the last confirmation is given, you return to the second-level menu.

Setting the time
(TIME SETTING on the BASIC menu)

When **TIME SETTING** is selected with the ↓ key, you will see:

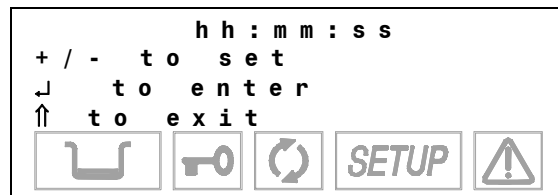

Proceed as follows:

- The hours **flash**: set the current hour with the + and - keys. Confirm with ↓.
- The minutes **flash**: set the current value with the + and - keys. Confirm with ↓.

The time is stored. Once the last confirmation is given, you return to the second-level menu.

Setting the password
(PASSWORD on the BASIC menu)

When **PASSWORD** is selected with the ↓ key, you will see this menu:

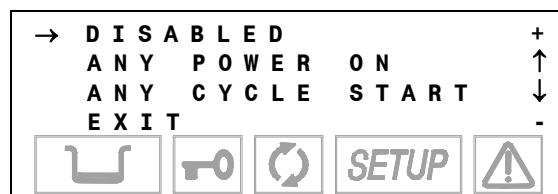

Select **DISABLED** to use the device freely, without any limitation on operator access.

Select **ANY POWER-ON** to protect the machine with a password at the time it is turned-on (power-on from the main switch).

This makes sure that the machine can only be powered-on by authorized personnel, but afterwards it can be used by others without limitation.

Select **ANY CYCLE START** to protect the autoclave with a password to be entered both at power-on and at the start of every sterilization program.

Only authorized personnel will be able to use it.

NOTE

ENTERING A PASSWORD PROVIDES MORE CONTROLLED USE OF THE PRODUCT BUT, AT THE SAME TIME, INEVITABLY MAKES IT MORE CUMBERSOME. So AS NOT TO OVERLY COMPLICATE USING THE DEVICE, WE RECOMMEND ONLY ACTIVATING THIS OPTION WHEN IT IS REALLY NEEDED.

When the **ANY POWER-ON** or **ANY CYCLE START** options are selected, the following screen is displayed:

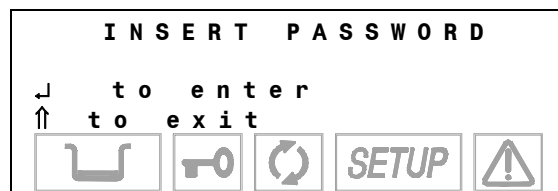

Enter the password with the + and – keys (fixed length, **8 characters**). Confirm with the ↓ key. Then, the following message will appear:

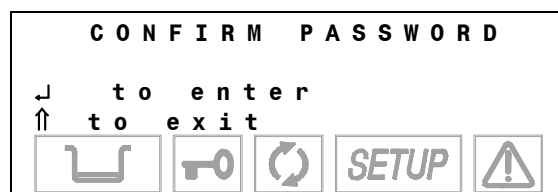

Enter the password again using the + and – keys. Confirm with the ↓ key.

NOTE

TO CHANGE THE PASSWORD, FIRST SELECT THE DISABLE OPTION, WHICH CANCELS THE PREVIOUS PASSWORD, AND THEN SELECT THE ANY POWER-ON OR ANY CYCLE START OPTION, ENTERING THE NEW PASSWORD AS DESCRIBED ABOVE.

Setting the sterilization programs
(PROGRAMS on the ADVANCED menu)

The program setting and their storing on four pre-set positions is achieved in various steps using several menus in sequence.

To associate **a cycle** and define several of its parameters, proceed as follows:

1. Select **PROGRAMS** using the \downarrow key; the following menu appears:

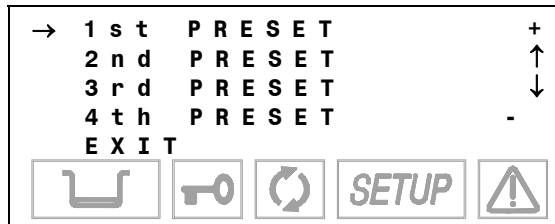

Define the position (1, 2, 3 or 4) to which the sterilization program will be associated using the + and - keys. Confirm with the \downarrow key.

2. From here, you enter the list of available cycles:

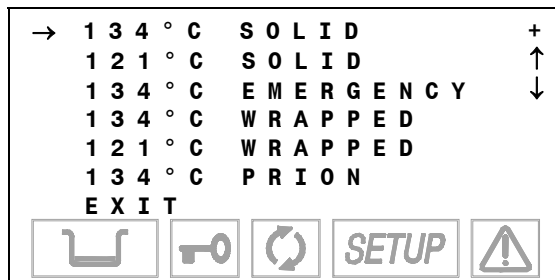

Using the + and - keys, scroll the list until you identify the sterilization program desired.

3. Confirm the selection with the \downarrow key.

When the **PRION** program is selected, you will go to a screen for selecting the sterilization time.

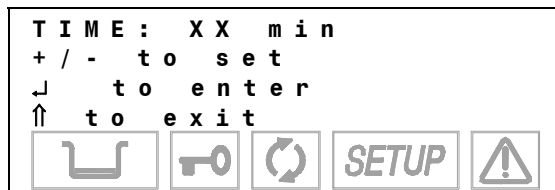

A value can be set, starting from **18** to **30** minutes.

As a function of the choices made, you will go to one of two alternative menus that allow selecting the type of drying to associate to the selected program.

a) Programs with short drying (SOLID, EMERGENCY):

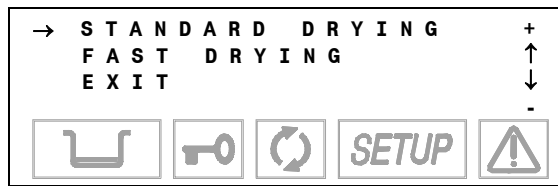

It is possible to select **STANDARD** mode (the default setting) or **FAST** (reduced drying, recommended for light loads). Move using the + and - keys and confirm with the ↵ key.

NOTE

THE EMERGENCY PROGRAM PROVIDES ONLY FAST DRYING.

b) Programs with long drying (WRAPPED, PRION):

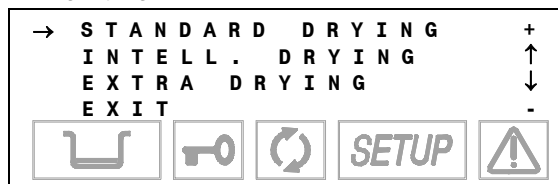

It is possible to select **STANDARD** (default setting), **INTELLIGENT** (automatic drying that adjusts its duration longer or shorter than standard drying on the basis of the volume and/or quantity and type of load) or **EXTRA** (drying extended by a selectable value, recommended for critical loads). Move using the + and - keys and confirm with the ↵ key.

NOTE

WITH LARGE LOADS OR SPECIAL MATERIALS, THE STANDARD OPTION MAY NOT PROVIDE A PERFECT RESULT. IN THIS CASE, EXTEND THE DRYING PHASE BY USING THE EXTRA MODE.

When the **EXTRA** option is activated, the following screen appears:

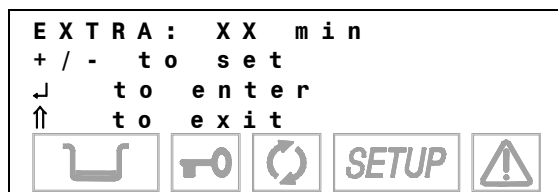

which permits setting the duration of extra drying from between **1** and **15** minutes (time to be added to the STANDARD DRYING time). Set the value and confirm the selection with the ↵ key.

NOTE

THE SELECTION CAN BE CHANGED AT ANY TIME BY FOLLOWING THE PROCEDURE DESCRIBED ABOVE. WHENEVER AN IDENTICAL STERILIZATION PROGRAM IS ALREADY PRESENT IN ANOTHER POSITION, THE SELECTION IS NOT ACCEPTED. THE FOLLOWING WARNING APPEARS ON THE DISPLAY, ALONG WITH A BEEP:



NOTE

THE LIST OF AVAILABLE PROGRAMS, THEIR SCREENS AND THE CHARACTERISTICS OF STERILIZABLE MATERIALS (IN RELATION TO THE PROGRAMS) ARE CONTAINED IN APPENDIX B (PROGRAMS).

Setting the STAND-BY mode

(STAND-BY OPTIONS on the ADVANCED menu)

Based on the equipment's frequency of use, or other considerations, it is possible to select the heating level during the STAND-BY (preheating) phase and the time beyond which STAND-BY is deactivated.

When you select **STAND-BY OPTIONS** with the ↵ key, you access the following menu:

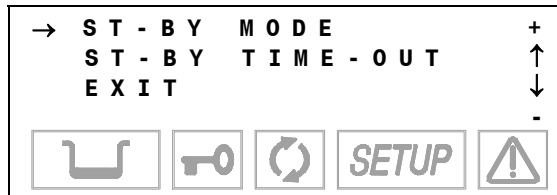

When you select **STAND-BY MODE**, an additional menu appears where you can set the heating level:

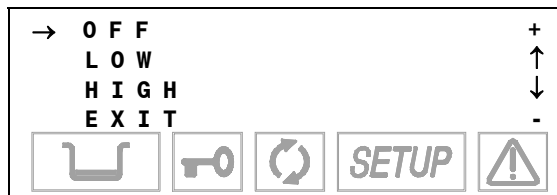

Select **HIGH** (high preheating level) for intense use or, at any rate, to reduce the wait time between one cycle and the next to a minimum.

Select **LOW** (low preheating) for normal use, since the wait time will be relatively shorter, in any case.

Select **OFF** (deactivate preheating) for occasional use. In this case, the wait time will be longer (up to about 10-12 minutes for a "cold start").

Move using the + and - keys; confirm with the ↵ key.

On the other hand, when the **ST-BY TIME-OUT** option is selected, it is possible to set the time for deactivating STAND-BY, i.e., how many minutes after the last cycle the heating elements are turned off.

The following screen appears:

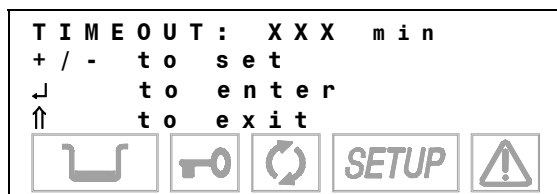

It is possible to set a value between **0** and **300** minutes (in 30-minute increments), after which the heating elements are turned off (a condition analogous to STAND-BY OFF), avoiding the useless consumption of electricity.

Set using the + and - keys; confirm with the ↵ key.

NOTE

THIS OPTION IS ALSO ACTIVE WITH STAND-BY OFF. HOWEVER, IN THIS CONDITION THE TIMER VALUE OBVIOUSLY HAS NO EFFECT SINCE THE HEATING ELEMENTS ARE TURNED OFF ANYWAY AT THE END OF THE STERILIZATION PROGRAM.

WHEN ANY CYCLE SELECTION KEY (STERILIZATION OR TEST) IS PRESSED, OR THE MACHINE IS TURNED OFF AND ON WITH THE MAIN SWITCH, THE ORIGINAL STAND-BY MODE (HIGH OR LOW) IS IMMEDIATELY REACTIVATED.

Setting the printing mode
(PRINT OPTIONS on the ADVANCED menu)

When the sterilizer is equipped with a printer (option) for recording sterilization program data, it is necessary to set the parameters required for its proper operation.

1. Select **PRINT OPTIONS** using the ↓ key and the following menu appears:



Select **PRINTER** to select the settings for the printer used, or **REPORT** to set the number of copies to print and to reprint data from the last program executed.

- a) Item **PRINTER**

The following screen appears:



Select **OFF** to deactivate the printing of data at the end of a sterilization (or test) cycle.

Select **INTERNAL** to enable the thermal printer set (option) inside the front of the sterilizer. In this case, another menu opens:

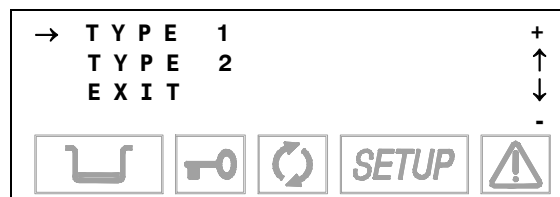

Select Type 1 for the model 1 of the printer installed.
Select Type 2 for the model 2 of the printer installed.

Printer model 1

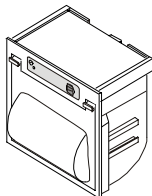

Printer model 2

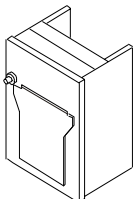

If, on the other hand, you choose **EXTERNAL**, the data will be printed on an external peripheral. Following this selection, another menu opens:

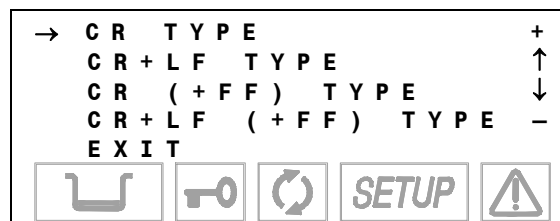

Activate **CR** to use printers that advance the paper only on the CR (*Carriage Return*) command, or **CR+LF** for that require the CR+LF (*Carriage Return + Line Feed*) commands, or with **+FF** (*Form-Feed*) for printers that require the addition of this command.

NOTE

CONSULT THE PRINTER MANUAL TO DETERMINE THE TYPE OF COMMAND USED. IF THIS INFORMATION IS NOT AVAILABLE, TRY PRINTING WITH THE VARIOUS OPTIONS TO IDENTIFY THE CORRECT SETTING.

b) Item **REPORT**

The following screen appears:

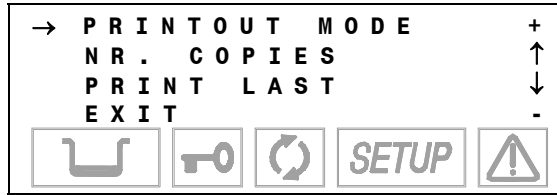

Select item **PRINTOUT MODE** to chose the mode the data are printed: The following options appear:

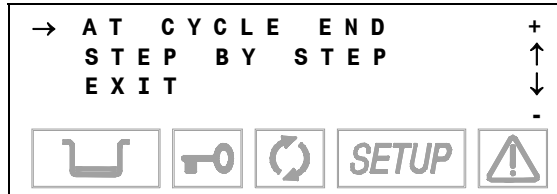

Select **AT CYCLE END** to print the report al the end of the cycle.
 Select **STEP BY STEP** to print the data at each phase of the cycle, as result in the normal printout (see Examples of printed report in Appendix B).

NOTE

IN STEP BY STEP MODE IS NOT POSSIBLE MORE REPORT COPIES.

THE VACUUM TEST REPORT PRINT IS CARRIED OUT ONLY IN MODE "AT CYCLE END".

Activate **NR. COPIES** to set the number of copies of the cycle report to print at the end of the program. The following text appears:

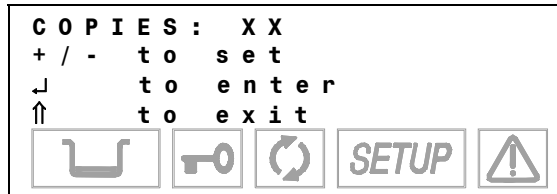

Set the number of copies desired (up to a maximum of 5). Confirm with the ↓ key.

On the other hand, the selection **PRINT LAST** reprints the report for the last cycle executed (whether it terminated correctly or was interrupted by an alarm). The following screen appears:

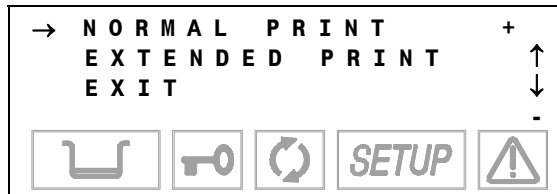

The **NORMAL PRINT** command activates normal printing (that with salient cycle data produced at the end of a correctly executed cycle), while **EXTENDED PRINT** activates complete printing (including all the data typical of a cycle interrupted by an alarm).





NOTE

 IF THE LAST CYCLE COMPLETED CORRECTLY (OR WAS INTERRUPTED BY **MANUAL STOP**) IT WILL BE POSSIBLE TO REPRINT IT IN EITHER **NORMAL** OR **EXTENDED MODE**.
IF THE LAST CYCLE WAS INTERRUPTED BY AN ALARM (**MANUAL STOP** EXCLUDED) IT ONLY THE **EXTENDED** MODE WILL BE AVAILABLE.

Following the reprint command, this message will be displayed:

NOW PRINTING
THE REPORT

PLEASE WAIT . . .

which will remain on the screen until printing is finished.

Setting the tank filling mode
(FILLING OPTIONS on the ADVANCED menu)

The internal tank can be filled either manually or automatically (option), in the latter case, drawing water from an external device (tank or demineralizer Milldrop connected to the device (see **Chapter "Installation"**).
After **FILL OPTIONS** is selected, the following menu appears:

→ AUTOMAT. FILLING +
MANUAL FILLING ↑
EXIT ↓
-







When **AUTOMATIC FILL** is selected, automatic filling is activated.
In this case, as reached the minimum water level (icon MIN on) in the internal tank, the equipment enable the auxiliary water feeding pump for a pre-set time or a time needed to reach the maximum level (icon MAX on).
When the maximum level (MAX signal) is reached, the automatic system is deactivated.

NOTE

 ONLY ACTIVATE THE AUTOMATIC FILLING MODE AFTER THE EXTERNAL TANK HAS BEEN FILLED WITH HIGH QUALITY DISTILLED WATER OR THE MILLDROP HAS BEEN TURNED ON. ALSO REMEMBER TO OPEN THE TAP ON THE EXTERNAL TANK OR THE MILLDROP.





When **MANUAL FILL** is selected, the internal tank must be filled manually (see the **Chapter, "First Start-Up"**).
Scroll through the items with the + and - keys; confirm with the ↵ key.

Acquisition of the ambient pressure
(AMBIENT PRESSURE on the SPECIAL menu)

The first time the sterilizer is used and after any reinstallation, the sterilizer must acquire the ambient pressure. This operation is **necessary** or the correct operation of several of the device's auxiliary systems.
When **AMBIENT PRESSURE** is activated, the following screen appears:

ACQUISITION OF THE
AMBIENT PRESSURE

↵ to enter
↑ to exit

NOTE

 CHECK THAT THE STERILIZER DOOR IS COMPLETELY OPEN. IF YOU TRY TO ACQUIRE THE PRESSURE WITH THE DOOR CLOSED THE FOLLOWING MESSAGE WILL BE DISPLAYED:

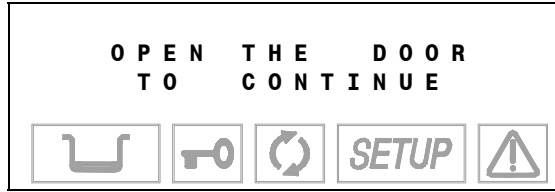

which remains until the door is opened.

Confirm the acquisition of the data by pressing the ↓ key. This message appears:

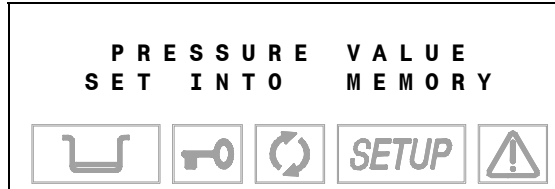

accompanied by a beep. The ambient data pressure has been acquired.

On the other hand, press the ↑ key to cancel the operation.

Adjusting the contrast of the liquid crystal display
(LCD CONTRAST on the SPECIAL menu)

The LCD contrast adjustment allow to obtain the screen reading as clear as possible, compensating different sterilizer positioning or ambient brightness.

When **LCD CONTRAST** is activated, this screen appears:

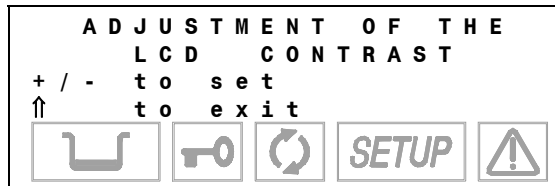

Press the + key increases the contrast while the - key decreases it.

Place yourself in your usual working position and adjust the contrast until the display is as clear and readable as possible.

EXIT THE CONFIGURATION MODE

Completed the sterilizer configuration, proceed as follows to return in normal mode:

- Go to the first-level menu (see the **SETUP layout**).

NOTE

TO RETURN TO THE FIRST LEVEL FROM ANY CURRENT MENU LEVEL, JUST SELECT ITEM EXIT OF THE CURRENT MENU AND CONFIRM BY ↓ KEY. ALTERNATIVELY, YOU CAN PRESS ↑ (ESC) KEY ONE OR MORE TIMES.

- Select **EXIT** and confirm with the ↓ key. This text appears on the display:

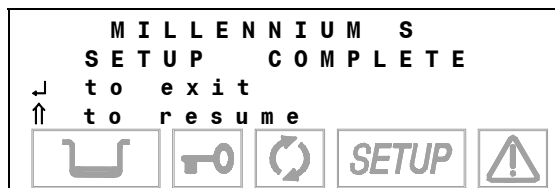

After several seconds, the device returns to **normal operation** in **STAND-BY** mode.

PREPARING THE MATERIAL

INTRODUCTION

The sterilization process can be considered effective, reliable and repeatable so long as the material is suitably treated first and then correctly arranged in the sterilization chamber in an orderly manner.

In fact, it should be emphasized that organic residues or deposits of substances used in medical practice are the inevitable receptacles of microorganisms and may obstruct contact between the steam and the walls of the instrument, deactivating, at least locally, the lethal process that sterilization normally provides.

On the other hand, an incorrect arrangement of the load can make the circulation and/or penetration of the steam into the material difficult and sometimes impossible with the imaginable consequences. Even the drying process can be strongly influenced by this factor. For this reason, below we provide some **basic** suggestions regarding these aspects, leaving the user to study the subject further in the most suitable way.

TREATING THE MATERIAL BEFORE STERILIZATION

First of all, it should be recalled that, when **handling** and **managing** contaminated material, it is a good idea to take the following **precautions**:

- Wear rubber gloves of adequate thickness;
- Clean your gloved hands with a germicide detergent;
- Always carry the instruments on a tray.
- Never carry them in your hands;
- Protect your hands from contact with any sharp points or edges; this will avoid the risk of contracting a dangerous infection;
- Immediately remove any article that does not need to be sterilized or that is not capable of withstanding the process;
- Carefully wash your still gloved hands when done handling non-sterile material.

All materials and/or instruments to be sterilized must be perfectly clean, without any type of residue (deposits of organic/inorganic material, fragments of paper, cotton/gauze pads, lime, etc.).

NOTE

IN ADDITION TO CAUSING PROBLEMS DURING STERILIZATION, THE FAILURE TO CLEAN AND REMOVE RESIDUE CAN DAMAGE THE INSTRUMENTS AND/OR THE STERILIZER, ITSELF.

An effective **cleaning** consists of the following:

1. Rinse the instruments under running water **immediately** after use;
2. Separate metal instruments by type of material (carbon steel, stainless steel, brass, aluminum, chromium, etc.), to avoid electrolytic oxidation-reduction;
3. Wash in an ultrasound cleaner using a mixture of water and germicidal solution, carefully following the manufacturer's recommendations.
4. For best results, use a detergent specifically designed for ultrasound washing, with a neutral pH.

NOTE

SOLUTIONS CONTAINING PHENOLS OR QUATERNARY AMMONIA COMPOUNDS CAN CAUSE CORROSION ON INSTRUMENTS AND THE METAL PARTS OF ULTRASOUND DEVICES.

5. After washing, carefully rinse the instruments and make sure that residues have been **completely eliminated**; if necessary, **repeat** the washing cycle or **clean manually**.

NOTE

TO AVOID THE FORMATION OF LIME SPOTS, RINSE WITH DEIONIZED OR DISTILLED WATER, IF POSSIBLE. **WHENEVER VERY HARD TAP WATER IS USED, WE RECOMMEND ALWAYS DRYING THE INSTRUMENTS.**

WARNING



CONSULT THE INSTRUCTIONS PROVIDED BY THE MANUFACTURER OF THE INSTRUMENT/MATERIAL TO BE STERILIZED BEFORE SUBJECTING IT TO AUTOCLAVE TREATMENT, CHECKING FOR ANY INCOMPATIBILITIES. SCRUPULOUSLY FOLLOW THE METHODS OF USING DETERGENTS OR DISINFECTANTS AND THE USAGE INSTRUCTIONS OF THE AUTOMATIC DEVICES FOR WASHING AND/OR LUBRICATING THEM.

ARRANGING THE LOAD

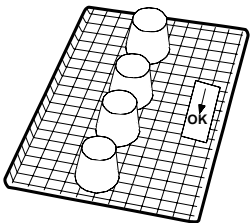
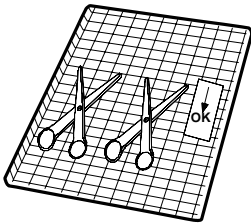

Follow the instructions below for the most efficient sterilization process, preserve the material and increase its useful life.

General notes for positioning on trays.

- Arrange instruments made of different metals (stainless steel, tempered steel, aluminum, etc.) on different trays or well separated from each other.
- In the case of instruments **not** made of stainless steel, place a paper sterilization napkin or a muslin cloth between the tray and the tool, avoiding direct contact between the two different materials;
- In any case, arrange the objects sufficiently distant from each other that they will remain so for the entire sterilization cycle;
- Make sure that all instruments are sterilized in an open position;
- Position cutting instruments, (scissors, scalpels, etc.) so they can **not** come into contact with each other during sterilization; if necessary, use a cotton or gauze cloth to isolate and protect them;
- Arrange recipients (glasses, cups, test tubes, etc.) resting on their side, or upended, so avoid pooling water;
- **Do not** load trays **beyond their indicated limit** (see Appendix A).
- *Since this value is understood to be the maximum allowed limit, it can be excessive in some cases, so always use **common sense**.*
- **Do not** stack trays **or** put them in direct contact with the walls of the sterilization chamber.
- **Always** use the tray support provided.
- To insert and extract trays from the sterilization chamber, **always** use the extractor provided.

NOTE

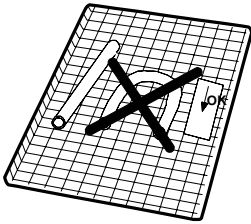

PLACE A CHEMICAL STERILIZATION INDICATOR ON EVERY TRAY TO INDICATE THAT THE PROCESS HAS OCCURRED: THIS AVOIDS USELESSLY REPROCESSING THE SAME LOAD OR, WORSE, USING NON-STERILIZED MATERIAL. IF PROCESSING WRAPPED MATERIAL, PLACE THE INDICATOR INSIDE ONE OF THE WRAPPINGS.

Notes for rubber and plastic tubing

- Always rinse before use with pyrogen-free water; do not dry them;
- Arrange the tubing on the tray so that their ends are not obstructed or crushed.
- Do not bend or wind them, but allow them to lie as straight as possible.

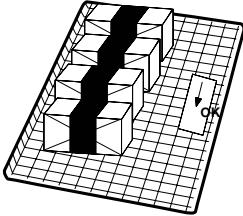
Notes for packets and packages

- Arrange packages side-by-side, suitably spaced and absolutely **not** piled, to avoid their coming in contact with the walls of the chamber.
- Whenever it is necessary to wrap particular objects, always use suitably porous material (sterilization paper, muslin napkins, etc.), closing the wrapping with autoclave adhesive tape.

Notes for wrapped material

- Wrap instruments individually or, when more than one instrument are placed in the same wrapping, make sure that they are made of the same metal;
- Seal the wrapping with adhesive tape for autoclaves or heat-sealing machines.
- Do not use staples, pins or other fasteners since they can compromise the maintenance of sterility;
- Arrange the envelopes so as to avoid forming air pockets that obstruct the correct penetration and removal of the steam.
- **Orient the envelopes so as to leave the plastic side down (tray side) and the paper side up.**
- If possible, place the envelopes edgewise to the tray, with a suitable support.
- **Never superimpose envelopes on top of each other.**

WARNING



WHENEVER YOU ANTICIPATE PROLONGED STORAGE, ALWAYS WRAP THE INSTRUMENTS. SEE THE CHAPTER. "PRESERVING STERILIZED MATERIAL".

NOTE

IF NO STERILIZATION PROGRAM IS SELECTED, THE EQUIPMENT CANNOT START A STERILIZATION CYCLE, AND THE FOLLOWING MESSAGE APPEARS ON THE DISPLAY, WITH A BEEP:

S E L E C T A P R O G R A M
P L E A S E . . .

**WARNING**

IF YOU USE A PROGRAM THAT IS INAPPROPRIATE FOR THE TYPE OF MATERIAL TO BE STERILIZED (SEE APPENDIX B) THE EFFECTIVENESS OF THE STERILIZATION PROCESS IS NOT GUARANTEED.

RUNNING THE CYCLE

INTRODUCTION

A sterilization cycle consists of a determined number of phases. The number and duration of the phases can differ for the programs, based on sterilization process and drying method.

The electronic control system monitors the various phases, at the same time checking that the various parameters are respected; if any type of anomaly is encountered during the cycle, the program is immediately interrupted, generating an alarm identified by a code, with a relative message explaining the nature of the problem.

With this type of control, when you select a suitable sterilization program, you are guaranteed perfect sterilization under any conditions.

STARTING THE CYCLE

After placing the load in the sterilization chamber and selecting the desired program, **close the door until you hear the click.**

The door status icon  **flashes** (door closed). Press the **START** button.

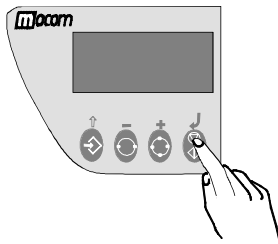





Password check

NOTE

 IF A PASSWORD HAS BEEN ENABLED WITH THE OPTION ANY CYCLE START (SEE THE CHAPTER CONFIGURATION - SETTING THE PASSWORD), YOU WILL BE ASKED TO ENTER THE ACCESS CODE:

I N S E R T P A S S W O R D

↓ t o e n t e r
↑ t o e x i t





Enter the password using the + and – keys. Confirm with the ↓ key.

Printer paper-out check (option)

The equipment checks the presence of the paper into the on-board printer (if installed); if out or ended the following message will be displayed:

W A R N I N G
P A P E R O U T

↓ t o c o n t i n u e
↑ t o e x i t

Push key ↓ to continue however (replace the paper during or at the end of the sterilisation cycle).

Push key ↑ to return in Stand-by mode.

If Millflash is connected

Dependent on the device connected, the equipment checks also the presence of the Compact Flash card. If not plugged in, the display shows:

W A R N I N G
C F C A R D M I S S I N G

↓ t o c o n t i n u e
↑ t o e x i t

    

Plug in the CF card in the recording device and press the key ↓ on the command panel. Push the key ↑ to interrupt the start command and return in Stand-by mode.

In case of card memory full or insufficient to store the new cycle data, the following message will be displayed:

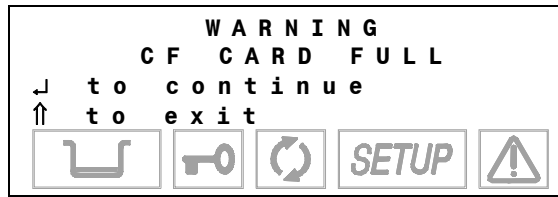

or

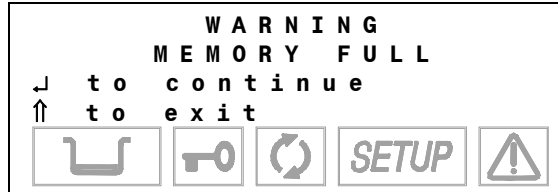

Push key ↓ to continue without recording the cycle data.

Push key ↑ to interrupt the start command; download the files on PC and delete the memory content according to the instructions of the Millflash Operating Manual. Repeat the **Start** command.

Door locking

The equipment locks the door.

The door status icon  remains **steady on** (door locked). When **START** is pushed, and for the entire sterilization cycle, the lower lines of the display will show the following parameters:

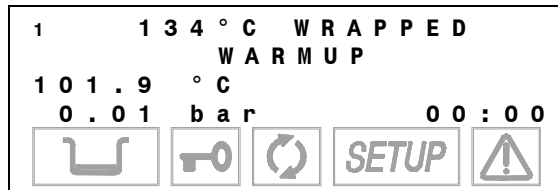
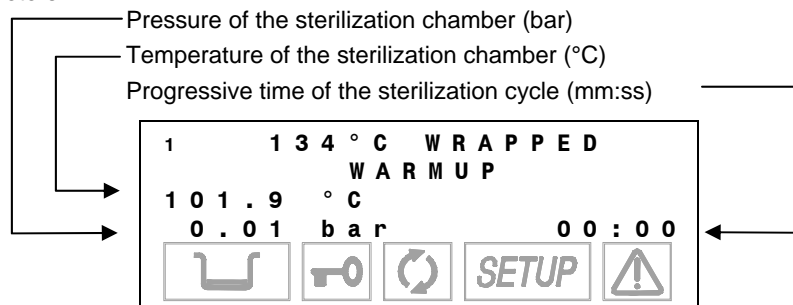

The time is counted from the start of the sterilization cycle (first vacuum phase), excluding the preheating phase.

PROGRAM EXECUTION

Now, we will analyze the execution of a sterilization cycle, phase by phase.

For our example, let's take the most complete and important cycle, i.e., the program **134 °C WRAPPED**.

Preheating

When the **START** button is pressed, the first phase is **PREHEATING**, which brings the chamber to temperature required for starting the cycle. The display shows the following:

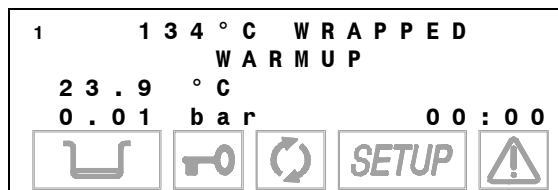

The icon that shows the status of the sterilization process  is off.

Vacuum phase

When the optimum temperature is reached, the vacuum phase (**VACUUM PULSE**) is started and brings the chamber pressure down to the established value. The display shows:

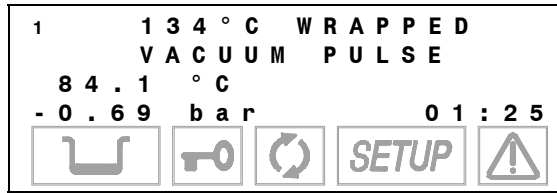

Rise in pressure

When the pre-set vacuum value is reached, steam is injected and the pressure begins to rise, until the established value is reached.

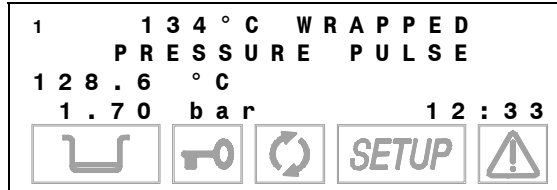

Thermodynamic equilibrium

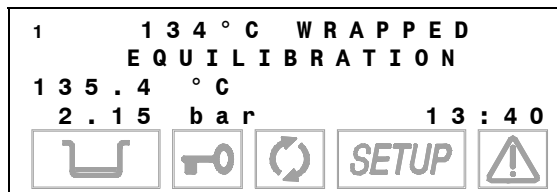

When the pressure and temperature values for the selected program have been reached, the sterilizer waits a moment to allow the temperature in the chamber and the load to stabilize (**EQUILIBRATION**). The liquid crystal display shows:

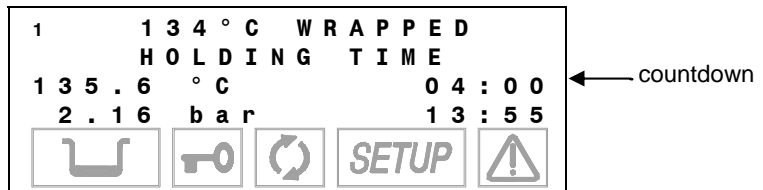

Sterilization time

When the thermodynamic parameters are balanced, the actual sterilization phase of the materials begins (**HOLDING TIME**). Thanks to continuous monitoring of the thermodynamic parameters and sophisticated management of the plumbing circuit, the pressure and temperature are maintained **constant** within the limits required by the program. The display shows the following:



The icon  **flashes** to indicate that the treatment of the load is in progress. At the end of the sterilization phase, the icon  remains **steady on** to indicate the complete sterilization of the material in the sterilization chamber.

WARNING

IF, FOR SOME REASON, THE STERILIZATION CYCLE HAS BEEN INTERRUPTED BEFORE COMPLETION, THE ICON CONTINUES FLASHING.

IN THIS CASE, THE MATERIAL CANNOT BE CONSIDERED STERILE AND MUST ABSOLUTELY NOT BE USED.



Steam discharge

At the end of the sterilization phase, the steam is released from the sterilization chamber (**STEAM DISCHARGE**). The liquid crystal display shows:

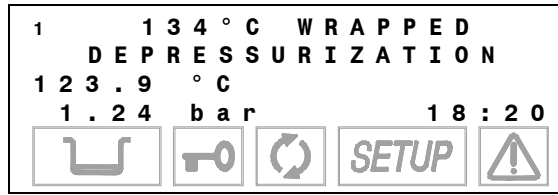

The icon for the sterilization process status  is **steady on**.

Drying

After the steam under pressure is released, its forced removal begins with the vacuum pump (**DRYING**): for this purpose, low pressure is created in the sterilization chamber to facilitate the evaporation of the steam and its consequent elimination. As a function of the type of drying set, one of the following screens will appear:

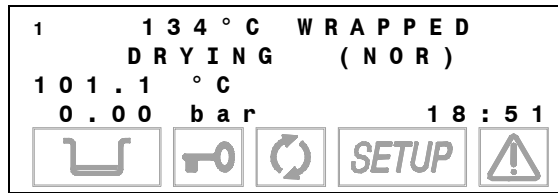

Standard drying

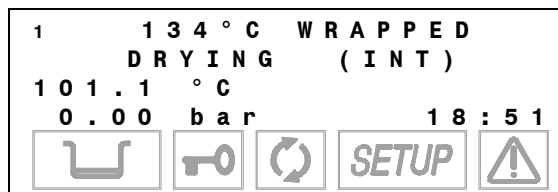

Intelligent drying

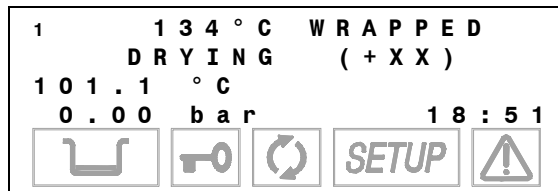

EXTRA DRYING
(+XX) is the time set

Ventilation

When the drying phase is finished, it is followed by a **VENTILATION** phase in which fresh sterile air is injected, while maintaining a vacuum in the chamber, to eliminate condensate and cool the load.

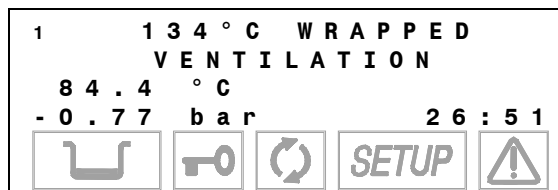

Leveling to the atmospheric pressure

At the end of the ventilation phase, the chamber is brought back to atmospheric pressure (**LEVELLING**) by injecting sterile outside air to allow the opening of the door and the retrieval of the load.



Completion of the cycle

When the pressure in the sterilization chambers returns within the pre-set safety limits, the door lock system is released.

The door status indicator **flashes**. At the same time, it also **beeps**.

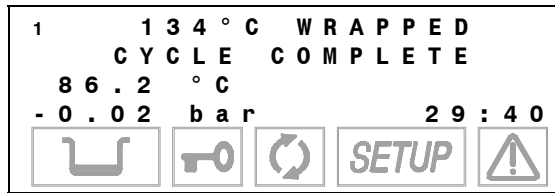

The icon for the sterilization process status is **steady on**.

NOTE

AT THE END OF THE CYCLE, AND UP TO THE OPENING OF THE DOOR, THE HEATING ELEMENTS ARE OFF. THE DEVICE IS COOLING SLOWLY.

NOTE

WHENEVER THE STERILIZER'S' DOOR IS NOT OPENED AT THE END OF THE CYCLE, THE VACUUM PUMP IS PERIODICALLY ACTIVATED TO REMOVE ANY TRACES OF CONDENSATE FROM THE STERILIZATION CHAMBER. THE DISPLAY SHOWS:

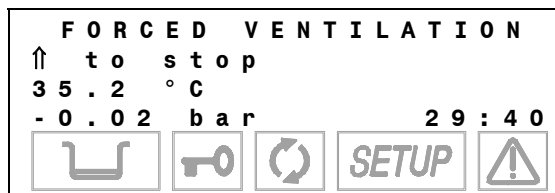

Press ↑ to interrupt ventilation and open the door.

Open the door

Open the door and **retrieve** the sterilized material, using the extractor provided.

The icon symbol **goes off**.

When the door is opened, the device goes to STAND-BY mode as previously set.

Report print (option)

When the door is opened, the report for the sterilization cycle executed is automatically produced (if the printer is installed). Check the document, initial it in the space provided and file it in a suitable place. Refer to the print report examples shown in Appendix B, Programs.

NOTE

IF SELECTED THE PRINTOUT STEP BY STEP OPTION, THE REPORT WILL BE PRINTED DURING THE PHASES OF THE CYCLE.

Equipment ready

The device is **ready** to execute a **new cycle**.

Repeat the procedures explained in the Chapter, "Program Selection" for executing a new sterilization cycle.

RESULT OF THE CYCLE

After the cycle is finished, it is important to check the sterilization results.

Whenever a cycle finishes (message **CYCLE COMPLETE** and icon on), without, therefore, being interrupted by any type of alarm, you are guaranteed to have **completely aseptic** material.

The report (option) of the sterilization parameters is an additional check tool.

CHECK OF THE CYCLE DATA REPORT (OPTION)

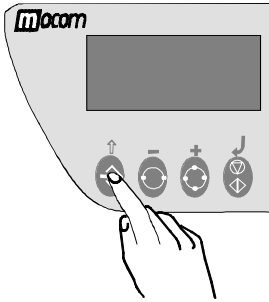

However, it is a good practice to check that the print report issued at the end of the sterilization program, also specifies a positive outcome.

At the end of the cycle, the salient data for the thermodynamic parameters (temperature, pressure and time) of the sterilization cycle, with particular attention to the sterilization phase true and proper, is printed by simply opening the door.

So, check the values on the print report and any additional indications for a further confirmation of the good outcome of the sterilization process.

The operator should sign in the space provided and file the document for possible future use.

If necessary, copies of the document can be used to identify the load (or parts of it) with the date/time of sterilization and details of the type of cycle performed.

NOTE



TO SELECT THE NUMBER OF COPIES TO PRINT, CONSULT [CHAPTER 6, CONFIGURATION - SETTING THE PRINTING MODE](#).

NOTE



TO START THIS PRINT FUNCTION, HOLD DOWN THE \uparrow (ESC) KEY ON THE CONTROL PANEL WHILE OPENING THE DOOR. THE OPERATOR CAN ALSO REQUEST AN EXTENDED PRINTOUT OF THE STERILIZATION PROCESS DATA, INCLUDING THE RECORDED VALUES OF ALL THE SENSORS INSTALLED ON THE MACHINE.

For complete details about printing the summary, please refer to the report examples shown in [Appendix B, Programs](#).

MANUAL CYCLE INTERRUPTION

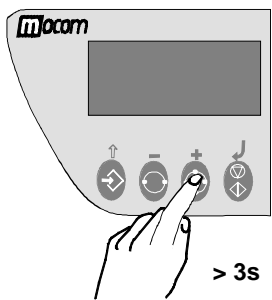
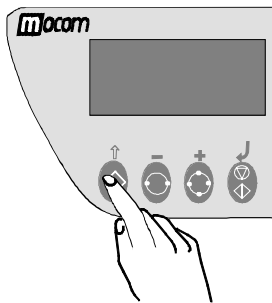
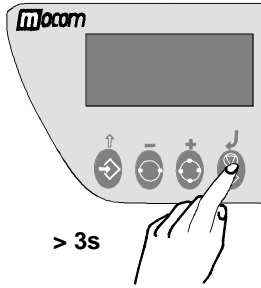

The operator can manually interrupt the cycle at any time by pressing the START/STOP key for three seconds.

The command generates the error **E999**, given that the cycle did not finish correctly. As a consequence, until safe conditions are reached, the display shows, along a beep:

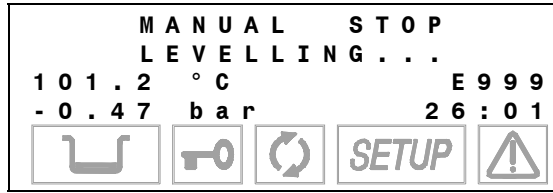

When safe conditions are reached, the machine activates a special procedure, first asking the user to manually unlock the door by displaying the following instruction:

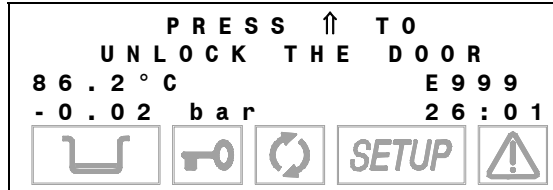

Press the ↑ key to unlock the door.
The following message is then displayed:



Finally, when the door is opened, you will be asked to reset the device by the following message:

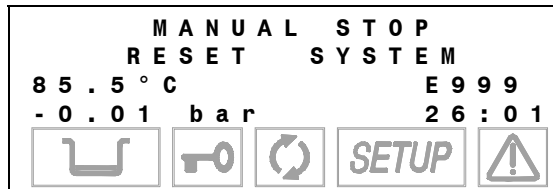

To **RESET** the system, **hold down, for at least three seconds**, the **PROGRAM SELECTION** key until you hear the confirming beep.

When the door is opened, the report for the sterilization cycle executed is produced, including the error code (**E999**). Check the report, initial it in the space provided and file it in a suitable place. Refer to the print report examples shown in **Appendix B, Programs**.

After the **RESET**, the device goes to **STAND-BY** mode, ready to execute a **new program**.

NOTE

WHENEVER AN ALARM IS GENERATED IN CERTAIN PHASES OF THE CYCLE, AN AUTOMATIC PROCEDURE IS ACTIVATED TO CLEAN THE PLUMBING CIRCUIT. FOR A COMPLETE DESCRIPTION OF THE ALARMS, SEE APPENDIX E "ALARMS".

WARNING

AFTER A PROGRAM IS MANUALLY INTERRUPTED (MANUAL STOP) ALWAYS CHECK THE STATUS OF THE ICON BEFORE USING THE MATERIAL IN THE STERILIZATION CHAMBER. IF THE ICON IS STEADY ON, THE MATERIAL IN THE STERILIZATION CAN BE CONSIDERED STERILE AND, THUS, BE USED. WE RECOMMEND USING IT IMMEDIATELY.

HOWEVER, IF IT IS OFF, THE MATERIAL IN THE STERILIZATION CHAMBER CANNOT BE CONSIDERED STERILE AND ABSOLUTELY MUST NOT BE USED.

STORING STERILIZED MATERIALS

INTRODUCTION

The sterilized material must be adequately treated and stored to maintain its sterility over time, until its use.

Inadequate storage **can** cause **rapid recontamination**.

This leads to problems regardless of what you do since you will either be using recontaminated material (most of the time unconsciously), placing the user and patient at risk, or you will have to run the sterilization cycle again, with an inevitable waste of time and resources.

For this reason, we think it will be useful to provide several basic suggestions, leaving the operator the task of further study of specific texts.

HANDLING

Assuming that the sterilizer is located in a clean place, free of dust and not too damp, the following **precautions** should be taken when handling and/or carrying sterile material:

1. Remove the load from the sterilization chamber wearing gloves and a clean, or even better, sterilized smock. As an additional precaution, wear a protective mask on your face;
2. Rest the tray on a dry, suitably clean and disinfected surface. *Take care to distance or, at any rate, separate the sterile material from the area where contaminated material is kept waiting to be sterilized;*
3. Touch the material and/or instruments as little as possible, taking extreme care **not** to cut or damage the wrappings;
4. Let the instruments cool before any transport (and subsequent storage). If necessary for transport, transfer the material using dry, clean and disinfected containers. The containers must be closed or, if open, covered with clean cloths.

STORAGE

Sterile material waiting for used must be stored using the appropriate techniques. These will significantly **slow** recontamination:

1. Store the material and/or instruments in the protective wrappings that were used during sterilization. **Do not** wrap the instruments after sterilization since, in addition to being useless and completely senseless, is also potentially damaging;
2. Store the material in a dry, suitably clean and disinfected place, far from the area where infected material passes. If possible, use closed compartments equipped with ultraviolet light;
3. Identify the sterile material by attaching the sterilization data (attaching a copy of the printed report or an adhesive label);
4. First use the material that has been stored the longest (FIFO, "First In First Out"). This results in material that is homogeneously stored, avoiding storing for too long, with the consequent risks.
5. **Never** store material for too long. In fact, do not overlook the fact that materials will tend to degrade and be recontaminated in a finite time, even when the above instructions are followed.

NOTE



CONSULT THE SPECIFICATIONS PROVIDED BY THE MANUFACTURER OF THE PACKAGING MATERIAL RELATIVE TO THE MAXIMUM ALLOWED STORAGE TIME.

TEST PROGRAMS

INTRODUCTION

Millennium S offers the possibility of, simply and automatically, executing the test program:

- Vacuum Test

The **Vacuum Test** program allows checking the perfect seal of the sterilizer's entire plumbing system.

By measuring the variation in the degree of vacuum in a certain span of time and comparing it with pre-set limit values, it is possible to determine the effectiveness of the seal of the sterilization chamber, the various tubes and the cut-off devices.

VACUUM TEST



To select the **VACUUM TEST** program, press the **Test Selection** key one or two times until the display reads:

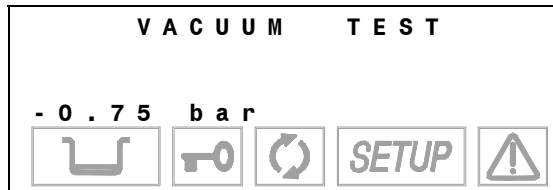

The Vacuum Test program is run with the **sterilization chamber empty**, and only the trays and their supports.

NOTE

RUN THE VACUUM TEST AS THE FIRST CYCLE AFTER POWERING-ON THE EQUIPMENT.

To avoid the heating of the sterilization chamber influencing the variation of the vacuum value measured during the Vacuum Test, the system is programmed to prevent its execution when the temperature sensors of the sterilization chamber shows a value higher than 50° C.

If you try to start the program with a higher temperature than indicated above, the liquid crystal display will read:



After a short time, the device will automatically return to STAND-BY mode, ready for use.

Close the door and start the program with the **START** key.

NOTE

IF A PASSWORD HAS BEEN SET WITH THE ANY CYCLE START OPTION (SEE THE CHAPTER, CONFIGURATION, SETTING THE PASSWORD), YOU WILL BE ASKED TO ENTER THE ACCESS CODE. IN ADDITION, THE EQUIPMENT CHECKS THE PRINTER PAPER PRESENCE AND, IF MILLFLASH IS CONNECTED, THE PRESENCE OF THE COMPACT FLASH CARD AND ITS MEMORY CAPACITY.

THE POSSIBLE WARNING MESSAGES, AND THE CONSEQUENT ACTIONS TO CARRY OUT, ARE THE SAME AS DESCRIBED FOR A STANDARD STERILIZATION CYCLE.

The vacuum phase begins immediately and the display shows the pressure (**bar**), and the total time from the start of the program.:

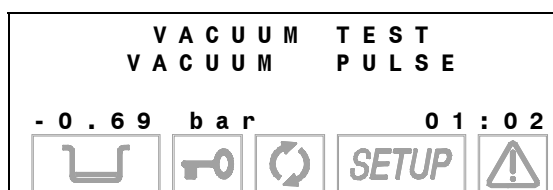

When the pre-set pressure is reached (-0.75 bar) the pump stops and the pressure stabilization phase begins (**WAITING PERIOD**), which lasts 5 minutes (shown on the display as a scalar value):

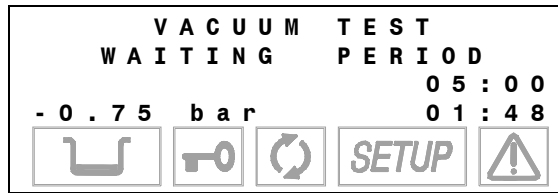

During this phase, a variation of the maximum low pressure is allowed of **not more than 10%**, without this causing the test to fail.

When the wait phase ends, the pressure verification phase, true and proper, begins (**LEAKAGE PERIOD**), with a duration of 10 minutes:

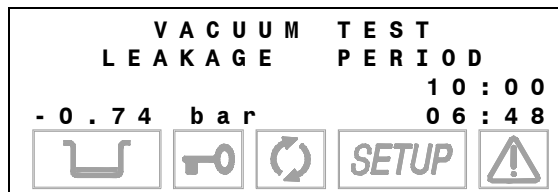

In this phase, a variation of **up to ±0.02 bar** is allowed, compared to the initial phase value. Higher variations cause the test to fail.

When this phase is also completed, the pressure is brought back to atmospheric pressure.



When the program finishes is signaled with a beep, the display will read:



NOTE

IF THE PRESSURE CHANGE EXCEEDS THE PRE-SET LIMIT, THE PROGRAM IS INTERRUPTED AND ALARM MESSAGE IS GENERATED. SEE A COMPLETE DESCRIPTION OF THE ALARMS IN APPENDIX E.

The duration of the test is about **23 minutes**.

When the door is opened at the end of the program, a report of the test cycle is printed (if the printer is installed) with all the salient data.

For complete details about printed reports, please refer to the examples shown in **Appendix B, Programs**.

SUMMARY TABLE

Device	Steam Sterilizer
Classification (as per 93/42/CEE)	II
Model	millennium S
Manufacturer	M.O.COM. S.r.l. Via delle Azalee, 1 20090 BUCCINASCO (MI) - ITALY
Power supply voltage	220V – 240 V~
Frequency	50 Hz
Mains fuses (6.3 x 32 mm)	F 16A 250V
On-board fuses (board type "T") (5 x 20 mm)	F1: T 6,3A 250V (trafo secondary winding) F2: T 3.15A 250V (trafo primary winding) F1 PTR: T 3.15A 250V (printer protection) - option
External dimensions (LxDxH)	480 x 560x 420 mm (excluding rear connections)
Nominal power	1600 W (7A)
Insulation class	Class I
Installation category	Cat. II
Environment of use	Internal use
Noise level	<60 db(A)
Environmental operating conditions	Temperature: +15 °C ÷ +40 °C Relative humidity: max 80% , non-condensing Altitude: max 3000 m (a.s.l.)
Net weight	about 53 kg (empty with trays and support) about 57 kg (empty, with trays and supports and water at MAX level)
Sterilization chamber dimensions (D x D)	250 x 350 mm
Sterilization chamber total volume	about 17 l (0.017 m ³)
Sterilization chamber useful volume (with tray supports inserted)	about 10 l (0.010 m ³)
Distilled water tank capacity (supply)	about 4.6 l (water at MAX level) about 0.8 l (water at MIN level)
Sterilization programs	Available: 6 (see Appendix B) Pre-sets: 4 (direct selection by user)
Test programs	Vacuum Test
Preheating time (from cold)	about 10 minutes
Serial connection	DB-9 pin (female) connector
Bacteriological filter (PTFE filtering element)	Porosity: 0.2 µm Connection: male 1/8" NPT connector

SAFETY DEVICES

The sterilizer is equipped with the following safety devices for which we provide a brief description of their function:

- **Mains fuses** (see summary table data)
Protection inside the device against a fault in the heating elements.
Action: cuts the electricity.
- **Fuses protecting the electronic circuits** (see summary table data)
Protection against a fault in the primary transformer circuit and low voltage uses.
Action: cuts power to one or more low-voltage circuits.
- **Thermal circuit breakers on the mains voltage windings**
Protection against overheating of the vacuum pump motor and the primary transformer windings.
Action: temporary cut-off (until cooling) of the winding.
- **Safety valve**
Protection against overpressure in the sterilization chamber.
Action: release of the steam and restoration of the safety pressure.
- **Steam generator manual rearm safety thermostat**
Protection against steam generator overheating.
Action: cut-off of the electricity to the steam generator.
- **Door position safety microswitch**
Confirmation of the correct closing position of the door of the container under pressure.
Action: signals wrong door position.
- **Mechanized door lock mechanism with electromechanical protection (pressure switch)**
Protection against accidental opening of the door (even in a blackout).
Action: prevents accidental opening of the door during a program.
- **Door lock mechanism safety microswitch**
Confirmation of the correct closing of the door lock.
Action: signaling the failure or incorrect operation of the door lock mechanism.
- **Self-leveling plumbing system**
Plumbing system structure for the spontaneous leveling of the pressure in the case of a manual interruption of the cycle, alarm or blackout.
Action: automatic restoration of atmospheric pressure in the sterilization chamber.
- **Integrated system for evaluating the sterilization process**
Continuous verification of the sterilization process parameters entirely managed by microprocessor.
Action: immediate interruption of the program (in case of anomaly) and generation of alarms.
- **Monitoring of the sterilizer's operation**
Real-time oversight of all significant parameters when the machine is powered.
Action: generation of alarm messages (in the case of anomaly) with possible interruption of the cycle.

WATER SUPPLY CHARACTERISTICS

DESCRIPTION	WATER SUPPLY VALUES	VALUES IN CONDENSATE
DRY RESIDUE	< 10 mg/l	< 1 mg/l
SILICON OXIDE SiO ₂	< 1 mg/l	< 0.1 mg/l
IRON	< 0.2 mg/l	< 0.1 mg/l
CADMIUM	< 0.005 mg/l	< 0.005 mg/l
LEAD	< 0.05 mg/l	< 0.05 mg/l
HEAVY METAL RESIDUES (except iron, cadmium and lead)	< 0.1 mg/l	< 0.1 mg/l
CHLORINES	< 2 mg/l	< 0.1 mg/l
PHOSPHATES	< 0.5 mg/l	< 0.1 mg/l
CONDUCTIVITY AT 20 °C	< 15 µs/cm	< 3 µs/cm
pH VALUE	5 - 7	5 - 7
APPEARANCE	colorless, transparent, without sediments	<i>colorless, transparent, without sediments</i>
HARDNESS	< 0.02 mmol/l	< 0.02 mmol/l

NOTE



WHEN PURCHASING DISTILLED WATER, ALWAYS CHECK THAT THE QUALITY AND CHARACTERISTICS DECLARED BY THE PRODUCER ARE COMPATIBLE WITH THOSE SHOWN IN THE TABLE.

WARNING



THE USE OF WATER FOR GENERATING STEAM CONTAINING CONTAMINANTS IN LEVELS EXCEEDING THOSE SHOWN IN THE TABLE WILL SIGNIFICANTLY SHORTEN THE STERILIZER'S LIFE.

IN ADDITION, THIS MAY INCREASE THE OXIDATION OF MORE SENSITIVE MATERIALS AND INCREASE LIME RESIDUES ON THE GENERATOR, BOILER, INTERNAL SUPPORTS AND INSTRUMENTS.

INTRODUCTION

The steam sterilizer is appropriate for almost all materials and instruments, so long as they are able to tolerate, without damage, a **minimum temperature of 121 °C** (otherwise, you will need to use other low-temperature sterilization systems).

The following material can normally be sterilized with steam:

- Stainless steel surgical/generic instruments;
- Carbon steel surgical/generic instruments;
- Rotating and/or vibrating instruments driven by compressed air (turbines) or mechanical transmission (counter-angles, tooth scalers);
- Glass articles;
- Mineral-based articles;
- Articles made of heat-resistant plastic;
- Articles made of heat-resistant rubber;
- Heat-resistant textiles;
- Medication materials (gauze, pads, etc.);
- Other generic material suitable for autoclave treatment.

NOTE



DEPENDING ON THE CONFORMATION OF THE MATERIAL, ANY PACKAGING (PAPER/PLASTIC ENVELOPE, STERILIZATION PAPER, MUSLIN NAPKIN, ETC.) AND ITS HEAT-RESISTANCE, IT IS INDISPENSABLE THAT YOU CHOOSE THE APPROPRIATE PROGRAM BY REFERRING TO THE TABLE SHOWN ON THE NEXT PAGE.

WARNING



THE DEVICE MUST NOT BE USED FOR STERILIZING FLUIDS, LIQUIDS OR PHARMACEUTICAL PRODUCTS.

PROGRAM SUMMARY TABLE

PROGRAM DESCRIPTION	NOMINAL VALUES				BASIC PROGRAM PARAMETERS					STERILIZABLE MATERIAL			NOTES	
	Temperature (°C)	Pressure (bar)	Holding time (min)	Cycle type (EN 13060: Pre-vacuum (F=fractionated; S=single)	Standard drying (L=long; S=short)	Total cycle time (average load ÷ max load)	Average consumption H ₂ O (ml/cycle)	Average energy consumption (kWh/cycle)	TYPE	MAX TOTAL MASS (kg)	MAX MASS PER TRAY (kg)	MAX MASS PER ARTICLE (kg)		
134 °C PRION	134	2,10	>18	S	S	L	57÷73	350	0.7	Solid instruments in single package	3.00	1.00	0.25	We recommend using the 3-tray configuration
134 °C WRAPPED	134	2,10	4	S	S	L	43÷47	300	0.6	Solid instruments in single package	3.00	1.00	0.25	
121 °C WRAPPED	121	1,10	20	S	S	L	58÷62	325	0.6	Solid instruments in single package	3.00	1.00	0.25	
134 °C SOLID	134	2,10	4	N	S	S	33÷37	300	0.5	Unpackaged solid instruments	6.00	1.20	0.50	
121 °C SOLID	121	1,10	20	N	S	S	48÷52	325	0.5	Unpackaged solid instruments	6.00	1.20	0.50	
134 °C EMERGENCY	134	2,10	3	N	S	Fast	29÷32	300	0.45	Unpackaged solid instruments	0.50	0.50	0.50	
VACUUM TEST	-	-0.80	-	-	-	-	23	-	-	Empty chamber	-	-	-	

NOTES

1) **SINGLE = PRE-VACUUM WITH SINGLE VACUUM PULSE (SEE FIGURES IN THE FOLLOWING PAGES)**

2) **LONG = 20 MINUTES VACUUM DRYING (TYPICAL OF WRAPPED CYCLES)**
SHORT = 10 MINUTES VACUUM DRYING (TYPICAL OF SOLID CYCLES)

STERILIZATION PROGRAM DIAGRAMS

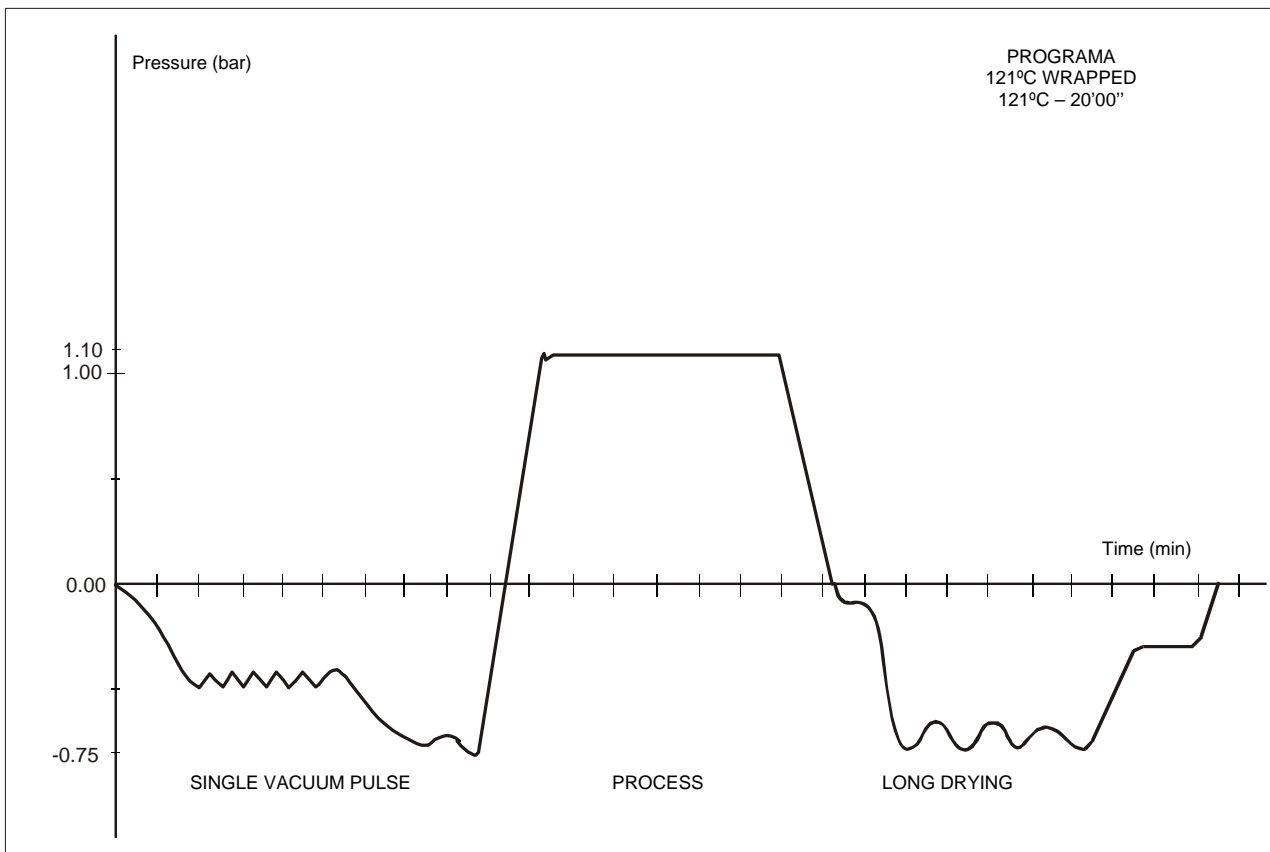
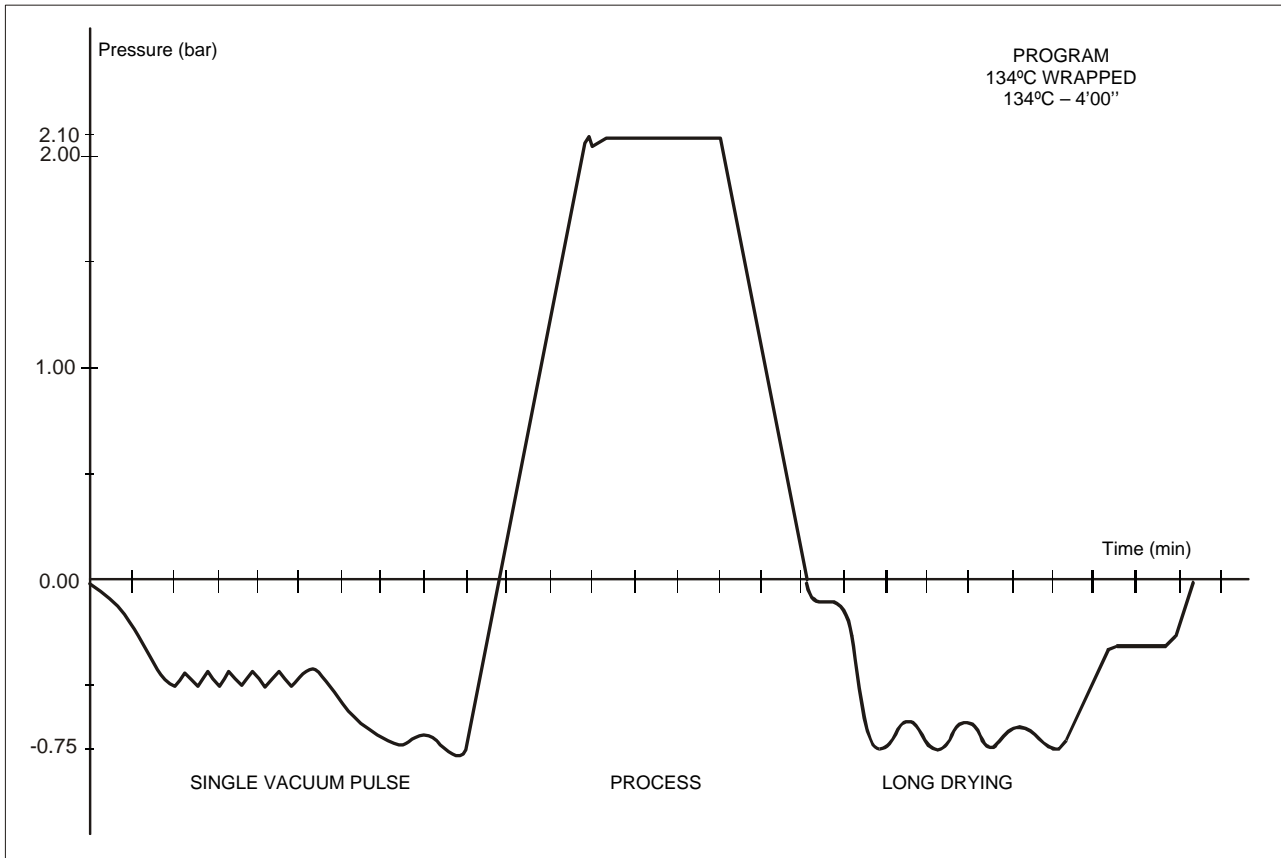

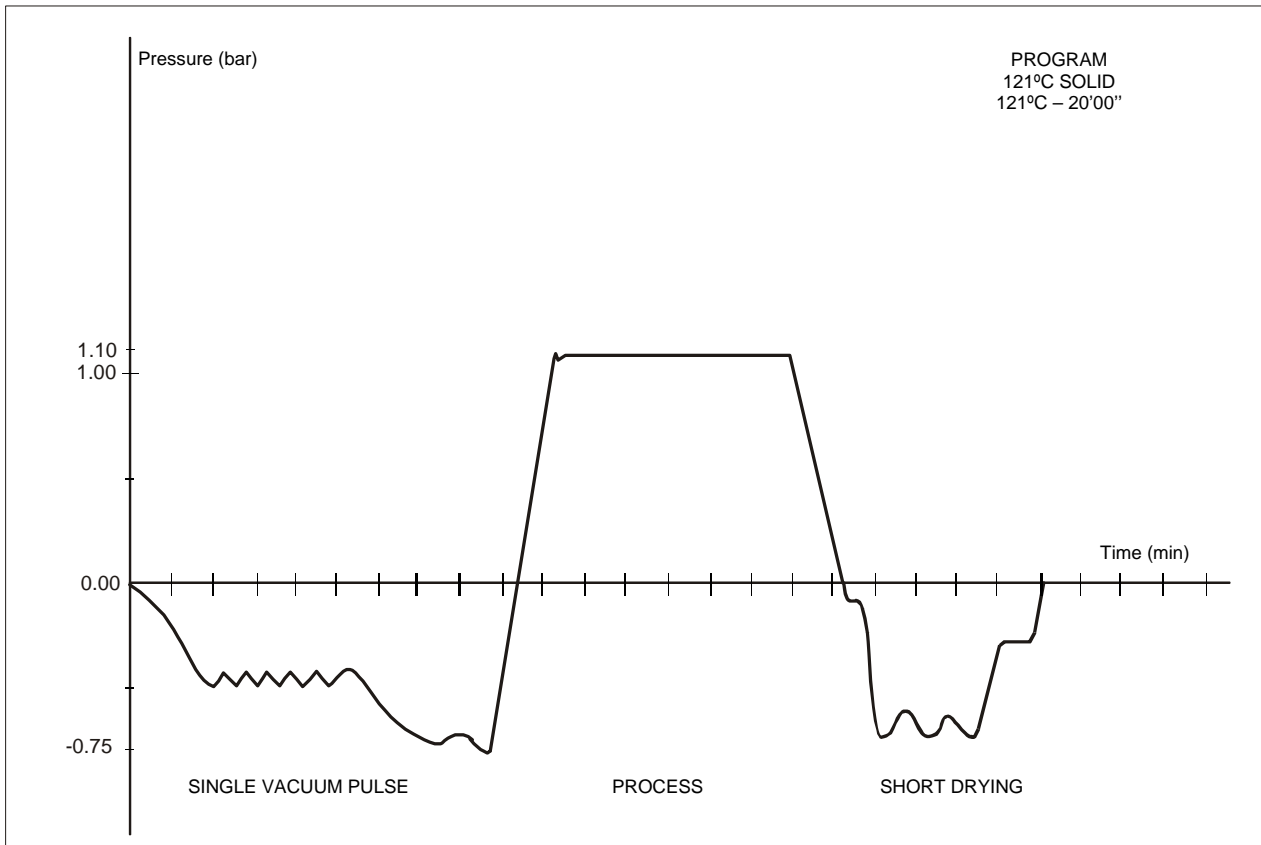
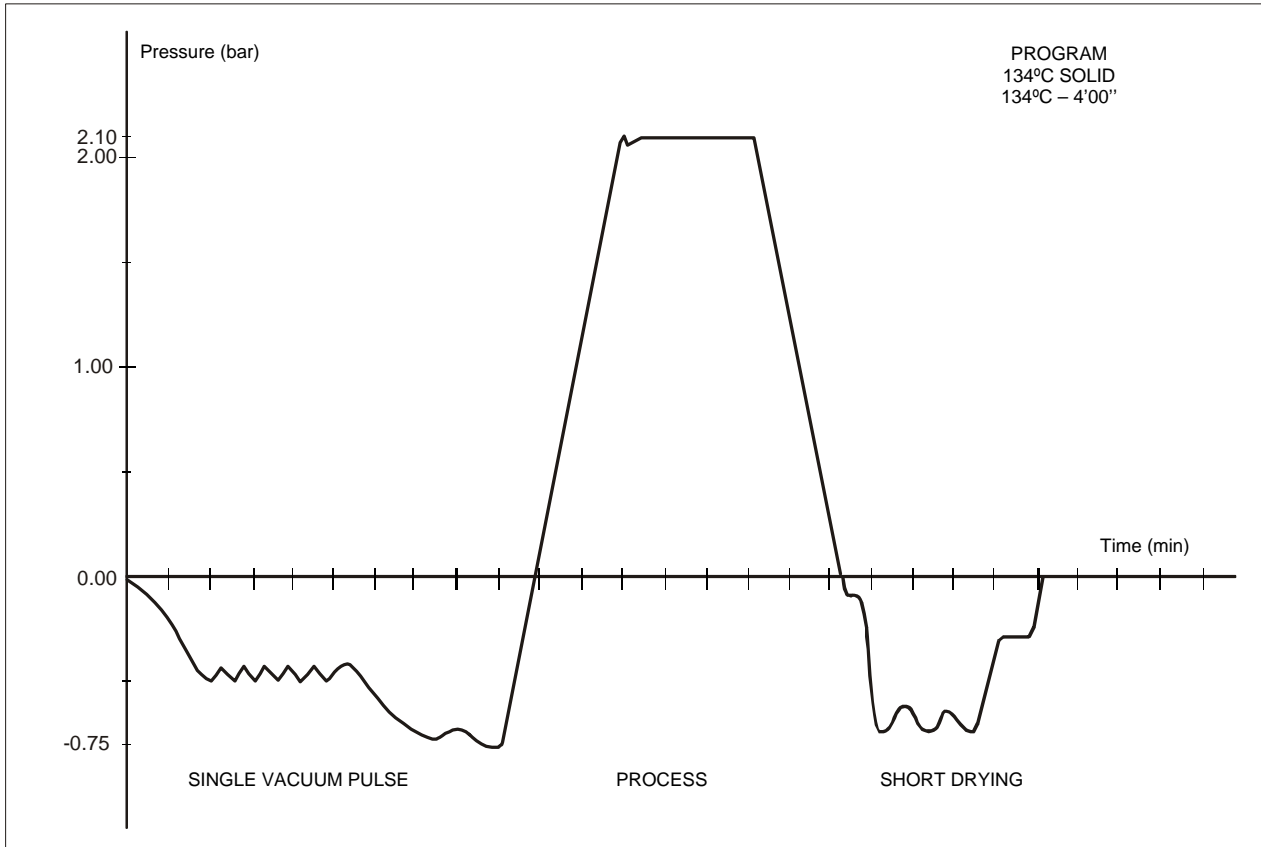

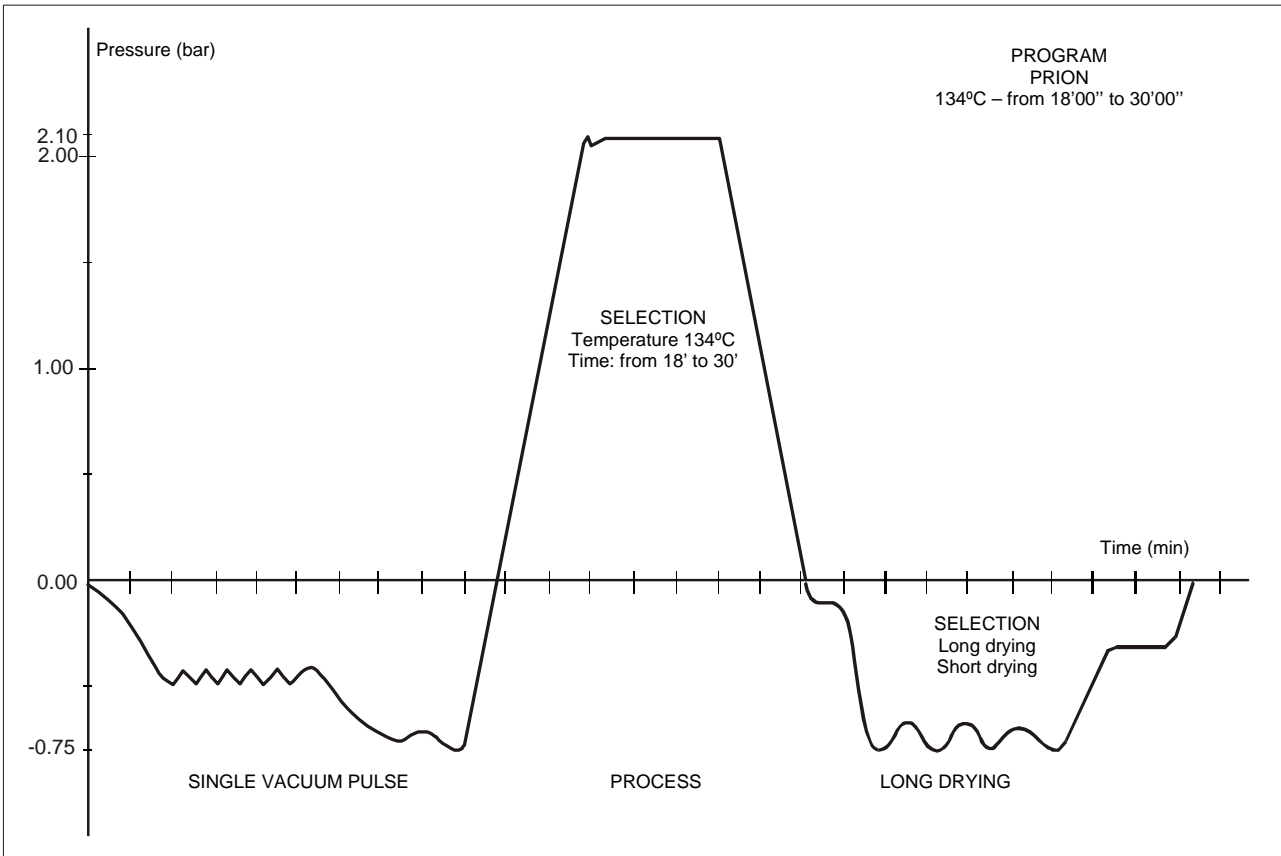
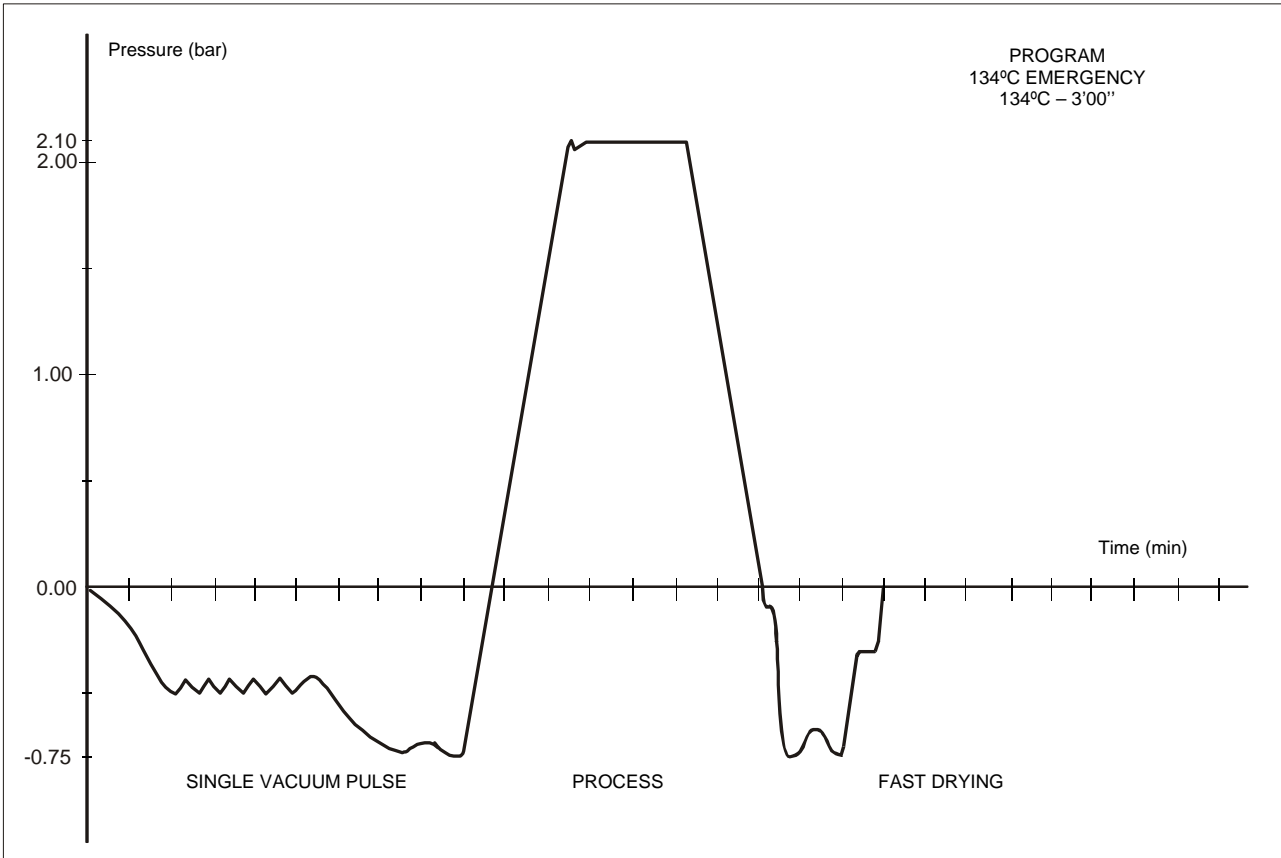

TEST PROGRAM DIAGRAM

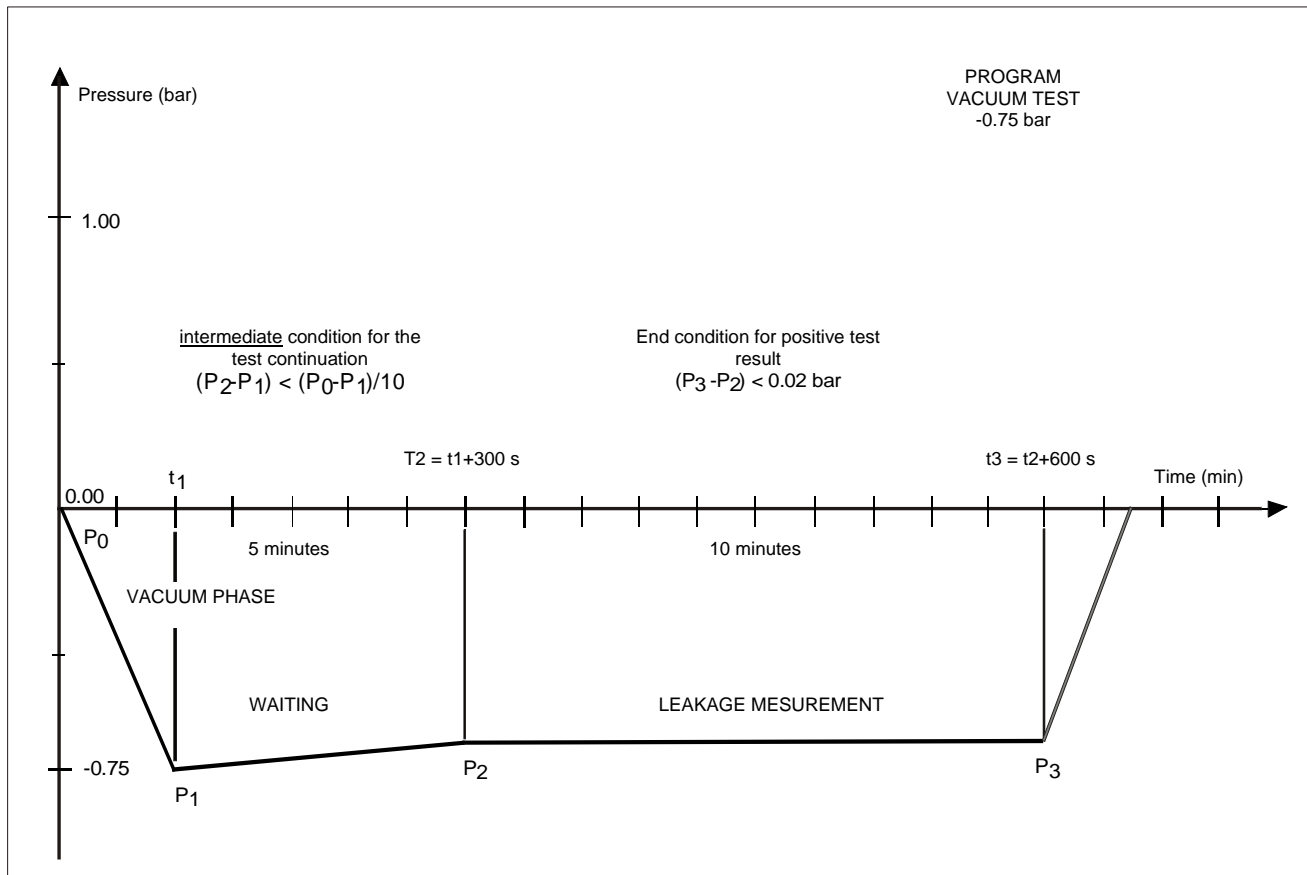

EXAMPLES OF PRINTED REPORTS

Cycle Report (normal)

Model MILLENNIUM S
 S/N 06 BH 0239
 Ver. SW E1002/BH000012
 Counter 00099/00101
 Selection 134°C WRAPPED
 Temperature 134°C
 Pressure 2.10 bar
 Process time 4 min
 Stand-by HIGH
 Pre-vacuum SINGLE
 Drying STANDARD

CYCLE START 09/05/2006
 16:48

Time		°C	bar
00:00	CSV	073.1	-0.02
05:38	1PV	076.0	-0.77
10:19	ET	135.5	+2.14
10:34	SS	135.8	+2.13
11:34		135.8	+2.13
12:34		135.8	+2.14
13:34		135.7	+2.14
14:34	SE	135.7	+2.13
15:33	DS	105.3	+0.00
17:33	SPD	085.9	-0.07
30:33	EPD	088.1	-0.62
31:33	DE	093.6	-0.07
31:48	CE	093.2	-0.03

10:34 MAX 135.8
 11:42 MIN 135.6

Drying Pulses 14
 CYCLE END 09/05/2006
 17:20

STERILIZATION: POSITIVE

OPERATOR

**Cycle Report (extended)
 at the operator's request**

Model MILLENNIUM S
 S/N 06 BH 0239
 Ver. SW E1002/BH000012
 Counter 00099/00101
 Selection 134°C WRAPPED
 Temperature 134°C
 Pressure 2.10 Bar
 Process time 4 min
 Stand-by HIGH
 Pre-vacuum SINGLE
 Drying STANDARD

CYCLE START 09/05/2006
 16:48

Time		PT1	P	PT2	PT3	PT4
00:00	CSV	073.1	-0.02	161.0	166.2	044.8
00:10	030	073.2	-0.09	163.2	165.4	045.1
00:20	030	073.1	-0.15	166.2	164.6	045.4
00:30	030	073.1	-0.20	169.8	163.7	045.7
00:40	030	073.0	-0.25	173.3	162.8	046.0
00:50	030	073.0	-0.29	175.7	162.0	046.3
01:00	030	072.9	-0.33	177.1	161.1	046.6
01:20	030	072.8	-0.41	177.9	159.8	047.1
01:52	040	074.5	-0.30	172.1	158.9	048.1
02:02	040	074.6	-0.36	172.5	159.0	048.6
02:12	040	074.9	-0.41	175.1	159.3	049.0
02:22	040	075.0	-0.44	179.2	159.5	049.4
08:16	110	121.0	+1.01	144.6	146.3	095.3
08:26	110	122.5	+1.11	144.8	144.6	097.1
08:36	110	123.9	+1.21	145.0	142.9	098.7
08:46	110	125.3	+1.31	145.4	141.3	100.3
15:04	130	121.7	+0.75	167.2	132.8	118.5
15:24	130	109.2	+0.18	167.3	132.3	111.8
15:33	DS	105.3	+0.00	167.0	132.4	109.6

19:13	140	077.3	-0.60	157.9	168.1	090.9
19:33	140	073.3	-0.67	157.0	167.2	089.8
19:49	140	071.3	-0.60	156.4	166.4	089.0
19:59	140	070.3	-0.62	156.0	165.9	088.6

20:09	140	069.5	-0.65	155.6	165.3	088.1
20:19	140	068.2	-0.68	155.2	164.7	087.7
20:32	140	067.9	-0.60	154.7	163.8	087.1
20:42	140	066.6	-0.63	154.3	163.3	086.7
20:52	140	065.8	-0.66	153.9	162.7	086.2

21:02	140	065.0	-0.68	153.5	162.3	085.9
23:29	140	080.8	-0.67	148.2	162.8	080.6

26:57	140	085.9	-0.65	141.5	163.2	075.6
27:17	140	085.5	-0.69	140.8	162.9	075.2
27:32	140	086.9	-0.60	140.3	162.9	074.9

29:16	140	086.2	-0.70	137.3	163.0	073.3
-------	-----	-------	-------	-------	-------	-------

29:36	140	087.6	-0.62	136.7	162.9	073.0
29:46	140	087.3	-0.64	136.4	163.1	072.9

10:34 MAX 135.8
 11:42 MIN 135.6

Drying pulses 14
 CYCLE END 09/05/2006
 17:20

STERILIZATION: POSITIVE

OPERATOR

EXTENDED REPORT
 REQUESTED BY THE OPERATOR

**Report following a
 Manual Stop**

Model MILLENNIUM S
 S/N 06 BH 0239
 Ver. SW E1002/BH000012
 Counter 00105/00111
 Selection 134°C WRAPPED
 Temperature 134°C
 Pressure 2.10 bar
 Process time 4 min
 Stand-by HIGH
 Pre-vacuum SINGLE
 Drying STANDARD

CYCLE START 11/05/2006
 09:07

Time		°C	bar
00:00	CSV	079.5	-0.02
05:10	1PV	085.3	-0.77
08:31	ET	135.5	+2.14
08:46	SS	135.7	+2.14
09:46		135.7	+2.13
10:46		135.8	+2.14
11:46		135.8	+2.14

STERILIZATION: NEGATIVE

ALARM CODE: E999
 DESCRIPTION: MANUAL STOP

DATE 11/05/2006
 TIME 09:19

CAUTION
 Please refer to the user manual

OPERATOR

**Report following a
 Blackout**

Model MILLENNIUM S
 S/N 03 BH 0001
 Ver. SW Exxxx/BHyyyyyy
 Counter 0006/0012
 Selection 134c PRIONE
 Temperature 134 °C
 Pressure 2.10 bar
 Process time 18 min
 Stand-by HIGH
 Pre-vacuum SINGLE
 Drying FAST

CYCLE START 19/11/02
 15:31

BLACK OUT 19/11/02
 15:45

STERILIZATION NEGATIVE

OPERATOR

ALARM CODE: E000
 DESCRIPTION: BLACK-OUT

**Cycle Report
 VACUUM TEST**

Model MILLENNIUM S
 S/N 03 BH 0001
 Ver. SW Exxxx/BHyyyyyy
 Counter 0011/0019
 Selection VACUUM TEST

CYCLE START 19/11/02
 11:37

Time		C	bar
00:00	CS	035.0	+0.00
01:39	E1F	037.4	-0.75
6:39	E2F	038.4	-0.74
16:39	E3F	042.0	-0.74
17:54	CE	045.5	-0.01
CYCLE END		19/11/02 11:41	

VACUUM TEST: POSITIVE

OPERATOR

In addition to correct use, the user needs to perform ordinary maintenance in order to guarantee safe, efficient operation over the device's entire life.

INTRODUCTION

For better quality maintenance, supplement ordinary checks with regular periodic examinations by the service department (see Appendix Z).

It is also fundamental to perform a **periodic sterilizer validation**, i.e., a check of the thermodynamic parameters of the process, comparing them with the reference values provided with suitably calibrated instruments. In this regard, see the paragraph, "Periodic Sterilizer's Validation", further below in this Appendix.

The ordinary maintenance described below consists in easy manual operations and preventive interventions involving simple instruments.

WARNING

IN THE EVENT OF THE REPLACEMENT OF THE DEVICE'S COMPONENTS OR PARTS, REQUEST AND/OR USE ORIGINAL REPLACEMENT PARTS ONLY.

ORDINARY MAINTENANCE PROGRAM

The table summarizes the maintenance required to keep the sterilizer operating at peak efficiency. In the case of **very intense use**, we recommend **shortening** maintenance intervals:

DAILY	Clean the gasket on the porthole Clean external surfaces
WEEKLY	Clean the sterilization chamber and relative accessories Disinfect external surfaces
MONTHLY	Clean the internal distilled water tank Safety valve maintenance Clean (or replace) the drain filter
EVERY 3-6 MONTHS (depending on frequency of use)	Replace bacteriological filter
ANNUALLY	Validate sterilizer (<i>see dedicated paragraph</i>)

Keep the following **general warnings** in mind:

- **Do not** wash the sterilizer with direct jets of water, either under pressure or sprinkled. Seepage into electrical and electronic components could damage the functioning of the device or its internal parts, even irreparably;
- **Do not** use abrasive cloths, metal brushes (or other aggressive materials) or metal-cleaning products, whether solids or liquids, to clean the device or sterilization chamber;
- **Do not** use chemical products or disinfectants to clean the sterilization chamber. In fact, these products can damage the sterilization chamber, even irreparably;
- **Do not** allow lime residue or other substances to accumulate in the sterilization chamber or on the door and its gasket, but periodically remove them. In fact, they can damage these parts over time in addition to compromising the operation of the components installed along the plumbing circuit.

NOTE

THE FORMATION OF WHITE SPOTS ON THE BASE OF THE INTERNAL WALLS OF THE STERILIZATION CHAMBER MEANS THAT YOU ARE USING LOW-QUALITY DEMINERALIZED WATER.

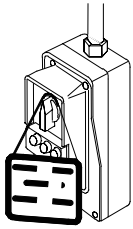

DANGER

BEFORE PERFORMING ORDINARY MAINTENANCE, MAKE SURE THAT THE POWER SUPPLY CORD IS REMOVED FROM THE MAINS SOCKET.

 **WHENEVER IT IS NOT POSSIBLE, PUT IN OFF THE EXTERNAL BREAKER OF THE EQUIPMENT POWER SUPPLY LINE.**

IF THE EXTERNAL BREAKER IS FAR AWAY OR, AT ANY RATE, NOT VISIBLE TO THE MAINTAINER, PLACE A WORK IN PROGRESS SIGN ON THE EXTERNAL BREAKER AFTER TURNING IT OFF.

MAINTENANCE DESCRIPTION

Clean gasket and porthole

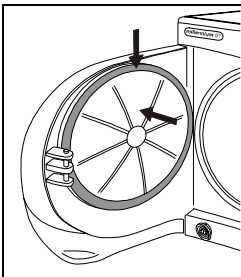

With reference to the preceding table, let's take a summary look at the various maintenance to be performed.

To remove traces of lime, clean the gasket of the container under pressure and the porthole with a clean, cotton cloth soaked in a weak solution of water and vinegar (or similar product, after first checking its contents on the label).
Dry the surfaces and remove any residue before using the device.

Clean external surfaces

Clean all the external parts using a clean cotton cloth dampened with water and, possibly, the addition of a neutral detergent.
Dry the surfaces and remove any residue before using the device.

Clean sterilization chamber and accessories

Clean the sterilization chamber, support and trays (and internal surfaces in general) with a clean cotton cloth soaked in water and, possibly, the addition of a small amount of neutral detergent. Carefully rinse with distilled water, taking care not to leave any type of residue in the chamber or on accessories.

NOTE

 **DO NOT USE SHARP OR POINTED INSTRUMENTS TO REMOVE LIME ENCRUSTATION FROM THE STERILIZATION CHAMBER. WHENEVER THERE ARE VISIBLE DEPOSITS, IMMEDIATELY CHECK THE QUALITY OF THE DISTILLED WATER USED (SEE APPENDIX A).**

Disinfect external surfaces

For the occasional disinfection of the external surfaces, you can use either denatured alcohol or detergents with a minimum percentage of sodium hypochlorite (or equivalent).

Clean internal distilled water tank

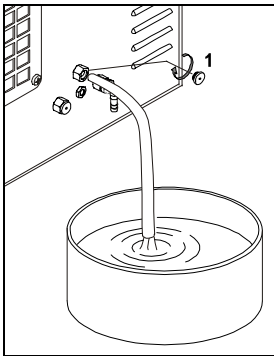

1. Arrange an empty container on the floor near the sterilizer and put the free end of a tube into it.
2. Unscrew the plug (1) from the rear draining point and plug-in the other end of the tube.
3. Wait until the internal tank is completely drained; close the draining point with the plug.
4. Prepare 4 liter of distilled water mixed with 10% of pure alcohol and fill the supplied standard container
5. Now fill completely the internal tank with this solution (see chapter “*Filling distilled water*” for the procedure) and allow the solution to sit for 30 minutes.

WARNING



DO NOT RUN ANY CYCLE DURING THIS PERIOD.

6. Drain again the internal tank and discard the solution. Close the draining point with the plug.

Safety valve maintenance

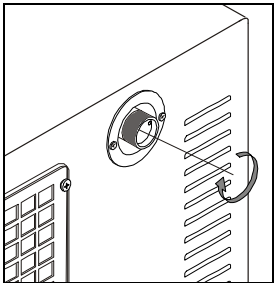

1. Access the safety valve located on the rear of the machine.
2. Loosen the knurled locking ring with your fingers (or a suitable tool inserted in the two holes in the ring itself), turning counter-clockwise until it reaches the end and turns loosely.
3. Retighten the locking ring and repeat the operation a couple of times.
4. **Definitively** tighten the locking ring all the way down.

WARNING



THIS OPERATION IS NECESSARY TO GUARANTEE THE CORRECT FUNCTIONING OF THE VALVE OVER TIME. AT THE END OF MAINTENANCE, MAKE SURE THAT THE LOCKING RING IS COMPLETELY SCREWED ON AND TIGHTENED.

Clean/replace the drain filter

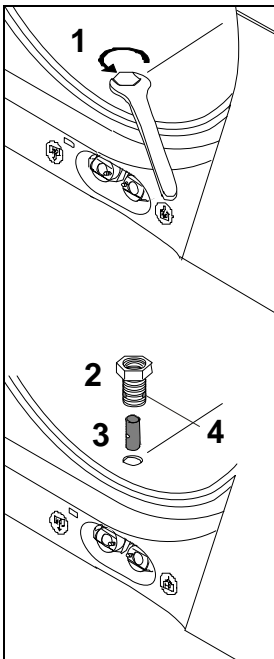

With use, various residues will probably tend to accumulate inside the filter, obstructing the lower drain tube over time.

For cleaning (or replace) the filter, open the door of the sterilizer and remove the nut (1) with a hexagonal wrench n. 14.

Then remove the fitting (2) and the filter (3).

Remove the filter from the support and carefully clean it under a throw of running water, using if necessary a pointed tool to remove possible material of greater dimensions.

If the filter cannot be reused, replace it with a new one.

Plug the filter in the support, block it with a drop of sealing (if available), having care to not obstruct the holes

Reassemble all parts following reversely the above procedure, paying attention on screwing down the fitting (2) so as to let the draining holes (4) at level of the chamber wall.

Replace bacteriological filter

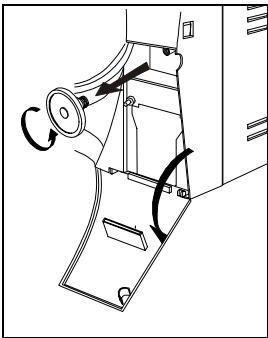

When it is due to be changed, or when you notice visible clogging of the filter (indicated by a color markedly tending towards gray) unscrew the bacteriological filter from its support and replace it with a new one by screwing it all the way down on the connector on the front of the machine.

NOTE



A REPLACEMENT BACTERIOLOGICAL FILTER IS SUPPLIED WITH THE DEVICE. TO REQUEST OTHERS, PLEASE REFER TO APPENDIX Z, TECHNICAL SUPPORT.

Replacing the paper in the printer (option)

Printer type 1

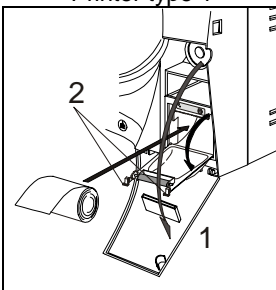

1. Open the door of the service compartment to access the printer,
2. Push the tongues to open the printer door and access the paper compartment,
3. Remove the empty roll and place a new roll of **thermal paper** so that the paper unrolls off the top;

the roll must have the following dimensions:

- width 57 mm
- diameter max 45 mm

4. Unroll about 15 cm of paper and close the compartment door,
5. Thread the paper in the slot of door of the service compartment and reclose.

Printer type 2

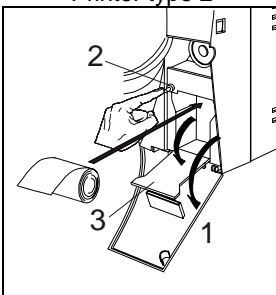

1. Open the door of the service compartment to access the printer,
2. Push the button on the left to open the printer door and access the paper compartment,
3. Remove the empty roll and place a new roll of **thermal paper** so that the paper unrolls off the top;

the roll must have the following dimensions:

- width 57 mm
- diameter max 45 mm

4. Unroll about 15 cm of paper and close the compartment door (the paper will automatically advance outside the window for several centimeters),
5. Thread the paper in the slot of door of the service compartment and reclose.

PERIODIC STERILIZER VALIDATION

As happens with all equipment, it is possible, and sometimes inevitable, to have a decrease in performance and the effectiveness of components along its lifespan, in a period of time dependent on its frequency of use.

To guarantee the safety of the process over time, it is periodically (possibly annually) necessary to **verify the thermodynamic process parameters** (pressure and temperature), to check if they continue to remain within allowed limits or not.

The requalification of the sterilizer's performance is the **responsibility of the user** of the product.

The reference European standards **EN 554** (*Sterilization of the medical devices - Method for the validation and systematic control of the steam sterilization*) and **EN 556** (*Sterilization of the medical devices – Requirements for the medical devices marked with “STERILE” indication*) supply an effective guide tool for carrying out the verifications on the steam sterilizers.

Since, in addition to specific experience and training, these controls require the use of special equipment (high-precision sensors and probes, data loggers, dedicated software, etc.) suitably verified and calibrated, it is necessary to contact a **company specializing** in these activities.

*The M.O.COM. Srl customer support department (see **Appendix Z**) is available to provide any information relative to the periodic validation of steam sterilizers.*

RECYCLING / DISPOSAL INSTRUCTIONS

Millennium S is mainly built from fiber-reinforced polymers, metals and electronic components.

In case of disposal:

- Separate the various components according to the materials they are made of.
- Drop the sterilizer with a company specialized on recycling these products.
- Do not abandon the sterilizer in unsecured places.
- Always refer to current/applicable laws in the country of use.

INTRODUCTION

If you run into a problem or alarm while using the device, you should **not** be immediately concerned. It may not, in fact, be related to a breakdown but, more probably to an anomalous situation, often merely transitory (such as a blackout), or incorrect use.

In any case, it is important to first identify the cause of the anomaly and then take suitable corrective action, either autonomously or with the help of the **Technical Support Department (see Appendix Z)**.

For this purpose, below, we provide instructions for diagnosing and resolving general problems, in addition to a precise description of the alarm codes, their meaning and their solution.

ANALYSIS AND RESOLUTION OF PROBLEMS

If your sterilizer is **not** working correctly, please make the following checks **before** calling the Technical Support Department:

PROBLEM	POSSIBLE CAUSE	PROPOSED SOLUTION
The sterilizer does not power-on.	The power cord is not plugged-in.	Plug it in.
	There is no voltage at the socket.	Check the cause of the lack of voltage at and socket and fix it.
	The main switch and/or differential switch are OFF.	Turn the switch ON.
	The mains fuses are blown.	Replace with good fuses of equal nominal value. <i>(See the Summary Table in Appendix A, Technical Characteristics).</i>
After pressing START , the sterilization cycle does not start.	The device is preheating.	Wait for the sterilizer to reach the proper operating conditions for starting the program. NOTE: Under normal conditions, the average preheating time is about 10-15 minutes.
The MIN water level icon is lit.	The distilled water level inside the tank is below the minimum level.	Fill the distilled water tank until the MAX level indicator comes on <i>(or, at any rate, until the MIN level signal turns off)</i> .
The alarm icon is lit.	An alarm was triggered, with the generation of the relative code and message (see <i>LCD</i>).	Check the alarm code and take the appropriate action. <i>(See the following paragraphs, Alarms, Alarm Codes and Troubleshooting).</i>
The safety valve has intervened.	Locking ring loosened. Presence of anomalous overpressure in the chamber.	Check that the knurled locking ring is correctly tightened on the upper part of the safety valve. <div style="border: 1px solid black; padding: 5px; text-align: center;">DANGER LET THE DEVICE COOL, OR WEAR GLOVES TO AVOID BEING BURNED WHEN TOUCHING THE VALVE.</div>
At the end of the program (CYCLE COMPLETE), I'm not able to open the door.	There is residual pressure in the sterilization chamber at the end of the cycle. NOTE: the display shows: NOW LEVELLING PLEASE WAIT...	Wait several minutes, until the pressure returns to 0.00 bar, and try to open the door again. Check if the bacteriological filter is clogged and, if necessary, replace it with a new one. The procedure for storing the ambient temperature (SET 0 bar function) was not executed correctly. Contact the Technical Support Department (see Appendix Z)
	At the end of the cycle, the safety door lock remains on.	Contact the Technical Support Department (see Appendix Z).

PROBLEM	POSSIBLE CAUSE	PROPOSED SOLUTION
<p>There is water on the support surface of the sterilizer.</p>	<p>Drain connectors or tubing (option) not correctly connected.</p>	<p>Check the tightness of the fittings; if necessary, reassemble, paying more attention to sealing.</p> <p>Check that the tubes are completely pushed onto the connectors; make sure that the plastic ties have been applied.</p>
	<p>The tube for the automatic water supply (option) not correctly connected.</p>	<p>Check the tightness of the connector; if necessary, reassemble, paying greater attention to sealing (see the Chapter, "Installation").</p> <p>Check that the tube coming from the external tank/Milldrop is completely pushed onto the connector; make sure that the plastic tie has been applied.</p>
	<p>Steam leaks from the door gasket.</p>	<p>At the end of the cycle, clean the gasket and porthole of the container under pressure. Check if the gasket is damaged.</p> <p>Run another cycle and check the situation.</p>
<p>The sterilizer has problems creating a vacuum in the chamber (drying problems, presence of water in the sterilization chamber at the end of the cycle, etc.).</p>	<p>Drain filter of the sterilization chamber obstructed.</p>	<p><u>Clean</u> or <u>replace</u> the drain filter</p> <p>(See Appendix C "Maintenance").</p>
	<p>Drain circuit obstructed or drain tubes choked (option).</p>	<p>Check that the drain tubes (and the connectors they are pushed onto) are not obstructed and run freely.</p>
	<p>The air intake on the frame and/or the cover are obstructed or the heat exchanger is not sufficiently ventilated.</p>	<p>Remove all possible obstructions from the air intake and heat exchanger.</p> <p>Check that the device is not in direct contact with walls or surfaces (see the Chapter, "Installation").</p>
<p>Excessive humidity on the material and/or instruments at the end of the program.</p>	<p>Excessive quantity of material inside the sterilization chamber.</p>	<p>Check the quantity of material sterilized and make sure that it does not exceed the maximum allowed quantity, depending on the type of load.</p> <p>(See the <i>Summary Table</i> in Appendix A, Technical Characteristics").</p>
	<p>Material not correctly positioned.</p>	<p>Position the material, and especially wrapped material, according to the instructions.</p> <p>(See the Chapter, "Preparing the Material").</p>
	<p>Wrong sterilization program selection</p>	<p>Select the appropriate sterilization program for the type of material to be treated.</p> <p>(See the <i>Summary Table</i> in Appendix B, "Programs").</p>
	<p>Drain filter of the sterilization chamber obstructed.</p>	<p><u>Clean</u> or <u>replace</u> the drain filter</p> <p>(See Appendix C "Maintenance").</p>
<p>Traces of oxidation or spots on instruments</p>	<p>Quality of the instruments is not adequate.</p>	<p>Check the quality of the instruments with the problem, checking whether the material they are made of can tolerate steam sterilization.</p>
	<p>Quality of the distilled water not adequate.</p>	<p>Empty the tank and fill it with high-quality distilled water.</p> <p>(See the <i>Water Supply Characteristics</i> in Appendix A, "Technical Characteristics").</p>
	<p>Organic or inorganic residues on the instruments</p>	<p>Carefully clean the material before subjecting it to the sterilization cycle.</p> <p>(See the Chapter, "Preparing the Material").</p>

PROBLEM	POSSIBLE CAUSE	PROPOSED SOLUTION
Traces of oxidation or spots on instruments (continue)	Contact between instruments made of different metals.	Separate instruments made of different metals. (See the Chapter, "Preparing the Material").
	Lime residue on the wall of the sterilization chamber and/or accessories.	Clean the device and its parts, as required. (See Appendix C "Maintenance").
Blackening of the instruments or damage to the material.	Wrong sterilization program selection.	Check the adequacy of the sterilization temperature of the selected program in relation to the material to be treated. (See the <i>Summary Table</i> in Appendix B, "Programs").
The printer (option) is not printing the summary report	Wrong printer configuration.	Configure the sterilizer for the type of printer used (Configuration program). (see the Chapter, "Configuring the Device").
	Paper used-up.	Insert a new roll of paper. (See Appendix C, "Replacing the Paper").
	Paper jammed.	Clear the jam. Check the dimensions of the roll of paper. (See Appendix C, "Replacing the Paper").

NOTE



SHOULD THE PROBLEM PERSIST, CONTACT THE CUSTOMER SERVICE (SEE **APPENDIX Z) PROVIDING THE MODEL OF THE STERILIZER AND THE SERIAL NUMBER. THIS INFORMATION IS FOUND ON THE SERIAL NUMBER PLATE ON THE REAR OF THE DEVICE AND ON THE WARRANTY CERTIFICATE.**

INTRODUCTION

Every time an **anomalous condition** occurs during the operation of the sterilizer, an alarm is generated, identified by a **specific code** (consisting of a letter followed by a 3-digit number).

Alarm codes are divided into **three categories**:

- **E = ERROR**
Wrong maneuver and/or use, or a cause external to the device.
A problem that can generally be fixed by the user.
Code format: **Exxx** (**xxx = identifying number from 000 ÷ 999**)
- **A = ALARM**
First-level fault, **not linked** to safety.
A problem that normally is fixed by a specialized technician on-site.
Code format: **Axxx** (**xxx = identifying number from 000 ÷ 999**)
- **H = HAZARD**
Second-level fault, **linked** to safety.
A problem generally fixed by the Technical Support Center.
Code format: **Hxxx** (**xxx = identifying number from 000 ÷ 999**)

ALARM INTERVENTION

NOTE

IN THE CASE OF AN ALARM, PLEASE ONLY REMOVE VOLTAGE FROM THE DEVICE AFTER EXECUTING A RESET (SEE THE PARAGRAPH, “RESETTING THE SYSTEM”).

The intervention of the **alarm** causes the **interruption of the cycle** (or the normal equipment operation) with the relative appearance of an **alarm code** and a **message** on the display, accompanied by a **beep** and the **lit alarm icon** (intermittent).

NOTE

DURING THE ALARM PROCEDURE, THE DISPLAY ALWAYS SHOWS THE CURRENT TEMPERATURE AND PRESSURE IN THE STERILIZATION CHAMBER.

This procedure is designed so as **not** to allow the user to **mistake** an anomalous cycle for a correctly completed cycle and, as a consequence, **involuntarily using non-sterile material**.

The alarm procedure is **differentiated** depending on whether it occurs **during** the execution of the program or **outside**, and is structured to guide the user to the **necessary RESET** of the sterilizer.

Alarm during a cycle

If the alarm intervenes **during a program**, the display will show the message:

(A l a r m M e s s a g e)

L E V E L L I N G

1 1 4 . 6 ° C X X X X

0 . 7 0 b a r 1 1 : 3 0

SETUP

← Alarm Message

← Alarm Code

Whenever an alarm is generated in certain phases of the cycle, an automatic procedure is activated to clean the internal water circuit. The display will contain the notice:

(A l a r m M e s s a g e)

C I R C U I T C L E A N I N G

1 0 0 . 6 ° C X X X X

0 . 7 0 b a r 1 1 : 4 0

SETUP

← Alarm Code

At the end of what has been described and having reached safe conditions, the machine activates a special procedure, that asks the user to manually unlock the door:

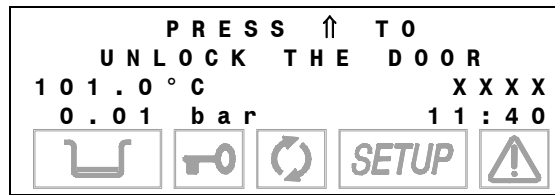

Press the ↑ key to unlock the door lock mechanism; the following message appears:

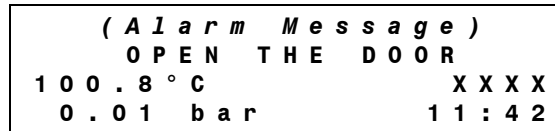

Once the door is open, the user is finally asked to **reset** the system:



Perform a **RESET** (described below) and then turn-off the equipment and check the error or make the repair.

NOTE

WHEN THE DOOR IS OPENED, THE REPORT (NORMAL OR EXTENDED DEPENDING ON THE TYPE OF ALARM) WILL BE PRINTED FOR THE INTERRUPTED STERILIZATION PROGRAM AND THE ALARM THAT INTERVENED. CHECK THE DOCUMENT, INITIAL IT IN THE SPACE PROVIDED AND FILE IT IN A SUITABLE PLACE. REFER TO THE PRINT REPORT EXAMPLES SHOWN IN APPENDIX B, PROGRAMS".

Alarm outside the cycle

If the alarm intervenes **outside the sterilization or test program** the display will show:



Turn-off the equipment and check the alarm.

Or, depending on the type of alarm:



Perform a **RESET** (described below) and then turn-off the device and check the alarm.

NOTE

ALARMS THAT INTERVENE OUTSIDE OF A PROGRAM DO NOT PRODUCE A PRINTED REPORT.

RESETTING THE SYSTEM

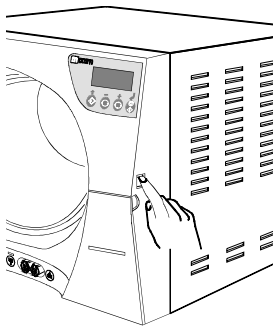
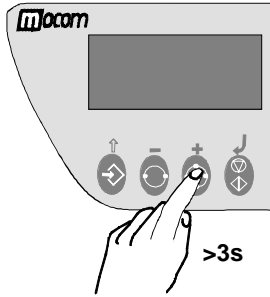

The system is **RESET** in two alternative ways, depending on the alarm that occurred (see the **Alarm Code List** further below in this appendix):

1. Press the PROGRAM SELECTION key for about 3 seconds.
A beep confirms the RESET;

WARNING





NEVER TURN THE DEVICE OFF BEFORE EXECUTING A RESET.

2. Turn-off the device and then power-on using the main switch.
Upon power-up, the sterilizer will perform its normal initial test.

After RESET, and any technical intervention necessary to eliminate the fault, the device will go to STAND-BY mode, ready to execute a new program.

ALARM CODES

The list of alarm codes and, consequently, the messages displayed on the LCD and relative RESET mode, is as follows:

CODE	ALARM DESCRIPTION	LCD INDICATION	RESET MODE
ERRORS (category E)			
E 000	Blackout	BLACK-OUT	Press key  (> 3 seconds)
E 010	Door open	DOOR OPEN	
E 020	Exceeded timeout for activating door lock system (closing)	DOOR UNLOCKED	
E 021	Exceeded timeout for activating door lock system (opening)	DOOR LOCKED	
E 030	Water in the fill tank at minimum (MIN) level	WATER MIN	
E 031	Water in the drain tank at maximum (MAX) level	EXHAUST MAX	
E 041 (option)	Filling the tank too frequently (<i>automatic filling</i>)	FILLING PROBLEM	
E 900	Vacuum Test failed (<i>during the LEAKAGE PHASE</i>)	TEST FAILED	
E 901	Vacuum Test failed (<i>during the WAITING PHASE</i>)	TEST FAILED	
E 902	Vacuum Test failed (<i>vacuum pulse timeout exceeded</i>)	TEST FAILED	
E 999	Manual cycle interruption	MANUAL STOP	
ALARMS (category A)			
A 022	System door lock microswitches failed (OFF-OFF)	LOCKING PROBLEM	Turning-off device
A 023	System door lock microswitches failed (ON-ON)	LOCKING PROBLEM	
A 024	System door lock microswitches failed (ON-OFF)	LOCKING PROBLEM	
A 032	Sensor-level problem	LEVEL PROBLEM	
A 040	Failure to fill the tank (<i>automatic filling</i>)	FILLING PROBLEM	
A 101	PT1 broken (<i>sterilization chamber</i>)	PTC BROKEN	
A 102	PT2 broken (<i>steam generator</i>)	PTC BROKEN	
A 111	PT1 short-circuited (<i>sterilization chamber</i>)	PTC SHORTCIRCUIT	
A 112	PT2 short-circuited (<i>steam generator</i>)	PTC SHORTCIRCUIT	
A200	Pre-heating not performed within the timeout (<i>heating resistor problem</i>).	HEATING PROBLEM	Press key  (> 3 seconds)
A 250	1st vacuum pulse not reached within timeout	PV1 TIMEOUT	
A 251	1st rise to atmospheric pressure not reached within timeout	ATM1 TIMEOUT	
A 258	3rd pressure pulse not reached within timeout	PPP TIMEOUT	
A 259	Phase of PROCESS not started within timeout	PROCESS TIMEOUT	
A 260	Chamber depressurization not completed within timeout	PPD TIME-OUT	

CODE	ALARM DESCRIPTION	LCD INDICATION	RESET MODE
HAZARDS (category H)			
H 150	MPX pressure sensor broken	MPX BROKEN	Turning-off device
H 160	MPX pressure sensor short-circuited/not connected	MPX SHORTCIRCUIT	
H 400	Ratio P_{conv}/T not balanced ($P_{conv}>T$) (Phase PROCESS)	P/T PROBLEM	Press key  (> 3 seconds)
H 401	Ratio T/P_{conv} not balanced ($T>P_{conv}$) (Phase PROCESS)	T/P PROBLEM	
H 402	Temperature above MAX limit (Phase PROCESS)	T OVER LIMIT	
H 403	Temperature below MIN limit (Phase PROCESS)	T UNDER LIMIT	
H 404	Temperature fluctuating over the limit (Phase PROCESS)	PT1 FLUCTUATING	
H 405	Pressure above MAX limit (Phase PROCESS)	P OVER LIMIT	
H 406	Pressure below MIN limit (Phase PROCESS)	P UNDER LIMIT	
H 410	Wrong maintenance time (Phase PROCESS)	TIMING PROBLEM	
H 990	Excessive pressure (sterilization chamber, MPX)	OVERPRESSURE	
H 991	Overheating (sterilization chamber, PT1)	OVERHEATING PT1	
H 992	Overheating (steam generator, PT2)	OVERHEATING PT2	

ANALYSIS AND RESOLUTION OF PROBLEMS

Based on the **type of alarm**, below we provide instructions for identifying the possible causes and restoring correct operation:

CODE	POSSIBLE CAUSE	PROPOSED SOLUTION
ERRORS (category E)		
E 000	Sudden power failure (blackout).	Wait for electricity to return and perform RESET following the instructions.
	Accidentally turning-off the main switch and/or pulling the plug out of the socket.	Reconnect the plug and/or power-on the device and perform RESET following the instructions.
	Mains fuses blown.	Replace with good fuses of equal nominal value. (See the <i>Summary Table</i> in Appendix A, Technical Characteristics). Turn-on the device and perform RESET following the instructions.
E 010	Door open (or not properly closed) at the start of the program (START).	Perform RESET following the instructions. Close the door <u>properly</u> and restart the program.
	Door position microswitch broken.	Contact the Technical Support Department (see Appendix Z).
E 020	Limit microswitch (CLOSED position) of the door lock mechanism broken.	Perform RESET following the instructions. Try to start the program a second time.
	Door lock system gear motor broken.	If the problem persists contact the Technical Support Department (see Appendix Z).
E 021	Limit microswitch (OPEN position) of the door lock mechanism broken.	Perform RESET following the instructions.
	Door lock system gear motor broken.	Contact the Technical Support Department (see Appendix Z).
E 030	Water level in the fill tank below minimum (MIN) level.	Perform RESET following the instructions. Top-off the water until the MAX level indicator comes on (or at least until MIN indicator goes off).
	MIN water level indicator broken.	Contact the Technical Support Department (see Appendix Z).
E 031	Level in the used water tank over the MAX.	Perform RESET following the instructions and empty the tank.
E 041 (option)	Connection tube between the sterilizer and a possible external filling device not correctly installed.	Perform RESET following the instructions. Check that the water supply tube is correctly and solidly connected to the relative connectors. Eliminate all possible obstructions along the path of the tube.
	Water filling pump broken.	Contact the Technical Support Department (see Appendix Z).
	Problem in the plumbing circuit.	
E 900	Air leaking through the gasket	Perform RESET following the instructions. Carefully clean the gasket with a clean cotton cloth dampened with water. Start the program again.
	Problem in the plumbing circuit.	Contact the Technical Support Department (see Appendix Z).

CODE	POSSIBLE CAUSE	PROPOSED SOLUTION
E 901	Excessive humidity in the sterilization chamber.	Perform RESET following the instructions. Carefully dry the inside of the sterilization chamber and start the program again.
	Air leaking through the gasket	Perform RESET following the instructions. Carefully clean the gasket with a clean cotton cloth dampened with water. Start the program again.
	Problem in the plumbing circuit.	Contact the Technical Support Department (see Appendix Z).
E 902	Excessive humidity in the sterilization chamber.	Perform RESET following the instructions. Carefully dry the inside of the sterilization chamber and start the program again.
	Air leaking through the gasket	Perform RESET following the instructions. Carefully clean the gasket with a clean cotton cloth dampened with water. Start the program again.
	Vacuum pump broken.	Contact the Technical Support Department (see Appendix Z).
	Problem in the plumbing circuit.	
E 999	Manual interruption of sterilization or test program. (Also see the Chapter, “Running the Program”)	Perform RESET following the instructions. Check that the load has been correctly sterilized (see LCD indicators) before using the material.
ALARMS (category A)		
A 022	Limit microswitch(es) on the door lock mechanism broken.	Contact the Technical Support Department (see Appendix Z).
A 023	Limit microswitch(es) on the door lock mechanism broken.	
A 024	Limit microswitch(es) on the door lock mechanism broken.	
A 032	Connector of the water level indicators not connected.	
	Level indicator(s) broken.	
A 101	Chamber temperature sensor (PT1) broken.	
A 102	Steam generator temperature sensor (PT2) broken.	
A 111	Incorrect connection of the temperature sensor (sterilization chamber) to the connector.	
	Temperature sensor short circuit (sterilization chamber).	
A 112	Incorrect connection of the temperature sensor (steam generator) to the connector.	
	Temperature sensor short circuit (steam generator).	

CODE	POSSIBLE CAUSE	PROPOSED SOLUTION
A 200	Intervention of the steam generator safety thermostat.	<u>Manually rearm</u> the thermostat located on the back of the device (see the Chapter, “Product Introduction”).
	Steam generator malfunction.	Unscrew the black plastic protection cap, press the red button until you hear a click and replace the cap. Turn-off (RESET) and then turn-on the device. If the problem persists contact the Technical Support Department (see Appendix Z) .
A 250	Presence of water or condensate in the sterilization chamber.	Perform RESET following the instructions. Carefully dry the inside of the sterilization chamber and start the program again. Do not put material impregnated with water, or liquids in general, in the chamber.
	Drain filter of the sterilization chamber obstructed.	<u>Clean</u> or <u>replace</u> the drain filter (See Appendix C “Maintenance”).
	Air leaking through the gasket.	Perform RESET following the instructions. Carefully clean the gasket with a clean cotton cloth dampened with water. Start the program again.
	Vacuum pump broken. Problem in the plumbing circuit.	Contact the Technical Support Department (see Appendix Z) .
A 251	Water injection pump malfunction. Problem in the plumbing circuit.	Contact the Technical Support Department (see Appendix Z) .
	Intervention of the steam generator safety thermostat.	See A 200.
	Steam generator malfunction.	Contact the Technical Support Department (see Appendix Z) .
A 258	Steam leaking through the gasket.	Perform RESET following the instructions. Carefully clean the gasket with a clean cotton cloth dampened with water and start the program again.
	Excessive load.	Perform RESET following the instructions. Check the quantity of the material in the sterilization chamber and make sure that it does not exceed the maximum allowed. (See the <i>Summary Table</i> in Appendix A, Technical Characteristics).
	Problem in the plumbing circuit.	Contact the Technical Support Department (see Appendix Z) .
A 259	Excessive load.	Perform RESET following the instructions. Check the quantity of the material in the sterilization chamber and make sure that it does not exceed the maximum allowed. (See the <i>Summary Table</i> in Appendix A, Technical Characteristics).
	Steam leaking through the gasket.	Perform RESET following the instructions. Carefully clean the gasket with a clean cotton cloth dampened with water and start the program again.
	Problem in the plumbing circuit.	Contact the Technical Support Department (see Appendix Z) .
A 260	Problem in the plumbing circuit.	Contact the Technical Support Department (see Appendix Z) .

CODE	POSSIBLE CAUSE	PROPOSED SOLUTION
HAZARDS (category H)		
H 150	Pressure sensor (MPX) broken.	Contact the Technical Support Department (see <u>Appendix Z</u>).
H 160	Incorrect connection of the pressure sensor (MPX) to the connector.	
	Pressure sensor (MPX) short circuit.	
H 400	Problem in the plumbing circuit.	
H 401	Problem in the plumbing circuit.	
H 402	Steam generator malfunction.	
	Problem in the plumbing circuit.	
H 403	Steam generator malfunction.	
	Problem in the plumbing circuit.	
H 404	Problem in the plumbing circuit.	
	Steam generator malfunction.	
H 405	Problem in the plumbing circuit.	
	Steam generator malfunction.	
H 406	Problem in the plumbing circuit.	
	Steam generator malfunction.	
H 410	Timer problem	
H 990	General operating problem.	
H 991	General operating problem.	
H 992	General operating problem.	

ELECTRICAL DIAGRAM (BOARD TYPE "T")

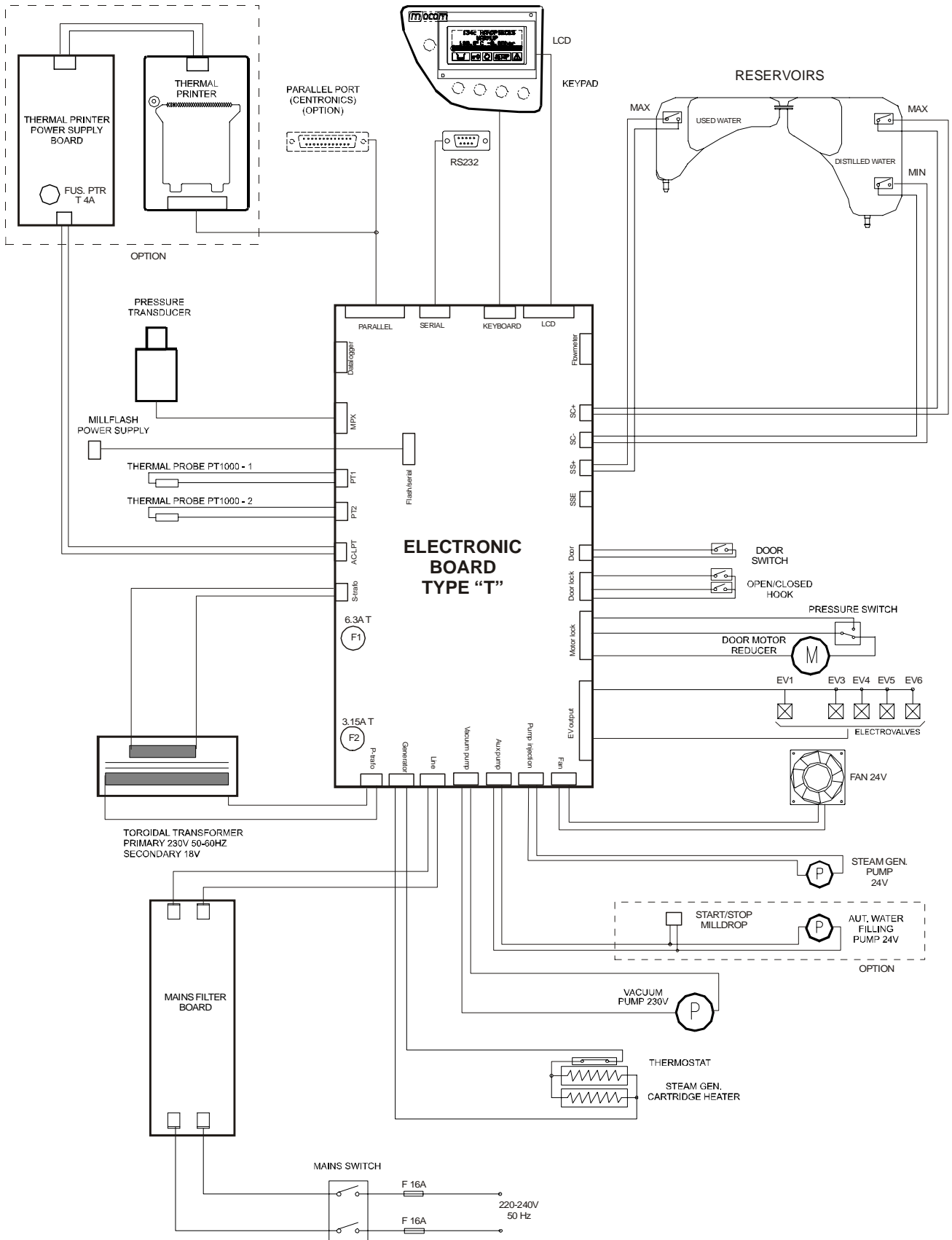

PLUMBING DIAGRAM

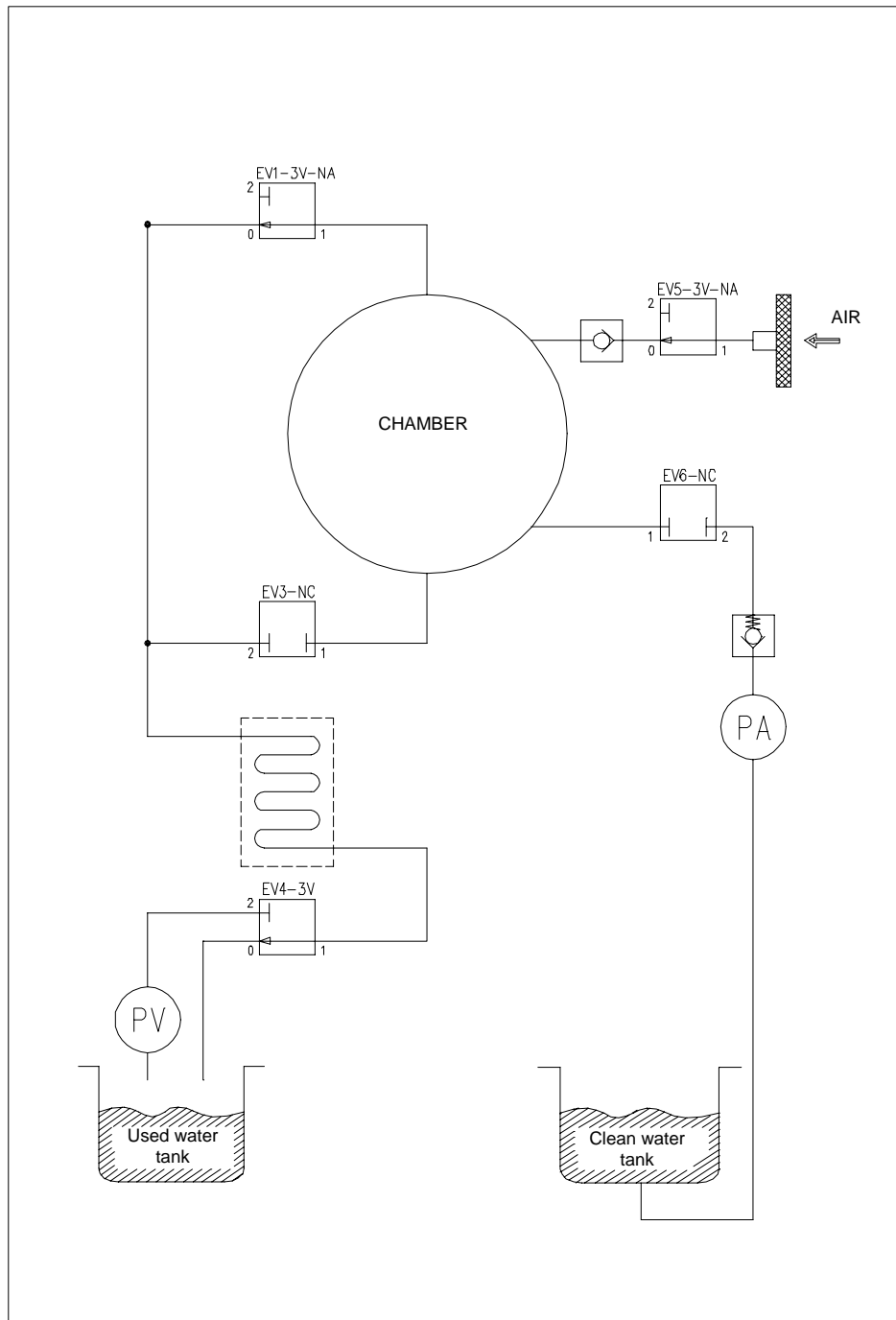



Sistemi innovativi di sterilizzazione

DECLARATION OF CONFORMITY

Application of Directives 93/42/CEE - 89/336/CEE - 73/23/CEE

Manufacturer's Name: **M.O.COM. S.r.l. - Manufacture of Dental Accessories**
Manufacturer's Address: **Via delle Azalee, 1 - 20090 Buccinasco (MI) - ITALY**
Product description: **Steam sterilizer**
Model: 
Constructed in: **ITALY**

The undersigned declares that the above material

conforms

to the EEC Directives 93/42 - 89/336 - 73/23 (and following updates).

Reference standards: EN 61010-1 EN 61010-1-A2 EN 61010-2-040
CEI EN 50081-1 CEI EN 50082-1
EN 55014 EN 55022 EN 60555-2 EN 60555-3
EN 61000-4-2 EN 61000-4-3 EN 61000-4-4 EN 61000-4-5
EN 61000-4-6 EN 61000-4-8 EN 61000-4-11 ENV 50204
EN 13060

31/05/2007

Date



Signature

Alfio VILLA
Name and SurnameLegal Representative
Function

**FOR ANY REQUEST FOR
TECHNICAL SERVICE FOR THE PRODUCT,
WHETHER IN OR OUT OF WARRANTY,
DIRECTLY CONTACT THE
TECHNICAL SUPPORT DEPARTMENT
OF THE DEALER OR RESELLER
THAT SUPPLIED THE PRODUCT.**

M.O.COM. Srl is available to customers to provide technical information about the product as well as to offer suggestions and advice on steam sterilization procedures.

In this regard, please refer to the following address:

M.O.COM. Srl
Customer Support
Via delle Azalee, 1
20090 Buccinasco (MI)
ITALY

Tel. (+39) 02-45701505
Fax (+39) 02-45701258
e-mail at@mocom.it
website www.mocom.it

To help us in the indispensable work of improving the quality of our products and service, please send your comments and/or suggestions to the following **e-mail** address:

uc@mocom.it (Commercial / Sales Department)

Or, you can send a **letter** or **fax** to the above address.

Thank you in advance for your valuable assistance.