

MITEL

# Communications Platforms



5360 IP Phone User Guide



Call us now 0800 316 7566



### **GENERAL NOTICE**

The information contained in this document is not warranted by Mitel Networks Corporation or any of its affiliates or subsidiaries ("Mitel") and is subject to change without notice. Mitel assumes no liability for any errors or omissions. This document may be reproduced, either wholly or in part, solely for distribution to authorized users of Mitel's products.

### **NOTICE TO DEALERS OR DISTRIBUTORS**

As the dealer or distributor, you assume responsibility for the content contained in this document. To signify responsibility, you must insert your company name in the one of the places indicated.

Mitel logos and wordmarks, along with legal disclaimers and copyright information, contained in these documents must NOT be removed.

Mitel provides this documents as is. No support is available from Mitel or its subsidiaries to assist the user with the modification, printing, distribution, or other processes pertaining to the use of these documents.

### **TRADEMARKS**

Mitel and Speak@Ease are trademarks of Mitel Networks Corporation.

Windows and Microsoft are trademarks of Microsoft Corporation.

Other product names mentioned in this document may be trademarks of their respective companies and are hereby acknowledged.

**Mitel 5360 IP Phone - User Guide  
August 2011**

® ,™ Trademark of Mitel Networks Corporation  
© Copyright 2011, Mitel Networks Corporation  
All rights reserved

---

**IMPORTANT! This phone is NOT suitable for direct connection to the public-switched telephone network. Connect the phone to a Mitel Networks system only.**

---

---

<b>ABOUT YOUR PHONE .....</b>	<b>1</b>
Elements of Your Phone .....	3
Ring/Message Indicators .....	4
For Users on Resilient 3300 ICP Systems .....	4
Mitel Line Interface Module .....	4
Using Your IP Phone with Mitel Unified Communicator Express .....	4
HTML Applications .....	5
Tips For Your Comfort And Safety .....	5
Don't Cradle the Handset! .....	5
Protect your Hearing .....	5
Adjust the Viewing Angle.....	5
<b>USING YOUR DEFAULT PHONE WINDOW .....</b>	<b>6</b>
Getting Started with Your Phone .....	6
5360 IP Phone Default Window .....	7
Gadget Sidebar on the 5360 IP Phone.....	8
<b>USING APPLICATIONS ON THE 5360 IP PHONE .....</b>	<b>9</b>
Accessing Your Phone Applications.....	10
Getting Help.....	10
Tips for Setting up Your Phone and Touch Screen .....	10
<b>CUSTOMIZING YOUR PHONE.....</b>	<b>11</b>
Using the Settings Application.....	11
Specify Language .....	12
Specify Text Size .....	12
Specify Call Notification Behavior.....	12
Adjust Display Brightness .....	13
Enable a Screen Saver .....	13
Calibrate the Display .....	14
Specify Audio Feedback Options .....	14
Enable Message Key .....	15

Enable PC Connectivity .....	15
Float Keys.....	15
Adjust the Ringer .....	15
Cleaning Your 5360 IP Phone.....	16
Text Entry .....	16
Text Entry Window .....	17
Keyboards .....	18
<b>SETTING UP YOUR CONTACT LIST.....</b>	<b>20</b>
Adding Names to Your Contact List .....	20
Editing Information in Your Contact List .....	20
<b>VISUAL VOICE MAIL.....</b>	<b>21</b>
Set Up your Mailbox.....	21
Enable Visual Voice Mail.....	21
Opening the Visual Voice Mail Application .....	21
Log Into Your Mailbox From Your Own Extension.....	22
Log Into Your Mailbox From Another Extension .....	22
Log Out Of Your Mailbox.....	23
About the Visual Voice Mail Main Window .....	23
Display Message Details.....	24
Play a Voice Message.....	26
Dial Message Sender.....	26
Save a Message .....	27
Delete a Message.....	27
Add a Message Sender to Your Contacts List.....	27
Forward a Message to Another Mailbox.....	28
Forward a Message to Your Email Address .....	28
<b>USING THE CALL HISTORY APPLICATION.....</b>	<b>29</b>
View Call Log Details .....	29
Review Call Log Icons.....	30

Delete Logs.....	30
<b>CALL FORWARDING .....</b>	<b>31</b>
Using Quick Call Forward Always .....	31
Programming Call Forwarding Defaults.....	32
<b>PROGRAMING FEATURES ON YOUR KEYS .....</b>	<b>33</b>
Tips on Programming Features.....	33
Features available for programming on programmable keys.....	33
Applications available for programming on programmable keys .....	35
Program Feature Keys Using the Settings Application .....	35
Clear Programming from a Key.....	37
<b>MAKING AND ANSWERING CALLS .....</b>	<b>38</b>
Dial from your People Application .....	38
Phone Book .....	38
Answer a Call.....	39
End a Call .....	39
Redial .....	39
Redial - Saved Number.....	40
Handsfree Operation.....	40
Auto-Answer .....	41
Using the Analog line .....	41
<b>CALL HANDLING .....</b>	<b>42</b>
Hold .....	42
Mute.....	42
Transfer .....	43
Conference .....	43
Conference Split .....	43
Add Held.....	44
Swap.....	44

<b>USING OTHER FEATURES.....</b>	<b>45</b>
Account Codes.....	45
ACD.....	45
Attendant Call Hold - Remote Retrieve .....	46
Callback.....	46
Call Forward - Remote (I'm Here) .....	46
Call Forward - End Chaining.....	47
Call Forward - Forced .....	47
Call Forward - Override.....	48
Call Park .....	48
Call Pickup.....	49
Campon.....	49
Direct Paging .....	50
Direct Paging - Handsfree Answerback Enabled.....	50
Direct Paging - Handsfree Answerback Disabled.....	52
Direct Voice Call .....	53
Do Not Disturb .....	53
Emergency Calls.....	54
Emergency Calls When Emergency Call Routing Not Programmed.....	54
Emergency Calls When Emergency Call Routing Programmed.....	54
Float Keys.....	55
Programming Float Keys.....	56
Using Float Keys .....	57
Group Listen .....	57
Group Paging / Meet Me Answer .....	58
Group Presence.....	59
Handoff - Personal Ring Groups .....	60
Headset Operation.....	61
Hot Desking .....	62
Hot Desk Remote Logout.....	63
Hot Desk - PIN Change.....	63
Make Busy.....	64

Message Waiting Indicator .....	64
Messaging - Advisory .....	64
Messaging - Callback .....	65
Messaging - Cancel Callback .....	66
Messaging - Cancel All Callbacks .....	66
Music .....	66
Night Answer .....	67
Override (Intrude) .....	67
Paging .....	67
Phone Lock .....	68
User PIN .....	69
Record a Call .....	70
Reminder .....	71
Speak@Ease .....	72
Speed Call .....	72
Contact Presence .....	72
Tag Call .....	73
Trunk Flash .....	73
<b>USING YOUR PHONE WITH THE 5310 IP CONFERENCE UNIT .....</b>	<b>74</b>
Access the Conference Controller .....	74
Turn the Conference Unit On and Off .....	74
Adjust the Conference Unit Volume .....	74
Place the Conference Unit in Presentation Mode .....	74
Exit the Conference Controller .....	75
Mute the Conference Unit .....	75
<b>USING THE LINE INTERFACE MODULE .....</b>	<b>76</b>
Making and Answering Calls Using the Analog key .....	76
Making and Answering Calls Using the Failover Mode .....	77

**USING YOUR PHONE WITH THE CORDLESS MODULE AND ACCESSORIES . 78**

Elements of Your Cordless Module and Accessories .....	79
Handset/Headset Combinations.....	80
Pairing the Cordless Module and Accessories .....	80
Pairing a DECT Cordless Accessory with a DECT Cordless Module .....	80
Pairing a Bluetooth Accessory with a Bluetooth Module.....	81
Unpairing an Accessory .....	82
Cordless Module LED Indicators.....	82
Using a Cordless Device as a Remote Control.....	82
Using the Mute Key on a Cordless Device .....	83
Using the Volume Keys on Cordless Device .....	83

**USING THE MITEL CORDLESS HANDSET ..... 84**

Elements of the Cordless Handset.....	84
Answer a Call.....	85
Hang up .....	85
Dialing – Auto Dial Disabled.....	85
Dialing – Auto Dial Enabled.....	85
Handset Alerting Tones and LEDs .....	86

**USING THE MITEL DECT CORDLESS HEADSET ..... 87**

Answer a Call.....	87
Hang Up.....	88
Dialing – Auto Dial Disabled.....	88
Dialing – Auto Dial Enabled.....	88
Headset Alerting Tones and LEDs .....	88

**USING A BLUETOOTH HEADSET..... 90**

Answer a Call.....	90
Hang Up.....	90
Dialing – Auto Dial Disabled.....	90
Dialing – Auto Dial Enabled.....	91



**USING THE CORDLESS DEVICES APPLICATION..... 92**

Low Battery Level .....92

Viewing Cordless Module Information .....92

Enabling/Disabling Auto-Connect on a Bluetooth Headset .....93

Connecting/Disconnecting a Bluetooth Headset.....93

Editing a Bluetooth Headset Name .....93

Auto Dial .....94



## ABOUT YOUR PHONE

The 5360 IP Phone is a high-end color phone with a touch display that delivers graphically rich applications. It is a full-feature enterprise-class phone that provides a large color backlit graphics display with 48 programmable self-labeling keys, six intuitive call state sensitive softkeys, superior sound quality, and a built-in HTML toolkit for desktop applications development.











Equipped with a Gadget Sidebar, the seven-inch display enables one-touch access to embedded or internet-based content and applications. The Gadget Sidebar provides you with a quick launch tool for embedded applications as well as HTML applications.

The 5360 IP Phone is compatible with the Mitel 3300 IP Communications Platform (ICP). The 5360 IP Phone is ideal for any enterprise executive or manager, Teleworker, and Contact Center supervisor. The 5360 IP Phone supports Mitel Call Control (MiNet) protocol only.



The 5360 IP Phone

## Elements of Your Phone

Feature	Function
1) Display	<p>Provides a large, high-resolution touch screen that assists you in selecting and using phone features and applications.</p> <p>The display area provides 48 self-labeling buttons that can be programmed as speed call keys, fixed function keys, hard keys, applications, or line appearance keys, according to your communication needs. On your home page, the bottom right feature key is always your Prime Line key.</p>
2) Ring/Message Indicator	Flashes to signal an incoming call and to indicate a message waiting in your voice mailbox.
3) Volume, Speaker and Mute Controls	<p>Provide the following audio control capability:</p> <ul style="list-style-type: none"> <li> (<b>UP</b>) and  (<b>DOWN</b>) provide volume control for the ringer, handset, and handsfree speakers.</li> <li> (<b>SPEAKER</b>) enables and disables Handsfree mode.</li> <li> (<b>MUTE</b>) enables Mute, which allows you to temporarily turn your phone's handset, headset or handsfree microphone off during a call.</li> </ul>
4) Fixed Function Keys	<p>Give you access to the following phone functions:</p> <ul style="list-style-type: none"> <li> (<b>APPLICATIONS</b>): provides access to menus for your phone's applications and settings.</li> <li> (<b>CANCEL</b>): ends a call when pressed during the call, and, when you are programming the phone, eliminates any input and returns to the previous menu level.</li> <li> (<b>REDIAL</b>): calls the last number dialed.</li> <li> (<b>HOLD</b>): places the current call on hold.</li> <li> (<b>TRANS/CONF</b>): initiates a call transfer or establishes a three-party conference call.</li> <li> (<b>MESSAGE</b>): provides access to your voice mailbox and flashes to notify you of messages waiting in your voice mailbox. Note: The Ring/Message indicator also flashes when messages are waiting.</li> </ul>
5) Keypad	Use to dial.
6) Gadget Sidebar	Provides up to nine quick launch icons that allow you to quickly navigate to any application (including the Phone/Home icon).
7) Navigation Page Keys and Context Icon	Use navigation keys to display additional pages of information. There are two page navigation keys: Back and Next. Additionally, a context icon shows the application in use.
8) Handsfree Speaker	Provides sound for Handsfree calls and background music.
9) Handset	Use for handset calls. If you are in headset or handsfree mode, you do not need to use the handset.

## Ring/Message Indicators

When indicator is	it means that
Flashing rapidly	Your phone is ringing
Flashing slowly	A message or callback message is waiting at your phone
On	Your phone is ringing another phone
Off	Your phone is idle, or you are on a call

## For Users on Resilient 3300 ICP Systems

If during a call, you hear a beep repeated every 20 seconds it means that your phone is switching to a secondary 3300 ICP system. The call continues and there is a change in the operation of some keys and features on your phone. Normal operation resumes when your phone switches back to the primary system. If your phone is idle and switched to the secondary system, you'll see a flashing rectangle on the display. The rectangle remains until the switch to the primary system is complete.

If the phone fails over to the secondary ICP, you have access to your mailbox on the secondary ICP only if your Administrator has programmed a mailbox for you.



### Notes:

- The mailbox on the secondary ICP will not contain the same messages as the mailboxes on the primary ICP. Any preferences that are voice mail related are not carried from the primary ICP to the secondary ICP. These preferences must be set on both ICPs.
- The People and Settings applications do not support resiliency. Your logs, contact information and any Settings on the primary ICP will not be carried from the primary ICP to the secondary ICP.

## Mitel Line Interface Module

The Line Interface module is an optional device that adds an analog phone line (POTS) capability to your phone. If Emergency Call Routing is not programmed on your 3300 ICP, you must use the Line Interface Module to dial emergency calls. For more information on emergency number dialing, see [Emergency Calls](#). If you have a Line Interface Module connected to your phone, all programming of the Line Interface Module, except the Analog Key, is done by the Installer when your phone is installed. For more information, refer to [Programming Features on Your Keys](#) and [Using the Line Interface Module](#).

## Using Your IP Phone with Mitel Unified Communicator Express

When used with Unified Communicator® Express or Unified Communicator Advanced applications, the 5360 IP Phone becomes a powerful communications tool that helps customers streamline communications between people and organizations. This leads to improved productivity, enhanced customer service, reduced costs, and ultimately improved business process integration. See the appropriate user guide at <http://edocs.mitel.com> for details.

## HTML Applications

Your 5360 IP Phone may have HTML Applications available for your customized use. The HTML Desktop Toolkit enables simple, intuitive development of customized applications that are easily integrated with telephony functions of your 5360 IP Phone.

## Tips For Your Comfort And Safety

### Don't Cradle the Handset!

Prolonged use of the handset can lead to neck, shoulder, or back discomfort, especially if you cradle the handset between your ear and shoulder. If you use your phone a lot, you may find it more comfortable to use a headset. See the section on headset usage elsewhere in this guide for more information.

### Protect your Hearing

Your phone has a control for adjusting the volume of the handset receiver or headset. Because continuous exposure to loud sounds can contribute to hearing loss, keep the volume at a moderate level.

### Adjust the Viewing Angle

The stand built into your phone tilts to give you a better view of the keys.

#### To tilt your phone for better viewing:

1. Turn the phone so that the front faces away from you.
2. Hold the base unit firmly and press the release tabs on the sides of the stand to detach the base unit.
3. Hinge the hooks of the base unit into the notches on the back of the phone and snap into place as follows:
  - a. For a high-angle mount, hinge the two lower hooks into the bottom set of notches and snap the two upper hooks into the middle set of notches.
  - b. For a low-angle mount, hinge the two lower hooks into the middle set of notches and snap the two upper hooks into the top set of notches.

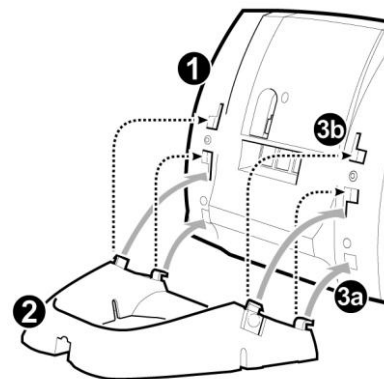

## USING YOUR DEFAULT PHONE WINDOW

The 5360 IP Phone default phone window and Gadget Sidebar are shown and described below. The Phone window provides access to programmable keys and the main phone interface.

### Getting Started with Your Phone







When you receive your phone, you may need to program features and applications. Press the blue **Applications** key  to access your phone's applications. You can then program your phone's settings, your contact list using People, Call Forwarding and so forth. See [Using Applications On The 5360 IP Phone](#).



**5360 IP Phone Window**



## 5360 IP Phone Default Window

Feature	Function
1) Status Bar	<p>Displays time, date, and icons indicating feature states as follows:</p> <ul style="list-style-type: none"> <li>• <b>Call History</b> (  ) – Indicates new missed calls</li> <li>• <b>Call Forward Always On</b> (  ) – Indicates Call Forward Always is activated.</li> <li>• <b>Message Waiting</b> (  ) - Indicates new voice mail.</li> <li>• <b>Headset</b> (  ) - Indicates that the phone is in headset mode.</li> <li>• <b>DND</b> (  ) - Indicates DND (Do not disturb) mode.</li> <li>• <b>Logged in as</b> (  ) - Indicates that a hot desk user is logged in.</li> <li>• <b>Conference Unit</b> (  ) - Indicates that the 5310 Conference Unit is connected and turned on.</li> </ul>
2) Information Display/User Prompt Area	Provides prompts in most phone applications. Content changes based on the application.
3) Control Area/Softkeys	Allow you to access specific call control features, which are context sensitive. These are non-programmable feature keys, which are specific to the application or state of the set. The 5360 IP Phone provides six softkeys or eight softkeys, depending on the application.
4) Programmable Keys	<p>Provides 48 self-labeling keys that can be programmed as speed call keys, fixed function keys, hard keys, applications, or line appearance keys. For instructions on programming the keys, see <a href="#">Programming Features on Your Keys</a>.</p> <p>This dynamic area is also used for displaying components based on the applications being used, including a QWERTY keyboard.</p>
5) Navigation Page Keys (Footer)	<p>Shows context and summary information based on information in the Programmable Keys area, such as Page Indicators, numbers of items, and so forth.</p> <p>Navigation keys display additional pages of information. There are two page navigation keys: <b>Back</b> and <b>Next</b>.</p>
6) Gadget Sidebar	Provides up to nine quick launch icons that allow you to quickly navigate to any application (including the Phone/Home icon). See <a href="#">Gadget Sidebar on the 5360 IP Phone</a> .

## Gadget Sidebar on the 5360 IP Phone

The Gadget Sidebar is a vertical bar that runs down the right side of the 5360 IP Phone’s display. The Gadget Sidebar contains a series of icons that provide one-touch access to the most commonly accessed phone applications and features, including HTML applications. The Gadget Sidebar is designed to accommodate up to nine quick launch icons, including the Phone icon, which always returns you to the main phone screen. The Gadget Sidebar consists of the following icons for applications:

- Call History
- Visual Voicemail
- People
- Call Forwarding
- Help
- Backlight/Light bulb (for turning off the backlight)
- Phone/Home







Gadget sidebar



Phone (Home) icon always at the bottom and separated from the rest of the icons.

A frame appears around a gadget icon when the icon is selected.

## USING APPLICATIONS ON THE 5360 IP PHONE

Your 5360 IP Phone provides applications that simplify the use of your phone. This table describes the applications that you may have on your 5360 IP Phone. The associated icon appears on the Gadget Sidebar or as a context icon in the navigation area. Simply touch the Gadget Sidebar icon to open the application.

Applications/Icons	Function
 Call History	Use the Call History application to display lists of the calls that you have missed, made, and answered. This feature allows you to filter the call records and display information on each call on the list. See <a href="#">Using the Call History Application</a> for more information.
 Voice Mail	Use the Voice Mail application to login and logout of voicemail boxes, and review messages. You can login to your own mailbox or login as a guest to another directory number's mailbox. See <a href="#">VISUAL VOICE MAIL</a> for more information.
 People/Contact List	Use the <i>People</i> application to add, delete and edit contact names and numbers. You can also dial anyone on your contact list from the <i>People</i> application. The People window displays up to eight contacts per page, ordered alphabetically by last name. For information on using the <i>People</i> application, refer to <a href="#">Setting Up Your Contact List</a> and <a href="#">Dial From Your People Application</a> .
 Call Forwarding	Use the <i>Call Forwarding</i> application to quickly set Call Forward Always. The Call Forwarding window shows your current Call Forwarding settings and provides access to change the default settings. See <a href="#">Call Forward</a> for more information on how to add, edit, delete, and activate Call Forwarding settings.
 Conference Unit	Use the <i>Conference Unit</i> application to control the 5310 IP Conference Unit. Use this application to turn the conference unit off or on, to adjust the volume, or to put the conference unit into Presentation mode. You can only run one Conference Controller session at a time. The <i>Conference Unit</i> application is available only when your phone is connected to a 5310 Conference Unit. See <a href="#">Using Your Phone with the 5310 Conference Unit</a> for more information.
 Backlight On/Off	Turns the backlight off.
 HTML Apps	Provides access to customer-developed HTML applications. A different icon may be provided by the HTML application.
 Phone/Home	Press the Home icon to bring you back to the main Phone/Home window.
 Cordless Device	Use the Cordless Devices application to configure and view status of cordless accessories. See <a href="#">Using the Cordless Module</a> for more information.

Applications/Icons	Function
 Settings	Use the <i>Settings</i> application to display and quickly change your phone's current communications settings. See <a href="#">Using the Settings Application</a> for more information.
 Help	Provides access to Quick Help and displays a list of the key icons, if Help is available on your phone.
 Clean Mode	Provides access to the Clean Mode application that allows the touch screen to be cleaned without activating any features.

## Accessing Your Phone Applications

To open the *Applications* window, press the blue **Applications** key . The *Applications* home window gives the current list of your phone's applications.

To open an application, touch the specific application icon on the Gadget Sidebar or touch the application name on the display.

For information on programming features and applications, see [Programming Features On Your Keys](#).

## Getting Help

**To access the 5360 IP Phone Help and documentation:**

- Press 

## Tips for Setting up Your Phone and Touch Screen

- After you receive your 5360 IP Phone, use the options in the *Settings* application to customize your phone.
- Calibrate your display for maximum touch accuracy. You may also want to turn on the button beep to receive an audible tone that indicates you have engaged the button or icon. See [Specify Audio Feedback Options](#) and [Calibrate the Display](#).

## CUSTOMIZING YOUR PHONE

Use the *Settings* application to customize your phone.



**Note:** The System Administrator can invoke a Lock Default Configuration option on a per-phone basis. When this is in effect, the system administrator sets the settings for Programmable Keys and you cannot change them.

### Using the Settings Application

The *Settings* application provides a single location to access all your phone settings. Select any of the options below to access a window where you can view and configure settings for your phone.



**Note:** You can access *Settings* by pressing the blue **Applications** key , and then **Settings**.

The Settings window provides the following:

- **Programmable Keys:** Use to assign features or applications to the Programmable Keys that are available in the *Phone* application.
- **Languages:** Allows you to select the language in which phone prompts and applications appear. Supported languages are English, French, Spanish, German, Dutch, Italian, and Portuguese. **Note:** The system can support up to three languages at one time. Language choices appearing in the phone display are controlled by ICP programming.
- **Text Size:** Allows you to specify the font size (large or small) for the 5360 IP Phone.
- **Call Notification:** Use to specify the *Phone* application behavior when incoming or outgoing calls occur.
- **Brightness:** Allows you to adjust the display brightness of your phone.
- **Screen Saver:** Sets a specific time of inactivity on your phone that triggers the screen to dim and a screen saver to display.
- **Audio Feedback:** This setting allows you to adjust the volume of the audio feedback as well as the error beeps, and enable or disable the setting.
- **Message Key Configuration:** Allows you to configure the Message  key.
- **PC Connectivity:** Allows you to enter a password that is used by the phone to establish communications with the PC-resident Unified Communicator (UC) Express application.
- **Float Keys:** Allows you to enable or disable up to three float keys. Float keys are typically used to display unanswered ringing lines on designated keys where the ringing lines would otherwise be hidden on one of the phone's application pages.
- **Calibrate Display:** Allows you to calibrate the touch display for optimum touch sensitivity.
- **AutoDial** (if Cordless Module installed): Automatically dials the configured Auto Dial number.
- **About 5360 IP Phone:** This screen displays the software release.

## Specify Language

**To specify the language in which prompts and applications display:**

1. Press the blue **Applications** key .
2. Press **Settings**.
3. Press **Languages**.  
The phone displays the three language selections that are currently programmed in the ICP.
4. Select the appropriate language and press **Save**.  
The phone displays your chosen language.



**Note:** Languages supported on the 5360 IP Phone may differ from those supported on the ICP. If the phone is configured for an unsupported language, the prompts may appear in your selected language but the Application language for the phone defaults to English. The Language window displays "(name of the selected language)(Unsupported)".

## Specify Text Size

**To specify the text size that displays on the phone:**

1. Press the blue **Applications** key .
2. Press **Settings**.
3. Press **Text Size**.
4. Select **Large Text** or **Small Text**.
5. Press **Save**.

## Specify Call Notification Behavior

**To specify that the *Phone* window automatically displays when you are making or receiving calls:**

1. Press the blue **Applications** key .
2. Press **Settings**.
3. Press **Call Notification**.
4. Press the appropriate options to identify when you want the Phone window to display. For example, if you select the Made option, each time the phone goes off hook to make a call, the Phone window is displayed.
5. Press **Save**.

**Notes:**

- Press **Cancel** at any time to exit this application without making any changes.
- When the *Conference Unit* application is displayed, the *Phone* application is not automatically displayed when making or receiving calls.

## Adjust Display Brightness

**To adjust the display brightness use the *Settings* application:**

1. Press the blue **Applications** key .
2. Press **Settings**.
3. Press **Brightness**.
4. Press the **+** or **-** keys to adjust the brightness of your screen.
5. Press **Save**.



**Note:** Press **Cancel** at any time to exit this application without making any changes.

## Enable a Screen Saver

You can program your screen saver to turn on after a specific time period of inactivity on your phone.

**To enable a screen saver:**

1. Press the blue **Applications** key .
2. Press **Settings**.
3. Press **Screen Saver**.
4. Select the inactivity time, which will activate the backlight switch to dim.
5. Press the checkbox opposite **Display image** if you wish the screen saver to be displayed. If you do not press this checkbox, only the set backlight is dimmed.
6. Use the Brightness options to adjust the Brightness of the screen saver, if necessary.
7. Press **Save**.

## Calibrate the Display

**To calibrate the phone screen for touch accuracy:**





1. Press the blue **Applications** key .
2. Press **Settings**.
3. Press **Calibrate Display**.
4. Touch the center of each **+** to calibrate the display.

## Specify Audio Feedback Options

The error beep volume in the phone is related to the volume of the speaker. You can set the beep volume using this procedure; however, adjusting the speaker volume also affects the beep volume.

**To adjust the volume of the audio feedback:**

1. Press the blue **Applications** key .
2. Press **Settings**.
3. Press **Audio Feedback**.
4. Set the options using the appropriate actions described below:

Option	Action
Turn audio feedback off for errors Turn button beep off	Press  Red indicates it's been turned off. 
Adjust audio for error beeps or button beeps	Press  or 
Turn audio feedback on for errors Turn button beep on	Press  to enable it.

5. Click **Save**.



**Note:** Press **Cancel** at any time to exit this application without making any changes.



## Enable Message Key

**To enable the Message Key for voicemail:**

1. Press the blue **Applications** key .
2. Press **Settings**.
3. Press **Message Key Config**.
4. Enable the Open Voicemail App.

## Enable PC Connectivity

**To enable a connection to be set up between your phone and the Unified Communicator (UC) Express Application:**

1. Press the blue **Applications** key .
2. Press **Settings**.
3. Press **PC Connectivity**.
4. Press the checkbox **Enable**.
5. Press **Edit Password** and enter a password.
6. Press **OK**, and then press **Save**.



**Note:** You can use the UC Express for easy PC-based programming of the labels on your phone.

For more information on setting up the UC Express Application, refer to the *Unified Communicator Express User's Guide* on <http://edocs.mitel.com>.



## Float Keys

Float keys are typically used to display unanswered ringing lines on designated keys where the ringing lines would otherwise be hidden on one of the phone's application pages. See [Float Keys](#) for more information.

## Adjust the Ringer

**To adjust the Ringer Volume while the phone is idle:**

1. Press **Superkey** (must be programmed to a key).
2. Press the **No** softkey until "**Ringer Adjust?**" appears.
3. Press "**Ring Adjust**".

4. Press **No**.
5. Press “**Ringer Vol**”.
6. Press  (**UP**) or  (**DOWN**) on your phone.
7. Press **Superkey**.



**Note:** Adjusting ringer volume also adjusts cordless headset/handset ringer tone.



#### **To adjust the Ringer Volume while the phone is ringing:**

- Press  (**UP**) or  (**DOWN**).



**Note:** If the phone is in talk state, this action adjusts the volume of the handset, headset or speaker.

#### **To adjust the Ringer Pitch while the phone is idle:**

1. Press **Superkey** (must be programmed to a key).
2. Press the **No** softkey until “**Ringer Adjust?**” appears.
3. Press “**Ring Adjust**”.
4. Press “**Ringer Pitch**”.
5. Press  (**UP**) or  (**DOWN**) on your phone.
6. Press **Superkey**.

## Cleaning Your 5360 IP Phone

You can wipe clean the touch screen of your 5360 IP Phone without causing touch-sensitive controls to be activated.

1. Launch Applications.
2. Press **Clean Mode**.
3. Clean the screen of your phone.
4. Press the blue **Applications** key  to end Clean Mode.

## Text Entry

The Text Entry feature provides a standard set of windows used by all applications for accepting user-entered text and numeric data. The Text Entry window opens when an application requires text input.

The following applications use Text Entry:

- Settings application – Programmable Key labels

- People application – names and phone numbers

## Text Entry Window

The Text Entry window remains open during calls and other activities (see diagram below). For example, if you are entering the text of a Programmable Key label in the Settings application, and you receive an incoming call, the Text Entry's window will remain open even though it is hidden. When you eventually re-display Settings, the edit window reappears in the same state as when Settings was hidden.

The user interface consists essentially of

- An Input Area that displays up to a maximum of two lines of text.
- Text manipulation Control Keys, such as cursor right, cursor left, backspace, clear, and delete digit.
- Control Keys for saving and canceling the user's input
- Keyboard
- Navigation Keys

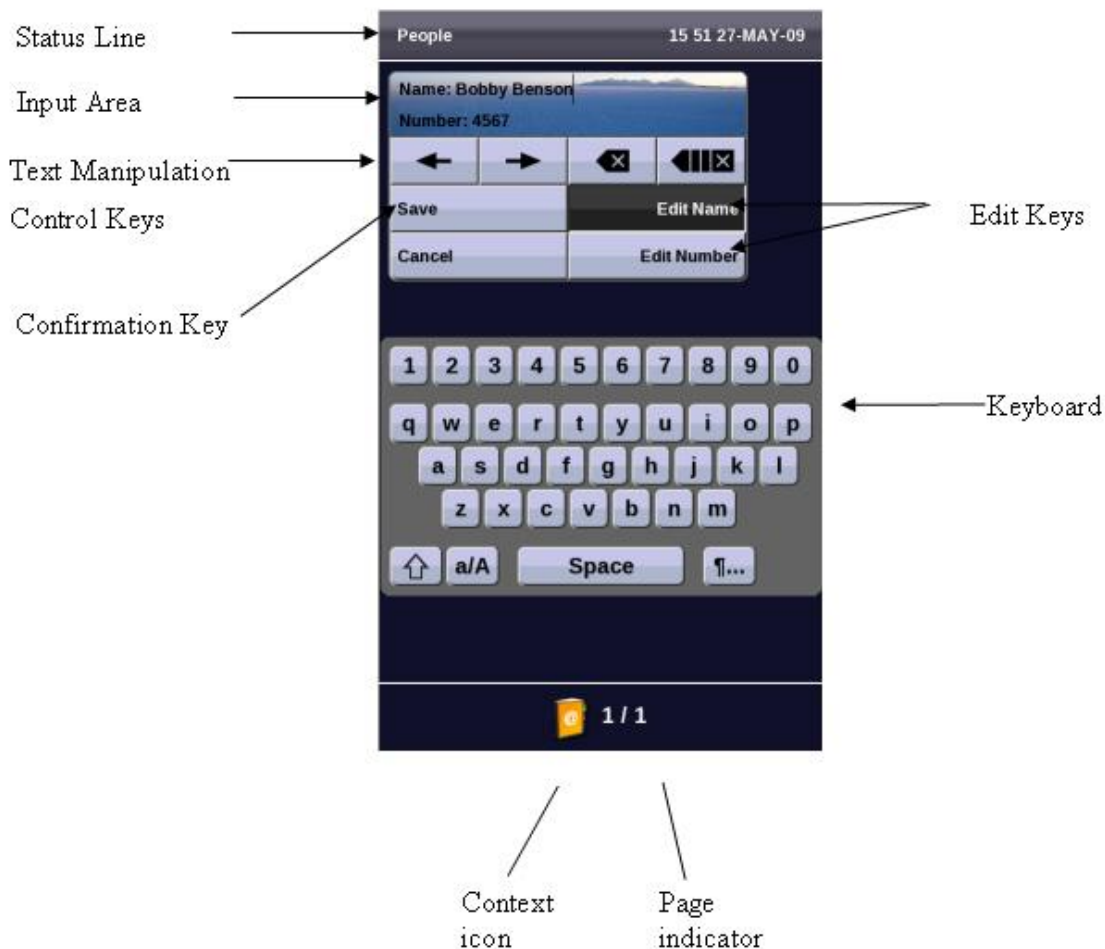

### Status Line

The Text Entry window's Status Line displays either a text string or the time and date and this depends on the application that requires text entry.

### Input Area

The Input area lets you see the text as you enter it, either in the name or number field.

### Text Manipulation Control Keys

The text manipulation control keys provided in the Text Entry window are Cursor Left, Cursor Right, Backspace, Clear, and Delete Digit.

To use these control keys, an Input Field must be selected.

The Cursor Left () and Cursor Right () keys move the cursor left and right, respectively, in the Input Field without deleting characters.

The Backspace () key removes the character to the left of the cursor in the Input Field.

The Clear () key removes all characters from the Input Field.

The Delete Digit () key deletes a character to the right of the cursor in the Input Field. If there is no character following the cursor the Backspace key is ignored.



**Note:** In some applications a Delete Digit key will be displayed instead of the Clear key.

### Keyboards

Two keyboard interfaces are provided for Text Entry: a numeric keyboard interface and an alphanumeric keyboard as described below.

#### Alphanumeric Keyboard

The alphanumeric keyboard consists of thirty-six character keys, space and three control keys. The thirty-six character keys can be shifted case to provide thirty-six additional characters, providing a total of seventy-three different characters for data input.



The character set includes the Space key, the numbers 0 through 9, the letters of the English language in both lowercase and uppercase and a subset of other Unicode characters which would be similar to the ASCII characters provided on a typical PC keyboard.

The Alphanumeric keyboard has four Character Keys views; only one view can be displayed at a time.

- **Default view:** This view consists of the lowercase version of the letters and numbers.
- **Shifted Default view:** This view consists of the uppercase version of the letters and the supported Unicode characters.
- **Caps view:** This view consists of the uppercase version of the letters and regular numbers.
- **Shifted Caps view:** This view consists of the lowercase version of the letters and the supported Unicode characters.
- **Special Character view:** This view consists of the supported symbols and the supported accented characters. Unlike the three views above, this view has a matrix layout and consists of more than one page of characters.

### *Numeric Keyboard*

The numeric keyboard interface is used when the Input Field requires phone numbers or other numerical input. The numeric keyboard provides nineteen character keys that represent the standard dial pad on a phone: the numbers 0 through 9, the \* key and the # key. The numbers appear as they would on a typical telephony dial pad. The seven remaining character keys include the Space key, -, +, (, ), Pause and Flash.



**Note:** Some of the last seven character keys may not be displayed if the host application does not require them. .

Pressing a character key adds the character associated with the key to the left of the cursor in the input field. The Pause and Flash character keys will appear as P and F, respectively, in the input field.



**Numeric Keyboard**

Some input buttons will not be available in some applications depending on the input required.

The keypad normally used for dialing calls can be used to enter numbers when the numeric keyboard is displayed.

## SETTING UP YOUR CONTACT LIST

Use the *People* application  to set up your contact list.

### Adding Names to Your Contact List

You can add a name to your contact list by entering it directly using the *People* application or by copying a number using the To People from Call Info, Visual Voice Mail and Call History.

**To add a name to your contact list using the *People* application:**

1. Open the People application. 
2. Press **New**.
3. Enter the name using the on-screen keyboard and press the appropriate letters to spell the first name of your contact.
4. Press **Edit Number** and using the on-screen numeric keyboard or the keypad, enter the number.
5. Press **Save**.
6. Press **Close**.

### Editing Information in Your Contact List

1. Open the People application. 
2. Press the name you wish to edit.  
**Note:** If you wish to delete the name from your contact list, press **Delete**.
3. Press **Edit ...**.
4. In the on-screen keyboard, update the appropriate information for the name.
5. Press **Edit Number** and using the on-screen numeric keyboard or keypad, edit the number.
6. Press **Save**.
7. Press **Close**.

## VISUAL VOICE MAIL

Use the Visual Voice Mail application  to manage and listen to voice mail messages.

### Set Up your Mailbox

Before you can use voice mail, you must first set up your mailbox.

#### To set up your mailbox:

1. Dial the voice mail Hunt Group number provided by your system administrator.
2. Follow the verbal instructions to create your personal passcode and to record your name and greeting.
3. Set up Call Forwarding to direct your calls to the voice mail hunt group number.

### Enable Visual Voice Mail

#### To enable Visual Voice Mail:

1. Press the blue **Applications** key .
2. Press **Settings**.
3. Press **Message Key Config**.
4. Select **Open Voice Mail App**.
5. Press **Save**.

### Opening the Visual Voice Mail Application

You can open the *Visual Voice Mail* application by pressing the Voice Mail icon  from the Gadget Sidebar.

You can also open the *Visual Voice Mail* application by selecting it in the *Application* list or by using the *Settings* application to program a key (either a feature key or the Message key,  to open it. See [Program Feature Keys Using the Settings Application](#).

 **Note:** You must log out of Visual Voice Mail before you can access your voice mailbox from the dialpad.

## Log Into Your Mailbox From Your Own Extension

**To login to your mailbox from your extension:**

1. Open the Voice mail application. 



**Note:** The mailbox number assigned to the prime extension of this phone is displayed. If this is not your mailbox number, see [Log into your mailbox from another extension](#). If there is no mailbox associated with the phone's primary DN, the voice mail application displays the Guest Mailbox. In this case, see [Log into your mailbox from another extension](#).

2. Enter your passcode.
3. If you wish to have the system remember this passcode, press **Remember my passcode** to enable the check box ()
4. Press **Login**.



**Note:** While you are logged into your mailbox, no indication of any new messages arriving is provided until you log out and log in again.

## Log Into Your Mailbox From Another Extension

**To login to your mailbox from another extension:**

1. Open the Voice mail application. 
2. Press **Connect as Guest**.
3. Enter your mailbox number.
4. Press **Enter Passcode**.
5. Enter your passcode.
6. Press **Login**.



**Note:** If you wish to return to the owner login window, press **Connect** as owner at any time.



## Log Out Of Your Mailbox

### To logout of your mailbox:

- Press **Logout**. This closes the *Voice Mail* application.



**Note:** After five minutes of inactivity, you are automatically logged out of your mailbox and the Voice Mail application closes. When you close the Voice Mail application, you are not automatically logged out of your mailbox.





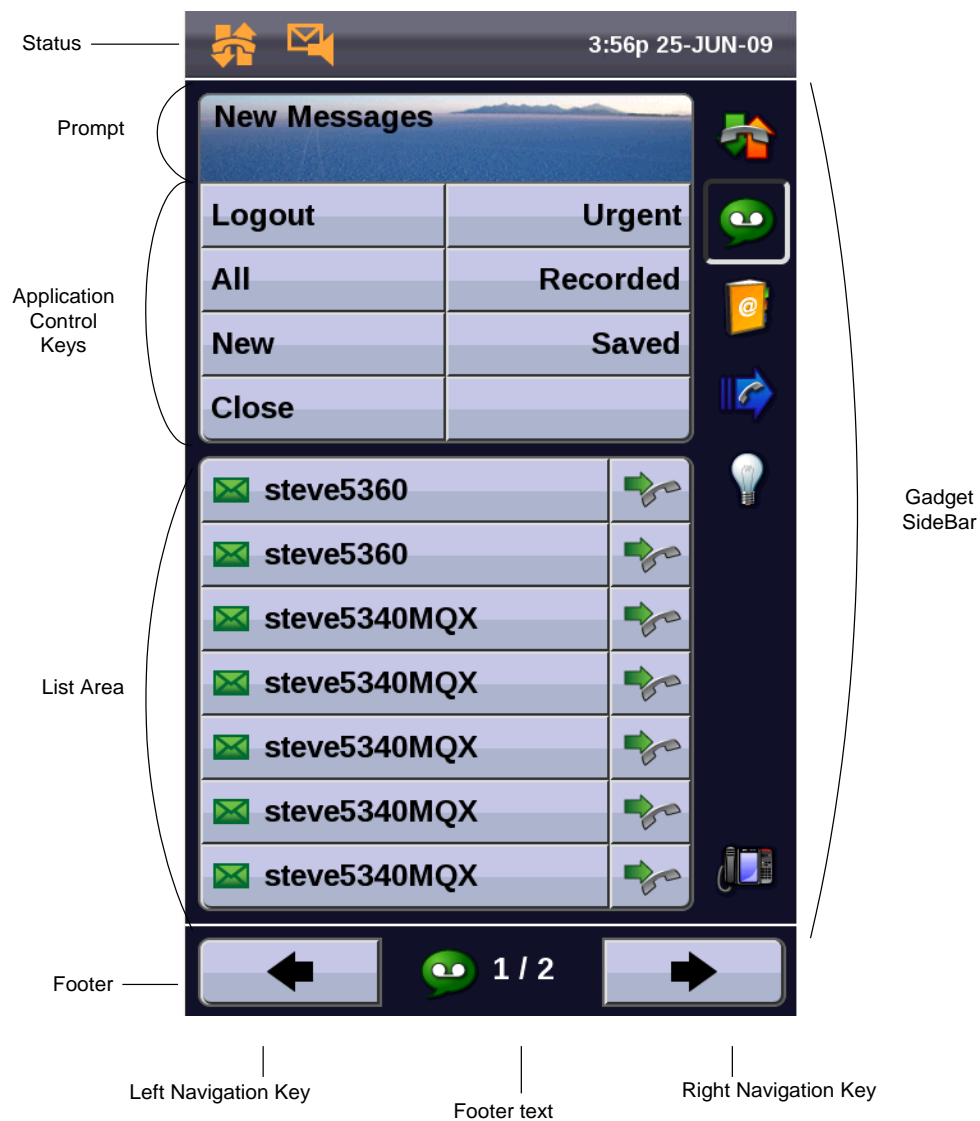



## About the Visual Voice Mail Main Window

The diagram below illustrates the main voice mail window.



**The Voice Mail Application Main Window**

The Voice Mail application main window contains a reverse chronological list of the voice messages in your mailbox, with the newest message listed first. Use the Navigation keys to scroll through the messages. By default, only new messages are listed when the main screen opens. You sort the list by message type using the sorting keys (All, New, Urgent, Recorded, Saved) in Control keys area. Messages are marked in the following ways:

Icon	Type of Message
	New (never played)
	New Confidential
	New Urgent
	New Confidential Urgent
	Saved
	Saved Confidential
	Saved Urgent
	Saved Confidential Urgent
	Recorded calls recorded using the Record A Call feature



**Note:** Confidential messages cannot be forwarded.

## Display Message Details

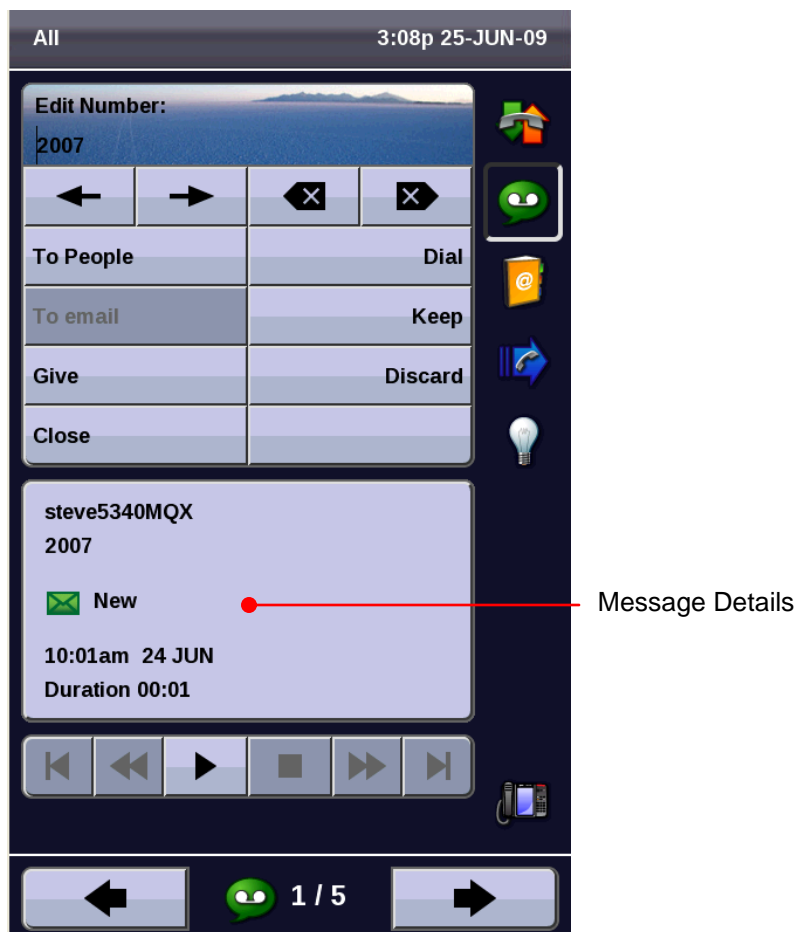

**To display details about a message:**

1. Open the Voice mail application. 
2. Login to your mailbox.
3. Press on a message in your message list. The Message Details window displays showing the following information about your message:
  - Message sender name and number (if available)
  - Message type: new, saved, confidential, urgent or recorded, receipt confirmation
  - Date, time and duration of message





### The Message Details Window







In this window, you can save (Keep), play, or delete (Discard) the message. You can send the voicemail to your email if the To Email feature is enabled or Give it to another user. You can dial the message sender or add the message sender to your contact list in the People application.

- To view other messages and their details, use the Navigation keys  or  to move up or down through your message list.

## Play a Voice Message

1. Open the Voice mail application. 
2. Login to your mailbox.
3. Select a message in your message list.
4. Press Play. 



Control the play of the message via the following command buttons:

- Stop (  )
- Pause (  )
- rewind the message by five seconds (  Skip)
- fast forward the message by five seconds (Skip  )
- go to the beginning of the message (  To start)
- go to the end of the message (To end  )

 **Note:** The audio connection is terminated after 30 seconds of idle time.

## Dial Message Sender

**To dial the phone number of a message sender:**

1. Open the Voice mail application. 
2. Login to your mailbox.
3. Do one of the following:
  - In the main window Message List, press the **Dial**  icon to the right of the message.
  - Select a message in your message list to display the Message Details, and then press **Dial**.

If there is no known number, the **Dial**  icon is disabled in the message list.

If the number is external, enter the required prefix digit (for example “9”) to access an outside line before pressing Dial. When dialing from the window Message List, the number is dialed as displayed; no prefix entry is allowed.

Pressing Dial will display the Phone application if Open on Made Calls is enabled in the Call Notification preferences in the Settings application.

## Save a Message

### To save a message:

1. Open the Voice mail application. 
2. Login to your mailbox.
3. Press on a message in your message list.
4. Press **Keep**.

The saved message is removed from the new list and added to the saved list.

## Delete a Message

### To delete a message:

1. Open the Voice mail application. 
2. Login to your mailbox.
3. Press on a message in your message list.
4. Press **Discard**.

The next message in the message list is displayed. If the last message in the list was deleted, the Message Details window is closed.

## Add a Message Sender to Your Contacts List

### To add a sender to your contact list:

1. Open the Voice mail application. 
2. Login to your mailbox.
3. Select a message in your message list.
4. Press **To People**.

The contact is added to your contacts list in the People application. If the contact already exists in your contact list, it is not added.

## Forward a Message to Another Mailbox

You can only forward messages to internal mailboxes. Confidential messages cannot be forwarded.

### To forward a message to another mailbox:

1. Open the Voice mail application. 
2. Login to your mailbox.
3. Select a message in your message list.
4. Press **Give**.
5. Enter the recipient's mailbox number.
6. Press **Send message**.

## Forward a Message to Your Email Address

You can only forward a message to your email address if the Forward to Email feature is enabled on your system. You can tell that the feature is disabled by **To Email** button on your phone shown as disabled.

### To forward a message to your email address:

1. Open the Voice mail application. 
2. Login to your mailbox.
3. Select a message in your message list.
4. Press **To Email**.

The message is forwarded to your email address. If you have set your preference in the Desktop User tool to delete messages when forwarding, the message is deleted (but remains in the list until you log out of your mailbox).

## USING THE CALL HISTORY APPLICATION

Use the Call History application  to display logs of your most recent 50 calls. After the 50-call limit has been reached, the oldest log is replaced each time a new call is missed, made, or answered.



From this application, you can



- display logs by type
- display call information (if available) for the logs
- return missed calls by pressing a key
- delete or modify digits before saving or dialing a call
- delete logs

If you are a hot-desk user, you can view and maintain your call history logs when you are logged into another extension.

### View Call Log Details



#### To view call log details:

1. Press Call History. 
2. Press
  - **Missed** to view your missed calls (if any).
  - **All** to view a list of all logs
  - **Answered** to view logs of your incoming calls
  - **Made** to view logs of your outgoing calls.
3. Use the navigation keys at the bottom of the display to move to the previous or next page of logs. The total number of pages in the current list is shown at the bottom of the display.
4. Press the Dial icon  to the right of the log to call the contact or  
Press on a Call log to display the call details:
  - Name and number (if available)
  - Log type and number of attempts (for example, Missed, 2x)
  - Type of call: Transfer (Tsf.) or Conference (Conf.)
  - Time and date of log
  - Duration of call in hours:minutes:seconds (for Made and Answered logs).

5. Do one of the following:
  - If necessary, use the keypad cursor left, cursor right, **Delete**, and **Backspace** keys to modify the number. If an outgoing prefix is required to access an external trunk, you must add the digit(s). Press **Dial** to call the number or press **To People** to save the contact details to the **People** application.
  - Press  or  at the bottom of the set to display details for another log.
  - Press **Close** to return to the previous list.

## Review Call Log Icons

**To review call log icons:**

1. Press  in the Gadget Sidebar to display help on Icons.
2. Press  or  to navigate to the list of Icons.

## Delete Logs

**To delete an individual log:**

- Press the key to the left of the log to display the call details and then press **Delete**.

**To delete all logs by type:**

1. Press **Call History**. 
2. Press
  - **Missed** to view your missed calls (if any)
  - **All** to view all logs
  - **Answered** to view logs of your incoming calls
  - **Made** to view logs of your outgoing calls.
3. Press **Delete** List to delete all logs from the currently displayed list.
4. You are prompted to confirm the delete. Press **Delete**.



## CALL FORWARDING

Use Call Forwarding  to redirect incoming calls to an alternate number when

- your phone is busy
- when you're not answering, or
- all the time.

You can program, activate, and deactivate Call Forward Always quickly using the Call Forwarding icon  even while you have other types of Call Forwarding, such as Busy External, activated through your Call Forwarding settings.

For example, you can enable settings to forward calls to your voice mailbox when your phone is busy or unanswered. Then, if you must leave your desk, you can quickly enable Call Forward Always to another phone, such as your home phone or cell. After you return to your desk and deactivate Call Forwarding Always, the defaults for busy or unanswered conditions remain active.

### Using Quick Call Forward Always

#### To program and enable Call Forward Always:

1. Press Call Forwarding. 
2. If a number is already programmed, you can
  - Press **Activate** to enable forwarding to the current number or
  - Enter a new destination number and then press **Activate**.



**Note:** Call Forward Always takes precedence over all other types of forwarding.

#### To deactivate Call Forward Always:

1. Press Call Forwarding. 
2. Press **Deactivate**.



**Note:** When Call Forward Always is not active, the defaults are active.

## Programming Call Forwarding Defaults

You can create default Call Forward settings that identify where to send your incoming calls if Call Forward Always is not active.

### To program Call Forwarding default settings:

1. Press Call Forwarding. 
2. Press **Edit Default**.
3. Select the desired type of Call Forwarding:
  - **Busy Internal:** forwards internal phone calls after several rings if your line is busy
  - **Busy External:** forwards external phone calls after several rings if your line is busy
  - **No Answer Int:** forwards internal phone calls redirects your calls after several rings if you don't answer
  - **No Answer Ext:** forwards external phone calls redirects your calls after several rings if you don't answer
4. Using the phone dial pad, enter the appropriate number.
5. Press **OK**.
6. Repeat Step 3 to Step 5 for each Call Forwarding type that you wish to program.
7. Press **Save**.

This setting is saved. If Call Forward Always is disabled, this setting is activated. If Call Forward Always is enabled, the default setting is not activated.

8. Press **Close** twice.



**Note:** Press **Cancel** at any time to exit this application without making any changes.

## PROGRAMING FEATURES ON YOUR KEYS

### Tips on Programming Features

You can program your phone's programmable keys to enable features. To program your keys, you can use:

- *Settings* application
- Unified Communicator Express application

You can assign the following to a programmable Key:

- Features and Fixed function keys: see [Program Feature Keys Using the Setting Application](#).
- Applications: People, Settings, Call Forwarding, Conference Unit (see [Program Phone Application](#))



**Note:** Only the System Administrator can program line select and line appearance keys. The user's Prime line by default is Key 1.

### Features available for programming on programmable keys

Feature	Default Label
Speed Call	(Blank)
Private Speed Call	(Blank)
Music	Music
Night Answer	Night Ans
Account Code Verified	Acct Verified
Account Code Non-Verified	Acct Non-Ver
Hot Desking	Hot Desk
Phonebook	Phonebook
Speak@Ease™	Speak@Ease
Auto Answer	Auto Ans
Paging	Paging
Call Pickup	Call Pickup
Call Back	Call Back
Headset <sup>1</sup>	Headset
Make Busy	Make Busy
Campon	Campon
Override	Override
Direct Page	Page
Do Not Disturb	DND

Feature	Default Label
Single Flash	Flash
Double Flash	Dbl Flash
Meet Me Answer	Meet Me
Message Waiting Indicator	Msg Waiting
Emergency Call	Emergency
Tag Call	Tag Call
Privacy Release	Privacy Rls
Swap	Swap
Rec Call	Rec Call
Release	Release
Call History	Call Hist
Call Park	Call Park
Call Park Retrieve	Park Retrieve
Group Listen	Grp Listen
Superkey	Superkey
Redial	Redial
Speaker	Speaker
Message	Message
Hold	Hold
Transfer/Conference	Trans/Conf
Cancel	Cancel
Analog Line	Analog Line
Phone Lock	Phone Lock
Group Park	Group Park
Group Presence	Group Presence
Personal Ring Group Presence	Personal Ring Group Presence
Handoff	Handoff

1. Turning on the Headset feature key has no effect on the Cordless Headset.

## Applications available for programming on programmable keys

Application	Default Label
People	People
Voicemail	Voicemail
Call History	Call Hist
Call Forwarding	Forwarding
Conference Unit	Conf Unit
Settings	Settings
Call Info	Call Info
Cordless Devices	Cordless Devs
Applications List	Applications

## Program Feature Keys Using the Settings Application

### To program a Phone Feature or hard key:

1. Press the blue **Applications** key .
2. Press **Settings**.
3. Press **Programmable Keys**.
4. Press the key you wish to program.
5. If applications are displayed, press **View Features**.
6. Use the Page Navigation keys to move through the features list.
7. Select the desired feature or fixed function key from the list. A default label is automatically assigned to the key, except for Speed Call and Private Speed Call.
8. Enter the required information in the fields provided, if necessary.
9. If you are programming any feature other than Speed Call, Message Waiting Indicator, Call Park, Call Park Retrieve, Group Park, Group Presence, or Personal Ring Group, press **Save** and you are finished with this procedure. If you are programming any of the features listed above, perform the following steps:
  - Press **Edit Info**.
  - Press **Edit Number**.
  - Enter the appropriate numbers that correspond to the phone whose messages you wish to be notified of (Message Waiting) or the directory number (Call Park/other features).
10. Press **OK**.
11. Press **Save**.
12. Press **Close**.

**To program a *Phone Application*:**

1. Press the blue **Applications** key .
2. Press **Settings**.
3. Press **Programmable Keys**.
4. Press the key you wish to program.
5. If Features are displayed, press **View Applications**.
6. Use the Page Navigation keys to move through the Applications list.
7. Select the desired application.
8. Press **Save**.
9. Press **Close**.

**To program Speed Call:**

1. Press the blue **Applications** key .
2. Press **Settings**.
3. Press **Programmable Keys**.
4. Press the key you wish to program. If it's already programmed, press **Clear Key**.
5. Press **Speed Call**.
6. Press **Edit Label** and enter the label for the Speed Call.
7. Press **OK**.
8. Press **Edit Number** and enter the phone number for the Speed Call:
  - The maximum length is 26 characters.
  - 0-9, # and \*.
9. Press **OK**, and then press **Save** again.
10. Press **Close** and then press **Close** again.



**Notes:**

- To return to the Feature or Applications list at any time, press **Cancel** or **View Applications**.
- You can also choose to Edit the Label and Clear Key.

## Clear Programming from a Key

You may wish to clear the programming from a key if you are no longer using it.

### To clear the feature or application programming from a key:

1. Press the blue **Applications** key .
2. Press **Settings**.
3. Press **Programmable Keys**.
4. Press the key you wish to clear.
5. Press **Clear Key**.
6. Press **Close**.



## MAKING AND ANSWERING CALLS

You can make a call using one of the following methods:

- Dial a number from the People application. 
- Press the programmed key associated with the party you want to call. For more information about programming keys, see [Programing Features On Your Keys](#).
- Dial the number using the dialpad.
- Use Phone Book (see Phone Book below).

### Dial from your People Application

**To dial a contact from your People list:**

1. Open the People application. 
2. Use the navigation keys to page through the contact list and select the name.
3. Dial the contact name using one of the following methods:
  - Press the Dial icon  to the right of the contact's name in the main list. (The contact name does not need to be selected.)
  - Select a contact name and press **Dial**.
  - Press the dial pad key that contains the first letter of the contact name and then press the Dial icon  or press **Dial**.
4. Continue the call using the speakerphone or lift the handset.

### Phone Book

**To use Phone Book:**



**Note:** You can enter the first or last name, or both.

1. Press **Phone Book** (if available) or the key programmed as Phone Book.
2. Enter the name of the desired party, as follows:
  - For each letter in the name, press the appropriate key on the keypad until the letter is shown in the display. For example, if the letter C is required, press the digit 2 three times.
  - Use the **←** softkey to correct errors.
  - If the next letter in the name is on the same digit key as the previous letter, press the **→** softkey before proceeding.
  - If required, press **→** softkey to add a space between the first and last name.



3. Press the **Lookup** softkey.
  - If the system option “Phonebook Lookup – Default to User Location” is enabled for your phone, the search is limited to names that share your location; otherwise, the entire directory is searched.
  - If the system option “Phonebook Lookup – Display User Location” is enabled, after the phonebook search function displays the matching name and directory number, the user’s location is displayed. The display alternates between the name/number and the location every 2 seconds.
4. If no match exists, edit the original entry.  
or  
If the system option “Phonebook with Location” is enabled, press **Backup**. ALL LOCATIONS? Is displayed. Press **Yes** to search the entire directory or press **No** to search for only names that share your location. Edit the name and press **Lookup**.
5. If more than one match is found, press the **Next** softkey.
6. Do one of the following:
  - To make the call, press the **Call** softkey.
  - To edit the entry, press the **Backup** softkey.
  - To exit, press **Cancel** or **Superkey**.



## Answer a Call

### Do one of the following:

- Select the programmable line key or Float Key (see page [55](#)) for the ringing line that is flashing.
- Lift the handset or press  (**SPEAKER**).

## End a Call

### Do one of the following:

- Press **Hang Up** or **Cancel** (.
- Replace the handset.
- Press the key that you have programmed as Cancel.
- If you are in Handsfree mode, press  (**SPEAKER**).

## Redial

### To redial the last number that you manually dialed:

1. Lift the handset (optional).
2. Press  (**REDIAL**).

## Redial - Saved Number

### To save the last number that you manually dialed:

1. Lift the handset.
2. Dial the appropriate feature access code.

### To Redial a saved number:

1. Lift the handset.
2. Dial the appropriate feature access code.

## Handsfree Operation

### To use Handsfree to make a call:

1. If you want to use a Non-Prime Line, press a Line Appearance key.  
**Note:** Your administrator must program Line Appearances to your phone.
2. Dial the number.
3. Begin speaking when the called party answers. Your phone's Handsfree microphone and Handsfree speaker transmit and receive audio.

### To use Handsfree operation to answer calls:

1. Press the flashing line key or Float Keys.
2. Begin speaking. Your phone's Handsfree microphone and Handsfree speaker transmit and receive audio.

### To hang up while using Handsfree operation:

- Press  (SPEAKER).

### To turn Mute on during Handsfree operation:

- Press  (MUTE). The **Mute** key light turns ON.

### To turn Mute off and return to conversation:

- Press  (MUTE). The **Mute** key light turns OFF.

### To disable Handsfree operation:

- Lift the handset.

**To return to Handsfree operation:**

1. Press  (**SPEAKER**).
2. Hang up the handset.

## Auto-Answer

When the Auto-Answer feature is active, incoming calls ring briefly, and then the phone answers the call in Handsfree mode. You can continue the call handsfree or use the handset.

**To enable or disable Auto-Answer:**

- Press **Auto-Answer** key. (See [Programming Features on Your Keys](#) for instructions on programming features on your phone.) The key is highlighted and all incoming calls are answered in Handsfree mode.

**To switch from Handsfree mode to handset mode:**

- Lift the handset

**To end a call, do one of the following:**

- Press  (**CANCEL**)
- Press the **Hang Up** softkey.
- Wait for the caller to hang up.

## Using the Analog line

The phone can support the Line Interface Module. See [Using The Line Interface Module](#) for more information.

## CALL HANDLING

### Hold

#### To place a call on Hold:

1. Press  (**HOLD**).
2. Press the key that you have programmed as Hold. The indicator flashes on the line that has the held call.



**Note:** You can only retrieve a call from hold when the phone is idle.

#### To retrieve a call from Hold, do one of the following:

- Lift the handset and press the flashing line key or Float Key (see page [55](#)).
- Press the flashing indicator.
- Use the Add Held feature to conference into the held call.

#### To retrieve a call from Hold at another phone, do one of the following:

- Press the flashing line key.
- Dial the appropriate feature access code and the number of the station that placed the call on Hold.

### Mute

Mute lets you temporarily turn your phone's handset, headset or handsfree microphone off during a call.

#### To turn Mute on during a call:

- Press  (**MUTE**). The  (**MUTE**) light turns ON.

#### To turn Mute off and return to the conversation:

- Press  (**MUTE**). The  (**MUTE**) light turns OFF.





**Note:** If you are on a Handsfree MUTED call and you lift the handset, the handset microphone is automatically enabled and the MUTE light turns OFF.



**NOTE FOR USERS ON RESILIENT 3300 ICP SYSTEMS:** If your phone switches to the secondary system while your speaker or handset is muted (that is, while the **Mute** key is lit) the call remains muted until you hang up.

## Transfer

### To Transfer an active call:



1. Press  (TRANSFER).
2. Dial the number of the third party.
3. Do one of the following:
  - To complete the Transfer, hang up.
  - To announce the Transfer, wait for an answer, consult, and hang up.
  - To cancel the Transfer, press  (CANCEL).

### To transfer an active call during headset operation:

1. Press  (TRANSFER).
2. Dial the number of the third party.
3. To complete the Transfer, press the **Release** feature key.

## Conference

### To form a Conference when a two-party call is already in place, or to add another party to an existing Conference:

1. Press  (TRANSFER).
2. Dial the number of the next party.
3. Wait for an answer.
4. Press  (TRANSFER).

### To leave a Conference:

- Hang up or press  (CANCEL).

## Conference Split

### To Split a Conference and speak privately with the original party:

- Press the **Split** softkey.

## Add Held

### To move a call on hold to another line appearance:

1. Press an available line key.
2. Press the **AddHeld** softkey.
3. Press the flashing line key.

### To add a call on Hold to an existing conversation or conference:

1. Press the **AddHeld** softkey.
2. Press the flashing line key.

## Swap

### To call another party when you are in an established two-party call:

1. Press  (TRANS/CONF).
2. Dial the number.

### To alternate between the two parties:

- Press the **Trade Calls** softkey.

## USING OTHER FEATURES

### Account Codes

An account code is a series of digits that you assign to your calls, usually for accounting purposes. The code identifies the account in the call records that your system generates. A forced account code is usually entered from another extension, enabling you to use features or make calls that the extension otherwise could not. If you want this feature enabled on your phone, ask your System Administrator.

#### To use Account Codes:

1. Lift the handset.
2. Dial the Account Code digits.
3. Press #.

#### To enter an Account Code during a call:

1. Press **Superkey** (must be programmed to a key).
2. Select **Account Code**.
3. Dial the Account Code digits.
4. Press the **Save** softkey.
5. Do one of the following:
  - For a verified account code, press the **Yes** key.
  - For a non-verified account code, press the **No** key.

### ACD

If your phone is ACD-enabled, you can log in as an agent. When there is no agent logged onto an ACD-enabled set, *LOGGED OUT* is displayed.

#### To log in as an ACD agent:

1. Press **Superkey**.
2. Press **Yes**.
3. Enter your Agent ID, using the key pad.
4. Press **Enter**.  
The text, *LOGGED OUT* disappears.

## Attendant Call Hold - Remote Retrieve

### To retrieve a call placed on Hold by the attendant:

1. Lift the handset.
2. Dial the appropriate feature access code.
3. Dial the digits announced by the attendant.

## Callback

The Callback feature allows you to be notified when a busy phone becomes free or when a phone has been used after a no-answer condition was encountered.

### To request a Callback when you reach a busy or unanswered station:

1. Press **Call Me Back**.
2. Hang up.

When the party is available, your phone starts ringing, and the display shows the Callback ringing indicator.

### To answer a Callback:

- When you see the Callback ringing indicator, lift the handset, or press the Float Key (flashing with the calling party's name label; see page [55](#)).

## Call Forward - Remote (I'm Here)

### To forward calls from a remote station to your current location:

1. Press **Superkey** (must be programmed to a key).
2. Press the **No** softkey until "Call Forwarding?" appears.
3. Press the **Forwarding** softkey.
4. Press the **Next** softkey until "I Am Here" appears.
5. Press the **To Me** softkey.
6. Dial the extension of the remote station.  
If you make an error while dialing, use the <— softkey to backspace and correct the number.
7. Press  (**DOWN**) or the Save softkey.



**To cancel Call Forward – Remote from the station that set the remote forwarding:**

1. Lift the handset.
2. Dial the appropriate feature access code.
3. Dial the extension of the remote station.
4. Hang up.

**To cancel Call Forward – Remote from the station that was forwarded:**

1. Press **Superkey** (must be programmed to a key).
2. Press the **No** softkey until "Call Forwarding?" appears.
3. Press the **Forwarding** softkey.
4. Press the **Review** softkey.
5. Press the **Change Key** softkey.
6. Press the **Turn FWD Off** softkey.
7. Press **Superkey** (must be programmed to a key).

## Call Forward - End Chaining

**To ensure that calls do not get forwarded again by the destination number:**

1. Lift the handset.
2. Dial 64.
3. Hang up.

**To again allow calls to be forwarded by the destination number:**

1. Lift the handset.
2. Dial the appropriate feature access code.
3. Hang up.

## Call Forward - Forced

**To force an incoming call to be forwarded:**

- Press the **Forward** softkey.

## Call Forward - Override

### To override Call Forward and ring a station:

1. Lift the handset.
2. Dial the appropriate feature access code.
3. Dial the extension number.

## Call Park

The Call Park feature allows you to place a call in a special hold state. You, or someone else, can then retrieve the call from any extension in the system.

After parking the call, the system can automatically connect you to paging equipment so that you can announce the call to the requested party.

### To park an active call:

1. Do one of the following:
  - Press the **Call Park** feature key (must be programmed)
  - Press  (TRANS/CONF), and then dial the appropriate feature access code. The display shows PARKED@, followed by the park destination and parking spot index (if applicable). Example: PARKED@ 1234 @ 02.
2. Dial the directory number on which to park the call (not required if the number is programmed to the **Call Park** feature key).
3. To inform a user that a parked call is waiting, do one of the following:
  - If automatic paging is enabled, announce the call and the park retrieve digits shown on the display.
  - If automatic paging is disabled, press the programmed **Page** key, or dial the appropriate feature access code, followed by the Paging zone number (if required). Then, announce the call and park retrieve digits shown on the display.



**Note:** Paging over a loudspeaker is not permitted in handsfree mode; you must use the handset or headset.

**To retrieve a parked call:**

1. Do one of the following:
  - Dial the appropriate feature access code.
  - Press the **Call Park - Retrieve** feature key (must be programmed).
2. Dial the directory number on which the call is parked (not required if the number is programmed to the **Call Park** feature key).
3. If there are multiple calls parked on the number, dial the two-digit index number to retrieve a specific call, or # to retrieve the longest parked call.

## Call Pickup

**To answer a call that is ringing at another extension in your Pickup Group:**

1. Lift the handset.
2. Press the key that you programmed as **Pickup**.

**To answer a call that is ringing at another extension not in your Pickup Group:**

1. Lift the handset.
2. Dial the appropriate feature access code.
3. Dial the number of the ringing station.

## Campon

When you get a busy tone, you can use the Campon feature to be notified when the busy party becomes available.

**To Campon to a busy station:**

- Press the **I Will Wait** softkey.

**To retrieve a call when you hear the Campon tone:**

- You can use the Trade Call or Call Swap feature with the  (TRANS/CONF) hardkey or a programmable line key.

## Direct Paging

Direct Paging allows you to page a party through their handsfree speaker. If the paged party has Off-Hook Voice Announce enabled, the page will be heard even when the party is on a handset or headset call. If the paged party has Handsfree Answerback enabled and turned on on the phone, your page automatically establishes a handsfree call with the paged party.

### To page a party:

1. Lift the handset.
2. Press the **Direct Paging** feature key or dial the appropriate feature access code.
3. Dial the directory number.
4. Speak to the dialed party after the tone.

How you answer a Direct Page depends on whether Handsfree Answerback is enabled and turned on at your phone. See one of the following procedures in this guide:

- [Direct Paging - Handsfree Answerback Enabled](#)
- [Direct Paging - Handsfree Answerback Disabled](#)

### Direct Paging - Handsfree Answerback Enabled

When you receive a Direct Page, Handsfree Answerback automatically establishes a Handsfree call on your phone after a single burst of tone.



Your administrator enables or disables Handsfree Answerback on your phone. After your administrator enables Handsfree Answerback, you can choose to turn it on or off directly from your phone.

### To turn Handsfree Answerback on:

- When your phone is idle, press  (**MUTE**) once. The MUTE key light flashes to indicate that Handsfree Answerback is ON.
- When a Direct Page arrives, the MUTE key light turns OFF and a Handsfree call is automatically established.

### To turn Handsfree Answerback off:

- Press the flashing  (**MUTE**) key once. The MUTE key light turns OFF.
- To respond to a Direct Page when Handsfree Answerback is OFF, see [Direct Paging - Handsfree Answerback Disabled](#).

 **Note:** By default, Handsfree Answerback is turned OFF at your phone. If the  (**MUTE**) key is OFF when your set is idle, Handsfree Answerback is OFF.

**To answer a call using Handsfree Answerback:**

Phone state before Page arrives	To answer the Direct Page
Phone is idle and MUTE is flashing	<ol style="list-style-type: none"> <li>1. Check that MUTE is OFF.</li> <li>2. Listen for the paging party.</li> <li>3. Begin speaking.</li> <li>4. Lift the handset if you wish to switch from a Handsfree call to a handset call.</li> </ol>
You are on a handset or headset call, and MUTE is OFF	<ol style="list-style-type: none"> <li>1. Check that MUTE is flashing.</li> <li>2. Press MUTE. The light turns ON solid, and you are now speaking to the paging party and have muted your handset/headset call.</li> <li>3. Speak to the paging party. Press MUTE to alternate between handset/headset and handsfree calls.</li> </ol>
You are on a MUTED handset/headset call, OR, you are on a Handsfree call	The party paging you receives a busy tone. Handsfree Answerback does not interrupt your call.

**To end a Handsfree Answerback call:**

- Press either  (**SPEAKER**) or  (**CANCEL**).

When the Handsfree Direct Page call ends, the **MUTE** key light returns to the state it was in before the call was established.



## Direct Paging - Handsfree Answerback Disabled

Your administrator enables or disables Handsfree Answerback and you can also turn it on or off on your phone. To turn Handsfree Answerback off, see [Direct Paging - Handsfree Answerback Enabled](#). When Handsfree Answerback is disabled on your phone and you receive a Direct Page, the Direct Page is indicated by a single burst of tone.

### To answer Direct Page calls when Handsfree Answerback is disabled:

Phone state before Page arrives:	To answer the Direct Page (indicated by single burst of tone):
Phone is idle and MUTE is OFF.	<ol style="list-style-type: none"> <li>1. Check that MUTE is ON solid.</li> <li>2. Lift the handset <b>OR</b> press the MUTE key to answer in Handsfree mode. (The light turns OFF.)</li> <li>3. Begin speaking.</li> </ol>
You are on a handset call or headset call, and MUTE is OFF	<ol style="list-style-type: none"> <li>1. Check that MUTE is flashing.</li> <li>2. Press MUTE. The light turns ON solid and you are now speaking to the paging party and have MUTED your handset/headset call.</li> <li>3. Speak to the paging party. Press MUTE to alternate between handset and handsfree calls.</li> </ol>
You are on a MUTED handset/headset call, OR, you are on a Handsfree call	The party paging you receives a busy tone. Handsfree Answerback does not interrupt your call.

### To end a Direct Page call, do one of the following:

- Hang up the handset to end a handset call.
- Press  (**SPEAKER**) to end a Handsfree call.
- Press  (**CANCEL**).

When the Handsfree Direct Page call ends, the (MUTE) key light returns to the state it was in before the call was established.

## Direct Voice Call

Direct Voice Call feature allows you to establish a two-way handsfree call at another extension whether or not it has Handsfree Answerback or Auto-Answer turned on. Only extensions programmed by the system administrator to receive Direct Voice Calls can be called using this feature.

### To make a Direct Voice Call:

1. Lift handset.
2. Dial the appropriate feature access code.
3. Dial the extension you want.
4. Speak to called party.

## Do Not Disturb

When you enable Do Not Disturb, callers will get a busy tone, and an on-screen text message indicating that you do not wish to be disturbed.

### To activate or deactivate Do Not Disturb:

- Press the **Do Not Disturb** key that you programmed. The key indicator is lit when Do Not Disturb is activated and is not lit when Do Not Disturb is not activated. The phone status line shows the Do Not Disturb  icon.

### To activate Do Not Disturb from a remote extension:

1. Lift handset.
2. Dial the number of the station to which **Do Not Disturb** is to apply.
3. Hang up.

### To deactivate Do Not Disturb from a remote station:

1. Lift handset.
2. Dial the appropriate feature access code.
3. Dial the number of the station with **Do Not Disturb** activated.
4. Hang up.

## Emergency Calls

**Warning for emergency number dialing:** Consult your local authorities for Emergency Numbers and 911 or equivalent service availability in your area.

There are two methods of dialing emergency numbers, based on the 3300 ICP programming:

- Emergency Call Routing NOT programmed
- Emergency Call Routing programmed

---

**CAUTION: Verify with your System Administrator which type of emergency number dialing you can use.**

---

### Emergency Calls When Emergency Call Routing Not Programmed

**If Emergency Call Routing is NOT programmed, Emergency Number dialing should only be performed by picking up the handset and selecting the Analog Line key you have programmed. If Privacy Mode is enabled and the Analog Line key local line is busy, dialing will not occur on the Line Interface Module line.** Emergency dialing using an IP connection may not be supported due to ICP system configuration and country location. For more information, contact your System Administrator.

#### **To make an Emergency Call using the Line Interface Module line:**

1. Lift the handset.
2. Press the Analog Line key that you have programmed.  
The set indicates *ANALOG CALL*
3. Dial your Local Emergency Number.

#### **To make an Emergency Call using the Line Interface Module line, when the IP connection has failed:**

1. Lift the handset.
2. Press the Analog Line key that you have programmed.  
The set indicates *IP FAIL: ANALOG CALL*.
3. Dial your Local Emergency Number.

### Emergency Calls When Emergency Call Routing Programmed



**Note:** This procedure is in addition to the methods described above.

#### **To make an Emergency Call if Emergency Call Routing is programmed:**

1. Lift the handset.
2. Dial your Local Emergency Number (911 or equivalent).

For more information on using the LIM line, refer to [Using The Line Interface Module](#).



## Float Keys

Float keys are used to display unanswered ringing lines on designated keys where the ringing lines would otherwise be hidden on one of the phone's programmable keys. The location of the Float keys is shown in the following figure:



Up to three concurrent incoming calls with associated labels can appear on Float keys. Float keys can also be used to support ringing line queues – due to the number of ringing lines at any one time, you are able to view the queue of unanswered “floated” lines, and answer them as quickly as possible.

Only the following line types are supported for float keys on 5360:

- Single Line
- Key System
- Multicall

## Programming Float Keys

You program the keys to appear on Float Keys using the Settings application on the 5360 phone. Float Keys act essentially as a mirror of any of the lines programmed on the 48 programmable keys and which are programmed to float. The Float Keys reflect the state of those lines including indicators and labels, and allows you to access those lines without having to navigate to the pages where those keys may be displayed. Any answered floating line remains floating for the duration of the call, regardless of the manner in which it was answered.

### To enable float keys:

1. Press the blue **Applications** key .
2. Press **Settings**.
3. Press **Float Keys**.
4. Press **Enable**, and then press **Save**.

### To program Float Keys using the Settings Application:

1. Press the blue **Applications** key .
2. Press **Settings**.
3. Press **Programmable Keys**.
4. Press one of the line keys that you want to appear on a Float Key. Use the Page Navigator keys to move through the pages of programmed keys if necessary. The Float Configuration display appears.
5. Press a button corresponding to your desired float configuration:
  - Float Immediate** – configure the unanswered incoming call on the designated line to appear at the Float Key immediately
  - Float after. . .** – configure unanswered incoming calls to display on a Float Key after a delay of up to 60 seconds
  - Do Not Float** – configure unanswered incoming calls to never display on a Float Key (this is the default setting)
6. Press **Save**.
7. Repeat steps 4 – 6 for every line key that you want to appear on the float keys.
8. Press **Close**.

### To disable float keys

1. Press the blue **Applications** key .
2. Press **Settings**.
3. Press **Float Keys**.
4. Press checkbox for **Enable** to disable Float Keys.
5. Press **Save**.

## Using Float Keys

You can set up more than three lines to float. As lines ring, they get placed into a queue which will display the first three in the float key area. If there are more than three lines configured to float, as Float Key positions are freed up, the next lines in the queue get displayed. Press the Float key of the ringing line to answer a call.

## Group Listen

With Group Listen, you can carry on a conversation using the handset or headset while allowing others nearby to listen to the person at the far end over the handsfree speaker. The handsfree microphone is disabled in Group Listen mode.

### To activate Group Listen while in a handset conversation:

- Press the **Group Listen** key.  
Audio from the far-end party is now heard through both the handset/headset and the speaker.

### To make the call a normal two-way speaker call:

- Press  (**SPEAKER**).

### To exit Group Listen mode (and return to a normal handset/headset call):

- Press the **Group Listen** key.

### To activate or deactivate Group Listen while in headset mode:

- Press the **Group Listen** key.

## Group Paging / Meet Me Answer

Group Paging allows you to page a group of phones through their built-in speakers. You can belong to as many as three paging groups with one group designated as your "prime" group.

When you need to respond to a Group Page but don't know the identity or directory number of the paging party, use the Meet Me Answer feature. You have up to 15 minutes after receiving the page to use Meet Me Answer.

### To make a Group Page:

1. Lift the handset.
2. Press **Direct Page** or dial the appropriate feature access code.
3. Do one of the following:
  - To page your prime page group, press #.
  - To page a specific page group, dial the page group directory number.
4. Speak to the dialed party after the tone.

### To respond to a Group Page by using Meet Me Answer:

1. Lift handset.
2. Press the key you have programmed to Meet Me Answer or dial the appropriate feature access code.  
(See [Programming Features On Your Keys](#) for instructions on programming features to your phone.)
3. Do one of the following:
  - To respond to a page from your prime page group, press #.
  - To respond to a page from a specific page group, dial the page group directory number.

## Group Presence

Group Presence allows members of call groups ( Hunt, ACD, Ring, and Personal Ring) to make themselves absent or present in a group. Only members who are present in a group are offered calls to that group.

If you are in a Personal Ring group (see [Handoff - Personal Ring Groups](#)), Group Presence lets you choose which device in the group you want to use to receive calls by making it 'Present' and the others 'Absent.'

You can also change the presence status of other users if allowed by your system administrator.

Users belonging to multiple groups can control their presence in each group separately through the use of feature keys (one for each group), or by dialing a feature access code (FAC) followed by the group number. For information about programming feature keys, see page [33](#).

### To join a group:

1. Lift the handset.
2. Do one of the following:
  - Press the **Group Presence** feature key to join the group associated with the key.
  - Dial the Group Presence - Join Group feature access code followed by the group directory number.

The LED associated with the key is steady lit when the member is present and off when absent.

### To leave a group:

1. Lift the handset.
2. Do one of the following:
  - Press the **Group Presence** feature key to join the group associated with the key.
  - Dial the Group Presence - Leave Group feature access code followed by the group directory number.

The LED associated with the key is steady lit when the member is present and off when absent.

### To change another group member's presence status:

1. Lift the handset.
2. Dial the Group Presence - Join Group Third Party or Group Presence - Leave Group Third Party .
3. Dial the directory number of the group member.
4. Dial the group directory number.

**To change the presence status of another Personal Ring Group member using a feature key:**

- Press the **Personal Ring Group Presence** feature key.

The LED associated with the key is steady lit when the member is present and off when absent.

## Handoff - Personal Ring Groups

Personal Ring Groups (PRGs) associate two or more of your devices, such as your office phone and cell phone, with a single user Directory Number (DN). PRGs are set up by the system administrator. Group member devices ring simultaneously when called.

You can use the group Handoff feature to “Push” or “Pull” calls between group member devices. A Push passes the call to the group, where it can be answered by any other present group device. A Pull takes an in-progress call away from another member.

**To use Handoff to Push an in-progress call to the PRG:**

- Press the **Handoff** key.

**To Pull an in-progress call from another member of the PRG:**

- Lift the handset (optional if the device supports handsfree operation).
- Press the **Handoff** key.

## Headset Operation



**Note:** For information about the Cordless Headset, see [USING YOUR PHONE WITH THE CORDLESS MODULE AND ACCESSORIES](#) on page 78.

### To enable Headset Operation:

- Press the **Headset** feature key.

### To answer a call (when Auto Answer is disabled):

- Press the flashing line key or Float Key.

### To answer call (when Call Notification is enabled)

- Select **Close** and then select the prime line.

### To hang up:

- Press  (**CANCEL**).

### To mute your headset microphone:

- Press the  (**MUTE**) key. The light turns ON.

### To turn mute off and return to the conversation:

- Press the  (**MUTE**) key. The light turns OFF.

## Hot Desking

Hot Desking allows you to log into the phone system from any phone designated as a Hot Desk phone. When you log in at the phone using your assigned Hot Desk User Directory number, the phone assumes all your speed dials, features keys, call forwarding setup, and line appearances - even your language preference for the display. Any changes you make to the phone while you are logged in--for example, adding a speed dial--are saved to your personal profile. Logging in activates your profile on any phone that supports Hot Desking.

When you log in as a hot desk user, Call History data is updated for you. You do not see any call logs for the phones registered DN; you only see your history data. When you log out, the registered DN's history data is displayed. To access your voice mail when you are logged in as a hot desk user, you must log in to your voice mail.

### To log into a Hot Desking phone (the phone must be idle):

1. Press the key you have programmed to **HotDesking**.
2. Press the **Login** key.
3. Using the phone keys, enter your Hot Desk User Directory number, and then press **OK**.
4. Enter your pin number and press **OK**.

While logged in as a hot desk user, the phone status line shows the Hot Desk  icon.

### To log out of Hot Desking phone (the phone must be idle):

1. Press the key you have programmed to **HotDesking**.
2. Press the **Logout** command key.
3. Press the **Confirm** command key.



**Note:** Your profile can only be active on one phone at a time. If you log in from another phone without logging out from the first one, the system will automatically deactivate your profile on the first phone.



## Hot Desk Remote Logout

A user who has forgotten to log out of a Hot Desking phone can be logged out from a phone that is configured to allow Hot Desk Remote Logout.



**Note:** This feature must be allowed by your System Administrator via the Class of Service.

### To remotely log out a Hot Desking phone:

1. Dial 111.
2. Dial the Hot Desk User Directory number that you want to log out.
3. Press the **Logout** command key.
4. Press the **Confirm** command key.

## Hot Desk - PIN Change

### To change your Hot Desk PIN:

1. Log into a Hot Desking phone.
2. Press **Superkey** (must be programmed to a key).
3. Press the **HotDesk PIN** softkey.
4. Press the **Yes** softkey.
5. Enter the current PIN or skip to step 6 if a PIN has not yet been assigned.
6. Press the **Enter** softkey.
7. Enter the new PIN.  
The PIN can include digits from 0 to 9 only and can be from 0 to 8 characters in length.
8. Press the **Enter** softkey.
9. Re-enter the new PIN.
10. Press **Superkey**.

## Make Busy

You can use the Make Busy feature to have your phone appear busy to other callers. If callers dial your phone number when Make Busy is enabled a message indicating that your line is busy is displayed on their phones.

### To enable Make Busy:

- Press the key you programmed to **Make Busy**. The key illuminates when Make Busy is activated and *MAKE BUSY* is displayed.

### To disable Make Busy:

- Press the key you programmed to **Make Busy**.

## Message Waiting Indicator

The Message Waiting Indicator (MWI) feature allows you to be notified when messages have been left on another phone. Once you have programmed a key to MWI, this key is always enabled.

### To use MWI to contact the extension that left a message:

- Press the key you have programmed to **MWI**.

## Messaging - Advisory

Advisory Messaging enables you to select a notice that appears on your phone display to inform people visiting your desk of your whereabouts. Select from a variety of advisory messages, including "On vacation", "In a meeting", or "Out to Lunch".

### To turn Messaging - Advisory on:

1. Press **Superkey** (must be programmed to a key).
2. If necessary, press the **No** softkey until "Advisory Msgs" appears.
3. Press the **Advisory** softkey.
4. Press the **Next** softkey until the desired message appears.
5. Press the **Turn Msg On** softkey.

### To turn Messaging - Advisory off:



1. Press **Superkey** (must be programmed to a key).
2. If necessary, press the **No** softkey until "Advisory Msgs" appears. .
3. Press the **Yes** softkey when "Advisory appears.
4. Press the **Turn Msg Off** softkey .

## Messaging - Callback

### To leave a Callback Message when you hear busy or ringback tone:

- Press  (MESSAGE) or press the **Callback** softkey.

### To respond to a message waiting condition on your phone:

1. Press  (MESSAGE).
2. If a password is required, dial your password (and press the **Enter** softkey if available).
3. Press the **Read Message** softkey, and do one or all of the following:
  - To display the time the message was sent, press the **More Msg** softkey.
  - To display the number of the caller, press the **More Msg** softkey twice.
  - To call the message sender, press the **Call** softkey.
  - To delete the message, press the **Erase Msg** softkey.
  - To view the next message, press  (MESSAGE).

### You can check for messages from a remote station:

1. Press **Superkey** (must be programmed to a key).
2. Press the **No** softkey until "Remote Msging?" appears.
3. Press the **Yes** softkey.
4. Dial your directory number.
5. Press the **Enter** softkey.
6. If a password is required, enter your password and press the **Enter** softkey.
7. Press the **Yes** softkey.

### You can set, change, or clear a password (up to 7 digits, not including 0):

1. Press **Superkey** (must be programmed to a key).
2. Press the **No** softkey until "Set Password?" appears.
3. Press the **Yes** softkey.
4. Do one of the following:
  - To enter a new password, enter your password.
  - To change or clear your password, enter your current password.
5. Press the **Enter** softkey.

6. To change or clear your password, do one of the following:
  - To change your password, enter your new password and press the **Enter** softkey.
  - To clear your password, enter 0.
7. Enter your new password again.
8. If you are setting up or changing a password, press the **Enter** softkey.
9. Press **Superkey** (must be programmed to a key).

## Messaging - Cancel Callback

### To cancel a Callback:

1. Lift the handset.
2. Dial the appropriate feature access code.
3. Dial the number of the called station.
4. Hang up.

## Messaging - Cancel All Callbacks

### To cancel all Callbacks:

1. Lift the handset.
2. Dial the appropriate feature access code.
3. Hang up.

## Music

### To turn Music on and off when the phone is idle, do one of the following:

- To turn the music on, press the key that you programmed to **Music** or the Music softkey.
- To turn the music off, press the key that you programmed to **Music** or the Music softkey.

When the Music is activated, the key you have programmed is highlighted.

## Night Answer

The Night Answer feature allows you to route calls to an attendant or message at night.

### To enable Night Answer:

- Press the key you programmed to **Night Answer**. When you have enabled Night Answer, this key is highlighted.

### To disable Night Answer:

- Press the key you programmed to **Night Answer**.

## Override (Intrude)

When you dial a number whose owner has enabled Make Busy, your phone displays the message indicating that the line is busy. You have the option to override this setting.

### To use Override when you encounter a busy tone:

1. Press the key you programmed as **Override**.
2. Wait for an answer.

## Paging

### To use Paging:

1. Lift handset.
2. Press the key that you have programmed to **Page**.
3. Dial the Paging zone number (if required).
4. Make the announcement.

## Phone Lock

Phone Lock prevents access to the features on a phone, with the following exceptions:

- unlocking the set via a user PIN
- Hot Desk Login and Logout support, and
- Emergency Call Notification support.

Phone Lock has no effect on incoming calls but restricts outgoing calls, with the following exceptions:

- calls to emergency trunk routes, and
- local operators.

Most keys on the device are disabled, except for the dial pad and volume keys. The following access and keys are disabled:

- Superkey access
- Applications access
- Softkeys
- feature access keys
- feature access codes, and
- account codes



**Note:** Softkeys will be displayed but disabled, except the hot desking softkeys will remain enabled. The Phone Lock, Hot Desk login, and Emergency Notification feature access keys will still be available. Superkey will provide Emergency Notification, if it is pending.

### Before locking a set, ensure that:

- the set is in the idle state (there should not be any ongoing call)
- you do not have any calls on hold or on consultation-hold on any line appearance
- you are not in headset mode

### To activate Phone Lock:

- Press the **Phone Lock** feature key or enter the Phone Lock Feature Access code.

### To de-activate Phone Lock:

- Press the **Phone Lock** feature key or enter the Phone Unlock Feature Access code.
- Enter your user PIN to unlock the set.



**Note:** If a user PIN has not been assigned, enter # when prompted for the PIN to unlock the phone.

## User PIN

A Personal Identification Number (PIN) allows a user to log into a set as a hot desk user or generic SIP user. It is also used to de-activate the Phone Lock feature. PINs must be from 0 to 8 digits in length. Only digits (0 to 9) are permitted. The default PIN is blank (length zero).

Users will have one generic PIN that can be used for any required features.

The User PIN initially has a zero length, allowing a user, for example, to unlock a phone using a blank PIN for Phone Lock. Setting the User PIN on the set requires the PIN to have at least one digit.

### To change the User PIN:

1. Press **SuperKey** (must be programmed to a key)
2. Press **No** until "Set User PIN?" appears.
3. Press **Yes** softkey or the **User PIN** softkey.
4. At the prompt "Enter Old PIN", enter your old User PIN.
5. Press **Enter**.
6. At the prompt "Enter new PIN", enter your new PIN.  
Use left arrow key to correct mistakes. The PIN can include digits from 0 to 9 only and can be from 0 to 8 characters in length.
7. Press **Enter**.
8. At the prompt to verify the PIN, re-enter your new PIN again. The set confirms successful or failed completion.
9. Press **Superkey** to end the Superkey session.

## Record a Call

This feature uses your voice mail system to record your phone conversations.



**Note:** You may be required by law to inform the other party that you are recording the conversation. For specific instructions, consult your system administrator.

### To start recording while on a 2-party call:

- Press the **Record Call** key. (See [Programming Features On Your Keys](#) for instructions on programming a **Record Call** key to your phone.)



**Note:** Your system may be programmed to automatically begin recording external calls when you or the other answers.

### To control recording, do one or all of the following:

- To pause recording, press the **Pause** softkey.
- To resume recording after pausing, press the **Resume** softkey.
- To stop a recording without saving it, press the **Erase** softkey or  (**CANCEL**).
- To stop and save a recording, press the **Save** softkey.

Putting the call on hold saves the recording; taking the call off hold starts a new recording. Depending on system programming, hanging up, or pressing  (**TRANS/CONF**) or a **DSS** key, may also save the recording.

### To listen to a recording:

1. Lift the handset.
2. Access your voice mailbox.
3. Follow the prompts to retrieve the recording.



## Reminder

### To program a Reminder:

1. Press **Superkey** (must be programmed to a key).
2. Press the **No** softkey until "Timed Reminder" appears.
3. Press the **Reminder** softkey.
4. Enter the time in 24-hour format.
5. Press the **Save** softkey.

### To view, change, and/or cancel a pending Reminder:

1. Press **Superkey** (must be programmed to a key).
2. Press the **No** softkey until "Timed Reminder" appears.
3. Press the **Reminder** softkey.
4. Do one of the following:
  - To change the Reminder, press the **Change Key** softkey, enter the new time, and press the **Save** softkey.
  - To cancel the Reminder, press the **Cancel No.** softkey.
  - To exit without canceling the Reminder, press **Superkey** (must be programmed to a key).

### To acknowledge a Reminder when your phone rings once:

- Press the **Confirm** softkey.

## Speak@Ease

Users of the Speak@Ease softkey can place a call by speaking the name of the person they wish to dial. Speak@Ease enables you to have access to Mitel Speech Server. The Speech Server is a speech recognition application that routes incoming calls to a specific destination based on spoken commands.

### To dial a call using Speak@Ease:

1. Press the key you have programmed to **Speak@Ease**.
2. Speak the name of the person you wish to call.

## Speed Call

Speed Call is an application that allows you to dial a specific number with one key press. You must program Speed Call on a Programmable key. For more information on programming this key, see [Program Feature Keys Using the Settings Application](#).

### To make a Speed Call:

- Press the key that you have programmed as your **Speed Call** key.

## Contact Presence

Unified Communicator (UC) Express supports the display of contact presence information through icons located on Programmable Keys that have been programmed as speed dials. The icons will be displayed on the button. The presence icons for the 5360 are shown below:



### Contact Presence Icons

An alternate speed dial number is supported for each contact, and the button label will show the alternate number instead of the primary number for some presence states.

For the 5360, when a user presses a programmable key which is in the alternate speed dial number state:

- The programmable key text will change to display the primary number for two seconds giving you the option to dial the primary number
- If you press the button again while the primary number is displayed, the primary number will be dialed; otherwise, the alternate number will be automatically dialed after the two second timeout.

## Tag Call

Tag Call allows you to signal that you are the victim of a threatening or malicious call. Using the tag, your system administrator or Telephone Company can identify the source of the call and provide this information to appropriate personnel or authorities.

---

**CAUTION: Tagging a non-malicious call may result in fines or other penalties.**

---

### To tag a malicious call:

1. Press the programmed **Tag Call** key while the call is in progress. (For information on how to program keys, see [Programing Features On Your Keys.](#))

-OR-

Press  (TRANS/CONF).

2. Dial the appropriate feature access code.  
If the call was successfully tagged, *Thank You* is shown on the display; otherwise, *Not Allowed* is displayed.



**Note:** Tag Call can be used on active two-party calls only. Calls on hold and conference calls cannot be tagged.

## Trunk Flash

The Trunk Flash feature allows you to access Centrex features (if available) while you are talking on an outside call.

### To flash a trunk while talking on an outside call:

1. Press the key you have programmed to **Flash**.  
**Note:** You can program a key to single flash or double flash.
2. Wait for dial tone.
3. Dial the Centrex feature access code.

## USING YOUR PHONE WITH THE 5310 IP CONFERENCE UNIT

Your phone uses the 5310 IP Conference Unit for conferencing . You use the Conference Controller to turn the conference unit off or on, to adjust the volume or to put the conference unit into Presentation mode. You can only run one Conference Controller session at a time. If the 5310 Conference Unit is not connected to your phone, the *Conference Controller* application is not available.

### Access the Conference Controller

**To access the Conference Controller:**

- Press the **Conference Unit** icon. 



**Note:** If the Conference Unit application is off when the application is opened, the unit will automatically turn on.

### Turn the Conference Unit On and Off

1. Verify that the conference unit is connected to your phone.
2. Press the **Conference Unit** icon . For more information, see Access Conference Controller.
3. Press **Turn On/Turn Off**.

While the Conference Unit is on, the  icon shows in the phone status line.

### Adjust the Conference Unit Volume

- Press **Volume Up** or **Volume Down** controls.

### Place the Conference Unit in Presentation Mode

Presentation Mode is used when only one individual is speaking to a group. If another member in the group wishes to speak, you must disable Presentation Mode. Presentation Mode minimizes extraneous noise.

**To place the conference unit in Presentation mode:**

- Press **Presentation Mode**.

## Exit the Conference Controller

**To exit the conference controller:**

- Press **Close**.

## Mute the Conference Unit

**To mute the conference unit so that conversation in the meeting room cannot be heard by individuals being conferenced:**

- Press **Mute**.

## USING THE LINE INTERFACE MODULE

Your phone supports the Mitel Line Interface Module. The Line Interface Module allows you to make and receive calls over an analog line (Line Interface Module line) connected to your phone. The Line Interface Module operates in either of the following two modes, as determined by your System Administrator:

- **Line Interface Module Mode:** your phone allows you to use the Line Interface Module line at any time
- **Failover Mode:** you can use the Line Interface Module line only when the IP connection has failed



**Note:** Handsfree and on-hook dialing are not supported on the Line Interface Module line.

For information on emergency number dialing using the Line Interface Module, refer to [Emergency Calls](#).

## Making and Answering Calls Using the Analog key

### To make a call using the Analog line:

1. Lift the handset.
2. Press the key you programmed as **Analog Line**.  
*ANALOG CALL* is displayed.
3. Dial the number.



**Note:** When you make an external call over the analog line, a prefix dialing number is not required. If your phone's Analog Line key has the Privacy option enabled, you cannot access the analog line when another phone is using the analog line (key is solid orange). To access the analog line, the user of the other phone must first hang up. To determine whether the Privacy option is enabled, contact your System Administrator.

### To answer a Call using the analog line:

1. Lift the handset.
2. Press the **Analog Line** key that is highlighted.

### To answer a waiting call on the analog line:



**Note:** If you have subscribed to an analog call waiting service, you may use the hookswitch or press **Cancel** (ⓧ) to answer a waiting analog call. When you are on an analog call and a waiting analog call arrives, you hear a beep. This feature may not be supported in all regions.

**To answer a waiting analog call or return to the original analog call:**

1. Do one of the following:
  - Press and release the hookswitch
  - Press **Cancel** (⊗)
2. Press the key you have programmed as **Analog Line**.

**To put a current call on hold to answer an incoming analog call:**

- Press the highlighted **Analog Line** key.

**To switch between the current call and the held call when one of the calls is using the analog line, do one of the following:**

- If your current call is using the analog line, press the flashing Line key of the held call. The analog call is automatically put on hold.
- If your current call is using an IP line, press the highlighted Analog Line key. The IP line is automatically put on hold.

**To end a current call when an incoming analog call arrives:**

- Press **Cancel** (⊗) and then press the highlighted Analog Line key. The current call ends and you are connected to the caller on the analog line.

**To end the current analog call when an incoming call arrives:**

- Press **Cancel** (⊗). The current analog call ends and you are connected to the new caller.

## Making and Answering Calls Using the Failover Mode

**To make a call using the analog line during an IP connection failure:**

1. Lift the handset.  
The phone displays *IP FAIL: ANALOG CALL*.
2. Dial the number.

**To answer a call using the analog line during an IP connection failure:**

- Lift the handset. The call is answered. The phone displays *IP FAIL: ANALOG CALL*.

## USING YOUR PHONE WITH THE CORDLESS MODULE AND ACCESSORIES

Cordless handsets and cordless headsets provide you with the capability to move around within your own office or adjacent offices while using your phone.

These cordless devices connect to your IP phone through a Mitel Cordless Module, which attaches to the back of the phone. There are two Cordless Module types available: Digital Enhanced Cordless Telecommunications (DECT) and Bluetooth®. The DECT Cordless Module works with the Mitel DECT Cordless Handset and the Mitel DECT Cordless Headset. The Bluetooth Module works the Mitel Bluetooth Handset and most third-party Bluetooth headsets.

The Mitel Cordless Handsets (both DECT and Bluetooth) recharge in the handset cradle. The Mitel Cordless Headset (DECT only) rests and recharges in a headset cradle that attaches to the side of the phone.

The Cordless Devices Application  (see page [92](#)) provides access to the configuration settings and information screens that apply to the Cordless Module and accessories.



**Note:** Since only one module type can be attached to the phone at any given time, you cannot, for example, use a 5310 Conference Module when a Cordless Module is attached.

**CAUTION:** Attempting to remove the back plate on the phone to install a Cordless Module before disconnecting the phone's power supply may damage the phone. For details on installing a Cordless Module, see the appropriate Cordless Module and Accessories Installation Guide for Mitel 5330/5340/5360 IP Phones included with the module and available at Mitel OnLine.





## DECT Cordless Module and Accessories on a 5360 IP Phone



Rear View of 5360 IP Phone

### Elements of Your Cordless Module and Accessories

Feature	Function
1) Cordless Module (either DECT or Bluetooth)	Attached to the back of the phone, the module contains a Light Emitting Diode (LED) indicating that a cordless device is in use; also indicates the state of pairing between the module and a cordless device.
2) Cordless Headset (photo shows DECT headset)	Cordless handsfree operation for calls. If you are using a cordless headset, you do not need to use the handset.
3) Cordless Headset Charging Cradle (DECT only)	Provides power to recharge the cordless headset battery. (Not available for Bluetooth headsets.)
4) Cordless Handset Charging Plate	Provides power to recharge the cordless handset battery. Replaces the handset cradle plate supplied with the phone for corded handsets.
5) Cordless Handset	Cordless operation for handset calls. (You can transfer from the phone handset to the cordless headset at any time.)
6) Cordless Module Pairing Button	Initiates pairing between the Cordless Module and a cordless accessory.
7) Cordless Headset Cradle Cable (DECT only)	Connects to the Cordless Module to provide power to the charging cradle.

## Handset/Headset Combinations

The following combinations of corded and cordless headset and handset are supported on the 5360 IP Phone:

- Corded handset only
- Corded handset and corded headset
- Cordless handset only
- Cordless handset and cordless headset
- Corded handset and cordless headset
- Corded headset and cordless handset

The DECT Cordless Handset, DECT Cordless Headset, and Bluetooth Handset are all Mitel-branded accessories available only from Mitel. Bluetooth headsets are third-party accessories available from a variety of manufacturers.

## Pairing the Cordless Module and Accessories

Before using a cordless handset or headset, it must establish communication with the Cordless Module using a procedure called pairing.

### Pairing a DECT Cordless Accessory with a DECT Cordless Module



**Notes:**

- An IP phone can have only one DECT Cordless Handset and one DECT Cordless Headset.
- A cordless handset or headset can be paired with only one IP phone at a time.
- Pairing a new cordless handset or headset with the IP phone overwrites the configuration of any previous handset or headset.
- Pairing cannot be performed when a cordless device is already in use.

**To pair a DECT cordless accessory:**

1. Ensure that the battery of the cordless device to be paired is at least partially charged.
2. Press and hold the pairing button on the back of the Cordless Module (see page [79](#)) for 5 seconds to activate phone pairing mode. The LED on the Cordless Module blinks. The Cordless Devices application opens on the phone and prompts you to place the accessory in pairing mode.
3. Press and hold the hookswitch on the side of the cordless handset (see page [84](#)) or headset (see page [87](#)) for 5 seconds to activate accessory pairing mode. The LED on the cordless accessory blinks. After a moment, the Cordless Devices application displays protocol, firmware, hardware, and IPEI information for the device to be paired.



**Note:** If the LED on the Cordless accessory does not start to blink after 10 seconds, the accessory requires charging or is still in factory battery saving mode (handset

only). Place the accessory on the charger and charge. The green LED starts to flash indicating that the accessory is charging. It could take up to 60 minutes for the green LED to start flashing. Allow the accessory to fully charge, approximately 3 hours.

4. Press **Yes** to confirm pairing. The Cordless Devices application confirms the pairing by displaying the paired device name and its battery level indicator.
5. Press **Close** to exit.

## Pairing a Bluetooth Accessory with a Bluetooth Module



### Notes:

- An IP phone can have one Bluetooth Handset and up to five Bluetooth headsets (or up to six headsets if no handset is paired).
- To pair a new Bluetooth Handset, you must first unpair the existing Bluetooth Handset.
- Pairing cannot be performed when a Bluetooth device is already in use.

### To pair a Bluetooth accessory:

1. Ensure that the battery of the Bluetooth device to be paired is at least partially charged.
2. Press and hold the pairing button on the back of the Bluetooth Module for 5 seconds to activate phone pairing mode. The LED on the Bluetooth Module blinks. The Cordless Devices application opens on the phone and prompts you to place the accessory in pairing mode.
3. **For Mitel Bluetooth Handsets:** Press and hold the hookswitch on side of the Bluetooth Handset (see page [84](#)) for 5 seconds to activate accessory pairing mode. The LED on the handset blinks. The pairing confirmation window on the IP Phone appears, displaying the product name for the device to be paired.



**Note:** If the LED on the handset does not start to blink after 10 seconds, the handset requires charging or is still in factory battery saving mode. Place the handset on the charger. The green LED starts to flash indicating that the handset is charging. It could take up to 60 minutes for the green LED to stop flashing. Allow the handset to fully charge, approximately 3 hours.

**For third-party Bluetooth headsets:** Follow the manufacturer's instructions to place the Bluetooth headset in pairing mode. The pairing confirmation window on the IP Phone appears, displaying the product name for the device to be paired.

4. Press **Yes** to confirm the pairing. The Cordless Devices application prompts you to enter a passcode.
5. Enter a valid passcode for the Bluetooth device (default is 0000) using the keyboard on the display, and press **OK**.

**For third-party Bluetooth headsets:** An **Auto Connect** window displays. Press **Yes** if the phone will not be shared with other users; press **No** if the phone will be shared with other users and multiple headsets.

6. The LED on the Bluetooth Module lights and remains lit for a few seconds and then resumes normal behavior. The Bluetooth device is paired to the Bluetooth Module.
7. Press **OK** to return to the Cordless Devices application.
8. Press **Close** to exit the application.

## Unpairing an Accessory

### To unpair a cordless accessory:

1. Press the blue **Applications** key  and then press **Cordless Devices**.
2. Press the device name that you want to unpair. The information screen for the selected device appears.
3. Press **Unpair this Device**. If the accessory is in use, an error message displays. Otherwise, the accessory is unpaired, removed from the display, and can no longer be used to interact with the phone.
4. Press **Close**.

For more information about the Cordless Devices Application, see page [92](#).

## Cordless Module LED Indicators

The Cordless Module has a blue light-emitting diode (LED) that indicates the current status of the module:

Blue LED	Function
Solid	Audio is active between the module and either the handset or headset.
Blinking	Pairing mode is active or a firmware upgrade is in progress.
Off	No audio is active.
Solid for several seconds	Pairing is successful.

Blinking: LED is On and Off for equal amount of time

## Using a Cordless Device as a Remote Control

When not being used to talk, the buttons on a Mitel-branded cordless handset/headset can act as a remote control device to change volume and mute settings on the host IP phone. For example, in a remote handsfree conference setting, the chairman can use the volume and mute buttons on a cordless device to adjust speaker levels and mute the microphone on an IP phone that is not within his reach. HTML applications may also make use of the cordless device buttons, but functionality may differ among applications.

## Using the Mute Key on a Cordless Device

When using a Mitel-branded cordless accessory, the Mute key on the cordless accessory is synchronized with the Mute key on your phone. Pressing the Mute key on either the phone or the accessory also controls the Mute function on the other device.

There is no synchronization between a third-party Bluetooth headset mute control (if one is available) and your phone Mute key. The procedure for muting a Bluetooth headset depends on the headset manufacturer. Some headsets have a mute control and some do not. You can, however, use the Mute key on your phone to mute a conversation on any type of Bluetooth headset.

## Using the Volume Keys on Cordless Device

When using a Mitel-branded cordless accessory, the Volume keys on the cordless accessory are synchronized with the Volume keys on your phone. Pressing the Volume keys on either the phone or the accessory also controls the Volume function on the other device.

When using a third-party Bluetooth headset, the volume control on the headset (if one is available) is not synchronized with the Volume keys on your phone. Pressing the Volume keys on the phone does not change the headset volume.

## USING THE MITEL CORDLESS HANDSET

The cordless handset provides office mobility, allowing you to make and answer calls while away from your desk. Replacing the standard corded handset, the cordless handset contains a rechargeable battery that charges in the handset cradle when not in use.

To use the cordless handset (whether DECT or Bluetooth), you must pair the handset with the phone. For details, see [Pairing the Cordless Module and Accessories](#) on page 80.



**Cordless Handset on a 5360 IP Phone**

### Elements of the Cordless Handset

Feature	Function
1) Cordless Handset LED	<p><b>Blue:</b> Light-emitting diode (LED) indicating the status of the handset.</p> <p><b>Green:</b> LED indicating the status of the handset battery.</p> <p>For more information, see page <a href="#">86</a>.</p>
2) Hookswitch Button	<p>Lifting the handset from the cradle activates the handset. If the handset is already out of the cradle, pressing the hookswitch takes the handset off-hook. Pressing the hookswitch again returns it to on-hook.</p> <p>Pressing the hookswitch while on a speakerphone call moves the call to the cordless handset.</p>
3) Mute button	Mute allows you to turn the microphone off during a call.
4) Volume Up and 5) Volume Down buttons	Up and Down provide volume control for the ringer and handset/headset.



**Note:** To return to a corded handset, you must first unpair the cordless handset.

## Answer a Call

**Do one of the following:**

- Lift the cordless handset.
- If the handset is already out of the cradle, press the hookswitch button on the handset.



**Note:** If you have a call on hold on your Prime Line and answer another on a Line Appearance key, it will be presented over the speaker.

## Hang up

**Do one of the following:**

- Replace the cordless handset in the cradle.
- Press the hookswitch button on the handset.

## Dialing – Auto Dial Disabled

**To dial a number with Auto Dial disabled:**

1. Lift the handset or press the hookswitch.
2. Make the call using the dial pad, or press a programmed speed dial key on the phone.

## Dialing – Auto Dial Enabled

**To dial with Auto Dial enabled:**

- To dial the predefined Auto Dial number, press the hookswitch on the cordless handset. To program Auto Dial, refer to [Auto Dial](#) on page 94.

## Handset Alerting Tones and LEDs

The handset provides the following alerting tones:

Feature	Function
<b>Mute</b> key on cordless device ON/OFF	2-pitch tone occurs immediately. Reminder tone occurs 30 seconds after activation and then regularly until deactivated.
<b>Mute</b> key on Phone ON/OFF	Immediate tone with Bluetooth; no immediate tone with DECT. Reminder tone occurs 30 seconds after activation and then regularly until deactivated.
Low battery (within 10 minutes left for DECT and within 20 minutes left for Bluetooth)	3 beeps and 20 second pause repeated 3 times
Low battery (within 2 minutes left)	3 rapid beeps and 1.5 second pause repeated 3 times
Out of range	<p><b>DECT:</b> Repetitive 3-pitch tone until you are back in range.  <b>Note:</b> If you are out of range for more than 10 seconds, any call that is in progress is dropped and not recovered.</p> <p><b>Bluetooth:</b> Single 3-pitch tone to indicate that you are out of range. <b>Note:</b> All Bluetooth devices will drop any call in progress if the maximum range is exceeded.</p>



**Note:** Audio indications are heard in the handset only when it is in use and may interrupt voice transmission.

The handset has two LEDs:

- Blue – indicates the operational status of the handset
- Green – indicates the status of the electrical charge of the battery

LED Color	LED State	Indicates
Blue	Solid	Handset is muted
	Blinking	Handset is in pairing mode
	Winking	Active audio path between Handset and Module
	Off	No audio path between Handset and Module OR Battery is dead
	Solid for 2 seconds	Pairing is successful.
Green	Solid	Battery is fully charged
	Blinking	Battery is charging. <b>Note:</b> It is normal for the handset LED to cycle between blinking and solid as battery charge is maintained.
	Off	When handset is cradled and the LED does not flash or illuminate, this indicates an absence of battery power. During the first 30 – 60 minutes that the light is off, the battery may be trickle charging. If that is the case, the LED will resume normal behavior within that 60 minute period. If the LED remains off for more than 60 minutes, then either the battery is no longer chargeable or there is a problem in the charging circuit.

Blinking: LED is On and Off for equal amount of time

Winking: LED is On for a short period of time and Off for a longer period



## USING THE MITEL DECT CORDLESS HEADSET



**Note:** This section applies only to the Mitel DECT Cordless Headset. It does not apply to third-party Bluetooth headsets.

The cordless headset offers the same capability as the cordless handset to make and answer phone calls away from your desk while adding the convenience of handsfree operation.

When not in use, the cordless headset sits in the headset charging cradle.

To use the cordless headset, you must pair the headset with the phone. For more information, see [Pairing the Cordless Module and Accessories](#) on page 80.

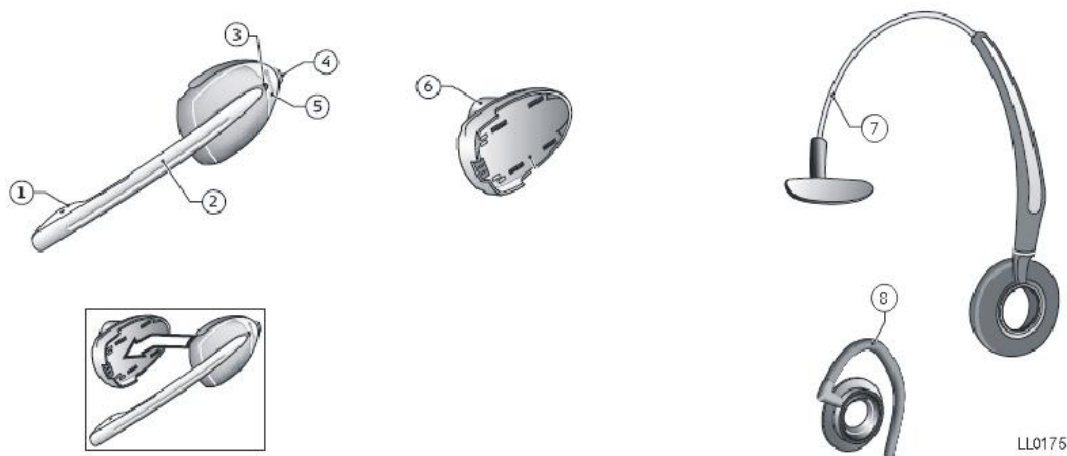

**Elements of the DECT Cordless Headset**

1) Microphone	5) Hookswitch and pairing button (gray section with logo imprinted)
2) Boom arm	6) Speaker
3) Link indicator (LED)	7) Headband
4) Volume control with mute switch	8) Ear hook

### Answer a Call

**Do one of the following:**

- Lift the cordless headset from the cradle.
- If the headset is already out of the cradle, press the hookswitch button on the headset.

## Hang Up

**Do one of the following:**

- Replace the cordless headset in the cradle.
- If the headset is already out of the cradle, press the hookswitch button on the headset.

## Dialing – Auto Dial Disabled

**To dial a number with Auto Dial disabled:**

1. Lift the headset or press the hookswitch.
2. Make the call using the dial pad, or press a programmed speed dial key on the phone.

## Dialing – Auto Dial Enabled

**To dial with Auto Dial enabled:**

- To dial the predefined Auto Dial number, press the hookswitch on the cordless handset or headset.

To program Auto Dial, refer to [Auto Dial](#) on page 94.

## Headset Alerting Tones and LEDs

The cordless headset provides the following alerting tones:

Feature	Function
Mute ON/OFF	2-pitch tone occurs immediately. Reminder tone occurs 30 seconds after activation and then regularly until deactivated.
Mute key on Phone ON/OFF	No immediate tone. Reminder tone occurs 30 seconds after activation and then regularly until deactivated.
Low battery (within 10 minutes left)	3 beeps and 20 second pause
Low battery (within 2 minutes left)	3 rapid beeps and 1.5 second pause
Out of range	Repetitive 3-pitch tone until you are back in range. <b>Note:</b> If you are out of range for more than 10 seconds, any call that is in progress is dropped and not recovered.

There are two LEDs associated with the cordless headset:

- A blue LED on the headset indicates the headset status
- A green LED in the headset charging cradle indicates battery status

LED Color	LED State	Indicates
Blue (on headset)	Solid	Headset microphone is muted
	Blinking	Headset is in pairing mode
	Winking	Active audio path between Headset and Module
	Solid for 2 seconds	Pairing successful OR New battery installed
	Off	No audio path between Headset and Module OR Battery is dead
Green (on cradle)	Solid	Battery is fully charged
	Blinking	Battery is charging. <b>Note:</b> It is normal for the headset LED to cycle between blinking and solid as battery charge is maintained.
	Winking	Indicates low voltage when headset is uncradled
	Off	When headset is cradled, indicates battery is not charging

Blinking: LED is On and Off for equal amount of time

Winking: LED is On for a short period of time and Off for a longer period

## USING A BLUETOOTH HEADSET

A third-party Bluetooth headset offers some of the same capability as the Bluetooth Handset to make and answer phone calls away from your desk while adding the convenience of handsfree operation.



**Note:** If you move out of range of the phone while connected using Bluetooth, you will notice that the audio quality quickly degrades. If you do not move back within range within about 10 seconds, the call is dropped.

To use a Bluetooth headset, you must first pair the headset with the Bluetooth Module on your phone. For more information, see [Pairing the Cordless Module and Accessories](#) on page 80.

For information on using mute and volume functions, see [Using the Mute Key on a Cordless Device](#) and [Using the Volume Keys on Cordless Device](#) on page 83.



**Note:** To switch from the Bluetooth Headset to the 5360 IP Phone speaker press the hookswitch twice on the Bluetooth headset.



**Note:** The specific operation of third-party Bluetooth headsets can vary somewhat by manufacturer and model. Refer to the documentation accompanying the Bluetooth headset for details on operation, alerting tones, LEDs, and charging. Note that all Bluetooth devices will drop any call in progress if the maximum range is exceeded.

### Answer a Call

**To answer a call:**

- Press the hookswitch button on the headset.

### Hang Up

**To hang up on a call:**

- Press the hookswitch button on the headset.

### Dialing – Auto Dial Disabled

**To dial a number with Auto Dial disabled:**

1. Press the hookswitch button on the headset.
2. Make the call using the dial pad, or press a programmed speed dial key on the phone.

## Dialing – Auto Dial Enabled

**To dial a number with Auto Dial enabled:**

- To dial the predefined Auto Dial number, press the hookswitch button on the headset.

To program Auto Dial, refer to [Auto Dial](#) on page 94.

## USING THE CORDLESS DEVICES APPLICATION

The Cordless Devices Application provides access to module information and pairing for handsets or headsets.

**To access the Cordless Devices Application, do one of the following:**

- Press the blue **Applications** key , and then press **Cordless Devices**.
- Press a feature key you have programmed as the Cordless Devices Application key.



**Note:** When the pairing button on the Cordless Module is pressed, or when the battery level of a Mitel-branded cordless accessory is critically low, the phone will automatically open the Cordless Devices Application.

### Low Battery Level

When the battery of a Mitel cordless device reaches a near-critical level, the phone displays a warning. Until the battery is recharged (or until it becomes fully discharged), the warning is repeated at each new call made using the Prime Line. To continue with a call while charging the cordless accessory, switch to speakerphone and then cradle the cordless accessory.

### Viewing Cordless Module Information

You can use the Cordless Devices Application to view protocol, firmware, and hardware information about the Cordless Module attached to your phone.

**To view Cordless Module information:**

1. Access the Cordless Devices Application.
2. Press **Cordless Module Info** or **Bluetooth Module Info**. Device information appears on the screen.
3. Press **Close** to exit.

## Enabling/Disabling Auto-Connect on a Bluetooth Headset

When pairing a Bluetooth headset with the Bluetooth Module installed on your phone, you are given the option to enable the Auto-Connect feature—a feature whereby, if a previously paired Bluetooth device comes into range of the module, it will automatically be connected.

If desired, you can turn this feature on or off using the Cordless Devices application. You should turn on the feature if you are the only user of the phone. If you share the phone, as is sometimes the case in a call center environment, you should turn off the feature.

### To turn the Auto-Connect feature on or off:

1. Access the Cordless Devices Application.
2. Press the desired Bluetooth headset, and then select **Auto-connect (On)** or **Auto-connect (Off)** to toggle the feature to the desired setting.
3. Press **Close** to exit.

## Connecting/Disconnecting a Bluetooth Headset

You can use the Cordless Device Application to connect or disconnect any Bluetooth headset that requires manual connection.

### To connect or disconnect a Bluetooth headset:

1. Access the Cordless Devices Application.
2. Press the desired Bluetooth headset, and then select **Connect** to connect the headset or **Disconnect** to disconnect the headset.
3. Press **Close** to exit.

## Editing a Bluetooth Headset Name

If desired, you can enter or edit a name to help distinguish the headset device from others that may have the same device name. Once you have programmed a name, it is displayed in brackets below the manufacturer name in the details window, and it replaces the headset manufacturer name on the main Cordless Devices application window.

### To edit a name:

1. Access the Cordless Devices Application.
2. Press the desired Bluetooth headset, and then select **Edit Name**.
3. Enter a new name or edit the existing name using the keyboard on the display, and then press **OK**.
4. Press **Close** to exit.

## Auto Dial

When a Cordless Module is installed and at least one Mitel-branded device is paired, the Auto Dial feature is available in the Settings menu. You can program a number that is automatically dialed when a cordless device hookswitch button is pressed.

### To program an Auto Dial number:

1. Press the blue **Applications** key , and then press **Settings**.
2. Press **Auto Dial**, and then press **Edit Number**.
3. In the on-screen keyboard, enter the auto dial number.
4. Press **Save**.
5. Press **Edit Label**.
6. In the on-screen keyboard, enter the appropriate information.
7. Press **Save** and then press **Close**.

### To disable Auto Dial:

1. Press the blue **Applications** key , and then press **Settings**.
2. Press **Auto Dial**.
3. Press **Disable Auto Dial**. The Auto Dial settings you have programmed are maintained when the feature is disabled.
4. Press **Save**.
  - To re-enable, repeat steps 1 and 2 and then press **Enable Auto Dial**.
  - To change Auto Dial information, press **Edit Number** and/or **Edit Label**.
  - Press **Save** to save all changes.





Global Headquarters	U.S.	EMEA	CALA	Asia Pacific
Tel: +1(613) 592-2122	Tel: +1(480) 961-9000	Tel: +44(0)1291-430000	Tel: +1(613) 592-2122	Tel: +61(0) 2 9023 9500
Fax: +1(613) 592-4784	Fax: +1(480) 961-1370	Fax: +44(0)1291-430400	Fax: +1(613) 592-7825	Fax: +61(0) 2 9023 9501

For more information on our worldwide office locations, visit our website at [www.mitel.com/offices](http://www.mitel.com/offices)

THIS DOCUMENT IS PROVIDED TO YOU FOR INFORMATIONAL PURPOSES ONLY. The information furnished in this document, believed by Mitel to be accurate as of the date of its publication, is subject to change without notice. Mitel assumes no responsibility for any errors or omissions in this document and shall have no obligation to you as a result of having made this document available to you or based upon the information it contains.

M MITEL (design) is a registered trademark of Mitel Networks Corporation. All other products and services are the registered trademarks of their respective holders.  
© Copyright 2011, Mitel Networks Corporation. All Rights Reserved.

[www.mitel.com](http://www.mitel.com)

