

LET'S WORK TOGETHER



SEATING AND TABLES

Senator

WE'RE DOING

WE LOVE, EVERY

SINGLE DAY

Robert Mustoe

ING WHAT

VERY

7

■

Let's work together

**SO, HOW
CAN WE
HELP?**

Senator

Part of The **Senator** Group

A LITTLE ABOUT US

WHAT'S OURS IS YOURS

Our story began in 1976, when we began designing and manufacturing office furniture, and although we've now grown into one of the largest furniture manufacturers in the world, we still remain an independent, family owned business.

All the things that were important to us in the beginning; our attention to detail, integrity, investment in people and passion for design, are still very much running through the veins of the business today.

OUR BRANDS

We have three global brands within The Senator Group. Each of our brands has its own individual personality, complementing each other to create an existing portfolio to choose from. Whatever your project, whatever your style and whatever you need, you'll find the solution within this brand family.

Senator

Innovation engineered

Allermuir

Anything but ordinary

Torassen

Beautifully efficient

SHOW AND TELL

This book is an introduction to Senator's portfolio of products and a guide to how you can make each piece your own. Read, research and be inspired, then come and experience the real thing. Comfort can't be chosen from a piece of paper.

WE BEGIN BY LOOKING AT YOU



With every Senator design comes a great deal of thought.

The design process begins way before pencil reaches paper, beginning with looking at you. We look at how you sit, reach, move and work to create a design which not only looks beautiful, but is a pleasure to use too.

Behind every Senator product is a fusion of intelligent thinking and innovative engineering to create products which support people whether they're focusing, collaborating, presenting or organising.



Let's work together

WHAT WE CAN DO FOR YOU



Innovation Engineered

007.**TASK SEATING**

008 Evolve
014 Clipper
016 Freeflex
024 Ecoflex
030 Sprint
031 Dash

033.**CHAIR COLLECTION**

034 Circo
040 Rhapsody
042 Symmetry
044 Zenith
046 Fuse
047 Freeflex
048 Ad-Lib
058 Ad-Lib Scholar
062 Ad-Lib Work Lounge
066 Trillipse
072 Elios

077.**TABLE SYSTEMS**

078 Ad-Lib
088 Pivot
092 Axis
100 Play
104 Chameleon

Let's work together

NEED IT DIGITAL?

A copy of this book, product rotations, high resolution images, CAD symbols and more detailed product information are all on our website.

thesenatorgroup.com

Innovation Engineered

Section One

TASK SEATING

Senator task chairs are designed to not only look beautiful, but to represent state of the art ergonomics, functionality and choice.

008 Evolve / 014 Clipper / 016 Freeflex /
024 Ecoflex / 030 Sprint / 031 Dash



Evolve

With its ergonomically contoured back construction, flexible movement and lumbar adjustment, Evolve offers a level of comfort and support that is unsurpassed.

Design by Paul Brooks



Evolve

Evolve incorporates a new advanced synchronised mechanism with enhanced geometry, which ensures the motion of the chair will mirror the natural pivot of the body throughout its range of movement.





Evolve

Evolve is ideally suited to those who sit at a desk for several hours everyday. Whether the user is focusing on a task, reaching for a file or deep in conversation, the chair flexes with their natural movements, providing both comfort and health benefits.

Clipper

BEND ME, SHAPE ME

The Clipper task chair delivers fantastic comfort with simple elegant styling. However, it is capable of providing a comprehensive suite of adjustments and features a dynamic synchronised tilt action.





Clipper

Clipper can be finished in one of six mesh back options, from the traditional neutrals to a palette of vibrant colours. Combined with black or light grey components, an option for a polished aluminium base and infinite upholstery choices, Clipper can be customised to suit any style.

Let's work together



Clipper

Clipper's ergonomic design and elegant well proportioned back frame makes it particularly suitable when postural support is required for long periods of time. The combination of strength with flexibility and various modes of adjustment allow the user to find the optimum sitting position.

Freeflex

I LIKE
THE WAY
YOU MOVE

Freeflex provides a clever and adaptable solution to support the user's movements in their working environment. Flexibility is central to the design of Freeflex, giving the user the freedom to make simple adjustments; to their seat height, seat depth and back height to achieve ultimate comfort.



Task Seating



Design by Justus Kolberg





Freeflex

In designing Freeflex, special attention was paid to the user's natural pivot points, where they flex and where they don't. This inspired the development of a dynamic weight balancing tilting action along with an articulated flexing back, which intuitively encourages movement, while providing proper support in all positions.

Design by Justus Kolberg



Freeflex

Freeflex is available in an array of colour choices with new combinations of dark grey and black components or light grey and dark grey components, to create inspirational spaces within workplaces.

I LIKE THE WAY YOU MOVE



SIT
20

REACH
REACH

MEET
MEET

MO
MO



VE
FE

Ecoflex

LESS IS ALWAYS MORE

A minimal masterpiece, combining a clean understated aesthetic design with outstanding functional flexibility. It's stylish, light and built with sustainability in mind, so it makes an impact on any interior without making an unnecessary impact on the environment.





Ecoflex

You feel at home in an Ecoflex because it's designed to fit around you. You can adjust everything from seat depth to lower back support with simple, intuitive controls. Plus, a rotational four stage travel limiter helps you maintain the open, fluid action of the chair - a feature that has recognised back health benefits.

Design by Justus Kolberg



Ecoflex

Less is also more when it comes to construction. Ecoflex has been designed to include less components and use less raw materials. The ingenious back frame incorporates many of the features required for the operation of the height adjustable arms. It also cuts down on production processes by requiring no extra co-moulded components or structural inserts.



Ecoflex

The variety of finish options make Ecoflex an ideal choice when designing creative and innovative environments. Its plastic components are available in either light grey or black, the perfect frame for the wide range of six back mesh colours available.





Sprint

Designed for simplicity and ease of use with an understated style, Sprint is a high performance, high comfort task chair. Featuring a new synchro-mechanism, seat slide and back height adjustment with optional height adjustable arms, Sprint represents the very best integration of style and function.



Dash

Dash is designed for comfort and performance. Competitively priced, this task chair includes a synchro-mechanism and ergonomic integrity. Its specifically designed arms represent unique style, function and value.

Let's work together

NEED IT DIGITAL?

A copy of this book, product rotations, high resolution images, CAD symbols and more detailed product information are all on our website.

thesenatorgroup.com

Innovation Engineered

**Let's Get Into
Some Detail**

TASK

SEATING

Senator

Let's get into some detail

EVOLVE



CLIPPER

FREEFLEX



ECOFLEX

SPRINT



DASH

LET'S GET
INTO SOME
DETAIL



Let's get into some detail

EVOLVE

STANDARD FEATURES

Black components/ Black base/ Synchronised mechanism with adjustable tension and back locking function in 11 positions, including locking upright/ Two degree negative seat tilt/ Flexible seat and back membrane/ 60mm seat depth adjustment/ Height adjustable arms with multi-functional armpad*/ 65mm castors

*-Selected models only

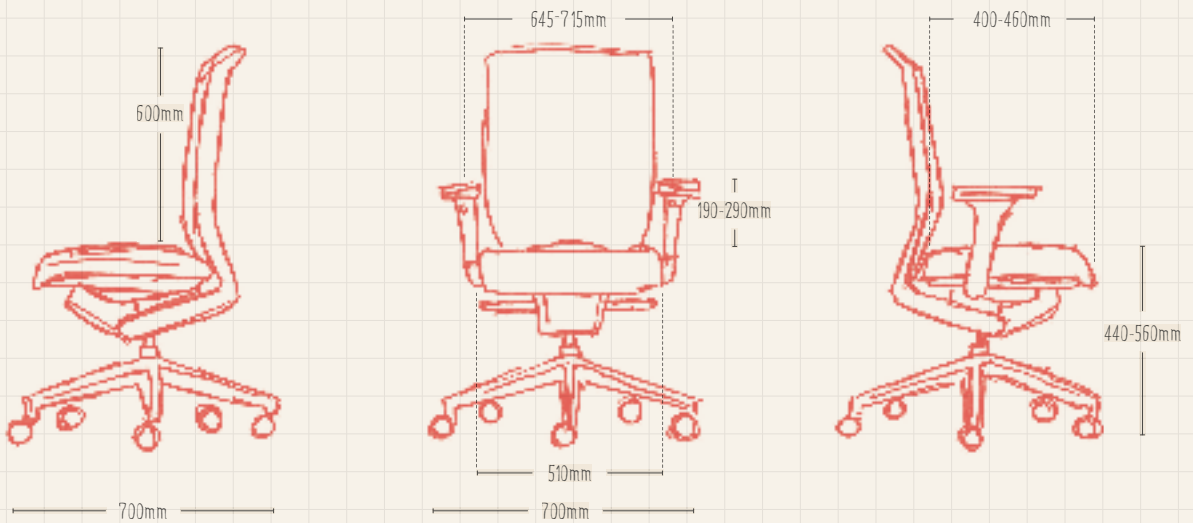

RANGE OVERVIEW



Upholstered seat+back



Membrane back



Height adjustable arms



Multi-function arms

Task Seating

Evolve is available with two-tone upholstery!*



AIRFLOW MESH COLOURS



Black

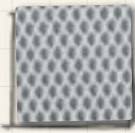

Grey



White

FRAME/ARM



Black
[STANDARD]

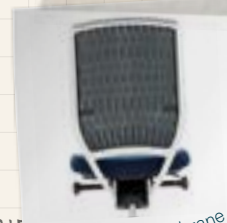

Anthracite Membrane

BACK MEMBRANE



Black Membrane



White Membrane

MECHANISM



Evolve Mechanism:
Synchronised

CASTOR OPTIONS



Brake unloaded/ Soft wheel/
Soft wheel - brake unloaded

GAS LIFT



STANDARD 150KG/
Heavy duty 190Kg/
Sprung base/
Dual lift telescopic

BASE



Black GRP
[STANDARD]

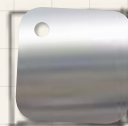

Polished Aluminium

LUMBAR ADJUST

Optional adjustable lumbar



EVOLVE:2

STANDARD FEATURES

Light grey components/ Light grey base/ Brushed steel 150kg gas lift/ Synchronised mechanism with adjustable tension and travel limitation in four steps, including locking upright/ Two degree negative seat tilt/ Flexible seat and back membrane/ 60mm seat depth adjustment/ Height adjustable arms with multi-functional armpad*/ 65mm castors

(*Selected models only)

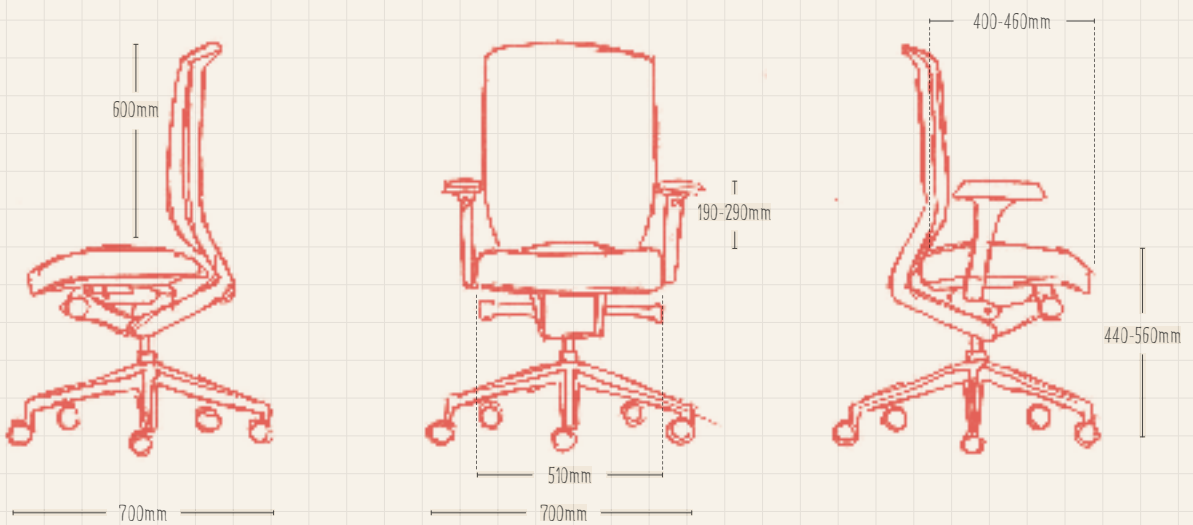

RANGE OVERVIEW



Upholstered seat+back



Membrane back



Height adjustable arms



Multi-function arms

Task Seating

AIRFLOW MESH COLOURS



Black



Grey



White

FRAME/ARM



Light Grey
[STANDARD]



Black

BACK MEMBRANE



White Membrane



Black Membrane



Anthracite Membrane

OPTIONAL

Polished Aluminium arm carrier

Evolve is available with two-tone upholstery!



Evolve:2 Mechanism:
Synchronised

LUMBAR ADJUST

Optional adjustable lumbar



CASTOR OPTIONS



Brake unloaded



Soft wheel



Soft wheel - brake unloaded

GAS LIFT



150KG

STANDARD 150KG/
Heavy duty 190Kg/
Sprung base/
Dual Lift Telescopic

BASE



Light Grey
[STANDARD]



Polished Aluminium

CLIPPER



STANDARD FEATURES

Black components with breathable mesh back in black/ Black base/ Synchronised mechanism with adjustable tension and travel limitation in four steps, including locking upright/ Width and height adjustable arms with multi-function armpad*/ Fully adjustable headrest*/ 60mm castors

[*Selected models only]

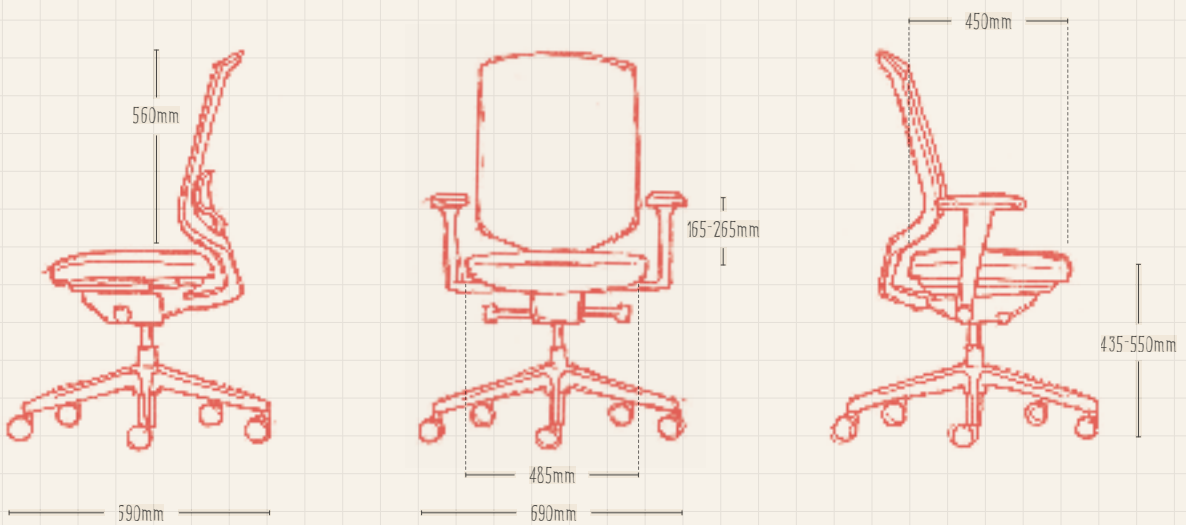

RANGE OVERVIEW

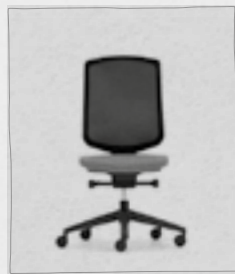

No arms



Height and Multi-adjustable arms



Neck and lumbar supports

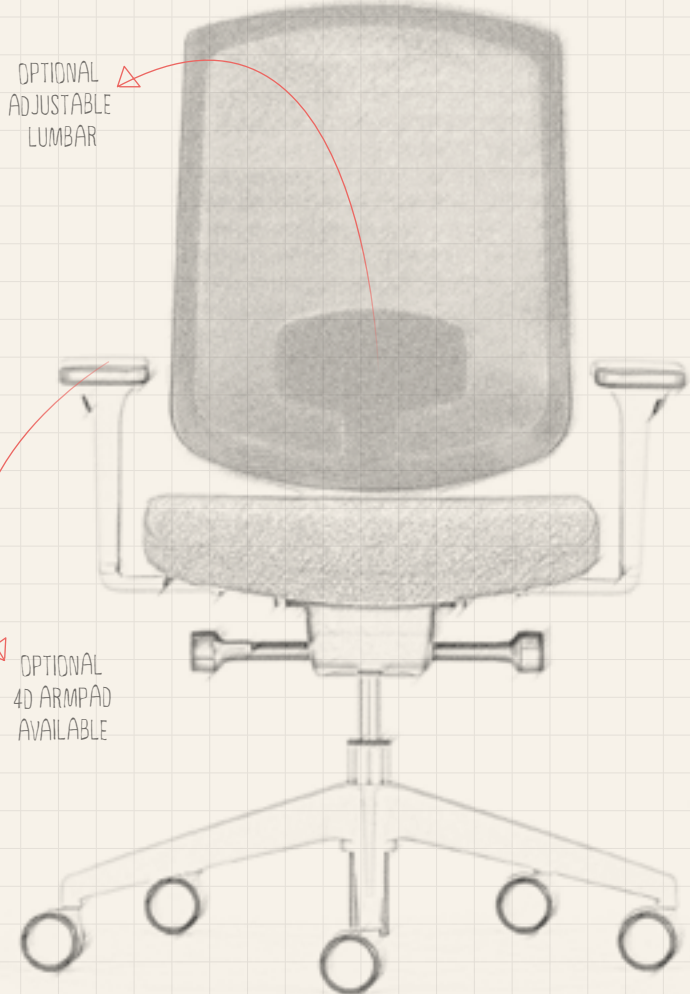

OPTIONAL
ADJUSTABLE
LUMBAR

OPTIONAL
4D ARMPAD
AVAILABLE

MESH COLOURS



Black
[STANDARD]

Grey

Snow

Burnt Orange

Fresh Apple

Soft Cyan

FRAME/ARM COLOURS

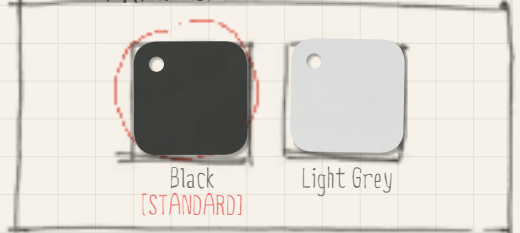

Black
[STANDARD]

Light Grey



SEAT SLIDE

60mm SEAT SLIDE AVAILABLE

MECHANISM



Clipper
Mechanism:
Synchronised

CASTOR OPTIONS



Brake
unloaded

Soft wheel

Soft wheel
- brake
unloaded

GAS LIFT

STANDARD 150KG/
Heavy duty 190Kg/
Sprung base/
Dual Lift Telescopic/
Counter height*/
Draughting height*

BASE



Black
[STANDARD]

Light Grey

Polished
Aluminium

FREEFLEX

STANDARD FEATURES

Dark grey components with optional light grey or black arms and back/ Dark grey base/ Weight controlled synchronised mechanism with travel limitation in four steps, including locking upright/ Integrated flexible back membrane/ 70mm back height adjustment/ Contrasting mesh side panels on the seat and back, with a complementary coloured back insert/ 60mm seat depth adjustment/ Width and height adjustable arms*/ 60mm castors

[* - Selected models only]

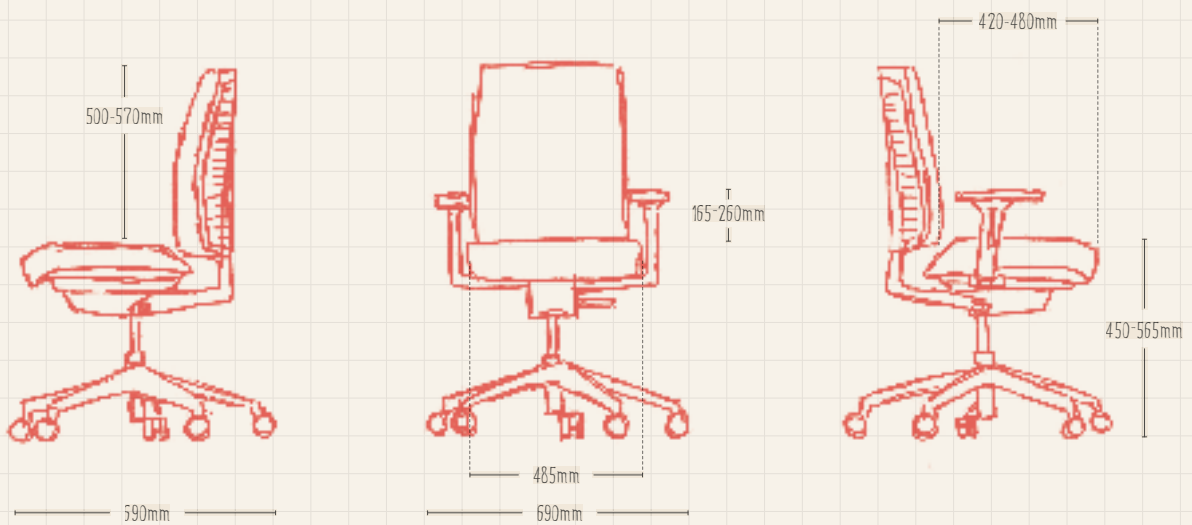

RANGE OVERVIEW



No arms



Width+Height adjustable arms



Stool

Task Seating



BREATHABLE MESH SIDE PANELS



MATCHING COLOUR INSERTS!



COMPONENTS



ARM/ BACK COLOURS

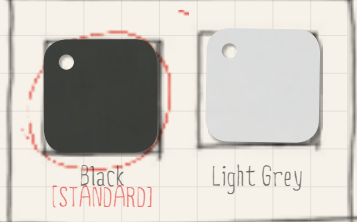

MECHANISM



CASTOR OPTIONS

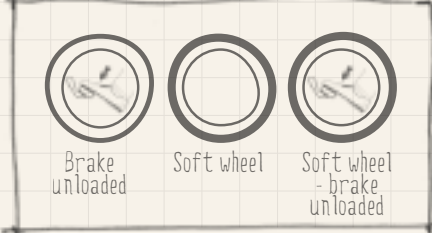

GAS LIFT

STANDARD 150KG/
Heavy duty 190kg/
Sprung base/
Dual Lift Telescopic/
Counter height*/
Draughting height*

BASE



Let's get into some detail

ECOFLEX



STANDARD FEATURES



Black components with breathable mesh back in black/ Black base/ Synchronised mechanism with adjustable tension and travel limitation in four steps, including locking upright/ Height adjustable arms*/ 60mm castors

*-Selected models only)

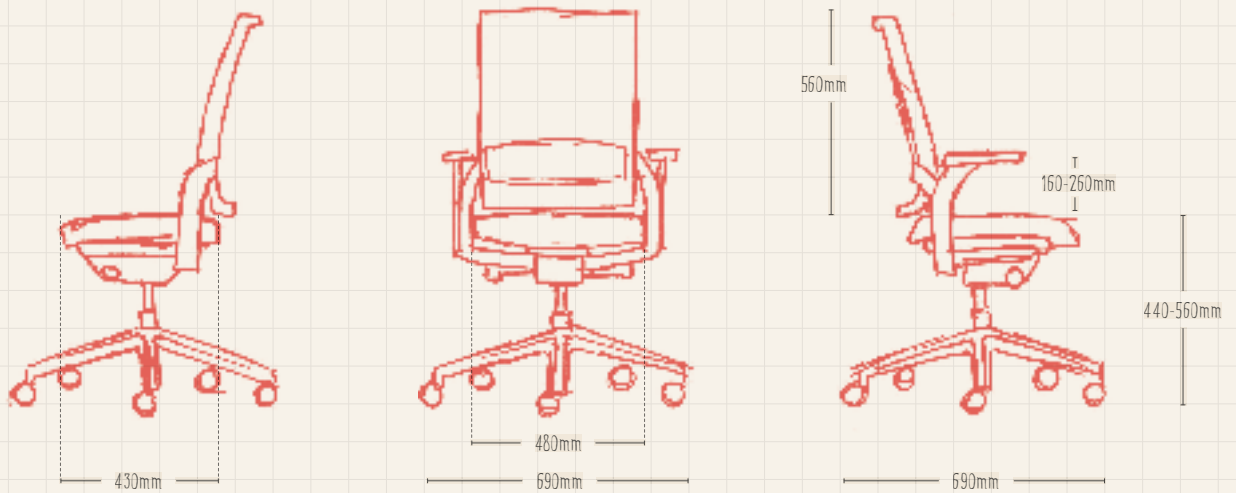

RANGE OVERVIEW

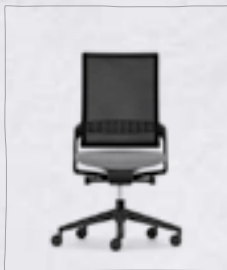

No arms



Height adjustable arms

Task Seating



MESH COLOURS



FRAME/ARM COLOURS



MECHANISM

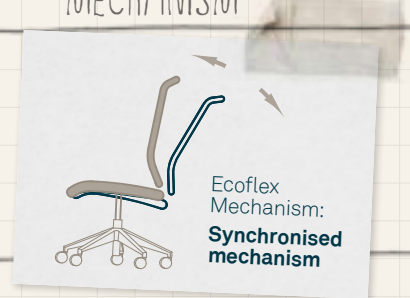

CASTOR OPTIONS

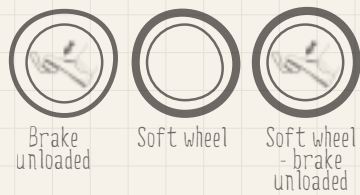

GAS LIFT

STANDARD 150KG/
Heavy duty 190Kg/
Sprung base/
Dual Lift Telescopic/

BASE



Let's get into some detail

SPRINT

STANDARD FEATURES

Black components/ Black base/ Synchronised mechanism with adjustable tension,
back locking function in four positions, including locking upright/
70mm back height adjustment/ 50mm seat depth adjustment/
Width and height adjustable arms* / 65mm castors

(* Selected models only)

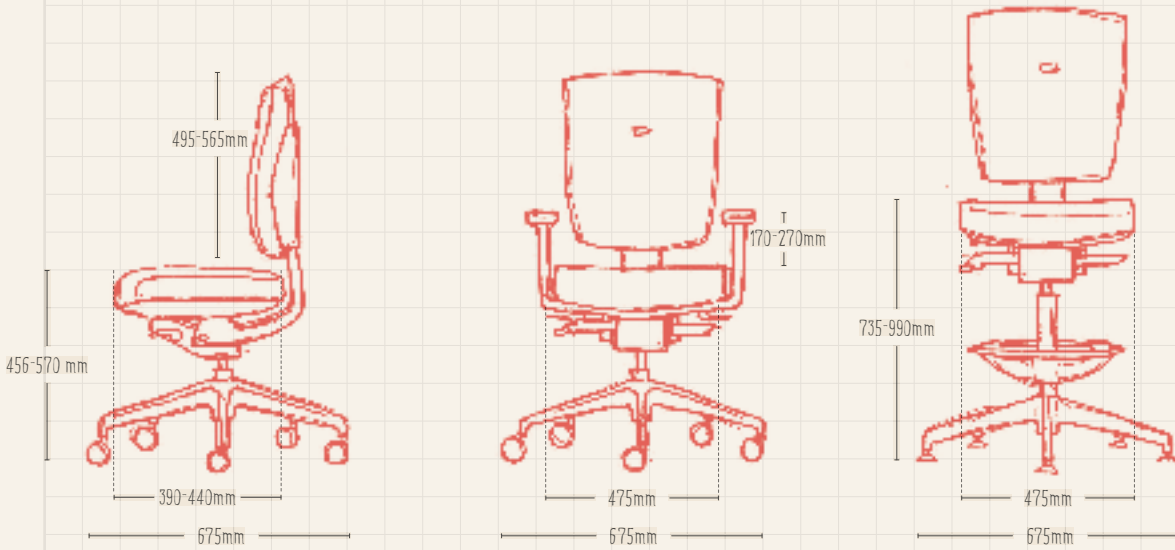

RANGE OVERVIEW



No arms



Height adjustable arms



Width + height adjustable arms



Draughtsman

Task Seating



Don't forget
Two-tone upholstery!

COMPONENT COLOUR

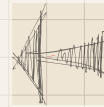

EXTENDED
SEAT SLIDE AVAILABLE

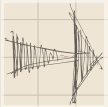

Optional three degree negative seat tilt available

MECHANISM

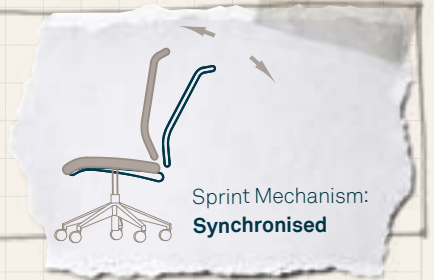

GAS LIFT

STANDARD 150KG/
Heavy duty 190Kg/
Sprung base/ Dual Lift
Telescopic/ Counter
height*/ Draughting height*



BASE

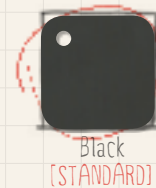

DASH



STANDARD FEATURES

Black components/ Black base/ Synchronised mechanism with adjustable tension, back locking function in four positions, including locking upright/ 70mm back height adjustment/ Width and height adjustable arms*/ 60mm castors

[* -Selected models only]

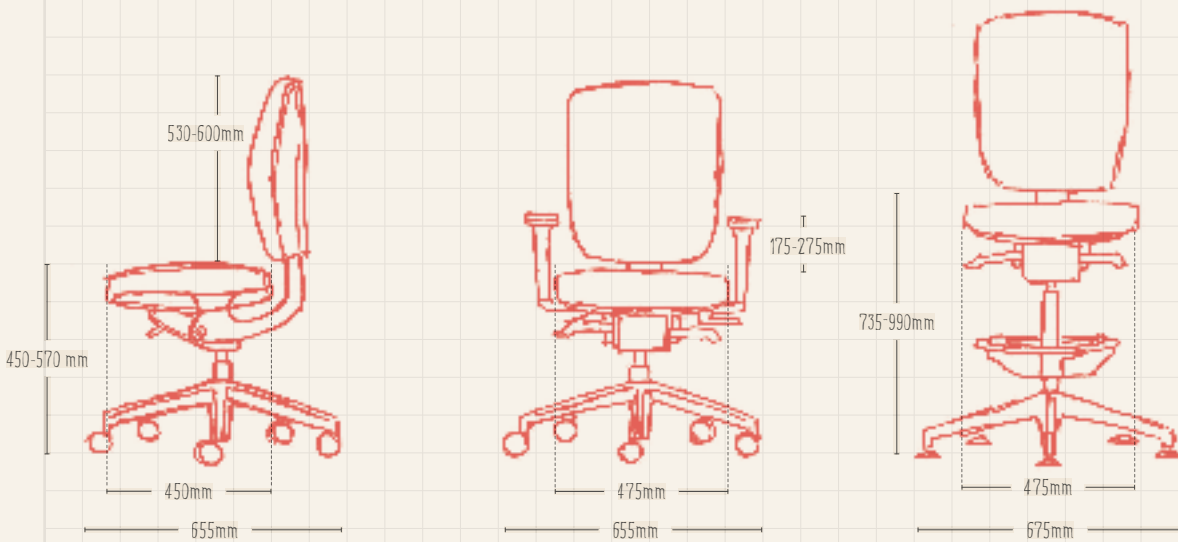

RANGE OVERVIEW



No arms



Height/width adjustable arms



Draughtsman

Let's get into some detail

This chair belongs to:

Print name here.

YOUR CHAIR.

thesenatorgroup.com

OPTIONAL
ADJUSTABLE
LUMBAR

We slip the
USER GUIDE
in here!

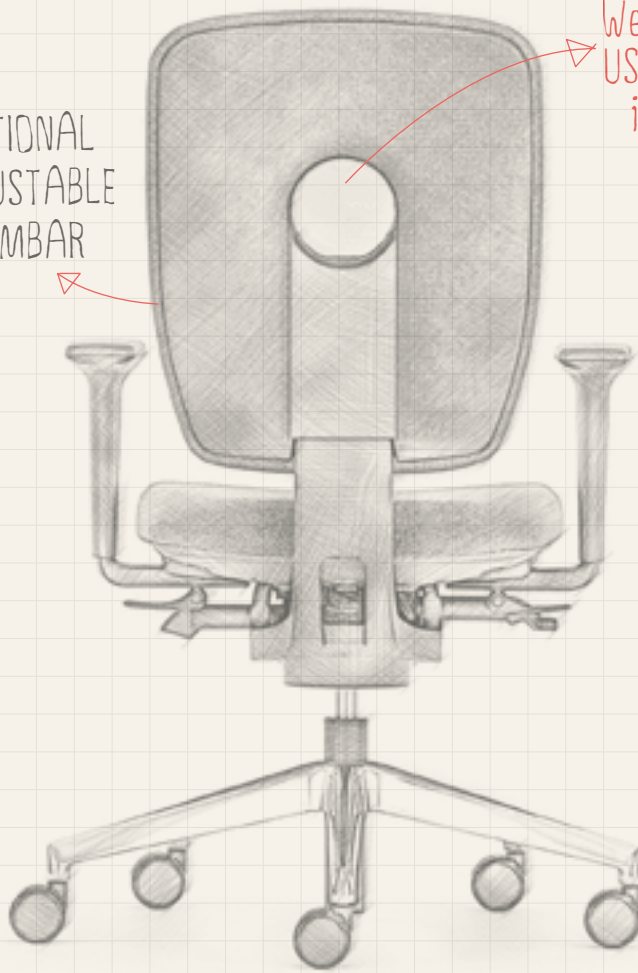

COMPONENT COLOUR

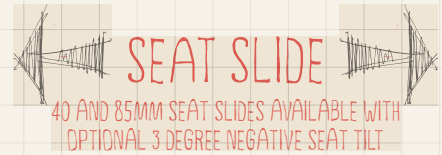
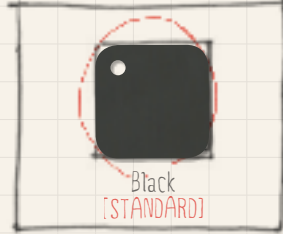

MECHANISM

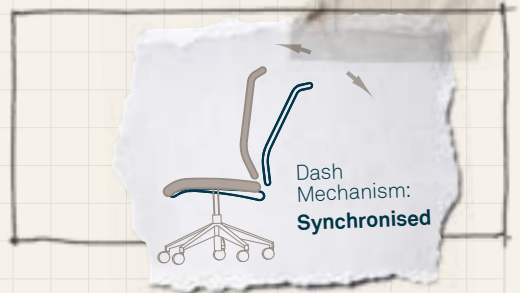

Dash is available with two-tone upholstery!

CASTOR OPTIONS



GAS LIFT

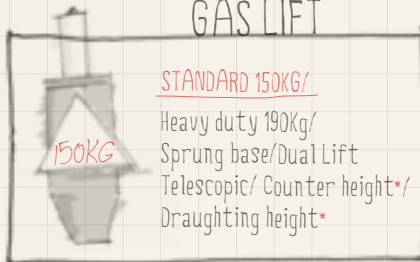

BASE

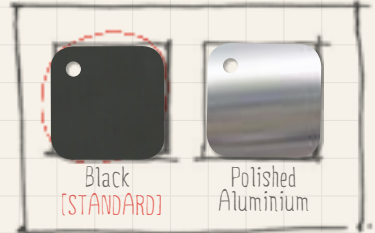

Let's get into some detail

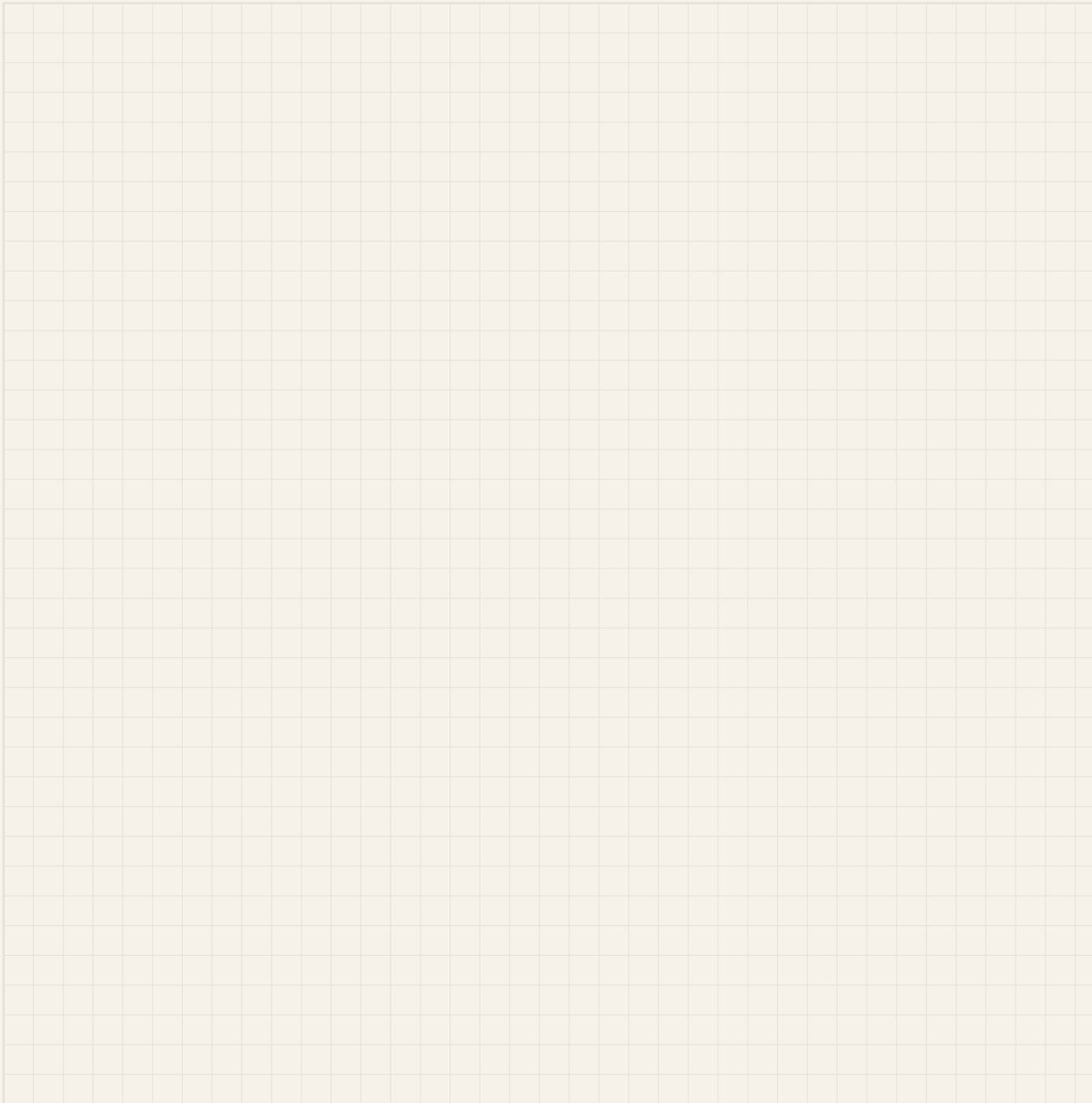

Task Seating

Need it digital?

A copy of this book, product rotations, high resolution images, CAD symbols and more detailed product information are all on our website.

thesenatorgroup.com

Section Two

CHAIR COLLECTION

Senator's collective range of chairs is suitable for a wide range of applications. From training rooms to breakout areas, there is a design to suit any working environment.

034 Circo / 040 Rhapsody / 042 Symmetry / 044 Zenith / 046 Fuse /
047 Freeflex Visitor / 048 Ad-Lib / 066 Trillipse / 072 Elios

Circo

THE ONE AND ONLY

Circo is a functionally simple, light work conference chair for ad hoc touch down working environments. Circo has a permanently floating action and a mesh back that morphs to support the user. These features are suitable for both conference and meeting environments.





Circo

With a choice of upholstered or leather finishes plus the option of an integrated tilt action, Circo effortlessly adjusts to the way you work and the environment you work in. It's equally at home with castors or glides and its meshed back is available in a range of contemporary colours to suit your workplace.

Design by Justus Kolberg



Circo

Circo's designer Justus Kolberg worked closely with toolmakers and injection moulders to exploit the latest technical possibilities of a complex single piece frame to reduce unnecessary material. The result is a chair that's tremendously strong but weighs just over nine kilos – significantly lighter than comparable models on the market.



Circo

Circo fits effortlessly into its surroundings and its features are welcome in conference and meeting environments. It is ideal for collaborative and meeting areas where ideas can be shared.





Rhapsody

Rhapsody, a fully upholstered armchair is an elegant, sumptuous design with flowing lines and contemporary styling.

Design by Paul Brooks



Rhapsody

This design provides the very best in comfort and relaxation. Its curvaceous form and cantilever back make this chair a product of beauty to complement the smartest of interiors.



Symmetry

Honesty and elegance coupled with sophisticated comfort. Symmetry offers eco-friendly design and people friendly ergonomics.

Let's work together



Symmetry

Symmetry is a carefully considered design, featuring a range of complementary cantilever chairs that can be co-ordinated throughout an office environment.

The shell is linked to the frame with polished aluminium castings and the arm pads are made from a tactile soft material.

Chair Collection

—



Design by Martin Ballendat



Zenith

Superbly crisp and refined, Zenith is a meeting and conference chair design with the best in comfort and flexibility. Essentially it is a four legged stacking chair designed with multiple arm and backrest material configurations.



Fuse

Designed for a variety of meeting and conferencing applications. The Fuse chair uses 3D knit mesh to cover both the seat and back.

Let's work together



Freeflex

Freeflex is a general purpose meeting and guest chair, its scale and comfort allow it to be specified freely with confidence around the workplace environment.

Ad-Lib

**ANYTIME
ANYPLACE
ANYWHERE**

Ad-Lib has been developed with fewer components so that it still achieves the versatility needed to build an amazingly wide range of chairs.



Chair Collection





Ad-Lib

Ad-Lib has been designed to be specified for all multi-purpose seating uses throughout the corporate environment; meeting, conference, training, light work or retail environments. It would also be applicable in educational and leisure areas.



Ad-Lib

Ad-Lib's comprehensive solution, considered from the ground up, has a unique build with an extensive series of leg frames which serve to support the chair's potential changes of use.



Ad-Lib

Ad-Lib redefines the current genre of multi-purpose seating. The family of products, while remaining architecturally neutral, respond to the holistic requirements of multi-purpose seating, from a compact stacking chair through to a light work chair.



Ad-Lib

Through the creation of Ad-Lib we have studied the current and developing needs of people and their environments. The result is a highly intelligent structure that provides a vast scope of models and finish options making it easy to specify.



Chair Collection

—



Let's work together

Ad-Lib

With Ad-Lib we set out to redefine the genre of multi-purpose seating. Work today tends to be carried out in a variety of different environments that cater to different needs. The family of products responds to the holistic requirements of multi-purpose seating.





Ad-Lib Scholar

The addition of Scholar to the Ad-Lib family recognises the changing nature of learning. Today the structured formality of education and training environments is being replaced by the need for more interactive and flexible spaces.



Ad-Lib Scholar

An intelligent base can comfortably hold a bag and other personal items, it also integrates a cup holder, reducing the possibility of spillages and extending the working area. Ergonomically designed, the base has a silhouette that allows the user to tuck their heels beneath the chair to help with standing, sitting and moving in and out of table space.



Let's work together



Ad-Lib Scholar

Designed by PearsonLloyd as an addition to the Ad-Lib family. Scholar enables mobility allowing a quick and easy transition between teaching styles and room layouts dependent upon the task.



Ad-Lib Work Lounge

Collaboration is seen as the key to business success today. Ad-Lib Work Lounge has been developed specifically to provide a furniture solution for this, creating a relaxed comfortable seating environment.



Ad-Lib Work Lounge

Designed by PearsonLloyd, Work Lounge features an innovative orbital work surface for left or right handed users with a generous surface space that can be parked in a rear position.

Ad-Lib Work Lounge

Ad-Lib Work Lounge has been developed as a unique solution to enable movement, flexibility and teamwork, breaking away from the static environments of traditional work settings. Described as a 'mobile soft seat', it is designed for collaborative work settings, enabling the user to move location easily.





Chair Collection



Design by Paul Brooks



Trillipse

Trillipse is the original multi-purpose chair family. It is the scale, comfort and uncompromising build quality that has ensured the continued success of this range. The four leg variant was developed as a general purpose meeting chair for the workplace and educational environment.



Trillipse

Trillipse includes a host of options to enhance its versatility. The Motion model adds castors to the base frame, making the chair ideally suited to the educational sector and training rooms.



Trillipse

The Cantilever version of Trillipse further enhances the range and delivers fantastic comfort thanks to its trilliptical cantilever frame.

It is just as at home in compact team meeting spaces as it is in a boardroom thanks to the diversity of finish options.







Elios

Elios is a range of slender and versatile chairs that are equally at home in meeting rooms, seminar and conference facilities, training rooms or restaurants.



Elios

The curvaceous, contoured form of both the seat and back achieve excellent comfort as well as adding to the pleasing aesthetics and universal appeal of this design.



Elios

Moving seamlessly from one area to another in any location, Elios is a visually elegant chair which stacks conveniently, allowing flexibility of use from meeting to conference room or hospitality area.

Also available with a linking device.



Elios

A high density stacking chair which fits comfortably through a standard doorway with up to 40 non upholstered chairs on a trolley and 12 freestanding, this steel wire framed chair is available with or without arms.

Let's work together

NEED IT DIGITAL?

A copy of this book, product rotations, high resolution images, CAD symbols and more detailed product information are all on our website.

thesenatorgroup.com

Innovation Engineered

**Let's Get Into
Some Detail**

CHAIR

COLLECTION

Senator

Let's get into some detail

CIRCO



RHAPSODY

SYMMETRY



ZENITH

FUSE



FREEFLEX



AD-LIB

AD-LIB SCHOLAR



AD-LIB WORK LOUNGE

TRILLIPSE



ELIOS



Let's get into some detail

CIRCO



STANDARD FEATURES

Black components/ Black base/ Height adjustment and free-floating tilt*/
Swivel only*/ Black 3D self supporting mesh back/ Plastic glides*/ 60mm Castors*

[* -Selected models only]

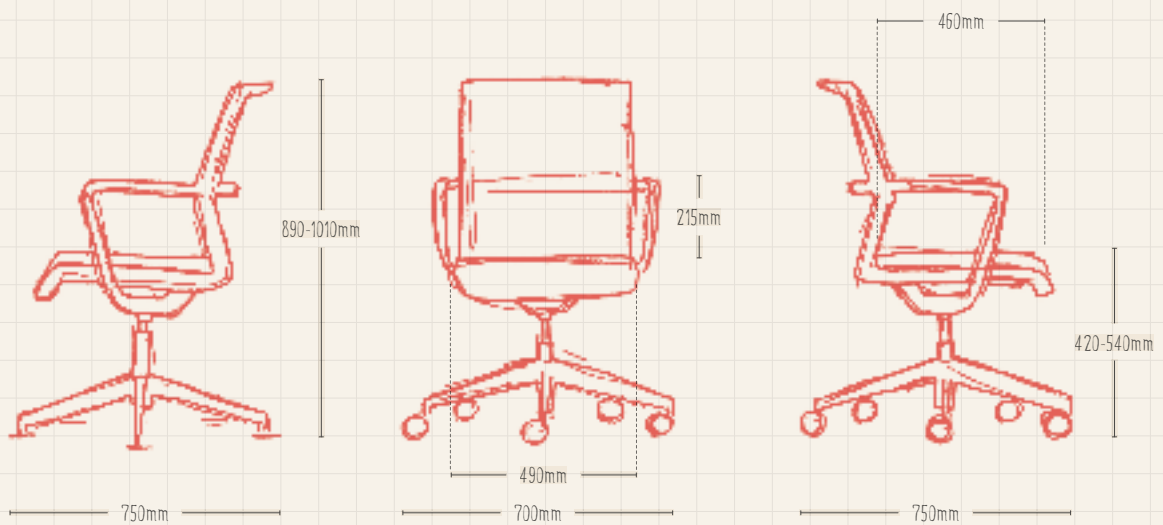

RANGE OVERVIEW



With Castors



With Glides

Collection



MESH COLOURS



FRAME COLOURS

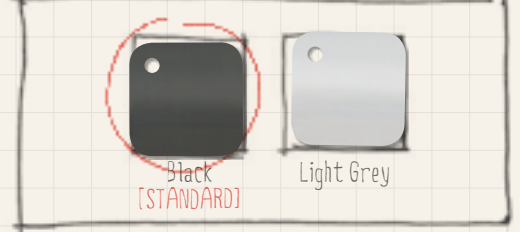

GAS LIFT OPTIONS

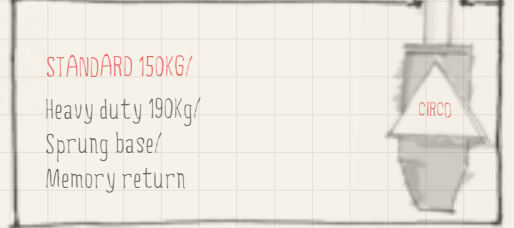

CASTOR OPTIONS

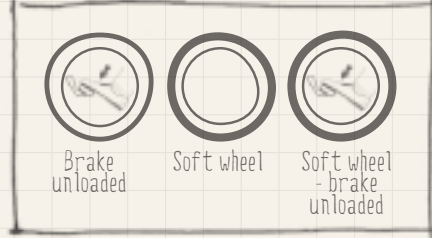

BASE

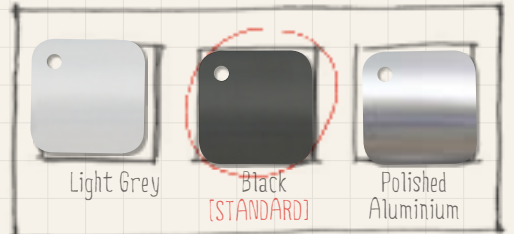

RHAPSODY



STANDARD FEATURES

Fully upholstered/ Synchronised mechanism with adjustable tension and back locking function in 11 positions, including locking upright*/ Tubular steel frame in polished chrome*/ 65mm castors*

[*Selected models only]

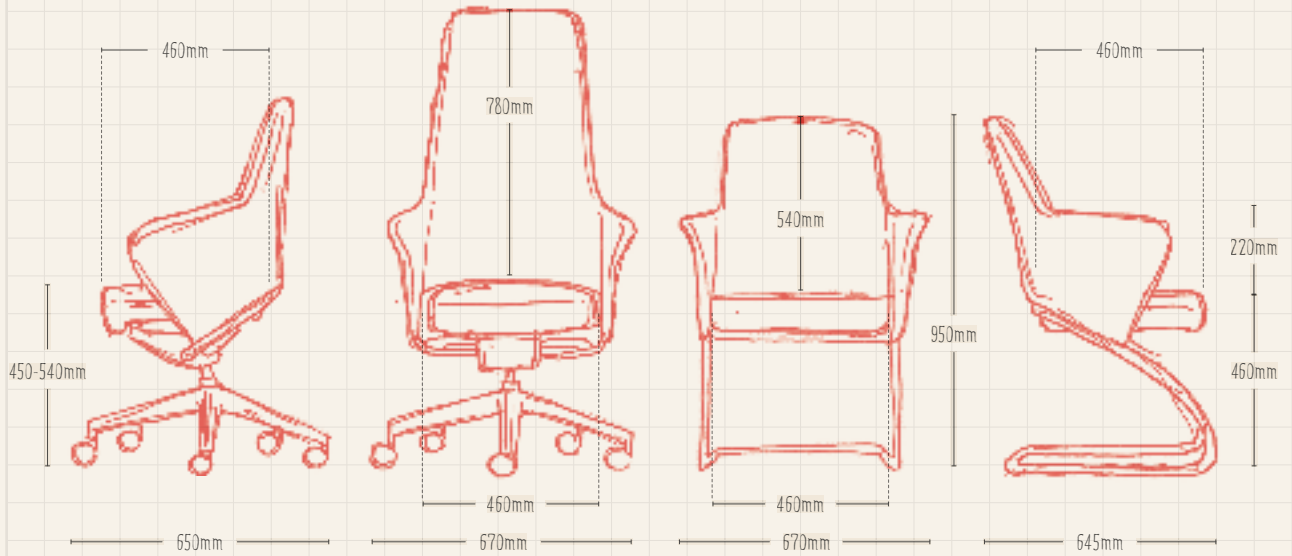

RANGE OVERVIEW



Medium back



High back



Visitor chair

Let's get into some detail



Rhapsody looks great with two-tone upholstery!

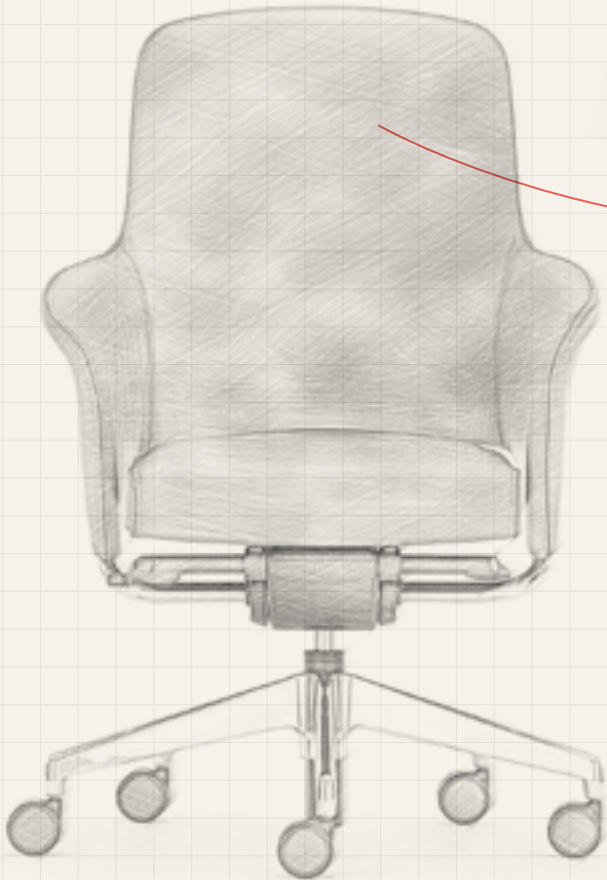

FRAME/ BASE FINISH



Polished Aluminium/ Chrome
[STANDARD]

GAS LIFT



Black
[STANDARD]



Brushed steel



CASTOR OPTIONS



Brake
unloaded



Soft wheel



Soft wheel
- brake
unloaded

GAS LIFT OPTIONS

STANDARD 150KG/
Heavy duty 190Kg/
Sprung base/
Dual Lift Telescopic

MECHANISM

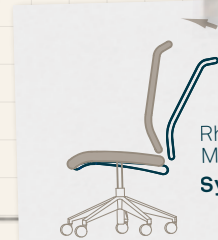

Rhapsody
Mechanism:
Synchronised

SYMMETRY

STANDARD FEATURES

Stacks 3 high* / Fully upholstered / Tubular steel frame in polished chrome /
Polished Aluminium back connectors / Soft touch arm pads

[* - Selected models only]

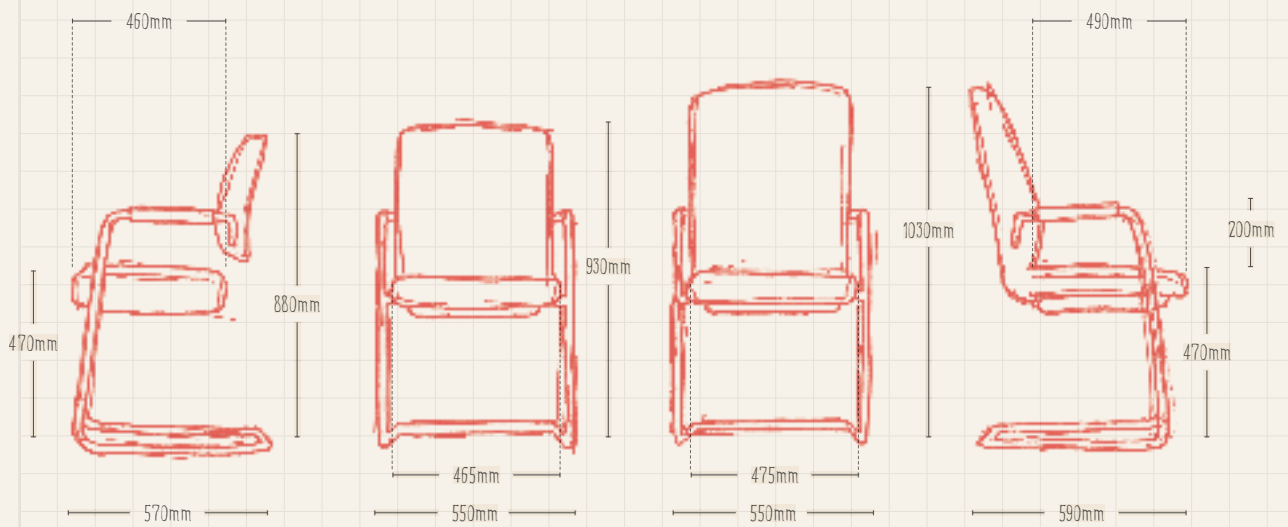

RANGE OVERVIEW



Split seat + back



Mid-back



High-back

Let's get into some detail



STEEL FRAME FINISH



GLIDES

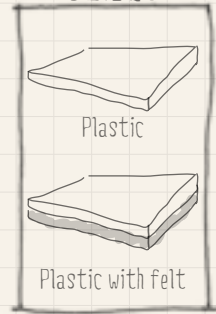

Let's get into some detail

ZENITH



STANDARD FEATURES



Stacks 8 high/ Tubular steel frame in silver EPPC/ Black plastic, upholstered or
Beech clear finish back/ Black plastic arms*/ Plastic glides

[* -Selected models only]

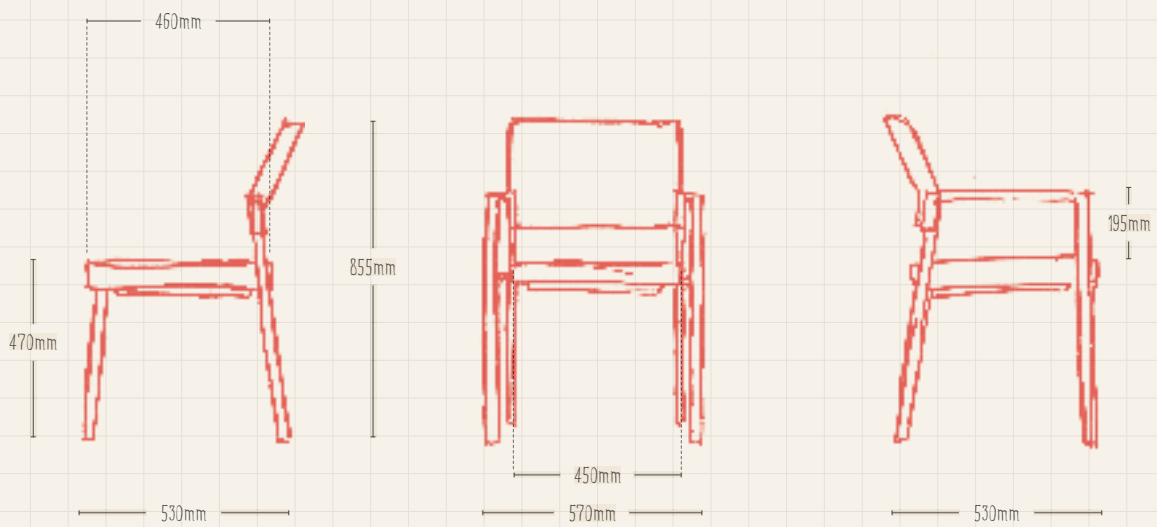

RANGE OVERVIEW



Plastic back



Upholstered seat + back



Wood back



With plastic or wood arms



STEEL FRAME FINISHES

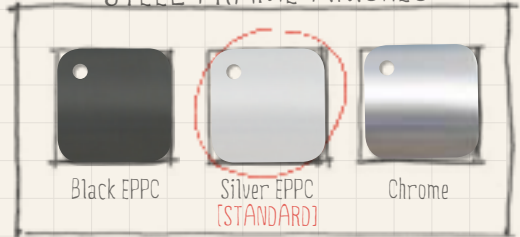

BACK FINISHES



ARM FINISHES



Zenith is available with two-tone upholstery!*

LINKING DEVICE

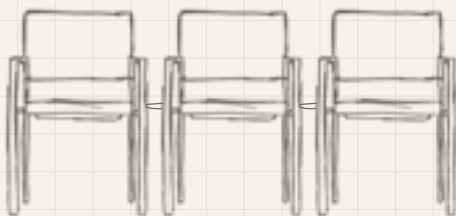

GLIDES



Beech back and arms can be stained as an option.

FUSE



STANDARD FEATURES

Stacks 4 high/ 3D knit seat and back in Black/
Tubular steel frame in Black EPPC/ Plastic arms in black*/ Plastic glides

[*-Selected models only]

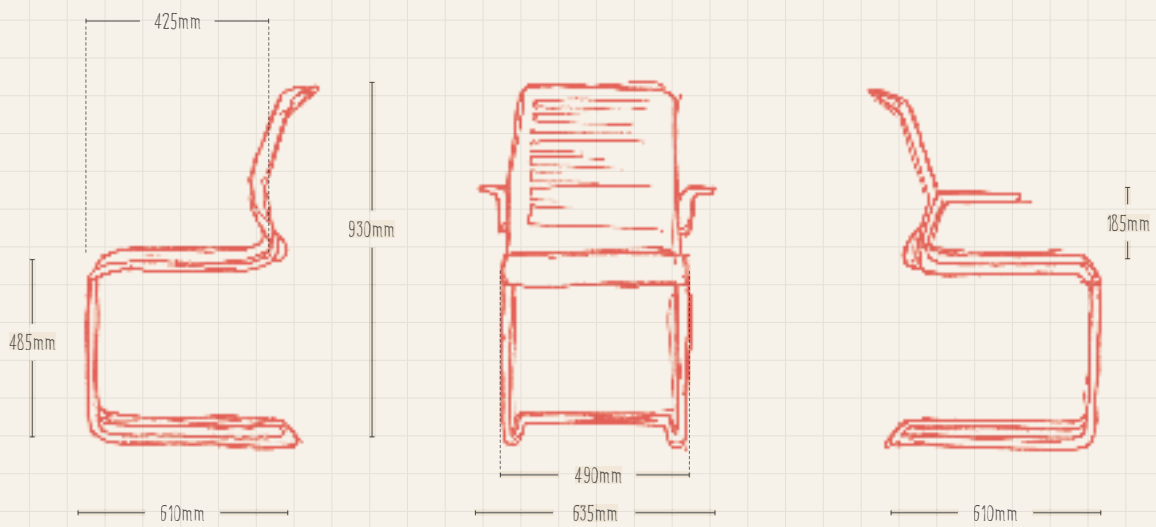

RANGE OVERVIEW



No arms



With Arms

Let's get into some detail



3D KNIT COLOURS



Black
[STANDARD]

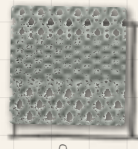

Grey

STEEL FRAME FINISHES



Black EPPC
[STANDARD]



Silver EPPC



Chrome



FREEFLEX



STANDARD FEATURES



Stacks 3 high/ Black plastic components/ Tubular steel frame in polished chrome/
Contrasting mesh side panels on the seat and back/ Soft touch arm pads

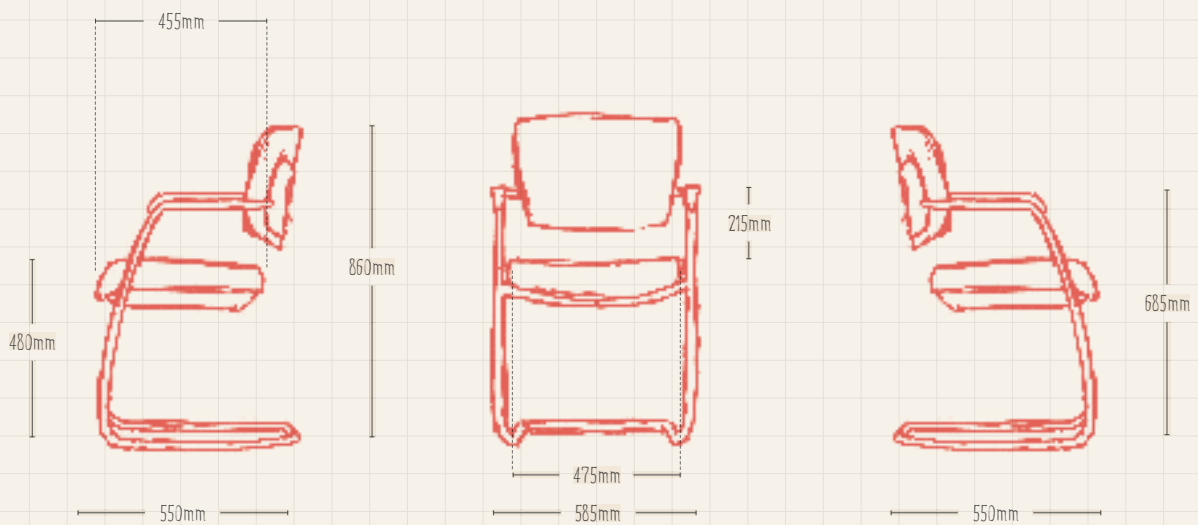



OUTER BACK/ SOFT TOUCH ARMPAD



BREATHABLE MESH SIDE PANELS



FRAME FINISH



GLIDES

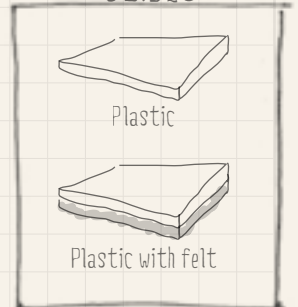

Freeflex Visitor is available with two-tone upholstery

Let's get into some detail

AD-LIB



STANDARD FEATURES

Injection moulded seat and back frame in black plastic/ Plastic or upholstered seat and back/ Moulded seat foam with integrated flexible membrane*/ Back frame with integral arms in a soft touch plastic*

[* Selected models only]

SKID

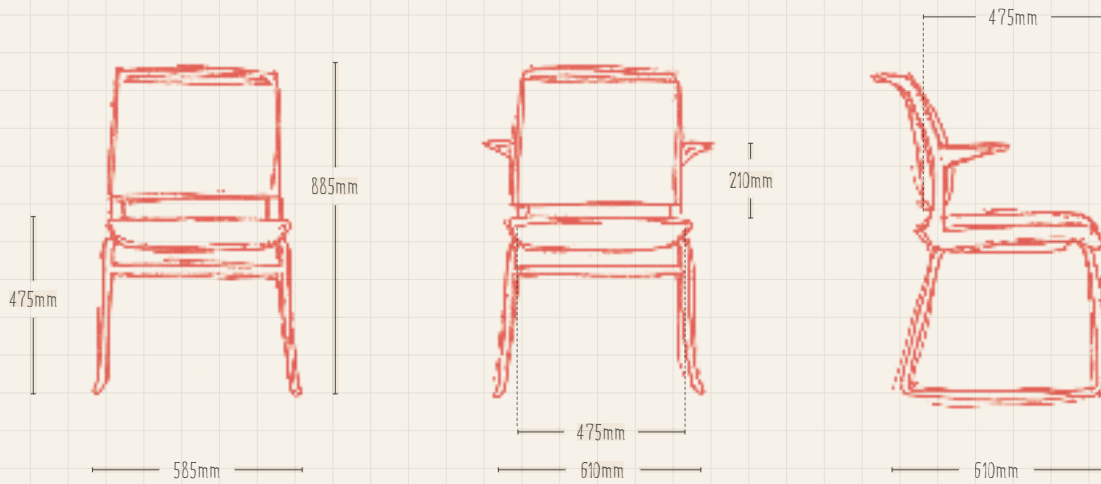

Chair Collection

FOUR LEG

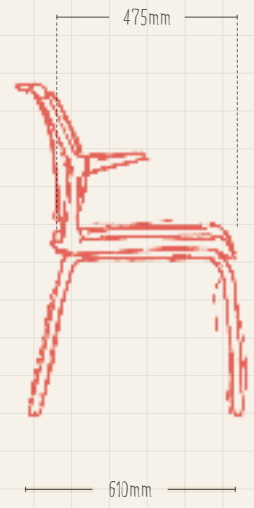
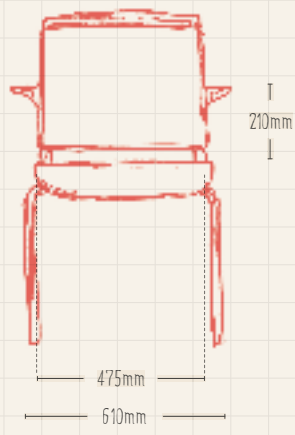
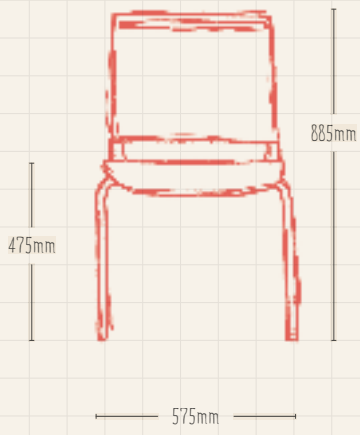

CANTILEVER

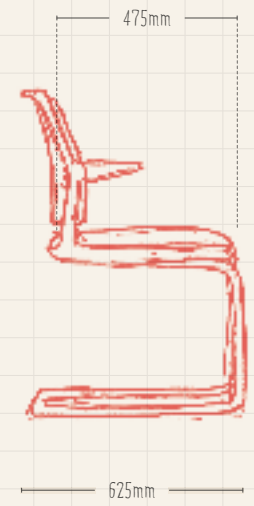
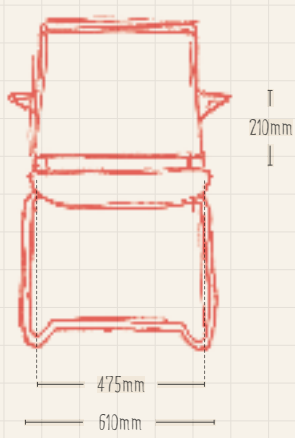
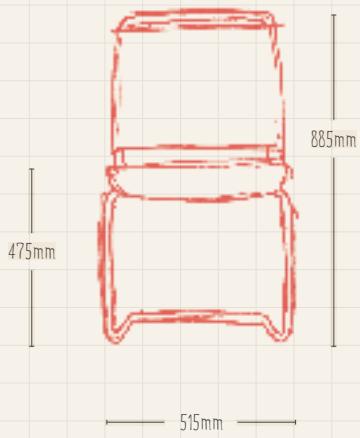

MOTION

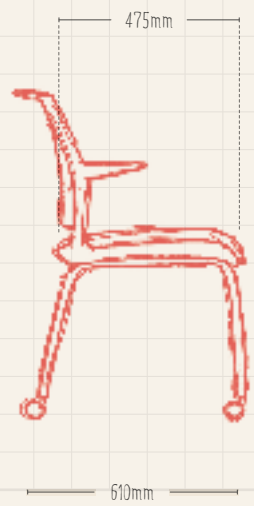
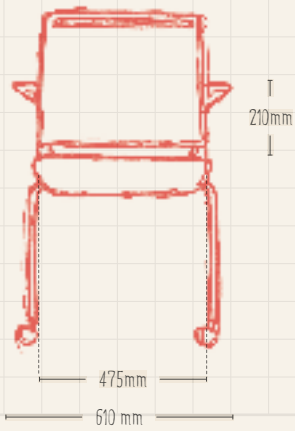
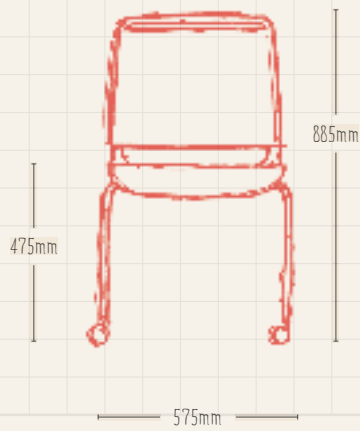

Let's get into some detail

AD-LIB

STANDARD FEATURES

Injection moulded seat and back frame in black plastic/ Plastic or upholstered seat and back/ Moulded seat foam with integrated flexible membrane*/ Back frame with integral arms in a soft touch plastic*

[*Selected models only]

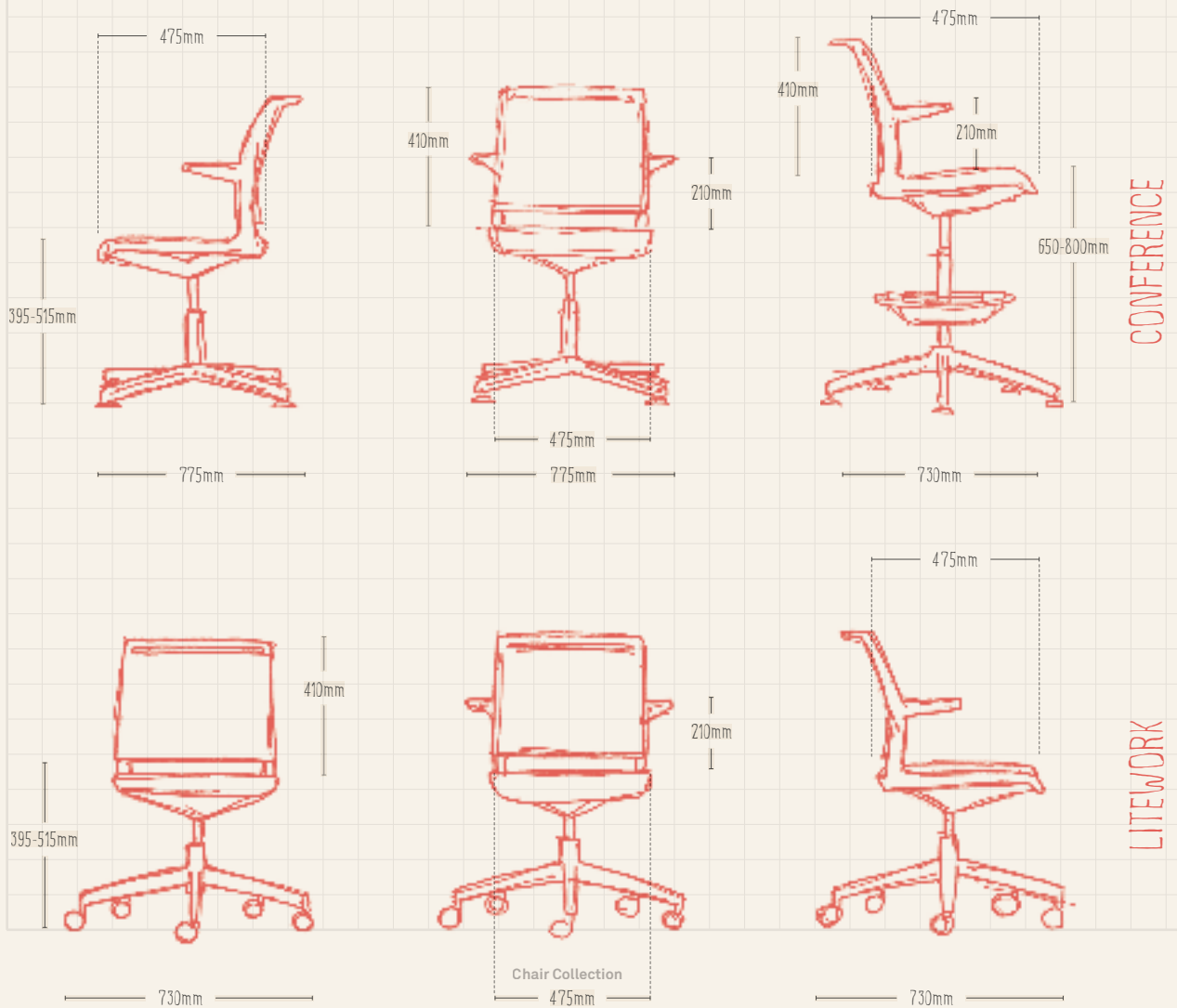

Let's get into some detail



SEAT FRAME/ BACK COLOURS

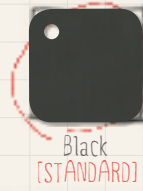

PLASTIC SEAT/ BACK



STEEL FRAME FINISHES



FLEXI-BACK OPTION AVAILABLE

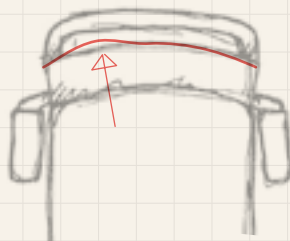
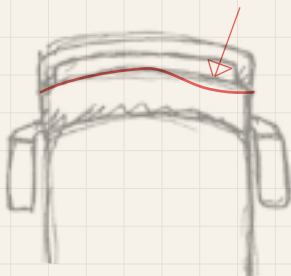

BASE

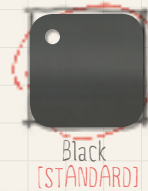

AD-LIB SCHOLAR

STANDARD FEATURES

Injection moulded plastic seat and back frame in anthracite/ Plastic or upholstered seat and back/ Tubular steel support base, incorporating four casters and storage tray in anthracite/ Soft touch orbital fold down work surface in anthracite/ 50mm Castors

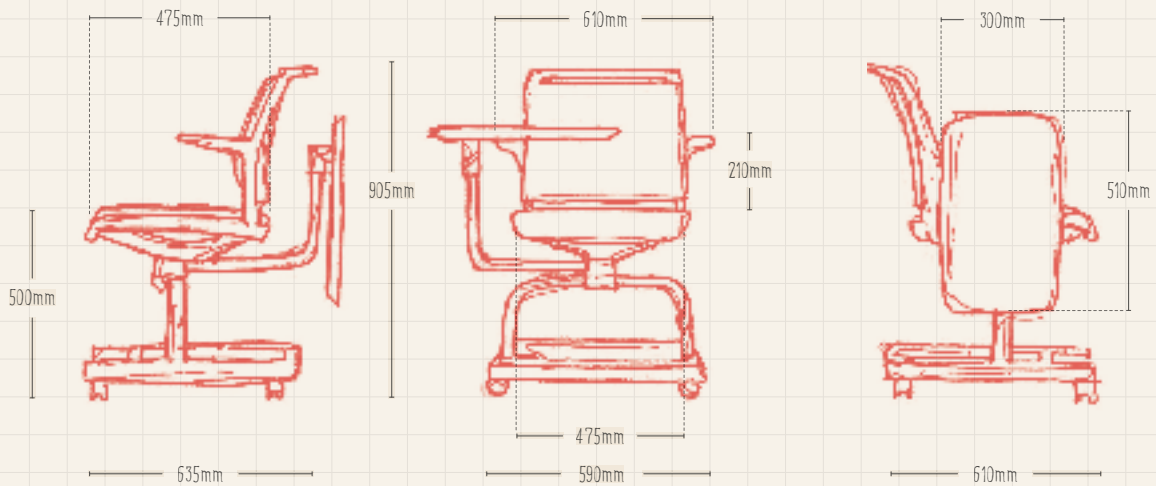

360°
ROTATION
TABLET

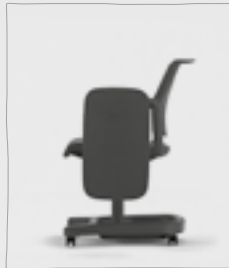

Ad-Lib Scholar is available with two-tone upholstery



Soft wheel castors available

FRAME + COMPONENT COLOUR



Anthracite
[STANDARD]

Seat/back frame - Plastic
Seat and back panel - Plastic
Tubular steel support base - EPPC
Storage tray - Plastic

CONTOURED SEAT+BACK PANEL



Signal Red



Fern Green



Blue



Light Grey



Black



Anthracite
[STANDARD]

Tray and drinks holder!

FLEXIBLE MEMBRANE BACK



Light Grey



Black



Anthracite

Button activated swivel hinge for easy storage - just drop the tablet and rotate away!

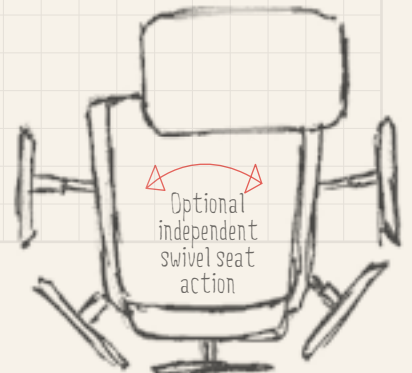
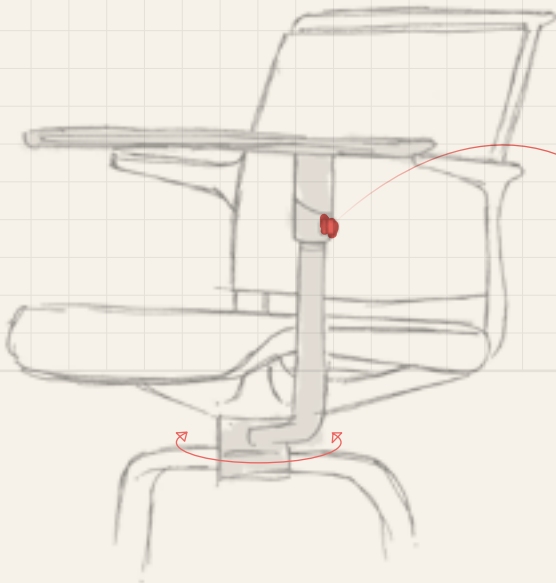

AD-LIB WORK LOUNGE

STANDARD FEATURES

Tubular steel back frame with foam overmould/ Fully upholstered in a select range of fabrics/
Fully upholstered height adjustable headrest*/ Four star Aluminium base and column in anthracite EPPC/
50mm Castors*/ Glides*

(* Selected models only)

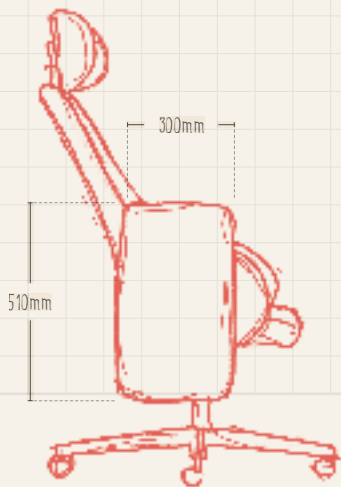
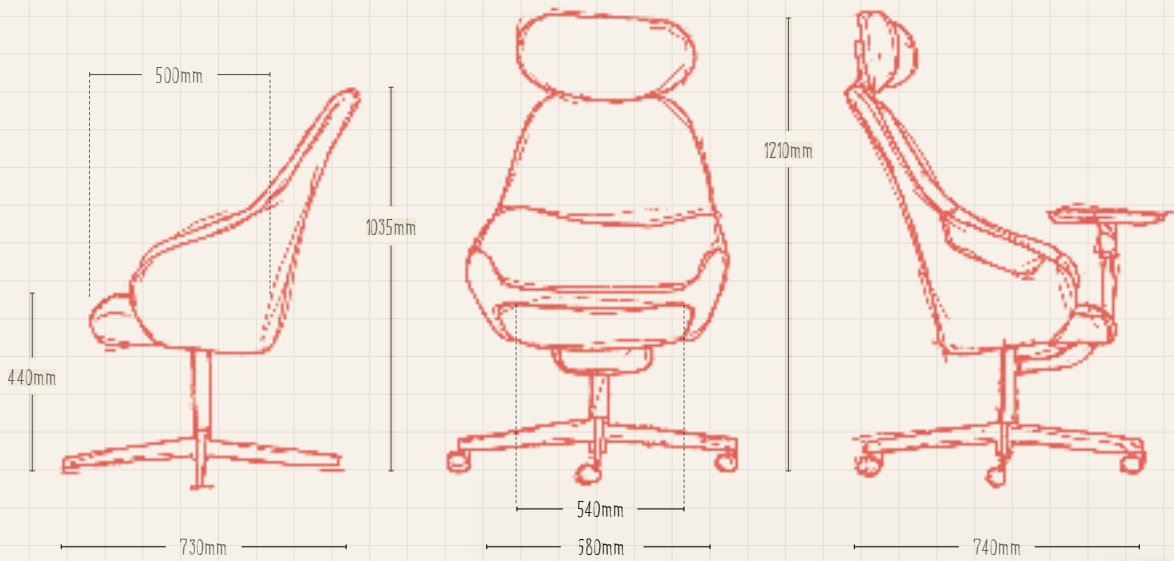

RANGE OVERVIEW



Chair

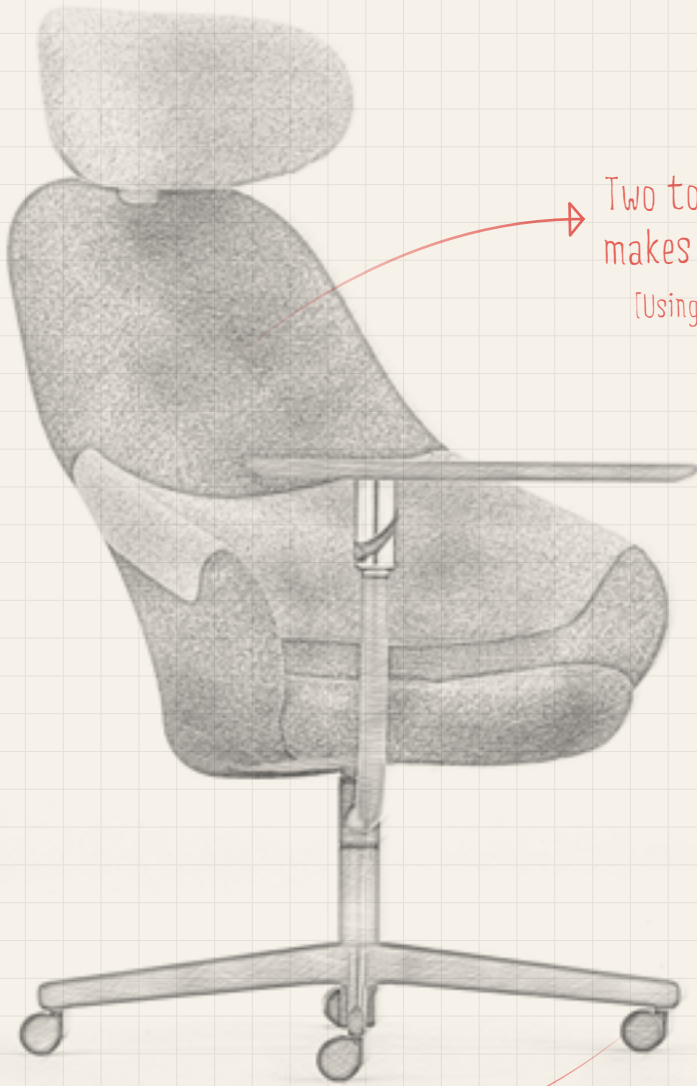

Two tone upholstery really makes this chair come alive!
[Using a select range of fabrics]

SOFT TOUCH
ORBITAL
WORKSURFACE



BASE



Soft wheel castors available

OPTIONAL ORBITAL
WORKSURFACE

Button activated swivel hinge
for easy storage - just drop the
tablet and rotate away!

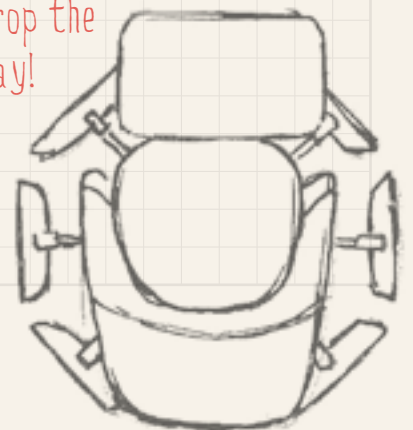
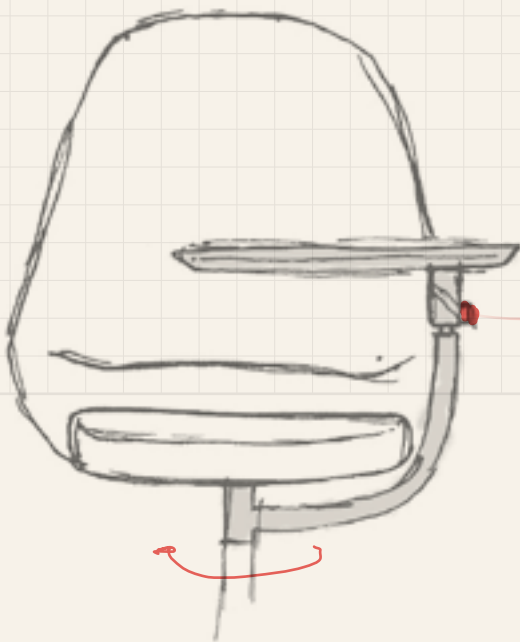

Let's get into some detail

TRILLIPSE

STANDARD FEATURES

Stacks 5 high*/ Trilliptical steel frame in silver EPPC/
Upholstered or black plastic back/ Plastic arms in black*

[* - Selected models only]

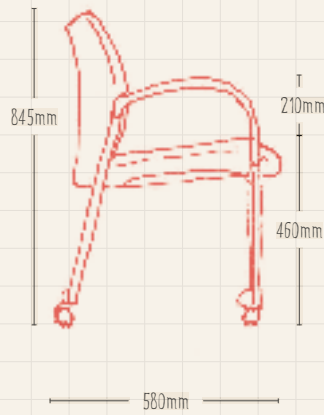
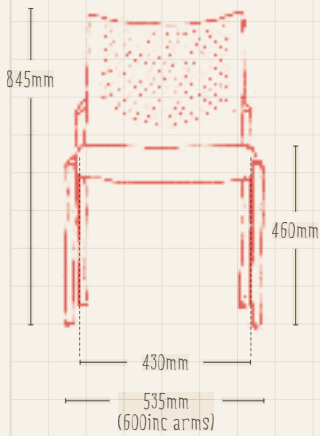

RANGE OVERVIEW



Four legged



Motion

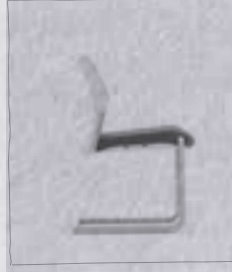

Cantilever



Writing tablet

Chair Collection

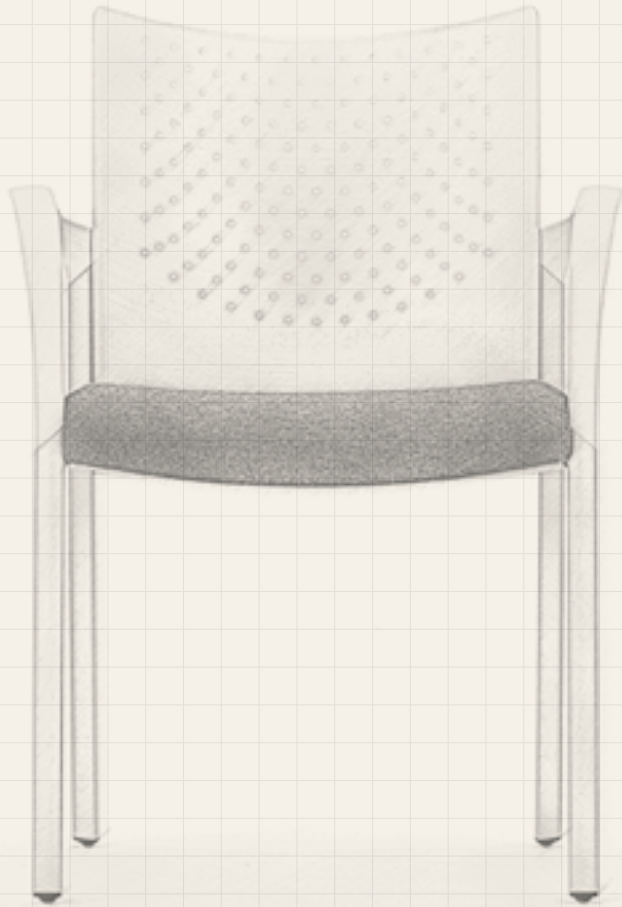

PLASTIC BACK COLOURS



Black
[STANDARD]

Light Grey

Dark Grey

White

ARM COLOURS



Black
[STANDARD]

Light Grey

Dark Grey

STEEL FRAME FINISHES



Black EPPC

Silver EPPC
[STANDARD]

Chrome

OPTIONS

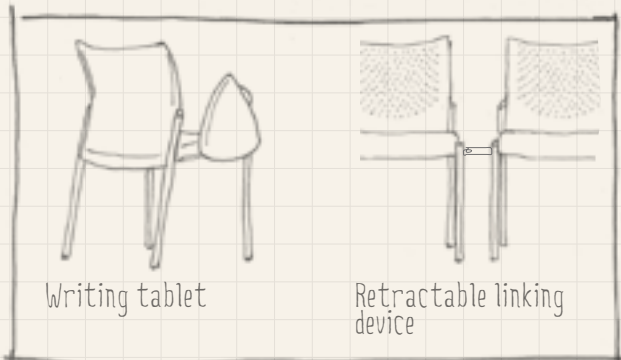

Writing tablet

Retractable linking device

Trillipse is available with two-tone upholstery
Under seat wire basket also available

GLIDES



Plastic



Plastic with felt



Trillipse Trolley
Enables 4 leg to stack 10 high

Let's get into some detail

ELIOS



STANDARD FEATURES

Stacks 12 high/ Wire frame in polished chrome/ Plastic back in black/
Plastic seat in black/ Upholstered seat and back*/
Plastic arms in black*/ Underseat stacking shroud

[*Selected models only]

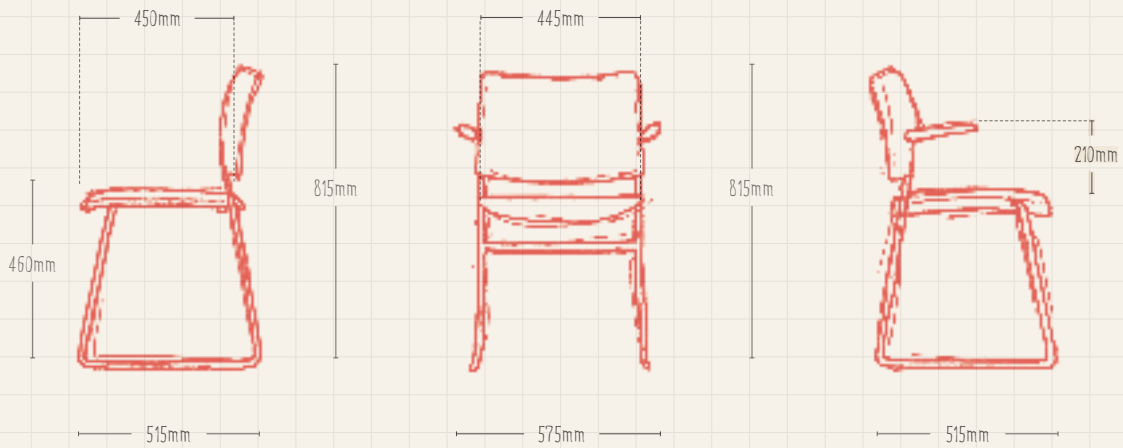

RANGE OVERVIEW



Plastic seat+back



Upholstered seat



Upholstered seat+back

WIRE FRAME



PLASTIC SEAT/BACK COLOURS



White



Putty



Grey



Purple



Blue



Red



Green



Yellow



Orange

GLIDE OPTIONS

Plastic/ With felt/ Linking glide

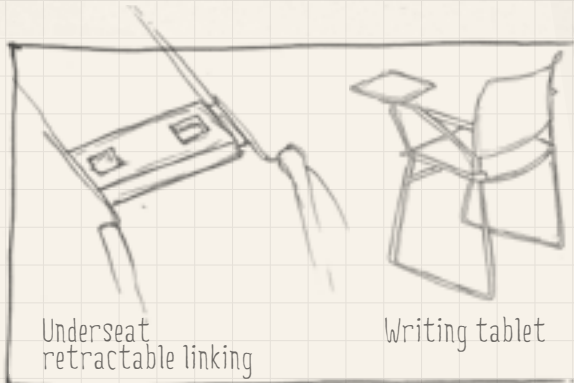

Underseat retractable linking

Writing tablet

Elios is available with two-tone upholstery



Elios Stacks 12 high

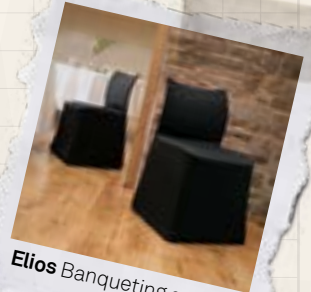

Elios Banqueting cover



Elios Trolley enables stacking of 40*

Need it digital?

A copy of this book, product rotations, high resolution images, CAD symbols and more detailed product information are all on our website.

thesenatorgroup.com



Section Three

TABLE SYSTEMS

Produced using the finest materials, Senator's collection of tables are elegantly designed and well engineered. Combining functionality and style they are ideal for a variety of applications.

078 Ad-Lib / 088 Pivot / 092 Axis / 096 Play /
100 Chameleon / 104 Acumen

Ad-Lib

**COMMON
DESIGN
LANGUAGE**

The Ad-Lib table family designed by PearsonLloyd, has been developed principally to work with the Ad-Lib seating range and shares common design values and architecture.



Table Systems

—



Let's work together

Ad-Lib Tables

VISUAL TRANSPARENCY AND INHERENT STRENGTH.

Lean material usage and sustainability were fundamental in the Ad-Lib table range's development, as was the desire to develop a truly universal table family with a very small inventory of components.

The Ad-Lib meeting table offers a range of shapes, configurations and finishes. Simple, adaptable and practical, it can be used in a variety of environments.







Table Systems

—



Let's work together



Ad-Lib

Designed with collaboration and versatility in mind, Ad-Lib tables offer configurations to support productivity from small impromptu gatherings to large group meetings.

Table Systems

—



Let's work together

Ad-Lib Tables

VISUAL TRANSPARENCY AND INHERENT STRENGTH.

The Ad-Lib table family spans from 800mm coffee tables through to vast boardroom tables. Rectangular and soft rectangular tables can be specified with in top power, data and AV connections in a variety of standard configurations.



Pivot

USER FRIENDLY FOLDING

Pivot tables actively adapt and change with the needs of today's training, meeting and conference environments. Pivot tables allow for individual use, small groups and can be reconfigured easily with its one touch release mechanism, into larger more diverse configurations and function layouts.







Axis

**NO TIME?
IT'S NO
PROBLEM**

Axis is an innovative and functional table system. Designed around a patented hinge, the table frame folds within its own length for ease of reconfiguration, storage and transportation.







Play

**SIMPLE
PLAYFUL
FUN**

The Play meeting table has an elegant poise with its slimline leg and oversized levelling adjuster. Its visual lightness masks the table's strength.







Chameleon

**MINIMAL
VISUAL
IMPACT**

Chameleon is a simple but elegant table system. The uncluttered detailing allows the tables to be used either individually or arranged to suit a wide range of different spatial and functional requirements.





Chameleon

Chameleon is a simple but elegant table system. The uncluttered detailing allows the tables to be used either individually or arranged to suit a wide range of different spatial and functional requirements.



Acumen

**CLEAN
CRISP
DETAILING**

The Acumen meeting table range brings finesse, quality and contemporary styling to any environment it graces. Traditional skills and meticulous veneer selections and cabinetry are fused with a lightweight structure, to provide a stunning solution that performs flawlessly in any working environment.



Acumen

Acumen possesses a contemporary yet timeless classic look through the use of clean lines and crisp detailing. This is matched with a choice of rich lavish materials and exceptional finishing.





Let's work together

NEED IT DIGITAL?

A copy of this book, product rotations, high resolution images, CAD symbols and more detailed product information are all on our website.

—
thesenatorgroup.com

Innovation Engineered

**Let's Get Into
Some Detail**

TABLE

SYSTEMS

Senator

Let's get into some detail

AD-LIB



PIVOT

AXIS



CHAMELEON



PLAY



Table Systems

AD-LIB



White with Silver Edging



Winter Oak MFC

25MM MFC FINISHES



CONTRAST EDGING



FRAME



REFORMED VENEERS

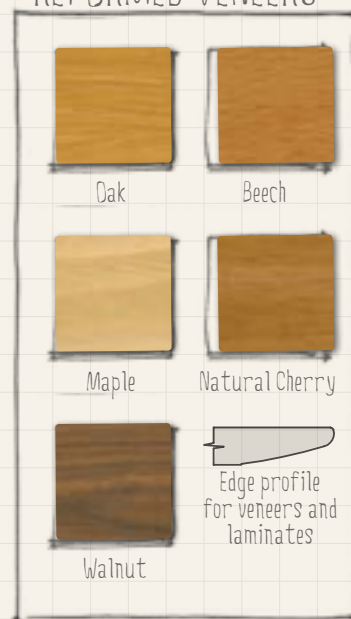

A-RANGE LAMINATES

A wide choice of A-range laminates are also available

FRAME TYPES



The collection covers 4 leg types all sharing a common aesthetic and common components.



4-STAR

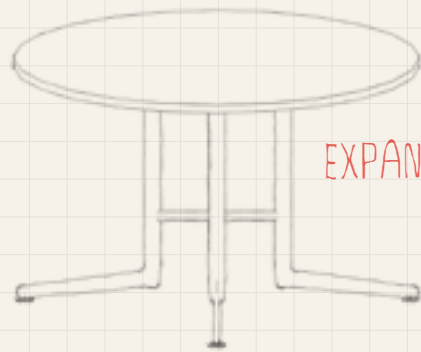

EXPANDED 4-STAR



I-LEG



J-LEG

Unlimited

The vast range of options offers unlimited configurations, from small impromptu gatherings, to large group meetings.

TOP SHAPES



CIRCULAR



SQUARE



SOFT RECTANGULAR

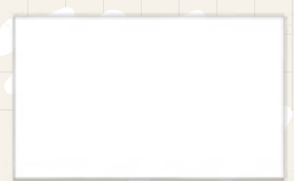

RECTANGULAR

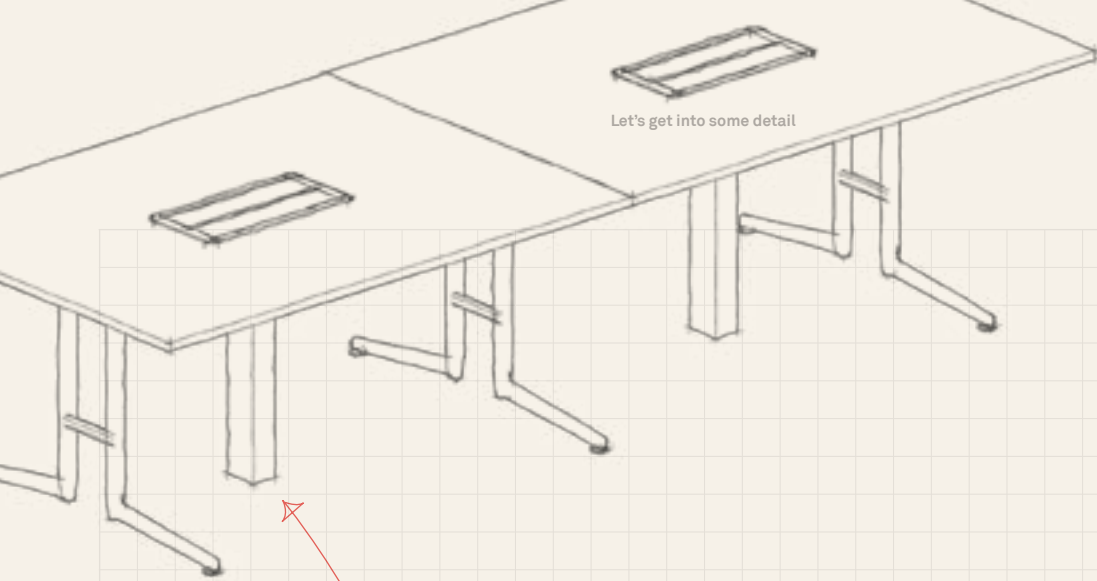

Let's get into some detail

POWER UP



Ad-Lib I and J frame Meeting tables can be specified with the additional benefit of centrally integrated units to house AV, Power and Data outlets

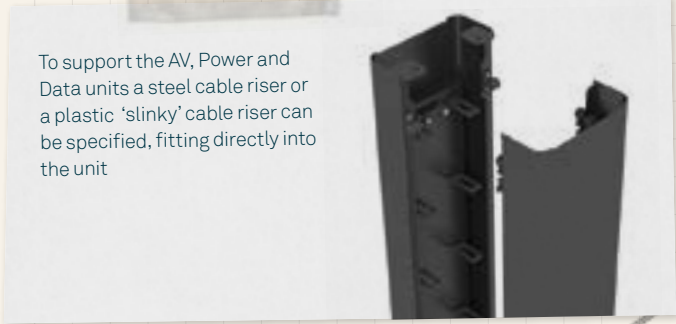

To support the AV, Power and Data units a steel cable riser or a plastic 'slinky' cable riser can be specified, fitting directly into the unit

CONNECTION

- Power
- Data
- AV

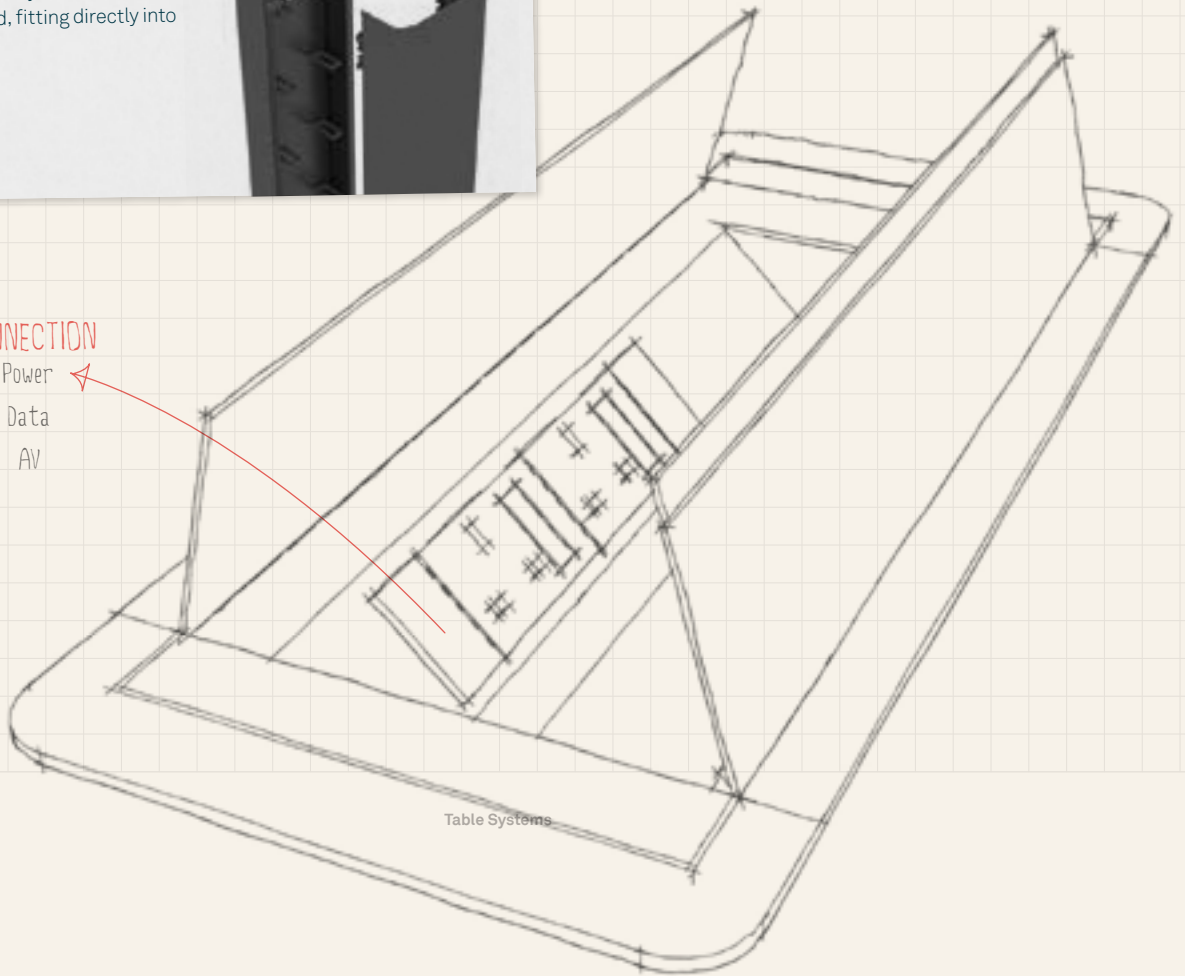
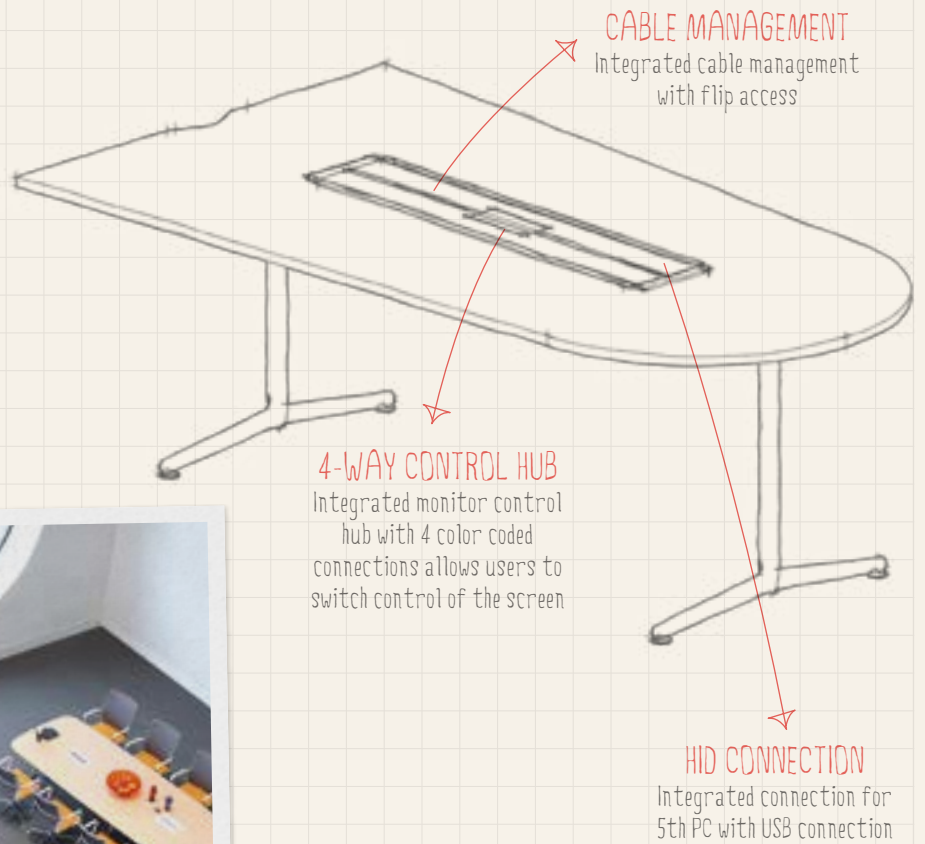

Table Systems

MEDIA TABLE

Partnering an Ad-Lib Media Table with an Allermuir Haven Team Work Pod or Senator Workwall creates an ideal environment to facilitate collaborative working, using laptops, tablets or smart phones.



POWER SOCKETS
Integrated power sockets for 4 laptops

CONFIGURATIONS



AL08RD AL10RD AL12RD AL15RD



AL08SQ



AL10SQ



AL12SQ



AL15SQ



AL1208RC



AL1408RC



AL1608RC

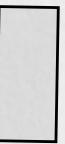

AL1808RC



AL2008RC

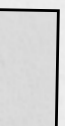

AL1610RC



AL1810RC

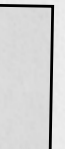

AL2010RC

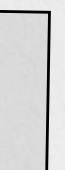

AL2210RC



AL2410RC



AL2610RC

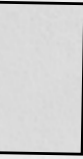

AL2012RC

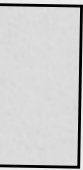

AL2212RC

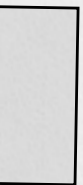

AL2412RC

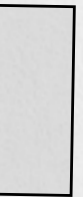

AL2612RC

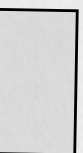

AL2014RC

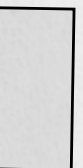

AL2214RC

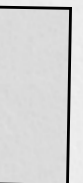

AL2414RC

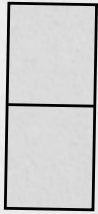

AL2812RC



AL3012RC

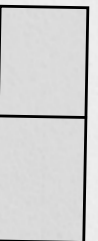

AL3212RC

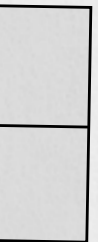

AL3214RC



AL4014RC



AL1809SR

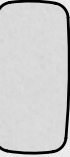

AL2010SR

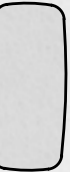

AL2210SR

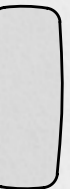

AL2410SR

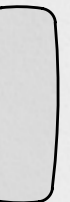

AL2610SR



AL3010SR



AL2212SR



AL2414SR

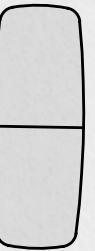

AL3212SR

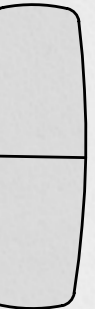

AL4014SR



AL2010TW

Let's get into some detail

PIVOT

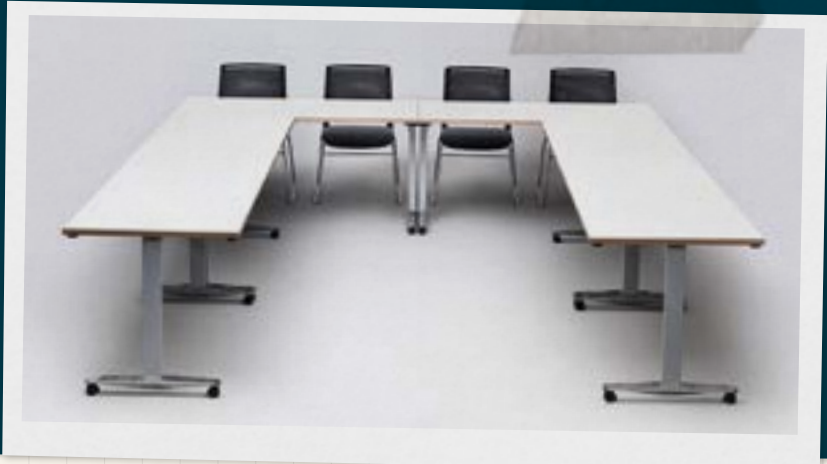

25MM MFC FINISHES



REFORMED VENEERS



REFORMED VENEER INLAID+BANDED



FRAME



TOP SHAPES



SQUARE



RECTANGULAR



SEMI CIRCULAR



TRAPEZOIDAL

FRAME TYPES

The Pivot table is designed to meet a multiplicity of requirements from impromptu meetings to the prestigious conference facility.

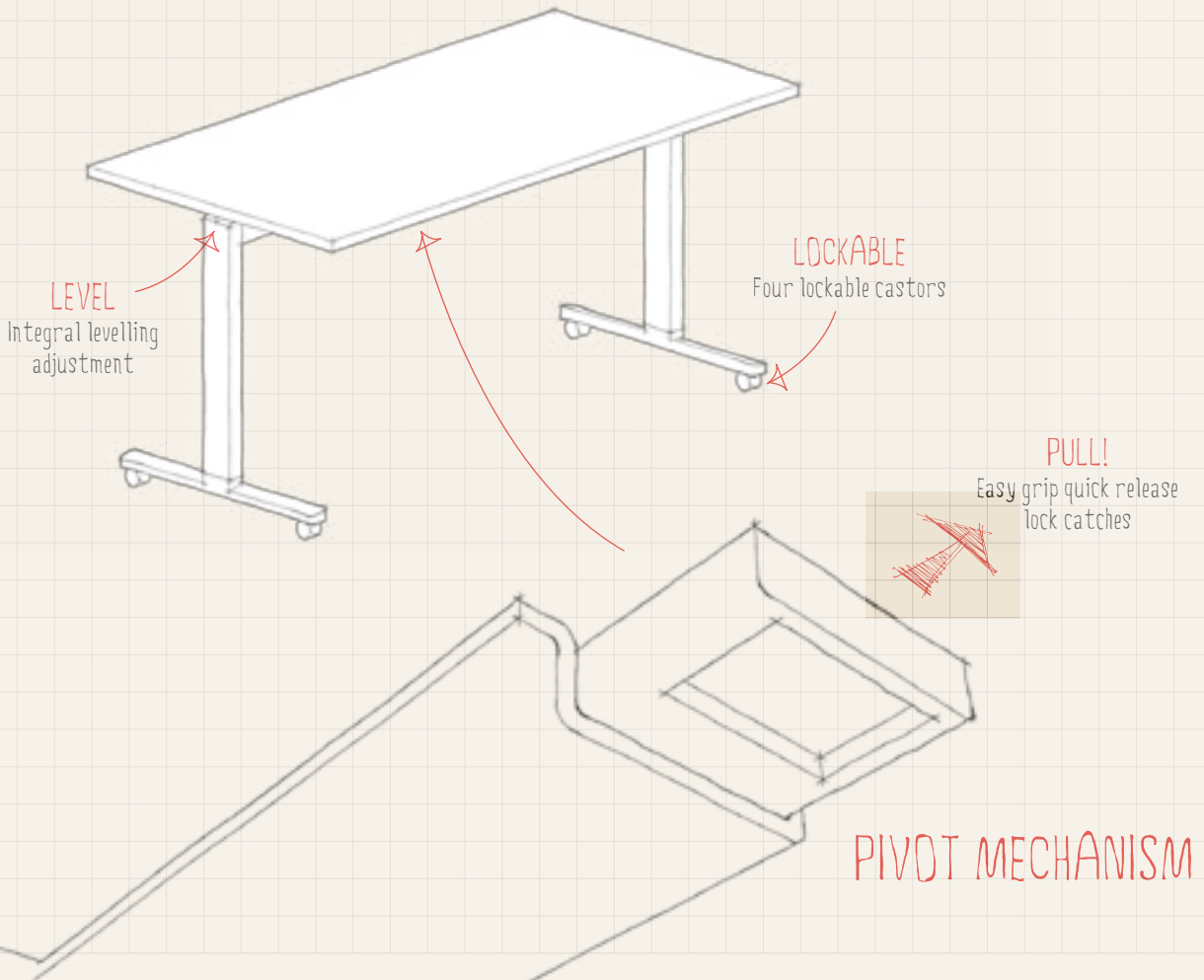

PIVOT
Table top rotates
through 90 degrees

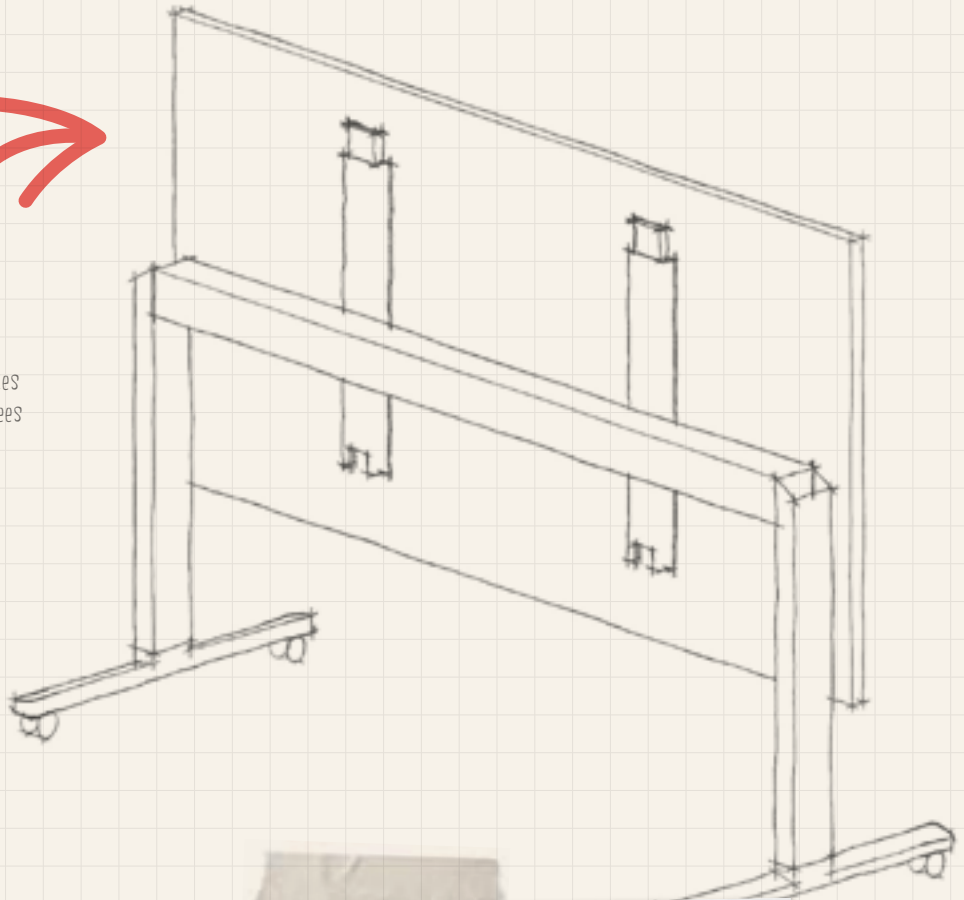

Pivot can be quickly assembled,
rearranged, stacked and stored,
saving space and time.



CONFIGURATIONS

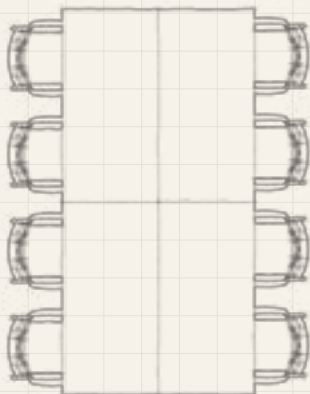
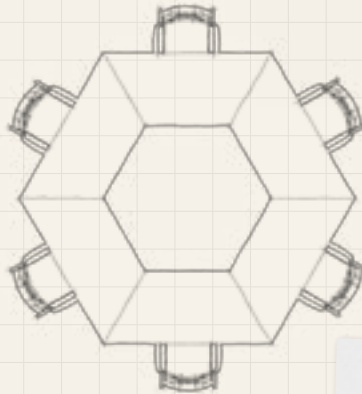
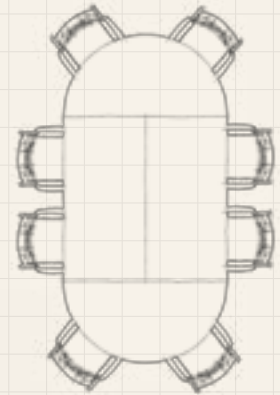
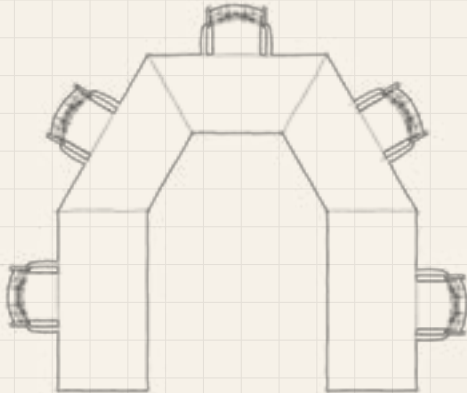

Optional linking device for securing configurations

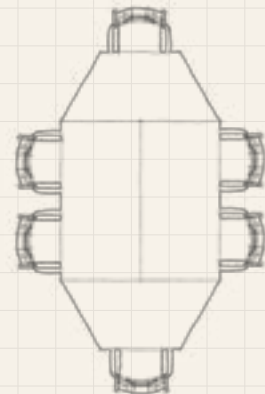
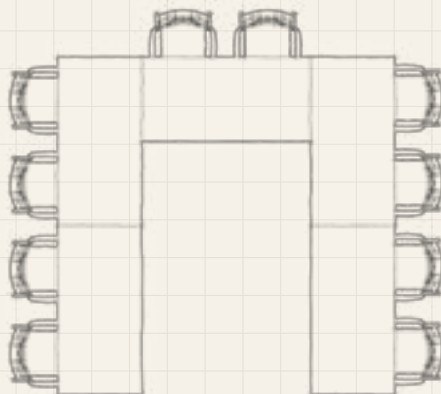

AXIS



25MM MFC FINISHES



REFORMED VENEERS

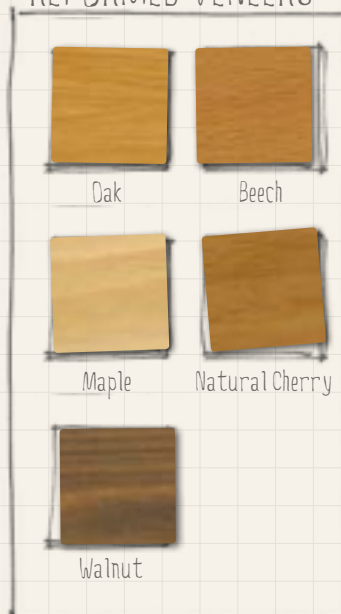

REFORMED VENEER INLAID + BANDED



FRAME



FRAME



An innovative and functional table system in which the frame folds within its own length

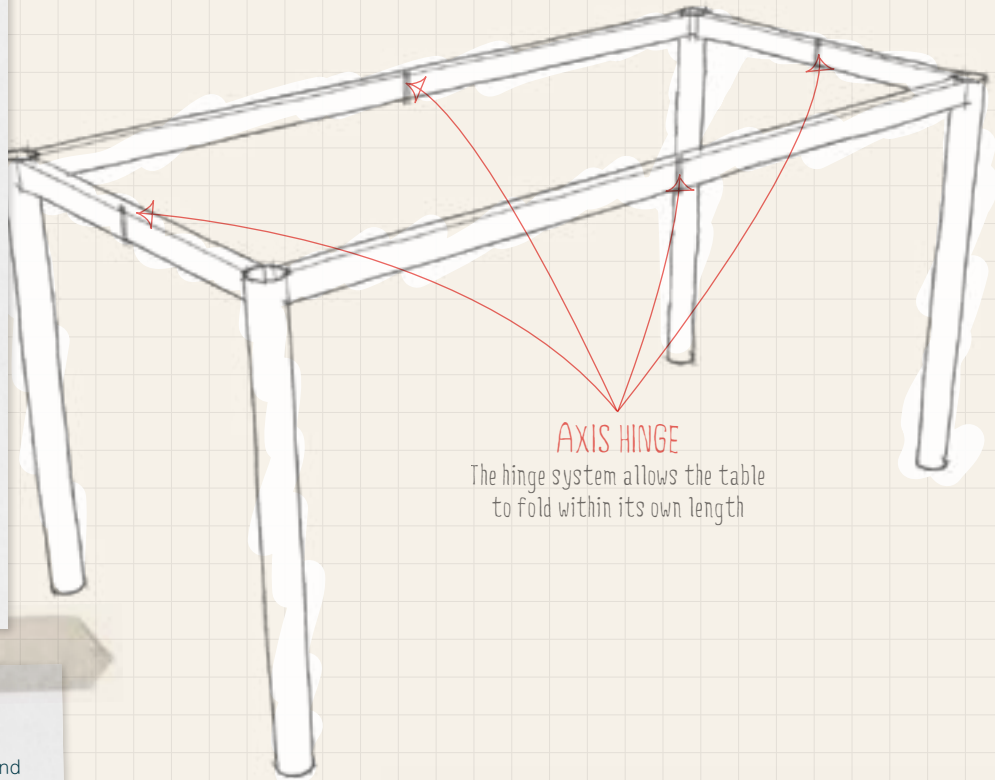
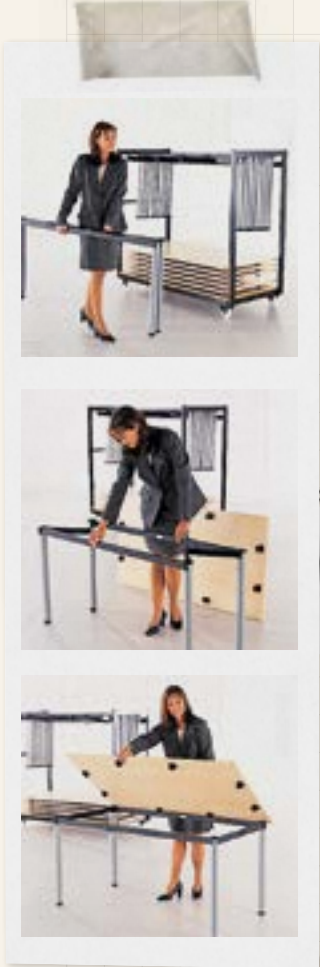

AXIS HINGE

The hinge system allows the table to fold within its own length

/ AXIS

Ideally suited to training and conference purposes with its ease of reconfiguration, storage and transport.

NO TOOLS, NO PROBLEM

Tool free assembly - top fits to frame using moulded plastic locating lugs



MODESTY PANELS

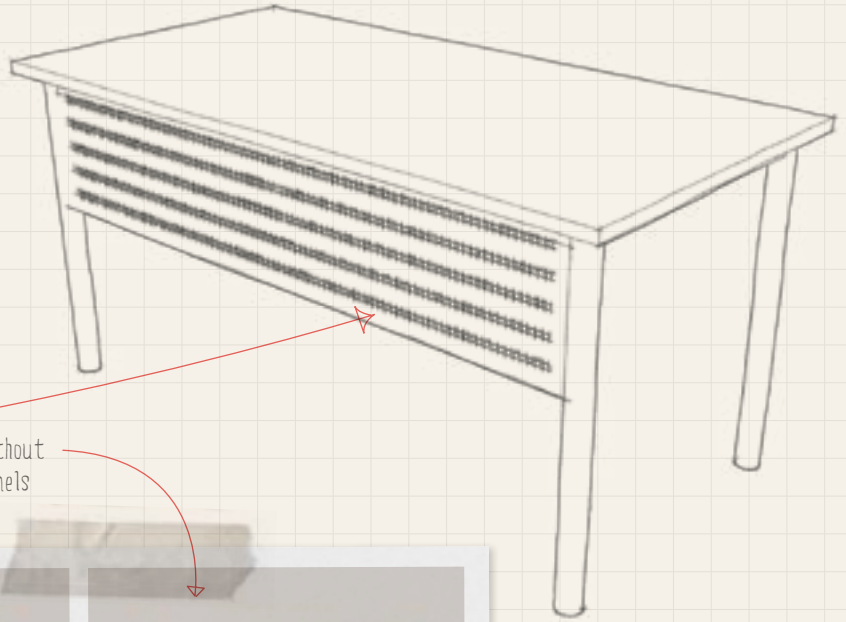

CHOICES

Can be specified with or without steel or MFC modesty panels

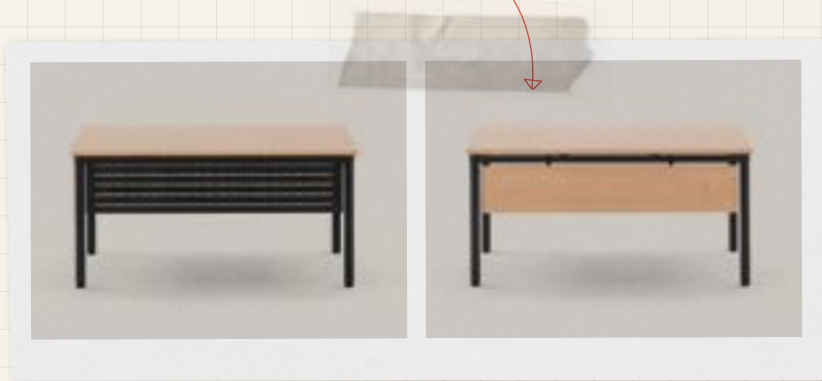

TOP SHAPES



CIRCULAR



SQUARE



RECTANGULAR



TRAPEZOIDAL



SEMI CIRCULAR



EXTENDED CURVE

Let's get into some detail

CONFIGURATIONS

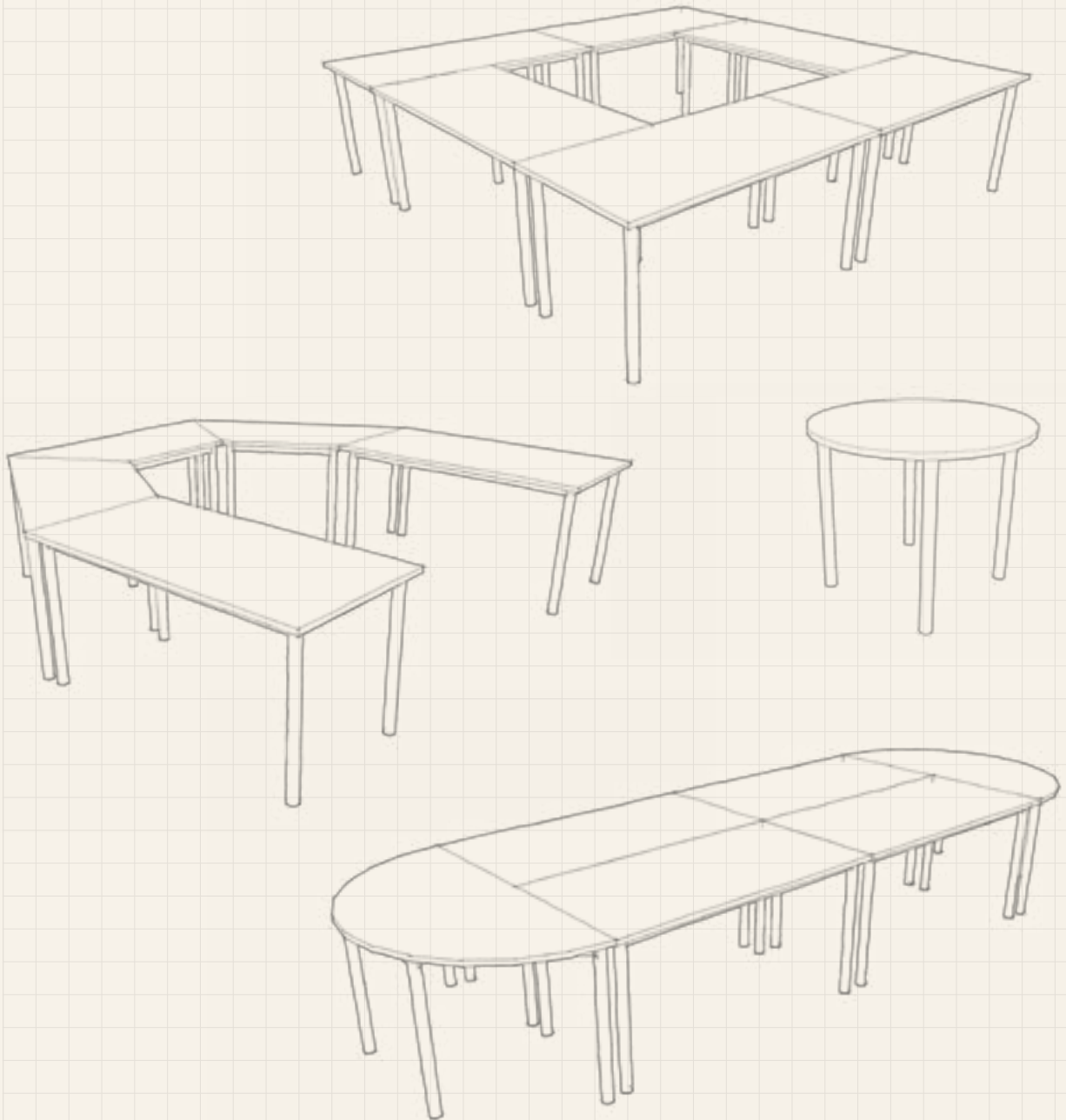





PLAY



25MM MFC FINISHES

 Highland Oak	 English Oak	 Maple
 Beech	 White	 Autumn
 Winter Oak	 Strata Oak	 Mocha

REFORMED VENEERS

 Oak	 Beech
 Maple	 Natural Cherry
 Walnut	

FRAME

 Black	 Silver
--	---

FRAME



Designed to be easily configured and has functionality at its heart

STAND ALONE
Modular system

OPEN ASPECT
Allows for provision of in-desk power module

SLIMLINE LEG
Belies the strength of the table

SPLAYED LEG
Give an extremely strong platform from which to work

LEVELLING
Oversized levelling adjuster

CONNECTION
Power/ Data/ AV

POWER UP



Play can be specified with the additional benefit of centrally integrated units to house AV, power and data



Table Systems

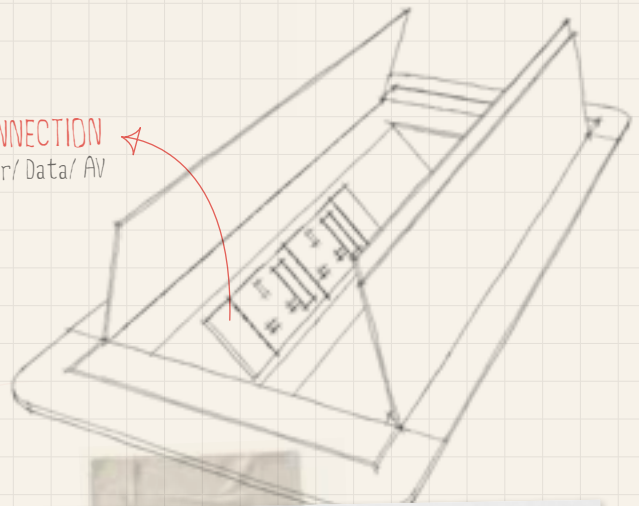

To support the AV, Power and Data units a steel cable riser or a plastic 'slinky' cable riser can be specified, fitting directly into the unit



Let's get into some detail

CHAMELEON



18MM MFC FINISHES



REFORMED VENEERS



FRAME



FRAME

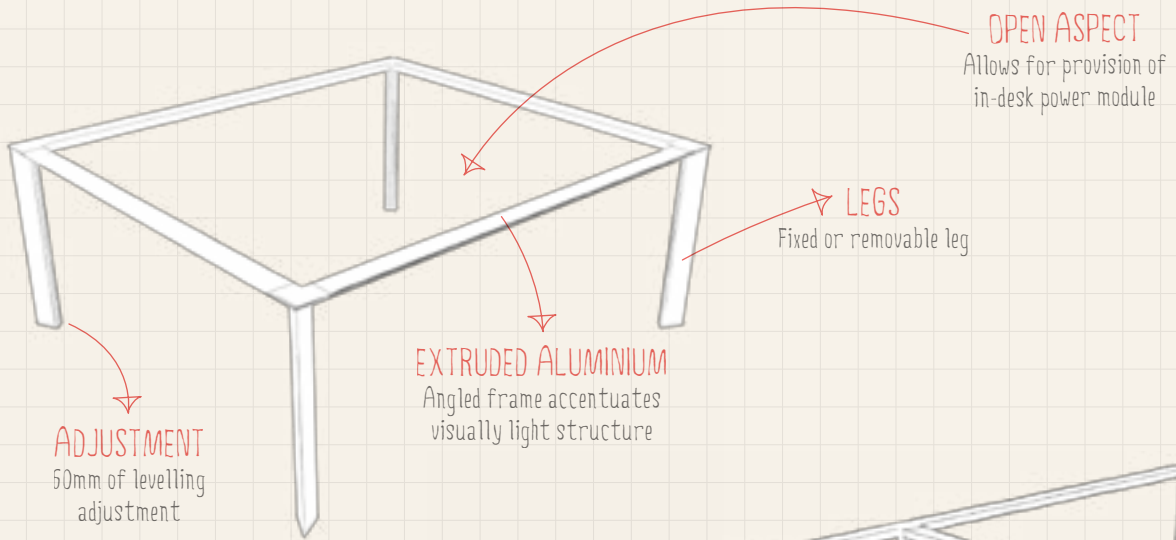

LEGS
Fixed or removable leg

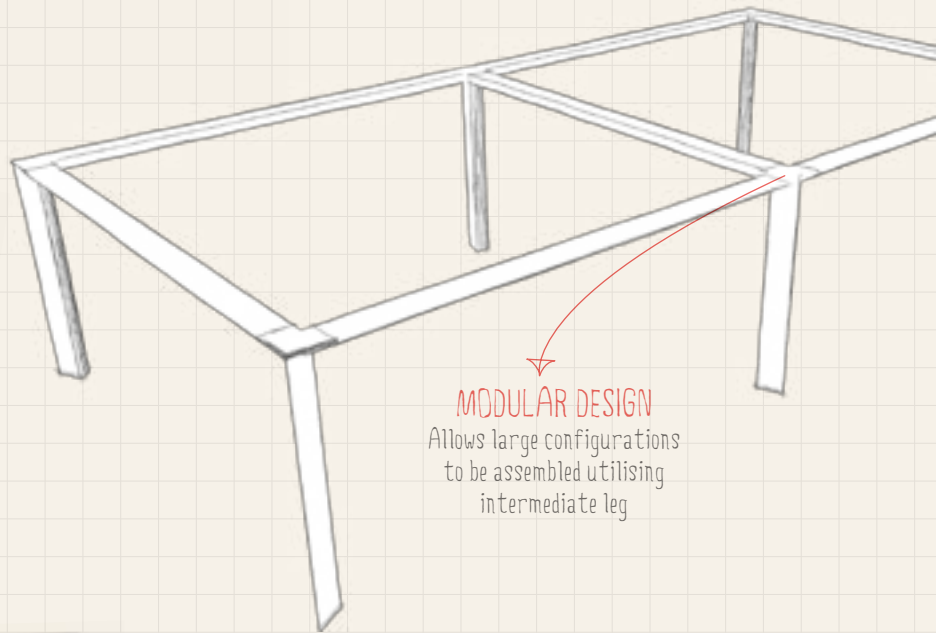

/ CHAMELEON

Ideally suited to training and seminar rooms, conference, boardrooms and training rooms.

The optional 'no tools' catch mechanism facilitates the removable leg.



Let's get into some detail

POWER UP

Chameleon meeting tables can be specified with the additional benefit of centrally integrated units to house AV, Power and Data outlets

To support the AV, Power and Data units a steel cable riser or a plastic 'slinky' cable riser can be specified, fitting directly into the unit

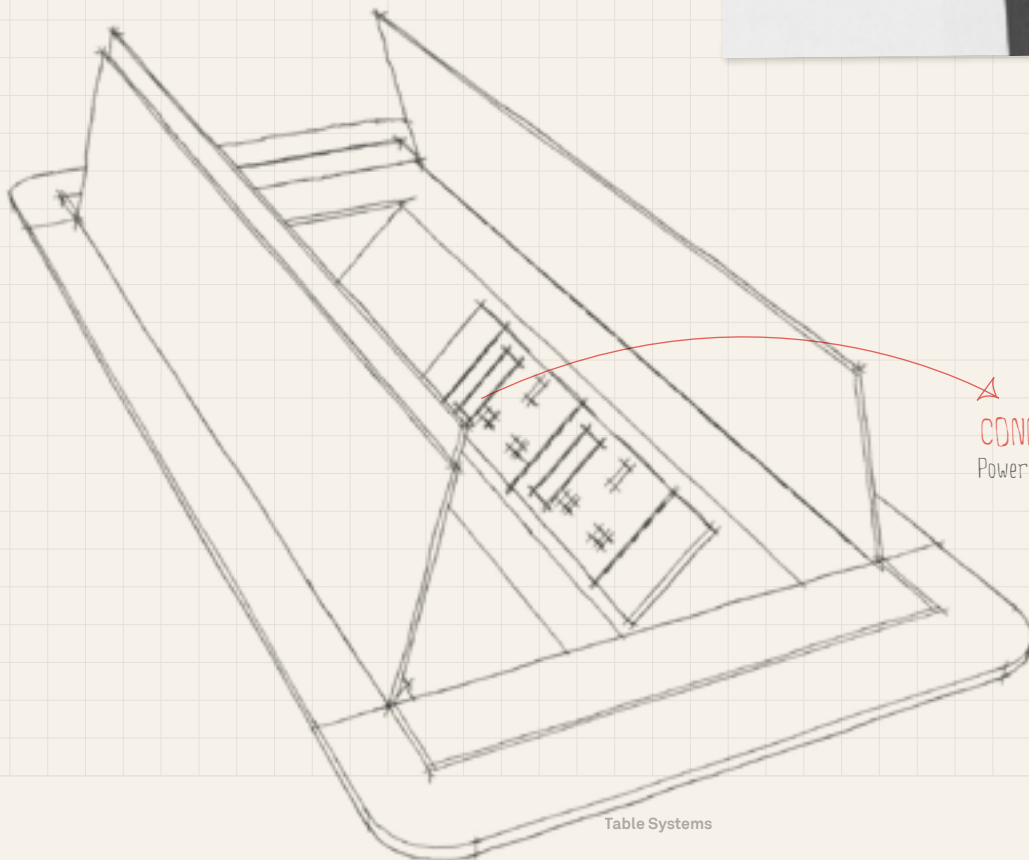

CONNECTION
Power/ Data/ AV

TOP SIZES

- CAF0808R
- CAF1010R
- CAF1212R
- CAF1008R
- CAF1208R
- CAF1408R
- CAF1608R
- CAF1808R
- CAF2008R

- CAF1210R
- CAF1410R
- CAF1610R
- CAF1810R
- CAF2010R

- CAF1412R
- CAF1612R
- CAF1812R
- CAF2012R
- CAF3210R
- CAF3610R
- CAF4010R

- CAF3212R
- CAF3612R
- CAF4012R

Need it digital?

A copy of this book, product rotations, high resolution images, CAD symbols and more detailed product information are all on our website.

thesenatorgroup.com

Section Four

**A LITTLE
MORE
ABOUT US**

Senator

A little more about us

A Little More About Us

OUR SERVICE TO YOU

XPRESS PROGRAM

Our customers and clients don't always want to wait and why should they? We offer Xpress programmes across all our three brands: **Senator**, **Allermuir** and **Torasan**.

This means some of our most popular products can be ordered and received within 5-10 days depending on the product.

WE LIKE TO SUSTAIN™

As part of our commitment to sustainability, we have our own recycling business called Sustain™ which has two recycling centres in the UK. Through Sustain™ you can access a number of services including the collection and recycling of your waste packaging and recycle or remanufacture of your old furniture.

IT'S ALL IN THE PLANNING

Our sales teams are there to support you in the planning of your project and the interpretation of the client brief. We can assist with space planning concepts with provision of space plans using the latest technology to realistically recreate spaces to accurately visualise the product in its environment, creating and supplying CAD symbols as required.

A Little More About Us

IT'S YOUR WORKPLACE

WE CALL IT SETTINGS™

The future of the office can't be defined into one vision and that's the exciting prospect, but we can understand how spaces will evolve by understanding and being at the forefront of trends in our changing environment. People are the drivers but the influences around them interact to create new challenges and opportunities. Settings™ is a concept from The Senator Group which was developed to enable modern, flexible, efficient and cost effective workplaces for people that will facilitate new working practices, enhance collaboration, improve service delivery and act as a catalyst for change in the workplace.

CHANGING SPACES

The workplace has changed, is changing and will carry on evolving as the influences around us change. We have four generations co-existing in the workplace and the workplace and our home life are blurring mainly through the speed of recent technological changes. What is so fascinating for us not just as a furniture supplier but as an enabler of change is how we can facilitate the needs of people. Not to dictate but to be there to enable and house future change for our customers, clients and end users. We are passionate about what we call 'Settings' which is a catalyst to support the changing needs of people and places.

thesenator



Work



Share



Show



Source



Refresh

WE CAN ALSO HELP YOU
WITH DESKING, STORAGE,
SOFT SEATING, STOOLS...

We've collated all of our
Desking, Storage and Screen
systems for you to complete
your workspace.

Order your copy of the
Workplace Solutions book.

Senator

To order your books contact-
marketing@thesenatorgroup.com

Yearbook Four
Anything but ordinary

Order your copy

Allermuir

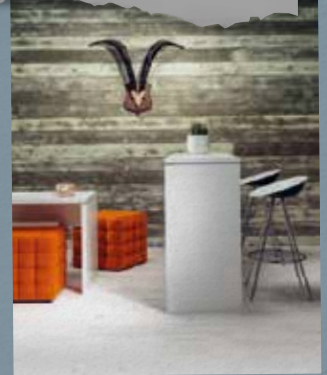

**THANK YOU
FOR TAKING
THE TIME**

**WE LOOK FORWARD TO
WORKING TOGETHER SOON**

—

THESENATORGROUP.COM

Senator