



# GROSVENOR HOUSE PAPERS LIMITED

RHINO

## Rhino Education

RHINO

RHINO Homework Diary

RHINO Music Manuscript

**EXERCISE BOOKS AND  
ART & CRAFT MATERIALS**

All prices quoted do not include V.A.T.

# 2015/16

## Ordering from Grosvenor House Papers

Orders can be placed by fax, post or email. You'll find a Purchase Order Form on the inside back cover of this brochure which can be photocopied for successive orders. We are one of the largest stock holders of classroom materials and therefore can offer a prompt and efficient service on delivery. If you have any special delivery requirements please let us know at time of ordering.

### Returns Policy

In the event that you have a problem with your order please notify us within 24 hours. We will replace any goods that are incorrect, damaged or faulty on receipt or issue a refund or make good any shortage or non-delivery.

If you sign for goods which are damaged/short, please ensure that you sign for them as "damaged/short" and notify us within 24 hours so that we can make a claim with the courier.

If you wish to return goods that have been incorrectly ordered you must notify us within 7 days and return the undamaged goods to us within 14 days. The Goods must be in their original un-opened packaging, fit for resale. Goods should be returned using UPS or a suitable carrier at your expense. It is your responsibility to ensure goods are returned on time and undamaged in order to receive a credit.

We make use of UPS Access Points for parcels and we may request that you to drop the parcels off at your local Access Point. For larger consignments we will arrange a carrier/our own transport to collect. Please contact customer services for details of your local access point and return labels which will be emailed to you.

Our re-stocking fee for goods incorrectly ordered is 20% of the value of the returned goods, with a minimum charge of £20 +VAT.

### Step by step guide to ordering exercise books

- Choose the size of book required 8x6½, 9x7, A4 etc.
- Choose the quantity of pages required, 32p, 48p, 64p, 80p, 120p etc. Please remember that a single leaf in the book constitutes 2 pages.
- Choose the ruling width or type that you require, 6mm, 8mm, 12mm, 15mm wide lines or plain unruled.
- Decide if you require a margin on each page or not, such as 6mm ruled and margin, 8mm ruled and margin etc.
- Decide if you require squares instead of lines, such as 5mm, 7mm, 10mm squares etc. Squares are often used for Maths and Science work.
- Finally choose the colour of your cover, coloured covers can be used to identify subjects or classes. There is a handy Colour Chart and Ruling Guide at the back of this brochure.

### Made in the EU to BS4448 standard

All our Exercise Books and Papers are made in the EU from EU manufactured materials.

Our range conforms with British Standard BS4448 which is specified for the manufacture of all Exercise Books and Papers to be used in the Educational Sector.

Exercise Books and Exercise Papers made outside the EU rarely conform with this British Standard BS4448.

ALL OF OUR PRODUCTS ARE COMPLIANT.

## Grosvenor House Papers and Victor Stationery - why our partnership is working hard for you and the environment.

Grosvenor House Papers is committed to supplying high quality products which conform to the latest industry standards and have attained environmental accreditation from the World's most trusted and respected environmental authorities.

We continue to work in partnership with Victor Stationery one of Europe's leading paper product manufacturers, whose production standards meet or exceed these exacting environmental requirements. Our partnership allows us to invest in ways to minimise the impact of our operations on the environment.

Victor Stationery which was established in 1882 has a long history of school stationery manufacture which dates back to the 1920's. They produce some of Europe's most famous stationery brands including Rhino, Aisling, Capital and Varsity.

Environmental production and waste standards are only part of the picture. Through the sale of Rhino branded products, Save the Rhino International benefits directly. The organisation works to conserve viable populations of critically endangered rhinos in Africa and Asia, delivering benefits to rhinos, other endangered species, ecosystems and to the people living in those areas.

Our combined attention to these issues means that you can purchase stationery products from us with confidence, with the assurance of quality manufacturing standards, reliable customer focused service and sound environmental awareness.

### Nordic Swan Label



The Nordic Swan label is widely recognised throughout Europe. Products accredited with this standard are printed with water based inks with optical ecolabelling. There is consideration of the environmental impact of these products from the raw material through to waste.

### Forest Stewardship Council



An Internationally recognised organisation dedicated to promoting responsible global forest management to the highest environmental, social and economic standards. Harvested trees are replanted to ensure future generations will be able to enjoy the benefits.

### Programme for the Endorsement of Forest Certification



Providing an assurance mechanism to purchasers of wood and paper products creating a positive contribution towards mitigating the effects of climate change. The organisation motivates and enables people to sustainably manage their forests and works to provide a market for those products.

### Save the Rhino International



Actively connects conservation and communities. Sales from Rhino branded stationery directly support the work of the organisation. Save the Rhino works throughout Africa and Asia to conserve populations of rhino with benefits which reach beyond the species to other endangered animals and local communities.

|                             |                 |                               |               |
|-----------------------------|-----------------|-------------------------------|---------------|
| A4 Range Exercise Books     | 9-11, 68        | Fibre Tipped Pens             | 54, 56, 57    |
| Accessories                 | 124-127         | File Paper                    | 21, 28        |
| Activity Paper              | 82,83           | Fimo Modelling Materials      | 61-63         |
| Adhesives                   | 128-129         | Fimo Modelling Kits           | 62            |
| Art Brushes                 | 104-106         | Fineliner Pens                | 60            |
| Ballpoint Pens              | 59              | Flip Chart Marker Pens        | 56            |
| Black Card                  | 92              | Flip Charts                   | 23            |
| Board & Card                | 95              | Folders                       | 76            |
| Book-keeping Ledgers        | 17, 18          | Graph Exercise Books          | 25            |
| Book-keeping Paper          | 18              | Graph Pads                    | 26            |
| Bordette Border Rolls       | 99-101          | Graph Paper                   | 30-31         |
| Bright Range Exercise Books | 4               | Gummed & Tissue Paper         | 96-97         |
| Bulletin Exercise Books     | 15, 16          | Hard Backed Notebooks         | 22, 36, 38-39 |
| Card Packs                  | 64-65           | Highlighter Marker Pens       | 58            |
| Casebound Books             | 41-41           | Holographic & Corrugated Card | 101           |
| Coloured Card               | 64-65           | Homework Diaries              | 17            |
| Compasses                   | 52              | Infant Papers                 | 28            |
| Crayons                     | 114             | Infant Range Exercise Books   | 4             |
| Crayons, Chalks & Pastels   | 54, 52, 114-116 | Injury Record Books           | 20            |
| Creative Paper & Card       | 64, 65, 84, 90  | Junior Papers                 | 27            |
| Crepe & Foil                | 98              | Junior Range Exercise Books   | 6             |
| Cuttings Albums             | 16              | Laminating Machines           | 66            |
| Display Paper               | 77              | Laminating Pouches            | 66            |
| Document Wallets            | 76              | Layout & Tracing Pads         | 102, 25       |
| Drawing Books               | 42-45           | Layout Pads                   | 25, 102       |
| Drawing Paper               | 91              | Learn to Write Exercise Books | 19            |
| Drawing Surfaces            | 103             | Learn to Write Pads           | 19            |
| Envelopes                   | 46-48           | Legal (Councils) Notebooks    | 18            |
| Exam Papers                 | 28-30           | Legal Pads                    | 34            |
| Exercise Book Finder        | 137-148         | Mark Books                    | 17            |
| Exercise Books Sample Packs | 9               | Marker Pens                   | 54-58         |
| Exercise Papers             | 31              | Maths Papers                  | 31            |
| Fibre Tipped Marker Pens    | 54, 56, 57      | Memo Pads                     | 34            |
|                             |                 | Metallic Markers              | 60            |

|                         |                |  |            |
|-------------------------|----------------|--|------------|
| Mixing Palettes         | 112-113        | Rough Work Exercise Books                | 6, 14      |
| Modelling               | 117            | Rulers & Maths Sets                      | 53, 123    |
| Modelling Material      | 60-63, 117     | Ruling & Cover Guides                    | 9          |
| Music Exercise Books    | 22             | Ruling Guide                             | 70-75      |
| Notebooks               | 36             | RYCO Book Covering Materials             | 69-75      |
| Padded Envelopes        | 48             | Save the Rhino Notebooks                 | 38, 40     |
| Paints                  | 107-113        | Science Books                            | 24-26, 36  |
| Parchment Paper & Card  | 94             | Scissors                                 | 121        |
| Pencil Erasers          | 52             | Scrap Books                              | 15         |
| Pencil Sharpeners       | 52             | Senior Range Exercise Books              | 7, 8       |
| Pencils - Blacklead     | 50-52, 118-120 | Shorthand Note Pads                      | 37-38      |
| Pencils - Coloured      | 53-54          | Sketch Pads & Books                      | 42-45      |
| Pens & Pencils          | 118-120        | Special Educational Needs Exercise Books | 21         |
| Photo Albums            | 16             | Special Educational Needs Exercise Paper | 21, 28     |
| Photo Mount Corners     | 16             | Squared Paper                            | 31         |
| Photo Mount Glue        | 16             | Standard Range Exercise Books            | 4          |
| Photo Mount Squares     | 16             | Steadtler Products                       | 50-63      |
| Portfolios              | 44             | Sugar & Frieze Paper                     | 80-81      |
| Postage Record Books    | 20             | Toughback Books                          | 24, 36     |
| Postal Packaging        | 48             | Tracing Pads                             | 27         |
| Poster Paper            | 78-79          | Tracing Paper                            | 27         |
| Professional Notebooks  | 20             | Transfile Portfolios                     | 44         |
| Project Exercise Books  | 4, 7, 15, 17   | Triplus Pencils                          | 50, 53     |
| Punched Pockets         | 75             | Value Range Exercise Books               | 8, 9, 68   |
| Reading Record Books    | 19             | Visitors Record Books                    | 20         |
| Record Books            | 17             | Vocabulary Exercise Books                | 14         |
| Recycled Exercise Books | 38             | Watercolour Pencils                      | 54         |
| Recycled Notepads       | 37-38          | White Board Markers & Pens               | 122        |
| Refill Pads             | 32, 34         | White Card                               | 62, 64, 93 |
| Register Books          | 17             | Whiteboard Markers                       | 56         |
| Revision Cards          | 19             | Wide Format Printing                     | 48         |
| Rhino Kids Range        | 18             | Wirebound Notebooks                      | 40, 68     |
| Ring Binders            | 76             |  |            |

| A Infant Books 5¼" x 6½"<br>(135mm x 165mm) Pack of 100 |              |               | 24 Pages<br>£10.75 |
|---|--------------|---------------|--------------------|
| Paper 75gsm with a 225gsm manilla cover.                |              |               |                    |
| ORDER CODE  | COVER COLOUR | DESCRIPTION   |                    |
| EX032130  | Purple       | Plain Unruled |                    |
| EX032169  | Light Blue   | 8mm Ruled     |                    |
| EX032156  | Red          | 11mm Ruled    |                    |
| EX032143  | Red          | 15mm Ruled    |                    |
| EX032172  | Light Green  | 10mm Squares  |                    |

| Infant Oblong Exercise Books 6¼" x 8"<br>(160mm x 203mm) Pack of 100 |              |               | 40 Pages<br>£17.99 |
|--|--------------|---------------|--------------------|
| Paper 75gsm with a 225gsm manilla cover.                             |              |               |                    |
| ORDER CODE   | COVER COLOUR | DESCRIPTION   |                    |
| AA004  | Yellow       | Plain Unruled |                    |
| AA007  | Light Green  | 15mm Ruled    |                    |

| Infant Exercise Book 8" x 5"<br>(203mm x 125mm) Pack of 100 |              |             | 64 Pages<br>£23.30 |
|---|--------------|-------------|--------------------|
| Paper 75gsm with a 225gsm manilla cover.                    |              |             |                    |
| ORDER CODE  | COVER COLOUR | DESCRIPTION |                    |
| AB005   | Dark Blue    | 8mm Ruled   |                    |

| Junior Range 8" x 6½"<br>(203mm x 165mm) Pack of 100 |              |                    | 32 Pages<br>£14.40 |
|--|--------------|--------------------|--------------------|
| Paper 75gsm with a 225gsm manilla cover.             |              |                    |                    |
| ORDER CODE   | COVER COLOUR | DESCRIPTION        |                    |
| EX142152   | Pink         | Plain Unruled      |                    |
| EX142181   | Light Blue   | 8mm Ruled          |                    |
| EX142194   | Light Blue   | 8mm Ruled & Margin |                    |
| EX142178   | Red          | 12mm Ruled         |                    |
| EX142165   | Red          | 15mm Ruled         |                    |
| EX142204   | Yellow       | 7mm Squares        |                    |
| EX142217   | Light Green  | 10mm Squares       |                    |

| B Project Books 8" x 6½"<br>(203mm x 165mm) Pack of 100 |              |                               | 32 Pages<br>£14.40 |
|---|--------------|-------------------------------|--------------------|
| Paper 75gsm with a 225gsm manilla cover.                |              |                               |                    |
| ORDER CODE  | COVER COLOUR | DESCRIPTION                   |                    |
| PW02513   | Light Green  | Top Plain Bottom ½ 8mm Ruled  |                    |
| PW02526   | Light Blue   | Top Plain Bottom ½ 12mm Ruled |                    |
| PW02568   | Red          | Top Plain Bottom ½ 12mm Ruled |                    |
| PW02539   | Red          | Top Plain Bottom ½ 15mm Ruled |                    |
| PW02550   | Light Green  | Plain & 12mm Ruled Alternate  |                    |
| PW02555   | Yellow       | Plain & 15mm Ruled Alternate  |                    |

| Standard Range 8" x 6½"<br>(203mm x 165mm) Pack of 100 |              |                             | 48 Pages<br>£12.60 |
|--|--------------|-----------------------------|--------------------|
| Paper 75gsm with a 225gsm manilla cover.               |              |                             |                    |
| ORDER CODE   | COVER COLOUR | DESCRIPTION                 |                    |
| EX34224  | Pink         | Plain Unruled               |                    |
| EX342448   | Yellow       | Plain Unruled               |                    |
| EX342150   | Red          | 6mm Ruled                   |                    |
| EX342244   | Light Green  | 6mm Ruled & Margin          |                    |
| EX342422   | Red          | 6mm Ruled & Margin          |                    |
| EX342105   | Light Blue   | 8mm Ruled                   |                    |
| EX342118   | Orange       | 8mm Ruled                   |                    |
| EX342626   | Red          | 8mm Ruled                   |                    |
| EX342202   | Dark Blue    | 8mm Ruled & Margin          |                    |
| EX342192   | Dark Green   | 8mm Ruled & Margin          |                    |
| EX342354   | Light Blue   | 8mm Ruled & Margin          |                    |
| EX342367   | Light Green  | 8mm Ruled & Margin          |                    |
| EX342370   | Orange       | 8mm Ruled & Margin          |                    |
| EX342419   | Purple       | 8mm Ruled & Margin          |                    |
| EX342228   | Red          | 8mm Ruled & Margin          |                    |
| AA114  | Yellow       | 8mm Ruled & Margin          |                    |
| EX34270  | Dark Blue    | 12mm Ruled                  |                    |
| EX34266  | Red          | 12mm Ruled                  |                    |
| EX342480   | Light Green  | 15mm Ruled                  |                    |
| EX34240  | Red          | 15mm Ruled                  |                    |
| EX342602   | Dark Green   | 5mm Squares                 |                    |
| EX342396   | Light Blue   | 5mm Squares                 |                    |
| EX342312   | Orange       | 5mm Squares                 |                    |
| EX342619   | Dark Green   | 7mm Squares                 |                    |
| EX342406   | Light Blue   | 7mm Squares                 |                    |
| EX342341   | Orange       | 7mm Squares                 |                    |
| EX342299   | Yellow       | 7mm Squares                 |                    |
| EX342325   | Dark Green   | 10mm Squares                |                    |
| EX342383   | Light Blue   | 10mm Squares                |                    |
| EX342558   | Red          | 10mm Squares                |                    |
| EX342287   | Dark Green   | Top Plain Bottom 8mm Ruled  |                    |
| EX342290   | Orange       | Top Plain Bottom 12mm Ruled |                    |
| EX342532   | Yellow       | Top Plain Bottom 15mm Ruled |                    |
| EX342189   | Dark Green   | Plain & 8mm Ruled Alternate |                    |
| EX342504   | Yellow       | Plain & 8mm Ruled Alternate |                    |



BUYING  
RHINO  
SAVES  
RHINOS



reg. charity no. 1035072



Minimum order value of £50.00 ex.VAT or small order administration charge of £7.50 will apply

| Junior Range 8" x 6½"<br>(203mm x 165mm) Pack of 100 |              | 64 Pages<br>£23.75 |
|--|--------------|--------------------|
| Paper 75gsm with a 225gsm manilla cover.             |              |                    |
| ORDER CODE   | COVER COLOUR | DESCRIPTION        |
| EX67640  | Light Blue   | Plain Unruled      |
| EX67679  | Red          | 6mm Ruled & Margin |
| EX67624  | Light Blue   | 8mm Ruled & Margin |
| EX67637  | Light Green  | 8mm Ruled & Margin |
| EX67611  | Red          | 8mm Ruled & Margin |
| EX67666  | Yellow       | 8mm Ruled & Margin |
| EX67682  | Buff         | 5mm Squares        |
| EX67695  | Red          | 7mm Squares        |
| EX67653  | Light Green  | 10mm Squares       |

| A Junior Range 8" x 6½"<br>(203mm x 165mm) Pack of 100 |              | 80 Pages<br>£25.40          |
|--|--------------|-----------------------------|
| Paper 75gsm with a 225gsm manilla cover.               |              |                             |
| ORDER CODE   | COVER COLOUR | DESCRIPTION                 |
| EX54415  | Pink         | Plain Unruled               |
| EX544167   | Light Green  | 6mm Ruled & Margin          |
| EX544170   | Light Blue   | 6mm Ruled & Margin          |
| EX544219   | Light Blue   | 8mm Ruled                   |
| EX544125   | Red          | 8mm Ruled & Margin          |
| EX54499  | Dark Blue    | 8mm Ruled & Margin          |
| EX54473  | Dark Green   | 8mm Ruled & Margin          |
| EX544109   | Light Blue   | 8mm Ruled & Margin          |
| EX544235   | Light Green  | 8mm Ruled & Margin          |
| EX544112   | Orange       | 8mm Ruled & Margin          |
| EX544125   | Red          | 8mm Ruled & Margin          |
| EX544138   | Yellow       | 8mm Ruled & Margin          |
| EX544248   | Light Blue   | 5mm Squares                 |
| EX544251   | Light Blue   | 7mm Squares                 |
| EX544196   | Yellow       | 7mm Squares                 |
| EX544222   | Light Green  | 10mm Squares                |
| EX544264   | Light Blue   | 10mm Squares                |
| EX54457  | Dark Green   | Plain & 8mm Ruled Alternate |

| Junior Range 8" x 6½"<br>(203mm x 165mm) Pack of 100 |              | 120 Pages<br>£38.99 |
|--|--------------|---------------------|
| Paper 75gsm with a 225gsm manilla cover.             |              |                     |
| ORDER CODE   | COVER COLOUR | DESCRIPTION         |
| EX36215  | Red          | 8mm Ruled & Margin  |

| Rough Work Books 8" x 6½"<br>(203mm x 165mm) Pack of 100 |              | 96 Pages<br>£28.10 |
|--|--------------|--------------------|
| Paper 60gsm with a 225gsm manilla cover.                 |              |                    |
| ORDER CODE   | COVER COLOUR | DESCRIPTION        |
| VRE01114   | Pink         | Plain Unruled      |
| VRE01127   | Light Blue   | 8mm Ruled          |

| Rough Work Books 9" x 7"<br>(230mm x 180mm) Pack of 50 |              | 48 Pages<br>£9.60 |
|--|--------------|-------------------|
| Paper 60gsm with a 225gsm manilla cover.               |              |                   |
| ORDER CODE   | COVER COLOUR | DESCRIPTION       |
| VRE02010-5   | Brown        | 8mm Ruled         |

| Rough Work Books 9" x 7"<br>(230mm x 180mm) Pack of 100 |              | 96 Page<br>£31.65 |
|---|--------------|-------------------|
| Paper 60gsm with a 225gsm manilla cover.                |              |                   |
| ORDER CODE  | COVER COLOUR | DESCRIPTION       |
| VRE02812  | Pink         | Plain Unruled     |
| VRE02825  | Light Blue   | 8mm Ruled         |



**FREE DELIVERY**  
on orders over £50



BUYING  
RHINO  
SAVES  
RHINOS



reg. charity no. 1035072





| <b>Project Books 9" x 7"</b><br><b>(230mm x 178mm) Pack of 100</b> |              | <b>32 Pages</b><br><b>£23.70</b> | <b>A</b> |
|--|--------------|----------------------------------|----------|
| Paper 75gsm with a 225gsm manilla cover.                           |              |                                  |          |
| ORDER CODE   | COVER COLOUR | DESCRIPTION                      |          |
| PW02346  | Light Blue   | Plain Unruled                    |          |
| PW02317  | Light Green  | Top Plain, Bottom 12mm Ruled     |          |
| PW02320  | Red          | Top Plain, Bottom 15mm Ruled     |          |
| PW0263   | Purple       | Plain & 15mm Ruled Alternate     |          |
| PW02333  | Yellow       | 20mm Squares                     |          |

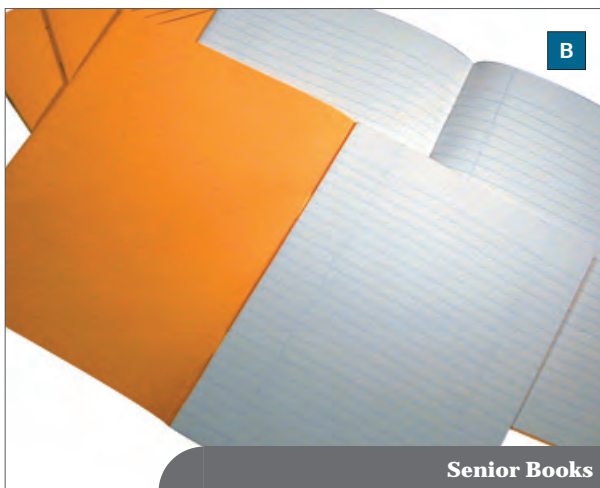

| <b>Senior Range 9" x 7"</b><br><b>(230mm x 178mm) Pack of 100</b> |              | <b>48 Pages</b><br><b>£21.00</b>     | <b>B</b> |
|---|--------------|--------------------------------------|----------|
| Paper 75gsm with a 225gsm manilla cover.                          |              |                                      |          |
| ORDER CODE  | COVER COLOUR | DESCRIPTION                          |          |
| EX35221   | Pink         | Plain Unruled                        |          |
| EX35292   | Light Green  | 6mm Ruled & Margin                   |          |
| EX35234   | Light Blue   | 8mm Ruled                            |          |
| EX35276   | Dark Blue    | 8mm Ruled & Margin                   |          |
| EX35263   | Dark Green   | 8mm Ruled & Margin                   |          |
| EX352157  | Light Blue   | 8mm Ruled & Margin                   |          |
| EX352131  | Light Green  | 8mm Ruled & Margin                   |          |
| EX352160  | Orange       | 8mm Ruled & Margin                   |          |
| EX352144  | Pink         | 8mm Ruled & Margin                   |          |
| EX35289   | Red          | 8mm Ruled & Margin                   |          |
| EX352115  | Yellow       | 8mm Ruled & Margin                   |          |
| EX352102  | Orange       | 5mm Squares                          |          |
| VEX352-245  | Red          | 7mm Squares                          |          |
| EX352128  | Yellow       | 7mm Squares                          |          |
| EX352260  | Red          | 10mm Squares                         |          |
| VEX352-200-6  | Brown        | Plain & 8mm Ruled & Margin Alternate |          |
| AG011   | Orange       | Plain & 8mm Ruled Alternate          |          |
| AG014   | Orange       | Plain & 12mm Ruled Alternate         |          |



| <b>Senior Range 9" x 7"</b><br><b>(230mm x 178mm) Pack of 100</b> |              | <b>64 Pages</b><br><b>£26.75</b> | <b>C</b> |
|---|--------------|----------------------------------|----------|
| Paper 75gsm with a 225gsm manilla cover.                          |              |                                  |          |
| ORDER CODE  | COVER COLOUR | DESCRIPTION                      |          |
| EX67859   | Red          | 6mm Ruled & Margin               |          |
| EX67817   | Light Blue   | 8mm Ruled & Margin               |          |
| EX67820   | Light Green  | 8mm Ruled & Margin               |          |
| EX67830   | Orange       | 8mm Ruled & Margin               |          |
| EX67833   | Red          | 8mm Ruled & Margin               |          |
| EX67846   | Yellow       | 8mm Ruled & Margin               |          |
| EX67875   | Orange       | 5mm Squares                      |          |
| EX67862   | Light Green  | Plain & 8mm Ruled Alternate      |          |

| Value Range 9" x 7"<br>(230mm x 178mm) Pack of 100 |              |                    | 60 Pages<br>£15.99 |
|--|--------------|--------------------|--------------------|
| Paper 60 gsm with a 225gsm manilla cover.          |              |                    | <b>NEW RANGE</b>   |
| ORDER CODE   | COVER COLOUR | DESCRIPTION        |                    |
| VRE025106  | Dark Blue    | 8mm Ruled & Margin |                    |
| VRE02583   | Dark Green   | 8mm Ruled & Margin |                    |
| VRE02527   | Light Blue   | 8mm Ruled & Margin |                    |
| VRE02573   | Light Green  | 8mm Ruled & Margin |                    |
| VRE02598   | Purple       | 8mm Ruled & Margin |                    |
| VRE02511   | Red          | 8mm Ruled & Margin |                    |
| VRE02556   | Yellow       | 8mm Ruled & Margin |                    |
| VRE025743  | Orange       | 5mm Squares        |                    |
| VRE025287  | Yellow       | 7mm Squares        |                    |
| VRE025261  | Orange       | 10mm Squares       |                    |

| Senior Range 9" x 7"<br>(230mm x 178mm) Pack of 100 |              |                    | 96 Pages<br>£33.35 |
|---|--------------|--------------------|--------------------|
| Paper 75gsm with a 225gsm manilla cover.            |              |                    |                    |
| ORDER CODE  | COVER COLOUR | DESCRIPTION        |                    |
| AA037   | Dark Blue    | 8mm Ruled & Margin |                    |

| Senior Range 9" x 7"<br>(230mm x 178mm) Pack of 100 |              |                    | 120 Pages<br>£48.80 |
|---|--------------|--------------------|---------------------|
| Paper 75gsm with a 225gsm manilla cover.            |              |                    |                     |
| ORDER CODE  | COVER COLOUR | DESCRIPTION        |                     |
| EX65855   | Dark Blue    | 8mm Ruled & Margin |                     |
| EX65826   | Dark Green   | 8mm Ruled & Margin |                     |
| EX658122  | Orange       | 8mm Ruled & Margin |                     |
| EX65884   | Red          | 8mm Ruled & Margin |                     |
| EX658148  | Yellow       | 8mm Ruled & Margin |                     |

| Senior Range 9" x 7"<br>(230mm x 178mm) Pack of 100 |              |                                      | 80 Pages<br>£20.99 |
|---|--------------|--------------------------------------|--------------------|
| Paper 75gsm with a 225gsm manilla cover.            |              |                                      |                    |
| ORDER CODE  | COVER COLOUR | DESCRIPTION                          |                    |
| EX55412   | Dark Blue    | Plain Unruled                        |                    |
| EX55425   | Pink         | Plain Unruled                        |                    |
| EX554368  | Yellow       | Plain Unruled                        |                    |
| EX55454   | Grey         | 6mm Ruled                            |                    |
| EX554355  | Light Blue   | 6mm Ruled & Margin                   |                    |
| EX554177  | Light Green  | 6mm Ruled & Margin                   |                    |
| DD030094  | Orange       | 6mm Ruled & Margin                   |                    |
| EX554193  | Red          | 6mm Ruled & Margin                   |                    |
| EX55438   | Light Blue   | 8mm Ruled                            |                    |
| EX55470   | Buff         | 8mm Ruled & Margin                   |                    |
| EX554106  | Dark Blue    | 8mm Ruled & Margin                   |                    |
| EX55483   | Dark Green   | 8mm Ruled & Margin                   |                    |
| EX554258  | Grey         | 8mm Ruled & Margin                   |                    |
| EX554119  | Light Blue   | 8mm Ruled & Margin                   |                    |
| EX55496   | Light Green  | 8mm Ruled & Margin                   |                    |
| EX554122  | Orange       | 8mm Ruled & Margin                   |                    |
| EX554164  | Pink         | 8mm Ruled & Margin                   |                    |
| EX554300  | Purple       | 8mm Ruled & Margin                   |                    |
| EX554135  | Red          | 8mm Ruled & Margin                   |                    |
| EX554148  | Yellow       | 8mm Ruled & Margin                   |                    |
| EX554371  | Dark Green   | 5mm Squares                          |                    |
| EX554290  | Light Blue   | 5mm Squares                          |                    |
| EX554232  | Orange       | 5mm Squares                          |                    |
| EX554382  | Red          | 5mm Squares                          |                    |
| EX554274  | Yellow       | 5mm Squares                          |                    |
| EX554313  | Light Blue   | 7mm Squares                          |                    |
| EX554229  | Orange       | 7mm Squares                          |                    |
| EX554287  | Yellow       | 7mm Squares                          |                    |
| EX554339  | Light Blue   | 10mm Squares                         |                    |
| EX554261  | Orange       | 10mm Squares                         |                    |
| EX554340  | Purple       | 10mm Squares                         |                    |
| EX55467   | Dark Green   | Plain & 8mm Ruled Alternate          |                    |
| EX554245  | Orange       | Plain & 8mm Ruled & Margin Alternate |                    |

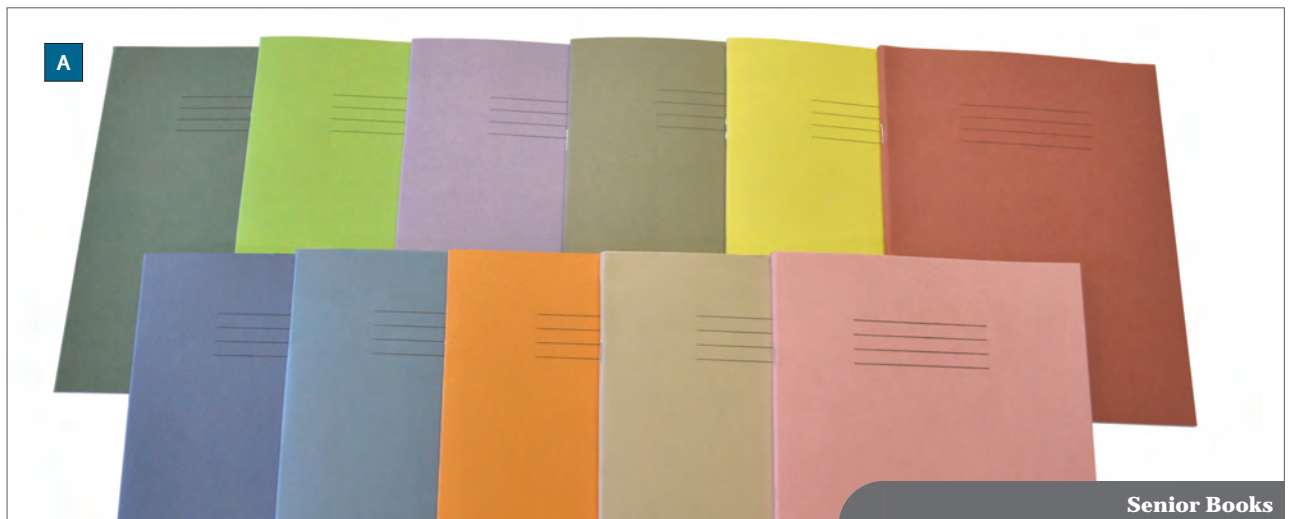

Senior Books

| A4 Junior Range<br>(300mm x 210mm) Pack of 100 |              | 32 Pages<br>£23.20           |
|--|--------------|------------------------------|
| Paper 75gsm with a 225gsm manilla cover.       |              |                              |
| ORDER CODE                                     | COVER COLOUR | DESCRIPTION                  |
| DU01484  | Light Blue   | Plain Unruled                |
| DU01471  | Light Green  | Plain Unruled                |
| DU014123                                       | Pink         | Plain Unruled                |
| DU014110                                       | Purple       | Plain Unruled                |
| DU01497  | Red          | Plain Unruled                |
| DU014107                                       | Yellow       | Plain Unruled                |
| DU014160                                       | Light Blue   | 8mm Ruled                    |
| DU014178                                       | Light Blue   | 8mm Ruled & Margin           |
| DU014136                                       | Light Green  | 8mm Ruled & Margin           |
| DU014165                                       | Red          | 8mm Ruled & Margin           |
| DU014149                                       | Light Blue   | 15mm Ruled                   |
| DU01480  | Red          | 12mm Ruled                   |
| DU014148                                       | Red          | 15mm Ruled                   |
| DU014100                                       | Yellow       | 7mm Squares                  |
| DU014151                                       | Light Green  | 10mm Squares                 |
| DU014155                                       | Orange       | 10mm Squares                 |
| DU014152                                       | Yellow       | 10mm Squares                 |
| DU014300                                       | Purple       | 20mm Squares                 |
| DU014200                                       | Red          | 20mm Squares                 |
| PW02414  | Red          | Top Plain, Bottom 13mm Ruled |
| PW02415  | Yellow       | Top Plain, Bottom 13mm Ruled |
| PW02424  | Red          | Top Plain, Bottom 15mm Ruled |
| PW02410  | Light Green  | Top Plain, Bottom 8mm Ruled  |
| PW02423  | Light Blue   | Top Plain, Bottom 13mm Ruled |
| PW02425  | Yellow       | Top Plain, Bottom 15mm Ruled |
| PW02430  | Light Green  | Top Plain, Bottom 20mm Ruled |
| PW02420  | Red          | Plain & 15mm Ruled Alternate |
| PW02421  | Yellow       | Plain & 15mm Ruled Alternate |

| Exercise Book Sample Packs   |          | £2.00                            |
|--|----------|----------------------------------|
| Junior pack contains 10 assorted books including 1 printed book.<br>Senior pack contains 15 assorted books & paper including 1 printed book. |          |                                  |
| ORDER CODE   | CONTAINS | DESCRIPTION                      |
| JSP  | 10       | Junior Exercise Book Sample Pack |
| SSP  | 15       | Senior Exercise Book Sample Pack |

| Ruling & Cover Guide  |                      | £2.00 |
|---|----------------------|-------|
| Spiral bound A5 booklet showing all rulings and a sample of each colour of cover available. |                      |       |
| ORDER CODE  | DESCRIPTION          |       |
| RSB/2   | Ruling & Cover Guide |       |

| A4 Standard Range<br>(300mm x 210mm) Pack of 100 |              | 48 Pages<br>£29.99            |
|--|--------------|-------------------------------|
| Paper 75gsm with a 225gsm manilla cover.         |              |                               |
| ORDER CODE                                       | COVER COLOUR | DESCRIPTION                   |
| EX68126  | Dark Green   | Plain Unruled                 |
| EX68125  | Pink         | Plain Unruled                 |
| EX68113  | Red          | Plain Unruled                 |
| EX681368   | Yellow       | Plain Unruled                 |
| EX681437   | Red          | 8mm Ruled                     |
| EX681106   | Dark Blue    | 8mm Ruled & Margin            |
| EX68171  | Dark Green   | 8mm Ruled & Margin            |
| EX68197  | Light Blue   | 8mm Ruled & Margin            |
| EX68168  | Light Green  | 8mm Ruled & Margin            |
| EX68155  | Orange       | 8mm Ruled & Margin            |
| EX68142  | Purple       | 8mm Ruled & Margin            |
| EX68184  | Red          | 8mm Ruled & Margin            |
| EX68139  | Yellow       | 8mm Ruled & Margin            |
| EX681110   | Dark Blue    | 12mm Ruled                    |
| EX681107   | Purple       | 12mm Ruled                    |
| EX681109   | Red          | 12mm Ruled                    |
| EX681150   | Red          | 15mm Ruled                    |
| EX681371   | Dark Green   | 5mm Squares                   |
| EX681290   | Light Blue   | 5mm Squares                   |
| EX681232   | Orange       | 5mm Squares                   |
| EX681303   | Dark Green   | 7mm Squares                   |
| EX681287   | Yellow       | 7mm Squares                   |
| EX681340   | Dark Green   | 10mm Squares                  |
| EX681339   | Light Blue   | 10mm Squares                  |
| EX681400   | Orange       | Top Plain, Bottom 12mm Ruled  |
| EX68167  | Dark Green   | Plain & 8mm Ruled Alternative |

| A4 Value Range<br>(300mm x 210mm) Pack of 50 |              | 60 Pages<br>£12.25           |
|--|--------------|------------------------------|
| Paper 60gsm with a 225gsm manilla cover.     |              |                              |
| ORDER CODE                                   | COVER COLOUR | DESCRIPTION                  |
| VRE01078-5                                   | Red          | Plain Unruled                |
| VRE01027-5                                   | Light Blue   | 8mm Ruled & Margin           |
| VRE010730-5                                  | Light Green  | 8mm Ruled & Margin           |
| VRE01098-5                                   | Purple       | 8mm Ruled & Margin           |
| VRE01011-5                                   | Red          | 8mm Ruled & Margin           |
| VRE01056-5                                   | Yellow       | 8mm Ruled & Margin           |
| VRE010743-5                                  | Orange       | 5mm Squares                  |
| VRE010292-5                                  | Yellow       | 10mm Squares                 |
| VRE01026-5                                   | Purple       | Plain & 15mm Ruled Alternate |

| A4 General Range<br>(300mm x 210mm) Pack of 50 |              | 64 Pages<br>£16.45            |                              |
|--|--------------|-------------------------------|------------------------------|
| Paper 75gsm with a 225gsm manilla cover.       |              |                               |                              |
| ORDER CODE                                     | COVER COLOUR | DESCRIPTION                   |                              |
| EX677400-5                                     | Buff         | Plain Unruled                 |                              |
| EX677409-5                                     | Light Blue   | Plain Unruled                 |                              |
| EX677410-5                                     | Light Green  | Plain Unruled                 |                              |
| EX67785-5                                      | Red          | Plain Unruled                 |                              |
| EX677136-5                                     | Yellow       | Plain Unruled                 |                              |
| EX677328-5                                     | Light Blue   | 6mm Ruled & Margin            |                              |
| EX677315-5                                     | Red          | 6mm Ruled & Margin            |                              |
| EX677149-5                                     | Buff         | 8mm Ruled & Margin            |                              |
| EX677108-5                                     | Dark Blue    | 8mm Ruled & Margin            |                              |
| EX677165-5                                     | Dark Green   | 8mm Ruled & Margin            |                              |
| EX67727-5                                      | Light Blue   | 8mm Ruled & Margin            |                              |
| EX67730-5                                      | Light Green  | 8mm Ruled & Margin            |                              |
| EX677110-5                                     | Orange       | 8mm Ruled & Margin            |                              |
| EX677152-5                                     | Pink         | 8mm Ruled & Margin            |                              |
| EX67798-5                                      | Purple       | 8mm Ruled & Margin            |                              |
| EX67714-5                                      | Red          | 8mm Ruled & Margin            |                              |
| EX67756-5                                      | Yellow       | 8mm Ruled & Margin            |                              |
| EX677425-5                                     | Light Blue   | 15mm Ruled                    |                              |
| EX67790-5                                      | Red          | 5mm Squares & Plain Alternate |                              |
| EX677357-5                                     | Light Blue   | 5mm Squares                   |                              |
| EX67743-5                                      | Orange       | 5mm Squares                   |                              |
| EX677438-5                                     | Light Blue   | 7mm Squares                   |                              |
| EX67770-5                                      | Orange       | 7mm Squares                   |                              |
| EX677300-5                                     | Purple       | 7mm Squares                   |                              |
| EX67772-5                                      | Yellow       | 7mm Squares                   |                              |
| EX67799-5                                      | Light Blue   | 10mm Squares                  |                              |
| EX677360-5                                     | Light Green  | 10mm Squares                  |                              |
| EX677361-5                                     | Purple       | 10mm Squares                  |                              |
| EX677292-5                                     | Yellow       | 10mm Squares                  |                              |
| EX677373-5                                     | Light Blue   | 20mm Squares                  |                              |
| EX67724-5                                      | Yellow       | 20mm Squares                  |                              |
| EX677344-5                                     | Light Blue   | Plain & 8mm Ruled Alternate   |                              |
| EX67769-5                                      | Light Green  | Plain & 8mm Ruled Alternate   |                              |
| EX677123-5                                     | Red          | Plain & 8mm Ruled Alternate   |                              |
| EX677331-5                                     | Yellow       | Plain & 8mm Ruled Alternate   |                              |
| EX67722-5                                      | Red          | Plain & 15mm Ruled Alternate  |                              |
| EX67723-5                                      | Yellow       | Plain & 15mm Ruled Alternate  |                              |
| EX67710-5                                      | Red          | Top Plain, Bottom 8mm Ruled   |                              |
| EX67712-5                                      | Light Green  | Top Plain, Bottom 8mm Ruled   |                              |
| EX67713-5                                      | Light Blue   | Top Plain, Bottom 8mm Ruled   |                              |
| EX67715-5                                      | Red          | Top Plain, Bottom 13mm Ruled  |                              |
| EX67717-5                                      | Yellow       | Top Plain, Bottom 13mm Ruled  |                              |
| EX67718-5                                      | Light Green  | Top Plain, Bottom 13mm Ruled  |                              |
| EX67721-5                                      | Light Blue   | Top Plain, Bottom 13mm Ruled  |                              |
| F  | EX677302-5   | Light Green                   | Top Plain, Bottom 15mm Ruled |

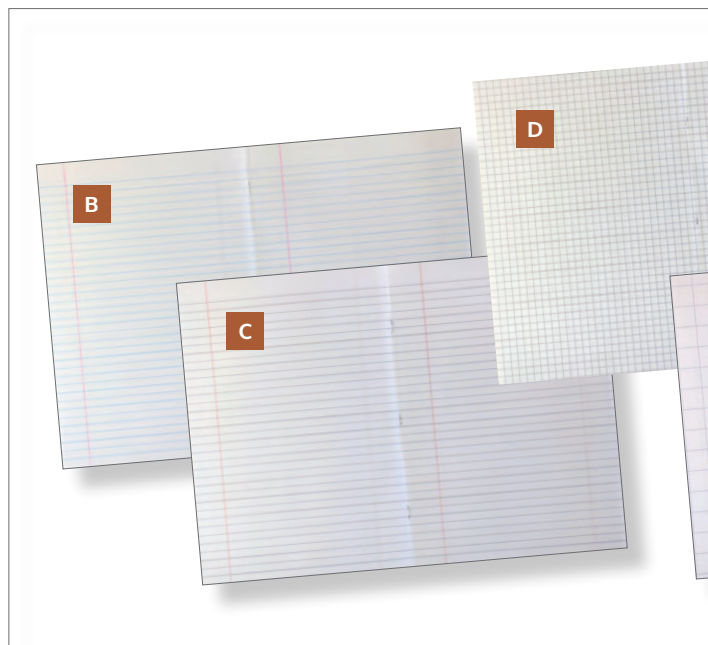

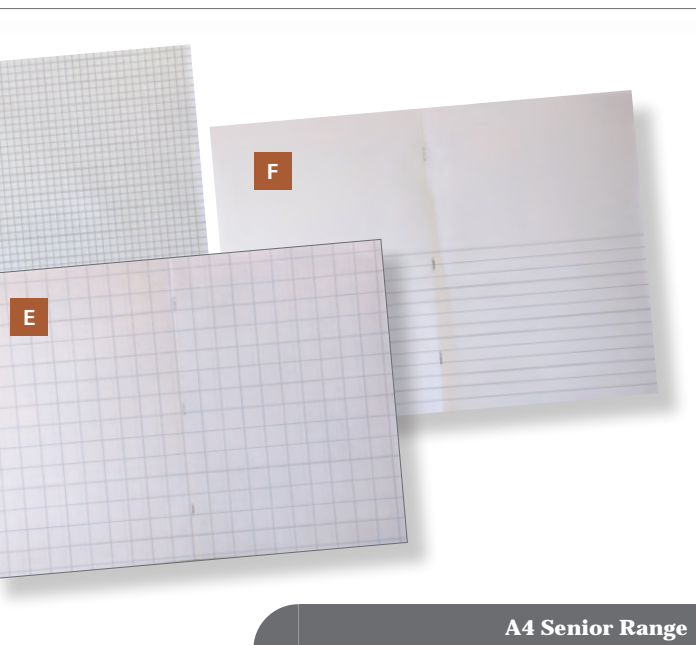

| A4 Senior Books<br>(300mm x 210mm) Pack of 50 |              | 80 Pages<br>£17.05          |
|---|--------------|-----------------------------|
| Paper 75gsm with a 225gsm manilla cover.      |              |                             |
| ORDER CODE                                    | COVER COLOUR | DESCRIPTION                 |
| EX668409-5                                    | Light Blue   | Plain Unruled               |
| EX66823-5                                     | Pink         | Plain Unruled               |
| EX66820-5                                     | Red          | Plain Unruled               |
| EX668136-5                                    | Yellow       | Plain Unruled               |
| EX66865-5                                     | Light Green  | 6mm Ruled & Margin          |
| EX668191-5                                    | Red          | 6mm Ruled & Margin          |
| EX66810-5                                     | Light Blue   | 8mm Ruled                   |
| EX668425-5                                    | Light Blue   | 15mm Ruled                  |
| EX66870-5                                     | Buff         | 8mm Ruled & Margin          |
| EX66836-5                                     | Dark Blue    | 8mm Ruled & Margin          |
| EX668104-5                                    | Dark Green   | 8mm Ruled & Margin          |
| EX668133-5                                    | Light Blue   | 8mm Ruled & Margin          |
| EX668120-5                                    | Light Green  | 8mm Ruled & Margin          |
| EX668146-5                                    | Orange       | 8mm Ruled & Margin          |
| EX66811-5                                     | Pink         | 8mm Ruled & Margin          |
| EX668159-5                                    | Purple       | 8mm Ruled & Margin          |
| EX66849-5                                     | Red          | 8mm Ruled & Margin          |
| EX66894-5                                     | Yellow       | 8mm Ruled & Margin          |
| EX668162-5                                    | Light Blue   | 5mm Squares                 |
| EX66852-5                                     | Orange       | 5mm Squares                 |
| EX668221-5                                    | Red          | 5mm Squares                 |
| EX668175-5                                    | Light Blue   | 7mm Squares                 |
| EX66833-5                                     | Purple       | 7mm Squares                 |
| EX668117-5                                    | Yellow       | 7mm Squares                 |
| EX668188-5                                    | Light Blue   | 10mm Squares                |
| EX668361-5                                    | Purple       | 10mm Squares                |
| EX66821-5                                     | Yellow       | 10mm Squares                |
| EX668373-5                                    | Light Blue   | 20mm Squares                |
| EX66878-5                                     | Dark Green   | Plain & 8mm Ruled Alternate |
| EX66875-5                                     | Light Green  | Plain & 8mm Ruled Alternate |
| EX668123-5                                    | Red          | Plain & 8mm Ruled Alternate |

| A4 Senior Range<br>(300mm x 210mm) Pack of 50 |              | 96 Pages<br>£22.65 |
|---|--------------|--------------------|
| Paper 75gsm with a 225gsm manilla cover.      |              |                    |
| ORDER CODE                                    | COVER COLOUR | DESCRIPTION        |
| EX696120-5                                    | Light Green  | 8mm Ruled & Margin |
| EX696159-5                                    | Purple       | 8mm Ruled & Margin |
| EX69649-5                                     | Red          | 8mm Ruled & Margin |
| EX69694-5                                     | Yellow       | 8mm Ruled & Margin |

**NEW RANGE**

| <b>A</b>                                 |       |                  | <b>Pack of 10</b> |
|--|-------|------------------|-------------------|
| <b>6½" x 4" Aisling Exercise Books</b>   |       |                  |                   |
| 165mm x 102mm with Printed Aisling Cover |       |                  |                   |
| ORDER CODE                               | PAGES | DESCRIPTION      | PRICE             |
| ASNB3                                    | 48    | 7mm Ruled - Blue | £4.00             |

| <b>A</b>                                 |       |                  | <b>Pack of 5</b> |
|--|-------|------------------|------------------|
| <b>6½" x 4" Aisling Exercise Books</b>   |       |                  |                  |
| 165mm x 102mm with Printed Aisling Cover |       |                  |                  |
| ORDER CODE                               | PAGES | DESCRIPTION      | PRICE            |
| ASNB4                                    | 100   | 7mm Ruled - Grey | £3.50            |

| <b>B</b>                                  |       |                         | <b>Pack of 10</b> |
|---|-------|-------------------------|-------------------|
| <b>6½" x 8" Aisling Exercise Books</b>    |       |                         |                   |
| 165mm x 203mm with Printed Aisling Cover. |       |                         |                   |
| ORDER CODE                                | PAGES | DESCRIPTION             | PRICE             |
| ASJ11                                     | 32    | Unruled - Blue Cover    | £2.30             |
| ASJ10                                     | 32    | 15mm Ruled - Pink Cover | £2.30             |

| <b>C</b>                                  |       |                             | <b>Pack of 10</b> |
|---|-------|-----------------------------|-------------------|
| <b>8" x 6½" Aisling Exercise Books</b>    |       |                             |                   |
| 203mm x 165mm with Printed Aisling Cover. |       |                             |                   |
| ORDER CODE                                | PAGES | DESCRIPTION                 | PRICE             |
| ASJ08                                     | 32    | 11mm Ruled - Pink           | £2.30             |
| ASJ09                                     | 32    | 15mm Ruled - Purple         | £2.30             |
| ASX310                                    | 32    | 10mm Squares - Orange       | £2.30             |
| ASX2                                      | 40    | 8mm Ruled & Margin - Yellow | £2.38             |
| ASX3                                      | 40    | 7mm Squares - Red           | £2.38             |
| ASX6                                      | 88    | 8mm Ruled & Margin - Red    | £4.00             |
| ASX13                                     | 88    | 7mm Squares - Orange        | £4.00             |
| ASX7                                      | 120   | 8mm Ruled & Margin - Blue   | £4.66             |

| <b>D</b>                                  |       |  | <b>Pack of 10</b> |
|---|-------|--|-------------------|
| <b>9" x 7" Aisling Exercise Books</b>     |       |  |                   |
| 230mm x 180mm with Printed Aisling Cover. |       |  |                   |
| ORDER CODE                                | PAGES | DESCRIPTION                                | PRICE             |
| ASJ04                                     | 32    | Unruled - Blue                             | £2.96             |
| ASXP                                      | 32    | Plain & 8mm Ruled Alternate - Green        | £2.96             |
| ASXP15A                                   | 32    | Top ½ Plain - Bottom ½ 11mm Ruled - Red    | £2.96             |
| ASXP15                                    | 32    | Top ½ Plain - Bottom ½ 15mm Ruled - Purple | £2.96             |
| ASJ07                                     | 32    | 20mm Squares - Orange                      | £2.96             |

| <b>E</b>                                  |       |                             | <b>Pack of 5</b> |
|---|-------|-----------------------------|------------------|
| <b>A4 Aisling Exercise Books</b>          |       |                             |                  |
| 300mm x 210mm with Printed Aisling Cover. |       |                             |                  |
| ORDER CODE                                | PAGES | DESCRIPTION                 | PRICE            |
| ASBM                                      | 32    | 8mm Ruled & Margin - Red    | £4.00            |
| ASE4                                      | 120   | 8mm Ruled & Margin - Yellow | £5.76            |

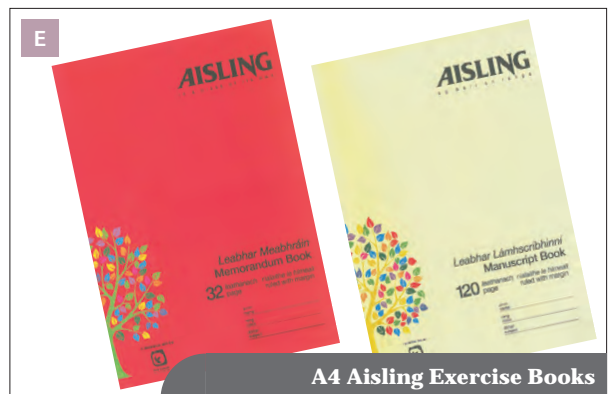
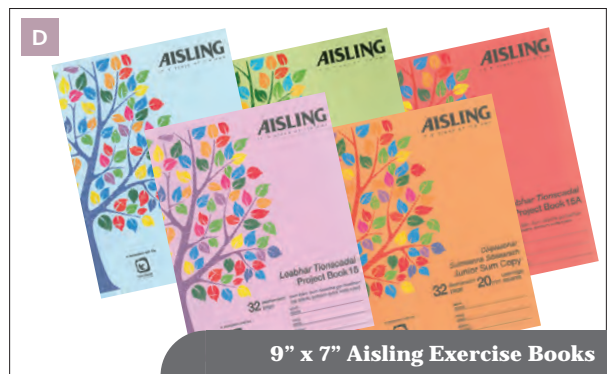
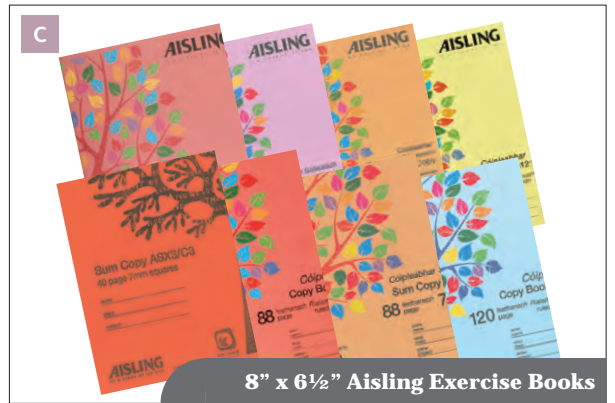

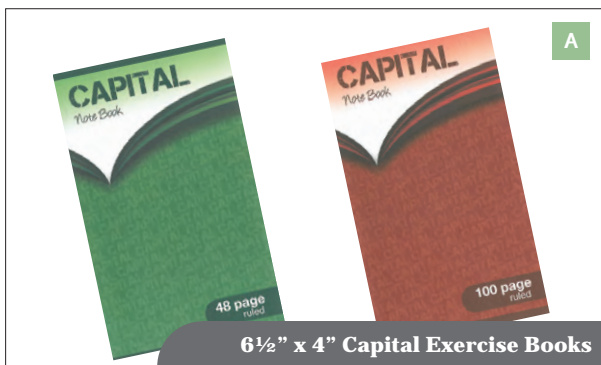

| 6½" x 4" Capital Exercise Books          |       |                   | Pack of 10 |
|--|-------|-------------------|------------|
| 165mm x 102mm with Printed Capital Cover |       |                   |            |
| ORDER CODE                               | PAGES | DESCRIPTION       | PRICE      |
| C30058                                   | 48    | 7mm Ruled - Green | £4.00      |

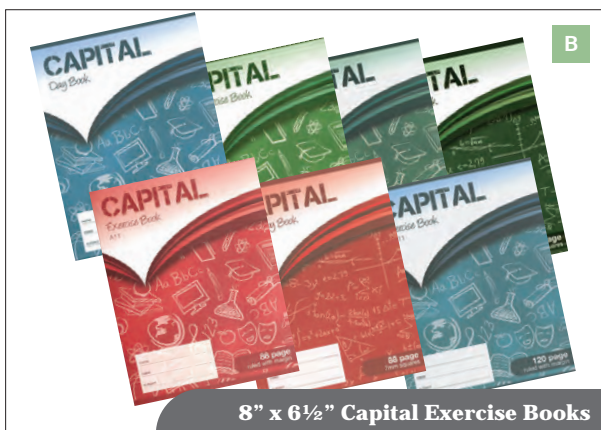

| 6½" x 4" Capital Exercise Books          |       |                 | Pack of 5 |
|--|-------|-----------------|-----------|
| 165mm x 102mm with Printed Capital Cover |       |                 |           |
| ORDER CODE                               | PAGES | DESCRIPTION     | PRICE     |
| C30062                                   | 100   | 7mm Ruled - Red | £3.50     |

| 8" x 6½" Capital Exercise Books           |       |                            | Pack of 10 |
|---|-------|----------------------------|------------|
| 203mm x 165mm with Printed Capital Cover. |       |                            |            |
| ORDER CODE                                | PAGES | DESCRIPTION                | PRICE      |
| C30030                                    | 32    | 10mm Squares - Blue        | £2.30      |
| C30026                                    | 40    | Unruled - Green            | £2.38      |
| C30000                                    | 40    | 8mm Ruled & Margin - Green | £2.38      |
| C30008                                    | 40    | 7mm Squares - Green        | £2.38      |
| C30010                                    | 88    | 8mm Ruled & Margin - Red   | £4.00      |
| C30009                                    | 88    | 7mm Squares - Red          | £4.00      |
| C30012                                    | 120   | 8mm Ruled & Margin - Blue  | £4.66      |



| 9" x 7" Capital Exercise Books            |       |   | Pack of 10 |
|---|-------|---|------------|
| 230mm x 180mm with Printed Capital Cover. |       |   |            |
| ORDER CODE                                | PAGES | DESCRIPTION                               | PRICE      |
| C30020                                    | 32    | Plain & 8mm Ruled Alternate               | £2.96      |
| C30014                                    | 32    | Top ½ Plain - Bottom ½ 11mm Ruled - Green | £2.96      |
| C30016                                    | 32    | Top ½ Plain - Bottom ½ 15mm Ruled         | £2.96      |
| C30032                                    | 32    | 20mm Squares - Red                        | £2.96      |

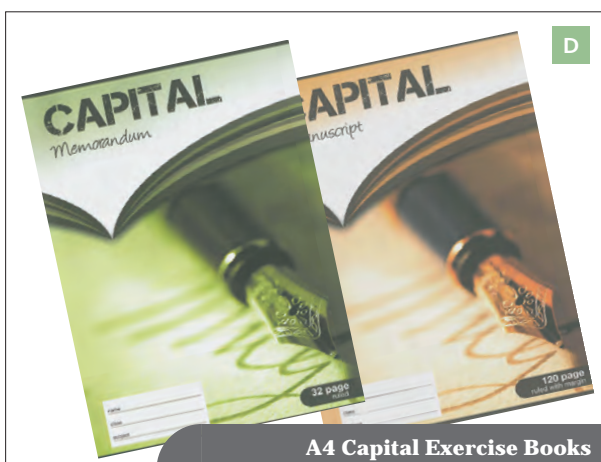

| A4 Capital Exercise Books                 |       |                            | Pack of 5 |
|---|-------|----------------------------|-----------|
| 300mm x 210mm with Printed Capital Cover. |       |                            |           |
| ORDER CODE                                | PAGES | DESCRIPTION                | PRICE     |
| C30042                                    | 32    | 8mm Ruled - Green          | £4.00     |
| C30013                                    | 120   | 8mm Ruled & Margin - Beige | £5.76     |

| Vocabulary Books 6½" x 4"<br>(165mm x 102mm) Pack of 100 |              |                           | 48 Pages<br>£13.65 |
|--|--------------|---------------------------|--------------------|
| Paper 75gsm with a 225gsm manilla cover.                 |              |                           |                    |
| ORDER CODE   | COVER COLOUR | DESCRIPTION               |                    |
| NB01250  | Yellow       | Plain Unruled             |                    |
| NB01265  | Light Blue   | 7mm Ruled                 |                    |
| NB01281  | Light Green  | 7mm Ruled                 |                    |
| NB01278  | Red          | 7mm Ruled                 |                    |
| NB01252  | Light Blue   | 7mm Ruled & Centre Margin |                    |
| NB01294  | Yellow       | 7mm Ruled & Centre Margin |                    |

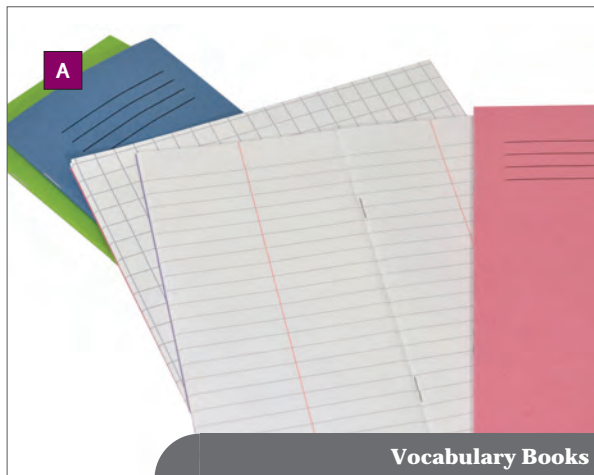

| Vocabulary Books 8" x 4"<br>(203mm x 102mm) Pack of 100 |              |                           | 32 Pages<br>£12.90 |
|---|--------------|---------------------------|--------------------|
| Paper 75gsm with a 225gsm manilla cover.                |              |                           |                    |
| ORDER CODE  | COVER COLOUR | DESCRIPTION               |                    |
| NB005106  | Light Green  | Plain Unruled             |                    |
| NB005122  | Purple       | 8mm Ruled & Centre Margin |                    |
| NB00583   | Yellow       | 8mm Ruled                 |                    |
| NB00596   | Light Blue   | 12mm Ruled                |                    |
| NB00596R  | Red          | 12mm Ruled                |                    |
| NB005119  | Pink         | 10mm Squares              |                    |



| Vocabulary Notebooks 8" x 4½"<br>(203mm x 115mm) Pack of 100 |              |             | 80 Pages<br>£29.20 |
|--|--------------|-------------|--------------------|
| Paper 75gsm with a 225gsm manilla cover.                     |              |             |                    |
| ORDER CODE   | COVER COLOUR | DESCRIPTION |                    |
| NB02220  | Light Blue   | 6mm Ruled   |                    |
| NB02217  | Dark Blue    | 8mm Ruled   |                    |

| Rough Work Books 8" x 6½"<br>(203mm x 165mm) Pack of 100 |              |               | 96 Pages<br>£28.10 |
|--|--------------|---------------|--------------------|
| Paper 60gsm with a 225gsm manilla cover.                 |              |               |                    |
| ORDER CODE   | COVER COLOUR | DESCRIPTION   |                    |
| VRE01114   | Pink         | Plain Unruled |                    |
| VRE01127   | Light Blue   | 8mm Ruled     |                    |



| Rough Work Books 9" x 7"<br>(230mm x 178mm) Pack of 50 |              |             | 48 Pages<br>£9.60 |
|--|--------------|-------------|-------------------|
| Paper 60gsm with a 225gsm manilla cover.               |              |             |                   |
| ORDER CODE   | COVER COLOUR | DESCRIPTION |                   |
| VRE02010-5   | Brown        | 8mm Ruled   |                   |

| Rough Work Books 9" x 7"<br>(230mm x 178mm) Pack of 100 |              |               | 96 Pages<br>£31.65 |
|---|--------------|---------------|--------------------|
| Paper 60gsm with a 225gsm manilla cover.                |              |               |                    |
| ORDER CODE  | COVER COLOUR | DESCRIPTION   |                    |
| VRE02812  | Pink         | Plain Unruled |                    |
| VRE02825  | Light Blue   | 8mm Ruled     |                    |



| Project / Bulletin Books 8" x 10"<br>Landscape (200mm x 250mm) Pack of 100 |               | 32 Pages<br>£24.75           |
|--|---------------|------------------------------|
| Paper 75gsm with a 225gsm manilla cover.                                   |               |                              |
| ORDER CODE   | COVER COLOUR  | DESCRIPTION                  |
| DU017119   | Asstd Colours | Plain Unruled                |
| DU01783  | Light Blue    | Plain Unruled                |
| DU01740  | Light Green   | Plain Unruled                |
| DU01716  | Pink          | Plain Unruled                |
| DU01796  | Red           | Plain Unruled                |
| DU01770  | Yellow        | Plain Unruled                |
| PW02931  | Dark Blue     | 15mm Ruled                   |
| PW02944  | Red           | 15mm Ruled                   |
| PW02928  | Yellow        | 15mm Ruled                   |
| PW02960  | Dark Blue     | Top Plain, Bottom 15mm Ruled |

| Project / Bulletin Books 10" x 8"<br>Portrait (250mm x 200mm) Pack of 100 |               | 32 Pages<br>£24.75 |
|---|---------------|--------------------|
| Paper 75gsm superior paper, with a 225gsm manilla cover.                  |               |                    |
| ORDER CODE  | COVER COLOUR  | DESCRIPTION        |
| DU0208  | Asstd Colours | Plain Unruled      |

| Large Project Books 13" x 10" (A4 Plus)<br>Portrait (330mm x 250mm) Pack of 100 |               | 40 Pages<br>£37.60           |
|---|---------------|------------------------------|
| Paper 75gsm with a 225gsm manilla cover.  |               |                              |
| ORDER CODE  | COVER COLOUR  | DESCRIPTION                  |
| DU0218  | Asstd Colours | Plain Unruled                |
| DU02812   | Light Blue    | Plain Unruled                |
| DU02436   | Light Green   | Plain Unruled                |
| DU02449   | Pink          | Plain Unruled                |
| DU02423   | Purple        | Plain Unruled                |
| DU02410   | Red           | Plain Unruled                |
| DU02452   | Yellow        | Plain Unruled                |
| DU024160  | Light Blue    | 8mm Ruled                    |
| DU024120  | Light Green   | 8mm Ruled                    |
| DU024150  | Pink          | 8mm Ruled                    |
| DU024130  | Purple        | 8mm Ruled                    |
| DU024110  | Red           | 8mm Ruled                    |
| DU024100  | Yellow        | 8mm Ruled                    |
| DU024260  | Light Blue    | 12mm Ruled                   |
| DU024220  | Light Green   | 12mm Ruled                   |
| DU024250  | Pink          | 12mm Ruled                   |
| DU024230  | Purple        | 12mm Ruled                   |
| DU024210  | Red           | 12mm Ruled                   |
| DU024200  | Yellow        | 12mm Ruled                   |
| DU024360  | Light Blue    | 7mm Squares                  |
| DU024320  | Light Green   | 7mm Squares                  |
| DU024350  | Pink          | 7mm Squares                  |
| DU024330  | Purple        | 7mm Squares                  |
| DU024310  | Red           | 7mm Squares                  |
| DU024300  | Yellow        | 7mm Squares                  |
| PW02812   | Light Blue    | Top Plain, Bottom 12mm Ruled |

| Project Books 9" x 7"<br>(230mm x 180mm) Pack of 100 |              | 32 Pages<br>£23.70           | C |
|--|--------------|------------------------------|---|
| Paper 75gsm with a 225gsm manilla cover.             |              |                              |   |
| ORDER CODE   | COVER COLOUR | DESCRIPTION                  |   |
| PW02346  | Light Blue   | Plain Unruled                |   |
| PW02317  | Light Green  | Top Plain, Bottom 12mm Ruled |   |
| PW02320  | Red          | Top Plain, Bottom 15mm Ruled |   |
| PW0263   | Purple       | Plain & 15mm Ruled Alternate |   |
| PW02333  | Yellow       | 20mm Squares                 |   |

| Project / Bulletin Books A4<br>Portrait (300mm x 210mm) Pack of 100 |              | 32 Pages<br>£23.20 |
|---|--------------|--------------------|
| Paper 75gsm with a 225gsm manilla cover.                            |              |                    |
| ORDER CODE  | COVER COLOUR | DESCRIPTION        |
| DU01484   | Blue         | Plain Unruled      |
| DU01471   | Green        | Plain Unruled      |
| DU014123  | Pink         | Plain Unruled      |
| DU014110  | Purple       | Plain Unruled      |
| DU01497   | Red          | Plain Unruled      |
| DU014107  | Yellow       | Plain Unruled      |

| Aisling Scrap Book 13" x 9"<br>Portrait 330mm x 235mm (A4 plus)<br>Pack Of 6  |                  | 36 Pages<br>£8.20         | A          |
|---|------------------|---------------------------|------------|
| 100gsm paper Assorted colours superior Linen Embossed Covers. Staple Bound on long edge. Printed Index List on Inside of Cover. |                  |                           |            |
| ORDER CODE  | COVER COLOUR     | DESCRIPTION               |            |
| ASCB6   | Assorted Colours | Plain Blue Coloured Paper | <b>NEW</b> |

| Aisling Scrap Book 13" x 9"<br>Portrait 330mm x 235mm (A4 plus)<br>Pack Of 6   |                  | 80 Pages<br>£16.80                           | B          |
|--|------------------|--|------------|
| 100gsm paper Assorted coloured superior linen embossed covers. Tape Bound on long edge. Printed Index List on Inside of Cover. |                  |  |            |
| ORDER CODE   | COVER COLOUR     | DESCRIPTION                                  |            |
| ASCB2  | Assorted Colours | Plain Assorted Coloured Paper<br>(6 Colours) | <b>NEW</b> |



A4+ Aisling Scrap Books

|  |  |                            |
|--|--|----------------------------|
| <b>A</b>   | <b>Rhino Scrap Books 13" x 9"<br/>(330mm x 235mm) Pack of 12</b> | <b>24 Pages<br/>£10.10</b> |
| Paper 100gsm Bright Design Illustrated Cover. Staple-bound on long edge. Printed Index List on Inside Cover. |  |                            |
| <b>ORDER CODE</b>  | <b>COVER COLOUR</b>  | <b>DESCRIPTION</b>         |
| SB3  | Bright Design  | Plain Blue Coloured Paper  |

|   |   |                           |
|---|---|---------------------------|
| <b>B</b>  | <b>Rhino Scrap Books 13" x 9"<br/>(330mm x 235mm) Pack of 6</b> | <b>36 Pages<br/>£8.20</b> |
| Paper 100gsm Blue Cover with a 220gsm Linen-embossed Cover. Staple-bound on long edge and with a printed index on inside cover. |   |                           |
| <b>ORDER CODE</b>   | <b>COVER COLOUR</b>   | <b>DESCRIPTION</b>        |
| SB6   | Assorted  | Plain Blue Coloured Paper |

|  |   |                               |
|--|---|-------------------------------|
| <b>C</b>   | <b>Rhino Scrap Books 13" x 9"<br/>(330mm x 235mm) Pack of 6</b> | <b>80 Pages<br/>£16.80</b>    |
| Paper 100gsm Mixed Colours with a 220gsm Linen-embossed Cover. Tape-bound on long edge and with a printed index on inside cover. |   |                               |
| <b>ORDER CODE</b>  | <b>COVER COLOUR</b>   | <b>DESCRIPTION</b>            |
| SB2  | Assorted  | Plain Assorted Coloured Paper |

|  |   |                            |
|--|---|----------------------------|
| <b>D</b>   | <b>Rhino Cuttings Album 12" x 12"<br/>(300mm x 300mm) Pack of 3</b> | <b>20 Leaves<br/>£9.90</b> |
| 170-gsm black ribbed heavy duty paper with extra thick black card cover for cuttings, photos or scrapbooking. Wire spiral bound. |   |                            |
| <b>ORDER CODE</b>  | <b>COVER COLOUR</b>   | <b>DESCRIPTION</b>         |
| RHBSB  | Black   | Black ribbed paper         |

|   |   |                            |
|---|---|----------------------------|
| <b>E</b>  | <b>Westmorland Cuttings Album 12" x 12"<br/>(300mm x 300mm) Pack of 1</b> | <b>40 Leaves<br/>£5.80</b> |
| 280micron black heavy duty card with extra thick black cover, for cuttings, photos or scrapbooking. Large 3D wire spiral bound. |   |                            |
| <b>ORDER CODE</b>   | <b>COVER COLOUR</b>   | <b>DESCRIPTION</b>         |
| RHBSB-40  | Black   | Black plain paper          |

|  |  |                     |
|--|--|---------------------|
| <b>F</b>   | <b>Photo Mounting Corners<br/>(Permanent Adhesive) Pack of 250</b> | <b>£1.50</b>        |
| Ideal for photo albums, scrapbooks, post cards and other collectable memorabilia. Self adhesive and acid free. |  |                     |
| <b>ORDER CODE</b>  | <b>COLOUR</b>  | <b>DESCRIPTION</b>  |
| S57072   | Transparent  | Photo mount corners |

|  |   |                    |
|--|---|--------------------|
| <b>G</b>   | <b>Photo Mounting Squares<br/>(Permanent Adhesive) Pack of 48</b> | <b>£1.50</b>       |
| Ideal for photo albums, scrapbooks, post cards and other collectable memorabilia. Double sided mounting squares. |   |                    |
| <b>ORDER CODE</b>  | <b>COLOUR</b>   | <b>DESCRIPTION</b> |
| S56946   | Transparent   | 19mm squares       |

|  |  |                    |
|--|--|--------------------|
| <b>H</b>   | <b>Photo Mounting Glue<br/>(Repositional Adhesive) Pack of 1</b> | <b>£2.85</b>       |
| Ideal for photo albums, scrapbooks, post cards and other collectable memorabilia. Squeezeable tube with nozzle attachment. |  |                    |
| <b>ORDER CODE</b>  | <b>COLOUR</b>  | <b>DESCRIPTION</b> |
| S57236   | Transparent  | 50ml tube.         |



Scrap Books



Cutting Album's



Westmorland Album Rings Size



Photo Fixers

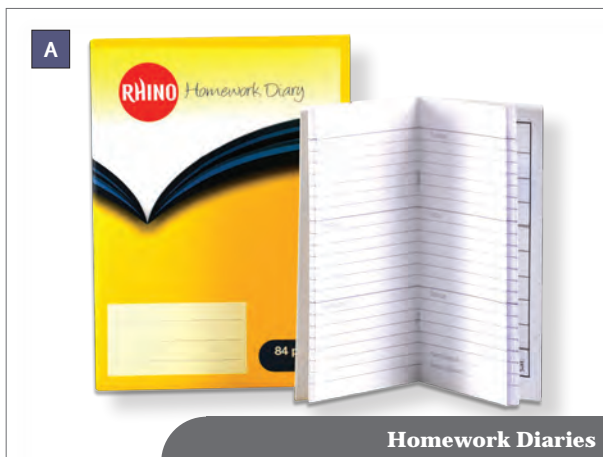

Homework Diaries

| Homework Diaries 6¼" x 4"<br>(160mm x 100mm) 84 Pages                               |           |        |
|---|-----------|--------|
| Paper 75gsm with a 225gsm manilla printed cover.<br>Pupils 6 Day Timetable & Diary. |           |        |
| ORDER CODE  | PACK SIZE | PRICE  |
| SDWD1/10  | 10        | £4.05  |
| SDWD1   | 100       | £33.30 |



Record Book

| Homework Diaries 8" x 6"<br>(205mm x 150mm) 84 Pages                               |           |        |
|--|-----------|--------|
| Paper 75gsm with a 225gsm manilla printed cover<br>Pupils 5 Day Timetable & Diary. |           |        |
| ORDER CODE   | PACK SIZE | PRICE  |
| SDWD2/10   | 10        | £6.88  |
| SDWD2  | 100       | £56.20 |



Book-keeping Books

| Project / Bulletin Books 8" x 10"<br>(200mm x 250mm) Pack of 100 |               | 32 Pages<br>£24.75           |
|--|---------------|------------------------------|
| Paper 75gsm with a 225gsm manilla cover.                         |               |                              |
| ORDER CODE   | COVER COLOUR  | DESCRIPTION                  |
| DU01719  | Asstd Colours | Plain Unruled                |
| DU01783  | Light Blue    | Plain Unruled                |
| DU01740  | Light Green   | Plain Unruled                |
| DU01716  | Pink          | Plain Unruled                |
| DU01796  | Red           | Plain Unruled                |
| DU01770  | Yellow        | Plain Unruled                |
| PW02931  | Dark Blue     | 15mm Ruled                   |
| PW02944  | Red           | 15mm Ruled                   |
| PW02928  | Yellow        | 15mm Ruled                   |
| PW02960  | Dark Blue     | Top Plain, Bottom 15mm Ruled |

| A4 Record Book<br>(300mm x 210mm) Pack of 5       |              | 80 Pages<br>£14.20            |
|---|--------------|-------------------------------|
| Foil blocked "Record Book" on cover. Hard backed. |              |                               |
| ORDER CODE  | COVER COLOUR | DESCRIPTION                   |
| AR1592  | Dark Blue    | Printed teacher's record book |

| A4 Register & Mark Book<br>(333mm x 203mm)  |              |            |        |
|---|--------------|------------|--------|
| Foil blocked "Register and Mark Book" on cover. Hard backed.<br>Attendance Register 50 Names. |              |            |        |
| ORDER CODE  | COVER COLOUR | PACK SIZE  | PRICE  |
| AR158-01  | Dark Blue    | Each       | £5.70  |
| AR158   | Dark Blue    | Pack of 10 | £48.40 |

| Book-keeping Books A4<br>(210mm x 300mm) Pack of 12   |              | 32 Pages<br>£13.40             |
|---|--------------|--------------------------------|
| 4 different types of book-keeping books. Bound in an attractive hard-wearing cover, excellent quality 90gsm paper. Staple-bound on the long edge. |              |                                |
| ORDER CODE  | COVER COLOUR | DESCRIPTION                    |
| BKA   | Purple       | Analysis Ruling                |
| BKC   | Green        | Cash Ruling <b>BEST SELLER</b> |
| BKJ   | Blue         | Journal Ruling                 |
| BKL   | Red          | Ledger Ruling                  |

|   |   |                            |
|---|---|----------------------------|
| <b>A</b>  | <b>Book-keeping Books A4<br/>(210mm x 300mm) Pack of 10</b> | <b>48 Pages<br/>£13.80</b> |
| 90gsm paper with cover. 6 Decimal Book-keeping columns. |   |                            |
| <b>ORDER CODE</b>                                       | <b>COVER COLOUR</b>   | <b>DESCRIPTION</b>         |
| D09011  | Light Green   | 6 Decimal Columns          |



Book-keeping Book

|   |  |                          |
|---|--|--------------------------|
| <b>B</b>  | <b>Book-keeping Paper A4<br/>(210mm x 300mm) Pack 500 sheets</b> | <b>1 Ream<br/>£16.20</b> |
| Paper 90gsm, punched 2 holes. Sold by the ream. |  |                          |
| <b>ORDER CODE</b>                               | <b>COVER COLOUR</b>  | <b>DESCRIPTION</b>       |
| D09059  | None   | 6 Decimal Columns        |

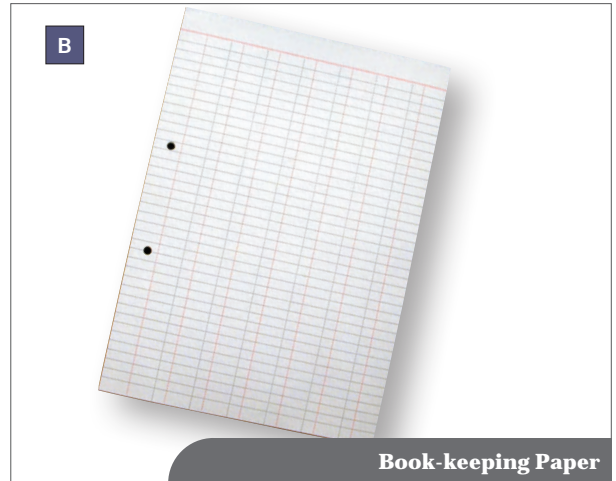

Book-keeping Paper

|  |   |                           |
|--|---|---------------------------|
| <b>C</b>   | <b>Rhino Kids Range - VAT FREE<br/>(165mm x 100mm) Pack of 12</b> | <b>24 Pages<br/>£6.84</b> |
| High quality books designed to stimulate and educate young children. |   |                           |
| <b>ORDER CODE</b>  | <b>COVER COLOUR</b>   | <b>DESCRIPTION</b>        |
| RKAN   | Printed   | Facts about Animals       |
| RKTR   | Printed   | Facts about Transport     |
| RKSP   | Printed   | Facts about Space         |
| RKNA   | Printed   | Facts about Nature        |

|  |                             |                    |
|--|-----------------------------|--------------------|
| <b>Rhino Professional Notebooks A4<br/>(300mm x 210mm) Pack of 3</b>   | <b>160 Pages<br/>£14.99</b> |                    |
| Protective fold-back cover, stiff backing board, pocket for holding disks, pens, notes etc., spiral-bound pages perforated for tear outs, punched 2 holes. Assorted colour covers. |                             |                    |
| <b>ORDER CODE</b>  | <b>COVER COLOUR</b>         | <b>DESCRIPTION</b> |
| CL4S8  | Assorted                    | 8mm Ruled & Margin |



Counsels Notebook

|   |   |                           |
|---|---|---------------------------|
| <b>D</b>  | <b>Counsels Legal Notebooks A4<br/>(300mm x 210mm) Pack of 10</b> | <b>96 Pages<br/>£6.35</b> |
| Strong 225gsm manilla cover, staple bound. Perforated sheets. |   |                           |
| <b>ORDER CODE</b>   | <b>COVER COLOUR</b>   | <b>DESCRIPTION</b>        |
| RHCN5   | Blue  | 8mm Ruled                 |

|  |                           |                                       |
|--|---------------------------|---------------------------------------|
| <b>Learn To Write Pad A4<br/>(210mm x 300mm) Pack of 12</b>          | <b>40 Pages<br/>£5.15</b> |                                       |
| Complete with template writing examples printed on the inside cover. |                           |                                       |
| <b>ORDER CODE</b>  | <b>COVER COLOUR</b>       | <b>DESCRIPTION</b>                    |
| RKLTWP   | Printed                   | Rhino 'Learn to Write' special ruling |

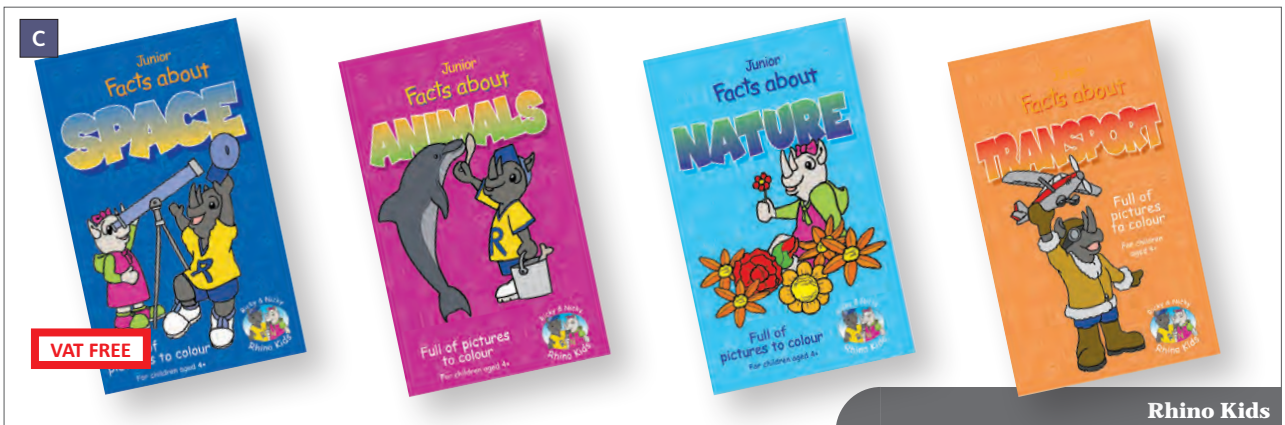

Rhino Kids

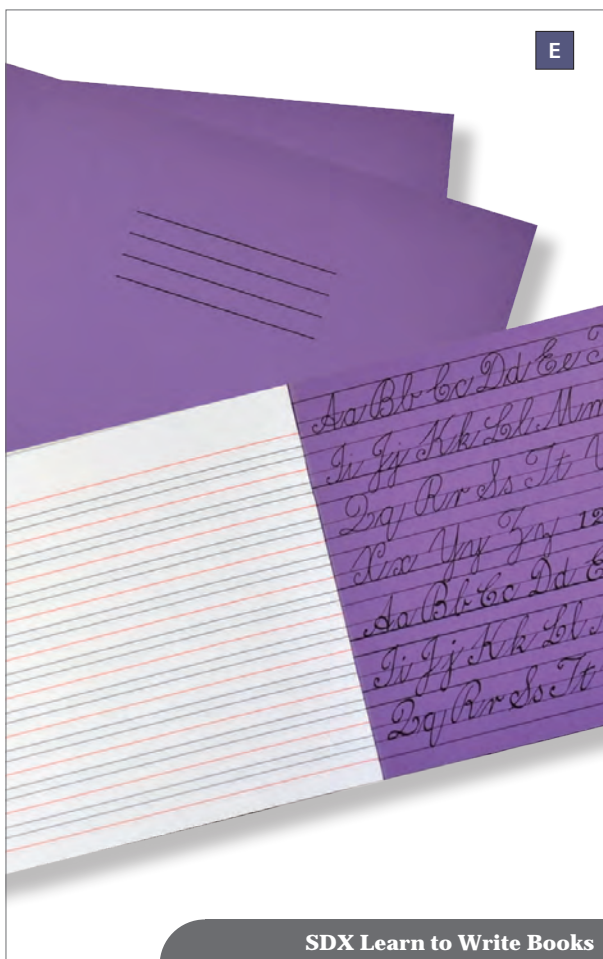

SDX Learn to Write Books

| Learn To Write 6¼" x 8"<br>(160mm x 200mm) Pack of 100  |              | 32 Pages<br>£24.99                          | E |
|---|--------------|---|---|
| Paper 75gsm with a 225gsm manilla cover. Also known as Handwriting Books. Cover printed inside with sample handwriting. |              |   |   |
| ORDER CODE  | COVER COLOUR | DESCRIPTION                                 |   |
| SDXB4   | Purple       | 4mm Blue Ruled centred on<br>15mm Red Ruled |   |
| SDXB2   | Red          | 6mm Blue Ruled centred on<br>20mm Red Ruled |   |

| Learn To Write 6¼" x 8"<br>(160mm x 200mm) Pack of 25 |              | 32 Pages<br>£8.99                           | F |
|---|--------------|---|---|
| Paper 75gsm with a 225gsm manilla cover.              |              |   |   |
| ORDER CODE  | COVER COLOUR | DESCRIPTION                                 |   |
| REXB4   | Printed      | 4mm Blue Ruled centred on<br>15mm Red Ruled |   |
| REXB2   | Printed      | 6mm Blue Ruled centred on<br>20mm Red Ruled |   |

| Value Learn To Write 8" X 6½"<br>(200mm x 165mm) Pack of 100 |              | 32 Pages<br>£16.85                          |  |
|--|--------------|---|--|
| Paper 75gsm with a 225gsm manilla cover.                     |              |   |  |
| ORDER CODE   | COVER COLOUR | DESCRIPTION                                 |  |
| SDXB6  | Dark Green   | 4mm Blue Ruled centred on<br>15mm Red Ruled |  |

| Reading Record Book 8" X 6"<br>(200mm x 150mm) Pack of 100 |                | 40 Pages<br>£36.55              | G |
|--|----------------|---------------------------------|---|
| Paper 75gsm with a 225gsm manilla cover.                   |                |                                 |   |
| ORDER CODE   | COVER COLOUR   | DESCRIPTION                     |   |
| SDRR5  | Yellow printed | Special 'Reading Record' ruling |   |

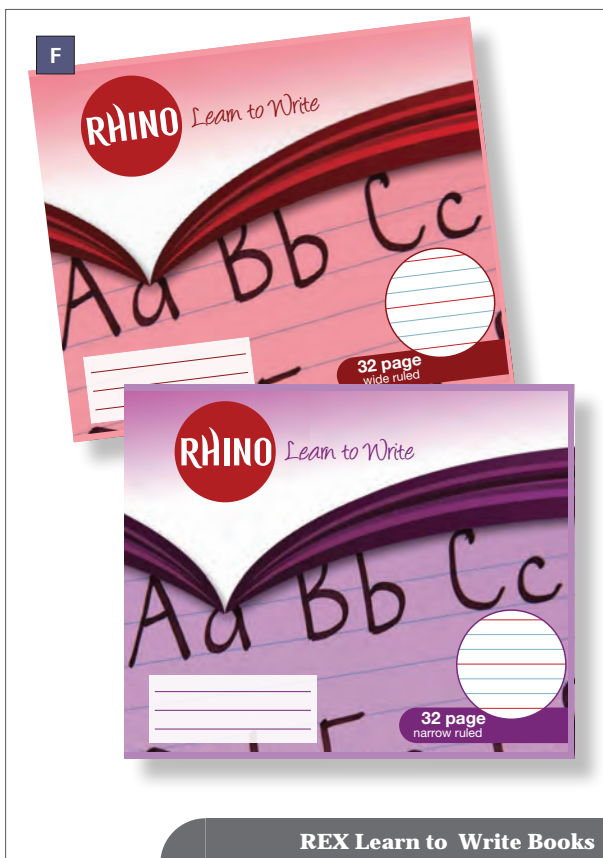

REX Learn to Write Books

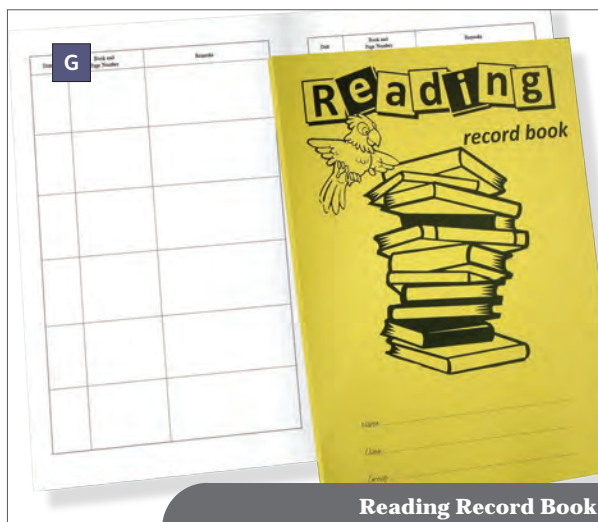

Reading Record Book

| A Guild Postage Book<br>(298mm x 152mm) 80 Pages                     |              |                           |       |
|--|--------------|---------------------------|-------|
| Printed heading for date, stamps bought, addresses and postage cost. |              |                           |       |
| ORDER CODE   | COVER COLOUR | RULING                    | PRICE |
| T229Z  | Grey         | Each page ruled 42 feints | £8.99 |

| B Guild Company Visitors Book<br>(298mm x 203mm) 160 Pages   |              |                     |        |
|--|--------------|---------------------|--------|
| Records date, time in & out, badge no, name, company, to see & car reg. Each page is ruled for 30 entries, giving a capacity of 4,800 entries. |              |                     |        |
| ORDER CODE   | COVER COLOUR | RULING              | PRICE  |
| T253Z  | Blue         | 30 Entries per page | £10.30 |

| C Guild Accident/Injury Record Book<br>Pack of 5<br>(210mm x 200mm) 20 Pages  |               |                    |        |
|---|---------------|--------------------|--------|
| Perforated pages to comply with current Data Protection Act requirements. Meets Health & Safety regulations & contains useful guidance notes. |               |                    |        |
| ORDER CODE  | COVER COLOUR  | RULING             | PRICE  |
| T44Z  | Green & White | One entry per page | £10.20 |

| Guild Loose Leaf Visitors Book<br>(236mm x 349mm)  |              |                     |        |
|--|--------------|---------------------|--------|
| Records date, time in & out, badge no, name, company, to see & car reg. Includes 50 sheets each ruled for 18 entries per page. |              |                     |        |
| ORDER CODE   | COVER COLOUR | RULING              | PRICE  |
| T40Z   | Blue PVC     | 18 Entries per page | £17.99 |

| D Guild Refill for Loose Leaf Visitors Book<br>(298mm x 152mm)   |                     |       |
|--|---------------------|-------|
| Records date, time in & out, badge no, name, company, to see & car reg. Includes 50 sheets each ruled for 18 entries per page. |                     |       |
| ORDER CODE   | RULING              | PRICE |
| T40-RZ   | 18 Entries per page | £5.70 |

| E Europa Revision Cards Booklet<br>(152mm x 76mm) Pack of 10 |              |             |        |
|--|--------------|-------------|--------|
| Twinwire Bound Booklet containing 50 cards.                  |              |             |        |
| ORDER CODE   | COVER COLOUR | DESCRIPTION | PRICE  |
| 3002Z  | Red          | 8mm Ruled   | £17.50 |

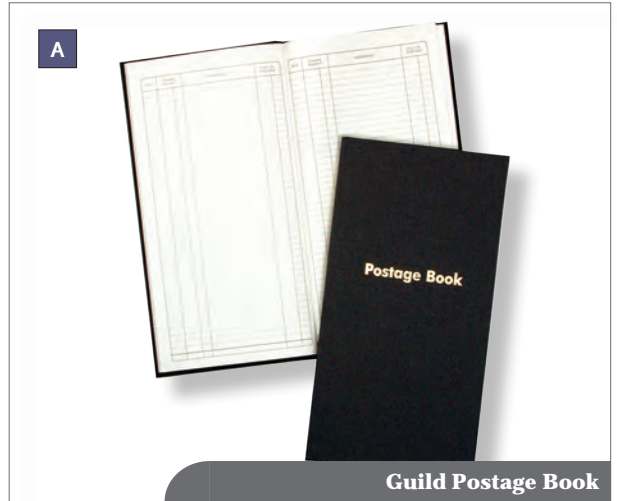

Guild Postage Book



Guild Company Visitors Books



Guild Accident/Injury Record Book



Europa Revision Cards Booklet



Guild Refill Loose Leaf Visitors Books

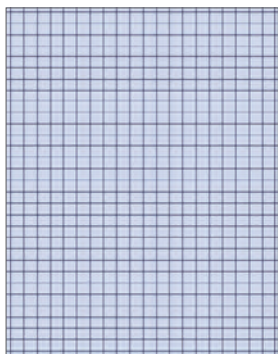

F

Special Educational Needs Exercise Books & Pads available in 4 paper colours. Blue, Pink, Green & Cream Vellum

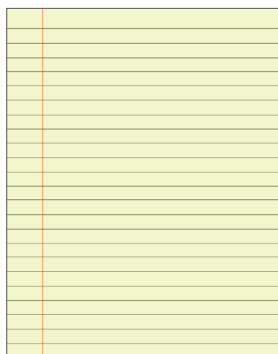
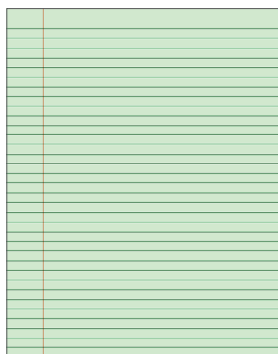

G

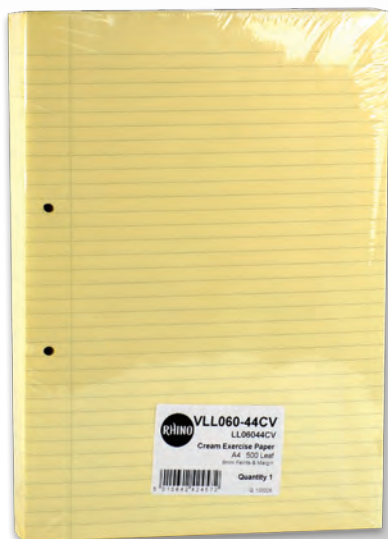

Special Educational Needs File Paper Punched

H



Special Educational Needs File Paper

| Special Educational Needs Exercise Books<br>Pack of 10 - (300mm x 210mm) |            |                     | 48<br>Pages<br>£5.99 |
|--|------------|---------------------|----------------------|
| Coloured Paper 80gsm with a 225gsm manilla cover.                        |            |                     | <b>NEW RANGE</b>     |
| ORDER CODE   | COVER      | Description         | PAPER                |
| EX68197B   | Light Blue | 8mm Ruled & Margin  | Blue                 |
| EX68197CV  | Light Blue | 8mm Ruled & Margin  | Cream                |
| EX68197G   | Light Blue | 8mm Ruled & Margin  | Green                |
| EX68197PP  | Light Blue | 8mm Ruled & Margin  | Pink                 |
| EX68184B   | Red        | 8mm Ruled & Margin  | Blue                 |
| EX68184CV  | Red        | 8mm Ruled & Margin  | Cream                |
| EX68184G   | Red        | 8mm Ruled & Margin  | Green                |
| EX68184PP  | Red        | 8mm Ruled & Margin  | Pink                 |
| EX68139B   | Yellow     | 8mm Ruled & Margin  | Blue                 |
| EX68139CV  | Yellow     | 8mm Ruled & Margin  | Cream                |
| EX68139G   | Yellow     | 8mm Ruled & Margin  | Green                |
| EX68139PP  | Yellow     | 8mm Ruled & Margin  | Pink                 |
| EX681111B  | Light Blue | 12mm Ruled & Margin | Blue                 |
| EX681111CV   | Light Blue | 12mm Ruled & Margin | Cream                |
| EX681111G  | Light Blue | 12mm Ruled & Margin | Green                |
| EX681111PP   | Light Blue | 12mm Ruled & Margin | Pink                 |
| EX681109B  | Red        | 12mm Ruled & Margin | Blue                 |
| EX681109CV   | Red        | 12mm Ruled & Margin | Cream                |
| EX681109G  | Red        | 12mm Ruled & Margin | Green                |
| EX681109PP   | Red        | 12mm Ruled & Margin | Pink                 |
| EX681108B  | Yellow     | 12mm Ruled & Margin | Blue                 |
| EX681108CV   | Yellow     | 12mm Ruled & Margin | Cream                |
| EX681108G  | Yellow     | 12mm Ruled & Margin | Green                |
| EX681108PP   | Yellow     | 12mm Ruled & Margin | Pink                 |
| EX681339B  | Light Blue | 10mm Squares        | Blue                 |
| EX681339CV   | Light Blue | 10mm Squares        | Cream                |
| EX681339G  | Light Blue | 10mm Squares        | Green                |
| EX681339PP   | Light Blue | 10mm Squares        | Pink                 |
| EX681260B  | Red        | 10mm Squares        | Blue                 |
| EX681260CV   | Red        | 10mm Squares        | Cream                |
| EX681260G  | Red        | 10mm Squares        | Green                |
| EX681260PP   | Red        | 10mm Squares        | Pink                 |
| EX68192B   | Yellow     | 10mm Squares        | Blue                 |
| EX68192CV  | Tellow     | 10mm Squares        | Cream                |
| EX68192G   | Yellow     | 10mm Squares        | Green                |
| EX68192PP  | Yellow     | 10mm Squares        | Pink                 |

Special Educational Needs File Paper Punched  
(300mm x 210mm) Pack of 500

G

| Cream Vellum Paper 80gsm, Punched 2 Holes. |                    |       |
|--|--------------------|-------|
| ORDER CODE                                 | RULING             | PRICE |
| LL06044CV                                  | 8mm Ruled & Margin | £5.99 |

Special Educational Needs Paper  
(210mm x 297mm) Pack of 500

H

| Cream Vellum Paper 80gsm. Unpunched |  |       |
|-------------------------------------|--|-------|
| ORDER CODE                          | RULING   | PRICE |
| IQVA481                             | Plain Unruled, Ideal for Photocopying, Writing on etc. | £3.88 |

|  |  |                                  |
|--|--|----------------------------------|
| <b>A</b>   | <b>Music Books 11¾" x 9"</b><br><b>(300mm x 230mm) Pack of 4</b> | <b>48 Pages</b><br><b>£10.20</b> |
| Excellent quality 90gsm paper, fine textured cover, musical information on inside covers, wire-bound, stiff board backing. |  |                                  |
| <b>ORDER CODE</b>  | <b>COVER COLOUR</b>  | <b>DESCRIPTION</b>               |
| REMM4S   | Purple   | 12 Stave Music Ruling            |

|  |  |                                 |                  |
|--|--|---------------------------------|------------------|
| <b>B</b>   | <b>Music Books 11¾" x 9"</b><br><b>(300mm x 230mm)</b> | <b>24 Pages</b><br><b>£8.40</b> |                  |
| Excellent quality 90gsm paper, fine textured cover, musical information on inside covers, staple-bound on long edge. |  |                                 |                  |
| <b>ORDER CODE</b>  | <b>COLOUR</b>  | <b>DESCRIPTION</b>              | <b>Pack Size</b> |
| REMM4  | Purple   | 12 Stave Music Ruling           | 6                |
| MU0211   | Blue   | 12 Stave Music Ruling           | 10               |

|   |   |                                  |
|---|---|----------------------------------|
| <b>C</b>  | <b>Music Books 6" x 9"</b><br><b>(150mm x 230mm) Pack of 12</b> | <b>24 Pages</b><br><b>£10.20</b> |
| Excellent quality 90gsm paper, fine textured cover, musical information on inside covers, staple-bound on short edge. |   |                                  |
| <b>ORDER CODE</b>   | <b>COVER COLOUR</b>   | <b>DESCRIPTION</b>               |
| REMM3   | Purple  | 6 Stave Music Ruling             |

|  |   |  |
|--|---|--|
| <b>D</b>                                 | <b>Music Books 6" x 9¼"</b><br><b>(150mm x 235mm) Pack of 100</b> | <b>24 Pages</b><br><b>£35.99</b>             |
| Paper 75gsm with a 225gsm manilla cover. |   |  |
| <b>ORDER CODE</b>                        | <b>COVER COLOUR</b>   | <b>DESCRIPTION</b>                           |
| MU0017                                   | Dark Green  | 6 Stave Music                                |
| MU0020                                   | Dark Green  | 6 Stave Music with alternate pages 7mm Ruled |

|  |   |  |
|--|---|--|
| <b>E</b>   | <b>Music Books 8" x 6½"</b><br><b>(205mm x 165mm) Pack of 100</b> | <b>48 Pages</b><br><b>£21.40</b>             |
| Excellent quality 75gsm paper, musical information on inside covers, staple-bound on short edge. |   |  |
| <b>ORDER CODE</b>  | <b>COVER COLOUR</b>   | <b>DESCRIPTION</b>                           |
| MU0130   | Light Blue  | 8 Stave Music with alternate pages 8mm Ruled |

|  |   |                                 |
|--|---|---------------------------------|
| <b>F</b>                                       | <b>Aisling Music Pad 11.75" x 9.25"</b><br><b>(300mm x 230mm) Pack of 4</b> | <b>48 Pages</b><br><b>£9.78</b> |
| 12 Stave Aisling Music Pad with printed cover. |   |                                 |
| <b>ORDER CODE</b>                              | <b>COVER COLOUR</b>   | <b>DESCRIPTION</b>              |
| AMM4S  | Printed   | 12 Stave                        |



Music 8 Stave Ruling



Music 6 Stave Ruling



Spiral Bound Aisling Music Pad



Music Manuscript





Teachers Flip Charts

|  |                  |   |          |
|--|------------------|---|----------|
| <b>Rhino Flip Chart A1<br/>(594mm x 841mm)</b>       |                  | <b>40 Leaves<br/>£14.35</b>                 | <b>A</b> |
| Paper 70gsm perforated at head with a printed cover. |                  |   |          |
| <b>ORDER CODE</b>                                    | <b>Pack Size</b> | <b>DESCRIPTION</b>                          |          |
| RHFC5  | 5                | Blank with 20mm Squares printed on reverse. |          |

|   |                     |  |          |
|---|---------------------|--|----------|
| <b>Rhino Literacy Flip Chart A1<br/>(594mm x 841mm) Pack of 5</b> |                     | <b>30 Leaves<br/>£17.99</b>                | <b>B</b> |
| Paper 80gsm perforated at head - Literacy.                        |                     |  |          |
| <b>ORDER CODE</b>   | <b>COVER COLOUR</b> | <b>DESCRIPTION</b>                         |          |
| RELFC   | Red                 | Ruled with 4 sets of Learn to Write guides |          |

|   |                     |                             |          |
|---|---------------------|-----------------------------|----------|
| <b>Rhino Numeracy Flip Chart A1<br/>(594mm x 841mm) Pack of 5</b> |                     | <b>30 Leaves<br/>£17.99</b> | <b>C</b> |
| Paper 80gsm perforated at head - Numeracy.                        |                     |                             |          |
| <b>ORDER CODE</b>   | <b>COVER COLOUR</b> | <b>DESCRIPTION</b>          |          |
| RENFC   | Blue                | Ruled with 50mm squares     |          |

|  |                     |                                    |          |
|--|---------------------|------------------------------------|----------|
| <b>Rhino Music Flip Chart A1<br/>(594mm x 841mm) Pack of 5</b> |                     | <b>30 Leaves<br/>£17.99</b>        | <b>D</b> |
| Paper 80gsm perforated at head - Music.                        |                     |                                    |          |
| <b>ORDER CODE</b>  | <b>COVER COLOUR</b> | <b>DESCRIPTION</b>                 |          |
| REMFC  | Purple              | Ruled with 5 Staves and 20mm lines |          |

|  |                     |                            |
|--|---------------------|----------------------------|
| <b>Rhino Value Flip Chart A1<br/>(594mm x 841mm) Pack of 5</b> |                     | <b>40 Leaves<br/>£9.95</b> |
| Paper 60gsm.   |                     |                            |
| <b>ORDER CODE</b>  | <b>COVER COLOUR</b> | <b>DESCRIPTION</b>         |
| FCITMP   | Printed             | Plain Unruled              |



Rhino Flip Chart

| <b>A</b>  | <b>Toughback Science Books A4<br/>(300mm x 210mm) Pack of 6</b> | <b>64 Pages<br/>£7.60</b>                          |
|---|---|--|
| Tough but flexible covers. Ideal for field work or as a longer lasting exercise book. |   |  |
| ORDER CODE  | COVER COLOUR  | DESCRIPTION  |
| TBSC1BU   | Dark Blue   | 8mm Ruled & Margin alternating with 1.5.10mm Grid  |
| TBSC2Y  | Dark Blue   | 8mm Ruled & Margin alternating with 2.10.20mm Grid |

| <b>B</b>   | <b>Capital Science Books A4<br/>(300mm x 210mm) Pack of 5</b> | <b>120 Pages<br/>£12.20</b>                        |
|--|---|--|
| Premium quality Threadsewn 75gsm paper, hard-backed cover. |   |  |
| ORDER CODE   | COVER COLOUR  | DESCRIPTION  |
| C40102   | Printed   | 8mm Ruled & Margin alternating with 2.10.20mm Grid |

| <b>C</b>   | <b>Capital Science Books 9" x 7"<br/>(230mm x 180mm) Pack of 5</b> | <b>120 Pages<br/>£9.70</b>                         |
|--|--|--|
| Premium quality Threadsewn 75gsm paper, hard-backed cover. |  |  |
| ORDER CODE   | COVER COLOUR   | DESCRIPTION  |
| C40100   | Printed  | 7mm Ruled & Margin alternating with 2.10.20mm Grid |



**Toughback Science Books**



**Capital Science Books**



**FREE DELIVERY  
on orders over £50**

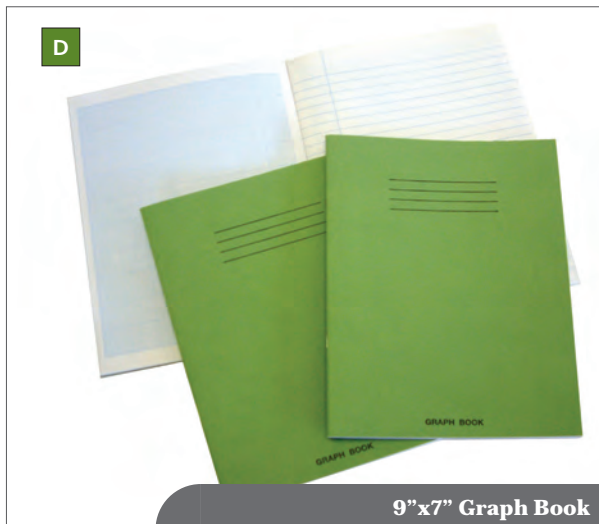

**9" x 7" Graph Book**

| Graph Books 9" x 7"<br>(230mm x 180mm) Pack of 10 |              | 32 Pages<br>£4.10                           |
|---|--------------|---|
| Paper 90gsm with a 225gsm manilla cover.          |              |   |
| ORDER CODE  | COVER COLOUR | DESCRIPTION                                 |
| GB0526  | Dark Green   | 2.10.20mm Graph Paper<br>Printed both sides |

| Graph Books 9" x 7"<br>(230mm x 180mm) Pack of 10 |              | 48 Pages<br>£4.55   |
|---|--------------|---|
| Paper 90gsm with a 225gsm manilla cover.          |              |   |
| ORDER CODE  | COVER COLOUR | DESCRIPTION   |
| GB0238  | Light Green  | 8mm R & M alternating with<br>2.10.20mm Graph Paper,<br>printed both sides. |

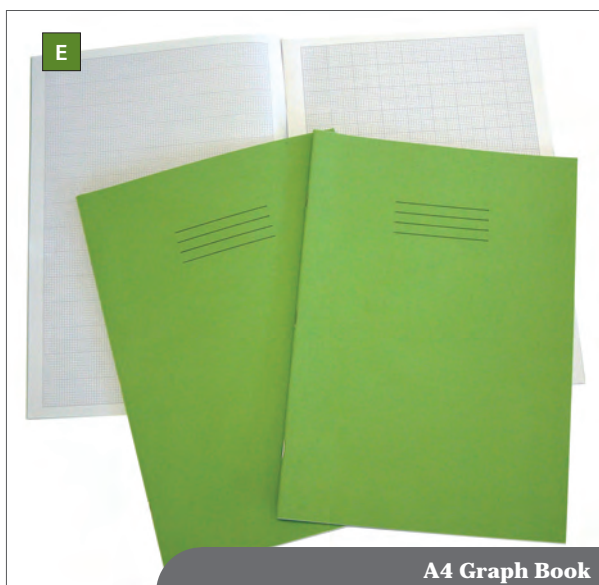

**A4 Graph Book**

| Graph Books A4<br>(300mm x 210mm) Pack of 10 |              | 32 Pages<br>£3.99                             |
|--|--------------|---|
| Paper 90gsm with a 225gsm manilla cover.     |              |   |
| ORDER CODE                                   | COVER COLOUR | DESCRIPTION                                   |
| GB062310                                     | Light Green  | 2.10.20mm Graph Paper,<br>printed both sides. |

| Summit Science Books A4<br>(300mm x 210mm) Pack of 10               |              | 80 Pages<br>£18.99   |
|---|--------------|--|
| Paper 75gsm with a glossy printed cover. Staple Bound on long edge. |              |  |
| ORDER CODE  | COVER COLOUR | DESCRIPTION  |
| 5751  | Printed      | 8mm R & M with 1.5.10mm<br>Graph Paper, printed on the<br>reverse. |

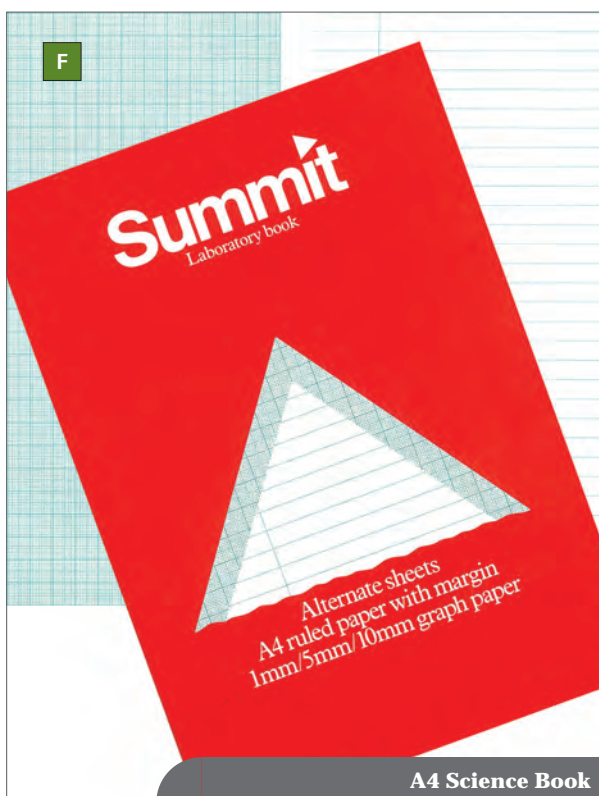

**A4 Science Book**

| Rhino Science Books A4<br>(300mm x 210mm) Pack of 10 |              | 64 Pages<br>£7.95  |
|--|--------------|--|
| Paper 75gsm with a 225gsm manilla cover.             |              |  |
| ORDER CODE   | COVER COLOUR | DESCRIPTION  |
| SDSCIBU  | Printed      | 8mm Ruled & Margin<br>alternating with 1.5.10mm<br>Graph paper   |
| SDSC2Y   | Printed      | 8mm Ruled & Margin<br>alternating with 2.10.20mm<br>Graph paper. |



**Rhino Science Books**

| Rhino Graph Pads A4 (297mm x 210mm) Pack of 6     |              |                                      | 50 Leaves<br>£4.50 |
|---|--------------|--------------------------------------|--------------------|
| Paper 75gsm, head bound and punched with 2 holes. |              |                                      |                    |
| ORDER CODE  | COVER COLOUR | DESCRIPTION                          |                    |
| A HAG1  | Green        | Graph 1.5.10mm and blank alternate.  |                    |
| B HAG2  | Grey         | Graph 2.10.20mm and blank alternate. |                    |

| Dual Grid Graph Pad A4 (300mm x 210mm) Pack of 4 |              |  | 30 Leaves<br>£9.50 |
|--|--------------|--|--------------------|
| Paper 90gsm, printed both sides.                 |              |  |                    |
| ORDER CODE                                       | COVER COLOUR | DESCRIPTION  |                    |
| RTA4G  | Rhino Tech   | Dual graph paper 1.5.10mm and 2.10.20mm alternate. |                    |

| Dual Grid Graph Pad A3 (420mm x 300mm) Pack of 2 |              |  | 30 Leaves<br>£5.70 |
|--|--------------|--|--------------------|
| Paper 90gsm, printed both sides.                 |              |  |                    |
| ORDER CODE                                       | COVER COLOUR | DESCRIPTION  |                    |
| D RTA3G  | Rhino Tech   | Dual graph paper 1.5.10mm and 2.10.20mm alternate. |                    |
| RTA3GP   | Plain        | Dual graph paper 1.5.10mm and 2.10.20mm alternate. |                    |

| Aisling Graph Pad A4 (300mm x 210mm) Pack of 5                |              |  | 16 Leaves<br>£4.40 |
|---|--------------|--|--------------------|
| Paper 90gsm, printed both sides with a Aisling printed cover. |              |  |                    |
| ORDER CODE  | COVER COLOUR | DESCRIPTION                            |                    |
| ASG1  | Printed      | 2:10:20 Graph Paper Printed Both Sides |                    |

NEW





D

Rhino Tech Pads

**CHARTA\\ Pure Tracing Paper**

63gsm Tracing paper.

| ORDER CODE | PACKED | DESCRIPTION      | PRICE  |
|------------|--------|------------------|--------|
| 361        | 500    | A4 (210 x 297mm) | £13.99 |
| TPA363-400 | 400    | A3 (297 x 420mm) | £23.99 |
| TPA363-500 | 500    | A3 (297 x 420mm) | £29.99 |
| TPA263-25  | 25     | A2 (420 x 594mm) | £3.25  |
| TPA163-25  | 25     | A1 (594 x 841mm) | £5.99  |
| TPA163BP1  | 100    | A1 (594 x 841mm) | £22.20 |

**CHARTA\\ Pure Tracing Paper**

90gsm Tracing paper.

| ORDER CODE | PACKED | DESCRIPTION      | PRICE  |
|------------|--------|------------------|--------|
| TPA49-50   | 50     | A4 (210 x 297mm) | £2.65  |
| TPA49-250  | 250    | A4 (210 x 297mm) | £10.99 |
| TPA39-200  | 200    | A3 (297 x 420mm) | £14.10 |
| TPA29-25   | 25     | A2 (420 x 594mm) | £4.50  |
| TPA19-25   | 25     | A1 (594 x 841mm) | £8.99  |
| TPA19BP1   | 100    | A1 (594 x 841mm) | £31.70 |

**CHARTA\\ Greasproof Tracing Paper**

38gsm Greasproof Tracing paper.

| ORDER CODE | PACKED | DESCRIPTION           | PRICE  |
|------------|--------|-----------------------|--------|
| 12661      | 250    | 248 x 184mm           | £1.20  |
| 812038C1   | 500    | (8 x 6.5) 203 x 165mm | £2.40  |
| 812038B1   | 500    | (9 x 7) 229 x 178mm   | £2.40  |
| TPA441     | 100    | A4 (210 x 297mm)      | £1.15  |
| GTPA4-250  | 250    | A4 (210 x 297mm)      | £1.85  |
| 321        | 500    | A4 (210 x 297mm)      | £3.30  |
| 812038A    | 25     | 500 x 700mm           | £0.99  |
| PG1        | 500    | 500 x 750mm           | £16.50 |

**Tracing Pads**

**30 Leaves**

63gsm Tracing paper pads.

| ORDER CODE | PACKED | DESCRIPTION      | PRICE  |
|------------|--------|------------------|--------|
| RTTP4      | 6      | A4 (300 x 210mm) | £10.99 |
| RTTP3      | 3      | A3 (420 x 300mm) | £9.65  |

F  
G

**Layout Pad A4 (300mm x 210mm) Pack of 4**

**50 Leaves £6.90**

Paper 50gsm, offset paper.

| ORDER CODE | COVER COLOUR | DESCRIPTION   |
|------------|--------------|---------------|
| RTLA4      | Rhino Tech   | Plain unruled |

H

**Layout Pad A3 (420mm x 300mm) Pack of 2**

**50 Leaves £4.30**

Paper 50gsm, offset paper.

| ORDER CODE | COVER COLOUR | DESCRIPTION   |
|------------|--------------|---------------|
| RTLA3      | Rhino Tech   | Plain unruled |

I

| <b>A Essential File Paper - Punched A4 (297mm x 210mm)</b> |                              | <b>5 Reams<br/>£16.80</b> |
|--|------------------------------|---------------------------|
| Paper 75gsm, punched with 2 holes.                         |                              |                           |
| ORDER CODE   | DESCRIPTION                  |                           |
| LL06015  | Plain Unruled                |                           |
| LL06007  | Plain Unruled & Margin       |                           |
| LL06031  | 6mm Ruled                    |                           |
| LL06057  | 6mm Ruled & Margin           |                           |
| LL06044  | 8mm Ruled & Margin (2 holes) |                           |
| LL06044-4  | 8mm Ruled & Margin (4 holes) |                           |
| LL06028  | 8mm Ruled                    |                           |
| LL06050  | 15mm Ruled                   |                           |
| LL06060  | 5mm Squares                  |                           |
| LL06070  | 7mm Squares                  |                           |
| LL06010  | 10mm Squares                 |                           |



**A4 Punched**

| <b>B Special Educational Needs File Paper Punched A4 (297mm x 210mm)</b> |                    | <b>Packed 500<br/>£5.99</b> |
|--|--------------------|-----------------------------|
| Paper 80gsm Cream Vellum Paper, punched with 2 holes.                    |                    |                             |
| ORDER CODE   | DESCRIPTION        |                             |
| LL06044CV  | 8mm Ruled & Margin |                             |



**Infant Punched**

| <b>C Infant Papers - Punched 8" x 6½" (203mm x 165mm)</b> |                    | <b>1 Ream<br/>£3.45</b> |
|---|--------------------|-------------------------|
| Paper 75gsm, punched with 2 holes.                        |                    |                         |
| ORDER CODE  | DESCRIPTION        |                         |
| LL03014   | Plain Unruled      |                         |
| AQ103   | 8mm Ruled          |                         |
| LL03043   | 8mm Ruled & Margin |                         |
| LL03012   | 12mm Ruled         |                         |
| LLL03060  | 5mm Squares        |                         |
| AS108   | 10mm Squares       |                         |



**Special Needs File Paper Punched**

| <b>Infant Papers - Unpunched 8" x 6½" (203mm x 165mm)</b> |                    | <b>1 Ream<br/>£3.45</b> |
|---|--------------------|-------------------------|
| Paper 75gsm.  |                    |                         |
| ORDER CODE  | DESCRIPTION        |                         |
| EP01116   | Plain Unruled      |                         |
| EP01145   | 8mm Ruled          |                         |
| EP01161   | 8mm Ruled & Margin |                         |
| EP01132   | 12mm Ruled         |                         |
| EP01105   | 5mm Squares        |                         |
| EP011100  | 10mm Squares       |                         |



A4 Unpunched

| Exercise Paper - Unpunched A4<br>(297mm x 210mm) |                        | 5 Reams<br>£16.80 |
|--|------------------------|-------------------|
| Paper 75gsm.                                     |                        |                   |
| ORDER CODE                                       | DESCRIPTION            |                   |
| EP05114  | Plain Unruled          |                   |
| D36105   | Plain Unruled & Margin |                   |
| EP05130  | 6mm Ruled              |                   |
| EP05156  | 6mm Ruled & Margin     |                   |
| EP05127  | 8mm Ruled              |                   |
| EP05143  | 8mm Ruled & Margin     |                   |
| EP05115  | 15mm Ruled             |                   |
| EP05172  | 5mm Squares            |                   |
| EP05198  | 7mm Squares            |                   |
| EP05185  | 10mm Squares           |                   |



Junior Unpunched

| Junior Papers - Punched 9" x 7"<br>(230mm x 178mm) |                    | 1 Ream<br>£3.90 |
|--|--------------------|-----------------|
| Paper 75gsm, punched with 2 holes.                 |                    |                 |
| ORDER CODE   | DESCRIPTION        |                 |
| LL04011  | Plain Unruled      |                 |
| AQ106  | 8mm Ruled          |                 |
| LL04040  | 8mm Ruled & Margin |                 |
| LL04010  | 10mm Squares       |                 |

| Junior Papers - Unpunched 9" x 7"<br>(230mm x 178mm) |                    | 1 Ream<br>£3.90 |
|--|--------------------|-----------------|
| Paper 75gsm.   |                    |                 |
| ORDER CODE   | DESCRIPTION        |                 |
| EP02113  | Plain Unruled      |                 |
| EP02126  | 8mm Ruled          |                 |
| EP02155  | 8mm Ruled & Margin |                 |
| EP02166  | 10mm Squares       |                 |



**FREE DELIVERY**  
min orders over £50



BUYING  
RHINO  
SAVES  
RHINOS



reg. charity no. 1035072

| <b>A Exam Papers - Corner Punched A4 (300mm x 210mm)</b>       |                           | <b>1 Ream<br/>£5.30</b> |
|--|---------------------------|-------------------------|
| Oxford & Cambridge. Paper 75gsm, punched with 1 hole top left. |                           |                         |
| ORDER CODE   | DESCRIPTION               |                         |
| CX0100   | 8mm Ruled & Margin        |                         |
| CX0061   | 8mm Ruled & 2 Margins     |                         |
| CX0204   | 5mm Squares               |                         |
| CX0254   | 2.10.20mm Graph Unpunched |                         |

| <b>B Graph Paper - Unpunched 9" x 7" (230mm x 178mm)</b> |   | <b>1 Ream<br/>£5.20</b> |
|--|---|-------------------------|
| Paper 75gsm, superior quality.                           |   |                         |
| ORDER CODE   | DESCRIPTION   |                         |
| GP0887   | 2.10.20mm graph printed on both sides with all round margin |                         |

| <b>C Exercise Paper A3 - Folded to A4 (420mm x 297mm)</b> |                        | <b>250 Sheets<br/>£8.40</b> |
|---|------------------------|-----------------------------|
| Paper 75gsm. Packed in handy 250 sheets.                  |                        |                             |
| ORDER CODE  | DESCRIPTION            |                             |
| EP06539   | Plain Unruled          |                             |
| D36142  | Plain Unruled & Margin |                             |
| EP06513   | 8mm Ruled              |                             |
| EP06526   | 8mm Ruled & Margin     |                             |



**Exam Papers**



**Graph Paper - Unpunched**

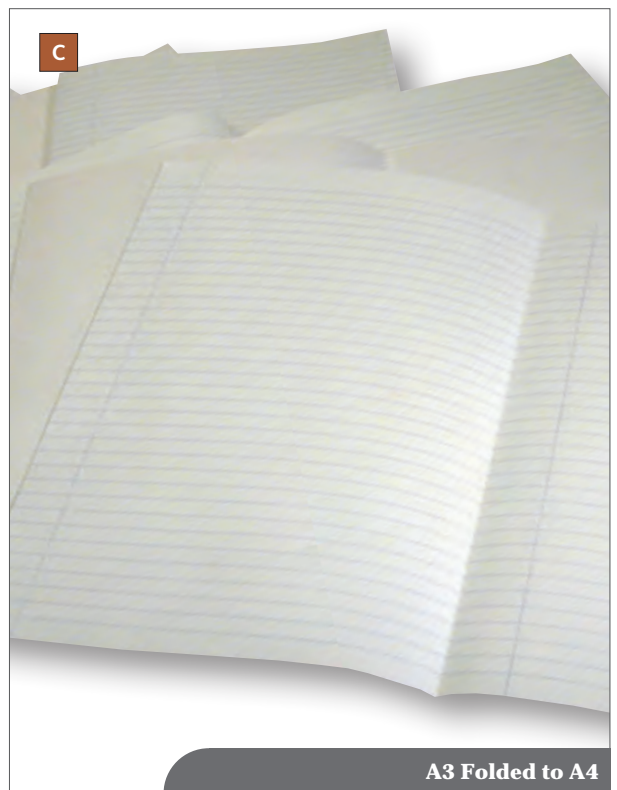

**A3 Folded to A4**



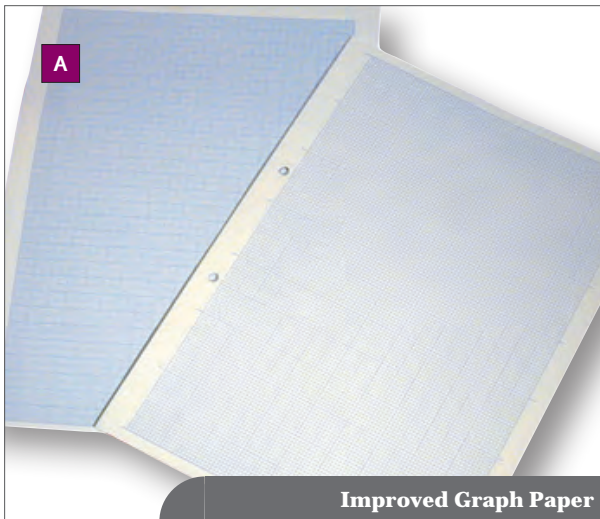

| <b>Improved Quality Graph A4<br/>(297mm x 210mm)</b>   |                                  | <b>1 Ream<br/>£4.50</b> | <b>A</b> |
|--|----------------------------------|-------------------------|----------|
| Paper 75gsm, superior quality paper, all round margin. |                                  |                         |          |
| ORDER CODE   | DESCRIPTION                      |                         |          |
| GP0890   | 2.10.20mm Grid. Unpunched.       |                         |          |
| LL0893   | 2.10.20mm Grid. Punched 2 holes. |                         |          |

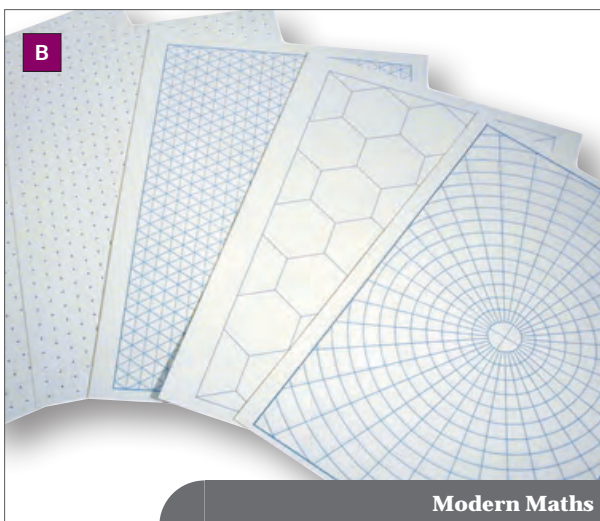

| <b>Litho Printed Graph A4<br/>(297mm x 210mm)</b>      |                                 | <b>1 Ream<br/>£4.50</b> |
|--|---------------------------------|-------------------------|
| Paper 75gsm, superior quality paper, all round margin. |                                 |                         |
| ORDER CODE   | DESCRIPTION                     |                         |
| GP0900   | 1.5.10mm Grid. Unpunched.       |                         |
| LL0903   | 1.5.10mm Grid. Punched 2 holes. |                         |

| <b>Modern Maths Paper A4<br/>(297mm x 210mm)</b>  |                             | <b>100 Sheets<br/>£3.40</b> | <b>B</b>       |
|---|-----------------------------|-----------------------------|----------------|
| Paper 75gsm, superior quality paper. Science use. |                             |                             | <b>REDUCED</b> |
| ORDER CODE  | DESCRIPTION                 |                             |                |
| GP0528  | 10mm Dot Lattice - Square   |                             |                |
| GP0926  | 10mm Dot Lattice - Triangle |                             |                |
| GP0573  | 10mm Isometric Grid         |                             |                |
| GP0531  | 25mm Hexagonal Grid         |                             |                |
| GP0544  | Polar Graph Circle at 10mm  |                             |                |

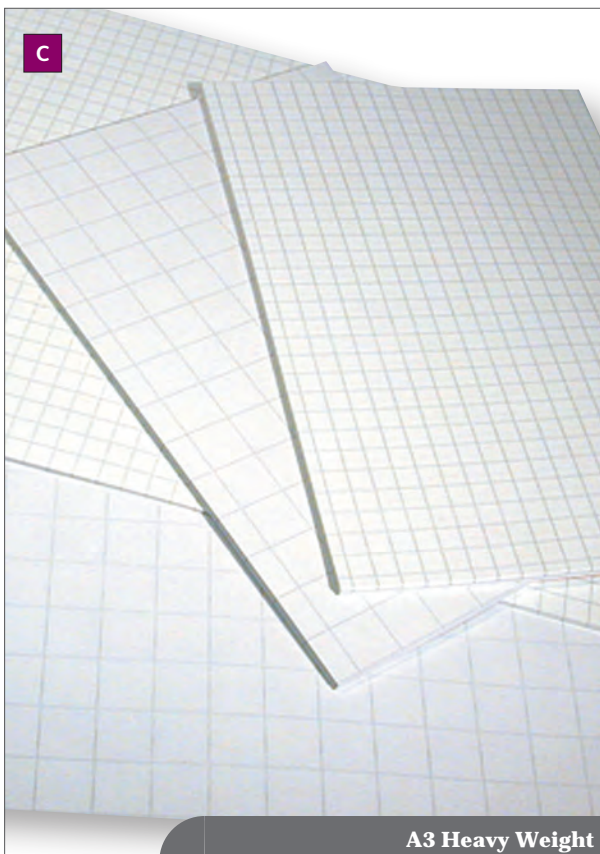

| <b>Rhino Squared Paper A4<br/>(297mm x 210mm)</b>    |              | <b>500 Sheets<br/>£8.90</b> |
|--|--------------|-----------------------------|
| Paper 75gsm, superior quality paper. Practice paper. |              |                             |
| ORDER CODE   | DESCRIPTION  |                             |
| DS08027  | 10mm Squares |                             |
| DS08030  | 20mm Squares |                             |

| <b>Rhino Large Graph Paper A3<br/>(420mm x 297mm)</b> |              | <b>100 Sheets<br/>£5.80</b> | <b>C</b> |
|---|--------------|-----------------------------|----------|
| Paper 75gsm, superior quality paper. Practice paper.  |              |                             |          |
| ORDER CODE  | DESCRIPTION  |                             |          |
| DS10017   | 10mm Squares |                             |          |
| DS10020   | 20mm Squares |                             |          |

| <b>Rhino Large Graph Paper A2<br/>(600mm x 420mm)</b> |              | <b>100 Sheets<br/>£12.50</b> |
|---|--------------|------------------------------|
| Paper 75gsm, superior quality paper. Practice paper.  |              |                              |
| ORDER CODE  | DESCRIPTION  |                              |
| AS038   | 10mm Squares |                              |
| AS044   | 20mm Squares |                              |

| <b>Rhino Graph Paper A1<br/>(600mm x 420mm)</b>      |              | <b>100 Sheets<br/>£22.50</b> |
|--|--------------|------------------------------|
| Paper 75gsm, superior quality paper. Practice paper. |              |                              |
| ORDER CODE   | DESCRIPTION  |                              |
| NT50029  | 10mm Squares |                              |
| AS046  | 20mm Squares |                              |

| Rhino Pads Head Bound A4 (297mm x 210mm) Pack of 6 |              |                    | 80 Leaves<br>£4.50 |
|--|--------------|--------------------|--------------------|
| Paper 75gsm, head bound, punched 2 holes.          |              |                    |                    |
| ORDER CODE   | COVER COLOUR | DESCRIPTION        |                    |
| A HAP  | Yellow       | Plain Unruled      |                    |
| B HANM   | Orange       | 6mm Ruled & Margin |                    |
| C HAF  | Blue         | 8mm Ruled          |                    |
| D HAFM   | Red          | 8mm Ruled & Margin |                    |
| E HAQ  | Purple       | 5mm Squares        |                    |

| Rhino Special Educational Needs Pad A4 (297mm x 210mm) NEW RANGE |              |                    | 50 Leaves<br>£5.99<br>Pack of 6 |
|--|--------------|--------------------|---------------------------------|
| Paper 75gsm, head bound, coloured paper, punched 2 holes.        |              |                    |                                 |
| ORDER CODE   | PAPER COLOUR | DESCRIPTION        |                                 |
| F HABFM  | Blue         | 8mm Ruled & Margin | NEW                             |
| HAPFM  | Pink         | 8mm Ruled & Margin | NEW                             |
| HACFM  | Cream        | 8mm Ruled & Margin | NEW                             |
| HAGFM  | Green        | 8mm Ruled & Margin | NEW                             |
| HAYFM  | Yellow       | 8mm Ruled & Margin | NEW                             |

| Rhino Spiral Pad A4 (297mm x 210mm) Pack of 6                          |              |                    | 80 Leaves<br>£7.75 |
|--|--------------|--------------------|--------------------|
| Paper 75gsm, side bound, punched 2 holes, perforated to full A4 sheet. |              |                    |                    |
| ORDER CODE   | COVER COLOUR | DESCRIPTION        |                    |
| S4S8   | Red          | 8mm Ruled & Margin |                    |

| Rhino Graph Pads A4 (297mm x 210mm) Pack of 6 |              |                                 | 50 Leaves<br>£4.50 |
|---|--------------|---------------------------------|--------------------|
| Paper 75gsm, head bound, punched 2 holes.     |              |                                 |                    |
| ORDER CODE                                    | COVER COLOUR | DESCRIPTION                     |                    |
| HAG1  | Green        | 1.5.10 Graph & Blank Alternate  |                    |
| HAG2  | Grey         | 2.10.20 Graph & Blank Alternate |                    |

| Rhino Pads A4 (297mm x 210mm) Pack of 6   |              |                    | 80 Leaves<br>£4.50 |
|---|--------------|--------------------|--------------------|
| Paper 75gsm, side bound, punched 2 holes. |              |                    |                    |
| ORDER CODE                                | COVER COLOUR | DESCRIPTION        |                    |
| G SANM                                    | Orange       | 6mm Ruled & Margin |                    |
| H SAFM                                    | Red          | 8mm Ruled & Margin |                    |

| Rhino Pads A4 (297mm x 210mm) Pack of 3   |              |                    | 160 Leaves<br>£4.50 |
|---|--------------|--------------------|---------------------|
| Paper 75gsm, side bound, punched 2 holes. |              |                    |                     |
| ORDER CODE                                | COVER COLOUR | DESCRIPTION        |                     |
| I SDNM                                    | Orange       | 6mm Ruled & Margin |                     |
| J SDFM                                    | Red          | 8mm Ruled & Margin |                     |

| Rhino Pads A5 (210mm x 150mm) Pack of 6   |              |             | 60 Leaves<br>£2.60 |
|---|--------------|-------------|--------------------|
| Paper 75gsm, head bound, punched 2 holes. |              |             |                    |
| ORDER CODE                                | COVER COLOUR | DESCRIPTION |                    |
| H5F                                       | Blue         | 8mm Ruled   |                    |



**HAP**  
Rhino Head Bound Refills



**SANM**  
Rhino Side Bound Refills



HANM

HAF

HAFM

HAQ



SAFM

SDNM

SDFM

**NEW** HABFM - Special Educational Needs  
Blue Paper Head Bound

Rhino Refill Pads

| A   |              | Precious Planet Pads A4<br>(297mm x 210mm) Pack of 10 |  | 80 Leaves<br>£5.99 |
|---|--------------|---|--|--------------------|
| Paper 60gsm, side bound, punched 2 holes. |              |   |  |                    |
| ORDER CODE                                | COVER COLOUR | DESCRIPTION   |  |                    |
| V4FM                                      | Printed      | 8mm Ruled & Margin                                    |  |                    |

| B   |              | Precious Planet Pads A4<br>(297mm x 210mm) Pack of 5 |  | 200 Leaves<br>£6.40 |
|---|--------------|--|--|---------------------|
| Paper 60gsm, side bound, punched 2 holes. |              |  |  |                     |
| ORDER CODE                                | COVER COLOUR | DESCRIPTION  |  |                     |
| V4DCFM                                    | Printed      | 8mm Ruled & Margin                                   |  |                     |
| V4DCNM                                    | Printed      | 6mm Ruled & Margin                                   |  |                     |

| C   |              | Precious Planet Pads A4<br>(297mm x 210mm) Pack of 10 |  | 80 Leaves<br>£6.20 |
|---|--------------|---|--|--------------------|
| Paper 60gsm, head bound, punched 2 holes. |              |   |  |                    |
| ORDER CODE                                | COVER COLOUR | DESCRIPTION   |  |                    |
| V4NMH                                     | Printed      | 6mm Ruled & Margin                                    |  |                    |
| V4FMH                                     | Printed      | 8mm Ruled & Margin                                    |  |                    |
| V4PH                                      | Printed      | Plain Unruled   |  |                    |

| D  |              | Precious Planet Spiral Pad A4<br>(297mm x 210mm) Pack of 3 |  | 150 Leaves<br>£9.60 |
|--|--------------|--|--|---------------------|
| Paper 60gsm, side bound, punched 2 holes, perforated to full A4 sheet. |              |  |  |                     |
| ORDER CODE   | COVER COLOUR | DESCRIPTION  |  |                     |
| V4S15  | Red          | 8mm Ruled & Margin   |  |                     |

| E   |              | Rhino Essentials Value Pad A4<br>(297mm x 210mm) Pack of 10 |  | 50 Leaves<br>£4.30 |
|---|--------------|---|--|--------------------|
| Paper 60gsm, head bound, punched 2 holes. |              |   |  |                    |
| ORDER CODE                                | COVER COLOUR | DESCRIPTION   |  |                    |
| RE4FMH                                    | Printed      | 8mm Ruled & Margin  |  |                    |

| F                        |                  | Memo Pads (no cover) |       | 80 Leaves |
|--------------------------|------------------|----------------------|-------|-----------|
| Paper 60gsm, head bound. |                  |                      |       |           |
| ORDER CODE               | SIZE & RULING    | PACK                 | PRICE |           |
| ES4P                     | A4 Plain Unruled | 10                   | £4.56 |           |
| ES4N                     | A4 6mm Ruled     | 10                   | £4.56 |           |
| ES4F                     | A4 8mm Ruled     | 10                   | £4.56 |           |
| ES5P                     | A5 Plain Unruled | 10                   | £2.80 |           |
| ES5F                     | A5 8mm Ruled     | 10                   | £2.80 |           |
| ES6P                     | A6 Plain Unruled | 20                   | £2.80 |           |

| G  |              | Legal Pad A4<br>(297mm x 210mm) Pack of 10 |  | 50 Leaves<br>£11.99 |
|--|--------------|--|--|---------------------|
| Quality yellow tinted paper, head bound. |              |  |  |                     |
| ORDER CODE                               | COVER COLOUR | DESCRIPTION                                |  |                     |
| RPY4FM                                   | None         | 8mm Ruled & Margin                         |  |                     |



Rhino Essentials Value Pad



A4 A3 A2 Heavy Weight



A4 & A5 Memo Pads



Legal Pad

Minimum order value of £50.00 ex.VAT or small order administration charge of £7.50 will apply

**A** **Rhino Notes - Polypropylene Cover**  
**200 Pages Pack of 6**

Twin wire bound, elasticated band to keep notes secure.

| ORDER CODE | SIZE & RULING   | COVER    | PRICE  |
|------------|-----------------|----------|--------|
| RNSE6      | 9"x7" 8mm Ruled | Assorted | £11.55 |
| RNSE8      | A4 8mm Ruled    | Assorted | £14.80 |
| RNSE3      | A6 7mm Ruled    | Assorted | £6.99  |

**B** **Rhino Notes - Stiff Laminated Cover**  
**100 Pages Pack of 6**

Staple bound.

| ORDER CODE | SIZE & RULING            | COVER    | PRICE |
|------------|--------------------------|----------|-------|
| RHE1       | 9"x7" 8mm Ruled & Margin | Assorted | £3.20 |
| RHE4       | A4 8mm Ruled & Margin    | Assorted | £5.15 |

**B** **Rhino Notes - Stiff Laminated Cover**  
**48 Pages Pack of 24**

Staple bound.

| ORDER CODE | SIZE & RULING    | COVER    | PRICE |
|------------|------------------|----------|-------|
| RHNB3      | 6½"x4" 7mm Ruled | Assorted | £7.20 |

**C** **Rhino Toughback Notebooks**  
**120 Pages Pack of 6**

Tough but flexible covers. Ideal for fieldwork or as a longer lasting exercise book.

| ORDER CODE | SIZE & RULING            | COVER     | PRICE |
|------------|--------------------------|-----------|-------|
| TB97       | 9"x7" 8mm Ruled & Margin | Dark Blue | £6.50 |
| TBA4       | A4 8mm Ruled & Margin    | Dark Blue | £9.65 |

**Rhino Toughback Notebooks**  
**120 Pages Pack of 12**

Tough but flexible covers. Ideal for fieldwork or as a longer lasting exercise book.

| ORDER CODE | SIZE & RULING    | COVER     | PRICE |
|------------|------------------|-----------|-------|
| TBNB       | 6½"x4" 7mm Ruled | Dark Blue | £4.99 |

**Rhino Toughback Science books**  
**64 Pages Pack of 6**

Tough but flexible covers. Ideal for fieldwork or as a longer lasting exercise book.

| ORDER CODE | SIZE & RULING                                     | COVER     | PRICE |
|------------|---|-----------|-------|
| TBSCIBU    | A4 8mm Ruled & Margin<br>alternating 1.5.10 Grid  | Dark Blue | £7.60 |
| TBSC2Y     | A4 8mm Ruled & Margin<br>alternating 2.10.20 Grid | Dark Blue | £7.60 |



Rhino Notes Twinwire



Rhino Notes Staple Bound



Rhino Toughback Notebooks



BUYING  
RHINO  
SAVES  
RHINOS



reg. charity no. 1035072



**Shorthand Notepads**

| Rhino Precious Planet College Pads <span style="float: right;">D</span>          |                       |         |       |
|--|-----------------------|---------|-------|
| 70 Leaves Pack of 10   |                       |         |       |
| 70gsm paper, spiral bound, punched 2 holes. Perforated to a full A4 or A5 sheet. |                       |         |       |
| ORDER CODE   | SIZE & RULING         | COVER   | PRICE |
| RCPA4  | A4 8mm Ruled & Margin | Printed | £7.50 |
| RCPA5  | A5 8mm Ruled & Margin | Printed | £5.50 |

| Rhino Precious Planet Spiral Bound Pad 8" x 5" <span style="float: right;">E</span> |              |             |       |
|---|--------------|-------------|-------|
| (203mm x 125mm) Pack of 12  |              |             |       |
| Printed covers. 60 Leaves.  |              |             |       |
| ORDER CODE  | COVER COLOUR | DESCRIPTION | PRICE |
| VRN6  | Printed      | 8mm Ruled   | £2.99 |



**Precious Planet Shorthand Notepads**

| Rhino Shorthand Pad 8" x 5" <span style="float: right;">F</span> |              |             |       |
|--|--------------|-------------|-------|
| (203mm x 125mm) Pack of 10                                       |              |             |       |
| Paper 75gsm, spiral bound at the top. 80 Leaves.                 |              |             |       |
| ORDER CODE   | COVER COLOUR | DESCRIPTION | PRICE |
| RHRN8  | Printed      | 8mm Ruled   | £2.40 |

| Rhino Recycled Shorthand Pad 8" x 5" <span style="float: right;">F</span> |              |             |       |
|---|--------------|-------------|-------|
| (203mm x 125mm) Pack of 10  |              |             |       |
| Paper 80gsm, spiral bound at the top. 80 Leaves.                          |              |             |       |
| ORDER CODE  | COVER COLOUR | DESCRIPTION | PRICE |
| SRN8  | Printed      | 8mm Ruled   | £3.25 |

| Rhino Spiral Bound Pad 8" x 5" <span style="float: right;">F</span> |              |             |       |
|---|--------------|-------------|-------|
| (203mm x 125mm) Pack of 5   |              |             |       |
| Paper 75gsm, spiral bound at the top. 150 Leaves.                   |              |             |       |
| ORDER CODE  | COVER COLOUR | DESCRIPTION | PRICE |
| RHRN15  | Printed      | 8mm Ruled   | £2.25 |



**Precious Planet College Pads**

Minimum order value of £50.00 ex.VAT or small order administration charge of £7.50 will apply

## Save the Rhino Refill Pads A4 (297mm x 210mm) Pack of 5

75gsm 100% recycled paper. Head Bound. 80 Leaves.

| ORDER CODE | COVER COLOUR | DESCRIPTION        | PRICE |
|------------|--------------|--------------------|-------|
| A RH4FMR   | Natural      | 8mm Ruled & Margin | £4.99 |

## Save the Rhino Refill Pads A4 (297mm x 210mm) Pack of 3

75gsm 100% recycled paper. Head Bound. 160 Leaves.

| ORDER CODE | COVER COLOUR | DESCRIPTION        | PRICE |
|------------|--------------|--------------------|-------|
| B RHDFMR   | Natural      | 8mm Ruled & Margin | £4.99 |

## Save the Rhino Notebook A4 (297mm x 210mm) Pack of 5

75gsm 100% recycled paper. Spiral bound. Perforated. 80 Leaves.

| ORDER CODE | COVER COLOUR | DESCRIPTION        | PRICE |
|------------|--------------|--------------------|-------|
| C SRS4S8   | Natural      | 8mm Ruled & Margin | £8.10 |

## Save the Rhino Notebook 9" x 7" (230mm x 178mm) Pack of 6

75gsm 100% recycled paper. Spiral bound. 80 Leaves.

| ORDER CODE | COVER COLOUR | DESCRIPTION | PRICE |
|------------|--------------|-------------|-------|
| D SRSE6    | Natural      | 8mm Ruled   | £7.50 |

## Save the Rhino Notebook A6 (150mm x 105mm) Pack of 6

75gsm 100% recycled paper. Spiral bound. 100 Leaves.

| ORDER CODE | COVER COLOUR | DESCRIPTION | PRICE |
|------------|--------------|-------------|-------|
| E SRSE3    | Natural      | 7mm Ruled   | £4.30 |

## Save the Rhino Shorthand 8" x 5" (203mm x 127mm) Pack of 10

75gsm 100% recycled paper. Spiral bound. 80 Leaves.

| ORDER CODE | COVER COLOUR | DESCRIPTION | PRICE |
|------------|--------------|-------------|-------|
| F SRN8     | Natural      | 8mm Ruled   | £3.25 |

## Save the Rhino Casebound 9" x 7" (230mm x 178mm) Pack of 5

75gsm 100% recycled paper. Casebound, hard backed. 160 Pages.

| ORDER CODE | COVER COLOUR | DESCRIPTION | PRICE |
|------------|--------------|-------------|-------|
| SRCB97     | Natural      | 8mm Ruled   | £5.99 |

## Save the Rhino Casebound A4 (300mm x 210mm) Pack of 5

75gsm 100% recycled paper. Casebound, hard backed. 160 Pages.

| ORDER CODE | COVER COLOUR | DESCRIPTION | PRICE  |
|------------|--------------|-------------|--------|
| SRCA4      | Natural      | 8mm Ruled   | £12.70 |

## Rhino Recycled Exercise Books A4 (300mm x 210mm) Pack of 10 **REDUCED**

80gsm 100% recycled paper. 64 Pages.

| ORDER CODE | COVER COLOUR | DESCRIPTION        | PRICE |
|------------|--------------|--------------------|-------|
| G RE4R     | Printed      | 8mm Ruled & Margin | £6.80 |

## Save the Rhino Twinwire A4 (300mm x 210mm) Pack of 5

75gsm 100% recycled paper. Twinwire, hard backed. 160 Pages.

| ORDER CODE | COVER COLOUR | DESCRIPTION | PRICE  |
|------------|--------------|-------------|--------|
| SRTWA4     | Natural      | 8mm Ruled   | £13.99 |

## Save the Rhino Twinwire A5 (210mm x 150mm) Pack of 5

75gsm 100% recycled paper. Twinwire, hard backed. 160 Pages

| ORDER CODE | COVER COLOUR | DESCRIPTION | PRICE |
|------------|--------------|-------------|-------|
| SRTWA5     | Natural      | 8mm Ruled   | £9.99 |







Recycled Notepads

Minimum order value of £50.00 ex.VAT or small order administration charge of £7.50 will apply

| A <b>Rhino Casebound Books</b><br>192 Pages Pack of 5                                      |                 |           |        |
|--|-----------------|-----------|--------|
| Premium quality 70gsm paper, hard backed cover and built in ribbon for bookmarking a page. |                 |           |        |
| ORDER CODE   | SIZE & RULING   | COVER     | PRICE  |
| RCB97B   | 9"x7" 8mm Ruled | Dark Blue | £9.40  |
| RCBA4B   | A4 8mm Ruled    | Dark Blue | £12.45 |
| RCBA5B   | A5 8mm Ruled    | Dark Blue | £7.20  |
| RCBA6B   | A6 8mm Ruled    | Dark Blue | £5.40  |

| B <b>Rhino Twinwire Books</b><br>160 Pages Pack of 5                    |                 |           |        |
|---|-----------------|-----------|--------|
| Premium quality 70gsm paper, hard backed cover and twinwire side bound. |                 |           |        |
| ORDER CODE  | SIZE & RULING   | COVER     | PRICE  |
| RTW97B  | 9"x7" 8mm Ruled | Dark Blue | £9.99  |
| RTWA4B  | A4 8mm Ruled    | Dark Blue | £13.70 |
| RTWA5B  | A5 8mm Ruled    | Dark Blue | £8.80  |
| RTWA6B  | A6 8mm Ruled    | Dark Blue | £5.85  |

| <b>Rhino Value Twinwire Books</b><br>100 Pages Pack of 10        |                       |        |       |
|--|-----------------------|--------|-------|
| 60gsm paper, hard backed polypropylene cover and twinwire bound. |                       |        |       |
| ORDER CODE   | SIZE & RULING         | COVER  | PRICE |
| REA4   | A4 8mm Ruled & Margin | Blue   | £4.99 |
| REA5   | A5 8mm Ruled & Margin | Yellow | £2.85 |

| C <b>Rhino Recycled Notebooks</b><br>160 Pages Pack of 5 |                 |         |        |
|--|-----------------|---------|--------|
| Save the Rhino, 100% recycled 80gsm paper, hard backed.  |                 |         |        |
| ORDER CODE   | SIZE & RULING   | COVER   | PRICE  |
| SRCB97   | 9"x7" 8mm Ruled | Natural | £5.99  |
| SRCBA4   | A4 8mm Ruled    | Natural | £12.70 |

| <b>Rhino Recycled Twinwire Notebooks</b><br>160 Pages Pack of 5   |               |           |        |
|---|---------------|-----------|--------|
| Save the Rhino, 100% recycled 80gsm paper, hard backed, twinwire. |               |           |        |
| ORDER CODE  | SIZE & RULING | COVER     | PRICE  |
| SRTWA4  | A4 8mm Ruled  | Dark Blue | £13.99 |
| SRTWA5  | A5 8mm Ruled  | Dark Blue | £9.99  |

| <b>Capital Casebound Books</b><br>120 Pages Pack of 5      |                       |         |       |
|--|-----------------------|---------|-------|
| Premium quality Threadsewn 75gsm paper, hard-backed cover. |                       |         |       |
| ORDER CODE   | SIZE & RULING         | COVER   | PRICE |
| C40104   | 9"x7" 8mm Ruled & M   | Printed | £6.50 |
| C40106   | A4 8mm Ruled & Margin | Printed | £8.55 |



Rhino Casebound Notebooks



Rhino Twinwire Notebooks



**Rhino Recycled Notebook**

| Capital Casebound Books A4 (300mm x 210mm) Pack of 3       |              |                    |       |
|--|--------------|--------------------|-------|
| Premium quality Threadsewn 75gsm paper, hard backed cover. |              |                    |       |
| ORDER CODE   | COVER COLOUR | DESCRIPTION        | PRICE |
| C40108   | Printed      | 8mm Ruled & Margin | £6.60 |

| Capital Science Books 120 Pages Pack of 5                  |  |         |        |
|--|--|---------|--------|
| Premium quality Threadsewn 75gsm paper, hard backed cover. |  |         |        |
| ORDER CODE   | SIZE & RULING  | COVER   | PRICE  |
| C40100   | 9"x7" 7mm Ruled & Margin alternating with 2.10.20 Grid | Printed | £9.70  |
| C40102   | A4 8mm Ruled & Margin alternating with 2.10.20 Grid    | Printed | £12.20 |

| Value Casebound Books 192 Pages Pack of 5       |                 |          |       |
|---|-----------------|----------|-------|
| Premium quality 60gsm paper, hard backed cover. |                 |          |       |
| ORDER CODE                                      | SIZE & RULING   | COVER    | PRICE |
| C40307  | 9"x7" 8mm Ruled | Assorted | £6.55 |
| C40301  | A4 8mm Ruled    | Assorted | £8.80 |
| C40303  | A5 8mm Ruled    | Assorted | £5.40 |
| C40305  | A6 8mm Ruled    | Assorted | £3.75 |



**Capital Casebound Books**

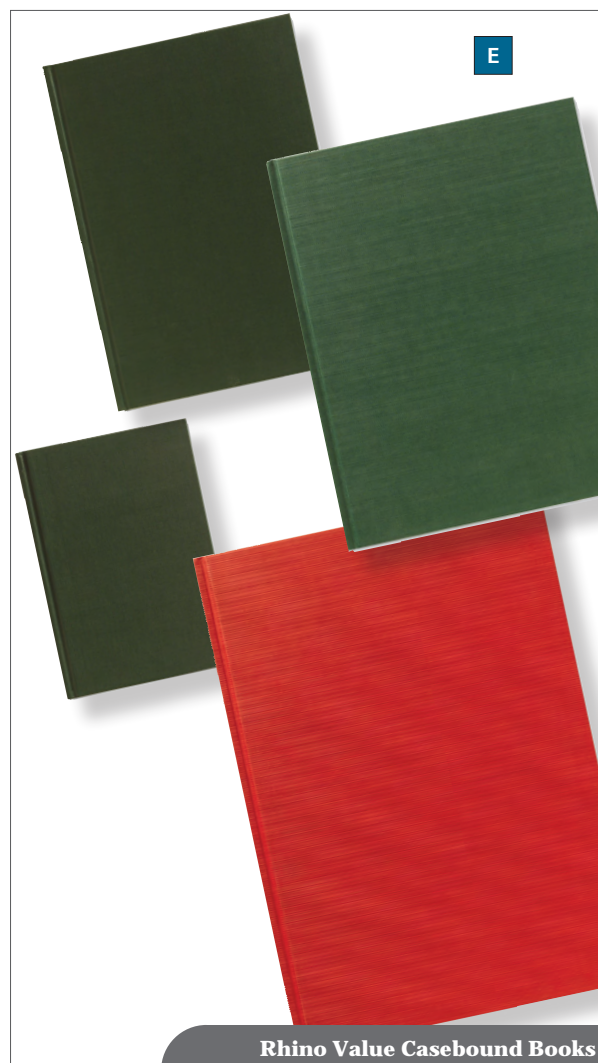

**Rhino Value Casebound Books**

Minimum order value of £50.00 ex.VAT or small order administration charge of £7.50 will apply

| A Rhino Tape Bound Sketch Pads<br>20 Leaves                      |                  |      |       |
|--|------------------|------|-------|
| Superior quality 150gsm acid free drawing cartridge. Head Bound. |                  |      |       |
| ORDER CODE   | DESCRIPTION      | PACK | PRICE |
| RASP4  | A4 Printed Cover | 6    | £8.99 |
| RASP3  | A3 Printed Cover | 4    | £8.60 |
| RASP2  | A2 Plain Cover   | 1    | £4.40 |

| Rhino Spiral Bound Sketch Pads<br>30 Leaves                      |                  |      |        |
|--|------------------|------|--------|
| Superior quality 135gsm acid free drawing cartridge. Head bound. |                  |      |        |
| ORDER CODE   | DESCRIPTION      | PACK | PRICE  |
| RASP4S30   | A4 Printed Cover | 6    | £14.20 |

| B Sketch Book Portrait A4<br>(300mm x 210mm) Pack of 50  |              |                         |        |
|--|--------------|-------------------------|--------|
| Superior 100gsm 'all medium' cartridge paper. 300 micron soft plain cover. 4 staple bound. 40 Pages. |              |                         |        |
| ORDER CODE   | COVER COLOUR | DESCRIPTION             | PRICE  |
| SB-PA4PBK  | Black        | For all types of medium | £32.10 |
| SB-PA4PR   | Red          | For all types of medium | £32.10 |
| SB-PA4PB   | Blue         | For all types of medium | £32.10 |
| SB-PA4PG   | Green        | For all types of medium | £32.10 |

| Sketch Book Portrait A3<br>(420mm x 300mm) Pack of 50  |              |                         |        |
|--|--------------|-------------------------|--------|
| Superior 100gsm 'all medium' cartridge paper. 300 micron soft plain cover. 4 staple bound. 40 Pages. |              |                         |        |
| ORDER CODE   | COVER COLOUR | DESCRIPTION             | PRICE  |
| SB-PA3PBK  | Black        | For all types of medium | £71.70 |
| SB-PA3PR   | Red          | For all types of medium | £71.70 |
| SB-PA3PB   | Blue         | For all types of medium | £71.70 |
| SB-PA3PG   | Green        | For all types of medium | £71.70 |

| Sketch Book Landscape A5<br>(150mm x 210mm) Pack of 50                                     |              |                         |        |
|--|--------------|-------------------------|--------|
| Superior 100gsm 'all medium' paper. 300 micron soft plain cover. 2 staple bound. 40 Pages. |              |                         |        |
| ORDER CODE   | COVER COLOUR | DESCRIPTION             | PRICE  |
| SB-PA5LBK  | Black        | For all types of medium | £16.75 |
| SB-PA5LR   | Red          | For all types of medium | £16.75 |
| SB-PA5LB   | Blue         | For all types of medium | £16.75 |
| SB-PA5LG   | Green        | For all types of medium | £16.75 |

| Sketch Book Landscape A4<br>(210mm x 300mm) Pack of 50                                     |              |                         |        |
|--|--------------|-------------------------|--------|
| Superior 100gsm 'all medium' paper. 300 micron soft plain cover. 2 staple bound. 40 Pages. |              |                         |        |
| ORDER CODE   | COVER COLOUR | DESCRIPTION             | PRICE  |
| SB-PA4LBK  | Black        | For all types of medium | £33.50 |
| SB-PA4LR   | Red          | For all types of medium | £33.50 |
| SB-PA4LB   | Blue         | For all types of medium | £33.50 |
| SB-PA4LG   | Green        | For all types of medium | £33.50 |



Rhino Sketch Pad

| C Premium Sketch Book Portrait A4<br>(300mm x 210mm) Pack of 40                                 |              |                         |        |
|---|--------------|-------------------------|--------|
| Superior 140gsm 'all medium' paper. 380 micron laminated plain cover. 4 staple bound. 40 Pages. |              |                         |        |
| ORDER CODE  | COVER COLOUR | DESCRIPTION             | PRICE  |
| SB-LA4PBK   | Black        | For all types of medium | £29.30 |
| SB-LA4PR  | Red          | For all types of medium | £29.30 |
| SB-LA4PB  | Blue         | For all types of medium | £29.30 |
| SB-LA4PG  | Green        | For all types of medium | £29.30 |

| Premium Sketch Book Portrait A3<br>(420mm x 300mm) Pack of 20                                   |              |                         |        |
|---|--------------|-------------------------|--------|
| Superior 140gsm 'all medium' paper. 380 micron laminated plain cover. 4 staple bound. 40 Pages. |              |                         |        |
| ORDER CODE  | COVER COLOUR | DESCRIPTION             | PRICE  |
| SB-LA3PBK   | Black        | For all types of medium | £31.10 |
| SB-LA3PR  | Red          | For all types of medium | £31.10 |
| SB-LA3PB  | Blue         | For all types of medium | £31.10 |
| SB-LA3PG  | Green        | For all types of medium | £31.10 |



Sketch Books Portrait

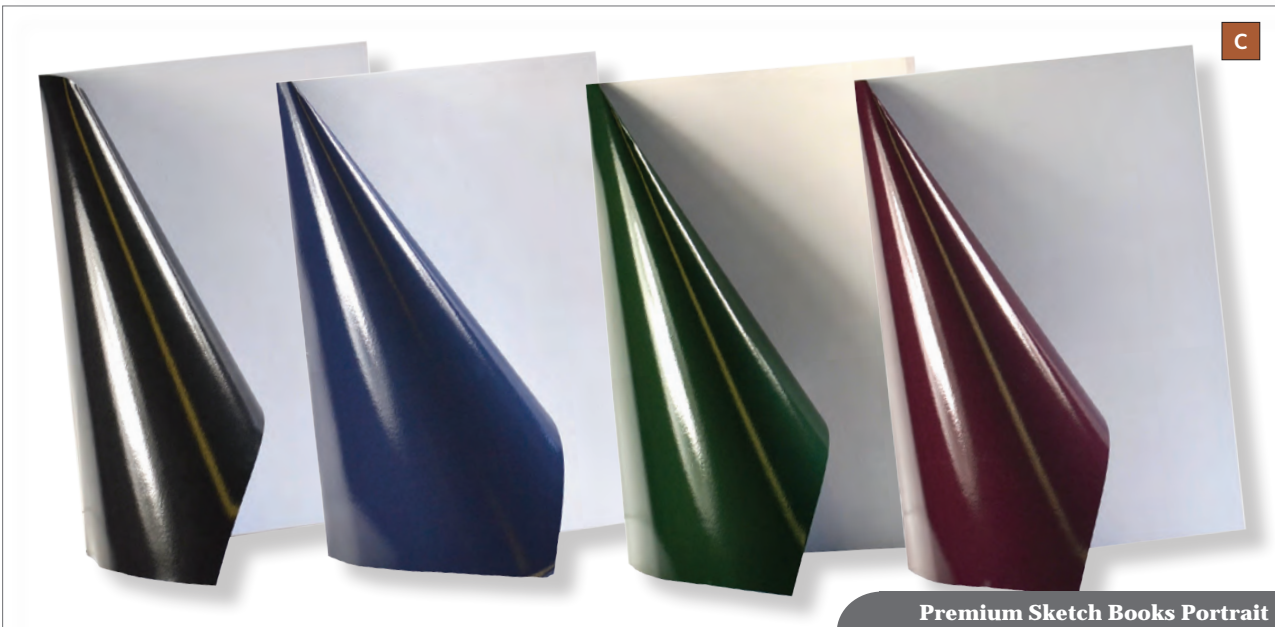

Premium Sketch Books Portrait

| Premium Sketch Book Landscape A5<br>(150mm x 210mm) Pack of 40                                  |              |                         |        |
|---|--------------|-------------------------|--------|
| Superior 140gsm 'all medium' paper. 380 micron laminated plain cover. 2 staple bound. 40 Pages. |              |                         |        |
| ORDER CODE  | COVER COLOUR | DESCRIPTION             | PRICE  |
| SB-LA5LBK   | Black        | For all types of medium | £16.70 |
| SB-LA5LR  | Red          | For all types of medium | £16.70 |
| SB-LA5LB  | Blue         | For all types of medium | £16.70 |
| SB-LA5LG  | Green        | For all types of medium | £16.70 |

| Premium Sketch Book Landscape A4<br>(210mm x 300mm) Pack of 40                                  |              |                         |        |
|---|--------------|-------------------------|--------|
| Superior 140gsm 'all medium' paper. 380 micron laminated plain cover. 2 staple bound. 40 Pages. |              |                         |        |
| ORDER CODE  | COVER COLOUR | DESCRIPTION             | PRICE  |
| SB-LA4LBK   | Black        | For all types of medium | £33.99 |
| SB-LA4LR  | Red          | For all types of medium | £33.99 |
| SB-LA4LB  | Blue         | For all types of medium | £33.99 |
| SB-LA4LG  | Green        | For all types of medium | £33.99 |

| A4 Exercise Drawing Book<br>(300mm x 210mm) Pack of 100 |              |                 |        |
|---|--------------|-----------------|--------|
| Paper 90gsm with a 225gsm manilla cover. 40 Pages.      |              |                 |        |
| ORDER CODE  | COVER COLOUR | DESCRIPTION     | PRICE  |
| DB04726   | Light Blue   | Plain Cartridge | £45.04 |
| DB04739   | Red          | Plain Cartridge | £45.04 |
| DB04742   | Yellow       | Plain Cartridge | £45.04 |

Minimum order value of £50.00 ex.VAT or small order administration charge of £7.50 will apply

**A**

**3D Spiral Bound Sketch Books**  
70 Pages White Cartridge

Superior quality 140gsm 'all medium' . Hard backed cover with large diameter spiral allowing for items to be mounted onto the pages. Plain covers for students own personalisation.

| ORDER CODE | DESCRIPTION  | PACK | PRICE |
|------------|--------------|------|-------|
| SB-3DA4W   | A4 Landscape | 1    | £2.85 |
| SB-3DA3W   | A3 Landscape | 1    | £4.40 |

**B**

**3D Spiral Bound Sketch Books**  
70 Pages Black Card

230gsm black card. Hard backed cover with large diameter spiral allowing for items to be mounted onto the pages. Plain covers for students own personalisation.

| ORDER CODE | DESCRIPTION   | PACK | PRICE |
|------------|---------------|------|-------|
| SB-3DA4BK  | A4 Landscape  | 1    | £3.86 |
| SB-3DA3BK  | A3+ Landscape | 1    | £7.40 |



**C**

**Hard Backed Sketch Books**  
96 Pages Black Cover

Superior quality 140gsm 'all medium' . Hard backed linen covered cover, hand made.

| ORDER CODE | DESCRIPTION  | PACK | PRICE |
|------------|--------------|------|-------|
| SB-HBA4PBK | A4 Portrait  | 1    | £2.70 |
| SB-HBA3PBK | A3 Portrait  | 1    | £6.20 |
| SB-HBA5PBK | A5 Portrait  | 1    | £2.40 |
| SB-HBA4LBK | A4 Landscape | 1    | £3.30 |

**D**

**Polyfile Portfolios**  
Clear Polypropylene

Larger than stated size to accommodate artwork. Black plastic carry handle, stiff card inserts.

| ORDER CODE | DESCRIPTION | PACK | PRICE  |
|------------|-------------|------|--------|
| PF-A1      | A1 Artwork  | 10   | £39.99 |
| PF-A2      | A2 Artwork  | 10   | £29.99 |
| PF-A3      | A3 Artwork  | 10   | £19.99 |

**E**

**Transfile Portfolios**  
Clear Polypropylene Hook & Loop Fastening

Larger than stated size to accommodate artwork. Black plastic carry handle, stiff card inserts. Fold over flap to make the folder waterproof, with hook & loop fastening.

| ORDER CODE | DESCRIPTION | PACK | PRICE  |
|------------|-------------|------|--------|
| TF-A1      | A1 Artwork  | 10   | £49.99 |
| TF-A2      | A2 Artwork  | 10   | £39.99 |
| TF-A3      | A3 Artwork  | 10   | £29.99 |



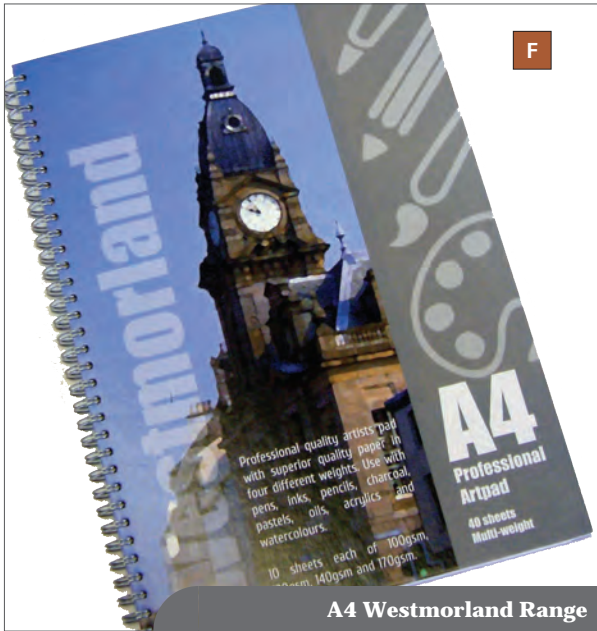

A4 Westmorland Range

| Westmorland Spiral Bound Sketch Books <span style="float: right;">F</span>   |             |      |       |
|--|-------------|------|-------|
| 80 Pages Multi-weight Paper  |             |      |       |
| Each book contains 10 sheets each of 100gsm, 120gsm, 140gsm and 170gsm 'all medium' paper with dividers. Easy tear our perforations to full A4 size. |             |      |       |
| ORDER CODE   | DESCRIPTION | PACK | PRICE |
| SB-WA4AS   | A4 Portrait | 1    | £3.99 |

| Westmorland Spiral Bound Sketch Books <span style="float: right;">G</span> |             |      |       |
|--|-------------|------|-------|
| 70 Pages   |             |      |       |
| Superior 140gsm 'all medium' paper.  |             |      |       |
| ORDER CODE   | DESCRIPTION | PACK | PRICE |
| SB-WA4P  | A4 Portrait | 1    | £2.70 |
| SB-WA3P  | A3 Portrait | 1    | £4.12 |

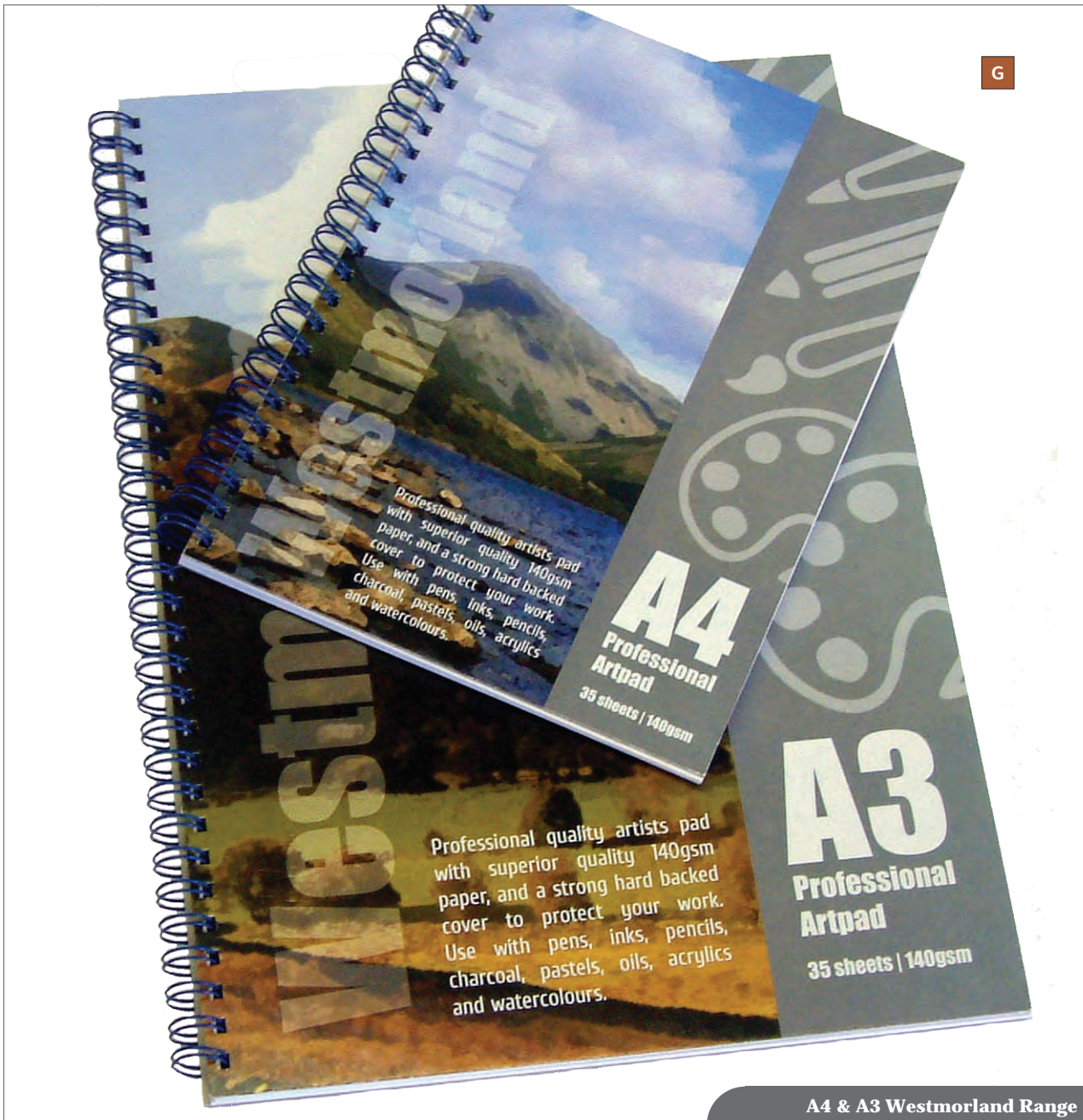

A4 & A3 Westmorland Range

Minimum order value of £50.00 ex.VAT or small order administration charge of £7.50 will apply

## Dinner Money Envelopes

Recycled = R Self Seal = S/S Peel & Seal = P/S.

| ORDER CODE      | DESCRIPTION                                    | PACK | PRICE  |
|-----------------|--|------|--------|
| <b>A</b> 119970 | 98x67, Gummed Flap, Buff Manilla, Plain, 80gsm | 1000 | £12.60 |
| <b>B</b> 13922  | 108x102mm, S/S, Buff Manilla, Plain, 80gsm     | 1000 | £13.80 |

## Plain Manilla Envelopes 100% Recycled 89 x 152mm

Recycled = R Self Seal = S/S Peel & Seal = P/S.  
Diamond Gummed Flap, Plain Envelope.

| ORDER CODE | DESCRIPTION            | PACK | PRICE |
|------------|------------------------|------|-------|
| 13770      | R, Wallet, Gummed Flap | 1000 | £8.15 |

## Plain & Window Envelopes DL 110 x 220mm

Recycled = R Self Seal = S/S Peel & Seal = P/S.  
DL size takes an A4 sheet folded twice, Buff Manilla 100% Recycled 80gsm and White Cartridge 80gsm and 100gsm.

| ORDER CODE | DESCRIPTION                         | PACK | PRICE  |
|------------|-------------------------------------|------|--------|
| 118821     | R, S/S, Buff Manilla, Plain, 80gsm  | 1000 | £12.90 |
| 118841     | R, S/S, Buff Manilla, Window, 80gsm | 1000 | £13.95 |
| FL2882     | S/S, White, Plain, 80gsm            | 1000 | £8.75  |
| FL2884     | S/S, White, Window, 80gsm           | 1000 | £9.75  |

## Plain & Window Envelopes C5 162 x 229mm

Recycled = R Self Seal = S/S Peel & Seal = P/S.  
C5 size takes an A4 sheet folded once, Buff Manilla 100% Recycled 80gsm and White Cartridge 90gsm and 100gsm.

| ORDER CODE | DESCRIPTION                        | PACK | PRICE |
|------------|------------------------------------|------|-------|
| 13885      | R, S/S, Buff Manilla, Plain, 80gsm | 500  | £8.20 |
| FL3893     | S/S, White, Plain, 90gsm           | 500  | £7.80 |
| FL2084     | S/S, White, Window, 90gsm          | 500  | £8.25 |

## Plain & Window Envelopes C4 229 x 324mm

Recycled = R Self Seal = S/S Peel & Seal = P/S.  
C4 sized envelopes self seal.

| ORDER CODE | DESCRIPTION                     | PACK | PRICE |
|------------|---------------------------------|------|-------|
| 13878      | S/S, Buff Manilla, Plain, 90gsm | 250  | £7.55 |
| FL2891     | S/S, White, Plain, 90gsm        | 250  | £7.20 |
| FL2892     | S/S, White, Window, 100gsm      | 250  | £7.50 |



Small Envelopes



DL Envelopes



C5 Envelopes



C4 Envelopes





F

**C6 Envelopes**

| White Cartridge Envelope C6<br>114 x 162mm   |                          |      |        |
|--|--------------------------|------|--------|
| Recycled = R Self Seal = S/S Peel & Seal = P/S.<br>C6 size takes an A4 folded in 4 (quartered) of an A5 sheet folded once. |                          |      |        |
| ORDER CODE   | DESCRIPTION              | PACK | PRICE  |
| 2602   | S/S, White, Plain, 90gsm | 1000 | £12.05 |

F

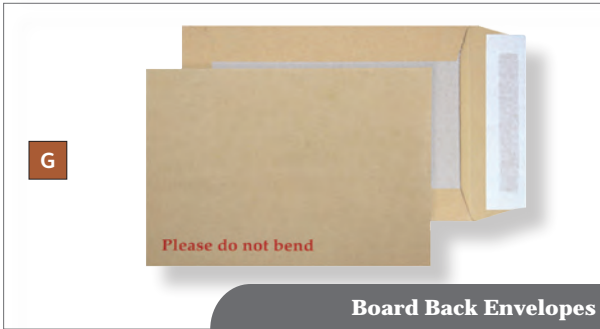

G

**Board Back Envelopes**

| Manilla Board Backed Envelope C4<br>229 x 324mm   |                  |      |        |
|---|------------------|------|--------|
| Recycled = R Self Seal = S/S Peel & Seal = P/S.<br>Heavy weight Manilla with a stiff board back, printed on face.<br>"Please do not bend" |                  |      |        |
| ORDER CODE  | DESCRIPTION      | PACK | PRICE  |
| 13935   | P/S, C4, Manilla | 125  | £14.99 |

G

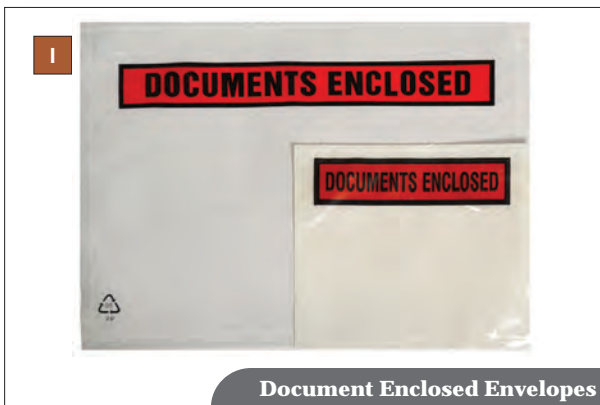

I

**Document Enclosed Envelopes**

| Gusset Envelopes in C4 & 15" x 10"<br>381 x 254  |                                    |      |        |
|--|------------------------------------|------|--------|
| Recycled = R Self Seal = S/S Peel & Seal = P/S.<br>Heavy Weight C4 130gsm and 15 x 10" 140gsm Mainilla with side gussets to allow for bulky items to be inserted, both envelopes with Peel & Seal flaps. |                                    |      |        |
| ORDER CODE   | DESCRIPTION                        | PACK | PRICE  |
| 1991   | P/S, C4, Plain, Manilla, 130gsm    | 125  | £15.85 |
| E1911101   | P/S, 15x10, Plain, Manilla, 140gsm | 125  | £17.00 |

H

| Document Enclosed Envelopes   |                  |      |        |
|---|------------------|------|--------|
| Self Adhesive pockets for use on packaging materials, easy to apply with self adhesive backing. |                  |      |        |
| ORDER CODE  | DESCRIPTION      | PACK | PRICE  |
| DOCA7   | 92 x 115mm (C7)  | 1000 | £10.65 |
| DOCA5   | 162 x 229mm (C5) | 1000 | £33.92 |

I



H

**Gusset Envelopes**

# Wide Format Printing Service

Grosvenor House Papers now offer a wide format print service for Photographs, Posters, Canvas, Banners and roll-up banners for indoor and outdoor use. With a wide variety of media for many different purposes Grosvenor House Papers can provide for all your schools printing needs.

For best results we require high quality digital photo in any of the popular formats used in digital cameras and high quality mobile phones. Ideally images should be at least 1600 x 1000 pixels for posters up to A2 and larger for A1.

We can accept images on a disk, memory stick, on a shared cloud folder (e.g. Dropbox), or by email. Please be aware that some email programs may automatically reduce the size/quality of images when sending by email.

The posters will be printed on the Canon imagePROGRAF units shown below which provide superior quality prints on all media.

If you would like any further information on our print services or you are interested in purchasing a Wide Format Printer for your School or Organisation please call our customer services team.

| 2015 | M | T | W | T | F | S | S | M | T | W  | T  | F  | S  | S  | M  | T  | W  | T  | F  | S  | S  | M  | T  | W  | T  | F  | S  | S  | M  | T  |    |    |    |    |  |
|------|---|---|---|---|---|---|---|---|---|----|----|----|----|----|----|----|----|----|----|----|----|----|----|----|----|----|----|----|----|----|----|----|----|----|--|
| JAN  |   |   |   | 1 | 2 | 3 | 4 | 5 | 6 | 7  | 8  | 9  | 10 | 11 | 12 | 13 | 14 | 15 | 16 | 17 | 18 | 19 | 20 | 21 | 22 | 23 | 24 | 25 | 26 | 27 | 28 | 29 | 30 | 31 |  |
| FEB  |   |   |   |   |   |   | 1 | 2 | 3 | 4  | 5  | 6  | 7  | 8  | 9  | 10 | 11 | 12 | 13 | 14 | 15 | 16 | 17 | 18 | 19 | 20 | 21 | 22 | 23 | 24 | 25 |    |    |    |  |
| MAR  |   |   |   |   |   |   | 1 | 2 | 3 | 4  | 5  | 6  | 7  | 8  | 9  | 10 | 11 | 12 | 13 | 14 | 15 |    |    |    |    |    |    |    |    |    |    |    |    |    |  |
| APR  |   |   | 1 | 2 | 3 | 4 | 5 | 6 | 7 | 8  | 9  | 10 | 11 | 12 | 13 | 14 | 15 | 16 | 17 | 18 | 19 |    |    |    |    |    |    |    |    |    |    |    |    |    |  |
| MAY  |   |   |   | 1 | 2 | 3 | 4 | 5 | 6 | 7  | 8  | 9  | 10 | 11 | 12 | 13 | 14 | 15 | 16 | 17 |    |    |    |    |    |    |    |    |    |    |    |    |    |    |  |
| JUN  | 1 | 2 | 3 | 4 | 5 | 6 | 7 | 8 | 9 | 10 | 11 | 12 | 13 | 14 | 15 | 16 | 17 | 18 | 19 | 20 | 21 |    |    |    |    |    |    |    |    |    |    |    |    |    |  |
| JUL  |   |   | 1 | 2 | 3 | 4 | 5 | 6 | 7 | 8  | 9  | 10 | 11 | 12 | 13 | 14 | 15 | 16 | 17 | 18 | 19 | 20 | 21 | 22 | 23 | 24 | 25 | 26 | 27 | 28 | 29 | 30 | 31 |    |  |
| AUG  |   |   |   |   |   |   |   |   |   |    |    |    |    |    |    |    |    |    |    |    |    |    |    |    |    |    |    |    |    |    |    |    |    |    |  |
| SEP  |   |   |   |   |   |   |   |   |   |    |    |    |    |    |    |    |    |    |    |    |    |    |    |    |    |    |    |    |    |    |    |    |    |    |  |
| OCT  |   |   |   |   |   |   |   |   |   |    |    |    |    |    |    |    |    |    |    |    |    |    |    |    |    |    |    |    |    |    |    |    |    |    |  |
| NOV  |   |   |   |   |   |   |   |   |   |    |    |    |    |    |    |    |    |    |    |    |    |    |    |    |    |    |    |    |    |    |    |    |    |    |  |
| DEC  |   |   |   |   |   |   |   |   |   |    |    |    |    |    |    |    |    |    |    |    |    |    |    |    |    |    |    |    |    |    |    |    |    |    |  |

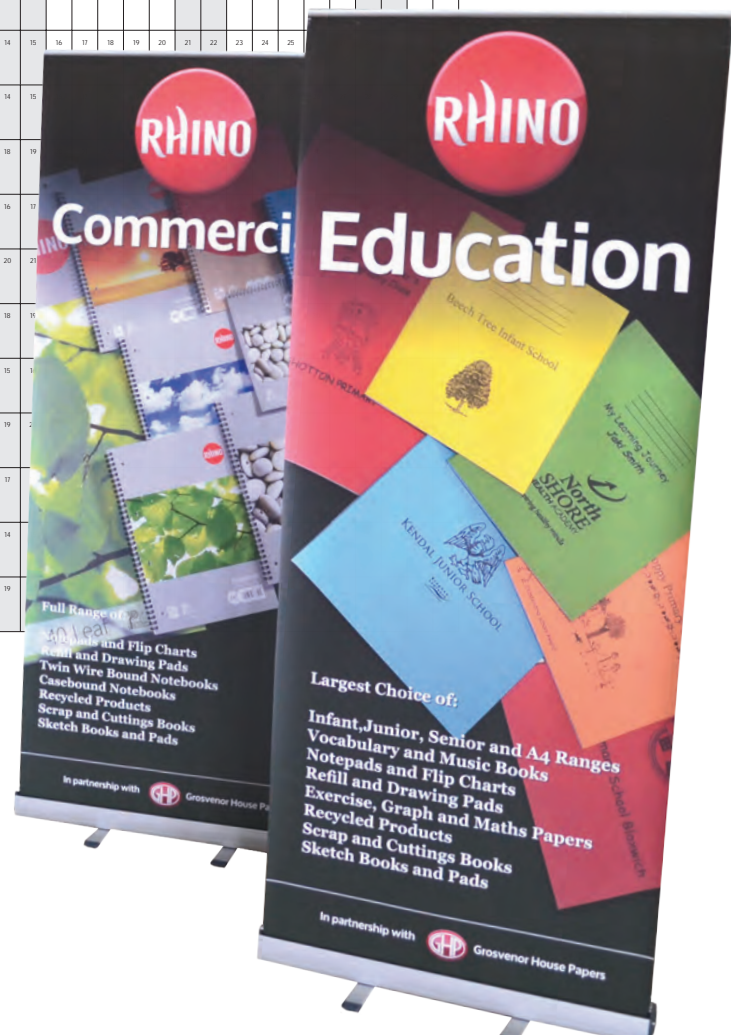

# Exercise Books Overprinting Service

**Personalise your school's exercise books with our overprinting service.**

There's no cost to digitise the artwork from the logo you supply, and any text of your choice. The artwork will then be retained for any future overprinting orders you may place.

You can choose any font you like, simply email the font file to us along with your school logo.

**NEW** - Personalisation is now available to include Department, Class, Subject, Teacher Name and Pupil Name details or any message required, in addition to your school crest or logo.

The printing cost is just 8 pence per book on orders over 1000 and 10 pence a book on orders below 1000 (plus the cost of the exercise books themselves). All printing is done in one colour, black with a choice of typefaces for your school name.

Delivery is normally 2 to 3 weeks.

For further details and quotations for our Exercise Book and Envelope overprinting services, please telephone our sales team on **01539 726161** or email **info@ghpkendal.co.uk**.



## Staedtler Noris Pencils Range Small Packs

The education sectors best selling pencil, available in 5 degrees.

| ORDER CODE | DESCRIPTION                      | PACK | PRICE |
|------------|----------------------------------|------|-------|
| 121 HB     | Noris Blacklead -HB              | 12   | £1.22 |
| 121 B      | Noris Blacklead - B              | 12   | £1.22 |
| 121 2B     | Noris Blacklead - 2B             | 12   | £1.22 |
| 121 H      | Noris Blacklead - H              | 12   | £1.22 |
| 121 2H     | Noris Blacklead - 2H             | 12   | £1.22 |
| 122 HB     | Noris Blacklead with Eraser - HB | 12   | £2.76 |

## Staedtler Noris Pencils Range HB - Classpacks

The education sectors best selling pencil.

| ORDER CODE   | DESCRIPTION                      | PACK | PRICE   |
|--------------|----------------------------------|------|---------|
| 121 C150     | Noris Blacklead Classpack        | 150  | £13.75  |
| 121 C600     | Noris Blacklead Classpack        | 600  | £49.20  |
| A 121 GL1500 | Noris Blacklead (Gratnells Tray) | 1500 | £127.99 |

## Staedtler Noris Triplus Pencils Range HB - Handwriting Packs

Effortless writing for all age groups. Noris pencils designed for handwriting. Triangular shaped pencil for better grip.

| ORDER CODE | DESCRIPTION               | PACK | PRICE  |
|------------|---------------------------|------|--------|
| 118T       | Noris Triplus Slim        | 12   | £3.15  |
| 119        | Noris Triplus Jumbo       | 12   | £5.85  |
| 119 T48    | Noris Triplus Jumbo (Tub) | 48   | £22.99 |
| 119 T72    | Noris Triplus Jumbo (Tub) | 72   | £24.60 |

## Staedtler Tradition Pencils Range HB - Classpacks

The perfect education pencil.

| ORDER CODE | DESCRIPTION         | PACK | PRICE  |
|------------|---------------------|------|--------|
| B 110 C144 | Tradition Classpack | 144  | £19.65 |

## Staedtler Maxi Pencils Range HB

Ideal for younger children. Large diameter lead gives a strong dense black line for smudge free work.

| ORDER CODE  | DESCRIPTION                   | PACK | PRICE  |
|-------------|-------------------------------|------|--------|
| 116 40-HB   | Maxi Infants Pencil           | 12   | £2.86  |
| 116 40 C144 | Maxi Infants Pencil Classpack | 144  | £31.26 |

## Noris Eco Pencils

Noris Eco pencil made from PEFC-certified wood.

| ORDER CODE | DESCRIPTION                          | PACK | PRICE |
|------------|--------------------------------------|------|-------|
| 180 30HB   | Noris Eco Pencil without eraser tip. | 12   | £1.97 |
| 182-30HB   | Noris Eco Pencil with eraser tip.    | 12   | £2.75 |



## Staedtler Tradition Pencils Range Small Packs

The perfect education pencil in 12 degrees and assorted packs

| ORDER CODE | DESCRIPTION  | PACK | PRICE |
|------------|--|------|-------|
| 110 6B     | 6B - Tradition Blacklead   | 12   | £1.98 |
| 110 5B     | 5B - Tradition Blacklead   | 12   | £1.98 |
| 110 4B     | 4B - Tradition Blacklead   | 12   | £1.98 |
| 110 3B     | 3B - Tradition Blacklead   | 12   | £1.98 |
| 110 2B     | 2B - Tradition Blacklead   | 12   | £1.98 |
| 110 B      | B - Tradition Blacklead  | 12   | £1.98 |
| 110 HB     | HB - Tradition Blacklead   | 12   | £1.98 |
| 110 F      | F - Tradition Blacklead  | 12   | £1.98 |
| 110 H      | H - Tradition Blacklead  | 12   | £1.98 |
| 110 2H     | 2H - Tradition Blacklead   | 12   | £1.98 |
| 110 3H     | 3H - Tradition Blacklead   | 12   | £1.98 |
| 110 4H     | 4H - Tradition Blacklead   | 12   | £1.98 |
| 110 5H     | 5H - Tradition Blacklead   | 12   | £1.98 |
| 110 6H     | 6H - Tradition Blacklead   | 12   | £1.98 |
| 110 G6     | 6 Assorted sketching pencils in a tin. Contains 1 each of: 6B, 5B, 4B, 3B, 2B, B               | 6    | £2.20 |
| 61 110-C6  | 6 Assorted sketching pencils plus eraser & sharpner. Contains 1 each of: 6B, 4B, 2B, B, HB, 2H | 6    | £2.20 |
| 112 HB     | HB - Tradition Blacklead with Eraser   | 12   | £3.36 |
| 100 C12-1  | 12 Assorted sketching pencils.   | 12   | £3.65 |

## Staedtler Classroom Pencils

Standard Blacklead Classroom Pencil.

| ORDER CODE | DESCRIPTION         | PACK | PRICE |
|------------|---------------------|------|-------|
| 13045-HB   | HB Blacklead Pencil | 10   | £1.02 |

NEW

A



Noris Gratnells Tray

B



Tradition Classpack

# Introducing the NEW and improved Noris Colour!

 **STAEDTLER**®

**NEW**

## Noris Colour Colouring Pencils

The new and improved Noris Colour soft lead pencil has an easy grip barrel and a non-slip rubberised surface, ideally suited for primary school children. Available in bright vibrant colours, it's designed to make a bold statement on paper.

Pack of 12 individual colours £1.45

|        |            |        |             |
|--------|------------|--------|-------------|
| 185-10 | Yellow     | 185-50 | Light green |
| 185-20 | Pink       | 185-30 | Light blue  |
| 185-76 | Brown      | 185-3  | Blue        |
| 185-61 | Dark mauve | 185-2  | Red         |
| 185-4  | Orange     | 185-43 | Peach       |
| 185-5  | Green      | 185-9  | Black       |

185 C12 Pack of 12 assorted colours £1.58

185 C24 Pack of 24 assorted colours £3.05

185 C144 Classpack of 144 assorted £17.50  
To include 3 FREE sharpeners\*

185 G288 Classpack of 288 assorted £32.40  
in Gratnells Tray  
To include 6 FREE sharpeners\*

\*Value added classpacks available whilst stocks last.



## Classpack

Available in packs  
of 12, 144 and 288

## Also in the Staedtler colouring pencil range...

### Noris Club 1/2 length Assorted

144 01NC12 Pack 12 £1.15



### Noris Club Triplus Slim

Standard – sized colouring pencil for all ages. Ergonomic triangular design encourages correct grip for fatigue-free writing, drawing and colouring.

127 NC12 Pack 12 £2.40

127 T144 Tub of 144 £28.20



### Noris Club Aquarell watercolour

Classic hexagonal shape colouring pencil with watercolour lead and anti-break system for a more break resistant, stronger pencil. Includes free brush.

144 10BC12 Pack 12 £2.42

144 10NC24 Pack 24 £4.85



### Noris Club Triplus Jumbo

A pack of 10 jumbo sized ergonomic triangular full length coloured pencils, ideal for beginners in colouring and writing.

128 NC10 Pack 10 £4.95

128 T50 Tub of 50 £24.80



### People of the World Colouring Pencils

A pack of 12 assorted colouring pencils ideal for colouring people of all nationalities.

144C12POW

Pack 12 £1.65

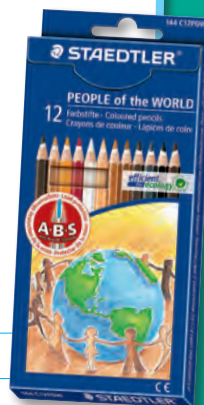

### Ergosoft Aquarell Watercolour

Watercolour pencil with anti-break system for uninterrupted creativity. Create a range of possibilities when colouring, drawing or watercolouring.

156 SB12 Pack 12 £6.60

156 SB24 Pack 24 £13.20



| Staedtler Mars Lumograph Pencils<br>Small Packs                    |   |      |        |
|--|---|------|--------|
| Premium quality artists pencil for writing, drawing and sketching. |   |      |        |
| ORDER CODE   | DESCRIPTION                                   | PACK | PRICE  |
| 100-8B   | Mars Lumograph Pencil - 8B                    | 12   | £6.48  |
| 100-7B   | Mars Lumograph Pencil - 7B                    | 12   | £6.48  |
| 100-6B   | Mars Lumograph Pencil - 6B                    | 12   | £6.48  |
| 100-5B   | Mars Lumograph Pencil - 5B                    | 12   | £6.48  |
| 100-4B   | Mars Lumograph Pencil - 4B                    | 12   | £6.48  |
| 100-3B   | Mars Lumograph Pencil - 3B                    | 12   | £6.48  |
| 100-2B   | Mars Lumograph Pencil - 2B                    | 12   | £6.48  |
| 100-B  | Mars Lumograph Pencil - B                     | 12   | £6.48  |
| 100-HB   | Mars Lumograph Pencil - HB                    | 12   | £6.48  |
| 100-F  | Mars Lumograph Pencil - F                     | 12   | £6.48  |
| 100-H  | Mars Lumograph Pencil - H                     | 12   | £6.48  |
| 100-2H   | Mars Lumograph Pencil - 2H                    | 12   | £6.48  |
| 100-3H   | Mars Lumograph Pencil - 3H                    | 12   | £6.48  |
| 100-4H   | Mars Lumograph Pencil - 4H                    | 12   | £6.48  |
| 100-5H   | Mars Lumograph Pencil - 5H                    | 12   | £6.48  |
| 100-6H   | Mars Lumograph Pencil - 6H                    | 12   | £6.48  |
| 100 G12  | Assorted - Mars Lumograph Pencil              | 12   | £7.99  |
| 100 G12 S  | Assorted Soft Degrees - Mars Lumograph Pencil | 12   | £7.99  |
| 100 G19  | Assorted - Mars Lumograph Pencil              | 19   | £12.60 |

| Staedtler<br>Pencil Sharpener                |                            |      |        |
|--|----------------------------|------|--------|
| Safe and easy to use with shaving collector. |                            |      |        |
| ORDER CODE                                   | DESCRIPTION                | PACK | PRICE  |
| A 511 004                                    | Noris Tub Sharpener        | 1    | £1.48  |
| 510 20                                       | Metal Two Hole             | 20   | £16.10 |
| 512 128                                      | Triangular Double Hole Tub | 1    | £1.99  |

| Staedtler<br>Erasers          |                                |      |        |
|-------------------------------|--------------------------------|------|--------|
| Latex Phthalate free erasers. |                                |      |        |
| ORDER CODE                    | DESCRIPTION/SIZE               | PACK | PRICE  |
| 526 N20                       | Noris Eraser 65x23x13mm        | 20   | £6.50  |
| B 526 50                      | Mars Plastic 65x23x13mm        | 20   | £10.15 |
| C 526 B30                     | Rasoplast 43x19x13mm           | 30   | £5.75  |
| D 5427                        | Karat Kneadable Art 40x40x10mm | 1    | £0.68  |

| Staedtler Basic Mars Compass   |  |      |       |
|--|--|------|-------|
| Precision Metal Compass with friction head for precise, smooth radius setting. |  |      |       |
| ORDER CODE   | DESCRIPTION/SIZE                       | PACK | PRICE |
| NEW 559 WP00   | Max Circle approx. 340mm, length 128mm | Each | £3.15 |





**Noris Club Range**



**Noris Club Gratnells Tray**



**Maxi Colouring Pencil Range**



**Staedtler Maths Set**

| Staedtler Noris Club Range Colouring Pencils                      |                                   |      |       |
|---|-----------------------------------|------|-------|
| The perfect education coloured pencil in a great range of shades. |                                   |      |       |
| ORDER CODE  | DESCRIPTION                       | PACK | PRICE |
| 144-9   | Noris Club - Black                | 12   | £1.40 |
| 144-3   | Noris Club - Blue                 | 12   | £1.40 |
| 144-30  | Noris Club - Light Blue           | 12   | £1.40 |
| 144-50  | Noris Club - Light Green          | 12   | £1.40 |
| 144-4   | Noris Club - Orange               | 12   | £1.40 |
| 144-5   | Noris Club - Green                | 12   | £1.40 |
| 144-2   | Noris Club - Red                  | 12   | £1.40 |
| 144-76  | Noris Club - Van Dyke Brown       | 12   | £1.40 |
| 144-23  | Noris Club - Wine Red             | 12   | £1.40 |
| 144-1   | Noris Club - Yellow               | 12   | £1.40 |
| 144-6   | Noris Club - Dark Muave           | 12   | £1.40 |
| 144-61  | Noris Club - Violet               | 12   | £1.40 |
| 144-43  | Noris Club - Light Brown          | 12   | £1.40 |
| 144 NC12  | Noris Club - Assorted             | 12   | £1.58 |
| 144 01NC12  | Noris Club - 1/2 Length Assorted  | 12   | £1.15 |
| 144C12POW   | Noris Club - People Colours       | 12   | £1.65 |
| 144 NC24  | Noris Club - Full Length Assorted | 24   | £3.05 |

| Staedtler Noris Club Range Assorted Colouring Pencils - Classpacks |                             |      |        |
|--|-----------------------------|------|--------|
| The perfect education coloured pencil in a great range of shades.  |                             |      |        |
| ORDER CODE   | DESCRIPTION                 | PACK | PRICE  |
| 144 C144   | Noris Club                  | 144  | £16.95 |
| 144 G288   | Noris Club (Gratnells Tray) | 288  | £31.45 |

| Staedtler Maxi Colouring Pencil Range   |                                  |      |       |
|---|----------------------------------|------|-------|
| Ideal for small hands and special needs when developing writing and drawing skills. |                                  |      |       |
| ORDER CODE  | DESCRIPTION                      | PACK | PRICE |
| 126 C8  | Maxi Colouring Pencil - Assorted | 8    | £3.86 |

| Staedtler Maths Set  |            | £1.95     |
|--|------------|-----------|
| Staedtler Matths set in sturdy lightweight tin containing ruler, protractor, 90 & 45 degree set squares, pencil, sharpener, rubber, compass and stencil. |            |           |
| Description  | Order Code | Pack Size |
| Matths Set   | 557-10     | Each      |

**Staedtler Club Aquarell Watercolour Pencils  
Assorted Colouring Pencils - Includes Free Paint  
Brush**

Can be used with water and brush.

| ORDER CODE | DESCRIPTION                 | PACK | PRICE |
|------------|-----------------------------|------|-------|
| 144 10NC12 | Aquarell Watercolour Pencil | 12   | £2.42 |
| 144 10NC24 | Aquarell Watercolour Pencil | 24   | £4.85 |

**Staedtler Karat Aquarell Watercolour Pencils  
Assorted Colouring Pencils**

The tins make ideal reward gifts for all sorts of occasion.

A

| ORDER CODE | DESCRIPTION                    | PACK | PRICE  |
|------------|--------------------------------|------|--------|
| 125 M12    | Karat Watercolour Pencil (Tin) | 12   | £7.90  |
| 125 M24    | Karat Watercolour Pencil (Tin) | 24   | £15.75 |
| 125 M36    | Karat Watercolour Pencil (Tin) | 36   | £23.60 |
| 125 M48    | Karat Watercolour Pencil (Tin) | 48   | £31.45 |
| 125 M60    | Karat Watercolour Pencil (Tin) | 60   | £39.25 |

**Staedtler Essential  
Assorted Colouring Pencils**

Essential Colour Pencils produced from certified wood.

| ORDER CODE | DESCRIPTION                                  | PACK | PRICE  |
|------------|--|------|--------|
| 143 C288   | Essential Colour Pencils<br>(Cardboard Tray) | 288  | £22.40 |

**Staedtler Club Wax Crayons**

Assorted coloured waterproof wax crayons that are break resistant and supplied paper-wrapped. 16 vibrant colours available, approx 8mm diameter.

B

| ORDER CODE | DESCRIPTION            | PACK | PRICE |
|------------|------------------------|------|-------|
| 220 NC8    | Noris Club Wax Crayons | 8    | £1.20 |
| 220 NC16   | Noris Club Wax Crayons | 16   | £1.70 |

**Staedtler Club Oil Pastels**

25 Brilliant colours available approx. diameter 8mm

| ORDER CODE | DESCRIPTION            | PACK | PRICE |
|------------|------------------------|------|-------|
| 241 NC12   | Noris Club Oil Pastels | 12   | £1.05 |
| 241 NC16   | Noris Club Oil Pastels | 16   | £1.25 |
| 241 NC25   | Noris Club Oil Pastels | 25   | £1.95 |

**Staedtler Club Oil Pastels**

Jumbo Range 24 brilliant colours available approx. diameter 11mm.

C

| ORDER CODE | DESCRIPTION            | PACK | PRICE |
|------------|------------------------|------|-------|
| 243 NC12   | Noris Club Oil Pastels | 12   | £1.80 |
| 243 NC24   | Noris Club Oil Pastels | 24   | £3.55 |

D

**Staedtler Club Colour Marker**

12 Brilliant colours available, approx. line width approx. 3mm.

| ORDER CODE | DESCRIPTION                         | PACK | PRICE  |
|------------|-------------------------------------|------|--------|
| 340 WP12   | Noris Club Chunky Markers           | 12   | £4.35  |
| 340 C96    | Noris Club Chunky Markers Classpack | 96   | £30.20 |

A



Karat Aquarell Watercolour

B



Club Wax Crayons

C



Club Oil Pastels

D



Noris Chunky Markers



G



Triplus Colour Pens

F



Noris Club School Colouring Pens

**Staedtler Noris Club Range  
Fibre Tipped Pens**

E

Bright range of shades in assorted packs. Choice of nib style.

| ORDER CODE | DESCRIPTION         | PACK | PRICE  |
|------------|---------------------|------|--------|
| 325 WP12   | Fine Nib            | 12   | £1.15  |
| 325 C144   | Fine Nib Classpack  | 144  | £12.50 |
| 346 C144   | Broad Nib Classpack | 144  | £22.10 |

**Staedtler Noris Club School Colouring  
Fibre Tipped Pens**

The perfect education colouring fibre tip pen in assorted packs

| ORDER CODE | DESCRIPTION                  | PACK | PRICE  |
|------------|------------------------------|------|--------|
| 326 WP10   | Fibre Tip Assorted           | 10   | £2.02  |
| 326 WP20   | Fibre Tip Assorted           | 20   | £3.99  |
| 326 NKP40  | Fibre Tip Assorted (Tub)     | 40   | £7.80  |
| 326 C100   | Fibre Tip Assorted Classpack | 100  | £19.02 |

F

**Staedtler Triplus Colour Pens**

Available in 20 Vibrant Colours, can be washed out of most textiles. Perfectly sized ergonomic, triangular barrel for effortless, fatigue free writing and colouring.

| ORDER CODE | DESCRIPTION              | PACK | PRICE  |
|------------|--------------------------|------|--------|
| 323 SB10   | Triplus Colour Fibre Tip | 10   | £5.35  |
| 323 SB20   | Triplus Colour Fibre Tip | 20   | £10.66 |

G

E



Noris Club Fibre Tips Classpack

Minimum order value of £50.00 ex.VAT or small order administration charge of £7.50 will apply

## Staedtler Lumocolor Whiteboard Markers - Bullet Tip

NEW RANGE

Can be dry-wiped from whiteboards and surfaces such as glass and porcelain without leaving a trace.

| ORDER CODE       | COLOUR               | PACK | PRICE  |
|------------------|----------------------|------|--------|
| 351-2            | Red                  | 10   | £4.20  |
| 351-3            | Blue                 | 10   | £4.20  |
| 351-5            | Green                | 10   | £4.20  |
| 351-9            | Black                | 10   | £4.20  |
| <b>A</b> 351 WP4 | Assorted Colours     | 4    | £2.76  |
| 351SO T80        | 20 each of 4 colours | 80   | £33.95 |



Lumocolor Whiteboard Marker

## Staedtler Lumocolor Compact Whiteboard Markers

New pen style marker perfect for pupils, reliable and instant drying.

| ORDER CODE        | COLOUR   | PACK | PRICE  |
|-------------------|----------|------|--------|
| 341-9             | Black    | 10   | £4.60  |
| 341 WP4           | Assorted | 4    | £3.05  |
| 341-9 T36         | Black    | 36   | £14.95 |
| 341SO T36         | Assorted | 36   | £14.50 |
| <b>B</b> 341 G144 | Assorted | 144  | £53.55 |



Lumocolor Flipchart Markers

## Staedtler Lumocolor Flipchart Markers

Assorted Pack contains 1 each of Red, Blue, Orange, Green, Purple & Black.

| ORDER CODE       | COLOUR   | PACK | PRICE |
|------------------|----------|------|-------|
| <b>C</b> 356 WP6 | Assorted | 6    | £5.85 |
| 356-3            | Blue     | 10   | £9.65 |
| 356-9            | Black    | 10   | £9.65 |



Lumocolor Compact Whiteboard Markers

E



Lumocolor Fine Nib

| Staedtler Non Permanent<br>Lumocolor Superfine Nib Markers - 0.4mm |          |      |       |
|--|----------|------|-------|
| Universal pen for use on overhead film and almost all surfaces.    |          |      |       |
| ORDER CODE   | COLOUR   | PACK | PRICE |
| 311 WP4  | Assorted | 4    | £3.15 |

D

| Staedtler Non Permanent<br>Lumocolor Fine Nib Markers - 0.6mm   |          |      |       |
|---|----------|------|-------|
| Universal pen for use on overhead film and almost all surfaces. |          |      |       |
| ORDER CODE  | COLOUR   | PACK | PRICE |
| 316-9   | Black    | 10   | £7.40 |
| 316 WP4   | Assorted | 4    | £3.15 |
| 316 WP8   | Assorted | 8    | £6.25 |

E

F



Lumocolor Medium Nib

| Staedtler Non Permanent<br>Lumocolor Medium Nib Markers - 1.0mm |          |      |       |
|---|----------|------|-------|
| Universal pen for use on overhead film and almost all surfaces. |          |      |       |
| ORDER CODE  | COLOUR   | PACK | PRICE |
| 315-9   | Black    | 10   | £7.40 |
| 315 WP4   | Assorted | 4    | £3.15 |
| 315 WP8   | Assorted | 8    | £6.25 |

F

| Staedtler Non Permanent<br>Lumocolor Broad Chisel Nib Markers<br>- 1.0mm or 2.5mm |          |      |       |
|---|----------|------|-------|
| Universal pen for use on overhead film and almost all surfaces.                   |          |      |       |
| ORDER CODE  | COLOUR   | PACK | PRICE |
| 312 WP4   | Assorted | 4    | £3.15 |
| 312 WP8   | Assorted | 8    | £6.25 |

G

G



Lumocolor Broad Chisel Nib

D



Lumocolor Superfine Nib

| A Staedtler Lumocolor Permanent Markers<br>Superfine Nib - 0.4mm |          |      |       |
|--|----------|------|-------|
| Universal pen for use on overhead film and almost all surfaces.  |          |      |       |
| ORDER CODE   | COLOUR   | PACK | PRICE |
| 313-9  | Black    | 10   | £7.40 |
| 313 WP4  | Assorted | 4    | £3.15 |

| B Staedtler Lumocolor Permanent Markers<br>Fine Nib - 0.6mm    |          |      |       |
|--|----------|------|-------|
| Universal pen for use on overhead film and almost all surfaces |          |      |       |
| ORDER CODE   | COLOUR   | PACK | PRICE |
| 318-9  | Black    | 10   | £7.40 |
| 318 WP4  | Assorted | 4    | £3.15 |
| 318 WP8  | Assorted | 8    | £6.25 |

| Staedtler Lumocolor Permanent Markers<br>Medium Nib - 1.0mm     |          |      |       |
|---|----------|------|-------|
| Universal pen for use on overhead film and almost all surfaces. |          |      |       |
| ORDER CODE  | COLOUR   | PACK | PRICE |
| 317-9   | Black    | 10   | £7.40 |
| 317 WP4   | Assorted | 4    | £3.15 |
| 317 WP8   | Assorted | 8    | £6.25 |

| C Staedtler Lumocolor Permanent Markers<br>Broad Chisel Nib - 1.0mm or 2.5mm |          |      |       |
|--|----------|------|-------|
| Universal pen for use on overhead film and almost all surfaces               |          |      |       |
| ORDER CODE   | COLOUR   | PACK | PRICE |
| 314 WP4  | Assorted | 4    | £3.15 |
| 314 WP8  | Assorted | 8    | £6.25 |

| Staedtler Lumocolor Permanent Markers<br>Bullet Tip Nib    |        |      |       |
|--|--------|------|-------|
| Dry safe, can be left uncapped for days without drying up. |        |      |       |
| ORDER CODE   | COLOUR | PACK | PRICE |
| 352-9  | Black  | 10   | £5.55 |

| D Textsurfer Classic<br>Highlighter Marker          |          |      |       |
|---|----------|------|-------|
| Highlights without smudging, ultra-soft chisel tip. |          |      |       |
| ORDER CODE  | COLOUR   | PACK | PRICE |
| 364-1   | Yellow   | 10   | £5.85 |
| 364-23  | Pink     | 10   | £5.85 |
| 364-2   | Red      | 10   | £5.85 |
| 364-3   | Blue     | 10   | £5.85 |
| 364-5   | Green    | 10   | £5.85 |
| 364-6   | Violet   | 10   | £5.85 |
| 364 WP4   | Assorted | 4    | £2.40 |
| 364 WP6   | Assorted | 6    | £3.50 |
| 364 WP8   | Assorted | 8    | £4.65 |



Lumocolor Superfine Nib and Broad



Lumocolor Fine Nib



Textsurfer Classic Highlighter



Staedtler Pens

| Staedtler Handwriting Pens<br>Normal & Classpacks <span style="float: right;">NEW RANGE</span> |        |      |        |
|--|--------|------|--------|
| Handwriting pen with moulded grip zone for comfort and control.                                |        |      |        |
| ORDER CODE   | COLOUR | PACK | PRICE  |
| 309-3 T50  | Blue   | 50   | £19.16 |
| 309-9 T50  | Black  | 50   | £19.16 |
| 309-3 C100   | Blue   | 100  | £38.25 |
| 309-9 C100   | Black  | 100  | £38.25 |
| 309-3 C200   | Blue   | 200  | £76.18 |
| 309-9 C200   | Black  | 200  | £76.18 |

| Staedtler Stick Ballpoint Pens   |        |          |      |       |
|--|--------|----------|------|-------|
| Premium quality, extremely long write out length, ballpoint pen with cap and clip. |        |          |      |       |
| ORDER CODE   | COLOUR | NIB SIZE | PACK | PRICE |
| 430 M-3  | Blue   | Medium   | 10   | £1.50 |
| 430 M-5  | Green  | Medium   | 10   | £1.50 |
| 430 M-2  | Red    | Medium   | 10   | £1.50 |
| 430 M-9  | Black  | Medium   | 10   | £1.50 |
| 430 M-3CP5   | Blue   | Medium   | 50   | £6.85 |
| 430 M-5CP5   | Green  | Medium   | 50   | £6.85 |
| 430 M-2CP5   | Red    | Medium   | 50   | £6.85 |
| 430 M-9CP5   | Black  | Medium   | 50   | £6.85 |
| 430 F-3CP5   | Blue   | Fine     | 50   | £6.85 |
| 430 F-5CP5   | Green  | Fine     | 50   | £6.85 |
| 430 F-2CP5   | Red    | Fine     | 50   | £6.85 |
| 430 F-9CP5   | Black  | Fine     | 50   | £6.85 |



Staedtler Pens

| Staedtler Ballpoint 432 Pens                             |          |      |       |
|--|----------|------|-------|
| Ergonomic triangular shape for relaxed and easy writing. |          |      |       |
| ORDER CODE   | COLOUR   | PACK | PRICE |
| 432 35MPB10  | Assorted | 10   | £2.35 |

| Staedtler Triplus Ballpoint Pens   |          |      |       |
|--|----------|------|-------|
| Ballpoint on with cap and clip with an ergonomic triangular barrel. An assorted desktop box contains 1 red, 1 blue, 1 green and 1 black. |          |      |       |
| ORDER CODE   | COLOUR   | PACK | PRICE |
| 431 M-2  | Red      | 10   | £8.25 |
| 431 M-3  | Blue     | 10   | £8.25 |
| 431 M-5  | Green    | 10   | £8.25 |
| 431 M-9  | Black    | 10   | £8.25 |
| 431 MSB4   | Assorted | 4    | £3.60 |

| Staedtler Triplus Metallic Gel Pens  |          |      |       |
|--|----------|------|-------|
| Award winning ballpoint pen with cap and clip, ergonomic triangular barrel. An assorted pack of 6 different colours. |          |      |       |
| ORDER CODE   | COLOUR   | PACK | PRICE |
| 463-DSB6   | Assorted | 6    | £4.20 |

NEW

| Staedtler Triplus Rollerball Pen  |          |      |       |
|---|----------|------|-------|
| Ergonomic triangular shape for relaxed and easy writing. An assorted desktop box of 10 different colours. |          |      |       |
| ORDER CODE  | COLOUR   | PACK | PRICE |
| 403 SB10  | Assorted | 10   | £5.25 |
| 403-3   | Blue     | 10   | £5.25 |
| 403-5   | Green    | 10   | £5.25 |

**A**

**Staedtler Metallic Markers**

Can be used on paper, card and dried FIMO also on dark coloured paper. Box of 10 of a colour or pack of 1 each of gold & silver.

| ORDER CODE | COLOUR        | PACK | PRICE |
|------------|---------------|------|-------|
| 8323-11    | Gold          | 10   | £7.36 |
| 8323-81    | Silver        | 10   | £7.36 |
| 8323-SBK2  | Gold & Silver | 2    | £1.75 |



**B**

**Staedtler Triplus Fineliner**

**NEW RANGE**

Fineliner with superfine 0.3mm line width, Dry Safe can be left uncapped for days.

| ORDER CODE | COLOUR   | PACK | PRICE |
|------------|----------|------|-------|
| 334-2      | Red      | 10   | £4.72 |
| 334-3      | Blue     | 10   | £4.72 |
| 334-5      | Green    | 10   | £4.72 |
| 334-9      | Black    | 10   | £4.72 |
| 334 SB4    | Assorted | 4    | £1.99 |
| 334 SB10   | Assorted | 10   | £4.96 |
| 334 SB20   | Assorted | 20   | £9.92 |

**C**

**Staedtler Pigment Liner**

Pigment liner for writing, sketching and drawing. Desktop box of 4 pens in widths 0.1mm, 0.3mm, 0.5mm & 0.7mm.

| ORDER CODE | COLOUR   | PACK | PRICE |
|------------|----------|------|-------|
| 308 WP4    | Assorted | 4    | £5.15 |



**Staedtler Fimo Soft & Effect Blocks of 56g**

Fimo soft & effect is extremely easy to knead and ready to use in no time.

| ORDER CODE | COLOUR                 | PACK | PRICE |
|------------|------------------------|------|-------|
| 8020-0     | White                  | 1    | £1.42 |
| 8020-003   | Marble                 | 1    | £1.42 |
| 8020-014   | Translucent            | 1    | £1.42 |
| 8020-04    | Nightglow              | 1    | £1.42 |
| 8020-08    | Mother of Pearl        | 1    | £1.42 |
| 8020-10    | Lemon                  | 1    | £1.42 |
| 8020-104   | Transparent Yellow     | 1    | £1.42 |
| 8020-11    | Metallic Gold          | 1    | £1.42 |
| 8020-112   | Glitter Gold           | 1    | £1.42 |
| 8020-16    | Sunflower              | 1    | £1.42 |
| 8020-202   | Glitter Red            | 1    | £1.42 |
| 8020-204   | Transparent Red        | 1    | £1.42 |
| 8020-22    | Raspberry              | 1    | £1.42 |
| 8020-24    | Indian Red             | 1    | £1.42 |
| 8020-26    | Cherry Red             | 1    | £1.42 |
| 8020-27    | Metallic Copper        | 1    | £1.42 |
| 8020-28    | Metallic Ruby Red      | 1    | £1.42 |
| 8020-302   | Glitter Blue           | 1    | £1.42 |
| 8020-33    | Brilliant Blue         | 1    | £1.42 |
| 8020-35    | Windsor Blue           | 1    | £1.42 |
| 8020-37    | Pacific Blue           | 1    | £1.42 |
| 8020-374   | Transparent Blue       | 1    | £1.42 |
| 8020-38    | Metallic Sapphire Blue | 1    | £1.42 |
| 8020-39    | Peppermint             | 1    | £1.42 |
| 8020-404   | Transparent Orange     | 1    | £1.42 |
| 8020-42    | Tangerine              | 1    | £1.42 |
| 8020-43    | Flesh Light            | 1    | £1.42 |
| 8020-50    | Apple Green            | 1    | £1.42 |
| 8020-502   | Glitter Green          | 1    | £1.42 |
| 8020-504   | Transparent Green      | 1    | £1.42 |
| 8020-052   | Glitter White          | 1    | £1.42 |
| 8020-53    | Tropical Green         | 1    | £1.42 |
| 8020-56    | Emerald                | 1    | £1.42 |
| 8020-58    | Metallic Opal Green    | 1    | £1.42 |
| 8020-602   | Glitter Purple         | 1    | £1.42 |
| 8020-604   | Transparent Purple     | 1    | £1.42 |
| 8020-61    | Purple                 | 1    | £1.42 |
| 8020-62    | Lavender               | 1    | £1.42 |
| 8020-63    | Plumb                  | 1    | £1.42 |
| 8020-7     | Caramel                | 1    | £1.42 |
| 8020-70    | Sahara                 | 1    | £1.42 |
| 8020-75    | Chocolate              | 1    | £1.42 |
| 8020-76    | Cognac                 | 1    | £1.42 |
| 8020-80    | Dolphin Grey           | 1    | £1.42 |
| 8020-803   | Granite                | 1    | £1.42 |
| 8020-81    | Metallic Silver        | 1    | £1.42 |
| 8020-812   | Glitter Silver         | 1    | £1.42 |
| 8020-9     | Black                  | 1    | £1.42 |

# Introducing the NEW FIMO kids classpack

FIMO kids offers everything you know and trust about FIMO clays, in a softer to handle consistency, that bakes hard (bake at 110°C for 30 minutes) to withstand the tough demands of play. With the introduction of child-friendly tools perfectly suited to children's hands, it is a must-have for any classroom.

- Extremely soft with a pleasant feel
- Ideal for small hands in the classroom
- Easy to use
- Vibrant colours

### Classpack includes:

2 x white, yellow, red, pink, rose, blue, turquoise, orange, flesh, green, light green, lilac, brown, black, glitter white and glitter gold, 32 x modelling tools and 1 step by step project leaflet containing 2 Key Stage specific projects.

8030-S32LA Classpack £26.85

for more inspiration, visit [www.fimo.com](http://www.fimo.com)



|                    |
|--------------------|
| Nightglow          |
| Glitter White      |
| Glitter Gold       |
| Glitter Red        |
| Glitter Purple     |
| Glitter Blue       |
| Glitter Green      |
| Glitter Silver     |
| Translucent        |
| Translucent Yellow |
| Translucent Orange |
| Translucent Red    |

|                    |
|--------------------|
| Translucent Purple |
| Translucent Blue   |
| Translucent Green  |
| Marble             |
| Granite            |
| Mother of Pearl    |
| Metallic Gold      |
| Copper             |
| Ruby Red           |
| Sapphire Blue      |
| Opal Green         |
| Metallic Silver    |

|                |
|----------------|
| White          |
| Lemon          |
| Sun Flower     |
| Tangerine      |
| Indian Red     |
| Cherry Red     |
| Raspberry      |
| Purple         |
| Lavender       |
| Plum           |
| Windsor Blue   |
| Brilliant Blue |

|                |
|----------------|
| Pacific Blue   |
| Peppermint     |
| Emerald        |
| Tropical Green |
| Apple Green    |
| Flesh          |
| Sahara         |
| Cognac         |
| Caramel        |
| Chocolate      |
| Dolphin Grey   |
| Black          |

Minimum order value of £50.00 ex.VAT or small order administration charge of £7.50 will apply

**Fimo Soft Classpack for Kids**

Each Classpack contains 26 x 56g assorted blocks, plus 10 modelling tools, 4 cords and 1 step project leaflet.

| ORDER CODE | COLOUR   | PACK | PRICE  |
|------------|----------|------|--------|
| 8023 50 GB | Assorted | 1    | £24.70 |

**A**

**Fimo Air Light White**

Fimo Air is the air-drying alternative that guarantees to put fresh ideas to creative users. Extremely light, ideal for mobiles or masks, easy to paint, pliable & lightweight, resealable box.

| ORDER CODE | DESCRIPTION             | PACK   | PRICE  |
|------------|-------------------------|--------|--------|
| 8131 50 GB | Air Light 4x250g Blocks | 1 Kilo | £14.85 |

**B**

**Fimo Modelling Tools**

Plastic wallet containing 4 different plastic modelling tools.

| ORDER CODE | DESCRIPTION                   | PACK | PRICE |
|------------|-------------------------------|------|-------|
| 8711       | Staedler Fimo Modelling Tools | 4    | £3.10 |

**C**

**Fimo Oven Thermometer**

Temperature range from 0 degrees to 300 degrees centigrade

| ORDER CODE | DESCRIPTION               | PACK | PRICE  |
|------------|---------------------------|------|--------|
| 8700-02    | Staedler Oven Thermometer | 4    | £17.12 |

**B**

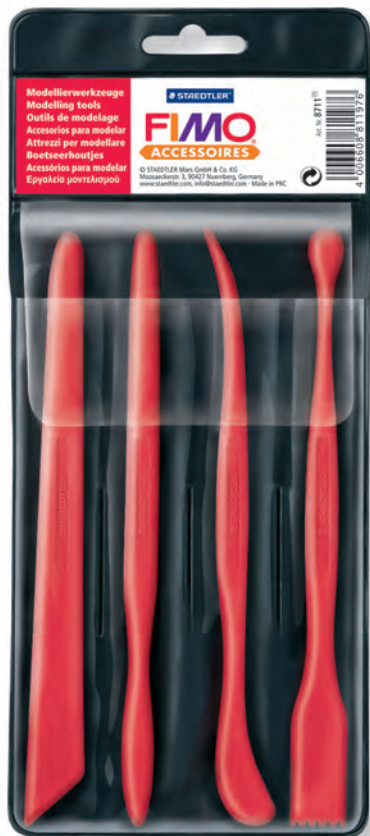

Fimo Modeling Tools

**Fimo Kids Form & Play**

Each FIMO set provides the FIMO kids clay needed to make the models shown on the front of the pack, a modelling tool, full set of instructions plus a relevant background so that the children can role play their creations. Each set is categorized according to the level of difficulty, ranging from 1 star to 3 stars on the skill indicator on the front of the pack.

| ORDER CODE       | DESCRIPTION                       | PRICE |
|------------------|-----------------------------------|-------|
| <b>D</b> 8034 01 | Fimo Kids Form & Play - farm      | £4.95 |
| <b>E</b> 8034 02 | Fimo Kids Form & Play - pet       | £4.95 |
| <b>F</b> 8034 04 | Fimo Kids Form & Play - fairy     | £4.95 |
| <b>G</b> 8034 05 | Fimo Kids Form & Play - knight    | £4.95 |
| <b>H</b> 8034 07 | Fimo Kids Form & Play - dino      | £4.95 |
| <b>I</b> 8034 08 | Fimo Kids Form & Play - pony      | £4.95 |
| <b>J</b> 8034 09 | Fimo Kids Form & Play - space     | £4.95 |
| <b>K</b> 8034 10 | Fimo Kids Form & Play - butterfly | £4.95 |
| <b>L</b> 8034 03 | Fimo Kids Form & Play - robot     | £4.95 |
| <b>M</b> 8034 06 | Fimo Kids Form & Play - princess  | £4.95 |

**A**



Fimo Air Light White

**C**



Fimo Oven Thermometer





Fimo Kids Form & Play

**Charta White Card Packs  
A4 (210mm x 297mm)**

Ideal for all types of craft projects.

| ORDER CODE | THICKNESS  | PACK | PRICE |
|------------|------------|------|-------|
| FWA421     | 200 micron | 200  | £4.25 |
| FWA423     | 230 micron | 100  | £2.25 |
| FWA4231    | 230 micron | 200  | £4.99 |
| FWA4285    | 280 micron | 50   | £1.75 |
| FWA4281    | 280 micron | 100  | £3.52 |
| FWA4282    | 280 micron | 200  | £6.99 |
| FWA4385    | 380 micron | 50   | £2.65 |
| FWA4381    | 380 micron | 100  | £5.20 |
| VWA4435    | 500 micron | 50   | £3.60 |
| VWA4581    | 580 micron | 10   | £0.95 |
| VWA4585    | 580 micron | 50   | £4.35 |
| VWA4751    | 750 micron | 10   | £1.15 |
| VWA475     | 750 micron | 50   | £5.65 |

**Charta White Card Packs  
A3 (297mm x 420mm)**

Ideal for all types of craft projects.

| ORDER CODE | THICKNESS  | PACK | PRICE  |
|------------|------------|------|--------|
| FWA3231    | 230 micron | 100  | £4.85  |
| FWA3285    | 280 micron | 50   | £3.52  |
| FWA3281    | 280 micron | 100  | £6.99  |
| FWA3385    | 380 micron | 50   | £5.65  |
| VWA3435    | 500 micron | 50   | £7.80  |
| VWA3585    | 580 micron | 50   | £9.40  |
| VWA3755    | 750 micron | 50   | £11.10 |

**Charta Coloured Card Packs  
A4 (210mm x 297mm) - 230 micron**

Ideal for all types of craft projects.

| ORDER CODE | DESCRIPTION     | PACK | PRICE |
|------------|-----------------|------|-------|
| VCBA423    | Celestial Blue  | 100  | £3.50 |
| VCVA423    | Cream Vellum    | 100  | £3.50 |
| VDA423     | Daffodil        | 100  | £3.50 |
| VDBA423    | Deep Blue       | 100  | £3.50 |
| VEGA423    | Emerald Green   | 100  | £3.50 |
| VJA423     | Jade            | 100  | £3.50 |
| VOA423     | Orange          | 100  | £3.50 |
| VOGA423    | Gold            | 100  | £3.50 |
| VPA423     | Pink            | 100  | £3.50 |
| VRA423     | Red             | 100  | £3.50 |
| VRAA423    | Raspberry       | 100  | £3.50 |
| VSGYA423   | Silver Grey     | 100  | £3.50 |
| VSYA423    | Sunlight Yellow | 100  | £3.50 |

**Charta Coloured Card Packs  
A4 (210mm x 297mm) - 300 micron**

Ideal for all types of craft projects.

| ORDER CODE | DESCRIPTION    | PACK | PRICE |
|------------|----------------|------|-------|
| VBKA435    | Black          | 50   | £3.95 |
| VCBA435    | Celestial Blue | 50   | £3.95 |
| VCOBA435   | Cobalt Blue    | 50   | £3.95 |
| VCVA435    | Cream Vellum   | 50   | £3.95 |
| VDA435     | Daffodil       | 50   | £3.95 |
| VDBA435    | Deep Blue      | 50   | £3.95 |
| VDGA435    | Dark Green     | 50   | £3.95 |
| VDGYA435   | Dark Grey      | 50   | £3.95 |
| VEGA435    | Emerald Green  | 50   | £3.95 |
| VFGA435    | Forest Green   | 50   | £3.95 |
| VIA435     | Ivory          | 50   | £3.95 |
| VJA435     | Jade           | 50   | £3.95 |
| VLGA435    | Lime Green     | 50   | £3.95 |
| VNBA435    | Navy Blue      | 50   | £3.95 |
| VOA435     | Orange         | 50   | £3.95 |
| VOGA435    | Gold           | 50   | £3.95 |
| VPA435     | Pink           | 50   | £3.95 |
| VRA435     | Red            | 50   | £3.95 |
| VRASA435   | Raspberry      | 50   | £3.95 |
| VRUA435    | Rust           | 50   | £3.95 |
| VSGA435    | Silver Grey    | 50   | £3.95 |
| VSYA435    | Sun Yellow     | 50   | £3.95 |
| VTA435     | Tangerine      | 50   | £3.95 |
| VVA435     | Violet         | 50   | £3.95 |

**Charta Assorted Coloured Card Packs  
A4 (210mm x 297mm)**

Ideal for all types of craft projects.

| ORDER CODE | DESCRIPTION                  | PACK | PRICE |
|------------|------------------------------|------|-------|
| VA423AS    | 230 micron - 20x10 Pastels   | 200  | £6.50 |
| VA43AS5    | 300 micron - 5 x 10 Pastels  | 50   | £3.95 |
| VVA43AS5   | 300 micron - 5 x 10 Vivids   | 50   | £4.35 |
| VA43AS     | 300 micron - 20 x 10 Pastels | 200  | £9.70 |
| VA438AS5   | 380 micron - 5 x 10 Pastels  | 50   | £4.70 |
| VA475AS5   | 750 micron - 10 x 5 Pastels  | 50   | £8.25 |



| Charta Assorted Coloured Card Packs<br>A3 (297mm x 420mm) |                             |      |       |
|---|-----------------------------|------|-------|
| Ideal for all types of craft projects.                    |                             |      |       |
| ORDER CODE  | DESCRIPTION                 | PACK | PRICE |
| VA323AS5  | 230 micron - 5 x 10 Pastels | 100  | £7.90 |
| VA33AS5   | 300 micron - 5 x 10 Pastels | 50   | £7.90 |
| VVA33AS5  | 300 micron - 5 x 10 Vivids  | 50   | £8.70 |
| VA338AS5  | 380 micron - 5 x 10 Pastels | 50   | £8.90 |

| Charta Assorted Coloured Card Packs<br>SRA2 (450mm x 640mm) |                             |      |       |
|---|-----------------------------|------|-------|
| Ideal for all types of craft projects.                      |                             |      |       |
| ORDER CODE  | DESCRIPTION                 | PACK | PRICE |
| 812045AS  | 300 micron - 1 x 10 Pastels | 10   | £2.05 |
| VS23AS5   | 300 micron - 5 x 10 Pastels | 50   | £9.00 |
| VVS23AS5  | 300 micron - 5 x 10 Vivids  | 50   | £9.50 |

| Charta Assorted Coloured Card Packs<br>Royal (520mm x 640mm) |                              |      |        |
|--|------------------------------|------|--------|
| Ideal for all types of craft projects.                       |                              |      |        |
| ORDER CODE   | DESCRIPTION                  | PACK | PRICE  |
| VR23AS1  | 230 micron - 10 x 10 Pastels | 100  | £18.55 |



|                 |
|-----------------|
| Deep Blue       |
| Celestial Blue  |
| Jade            |
| Emerald Green   |
| Silver Grey     |
| Pink            |
| Red             |
| Orange          |
| Gold            |
| Daffodil        |
| Sunlight Yellow |
| Cream Vellum    |
| Ivory           |
| White           |
| Navy Blue       |
| Cobalt Blue     |
| Lime Green      |
| Dark Green      |
| Forest Green    |
| Black           |
| Dark Grey       |
| Violet          |
| Tangerine       |
| Rust            |
| Raspberry       |

**A**

| Charta Laminating Pouches<br>Boxed in 100s |            |         |        |
|--|------------|---------|--------|
| Guaranteed for all laminating machines.    |            |         |        |
| ORDER CODE                                 | THICKNESS  | SIZE    | PRICE  |
| CLPA415                                    | 150 micron | A4      | £4.25  |
| CLPA425                                    | 250 micron | A4      | £7.65  |
| CLPA315                                    | 150 micron | A3      | £9.50  |
| CLPA325                                    | 250 micron | A3      | £15.82 |
| LP37                                       | 150 micron | A6      | £2.06  |
| LP40                                       | 250 micron | A7      | £2.37  |
| LP47                                       | 150 micron | A2 Pk50 | £25.75 |

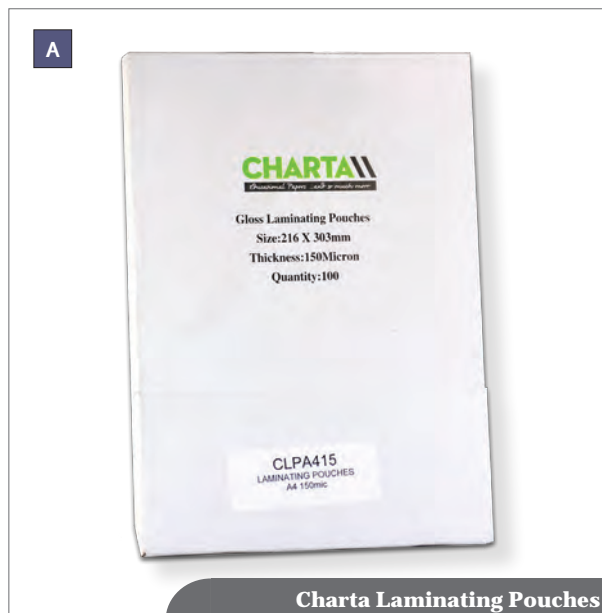

**B**

| GBC Laminating Pouches<br>Boxed in 100s |            |         |        |
|---|------------|---------|--------|
| Guaranteed for all laminating machines. |            |         |        |
| ORDER CODE                              | THICKNESS  | SIZE    | PRICE  |
| 3740400                                 | 150 micron | A4      | £5.51  |
| 3200723                                 | 250 micron | A4      | £8.75  |
| 3200745                                 | 150 micron | A3      | £10.61 |
| 3200725                                 | 250 micron | A3      | £18.02 |
| 3740451                                 | 150 micron | A5      | £7.83  |
| 3200749                                 | 250 micron | A5      | £12.26 |
| 3740300                                 | 250 micron | 54x86mm | £4.79  |
| 3740491                                 | 200 micron | A4      | £23.28 |



| GBC Laminating Pouch Carriers                 |                   |      |       |
|---|-------------------|------|-------|
| Fully guaranteed for all laminating machines. |                   |      |       |
| ORDER CODE                                    | DESCRIPTION       | SIZE | PRICE |
| EK04000                                       | GBC Pouch Carrier | A4   | £3.71 |
| EK03000                                       | GBC Pouch Carrier | A3   | £6.08 |

| GBC Laminating Machines<br>Boxed Each |   |                  |         |
|---------------------------------------|---|------------------|---------|
| Great for any laminating pouches.     |   |                  |         |
| ORDER CODE                            | DESCRIPTION                                     | SIZE             | PRICE   |
| <b>C</b> 4400304                      | GBC Inspire Laminator                           | A4               | £19.99  |
| <b>D</b> 4400305                      | GBC Inspire Laminator <b>REDUCED</b>            | A3               | £30.99  |
| <b>E</b> 4400747                      | GBC Fusion Laminator Ref 1100L                  | A3               | £79.80  |
| <b>F</b> 4400749                      | GCB Fusion Laminator Ref 3000L                  | A3               | £92.30  |
| <b>G</b> 4400750                      | GCB Fusion Laminator Ref 3100L                  | A3               | £111.68 |
| <b>H</b> 4400751                      | GCB Fusion Laminator Ref 5000L                  | A3               | £150.25 |
| <b>I</b> 4400752                      | GCB Fusion Laminator Ref 5100L                  | A3               | £173.80 |
| <b>J</b> 1701660                      | GCB RollSeal Ultima 35 Ezload Roll              | Roll 305mm       | £399.00 |
| 3400931EZ                             | Laminating Film for Ultima 35 Ezload 25mic Pk 2 | Roll 305mm x 60m | £44.75  |





GBC Laminating Machine

Minimum order value of £50.00 ex.VAT or small order administration charge of £7.50 will apply

| Rhino Exercise Books - Value Range<br>A4 (210mm x 297mm) 60 Pages Pack of 50 |                    |             |        |
|--|--------------------|-------------|--------|
| 60gsm paper with a 225gsm manilla cover.                                     |                    |             |        |
| ORDER CODE   | DESCRIPTION        | COVER       | PRICE  |
| VRE01078-5   | Plain Unruled      | Red         | £12.25 |
| VRE01027-5   | 8mm Ruled & Margin | Light Blue  | £12.25 |
| VRE010730-5  | 8mm Ruled & Margin | Light Green | £12.25 |
| VRE01011-5   | 8mm Ruled & Margin | Red         | £12.25 |
| VRE01098-5   | 8mm Ruled & Margin | Purple      | £12.25 |
| VRE01056-5   | 8mm Ruled & Margin | Yellow      | £12.25 |
| VRE010743-5  | 5mm Squares        | Orange      | £12.25 |
| VRE010292-5  | 10mm Squares       | Yellow      | £12.25 |

| A Rhino Twinwire Books<br>Value Range - 100 Pages - Pack of 10    |                       |        |       |
|---|-----------------------|--------|-------|
| 60gsm paper with hard backed polypropylene cover, twinwire bound. |                       |        |       |
| ORDER CODE  | DESCRIPTION           | COVER  | PRICE |
| REA4  | A4 8mm Ruled & Margin | Blue   | £4.99 |
| REA5  | A5 8mm Ruled & Margin | Yellow | £2.85 |

| A1 Rhino Flip Chart<br>Value Range - 40 Leaves - Pack of 5 |               |         |       |
|--|---------------|---------|-------|
| 60gsm paper. 594mm x 841mm. Perforated at Head.            |               |         |       |
| ORDER CODE   | DESCRIPTION   | COVER   | PRICE |
| FCITMP   | Plain unruled | Printed | £9.95 |

| B Value Learn to Write Books 8" x 6½"<br>(205mm x 165mm) Pack of 100 32 Pages |                           |            |        |
|---|---------------------------|------------|--------|
| 75gsm paper with a 225gsm manilla cover.                                      |                           |            |        |
| ORDER CODE  | DESCRIPTION               | COVER      | PRICE  |
| SDXB6   | 4mm ruled centred on 15mm | Dark Green | £16.85 |

| C A4 Rhino Essentials Value Pads<br>(297mm x 210mm) 50 Leaves Pack of 10 |                    |         |       |
|--|--------------------|---------|-------|
| 60gsm paper, head bound, punched 2 holes.                                |                    |         |       |
| ORDER CODE   | DESCRIPTION        | COVER   | PRICE |
| RE4FMH   | 8mm Ruled & Margin | Printed | £4.30 |



Value Learn to Write

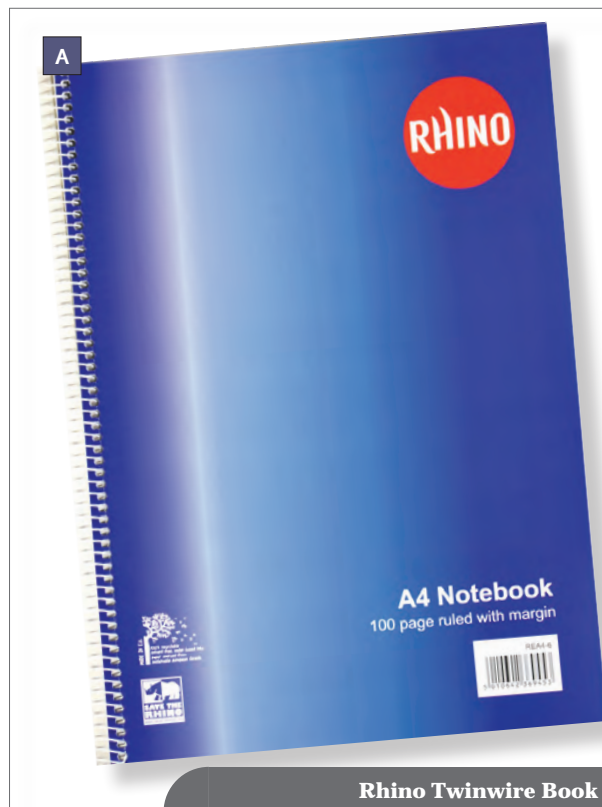

Rhino Twinwire Book



A4 Rhino Essentials Value Pad

# RYCO™

'make books last longer'

*Proud Supporter of  
Schools & Colleges*



**CLEAR  
SHIELD®**  
A RYCO® PRODUCT

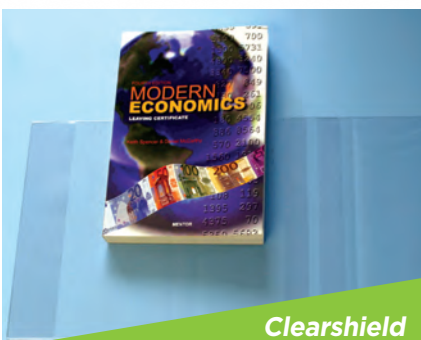

**Clearshield**  
Economical Book Cover  
Jackets in a range of sizes to  
fit every book in the Library

**POLY  
WRAP®**  
A RYCO® PRODUCT



**Polywrap**  
Low-Cost Laminate  
Rolls to protect  
School Books

**RHINO®**  
**COVERS**  
A RYCO® PRODUCT



**Rhino**  
Premium Protection for  
Paperback Books. #1 choice for  
Books in high-traffic circulation

[www.ghpkendal.co.uk](http://www.ghpkendal.co.uk)

PHONE 01539 726161

*Visit us at Stand D22 at the Education Show Birmingham, 2015*



Ryco is a leading name in the world of book protection and has become synonymous with quality and service. Our range of book covers for both paperback and hardback books are helping to preserve millions of books in the public library sector, schools and universities and books for personal use.

### Ryco Clearshield Covers

Slip-over, Reusable Book Covers, cost effective protection for paperbacks and magazines.

| ORDER CODE | DESCRIPTION   | PRICE  |
|------------|---------------|--------|
| CS166MM    | 166mm x 265mm | £15.97 |
| CS168MM    | 168mm x 265mm | £15.97 |
| CS170MM    | 170mm x 265mm | £15.97 |
| CS172MM    | 172mm x 265mm | £15.97 |
| CS174MM    | 174mm x 265mm | £15.97 |
| CS176MM    | 176mm x 265mm | £15.97 |
| CS178MM    | 178mm x 265mm | £16.97 |
| CS180MM    | 180mm x 275mm | £16.97 |
| CS182MM    | 182mm x 275mm | £16.97 |
| CS184MM    | 184mm x 275mm | £16.97 |
| CS186MM    | 186mm x 275mm | £16.97 |
| CS188MM    | 188mm x 275mm | £16.97 |
| CS190MM    | 190mm x 310mm | £17.97 |
| CS192MM    | 192mm x 310mm | £17.97 |
| CS194MM    | 194mm x 310mm | £17.97 |
| CS196MM    | 196mm x 310mm | £17.97 |
| CS198MM    | 198mm x 310mm | £17.97 |
| CS200MM    | 200mm x 310mm | £17.97 |
| CS202MM    | 202mm x 310mm | £18.98 |
| CS204MM    | 204mm x 320mm | £18.98 |
| CS206MM    | 206mm x 320mm | £18.98 |
| CS208MM    | 208mm x 320mm | £20.97 |
| CS210MM    | 210mm x 320mm | £20.97 |
| CS212MM    | 212mm x 320mm | £20.97 |
| CS214MM    | 214mm x 320mm | £20.97 |
| CS216MM    | 216mm x 320mm | £20.97 |
| CS218MM    | 218mm x 320mm | £20.97 |
| CS220MM    | 220mm x 350mm | £22.97 |
| CS222MM    | 222mm x 350mm | £22.97 |
| CS224MM    | 224mm x 350mm | £22.97 |
| CS226MM    | 226mm x 350mm | £22.97 |
| CS228MM    | 228mm x 350mm | £22.97 |
| CS230MM    | 230mm x 430mm | £22.97 |
| CS232MM    | 232mm x 450mm | £25.96 |
| CS234MM    | 232mm x 450mm | £25.96 |
| CS236MM    | 236mm x 450mm | £25.96 |
| CS238MM    | 238mm x 450mm | £25.96 |
| CS240MM    | 240mm x 450mm | £25.96 |
| CS242MM    | 242mm x 450mm | £25.96 |

### Ryco Clearshield Covers

Slip-over, Reusable Book Covers, cost effective protection for paperbacks and magazines.

| ORDER CODE | DESCRIPTION   | PRICE  |
|------------|---------------|--------|
| CS244MM    | 244mm x 450mm | £25.96 |
| CS246MM    | 246mm x 450mm | £25.96 |
| CS248MM    | 248mm x 450mm | £25.96 |
| CS250MM    | 250mm x 465mm | £28.95 |
| CS252MM    | 252mm x 465mm | £28.95 |
| CS254MM    | 254mm x 465mm | £28.95 |
| CS256MM    | 256mm x 465mm | £28.95 |
| CS258MM    | 258mm x 465mm | £28.95 |
| CS260MM    | 260mm x 465mm | £28.95 |
| CS262MM    | 262mm x 465mm | £28.95 |
| CS264MM    | 264mm x 465mm | £28.95 |
| CS266MM    | 266mm x 475mm | £30.95 |
| CS268MM    | 268mm x 475mm | £30.95 |
| CS270MM    | 270mm x 475mm | £30.95 |
| CS272MM    | 272mm x 475mm | £30.95 |
| CS274MM    | 274mm x 475mm | £30.95 |
| CS276MM    | 276mm x 475mm | £30.95 |
| CS278MM    | 278mm x 475mm | £30.95 |
| CS280MM    | 280mm x 475mm | £30.95 |
| CS282MM    | 282mm x 490mm | £32.95 |
| CS284MM    | 284mm x 490mm | £32.95 |
| CS286MM    | 286mm x 490mm | £32.95 |
| CS288MM    | 288mm x 490mm | £32.95 |
| CS290MM    | 290mm x 490mm | £32.95 |
| CS292MM    | 292mm x 490mm | £32.95 |
| CS294MM    | 294mm x 490mm | £32.95 |
| CS296MM    | 296mm x 490mm | £32.95 |
| CS298MM    | 298mm x 500mm | £34.95 |
| CS300MM    | 300mm x 500mm | £34.95 |
| CS302MM    | 302mm x 500mm | £34.95 |
| CS304MM    | 304mm x 500mm | £34.95 |
| CS306MM    | 306mm x 500mm | £34.95 |
| CS308MM    | 308mm x 500mm | £34.95 |
| CS310MM    | 310mm x 500mm | £34.95 |
| CS312MM    | 312mm x 500mm | £36.94 |
| CS314MM    | 314mm x 500mm | £36.94 |
| CS316MM    | 316mm x 500mm | £36.94 |
| CS320MM    | 320mm x 500mm | £36.94 |



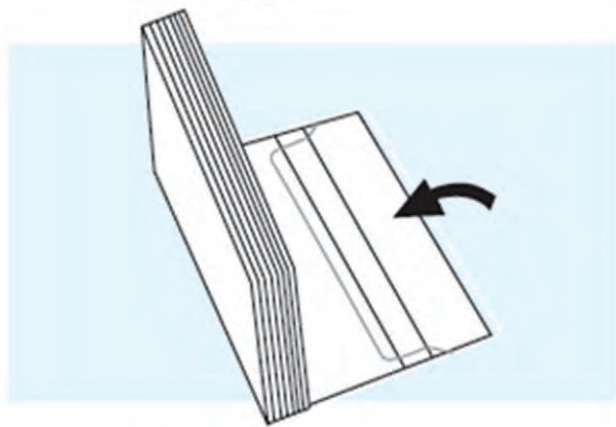
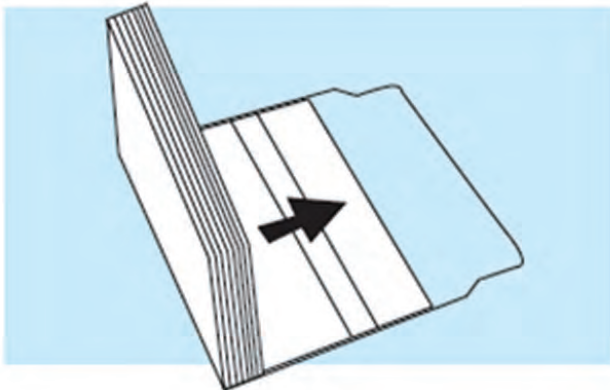
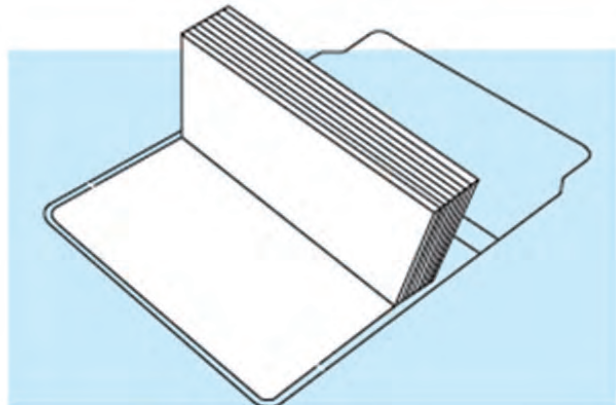
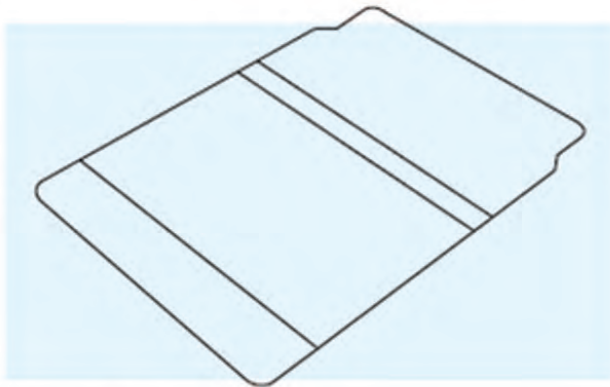

## Easy to apply adjustable paperback jackets

Minimum order value of £50.00 ex.VAT or small order administration charge of £7.50 will apply



**A**

**Ryco Self-Adhesive Adjustaroll**

4 Standard Heights available to cover virtually any size of Hardback book. Constructed from 70 Micron Clear PVC and White Kraft Paper. Made from environmentally friendly materials using solvent free adhesives.

| ORDER CODE | DESCRIPTION                       | PRICE  |
|------------|-----------------------------------|--------|
| RHP2325    | 230mm (height) x 25m (width) Roll | £12.95 |
| RHP2375    | 230mm (height) x 75m (width) Roll | £33.40 |
| RHP2725    | 275mm (height) x 25m (width) Roll | £14.42 |
| RHP2775    | 275mm (height) x 75m (width) Roll | £37.75 |
| RHP3325    | 330mm (height) x 25m (width) Roll | £16.70 |
| RHP3375    | 330mm (height) x 75m (width) Roll | £44.30 |
| RHP3825    | 380mm (height) x 25m (width) Roll | £18.55 |
| RHP3875    | 380mm (height) x 75m (width) Roll | £49.80 |



**B**

**Ryco Self-Adhesive Cotton Tape**

When applied to the inside front and back cover of a book, cotton tape strengthens the spine. We recommend using this tape in conjunction with the Ryco Book Cover range for complete protection.

| ORDER CODE | DESCRIPTION                       | PRICE  |
|------------|-----------------------------------|--------|
| CT325      | 30mm (width) x 25m (length) Roll. | £11.63 |
| CT510      | 50mm (width) x 10m (length) Roll. | £13.95 |
| CT810      | 80mm (width) x 10m (length) Roll. | £17.45 |



**C**

**Ryco Self-Adhesive Paper Tape**

Ideal for: Repairing, Reinforcing, Protecting and Covering. Strong, easy tear and non-static for ease of use and will not yellow over time. Suitable for most taping needs.

| ORDER CODE | DESCRIPTION                  | PRICE |
|------------|------------------------------|-------|
| PT250-23   | 20mm x 50m Roll. (23 micron) | £6.50 |
| PT250-68   | 20mm x 50m Roll. (68 micron) | £6.50 |



**D**

**Ryco Self-Adhesive Barcode Protectors**

Protect barcodes from moisture, fraying, smudging or damage. Our barcode protectors are scanner friendly and contain UV inhibitors.

| ORDER CODE | DESCRIPTION | Pack | PRICE  |
|------------|-------------|------|--------|
| RCLS       | 22mm x 76mm | 2000 | £30.60 |
| RCLS4375   | 46mm x 76mm | 500  | £19.80 |



**Ryco Self-Adhesive Blackboard & Greenboard Roll** E

Chalkboard self-adhesive vinyl that can be applied to any clean, smooth surface - just peel and stick. Transforms any surface into a blackboard, chalk wipes off easily and Extremely Cost effective in comparison with other black board solutions.

| ORDER CODE | DESCRIPTION           | PRICE |
|------------|-----------------------|-------|
| WBB        | 675mm x 1m Blackboard | £9.16 |
| WGB        | 675mm x 1m Greenboard | £9.16 |



**Ryco Self Adhesive Polypocket & Polycorners** F

Simple and Easy method of holding Date or Label Cards. Used in every School and County Library across the UK and Ireland. Initially Repositionable adhesive turning permanent with multiple uses and environmentally friendly.

| ORDER CODE | DESCRIPTION            | PACK | PRICE  |
|------------|------------------------|------|--------|
| PP-500     | Poly Pocket 135 x 95mm | 500  | £36.00 |
| PP-10      | Poly Pocket 135 x 95mm | 10   | £2.50  |
| PC-500     | Poly Corners 80 x 80mm | 500  | £18.50 |
| PC-8       | Poly Corners 80 x 80mm | 8    | £1.99  |



**Ryco Self-Adhesive Holographic Film Rolls** G

Shiney, Colourful Book Covering with a multitude of uses. Constructed from the highest Polypropylene (OPP) Films. Ideal for any and all Arts and Crafts Applications.

| ORDER CODE | DESCRIPTION                   | PACK | PRICE |
|------------|-------------------------------|------|-------|
| HOLOG      | Assorted colours - 330mm x 1m | 10   | £8.50 |
| HOLOR      | Rainbow - 500mm x 2m          | Each | £3.10 |
| HOLOM      | Metalized - 330mm x 1m        | Each | £3.20 |
| HOLOA      | Iridescent - 330mm x 1m       | Each | £3.80 |

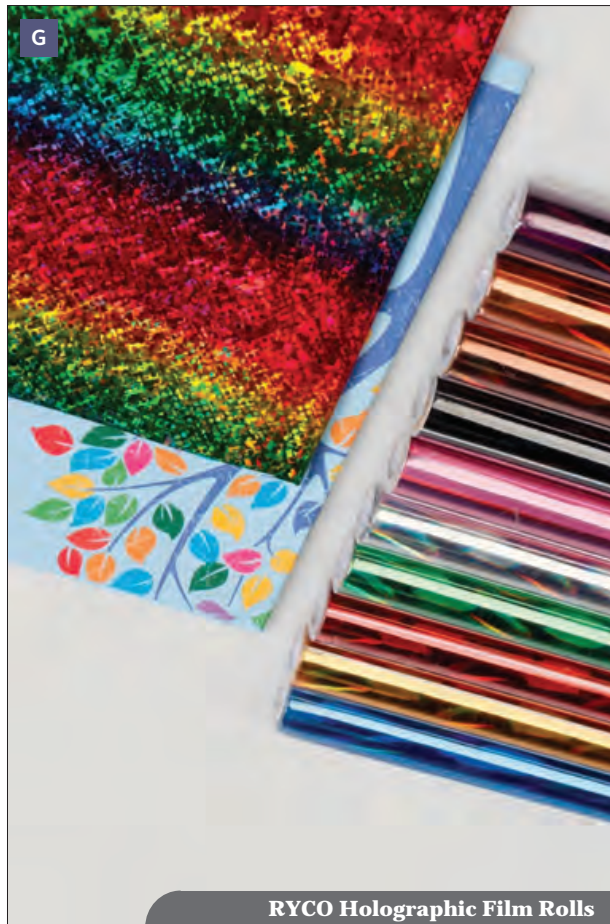

**Ryco Self-Adhesive Whiteboard Roll** H

Ideal for use with any normal white board marker. Portable and Extremely Cost effective in comparison with other White board solutions.

| ORDER CODE | DESCRIPTION                 | PRICE |
|------------|-----------------------------|-------|
| WB         | 675mm (height) x 1m (width) | £9.16 |





A

**Ryco Self-Adhesive Rhino.1 Book Covers**

Transforms Paperbacks into Virtual Hardbacks. Boxed in 100's. Excellent Protection for Paperback Books, Self-Adhesive, Semi rigid laminate covers maximize the life of paperback books. Fitted in less than 30 seconds with no air bubbles or creases. No Machine required, just a pair of scissors. Made from Solvent free adhesives that are environmentally friendly. 250 Micron made from PVC and Polyester.

| ORDER CODE | DESCRIPTION     | PACK | PRICE  |
|------------|-----------------|------|--------|
| RC-A1      | 186 mm x 270 mm | 100  | £31.35 |
| RC-B1      | 204mm x 310 mm  | 100  | £39.20 |
| RC-C1      | 222mm x 350 mm  | 100  | £50.95 |
| RC-D1      | 258mm x 410 mm  | 100  | £64.02 |
| RC-E1210   | 210mm x 510 mm  | 100  | £64.02 |
| RC-E1      | 320mm x 510 mm  | 100  | £87.55 |

A



**RYCO Rhino.1 Book Covers**

B

**Ryco Self-Adhesive Rhino.2 Book Covers**

Added Flexibility for Paperback Books of varying Spine Widths. Boxed in 100's. Excellent Protection for Paperback Books, Self-Adhesive, Semi rigid laminate covers maximize the life of paperback books. Fitted in less than 30 seconds with no air bubbles or creases. No Machine required, just a pair of scissors. Made from Solvent free adhesives that are environmentally friendly. 340 Micron made from PVC and Polyester.

| ORDER CODE | DESCRIPTION     | PACK | PRICE  |
|------------|-----------------|------|--------|
| RCH757     | 180 mm x 127 mm | 100  | £33.30 |
| RCH8565    | 218 mm x 165 mm | 100  | £43.95 |
| RCH9575    | 244 mm x 185 mm | 100  | £59.40 |
| RCH1075    | 267 mm x 209 mm | 100  | £73.65 |
| RCH1285    | 309 mm x 249 mm | 100  | £87.90 |
| RCH1251    | 318 mm x 269 mm | 100  | £91.50 |
| RCH1397    | 350 mm x 269 mm | 100  | £97.42 |

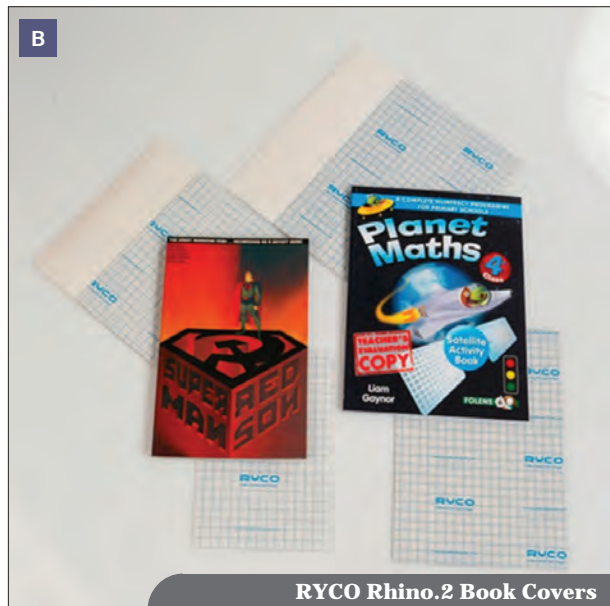

**RYCO Rhino.2 Book Covers**

C

**Ryco Self-Adhesive Retail Pack**

3 of our Rhino.1 Covers in a convenient retail pack format. Excellent Protection for Paperback Books, Self-Adhesive, Semi rigid laminate covers maximize the life of paperback books. Fitted in less than 30 seconds with no air bubbles or creases. No Machine required, just a pair of scissors. Made from Solvent free adhesives that are environmentally friendly. 250 Micron made from PVC and Polyester.

| ORDER CODE | DESCRIPTION              | PACK | PRICE  |
|------------|--------------------------|------|--------|
| RCR-S      | 225mm x 350mm Small      | 3    | £4.16  |
| RCR-M      | 258mm x 420mm Medium     | 3    | £4.99  |
| RCR-L      | 320mm x 510mm Large      | 3    | £5.82  |
| RCR-ASTD   | 3 Small 6 Medium 3 Large | 12   | £10.82 |



**RYCO Retail Pack**



**Ryco Poly Wrap Self-Adhesive Film**

| Ryco Poly Wrap Transparent Self-adhesive Film Book Covering <span style="float: right;">D</span> |                                  |        |        |
|--|----------------------------------|--------|--------|
| 50 micron gloss Wipe clean, hard wearing covering for books and otherporous surfaces.            |                                  |        |        |
| ORDER CODE   | DESCRIPTION                      | PACK   | PRICE  |
| 812036A  | 250mm x 25m                      | 1 Roll | £4.45  |
| 812036B  | 330mm x 25m                      | 1 Roll | £5.20  |
| 812036C  | 500mm x 25m                      | 1 Roll | £8.10  |
| 812036D  | 1000mm x 25m                     | 1 Roll | £15.80 |
| 812036E  | 1000m x 10m                      | 1 Roll | £5.99  |
| 04970437   | 50cm x 25m                       | 1 Roll | £11.20 |
| 605007   | Matt Self-Adhesive<br>50cm x 25m | 1 Roll | £8.15  |



**Exercise Book Covers**



**Multi-punch Pockets**

| Rhino Exercise Book Covers <span style="float: right;">F</span>      |                                |      |        |
|--|--------------------------------|------|--------|
| Heavy Duty, 250 micron PVC, fits all books, easy to fit, wipe clean. |                                |      |        |
| ORDER CODE   | DESCRIPTION                    | PACK | PRICE  |
| EB004  | Fits all A4 Exercise Books     | 100  | £26.50 |
| EB007  | Fits all 9"x7" Exercise Books  | 100  | £19.99 |
| EB010  | Fits all 8"x6½" Exercise Books | 100  | £17.99 |

| A4 Rexel Multi-punch Pockets (297mm x 210mm) Box of 100 <span style="float: right;">E</span> |               |      |       |
|--|---------------|------|-------|
| Superb quality with reinforced strip.  |               |      |       |
| ORDER CODE   | DESCRIPTION   | PACK | PRICE |
| A4MP   | Clear pockets | 100  | £2.60 |

| A Eastlight Document Wallets<br>Pack of 50                                |           |          |       |
|---|-----------|----------|-------|
| Designed to take either A4 OR Foolscap size documents.<br>Made in the UK. |           |          |       |
| ORDER CODE  | THICKNESS | COLOUR   | PRICE |
| 45913   | 215gsm    | Blue     | £4.20 |
| 45914   | 215gsm    | Green    | £4.20 |
| 45916   | 215gsm    | Orange   | £4.20 |
| 46017   | 215gsm    | Purple   | £4.20 |
| 45918   | 215gsm    | Red      | £4.20 |
| 45919   | 215gsm    | Yellow   | £4.20 |
| 45910   | 215gsm    | Assorted | £4.20 |

| B Eastlight A4 Ring Binders<br>Pack of 10                      |                |        |       |
|--|----------------|--------|-------|
| 2 rings 8cm apart, 2.5cm diameter capacity.<br>Made in the UK. |                |        |       |
| ORDER CODE   | DESCRIPTION    | COLOUR | PRICE |
| 55245  | A4 Ring Binder | Black  | £5.60 |
| 54343  | A4 Ring Binder | Blue   | £5.60 |
| 54344  | A4 Ring Binder | Green  | £5.60 |
| 54346  | A4 Ring Binder | Orange | £5.60 |
| 54347  | A4 Ring Binder | Purple | £5.60 |
| 54348  | A4 Ring Binder | Red    | £5.60 |
| 54349  | A4 Ring Binder | Yellow | £5.60 |

A



Eastlight Document Wallets

B



Eastlight A4 Ring Binders

| <b>EduCraft Extra Wide Poster Rolls</b>                           |        | <b>£4.10 per roll<br/>£30.90 per pack of 8</b> | <b>A</b> |
|---|--------|--|----------|
| (1020mm x 10m) Assorted Pack of 8 contains 1 roll of each colour. |        |  |          |
| Description   | Weight | Order Code                                     |          |
| Leaf Green  | 100gsm | PRLG   |          |
| Lemon   | 100gsm | PRL  |          |
| Purple  | 100gsm | PRPU   |          |
| Black   | 100gsm | PRBK   |          |
| Ultra Blue  | 100gsm | PRUB   |          |
| Scarlet   | 100gsm | PRS  |          |
| Orange  | 100gsm | PRO  |          |
| Sky Blue  | 100gsm | PRSB   |          |
| Assorted  | 100gsm | PRAS   |          |



Extra Wide Poster Rolls

| <b>EduCraft Fluorescent Paper Rolls &amp; Sheets</b> |                  |                |                   | <b>B</b> |
|--|------------------|----------------|-------------------|----------|
| Rolls (760mm x 10m) - <b>£4.80</b>                   |                  |                |                   |          |
| Sheets (510mm x 760mm) - <b>£6.30 Pk.25</b>          |                  |                |                   |          |
| 100gsm Paper   |                  |                |                   |          |
| Rolls  | Order Code Rolls | Sheets         | Order Code Sheets |          |
| Yellow   | FRY1             | Yellow Sheets  | AD3               |          |
| Blaze  | FRO1             | Orange Sheets  | AD4               |          |
| Green  | FRG1             | Green Sheets   | AD6               |          |
| Sunset Orange  | FRS1             | Scarlet Sheets | AD2               |          |
| Pink   | FRP1             | Pink Sheets    | AD1               |          |

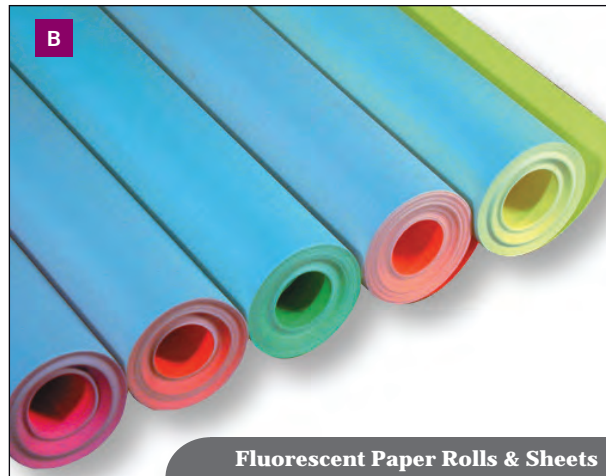

Fluorescent Paper Rolls & Sheets

| <b>Charta\ Assorted Display Paper 80gsm</b>   |          |            |      |       | <b>C</b> |
|---|----------|------------|------|-------|----------|
| Colours: Red, Orange, Yellow, Bright Green, Deep Blue, Deep Green, Lilac, Bright Blue and Candy Pink and Black.                         |          |            |      |       |          |
| Pack options are 100 sheet packs contain 10 sheets each of all 10 colours and 200 sheet packs contain 20 sheets each of all 10 colours. |          |            |      |       |          |
| Sheet Size  | Colour   | Order Code | Pack | Price |          |
| 450mm x 640mm   | Assorted | EDP        | 100  | £8.90 |          |
| 320mm x 450mm   | Assorted | EDPA3+     | 200  | £8.90 |          |
| 225mm x 320mm   | Assorted | EDPSRA4    | 200  | £4.45 |          |



Assorted Display Paper

| <b>Essential Display Paper</b>   |          |            |      |        | <b>D</b> |
|--|----------|------------|------|--------|----------|
| 120gsm Assorted Essential Display Paper. Colours: Black, Forest Green, Blue, Green, Pink, Red, Yellow, Gold, Royal Blue and Orange |          |            |      |        |          |
| Sheet Size   | Colour   | Order Code | Pack | Price  |          |
| A3 +   | Assorted | EDPA3+12   | 200  | £11.50 |          |
| SRA2   | Assorted | EDP12      | 100  | £11.50 |          |
| SRA4   | Assorted | EDPSRA412  | 200  | £5.75  |          |

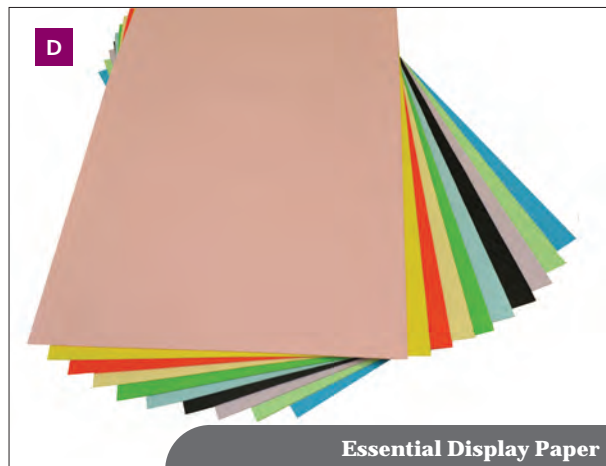





















Essential Display Paper

A

## EduCraft Poster Paper

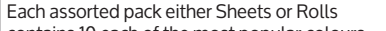
Available in 25 sheet packs, Standard 10 metre rolls and Jumbo 50 metre rolls.

|                 |  | <b>SHEETS</b><br>£3.30 Pk 25<br><b>510mm x 760mm</b> | <b>STANDARD ROLLS</b><br>£2.31 Each<br><b>760mm x 10m</b> | <b>JUMBO ROLLS</b><br>£11.00 Each<br><b>760mm x 50m</b> |
|-----------------|--|--|---|---|
| Description     | Colour   | Order Code   | Order Code  | Order Code  |
| Chocolate Brown |       | 812022CB   | S105CB  | PR5CB   |
| Lemon           |       | 812022L  | S105L   | PR5L  |
| Buttercup       |       | 812022BU   | S105BU  | PR5BU   |
| Orange          |       | 812022O  | S105O   | PR5O  |
| Scarlet         |       | 812022SC   | S105SC  | PR5SC   |
| Fire Orange     |       | 812922FO   | S105FO  | PR5FO   |
| Rose            |       | 812022RO   | S105RO  | PR5RO   |
| Candy Pink      |       | 812022CP   | S105CP  | -   |
| Lilac           |       | 812022LI   | S105LI  | PR5LI   |
| Purple          |       | 812022PU   | S105PU  | PR5PU   |
| Peppermint      |       | 812022PM   | S105PM  | -   |
| Pale Green      |       | 812022PG   | S105PG  | PR5PG   |
| Leaf Green      |       | 812022LG   | S105LG  | PR5LG   |
| Emerald Green   |      | 812022E  | S105E   | PR5E  |
| Turquoise       |     | 812022T  | S105T   | PR5T  |
| Sky Blue        |     | 812022SB   | S105SB  | PR5SB   |
| Azure Blue      |     | 812022A  | S105A   | PR5A  |
| Ultra Blue      |     | 812022UB   | S105UB  | PR5UB   |
| Black           |     | 812022BK   | S105BK  | PR5BK   |
| Orchid White    |     | 812022OW   | S105OW  | PR5OW   |
| Silver Metallic |     | 812022S  | S105S   | PR5S  |
| Gold Metallic   |     | 812022OG   | S105OG  | PR5OG   |
| Assorted        | Each assorted pack either Sheets or Rolls contains 10 each of the most popular colours | 812022AS<br>£12.30 per 100 sheet pack.               | S105AS<br>£21.75 per assorted pack of 10 rolls            | PRAS<br>£30.90 per pack of 8                            |

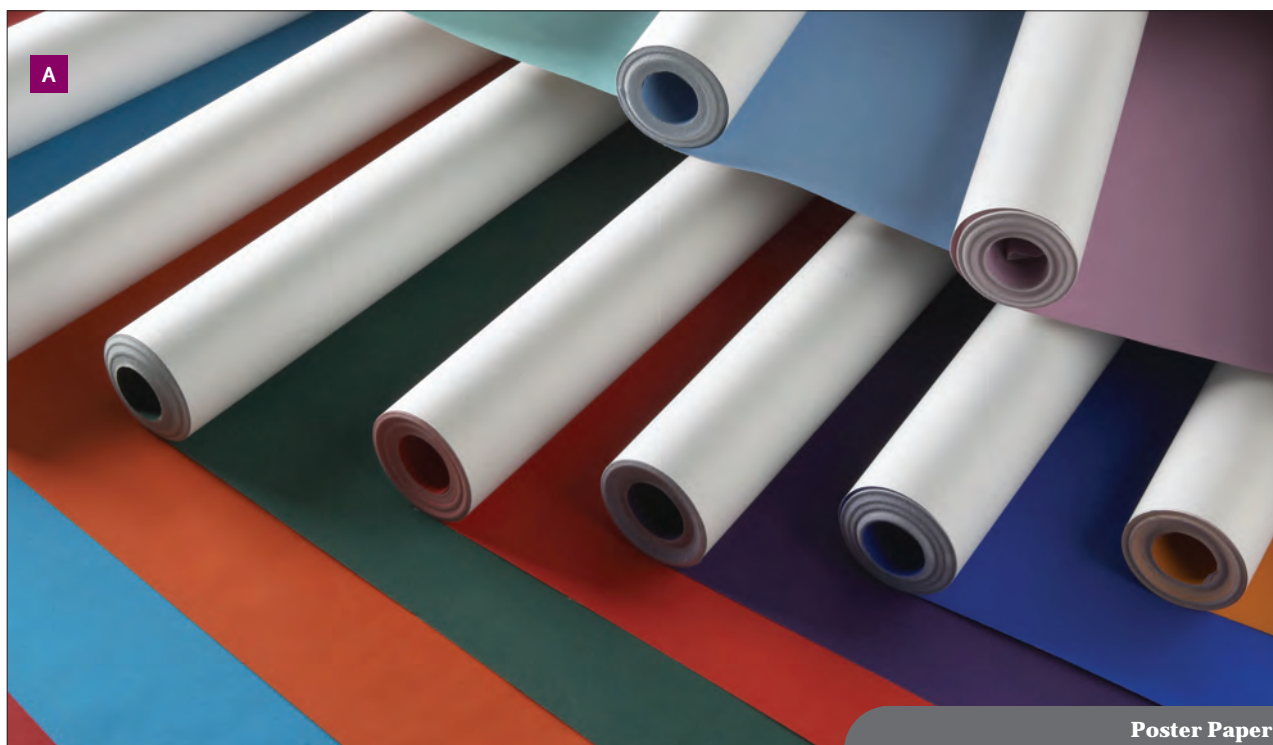

Poster Paper



**EduCraft Poster Paper**

B

For craftwork, poster, displays, painting etc. Ideal for mounting A4 and A3 artwork leaving a 40mm border all round, 10 x 10 assorted colours, Lemon, Ultra Blue, Sky Blue, Pale Green, Orange, Leaf Green, Chocolate Brown, Turquoise, Black & Scarlet.

| Sheet Size | Metroc        | Order Code | Pack | Price |
|------------|---------------|------------|------|-------|
| A4+        | 250mm x 337mm | PPASA4P    | 100  | £4.98 |
| A3+        | 337mm x 460mm | PPASA3P    | 100  | £9.90 |



Poster Paper

| EduCraft Poster Paper Assorted Sheets  |            |      | £12.70 |
|--|------------|------|--------|
| Each assorted pack of Sheets contains 10 each of the 10 most popular colours |            |      |        |
| ROLL Size  | Order Code | Pack |        |
| 20" x 30" 510mm x 760mm  | 812022AS   | 100  |        |

A

**Sugar Paper 100gsm**

All packs are 250 sheets, A4 (210 x 297mm), A3 (297 x 420mm), A2 (420 x 594mm)  
Royal (510 x 635mm), A1 (594 x 841mm)

| Description                  | Colour | A4 100gsm Order Code | A3 100gsm Order Code | A2 100gsm Order Code | Royal 100gsm Order Code | A1 100gsm Order Code |
|------------------------------|--------|----------------------|----------------------|----------------------|-------------------------|----------------------|
| Black                        |        | SPBKA411             | SPBKA311             | 812024BK1            | 52BK1                   | SPBKA111             |
| White                        |        | SPWA411              | SPWA311              | 812024W1             | 52OW1                   | SPWA111              |
| Grey                         |        | SPGYA411             | SPGYA311             | 812024GY1            | -                       | SPGYA111             |
| Price per pack of 250 sheets |        | £2.81                | £5.67                | £9.86                | £12.63                  | £18.23               |



Sugar Paper

**Sugar Paper 140gsm**

All packs are 250 sheets, A4 (210 x 297mm), A3 (297 x 420mm), A2 (420 x 594mm)

| Description                  | Colour | A4 140gsm Order Code | A3 140gsm Order Code | A2 140gsm Order Code |
|------------------------------|--------|----------------------|----------------------|----------------------|
| Black                        |        | SPBKA4141            | SPBKA3141            | 72BK1                |
| White                        |        | SPWA4141             | SPWA3141             | 72W1                 |
| Grey                         |        | SPGYA4141            | SPGYA3141            | 72GY1                |
| Price per pack of 250 sheets |        | £3.87                | £7.74                | £12.63               |

| Sugar Paper Assorted  |             |                      |                      |                      |
|---|-------------|----------------------|----------------------|----------------------|
| All packs are 250 sheets, A4 (210 x 297mm), A3 (297 x 420mm), A2 (420 x 594mm)<br>Assorted - 10 colours block collated in the following order - Red, Blue, Buff, Green, Brown, Pink, Yellow, Lilac, Orange, Grey. |             |                      |                      |                      |
| Colour  | Description | A4 140gsm Order Code | A3 140gsm Order Code | A2 140gsm Order Code |
|   | Assorted    | SPASA4141            | SPASA3141            | 74AS1                |
| Price per pack of 250 sheets  |             | £3.99                | £7.74                | £13.01               |

| Sugar Paper Assorted 100gsm   |             |                      |                      |                      |                         |                      |
|---|-------------|----------------------|----------------------|----------------------|-------------------------|----------------------|
| All packs are 250 sheets, A4 (210 x 297mm), A3 (297 x 420mm), A2 (420 x 594mm)<br>Royal (510 x 635mm), A1 (594 x 841mm)<br>Assorted - 10 cols block collated in the following order - Red, Orange, White, Lilac, Buff, Blue, Green, Grey, Pink, Yellow. |             |                      |                      |                      |                         |                      |
| Colour  | Description | A4 100gsm Order Code | A3 100gsm Order Code | A2 100gsm Order Code | Royal 100gsm Order Code | A1 100gsm Order Code |
|   | Assorted    | SPASA411             | SPASA311             | 812024AS1            | 52AS1                   | SPASA111             |
| Price per pack of 250 sheets  |             | £2.90                | £5.96                | £10.16               | £13.01                  | £18.76               |

| Frieze Paper Roll                      |        |            | Each   |
|--|--------|------------|--------|
| Frieze Paper Roll 508mm x 10m, 100gsm. |        |            |        |
| Description                            | Colour | Order Code | Price  |
| Black                                  |        | 812007BK   | £1.95  |
| Blue                                   |        | 812007B    | £1.95  |
| Cerise                                 |        | 812007C    | £1.95  |
| Emerald                                |        | 812007E    | £1.95  |
| Gold                                   |        | 812007OG   | £1.95  |
| Lime                                   |        | 812007L    | £1.95  |
| Orange                                 |        | 812007O    | £1.95  |
| Plum                                   |        | 812007PU   | £1.95  |
| Red                                    |        | 812007R    | £1.95  |
| Yellow                                 |        | 812007Y    | £1.95  |
| White                                  |        | 812007W    | £1.95  |
| 6 Assorted Rolls                       |        | 812007AS   | £10.81 |











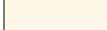
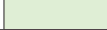









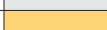



Coloured Sugar Paper

| Sugar Paper 100gsm  |        |                           |
|---|--------|---------------------------|
| Packs of 250 sheets, A4 Plus(230 x 317mm) For mounting A4 work with 20mm Border |        |                           |
| Description   | Colour | A4 Plus 100gsm Order Code |
| Black   |        | SPBKA41P1                 |
| White   |        | SPWA41P1                  |
| Price per pack of 250 sheets  |        | £3.76                     |

















| Sugar Paper 100gsm  |        |                           |
|---|--------|---------------------------|
| Packs of 250 sheets, A4 Plus(230 x 317mm) For mounting A4 work with 20mm Border |        |                           |
| Description   | Colour | A4 Plus 100gsm Order Code |
| Assorted  |        | SPASA41P1                 |
| Price per pack of 250 sheets  |        | £3.88                     |

Minimum order value of £50.00 ex.VAT or small order administration charge of £7.50 will apply

| A Centura Pearl Card |                |   | £1.65      |
|----------------------|----------------|---|------------|
| 330 Micron.          |                |   |            |
| Pack Size            | Colour         |   | Order Code |
| A4, Pack Of 5        | Accent Copper  |    | CPCACA45   |
| A4, Pack Of 5        | Accent Green   |    | CPCAGA45   |
| A4, Pack Of 5        | Accent Lilac   |    | CPCALA45   |
| A4, Pack Of 5        | Accent Red     |    | CPCARA45   |
| A4, Pack Of 5        | Black          |    | CPCBKA45   |
| A4, Pack Of 5        | Dark Chocolate |    | CPCDCA45   |
| A4, Pack Of 5        | Deep Purple    |    | CPCDPUA45  |
| A4, Pack Of 5        | Fresh Blue     |    | CPCFBA45   |
| A4, Pack Of 5        | Fresh Cream    |    | CFCFMA45   |
| A4, Pack Of 5        | Fushsia Pink   |    | CPCFPA45   |
| A4, Pack Of 5        | Fresh Pink     |    | CPCPA45    |
| A4, Pack Of 5        | Fresh White    |    | CPCWA45    |
| A4, Pack Of 5        | Golden Yellow  |    | CPCGYA45   |
| A4, Pack Of 5        | Ivory          |    | CPCIA45    |
| A4, Pack Of 5        | Lavender       |    | CPCLA45    |
| A4, Pack Of 5        | Mink           |    | CPCMIA45   |
| A4, Pack Of 5        | Old Gold       |    | CPCOGA45   |
| A4, Pack Of 5        | Platinum       |    | CPCPTA45   |
| A4, Pack Of 5        | Purple         |  | CPCPUA45   |
| A4, Pack Of 5        | Regal Blue     |  | CPCRBA45   |
| A4, Pack Of 5        | Snow White     |  | CPCSWA45   |
| A4, Pack Of 5        | Turquoise      |  | CPCTA45    |
| A4, Pack Of 5        | Xmas Green     |  | CPCXGA45   |
| A4, Pack Of 5        | Xmas Red       |  | CPCXRA45   |



| Centura Pearl Envelopes |            |             |        |
|-------------------------|------------|-------------|--------|
| 90gsm. Packed in 1,000. |            |             |        |
| Size                    | Order Code | Colour      | Price  |
| 155 x 155 mm            | CPEFW155   | Fresh White | £72.70 |
| 155 x 155 mm            | CPESW155   | Snow White  | £72.70 |
| C6                      | CPEFWC6    | Fresh White | £72.70 |
| C6                      | CPESWC6    | Snow White  | £72.70 |
| DL                      | CPEFIDL    | Fresh White | £82.50 |
| DL                      | CPESIDL    | Snow White  | £82.50 |

| B Milskin Roll   |   |            | £20.90 |
|--|---|------------|--------|
| Originally used as a covering for hard backed books. Hard wearing. Face side has a woven textured finish, the other is plain, can be wiped with a damp cloth, Ideal as a Frieze Paper. 100gsm 1020mm x 25m |   |            |        |
| Colour   |   | Order Code |        |
| Azure  |  | 8120AB     |        |
| Black  |  | 8120BK     |        |
| Bright Yellow  |  | 8120BY     |        |
| Claret   |  | 8120C      |        |
| Cherry   |  | 8120CH     |        |
| Dark Green   |  | 8120DG     |        |
| Lilac  |  | 8120L      |        |
| Leaf Green   |  | 8120LG     |        |
| Orange   |  | 8120O      |        |
| Petal  |  | 8120P      |        |
| Paris Blue   |  | 8120PB     |        |
| Pistachio  |  | 8120PI     |        |
| Sky  |  | 8120S      |        |
| Sapphire Blue  |  | 8120SB     |        |
| Violet   |  | 8120V      |        |
| White  |  | 8120W      |        |



| Construction Paper |            |           | £1.99 |
|--------------------|------------|-----------|-------|
| A5 120gsm.         |            |           |       |
| Colour             | Order Code | Pack Size |       |
| Assorted           | 9450A5     | 100       |       |



**Centura Pearl Card**

| Centura Pearl Card      |                |  |            |        |
|-------------------------|----------------|--|------------|--------|
| 330 Micron. Pack of 25. |                |  |            |        |
| Description             | Colour         |  | Order Code | Price  |
| 510 x 635mm             | Dark Chocolate |  | CPCDC      | £17.75 |
| 510 x 635mm             | Deep Purple    |  | CPCDPU     | £17.75 |
| 510 x 635mm             | Fresh Blue     |  | CPCFB      | £15.88 |
| 510 x 635mm             | Fresh Cream    |  | CPCFCM     | £15.88 |
| 510 x 635mm             | Fushsia Pink   |  | CPCFP      | £17.75 |
| 510 x 635mm             | Fresh Pink     |  | CPCFPK     | £15.88 |
| 510 x 635mm             | Fresh White    |  | CPCFW      | £15.88 |
| 510 x 635mm             | Golden Yellow  |  | CPCGY      | £15.88 |
| 510 x 635mm             | Ivory          |  | CPCI       | £15.88 |
| 510 x 635mm             | Lavender       |  | CPCL       | £15.88 |
| 510 x 635mm             | Mink           |  | CPCMI      | £15.88 |
| 510 x 635mm             | Platinum       |  | CPCPT      | £15.88 |
| 510 x 635mm             | Purple         |  | CPCPU      | £15.88 |
| 510 x 635mm             | Regal Blue     |  | CPCRB      | £17.75 |
| 510 x 635mm             | Turquoise      |  | CPCT       | £17.75 |
| 510 x 635mm             | Xmas Green     |  | CPCXG      | £17.75 |
| 510 x 635mm             | Xmas Red       |  | CPCXR      | £17.75 |
| 510 x 635mm             | Snow White     |  | CPCSW      | £18.62 |
| 510 x 635mm             | Black          |  | CPCBK      | £17.75 |



**Activity Paper**

| Kaleidoscope Activity Paper   |             |            |        |
|---|-------------|------------|--------|
| Similar to Sugar Paper but manufactured in 100gsm, Pack Of 250. Assorted - 10 colours block collated in the following order - Red, Gold, Lime, Orange, Plum, Emerald, Cerise, Yellow, Blue. |             |            |        |
| Type  | Size        | Order Code | Price  |
| A1  | 594 x 841mm | 831        | £19.35 |
| A2  | 420 x 594mm | 841        | £9.70  |
| A3  | 297 x 420mm | 851        | £5.67  |
| A4  | 210 x 297mm | 861        | £2.81  |



**Art Paper**

| Free Art Paper                                   |      | £9.25     |
|--|------|-----------|
| White Free Art Paper A2 size (420 x 594mm) 80gsm |      |           |
| Order Code                                       | Size | Pack Size |
| FA80A2   | A2   | 500       |

| Free Art Paper  |              | £8.80     |
|---|--------------|-----------|
| Generous selection of White 80gsm paper in assorted sizes, 10 kilos per pack. |              |           |
| Order Code  | Size         | Pack Size |
| FAOC  | Random Sizes | 10kg      |

| Fadeless Paper Roll           |            | £8.50 |
|-------------------------------|------------|-------|
| Assorted Colours, 609mm x 18m |            |       |
| Colour                        | Order Code |       |
| White                         | 57017      |       |
| Flame                         | 57037      |       |
| Apple Green                   | 57137      |       |
| Royal Blue                    | 57207      |       |
| Sunshine Yellow               | 57377      |       |
| Azure                         | 57167      |       |
| Black                         | 57307      |       |
| Bright Blue                   | 57177      |       |
| Magenta                       | 57347      |       |
| Nile Green                    | 57127      |       |
| Orange                        | 57107      |       |
| Pink                          | 57267      |       |
| Violet                        | 57337      |       |

| Pastel Card A3 200 Microns    |            | £6.60 |
|-------------------------------|------------|-------|
| Assorted Colours, 609mm x 18m |            |       |
| Colour                        | Order Code |       |
| Cream Vellum                  | VCVA321    |       |

| Fadeless Safari Prints          |            |        | £6.95 |
|---------------------------------|------------|--------|-------|
| Fadeless Assorted Safari Prints |            |        |       |
| Colour                          | Order Code | Packed |       |
| Assorted                        | 57770      | 24     |       |

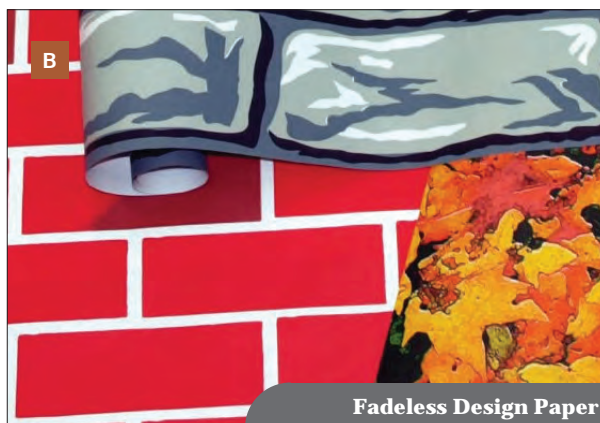

| Fadeless Display Art Paper Standard                           |            |            |            | £2.20 |
|---|------------|------------|------------|-------|
| Standard Rolls - 609mm x 3.6m. Supplied in easy dispense box. |            |            |            |       |
| Colour  | Order Code | Colour     | Order Code |       |
| White   | 57010      | Rich Blue  | 57180      |       |
| Brown   | 57020      | Royal Blue | 57200      |       |
| Flame   | 57030      | Sky Blue   | 57210      |       |
| Orange  | 57100      | Black      | 57300      |       |
| Apple Green   | 57130      | Violet     | 57330      |       |
| Azure   | 57160      | Pink       | 57260      |       |

| C Fadeless Display Art Paper Large |            |  |            | £12.75 |
|------------------------------------|------------|--|------------|--------|
| Large Rolls - 1218mm x 15m         |            |  |            |        |
| Colour                             | Order Code | Colour   | Order Code |        |
| Flame                              | 57035      | Bright Blue  | 57175      |        |
| Canary                             | 57085      | Rich Blue  | 57185      |        |
| Emerald                            | 57145      | Black  | 57305      |        |
| Cherry Red                         | 57065      | Nile Green   | 57125      |        |
| Apple Green                        | 57135      | Azure  | 57165      |        |
| Orchid                             | 57285      | Sky Blue   | 57215      |        |
| Violet                             | 57335      | <b>Please note:</b> Gold Metallic is a 7.5m length roll. |            |        |
| Purple                             | 57365      |  |            |        |
| Gold Metallic                      | 57985      |  |            |        |

| A People Coloured Cartridge                                   |            |           | £9.96 |
|---|------------|-----------|-------|
| A4 210mm x 297mm - 135gsm                                     |            |           |       |
| Each Pack contains 8 sheets Of 10 different skin tone Colour. |            |           |       |
| Colour  | Order Code | Packed    |       |
| Assorted  | PCCA4135   | 80 Sheets |       |

| B Fadeless Design Paper   |            | £4.85 |
|---|------------|-------|
| Each roll is an individual design, Assorted Colours, 1218mm x 3.6m. |            |       |
| Colour  | Order Code |       |
| Clouds  | 56468      |       |
| Tu-Tone Brick   | 56478      |       |
| Rock Wall   | 56488      |       |
| Flagstone   | 56498      |       |
| Autumn Leaves   | 5650-8     |       |
| Wood  | 56518      |       |
| Ocean   | 56528      |       |

| Educaft Creative Paper Pack                           |            |            | £3.30 |
|---|------------|------------|-------|
| A4+   |            |            |       |
| Each pack contains 10 sheets of ten different colours |            |            |       |
| Colour  | Order Code | Packed     |       |
| Assorted  | CPPA4P     | 100 Sheets |       |

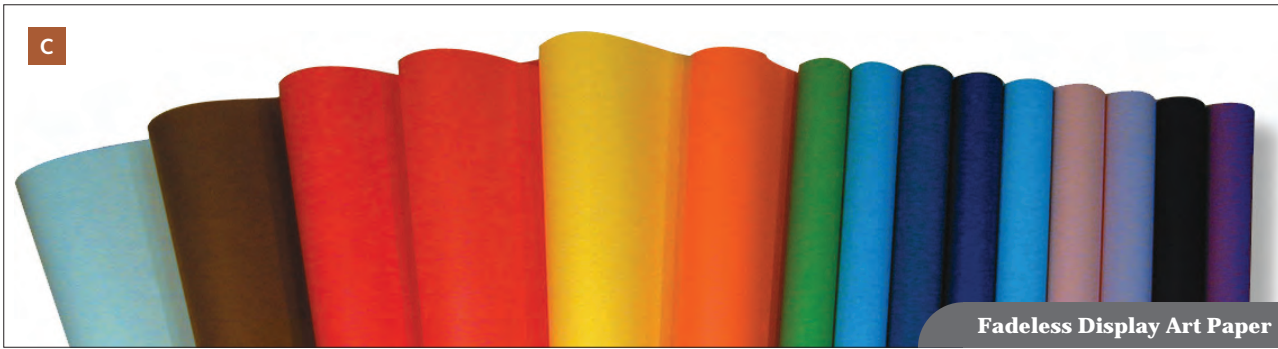

Fadeless Display Art Paper

**Recycled Coloured Card**

Assorted Bright Colours and Pastel Colours

| Weight     | Type      | Pack Of Size | Order Code | Price |
|------------|-----------|--------------|------------|-------|
| 230 Micron | A4 Pastel | 200          | RPCA423AS2 | £5.67 |
| 340 Micron | A4 Bright | 100          | RBCA4AS1   | £4.77 |
| 340 Micron | A3 Bright | 100          | RBCA3AS1   | £8.90 |

**Coloured Card 200 Microns**

| Coloured Card 200 mic. | £26.50<br>SRA2 - Pk 200 |
|------------------------|-------------------------|
| Colour                 | Order Code              |
| Cream                  | VCVS22                  |
| Deep Blue              | VDBS22                  |
| Emerald Green          | VEGS22                  |
| Pink                   | VPS22                   |
| Red                    | VRSS22                  |
| Sun Yellow             | VSYS22                  |

**Coloured Paper**

Coloured Paper 120gsm.

| Description   | Order Code | Packed | Price  |
|---------------|------------|--------|--------|
| A2 - Assorted | TA212AS1   | 100    | £7.70  |
| A2 - Assorted | TA212AS25  | 250    | £19.30 |
| A3 - Assorted | TA312AS25  | 250    | £9.70  |
| A4 - Assorted | TA412AS25  | 250    | £4.85  |

**Coloured Card 230 Microns**

|                 | £3.50<br>A4 - Pk 100 | Royal Pk 10 £1.85<br>Assorted 3.45 | £35.00<br>ROYAL - Pk 200 | £32.20<br>SRA2 - Pk 200 | £6.50<br>A4 - Pk 200 | 18.55<br>ROYAL - Pk 100 |
|-----------------|----------------------|------------------------------------|--------------------------|-------------------------|----------------------|-------------------------|
| Colour          | Order Code           | Order Code                         | Order Code               | Order Code              | Order Code           | Order Code              |
| Deep Blue       | VDBA423              | VDBR2310                           | VDBR23                   | -                       | -                    | -                       |
| Celestial Blue  | VCBA423              | VCBR2310                           | VCBR23                   | -                       | -                    | -                       |
| Jade            | VJA423               | VJR2310                            | VJR23                    | VJS223                  | -                    | -                       |
| Emerald Green   | VEGA423              | VEGR2310                           | VEGR23                   | -                       | -                    | -                       |
| Silver Grey     | VSGYA423             | VSGR2310                           | VSGR23                   | -                       | -                    | -                       |
| Pink            | VPA423               | VPR2310                            | VPR23                    | -                       | -                    | -                       |
| Red             | VRA423               | VRR2310                            | VRR23                    | -                       | -                    | -                       |
| Orange          | VOA423               | VOR2310                            | VOR23                    | VOS223                  | -                    | -                       |
| Gold            | VOGA423              | VOGR2310                           | VOGR23                   | -                       | -                    | -                       |
| Daffodil        | VDA423               | VDR2310                            | VDR23                    | VDS223                  | -                    | -                       |
| Sunlight Yellow | VSYA423              | VSYR2310                           | VSYR23                   | -                       | -                    | -                       |
| Cream Vellum    | VCVA423              | VCVR2310                           | VCVR23                   | VCVS223                 | -                    | -                       |
| Raspberry       | VRAA423              | -                                  | -                        | VRAS223                 | -                    | -                       |
| Salmon          | VSA423               | VSR2310                            | VSR23                    | -                       | -                    | -                       |
| Assorted        | -                    | 812042A                            | -                        | -                       | VA423AS              | VR23AS1                 |

Minimum order value of £50.00 ex.VAT or small order administration charge of £7.50 will apply



Adagio Coloured Card

| Adagio Colour Card    |             |       |               |               |               |        |
|-----------------------|-------------|-------|---------------|---------------|---------------|--------|
|                       | A4 - 80 gsm |       | A4 - 160 gsm  | A3 - 80 gsm   | SRA2 - 80 gsm |        |
| Colour                | Order Code  | Price | Price - £5.38 | Price - £9.52 | Order Code    | Price  |
| Ivory                 | -           | -     | -             | -             | AIS28         | £16.60 |
| Canary                | ACA481      | £4.60 | -             | -             | -             | -      |
| Chestnut              | ACBA481     | £4.60 | -             | -             | -             | -      |
| Bright Blue           | -           | -     | -             | -             | ABBS28        | £16.60 |
| Bright Green          | -           | -     | -             | -             | ABGS28        | £16.60 |
| Deep Blue             | ADBA481     | £4.60 | ADBA4161      | ADBA381       | ADBS28        | £17.40 |
| Deep Green            | ADGA481     | £4.60 | ADGA4161      | ADGA381       | ADGS28        | £17.40 |
| Lilac                 | -           | -     | -             | ALA381        | ALS28         | £17.40 |
| Fuchia Red            | AFRA481     | £4.60 | -             | -             | -             | -      |
| Orange                | AOA481      | £4.60 | AOA4161       | AOA381        | AOS28         | £17.40 |
| Pink                  | -           | -     | -             | -             | APS28         | £16.60 |
| Red                   | ARA481      | £4.60 | ARA4161       | ARA381        | ARS28         | £17.40 |
| Yellow                | AYA481      | £4.60 | AYA4161       | AYA381        | AYS28         | £17.40 |
| Gold                  | -           | -     | -             | -             | -             | -      |
| Flash Banana Yellow   | AFBA481     | £6.50 | -             | -             | -             | -      |
| Flash Kiwi Green      | AFKA481     | £6.50 | -             | -             | -             | -      |
| Flash Mandarin Orange | AFMA481     | £6.50 | -             | -             | -             | -      |
| Flash Raspberry Pink  | AFRPA481    | £6.50 | -             | -             | -             | -      |





Pastel Coloured Card

## Bespoke Paper & Card Conversion Service

*“Please call Nick Quinn for a quote if you require specifications different to those shown in our range above. We have 2 Guillotines and a new dedicated production suite. We can produce to your specification including pack sizes, card sizes and various assortments.(subject to minimum order)”*

**Tel: 01539 726161**

### Coloured Card Pastel 300 Microns

|                 | £3.60<br>A5 - Pk 100 | £3.95<br>A4 - Pk50 | £4.95<br>A4 - Pk 100 | ASS £9.00<br>SRA2 - Pk 50<br>£10.95 | £19.70<br>SRA2- Pk 100 | £2.35<br>SRA2 - Pk<br>10 ASS2.05 | £24.30<br>ROYAL<br>Pk 100 | £2.25<br>ROYAL<br>Pk 10 | £7.90<br>A3 - Pk 50 |
|-----------------|----------------------|--------------------|----------------------|-------------------------------------|------------------------|----------------------------------|---------------------------|-------------------------|---------------------|
| Colour          | Order Code           | Order Code         | Order Code           | Order Code                          | Order Code             | Order Code                       | Order Code                | Order Code              | Order Code          |
| Deep Blue       | -                    | VDBA435            | VDBA431              | VDBS235                             | VDBS23                 | VDBS2310                         | VDBR3                     | VDBR310                 | VDBA335             |
| Celestial Blue  | -                    | VCBA435            | VCBA431              | VCBS235                             | VCBS23                 | VCBS2310                         | VCBR3                     | -                       | VCBA335             |
| Jade            | -                    | VJA435             | VJA431               | VJS235                              | VJS23                  | VJS2310                          | VJR3                      | -                       | VJA335              |
| Emerald Green   | -                    | VEGA435            | VEGA431              | VEGS235                             | VEGS23                 | VEGS2310                         | VEGR3                     | VEGR310                 | VEGA335             |
| Silver Grey     | -                    | VSGA435            | VSGA431              | VSGS235                             | VSGS23                 | VSGS2310                         | VSGR3                     | -                       | VSGA335             |
| Pink            | -                    | VPA435             | VPA431               | VPS235                              | VPS23                  | VPS2310                          | VPR3                      | -                       | VPA335              |
| Red             | VRA531               | VRA435             | VRA431               | VRS235                              | VRS23                  | VRS2310                          | VRR3                      | VRR310                  | VRA335              |
| Orange          | -                    | VOA435             | VOA431               | VOS235                              | VOS23                  | VOS2310                          | VOR3                      | -                       | VOA335              |
| Gold            | -                    | VOGA435            | VOGA431              | VOGS235                             | VOGS23                 | VOGS2310                         | VOGR3                     | VOGR310                 | VOGA335             |
| Daffodil        | -                    | VDA435             | VDA431               | VDS235                              | VDS23                  | VDS2310                          | VDR3                      | VDR310                  | VDA335              |
| Sunlight Yellow | -                    | VSYA435            | VSYA431              | VSYS235                             | VSYS23                 | VSYS2310                         | VSyr3                     | -                       | VSYA335             |
| Cream           | -                    | VCVA435            | VCVA431              | VCVS235                             | VCVS23                 | VCVS2310                         | VCVR3                     | -                       | VCVA335             |
| Ivory           | VIA531               | VIA435             | VIA431               | VIS235                              | VIS23                  | VIS2310                          | VIR3                      | -                       | VIA335              |
| Buff            | -                    | -                  | -                    | -                                   | VBFS23                 | -                                | -                         | -                       | -                   |
| Salmon          | -                    | -                  | -                    | -                                   | VSS23                  | -                                | -                         | -                       | -                   |
| Assorted        | -                    | -                  | -                    | VS23AS5                             | -                      | 812045AS                         | -                         | -                       | VA33AS5             |

## Deep Coloured Card 300 Microns

|              | £3.60<br>A5 - Pk 100 | £3.95<br>A4 - Pk 50 | £4.95<br>A4 - Pk 100 | £7.90<br>A3 - Pk 50 | ASS £9.50<br>£10.95<br>SRA2 - Pk 50 | £21.40<br>SRA2 - Pk 100 | £2.35<br>SRA2 - Pk 10 | £24.30<br>ROYAL - Pk 100 |
|--------------|----------------------|---------------------|----------------------|---------------------|-------------------------------------|-------------------------|-----------------------|--------------------------|
| Colour       | Order Code           | Order Code          | Order Code           | Order Code          | Order Code                          | Order Code              | Order Code            | Order Code               |
| Navy Blue    | VNBA531              | VNBA435             | VNBA431              | VNBA335             | VNBS235                             | VNBS23                  | VNBS2310              | -                        |
| Cobalt Blue  | -                    | VCBA435             | VCBA431              | VCBA335             | VCBS235                             | VCBS23                  | VCBS2310              | -                        |
| Lime Green   | -                    | VLGA435             | VLGA431              | VLGA335             | VLGS235                             | VLGS23                  | VLGS2310              | VLGR3                    |
| Dark Green   | -                    | VDGA435             | VDGA431              | VDGA335             | VDGS235                             | VDGS23                  | VDGS2310              | -                        |
| Forest Green | VFGA531              | VFGA435             | VFGA431              | VFGA335             | VFGS235                             | VFGS23                  | VFGS2310              | -                        |
| Black        | VBKA531              | VBKA435             | VBKA431              | VBKA335             | VBKS235                             | VBKS23                  | VBKS2310              | -                        |
| Dark Grey    | -                    | VDGYA435            | VDGYA431             | VDGYA335            | VDGYS235                            | VDGYS23                 | VDGYS2310             | -                        |
| Violet       | -                    | VVA435              | VVA431               | VVA335              | VVS235                              | VVS23                   | VVS2310               | VVR3                     |
| Tangerine    | -                    | VTA435              | VTA431               | VTA335              | VTS235                              | VTS23                   | VTS2310               | VTR3                     |
| Rust         | -                    | VRUA435             | VRUA431              | VRUA335             | VRUS235                             | VRUS23                  | VRUS2310              | -                        |
| Lilac        | -                    | VLA435              | VLA431               | VLA335              | -                                   | VLS23                   | -                     | -                        |
| Assorted     | -                    | VVA43AS5            | -                    | VVA33AS5            | VVS23AS5                            | 812035AS1               | 812035AS1             | -                        |

## Coloured Card Pastel 380 Microns

|                 | A5 - Pk 100<br>Assorted - £4.95 | £4.25<br>A4 - Pk 50<br>Assorted - £4.70 | £2.95<br>Royal - Pk 10 | £27.40<br>Royal - Pk 100 | £13.50<br>SRA2 - Pk 50 | £25.10<br>SRA2 - Pk 100 | Assorted - £8.90<br>A3 - Pk 50 |
|-----------------|---------------------------------|---|------------------------|--------------------------|------------------------|-------------------------|--------------------------------|
| Colour          | Order Code                      | Order Code                              | Order Code             | Order Code               | Order Code             | Order Code              | Order Code                     |
| Celestial Blue  | -                               | VCBA4385                                | VCBR3810               | VCBR380                  | -                      | -                       | -                              |
| Cream Vellum    | -                               | VCVA4385                                | VCVR3810               | VCVR380                  | VCVS2385               | VCVS2380                | -                              |
| Daffodil        | -                               | VDA4385                                 | VDR3810                | VDR380                   | VDS2385                | VDS2380                 | -                              |
| Deep Blue       | -                               | VDBA4385                                | VDBR3810               | VDBR380                  | VDBS2385               | VDBS2380                | -                              |
| Emerald Green   | -                               | VEGA4385                                | VEGR3810               | VEGR380                  | VEGS2385               | VEGS2380                | -                              |
| Ivory           | -                               | VIA4385                                 | VIR3810                | VIR380                   | VIS2385                | VIS2380                 | -                              |
| Jade            | -                               | VJA4385                                 | VJR3810                | VJR380                   | VJS2385                | VJS2380                 | -                              |
| Orange          | -                               | VOA4385                                 | VOR3810                | VOR380                   | VOS2385                | VOS2380                 | -                              |
| Gold            | -                               | VOGA4385                                | VOGR3810               | VOGR380                  | VOGS2385               | VOGS2380                | -                              |
| Pink            | -                               | VPA4385                                 | VPR3810                | VPR380                   | VPS2385                | VPS2380                 | -                              |
| Red             | -                               | VRA4385                                 | VRR3810                | VRR380                   | VRS2385                | VRS2380                 | -                              |
| Salmon          | -                               | -                                       | -                      | VSR380                   | -                      | -                       | -                              |
| Silver Grey     | -                               | VSGA4385                                | VSGR3810               | VSGR380                  | VSGS2385               | VSGS2380                | -                              |
| Sunlight Yellow | -                               | VSYA4385                                | VSYR3810               | VSYR380                  | VSYS2385               | VSYS2380                | -                              |
| Lilac           | -                               | -                                       | -                      | -                        | -                      | VLS2380                 | -                              |
| Assorted        | VA538AS1                        | VA438AS5                                | -                      | -                        | -                      | -                       | VA338AS5                       |

| Coloured Card Pastel 750 Microns |                                      |  |                                       |
|----------------------------------|--------------------------------------|--|---------------------------------------|
|                                  | £7.50<br>A4 - Pk 50 - assorted £8.25 | £6.90<br>Royal (520 x 640mm) - Pk 10 ASS7.20 | £31.40<br>Royal ( 520 x 640mm)- Pk 50 |
| Colour                           | Order Code                           | Order Code                                   | Order Code                            |
| Buff                             | VBFA4755                             |  | VBFR750                               |
| Daffodil                         | VDA4755                              | VDR7510                                      | VDR750                                |
| Deep Blue                        | VDBA4755                             | VDBR7510                                     | VDBR750                               |
| Emerald Green                    | VEGA4755                             | VEGR7510                                     | VEGR750                               |
| Red                              | VRA4755                              | VRR7510                                      | VRR750                                |
| Assorted                         | VA475AS5                             | 812051                                       | -                                     |



| Cumbria Coloured Card 135gsm |            |       |
|------------------------------|------------|-------|
| A4 Coloured Card Pack Of 10. |            |       |
| Colour                       | Order Code | Price |
| Adriatic                     | CAA41351   | £1.88 |
| Bagdad Brown                 | CBBA41351  | £1.88 |
| Forest Green                 | CFA41351   | £1.88 |
| Mid Green                    | CMGA41351  | £1.88 |
| Nubuck Brown                 | CNBA41351  | £1.88 |
| Scarlet                      | CSA41351   | £1.88 |
| Violet                       | CVA41351   | £1.88 |
| Vermilion                    | CVNA41351  | £1.88 |

| Cumbria Coloured Card 270gsm |            |       |
|------------------------------|------------|-------|
| A4 Coloured Card Pack Of 5   |            |       |
| Colour                       | Order Code | Price |
| Bagdad Brown                 | CBBA4275   | £1.88 |
| Forest Green                 | CFA4275    | £1.88 |
| Mid Green                    | CMGA4275   | £1.88 |
| Nubuck Brown                 | CNBA4275   | £1.88 |
| Purple                       | CPUA4275   | £1.88 |
| Scarlet                      | CSCA4275   | £1.88 |
| Vermilion                    | CVA4275    | £1.88 |
| Stone                        | CSTA475    | £1.88 |

| Assorted Coloured Card       |                       | 100 Sheets |
|------------------------------|-----------------------|------------|
| A4 Coloured Card, 200 micron |                       |            |
| Colour                       | Order Code            | Price      |
| Vivid Assorted               | IQDA4AS1 - 5 Colours  | £2.40      |
| Pastel Assorted              | IQDA4AS2 - 10 Colours | £3.96      |

| Recycled Coloured Card 230gsm              |            |       |
|--|------------|-------|
| SRA2 Recycled Coloured Card , Pack of 100. |            |       |
| Colour                                     | Order Code | Price |
| Assorted                                   | RPCS223AS1 | £8.45 |

Minimum order value of £50.00 ex.VAT or small order administration charge of £7.50 will apply

|   |                   |                  |
|---|-------------------|------------------|
| <b>Rainbow Shaded Glossy Paper</b>      |                   | <b>£5.28</b>     |
| Rainbow Shaded Glossy Paper 500 x 700mm |                   |                  |
| <b>Colour</b>                           | <b>Order Code</b> | <b>Pack Size</b> |
| Rainbow                                 | 1410R             | 10               |

|                                       |                   |              |
|---------------------------------------|-------------------|--------------|
| <b>Fadeless Metallic Rolls</b>        |                   | <b>£3.40</b> |
| Assorted Metallic rolls, 610mm x 2.4m |                   |              |
| <b>Colour</b>                         | <b>Order Code</b> |              |
| Silver                                | 57970             |              |
| Gold                                  | 57980             |              |

|                                       |                   |               |
|---------------------------------------|-------------------|---------------|
| <b>Fadeless Assorted Paper Sheets</b> |                   | <b>£18.80</b> |
| 609mm x 750mm, Pack Of 50             |                   |               |
| <b>Colour</b>                         | <b>Order Code</b> |               |
| Assorted                              | 57XXAS            |               |



| <b>Coloured Card Mirri Finish 250gsm</b> |                            |                              |                                |
|--|----------------------------|------------------------------|--------------------------------|
|  | <b>£9.25</b><br>A4 - Pk 40 | <b>£9.25</b><br>SRA2 - Pk 10 | <b>£92.50</b><br>SRA2 - Pk 100 |
| <b>Colour</b>                            | <b>Order Code</b>          | <b>Order Code</b>            | <b>Order Code</b>              |
| Matt Gold                                | LOGA4251                   | LOGS2251                     | LOGS225100                     |
| Matt Silver                              | LSA4251                    | LSS2251                      | LSS225100                      |

|  |                           |                               |
|--|---------------------------|-------------------------------|
| <b>B Coloured Card Mirri Finish 270gsm</b> |                           |                               |
|  | <b>£3.40</b><br>A4 - Pk 5 | <b>£31.00</b><br>SRA2 - Pk 25 |
| <b>Colour</b>                              | <b>Order Code</b>         | <b>Order Code</b>             |
| Blue                                       | MHBA4275                  | MHBS2271                      |
| Black                                      | MHBKA4275                 | MHBKS2271                     |
| Copper                                     | MHCA4275                  | MHCS2271                      |
| Green                                      | MHGA4275                  | MHGS2271                      |
| Gunmetal                                   | MHGMA4275                 | MHGMS2271                     |
| Gold                                       | MHOGA4275                 | MHOGS2271                     |
| Purple                                     | MHPA4275                  | MHPS2271                      |
| Pink                                       | MHPKA4275                 | MHPKS2271                     |
| Red  | MHRA4275                  | MHRS2271                      |
| Silver                                     | MHSA4275                  | MHS2271                       |
| Silk Red                                   | MHSRA4295 290gsm          | MHSRS2291 290gsm              |



| Matt White Drawing Cartridge - 100gsm   |            |        |                |
|---|------------|--------|----------------|
| <p>Superb quality and value drawing cartridge, available in all popular Sizes and Weights. There are three finishes to choose from including 100 % Recycled Matt. Refer to the diagram for Size comparison.<br/>Matt 100g/m</p> |            |        |                |
| Size  | Order Code | Packed | Price Per Pack |
| A4  | 812059F1   | 500    | £4.20          |
| A3  | 812059E1   | 500    | £8.35          |
| A2  | 812059D1   | 500    | 19.65          |
| A1  | 812059C1   | 250    | 16.65          |

| 100% Recycled White Drawing Cartridge - 140gsm |            |        |                |
|--|------------|--------|----------------|
| <p>Recycled Matt 140g/m</p>                    |            |        |                |
| Size   | Order Code | Packed | Price Per Pack |
| A4   | 8120PU51   | 500    | £8.05          |
| A3   | 8120PU41   | 500    | £16.00         |
| A3   | 8120PU4125 | 250    | £8.05          |
| A2   | 8120PU21   | 500    | £31.92         |
| A1   | 8120PU11   | 250    | £31.92         |

| Matt White Drawing Cartridge - 130gsm   |            |        |                |
|---|------------|--------|----------------|
| <p>Superb quality and value drawing cartridge, available in all popular Sizes and Weights. There are three finishes to choose from including 100 % Recycled Matt. Refer to the diagram for Size comparison.<br/>Matt 130g/m</p> |            |        |                |
| Size  | Order Code | Packed | Price Per Pack |
| A4  | 812058G1   | 500    | £6.05          |
| A3  | 812058F1   | 500    | £12.05         |
| A2  | 812058E1   | 500    | £24.10         |
| A1  | 812058D1   | 250    | £24.10         |

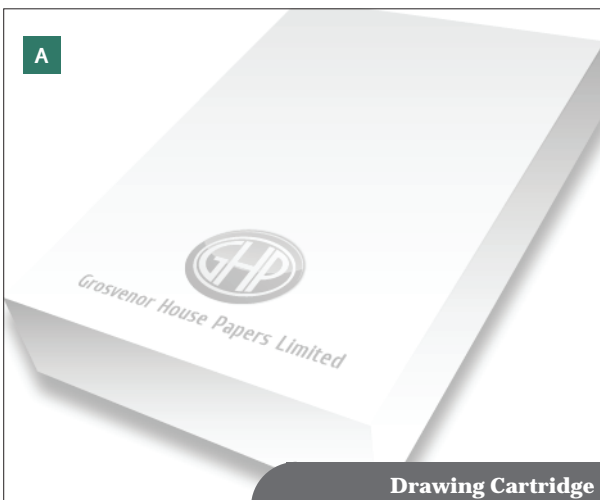

| Drawing Cartridge |            |        |        |                |
|-------------------|------------|--------|--------|----------------|
| White Cartridge.  |            |        |        |                |
| Type              | Order Code | Weight | Packed | Price Per Pack |
| A1                | 9200       | 85gsm  | 250    | £17.30         |
| A2                | GHP9210    | 85gsm  | 250    | £8.65          |
| A3                | GHP9220    | 85gsm  | 250    | £4.35          |
| A1                | 812060H1   | 90gsm  | 250    | £17.30         |
| A1                | SDCA111    | 100gsm | 250    | £17.12         |
| A2                | SDCA211    | 100gsm | 500    | £17.12         |
| A3                | SDCA311    | 100gsm | 250    | £4.30          |
| A4                | SDCA411    | 100gsm | 500    | £4.30          |
| A1                | SDCA11151  | 120gsm | 250    | £20.55         |
| A2                | SDCA21151  | 120gsm | 500    | £20.55         |
| A3                | SDCA31151  | 120gsm | 500    | £10.25         |
| A4                | SDCA41151  | 120gsm | 500    | £5.12          |
| A1                | SDCA1131   | 140gsm | 250    | £23.95         |
| A2                | SDCA2131   | 140gsm | 500    | £23.95         |
| A3                | SDCA3131   | 140gsm | 500    | £11.96         |
| A4                | SDCA4131   | 135gsm | 250    | £2.99          |
| A2                | SDCA21351  | 135gsm | 500    | £24.75         |
| A3                | SDCA31351  | 135gsm | 500    | £12.38         |
| A4                | SDCA41351  | 135gsm | 500    | £6.20          |



A

## Black Card

550gsm

| Size | Order Code | Packed | Price Per Pack |
|------|------------|--------|----------------|
| SRA1 | BKS1550-10 | 10     | £8.20          |

## Black Card

270gsm

| Size | MM        | Order Code | Packed | Price Per Pack |
|------|-----------|------------|--------|----------------|
| A4   | 210 x 297 | BKA4271    | 100    | £5.42          |
| A3   | 297 x 420 | BKA3271    | 100    | £11.10         |
| A2   | 420 x 594 | BKA2251    | 100    | £14.12         |
| A1   | 594 x 840 | BKA1271    | 50     | £17.55         |

## Black Card

300mic

| Weight | Order Code | Packed | Price Per Pack |
|--------|------------|--------|----------------|
| A4     | VBKA435    | 50     | £3.95          |
| A4     | VBKA431    | 100    | £4.95          |
| A3     | VBKA335    | 50     | £7.90          |
| SRA2   | VBKS2310   | 10     | £2.35          |
| SRA2   | VBKS235    | 50     | £10.95         |
| SRA2   | VBKS23     | 100    | £19.70         |



**FREE DELIVERY**  
min orders over £50

A

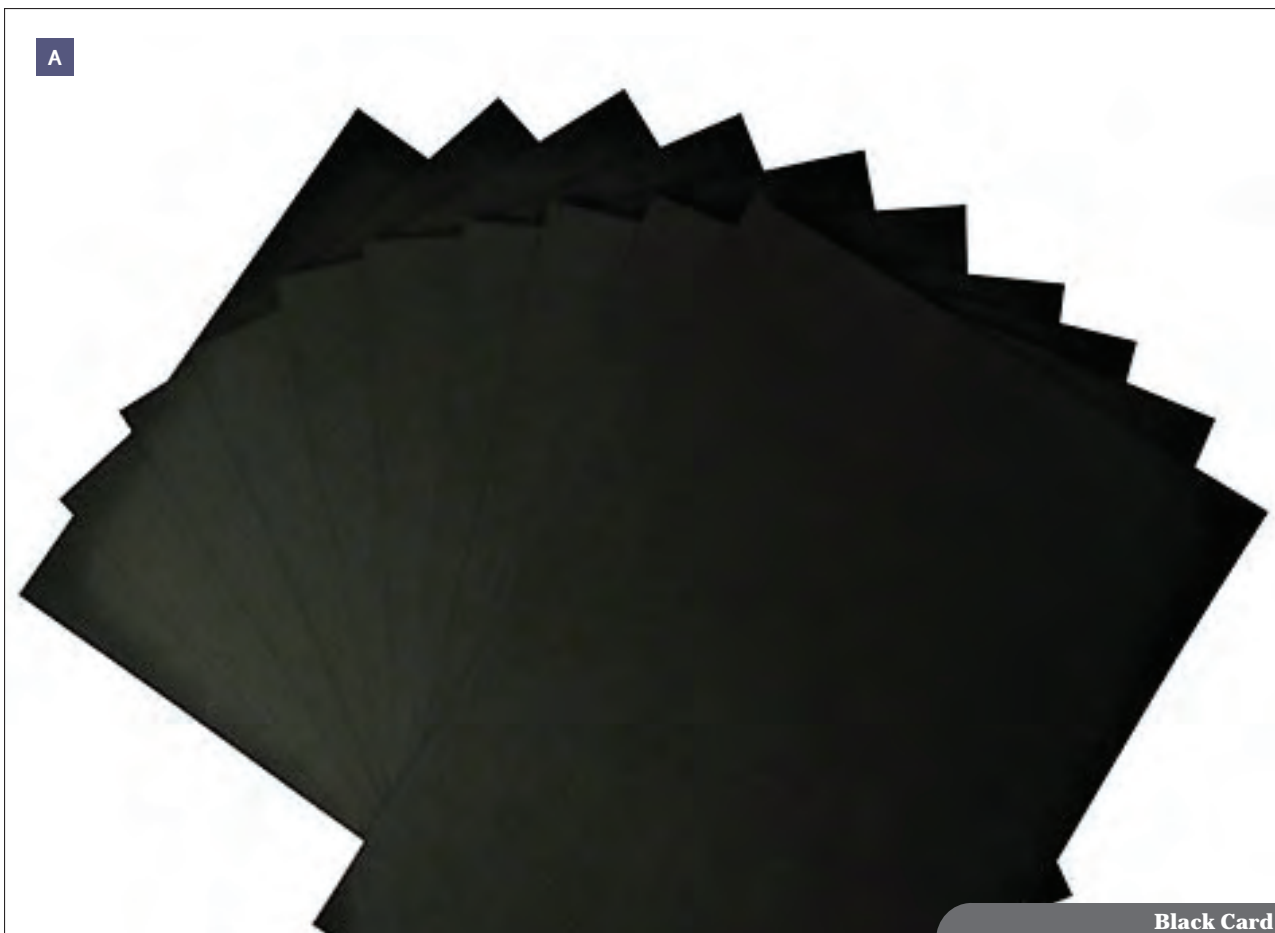

Black Card

**White Card - A5**

148mm x 210mm

| Thickness   | Order Code | Packed | Price Per Pack |
|-------------|------------|--------|----------------|
| 280 Microns | FWA5281    | 100    | £1.75          |
| 380 Microns | FWA5381    | 100    | £2.65          |
| 580 Microns | VWA5581    | 100    | £4.35          |

**White Card - A4**

210mm x 297mm

| Thickness   | Order Code | Packed | Price Per Pack |
|-------------|------------|--------|----------------|
| 200 Microns | FWA421     | 200    | £4.25          |
| 230 Microns | FWA423     | 100    | £2.25          |
| 230 Microns | FWA4231    | 200    | £4.99          |
| 280 Microns | FWA4285    | 50     | £1.75          |
| 380 Microns | FWA4385    | 50     | £2.65          |
| 280 Microns | FWA4281    | 100    | £3.52          |
| 280 Microns | FWA4282    | 200    | £6.99          |
| 380 Microns | FWA4381    | 100    | £5.20          |
| 500 Microns | VWA4435    | 50     | £3.60          |
| 580 Microns | VWA4585    | 50     | £4.35          |
| 580 Microns | VWA4581    | 10     | £0.95          |
| 750 Microns | VWA4751    | 10     | £1.15          |
| 750 Microns | VWA475     | 50     | £5.65          |

**White Card - A3**

297 x 420mm

| Thickness   | Order Code | Packed | Price Per Pack |
|-------------|------------|--------|----------------|
| 230 Microns | FWA3231    | 100    | £4.85          |
| 280 Microns | FWA3285    | 50     | £3.52          |
| 280 Microns | FWA3281    | 100    | £6.99          |
| 380 Microns | FWA3385    | 50     | £5.65          |
| 500 Microns | VWA3435    | 50     | £7.80          |
| 580 Microns | VWA3585    | 50     | £9.40          |
| 750 Microns | VWA3755    | 50     | £11.10         |

**White Card - A2**

420 x 594mm

| Thickness  | Order Code | Packed | Price Per Pack |
|------------|------------|--------|----------------|
| 230 Micron | FWA223BP1  | 100    | £7.05          |
| 280 Micron | FWA228BP1  | 100    | £9.80          |

**White Card - SRA2**

450 x 640mm

| Thickness   | Order Code | Packed | Price Per Pack |
|-------------|------------|--------|----------------|
| 230 Microns | FWS2231    | 100    | £9.40          |
| 230 Microns | FWS2232    | 200    | £18.75         |
| 280 Microns | FWS2285    | 50     | £5.75          |
| 280 Microns | FWS2282    | 200    | £23.10         |
| 380 Microns | FWS23810   | 10     | £2.30          |
| 380 Microns | FWS2381    | 100    | £18..10        |
| 430 Microns | VWS243     | 100    | £28.60         |
| 500 Microns | VWS24310   | 10     | £4.60          |
| 750 Microns | VWS275     | 50     | £22.20         |

**White Card - Royal**

520mm x 640mm.

| Thickness   | Order Code | Packed | Price Per Pack |
|-------------|------------|--------|----------------|
| 230 Microns | FWR232     | 200    | £21.63         |
| 230 Microns | FWR231     | 100    | £10.85         |
| 230 Microns | 812041A    | 10     | £1.60          |
| 280 Microns | FWR282     | 200    | £26.75         |
| 280 Microns | FWR281     | 100    | £13.40         |
| 280 Microns | 812044     | 10     | £1.99          |
| 380 Microns | FWR381     | 100    | £18.20         |
| 380 Microns | 812046A    | 10     | £2.70          |
| 430 Microns | VWR43      | 100    | £33.20         |
| 580 Microns | VWR58      | 100    | £39.99         |
| 580 Microns | 812049     | 10     | £6.75          |
| 750 Microns | VWR75      | 50     | £25.65         |
| 750 Microns | 812050     | 10     | £8.65          |

**White Card - B1****£43.70**

700 x 1000mm

| Colour | Order Code | Pack Size |
|--------|------------|-----------|
| White  | VWB1300    | 100       |



Parchmarque Parchment Paper & Card

| A Parchmarque Parchment Paper & Card |   |   |
|--------------------------------------|---|---|
|                                      | A4 Paper<br>£63.45<br>Pack Of 500 90g/m | A4 Card<br>£49.28<br>Pack Of 250 176g/m |
| Colour                               | Order Code                              | Order Code                              |
| Bright White                         | PMBWA491                                | PMBWA41761                              |
| Natural                              | PMNA491                                 | PMNA41761                               |
| Champagne                            | PMCA491                                 | PMCA41761                               |

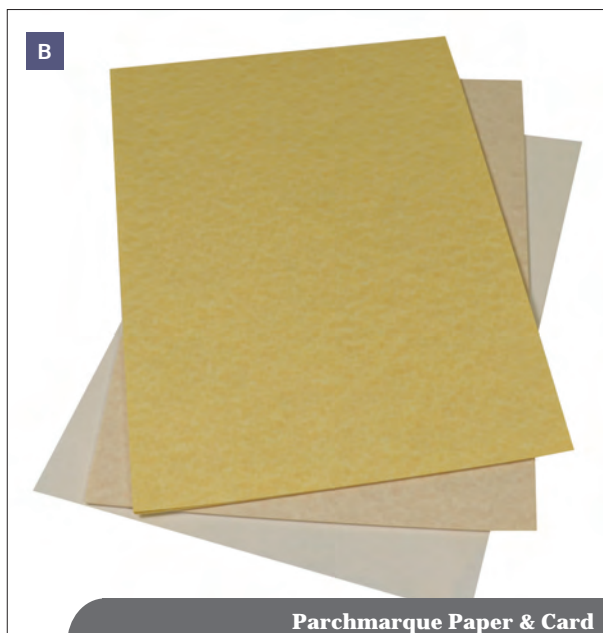

Parchmarque Paper & Card

| B Parchmarque Paper & Card |                                       |                                       |
|----------------------------|---------------------------------------|---------------------------------------|
|                            | A4 Paper<br>£4.10<br>Pack Of 20 90g/m | A4 Card<br>£3.20<br>Pack Of 10 176g/m |
| Colour                     | Order Code                            | Order Code                            |
| Bright White               | PMBWA4920                             | PMBWA417610                           |
| Champagne                  | PMCA4920                              | PMCA417610                            |
| Natural                    | PMNA4920                              | PMNA417610                            |

| Marlmarque Parchment Paper & Card                      |  |   |
|--|--|---|
| Available in 90g/m and 200g/m Weights and in 7 colours |  |   |
|  | A4 Paper<br>£45.90<br>Pack Of 500<br>90g/m | A4 Card<br>£40.25<br>Pack Of 250 200g/m |
| Colour   | Order Code                                 | Order Code                              |
| Marble White   | MMWA491                                    | MMWA421                                 |
| Olympic Ivory  | MOIA491                                    | MOIA421                                 |
| Grecian Tan  | MGTA491                                    | MGTA421                                 |
| Aegean Blue  | MABA491                                    | MABA421                                 |



Assorted Certificate Paper

| C Assorted Certificate Paper  |          |            | £38.88<br>Per Pack |
|---|----------|------------|--------------------|
| 100 sheets Each Champagne, Pewter and Natural (Gold, Silver & Bronze) |          |            |                    |
| Description   | Colour   | Order Code | Pack Size          |
| Certificate Paper   | Assorted | PMCPA49    | 300 Sheets         |

| Laid Paper   |            | £8.99 |
|--|------------|-------|
| Laid Paper ideal for Letterheads, Menus or any prestigious documents A4, 100gsm Pack Of 500. |            |       |
| Colour   | Order Code |       |
| Vellum   | SHLVA411   |       |
| White  | SHLWA411   |       |



| School Mounting Pack <span style="float: right;">D</span> |                  |  |       |
|---|------------------|--|-------|
| All packs come with assorted colours.                     |                  |  |       |
| Order Code  | Size             | Packed   | Price |
| PPASA3P   | A3 + 460 x 337mm | 100 Sheets   | £9.90 |
| PPASA4P   | A4+ 250 x 337mm  | 100 Sheets   | £4.98 |
| SMP   | 320mm x 317mm    | 30 sheets Of Black PLUS 30 sheets Assorted Colours | £4.20 |



| Pre-cut Mat Frames <span style="float: right;">E</span> |            |                          | £16.20 |
|---|------------|--------------------------|--------|
| Assorted Colours and Sizes                              |            |                          |        |
| Colour  | Order Code | Packed                   |        |
| Assorted  | 72550      | 60 Asst. Sizes & Colours |        |

| Colourmount Mounting Boards <span style="float: right;">F</span>  |        |            | £7.25 |
|---|--------|------------|-------|
| Ideal for Display, Mounting work or Picture Framing, 1250 micron in Packs of 5 Boards .Available in 90g/m and 176g/m Weights and in 8 colours |        |            |       |
| Description   | Colour | Order Code |       |
| Ivory   |        | 981I5      |       |
| Smoke Grey  |        | 981SGY5    |       |
| Bottle Green  |        | 981BG5     |       |
| Oxford Blue   |        | 981OB5     |       |
| Bluebell  |        | 981BB5     |       |
| Burgundy  |        | 981B5      |       |
| White   |        | 981W5      |       |
| Black   |        | 981BK5     |       |
| Black 2 Sided   |        | 981BK25    |       |
| Charcoal  |        | 981C5      |       |

| Foam Centered Boards <span style="float: right;">G</span> |            |       |
|---|------------|-------|
| Individual White Foam Centred Boards - 5mm thickness      |            |       |
| Size  | Order Code | Price |
| A0  | 03501010   | £8.10 |
| A1  | 03501110   | £3.95 |
| A2  | 03501220   | £2.10 |
| A3  | 03501310   | £1.50 |
| A4  | 03501420   | £1.20 |



| Poster Board Classpack <span style="float: right;">£33.25</span> |            |             |        |
|--|------------|-------------|--------|
| Pack of 50 sheets of assorted 270gsm poster board - pack of 50   |            |             |        |
| Colour   | Order Code | Size        | Packed |
| Assorted   | 76347      | 558 x 710mm | 50     |

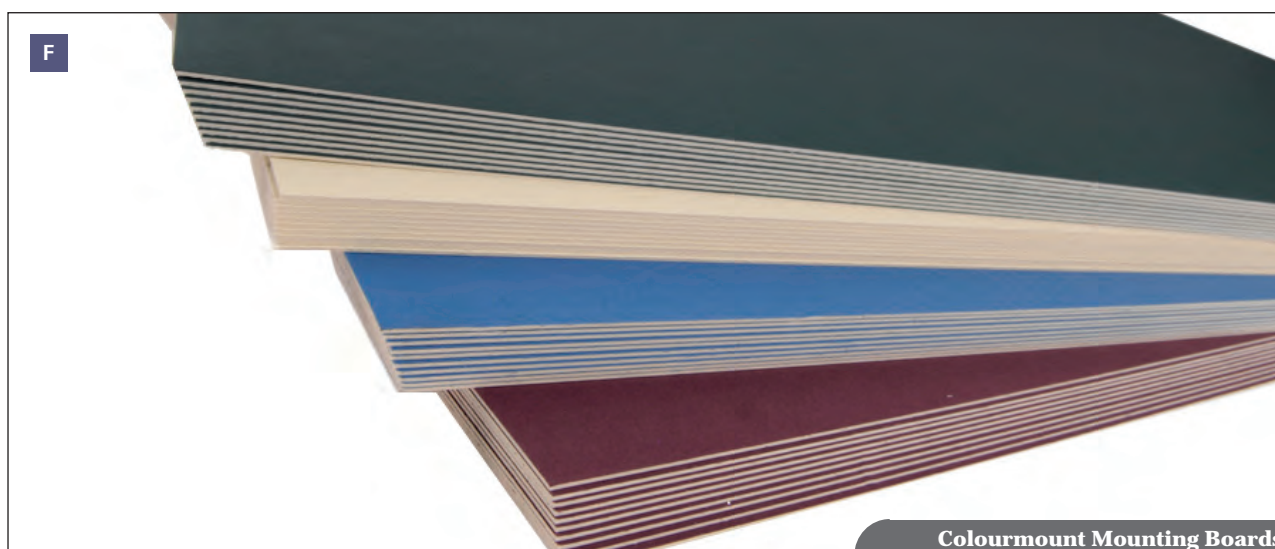



**Golf Merit Stars**

|                         |               |              |
|-------------------------|---------------|--------------|
| <b>Gold Merit Stars</b> |               | <b>£0.65</b> |
| <b>Order Code</b>       | <b>Packed</b> |              |
| 812063A                 | 500           |              |



**Silver Merit Stars**

|                                  |               |              |
|----------------------------------|---------------|--------------|
| <b>Gummed Silver Merit Stars</b> |               | <b>£0.65</b> |
| <b>Order Code</b>                | <b>Packed</b> |              |
| 812063B                          | 500           |              |



**Assorted Merit Stars**

|                                    |               |              |
|------------------------------------|---------------|--------------|
| <b>Gummed Assorted Merit Stars</b> |               | <b>£0.65</b> |
| <b>Order Code</b>                  | <b>Packed</b> |              |
| 812063C                            | 500           |              |



**Assorted Gummed Shapes**

|                        |               |              |
|------------------------|---------------|--------------|
| <b>Felt Squares</b>    |               | <b>£2.75</b> |
| Pack of 10 - 220x250mm |               |              |
| <b>Order Code</b>      | <b>Packed</b> |              |
| L-CC0600               | 10            |              |

|                               |               |              |
|-------------------------------|---------------|--------------|
| <b>Assorted Gummed Shapes</b> |               | <b>£0.65</b> |
| <b>Order Code</b>             | <b>Packed</b> |              |
| PS9                           | 500           |              |



**Felt Squares**

|                             |                |             |                   |
|-----------------------------|----------------|-------------|-------------------|
| <b>Gummed Paper Squares</b> |                |             |                   |
| Assorted Colours            |                |             |                   |
| <b>Order Code</b>           | <b>Size</b>    | <b>Pack</b> | <b>Pack Price</b> |
| S2G                         | 50mm x 50mm    | 100         | £0.70             |
| S4G                         | 100mm x 100mm  | 100         | £1.80             |
| S5G                         | 125mm x 125mm  | 100         | £3.00             |
| S6G                         | 150mm x 150mm  | 100         | £3.10             |
| S8G                         | 200mm x 200mm  | 100         | £6.00             |
| SASG                        | Assorted Sizes | 300         | £6.60             |

|                             |                |             |                   |
|-----------------------------|----------------|-------------|-------------------|
| <b>Gummed Paper Circles</b> |                |             |                   |
| Assorted Colours            |                |             |                   |
| <b>Order Code</b>           | <b>Size</b>    | <b>Pack</b> | <b>Pack Price</b> |
| C2G                         | 50mm Diameter  | 100         | £0.70             |
| C4G                         | 100mm Diameter | 100         | £1.80             |
| C5G                         | 125mm Diameter | 100         | £3.00             |
| C6G                         | 150mm Diameter | 100         | £3.10             |
| C8G                         | 200mm Diameter | 100         | £6.00             |
| CASG                        | Assorted Sizes | 300         | £6.60             |

|                                     |               |                   |
|-------------------------------------|---------------|-------------------|
| <b>Tissue Paper</b>                 |               | <b>£1.12</b>      |
| 510 x 760mm tissue paper pack of 25 |               |                   |
| <b>Description</b>                  | <b>Colour</b> | <b>Order Code</b> |
| Yellow                              |               | 812026Y           |
| White                               |               | 812026W           |
| Violet                              |               | 812026V           |
| Red                                 |               | 812026R           |
| Pale Pink                           |               | 812026PP          |
| Orange                              |               | 812026O           |
| Lilac                               |               | 812026L           |
| Dark Green                          |               | 812026DG          |
| Dark Blue                           |               | 812026DB          |
| Brown                               |               | 812026BN          |
| Dark Pink                           |               | 812026DP          |
| Gold Yellow                         |               | 812026GY          |
| Medium Green                        |               | 812026MG          |
| Magenta                             |               | 812026M           |
| Pale Blue                           |               | 812026PB          |
| Pale Brown                          |               | 812026PBN         |
| Pale Green                          |               | 812026PG          |
| Sky Blue                            |               | 812026SB          |
| Black                               |               | 812026BK          |

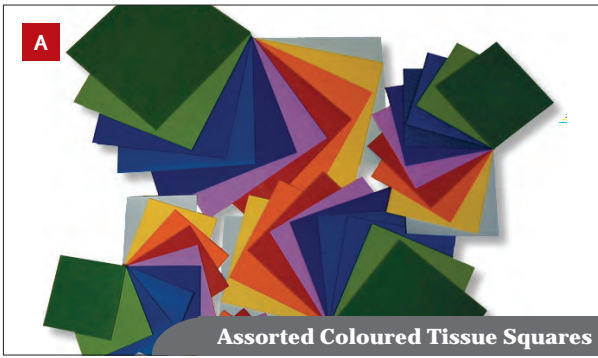

Assorted Coloured Tissue Squares



Assorted Coloured Tissue Circles

| Creative Tissue Paper |            | £1.70     |
|-----------------------|------------|-----------|
| 508mm x 762mm         |            |           |
| Colour                | Order Code | Pack Size |
| Assorted              | 5850-8     | 20        |

| Assorted Coloured Tissue Circles                              |            |       |
|---|------------|-------|
| Pack Of 480 contains 50 sheets Of the 10 most popular Colours |            |       |
| Colour  | Order Code | Price |
| 812029A   | 50mm Dia.  | £0.65 |
| 812029B   | 75mm Dia.  | £0.75 |
| 812029C   | 100mm Dia. | £1.15 |
| 812029D   | 125mm Dia. | £1.80 |
| 812029E   | 150mm Dia. | £2.20 |
| 812029F   | 200mm Dia. | £4.85 |
| 812029AS  | Assorted   | £5.55 |

| Tissue Paper    |            |       |
|-----------------|------------|-------|
| 510mm x 760mm   |            |       |
| Colour          | Order Code | Price |
| Metallic Gold   | 812026OG   | £2.37 |
| Metallic Silver | 812026S    | £2.37 |

| Tissue Paper        |            | £15.20    |
|---------------------|------------|-----------|
| 508mm x 762mm 18gsm |            |           |
| Colour              | Order Code | Pack Size |
| Assorted            | 812027     | 480       |

| Creative Lustre Tissue Paper |            | £3.06     |
|------------------------------|------------|-----------|
| 507mm x 761mm                |            |           |
| Colour                       | Order Code | Pack Size |
| Assorted                     | 58588      | 14        |

| Remnant Tissue Paper |            | £4.16     |
|----------------------|------------|-----------|
| 508mm x 762mm        |            |           |
| Colour               | Order Code | Pack Size |
| Assorted             | 599990     | £4.16     |

| Assorted Coloured Tissue Squares                              |               |        |
|---|---------------|--------|
| Pack Of 500 contains 50 sheets Of the 10 most popular Colours |               |        |
| Colour  | Order Code    | Price  |
| 812028A   | 50mm x 50mm   | £0.60  |
| 812028B   | 75mm x 75mm   | £0.65  |
| 812028C   | 100mm x 100mm | £1.12  |
| 812028D   | 125mm x 125mm | £1.75  |
| 812028E   | 150mm x 150mm | £2.10  |
| 812028F   | 200mm x 200mm | £4.50  |
| 812028AS  | Assorted      | £10.70 |

| Metallized Tissue Assortment |           | £2.62 |
|------------------------------|-----------|-------|
| 457mm x 762mm                |           |       |
| Order Code                   | Pack Size |       |
| 58618                        | 12        |       |

| Acid Free Tissue Paper |            | £10.10    |
|------------------------|------------|-----------|
| 500mm x 750mm          |            |           |
| Colour                 | Order Code | Pack Size |
| White                  | AFT1       | 500       |

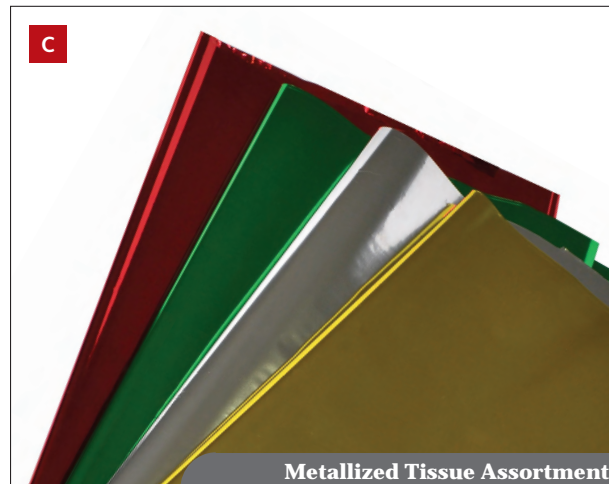

Metallized Tissue Assortment

| A Crepe Paper Fold       |        |            | £0.28<br>Assorted<br>£2.80 |
|--------------------------|--------|------------|----------------------------|
| 500mm x 2.5m single fold |        |            |                            |
| Description              | Colour | Order Code |                            |
| White                    |        | 812005W    |                            |
| Yellow                   |        | 812005Y    |                            |
| Black                    |        | 812005BK   |                            |
| Orange                   |        | 812005O    |                            |
| Cerise/Magenta           |        | 812005M/C  |                            |
| Pink                     |        | 812005P    |                            |
| Purple                   |        | 812005PU   |                            |
| Red                      |        | 812005R    |                            |
| Mid Green                |        | 812005MG   |                            |
| Light Blue               |        | 812005LB   |                            |
| Dark Blue                |        | 812005DB   |                            |
| Dark Green               |        | 812005DG   |                            |
| Brown                    |        | 812005BN   |                            |
| Assorted                 |        | 812006     |                            |

| Metallic Crepe Paper Fold                      |        |            | £2.40<br>Assorted<br>£10.95 |
|--|--------|------------|-----------------------------|
| 500mm x 2.5m single fold. 5 Folds in assorted. |        |            |                             |
| Description                                    | Colour | Order Code |                             |
| Blue   |        | 812105B    |                             |
| Green  |        | 812105G    |                             |
| Magenta  |        | 812105L    |                             |
| Gold   |        | 812105OG   |                             |
| Red  |        | 812105R    |                             |
| Silver   |        | 812105S    |                             |
| Assorted                                       |        | 812105AS   |                             |

| Coloured Metal Foil Roll  |                          |                            |
|---|--------------------------|----------------------------|
| 500mm wide, Single roll.<br>Assorted Pack 5 x 3m lengths: Silver, Red, Gold, Green, Blue. |                          |                            |
| Colour  | £125<br>3m<br>Order Code | £2.65<br>10m<br>Order Code |
| Silver  | 812016S                  | 12706                      |
| Red   | 812016R                  | 12701                      |
| Gold  | 812016OG                 | 12707                      |
| Green   | 812016G                  | 12704                      |
| Blue  | 812016B                  | 12702                      |
| Copper  | -                        | 12708                      |
| Purple  | -                        | 12709                      |
| Assorted Pack   | 812016AS - £5.30         | -                          |

| Two Sided Metallic Foil Rolls  |          | £2.20 |
|--|----------|-------|
| 500 x 800mm Gold backing<br>Pack Of 5 Colours: Silver, Violet, Blue, Red & Green |          |       |
| Order Code   | Colour   |       |
| A2SAS  | Assorted |       |

| B Metal Foil Roll                 |        |            |       |
|-----------------------------------|--------|------------|-------|
| 500mm x 800mm 2/Sided Gold 1 Side |        |            |       |
| Description                       | Colour | Order Code | Price |
| Blue                              |        | A2SB       | £0.50 |
| Green                             |        | A2SG       | £0.50 |
| Red                               |        | A2SR       | £0.50 |
| Silver                            |        | A2SS       | £0.50 |
| Violet                            |        | A2SV       | £0.50 |

| Rainbow Shaded Crepe Paper               |            |           | £1.76 |
|--|------------|-----------|-------|
| Rainbow Shaded Crepe Paper 500mm x 2.5m. |            |           |       |
| Colour                                   | Order Code | Pack Size |       |
| Rainbow                                  | 1650R      | Each      |       |

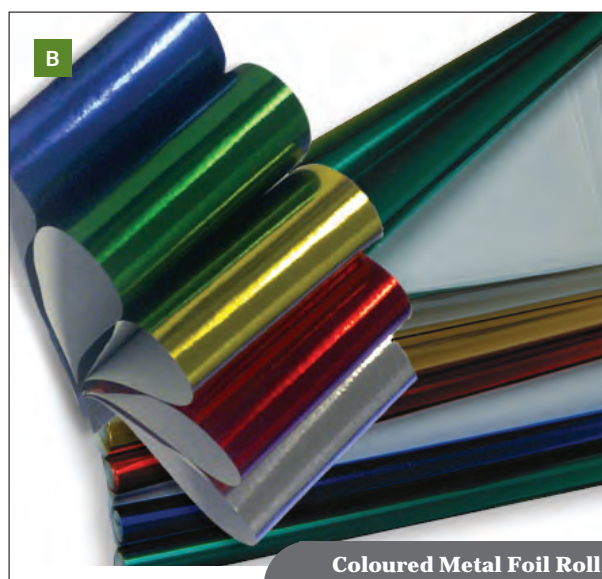
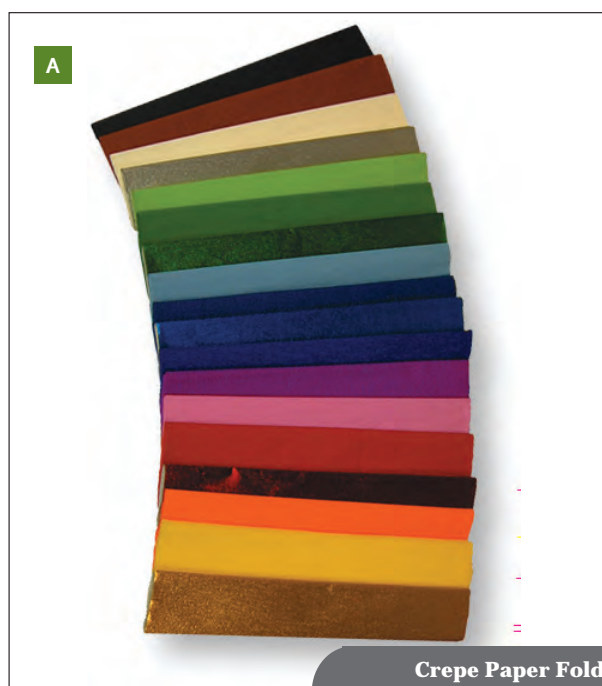

| Bordette Rolls   |        | £2.65      |
|--|--------|------------|
| Each roll contains 57mm x 15m - Plain Colours with scalloped edge. |        |            |
| Description  | Colour | Order Code |
| White  |        | 77000      |
| Flame Red  |        | 77030      |
| Canary   |        | 77080      |
| Orange   |        | 77100      |
| Nile Green   |        | 77120      |
| Apple Green  |        | 77130      |
| Emerald  |        | 77140      |
| Azure Blue   |        | 77160      |
| Bright Blue  |        | 77170      |
| Rich Blue  |        | 77180      |
| Black  |        | 77300      |
| Violet   |        | 77330      |



| Themed Icicle Rolls  |                   |            |            |
|--|-------------------|------------|------------|
| Icicle patterned edge. Each roll contains 2 x 3.75m strips. The Perfect finish for festive and winder displays, available in two Sizes and two different Papers. |                   |            |            |
| Colour   | Size              | Order Code | Price Each |
| White  | Small 70mm x 7.5m | 37700      | £2.72      |
| White  | Large 127mm x 15m | 34011      | £4.60      |
| Silver   | Small 70mm x 7.5m | 37710      | £3.64      |
| Silver   | Large 127mm x 15m | 34031      | £5.92      |

| Corogated Bordette Rolls  |        |               |               |
|---|--------|---------------|---------------|
| Each roll contains 57mm x 7.5m strips, scalloped edge. Pack of 2. |        |               |               |
| Description   | Colour | SCALLOP       | ZIG-ZAG       |
|   |        | Order Code    | Order Code    |
|   |        | Price - £2.65 | Price - £2.65 |
| White   |        | 37014         | 33014         |
| Brown   |        | 37024         | -             |
| Flame Red   |        | 37034         | 33034         |
| Chinese Red   |        | 37064         | -             |
| Canary  |        | 37084         | 33084         |
| Orange  |        | 37104         | 33104         |
| Nile Green  |        | 37124         | -             |
| Apple Green   |        | 37134         | 33134         |
| Emerald   |        | 37144         | 33144         |
| Azure Blue  |        | 37164         | -             |
| Bright Blue   |        | 37174         | 33174         |
| Rich Blue   |        | 37184         | 33184         |
| Teal  |        | 37194         | -             |
| Royal Blue  |        | 37204         | -             |
| Sky Blue  |        | 37214         | -             |
| Pink  |        | 37264         | -             |
| Orchid  |        | 37284         | -             |
| Black   |        | 37304         | 33304         |
| Violet  |        | 37334         | 33304         |
| Magenta   |        | 37344         | -             |
| Metallic Gold   |        | 37394         | -             |

| Metallic Bordette Rolls  |        | £3.50      |
|--|--------|------------|
| Each roll contains 57mm x 15m - Plain Colours with scalloped edge. |        |            |
| Description  | Colour | Order Code |
| Metallic Silver  |        | 77970      |
| Metallic Gold  |        | 77980      |

| Corrugated Bordettes      |           |            |            |
|---------------------------|-----------|------------|------------|
| Scalloped Edge 57mm x 15m |           |            |            |
| Colour                    | Size      | Order Code | Price Each |
| Assorted                  | Pack Of 5 | CBRASS5    | £11.75     |
| Metallic Assorted         | Pack Of 4 | CBRASS4    | £10.15     |



| Assorted Bright Corobuff Card Sheets - Pack Of 12 |          | £2.99       |
|---|----------|-------------|
| Order Code  | Colour   | Size        |
| 71500   | Assorted | 305 x 407mm |

| A Assorted Pastel Rolls - Pack Of 6 |          | £11.36     |
|-------------------------------------|----------|------------|
| Order Code                          | Colour   | Size       |
| BRSC                                | Standard | 48mm x 50m |



| B Assorted Metallic Rolls - Pack Of 4 |          | £11.36     |
|---------------------------------------|----------|------------|
| Order Code                            | Colour   | Size       |
| BRMC                                  | Metallic | 48mm x 50m |

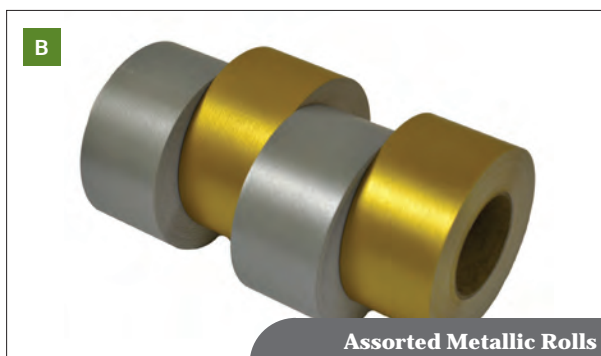

| C Corrugated Rainbow Shaded Paper            |            | £6.00     |
|--|------------|-----------|
| Corrugated Rainbow Shaded Sheets 350 x 500mm |            |           |
| Colour                                       | Order Code | Pack Size |
| Rainbow                                      | 1083R      | 10        |



| D Scalloped Border Poster Rolls                |                                   |                                    |
|--|-----------------------------------|------------------------------------|
| Twin Roll measuring 57mm x 50m and 57mm x 7.5m |                                   |                                    |
| Colour   | £5.40<br>57mm x 50m<br>Order Code | £3.25<br>57mm x 7.5m<br>Order Code |
| Black  | SBRBK                             | CSBRBK                             |
| Blue   | SBRUB                             | CSBRB                              |
| Yellow   | -                                 | CSBRY                              |
| Green  | -                                 | CSBRG                              |
| Red  | -                                 | CSBRR                              |
| Scarlet  | SBRSC                             | -                                  |
| Green  | SBRE                              | -                                  |
| Lemon  | SBRL                              | -                                  |



| E Themed Design Rolls                               |            | £2.85 |
|---|------------|-------|
| Scalloped edge. Each roll contains 2 x 7.5m strips. |            |       |
| Description   | Order Code |       |
| Handprints  | 37600      |       |
| School Days   | 37610      |       |
| Autumn Leaves                                       | 37680      |       |
| Crayons   | 37690      |       |
| Stars   | 37900      |       |
| Spring Flowers                                      | 37910      |       |
| Winter Fun  | 37920      |       |
| Clouds  | 37930      |       |

| Assorted Pastel Rolls - Pack Of 4 |        | £7.58      |
|-----------------------------------|--------|------------|
| Order Code                        | Colour | Size       |
| BRPC                              | Pastel | 48mm x 50m |

| Corrugated Metallic Rolls                            |            | £3.45 |
|--|------------|-------|
| Scalloped edge. Each roll contains 2 x 3.75m strips. |            |       |
| Colour   | Order Code |       |
| Black  | 37800      |       |
| Red  | 37810      |       |
| Blue   | 37830      |       |
| Gold   | 37840      |       |
| Silver   | 37850      |       |
| Green  | 37860      |       |
| Purple   | 37870      |       |

| Sequin Mesh |                   | £5.00     | F |
|-------------|-------------------|-----------|---|
| 80mm x 5m   |                   |           |   |
| Order Code  | Colour            | Pack Size |   |
| SM8520      | Assorted Metallic | 5         |   |



| Scalloped Metallic Border Poster Rolls                  |                                   |                                    | G |
|---|-----------------------------------|------------------------------------|---|
| 57mm wide, Single roll.<br>Assorted Pack Silver & Gold. |                                   |                                    |   |
| Colour  | £6.85<br>57mm x 50m<br>Order Code | £3.50<br>57mm x 7.5m<br>Order Code |   |
| Gold  | SBROG                             | CSBROG                             |   |
| Silver  | SBRS                              | CSBRS                              |   |



| Holographic Card    |            | £2.48     | H |
|---------------------|------------|-----------|---|
| A4 Assorted Colours |            |           |   |
| Colour              | Order Code | Pack Size |   |
| Assorted            | 76470      | 10        |   |

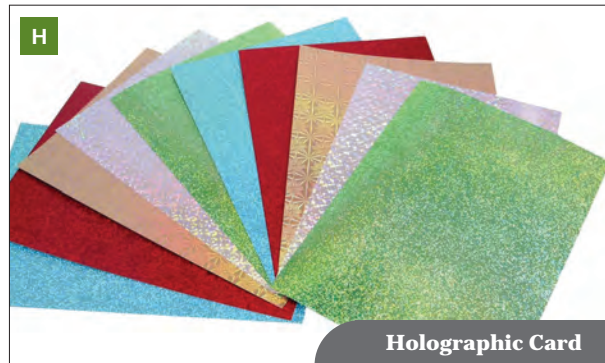

| Corrugated Card Sheets                 |            | £2.99     |
|--|------------|-----------|
| Assorted Corrugated Sheets 305 x 407mm |            |           |
| Colour                                 | Order Code | Pack Size |
| Assorted                               | 71500      | 12        |

| Corrugated Metallic Sheets                |            | £4.50     | I |
|---|------------|-----------|---|
| Silver & Gold Metallic Sheets 305 x 407mm |            |           |   |
| Colour                                    | Order Code | Pack Size |   |
| Silver & Gold                             | 71520      | 12        |   |



| Corrugated Metallic Micro Flute A4 Sheets |            | £2.99     | J |
|---|------------|-----------|---|
| Assorted Metallic Sheets 210 x 297mm      |            |           |   |
| Colour                                    | Order Code | Pack Size |   |
| Assorted                                  | 71595      | 10        |   |

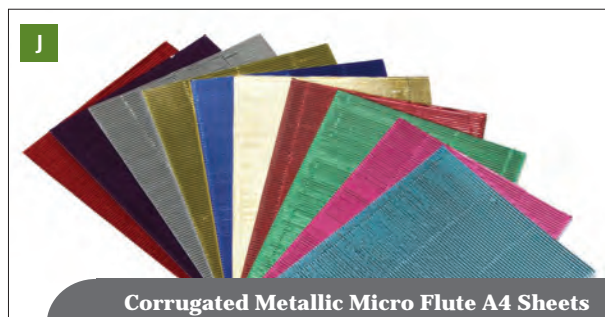

## Charta Tracing Paper Pad - 60gsm

| Order Code | Size | Pack Size | Price |
|------------|------|-----------|-------|
| 719105     | A4   | 50 Leaves | £1.99 |

## Charta Tracing Paper - 63gsm

| Order Code | Size | Pack Size | Price  |
|------------|------|-----------|--------|
| 361        | A4   | 500       | £13.99 |
| TPA263-25  | A2   | 25        | £3.25  |
| TPA163-25  | A1   | 25        | £5.99  |
| TPA363-400 | A3   | 400       | £23.99 |
| TPA363-500 | A3   | 500       | £29.99 |

## Charta Tracing Paper - 90gsm

| Order Code | Size | Pack Size | Price  |
|------------|------|-----------|--------|
| TPA29-25   | A2   | 25        | £4.50  |
| TPA19-25   | A1   | 25        | £8.99  |
| TPA49-50   | A4   | 50        | £2.65  |
| TPA49-250  | A4   | 250       | £10.99 |

## Kitchen Paper Sheers - 90gsm

| Order Code | Size          | Price  | Pack Size |
|------------|---------------|--------|-----------|
| KP91       | 500mm x 750m  | £14.90 | 500       |
| KP931      | 250mm x 375mm | £3.85  | 500       |
| KP951      | 375mm x 500mm | £7.45  | 500       |

## Bulk Tracing Paper - A1

| Order Code | Weight | Pack Size       | Price  |
|------------|--------|-----------------|--------|
| TPA163BP1  | 63g    | Tabbed in 100's | £22.20 |
| TPA19BP1   | 90g    | Tabbed in 100's | £31.70 |

## A Transparent Cellophane Rolls - 70cm x 5m

| Order Code | Colour                | Price  |
|------------|-----------------------|--------|
| 6933       | Red                   | £2.99  |
| 6934       | Blue                  | £2.99  |
| 6935       | Green                 | £2.99  |
| 6936       | Pink                  | £2.99  |
| 6937       | Yellow                | £2.99  |
| 6938       | Orange                | £2.99  |
| 6939       | White                 | £2.99  |
| 6940       | Mauve                 | £2.99  |
| 6941       | Pale Blue             | £2.99  |
| 6942       | Silver                | £2.99  |
| 6958       | Transparent           | £2.99  |
| 60AS       | Assorted - Pack of 5  | £14.95 |
| 60AS6      | Assorted - Pack of 6  | £17.95 |
| 60AS24     | Assorted - Pack of 24 | £71.75 |

## Day-Glo Florescent Copier Paper

Packs Of 100 - Assorted Colours - 100gsm

| Order Code | Size | Price  |
|------------|------|--------|
| DCASA41    | A4   | £5.32  |
| DCASA31    | A3   | £10.65 |

## Greaseproof Tracing Paper - 38gsm

| Order Code | Size         | Pack Size | Price  |
|------------|--------------|-----------|--------|
| 812038B1   | 229 x 178 mm | 500       | £2.40  |
| 321        | 210 x 297 mm | 500       | £3.30  |
| 812038A    | 500 x 750 mm | 25        | £0.99  |
| TPA441     | 240x 297 mm  | 100       | £1.15  |
| 12661      | 184x 248 mm  | 250       | £1.20  |
| 02019026   | 210 x 297mm  | 250       | £1.85  |
| 812038C1   | 203 x 165 mm | 500       | £2.40  |
| PG1        | 500 x 750 mm | 500       | £16.50 |

## Kitchen Paper Rolls - 60gsm

£10.20

| Order Code | Size         | Pack Size |
|------------|--------------|-----------|
| KPR        | 457mm x 230m | 1         |

## Polystyrene Print Sheets

£33.20

| Order Code  | Size | Pack Size |
|-------------|------|-----------|
| 79500 - 100 | A4   | 100       |

## Kraft Wrapping Paper

Superior quality Acid Free Drawing Cartridge

| Order Code | Size           | Pack Size | Price  |
|------------|----------------|-----------|--------|
| 812040B    | 900mm x 1150m  | 25        | £3.75  |
| NSK42      | 300mm x 575mm  | 500       | £6.60  |
| K364571    | 900mm x 1150mm | 250       | £32.50 |
| 12858      | 900mm 1150mm   | 50        | £9.20  |
| K364591    | 900mm x 1150mm | 250       | £40.20 |
| K36        | 900mm x 28m    | Roll Each | £28.95 |

## Bubble Wrap

£6.56

| Order Code | Size       |
|------------|------------|
| 09103      | 530mm x 5m |



A

Transparent Cellophane Roll



|                       |                          |              |
|-----------------------|--------------------------|--------------|
| <b>Newsprint Reel</b> |                          | <b>£7.40</b> |
| 49gsm, Pack - Each    |                          |              |
| <b>Order Code</b>     | <b>Size</b>              |              |
| NKR                   | 457mm x 230 meters (18") |              |

|                         |                                 |              |
|-------------------------|---------------------------------|--------------|
| <b>Newsprint Sheets</b> |                                 |              |
| 49gsm, Pack of 500      |                                 |              |
| <b>Order Code</b>       | <b>Size</b>                     | <b>Price</b> |
| NP381                   | 250 x 380mm (10x15")            | £2.20        |
| NP51                    | 380 x 500mm (15 x 20")          | £4.35        |
| NP1                     | 500 x 750mm (20 x 30")          | £8.50        |
| NPA31                   | A3, 297 x 420mm (11.75 x 16.5") | £2.85        |
| NPA21                   | A2, 420 x 594mm (16.5 x 24")    | £5.65        |
| NPA11                   | A1, 594 x 841mm (24 x 33")      | £11.30       |

|                                 |                           |              |
|---------------------------------|---------------------------|--------------|
| <b>Junior Drawing Cartridge</b> |                           |              |
| 60gsm, Pack of 500              |                           |              |
| <b>Order Code</b>               | <b>Size</b>               | <b>Price</b> |
| 181                             | 250 x 375mm (10 x 14.75") | £2.55        |
| 721                             | 375 x 500mm (14.75 x 20") | £5.10        |
| 731                             | 500 x 768mm (20 x 30")    | £9.90        |

|                               |               |                  |              |
|-------------------------------|---------------|------------------|--------------|
| <b>Matt Drawing Cartridge</b> |               |                  |              |
| 150gsm                        |               |                  |              |
| <b>Order Code</b>             | <b>Size</b>   | <b>Pack Size</b> | <b>Price</b> |
| 812057B1                      | A2, 420 x 594 | 250              | £15.72       |
| 812057C1                      | A3, 297 x 420 | 500              | £15.72       |
| 812057D1                      | A4, 210 x 297 | 500              | £7.86        |
| 812057A1                      | A1, 594 x 841 | 250              | £24.65       |

|                          |                 |                  |              |
|--------------------------|-----------------|------------------|--------------|
| <b>Drawing Cartridge</b> |                 |                  |              |
| 90gsm, Pack of 500       |                 |                  |              |
| <b>Order Code</b>        | <b>Size</b>     | <b>Pack Size</b> | <b>Price</b> |
| 812060G1                 | A4, 210 x 297mm | 500              | £3.85        |
| 812060F1                 | A3, 297 x 420mm | 500              | £8.65        |
| 812060E1                 | A2, 420 x 594mm | 500              | £17.30       |
| 812060H1                 | A1, 594 x 841mm | 250              | £17.30       |

|                          |                 |                  |              |
|--------------------------|-----------------|------------------|--------------|
| <b>Drawing Cartridge</b> |                 |                  |              |
| 180gsm                   |                 |                  |              |
| <b>Order Code</b>        | <b>Size</b>     | <b>Pack Size</b> | <b>Price</b> |
| SDCA2181                 | A2, 420 x 594mm | 250              | £21.62       |
| SDCA3181                 | A3, 297 x 420mm | 250              | £8.18        |



|                          |                 |                  |              |
|--------------------------|-----------------|------------------|--------------|
| <b>Drawing Cartridge</b> |                 |                  |              |
| 100gsm                   |                 |                  |              |
| <b>Order Code</b>        | <b>Size</b>     | <b>Pack Size</b> | <b>Price</b> |
| SDCA411                  | A4, 210 x 297mm | 500              | £4.30        |
| SDCA311                  | A3, 297 x 420mm | 250              | £4.30        |
| SDCA211                  | A2, 420 x 594mm | 500              | £17.12       |
| SDCA111                  | A1, 594 x 841mm | 250              | £17.12       |

|                          |                 |                  |              |
|--------------------------|-----------------|------------------|--------------|
| <b>Drawing Cartridge</b> |                 |                  |              |
| 120gsm                   |                 |                  |              |
| <b>Order Code</b>        | <b>Size</b>     | <b>Pack Size</b> | <b>Price</b> |
| SDCA41151                | A4, 210 x 297mm | 500              | £5.12        |
| SDCA31151                | A3, 297 x 420mm | 500              | £10.25       |
| SDCA21151                | A2, 420 x 594mm | 500              | £20.55       |
| SDCA11151                | A1, 594 x 841mm | 250              | £20.55       |

|                          |                 |                  |              |
|--------------------------|-----------------|------------------|--------------|
| <b>Drawing Cartridge</b> |                 |                  |              |
| 140gsm                   |                 |                  |              |
| <b>Order Code</b>        | <b>Size</b>     | <b>Pack Size</b> | <b>Price</b> |
| SDCA4131                 | A4, 210 x 297mm | 250              | £2.99        |
| SDCA3131                 | A3, 297 x 420mm | 500              | £11.96       |
| SDCA2131                 | A2, 420 x 594mm | 500              | £23.95       |
| SDCA1131                 | A1, 594 x 841mm | 250              | £23.95       |

|                          |                 |                  |              |
|--------------------------|-----------------|------------------|--------------|
| <b>Drawing Cartridge</b> |                 |                  |              |
| 150gsm                   |                 |                  |              |
| <b>Order Code</b>        | <b>Size</b>     | <b>Pack Size</b> | <b>Price</b> |
| SDCA4151                 | A4, 210 x 297mm | 500              | £8.10        |
| SDCA3151                 | A3, 297 x 420mm | 500              | £16.15       |
| SDCA2151                 | A2, 420 x 594mm | 250              | £16.15       |

|                                   |                 |                  |              |
|-----------------------------------|-----------------|------------------|--------------|
| <b>Recycled Drawing Cartridge</b> |                 |                  |              |
| 140gsm                            |                 |                  |              |
| <b>Order Code</b>                 | <b>Size</b>     | <b>Pack Size</b> | <b>Price</b> |
| 8120PU51                          | A4, 210 x 297mm | 500              | £8.05        |
| 8120PU41                          | A3, 297 x 420mm | 500              | £16.00       |
| 8120PU21                          | A2, 420 x 594mm | 500              | £31.92       |
| 8120PU11                          | A1, 594 x 841mm | 250              | £31.92       |

## Hog Hair Brushes

White bristles with seamless aluminium ferrule and polished handle.  
Overall length 300mm (12" long) **Pack Of 10**

| Description        | Order Code | Price |
|--------------------|------------|-------|
| Round Size No.4    | 58404      | £2.32 |
| Round Size No.6    | 58406      | £2.52 |
| Round Size No.8    | 58408      | £2.74 |
| Round Size No.10   | 58410      | £3.80 |
| Round Size No.12   | 58412      | £3.20 |
| Round Size No.14   | 58414      | £5.80 |
| Round Size No.16   | 58416      | £6.80 |
| Round Size No.18   | 58418      | £7.20 |
| Flat Size No.4     | 56304      | £2.32 |
| Flat Size No.6     | 56306      | £2.50 |
| Flat Size No.8     | 56308      | £2.75 |
| Flat Size No. 10   | 56310      | £2.95 |
| Flat Size No.12    | 56312      | £3.20 |
| Flat Size No.14    | 56314      | £5.60 |
| Flat Size No.16    | 56316      | £5.80 |
| Flat Size No.18    | 56318      | £7.00 |
| Filbert Size No.4  | 56504      | £2.75 |
| Filbert Size No. 6 | 56506      | £3.16 |
| Filbert Size No. 8 | 56508      | £4.00 |

## Hog Hair Brushes - Short Handle

Hog Hair Brushes with a short handle in packs of 10

| Description     | Order Code | Price |
|-----------------|------------|-------|
| Round Size No.4 | 58304      | £2.40 |
| Round Size No.6 | 58306      | £2.10 |
| Round Size No.8 | 58308      | £2.40 |

## Hog Hair Brushes - Assorted Packs

White bristles with seamless aluminium ferrule and polished handle.  
Overall length 190mm (7.5" short).

| Description   | Order Code | Pack Size | Price  |
|---------------|------------|-----------|--------|
| Flat Assorted | 5816       | 6         | £2.00  |
| Flat Assorted | 58160      | 60        | £18.00 |

## Hog Hair Brushes - Classroom Packs

White bristles with seamless aluminium ferrule and polished handle.  
**Pack Of 50**

| Description   | Order Code | Price  |
|---------------|------------|--------|
| Round - Long  | 58450GHP   | £11.60 |
| Round - Short | 58350GHP   | £10.60 |
| Flat - Long   | 56350GHP   | £11.70 |

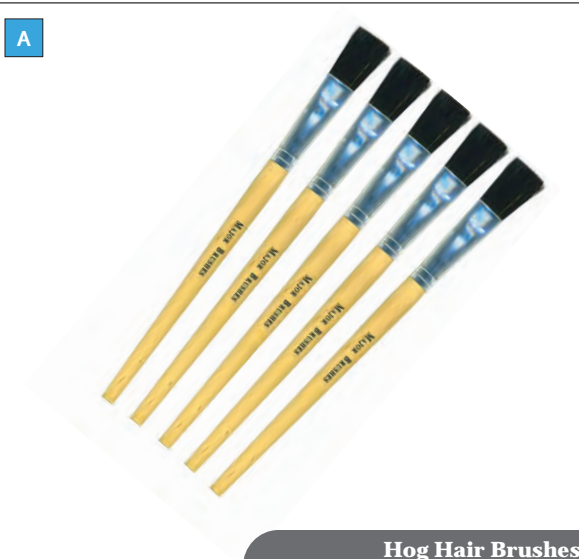

Hog Hair Brushes

## Large Chubby Brush Infant

Pack Of 6

| Description              | Order Code | Price |
|--------------------------|------------|-------|
| Chubby Brush for Infants | 6002-6     | £3.05 |

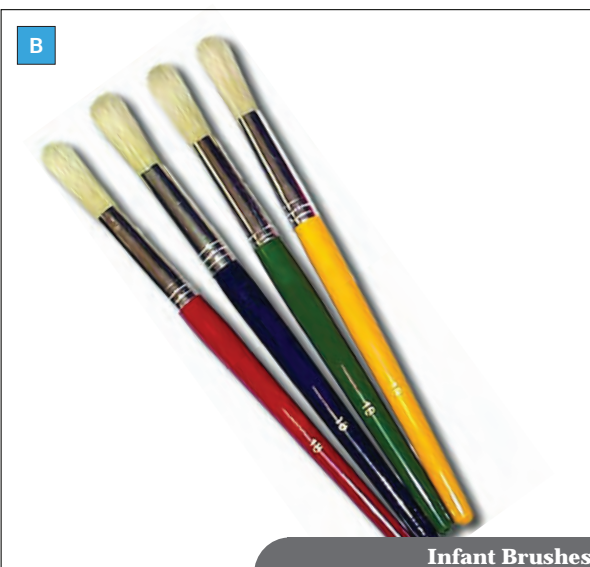

Infant Brushes

## Spreaders - Packs Of 10

| Description             | Order Code | Price |
|-------------------------|------------|-------|
| Glue Spreaders, Plastic | 6003       | £0.64 |

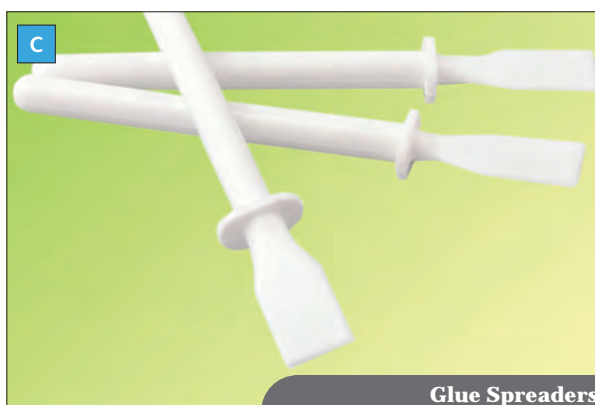

Glue Spreaders

**Pure Squirrel Soft Hair Brushes - Packs of 10** E

Soft Hair Brushes with pointed handle. Overall length 190mm (7.5")

| Description | Order Code | Price  |
|-------------|------------|--------|
| Size No.10  | 59210      | £9.00  |
| Size No.12  | 59212      | £10.60 |



**Soft Hair Imitation Squirrel Brushes**

Overall length 190mm (7.5"Short) Pointed **Pack Of 5**

| Description       | Order Code | Price |
|-------------------|------------|-------|
| Pointed Size No.2 | 51102-5    | £0.95 |
| Pointed Size No.4 | 51104-5    | £1.26 |
| Pointed Size No.6 | 51106-5    | £1.38 |
| Round Size No.8   | 51108-5    | £2.04 |

**Stencil Brushes - White Bristle, Polished Handle**

| Description          | Order Code | Price |
|----------------------|------------|-------|
| Pack Of 5 Size No. 2 | 56902-5    | £2.32 |
| Pack Of 5 Size No.4  | 56904-5    | £2.42 |
| Pack Of 5 Size No.6  | 56906-5    | £4.20 |

**Black Paste Brush**

Flat Nylon Brush 25mm Wide - Pack of 10

| Description | Order Code | Price |
|-------------|------------|-------|
| 25mm Width  | 52912      | £6.30 |

**Hog Hair Brush - Chubby Handle**

Pack Of 4

| Description | Order Code | Price |
|-------------|------------|-------|
| Size No.18  | 583184     | £2.50 |

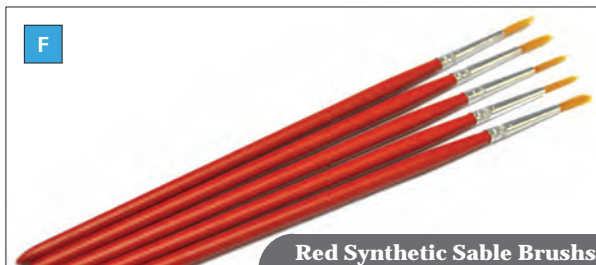

**Red Synthetic Sable Brushes** F

Pointed Brushes Pack of 5

| Description | Order Code | Price  |
|-------------|------------|--------|
| Size No.2   | 59102-5    | £2.10  |
| Size No.4   | 59104-5    | £2.30  |
| Size No.6   | 59106-5    | £3.20  |
| Size No.8   | 59108-5    | £4.70  |
| Size No.10  | 59110      | £12.60 |

**Imitation Sable Brushes** G

Classpack of 50 brushes in assorted sizes, No's 1, 2, 3, 4 & 6)

| Description | Order Code | Price  |
|-------------|------------|--------|
| Round       | 57950MB    | £18.00 |

**Synthetic Sable - Short Handle**

White bristles with seamless aluminium ferrule and polished handle. Overall length 190mm (7.5"Short)

| Description      | Order Code | Pack Size | Price |
|------------------|------------|-----------|-------|
| Round Size No.2  | 53402-5    | 5         | £1.14 |
| Round Size No.4  | 53404-5    | 5         | £1.36 |
| Round Size No.6  | 53406-10   | 10        | £3.30 |
| Round Size No.8  | 53408-5    | 5         | £1.80 |
| Round Size No.12 | 53410-5    | 5         | £6.40 |
| Round Size No.14 | 53412-5    | 5         | £7.45 |



| A Synthetic Brush                                       |            |       |
|---|------------|-------|
| One-Stroke Wash Brush with Synthetic Soft Flat Bristles |            |       |
| Description   | Order Code | Price |
| 38mm (1.5")   | 59714      | £2.40 |



Synthetic Brush

| B Jumbo Non-Roll Brush                          |            |       |
|---|------------|-------|
| Short sturdy chubby handle for easy grip - Each |            |       |
| Description                                     | Order Code | Price |
| Chubby Non-Roll Brush                           | 6000       | £0.75 |



Jumbo Non-Roll Brush

| Golden Nylon Bristle Brushes - Short Handle   |            |       |
|---|------------|-------|
| Golden bristles with seamless aluminium ferrule and polished handle. Overall length 190mm (7.5" Short) <b>Pack Of 5</b> |            |       |
| Description   | Order Code | Price |
| Round Size No.2   | 54202-5    | £0.86 |
| Round Size No.4   | 54204-5    | £1.00 |
| Round Size No.6   | 54206-5    | £1.12 |
| Round Size No.8   | 54208-5    | £1.26 |
| Round Size No.10  | 54210-5    | £1.50 |

| C White Nylon Bristle Brushes - Long Handle  |            |       |
|--|------------|-------|
| White bristles with seamless aluminium ferrule and polished handle. Overall length 300mm (12" long) <b>Pack Of 5</b> |            |       |
| Description  | Order Code | Price |
| Round Size No.2  | 59502      | £1.50 |
| Round Size No.4  | 59504      | £1.60 |
| Round Size No.6  | 59506      | £1.70 |
| Round Size No.8  | 59508      | £1.80 |
| Round Size No.10   | 59510      | £2.30 |
| Round Size No.12   | 59512      | £2.95 |
| Round Size No.14   | 59514      | £3.80 |
| Round Size No.16   | 59516      | £4.60 |
| Round Size No.18   | 59518      | £4.70 |
| Flat Size No.4   | 59604      | £1.70 |
| Flat Size No.6   | 59606      | £2.00 |
| Flat Size No.8   | 59608      | £2.20 |
| Flat Size No.10  | 59610      | £2.40 |
| Flat Size No.12  | 59612      | £2.80 |
| Flat Size No.14  | 59614      | £3.20 |
| Flat Size No.16  | 59616      | £3.36 |
| Flat Size No.18  | 59618      | £4.00 |



White Nylon Brushes













| Ready Mixed Poster Paint <span style="float: right;">A</span>   |        |                                     |
|---|--------|-------------------------------------|
| Highly concentrated, water soluble, non-toxic, single Colours. 568ml squeeze bottles or 5 litre containers. |        |                                     |
| Description   | Colour | 568ml Bottle<br>£1.05<br>Order Code |
| Lemon   |        | 01296020                            |
| Orange  |        | 01296023                            |
| Peach   |        | 01296024                            |
| Vermillion  |        | 01296025                            |
| Crimson   |        | 01296027                            |
| Ostwald Red   |        | 01296028                            |
| Purple  |        | 01296029                            |
| Violet  |        | 01296030                            |
| Brilliant Blue  |        | 01296031                            |
| Ostwald Blue  |        | 01296033                            |
| Prussian Blue   |        | 01296034                            |
| Turquoise   |        | 01296036                            |
| Sea Green   |        | 01296037                            |
| Emerald   |        | 01296038                            |
| Brilliant Green   |        | 01296040                            |
| Leaf Green  |        | 01296041                            |
| Black   |        | 01296042                            |
| Burnt Umber   |        | 01296043                            |
| Burnt Sienna  |        | 01296044                            |
| Yellow Ochre  |        | 01296045                            |
| Sky Blue  |        | 01296067                            |
| Cobalt Blue   |        | 01296117                            |
| Veridian Hue  |        | 01296108                            |









| Ready Mixed Thick Poster Paint                       |        | £2.20 <span style="float: right;">B</span> |
|--|--------|--|
| Finely ground in Gum, resolute in water, 300ml tubes |        |  |
| Description  | Colour | Order Code                                 |
| Black  |        | 03394042                                   |
| Brilliant Blue                                       |        | 03394031                                   |
| Brilliant Green                                      |        | 03394040                                   |
| Brilliant Red  |        | 03394026                                   |
| Brilliant Yellow                                     |        | 03394021                                   |
| Burnt Umber  |        | 03394043                                   |
| Burn Sienna  |        | 03394044                                   |
| Cerise   |        | 03394012                                   |
| Cobalt Blue  |        | 03394117                                   |
| Crimson  |        | 03394027                                   |
| Leaf Green   |        | 03394041                                   |
| Lemon  |        | 03394020                                   |
| Orange   |        | 03394023                                   |
| Prussian Blue  |        | 03394034                                   |
| Purple   |        | 03394029                                   |
| Sky Blue   |        | 03394067                                   |
| Turquoise  |        | 03394036                                   |
| Vermillion   |        | 03394025                                   |
| Viridian   |        | 03394108                                   |
| Yellow Ochre   |        | 03394045                                   |







| Scola Ready Mix Fluorescent Paint |            | £12.30 <span style="float: right;">C</span> |
|-----------------------------------|------------|---|
| 600ml Bottles, Assorted Colours.  |            |   |
| Pack Size                         | Order Code |   |
| 6                                 | AMF600/6/A |   |







| A Scola Artmix Ready Mixed Paint |            |   |        |
|----------------------------------|------------|---|--------|
| Plastic Bottle, 600ml.           |            |   |        |
| Colour                           | Order Code | Colour  | Price  |
| Sky Blue                         | AM600/17   |    | £0.99  |
| Lemon                            | AM600/20   |    | £0.99  |
| Yellow                           | AM600/21   |    | £0.99  |
| Orange                           | AM600/22   |    | £0.99  |
| Vermillion                       | AM600/23   |    | £0.99  |
| Red                              | AM600/24   |    | £0.99  |
| Crimson                          | AM600/25   |    | £0.99  |
| Purple                           | AM600/27   |    | £0.99  |
| Brilliant Blue                   | AM600/29   |    | £0.99  |
| Cobalt                           | AM600/30   |    | £0.99  |
| Prussian Blue                    | AM600/31   |    | £0.99  |
| Turquoise                        | AM600/33   |    | £0.99  |
| Viridian                         | AM600/35   |    | £0.99  |
| Brilliant Green                  | AM600/36   |    | £0.99  |
| Leaf Green                       | AM600/37   |    | £0.99  |
| Black                            | AM600/38   |    | £0.99  |
| Burnt Umber                      | AM600/39   |    | £0.99  |
| Burnt Sienna                     | AM600/40   |    | £0.99  |
| Yellow Ochre                     | AM600/41   |  | £0.99  |
| White                            | AM600/43   |   | £0.99  |
| Assorted - Pack of 20            | AM600/20/A |   | £18.00 |

| Scola Artmix Ready Mixed Paint |            |   |       |
|--------------------------------|------------|---|-------|
| 5 litre container.             |            |   |       |
| Colour                         | Order Code | Colour  | Price |
| Black                          | AM5LT/38   |  | £7.75 |
| Brilliant Blue                 | AM5LT/29   |  | £7.75 |
| Brilliant Green                | AM5LT/36   |  | £7.75 |
| Red                            | AM5LT/24   |  | £7.75 |
| Orange                         | AM5LT/22   |  | £7.75 |
| Yellow                         | AM5LT/21   |  | £7.75 |
| Burnt Sienna                   | AM5LT/40   |  | £7.75 |
| Burnt Umber                    | AM5LT/39   |  | £7.75 |
| Purple                         | AM5LT/27   |  | £7.75 |
| White                          | AM5LT/43   |   | £7.75 |



| B Metallic Ready Mixed Paint   |   |            | £2.15 |
|--------------------------------|---|------------|-------|
| 284ml bottles. Single Colours. |   |            |       |
| Description                    | Colour  | Order Code |       |
| Gold                           |  | 01210048   |       |
| Silver                         |  | 01210049   |       |
| Bronze                         |  | 01210075   |       |
| Antique Gold                   |  | 01210076   |       |











| C Ocaldo Fluorescent Ready Mixed Paint |   |            | £2.20 |
|--|---|------------|-------|
| 568ml bottles. Single Colours.         |   |            |       |
| Description                            | Colour  | Order Code |       |
| Orange                                 |  | 03496098   |       |
| Red                                    |  | 03496101   |       |
| Green                                  |  | 03496102   |       |
| Blue                                   |  | 03496104   |       |













| Reeves Ready Mix Paint |            |   |       |
|------------------------|------------|---|-------|
| Plastic Bottle, 500ml. |            |   |       |
| Colour                 | Order Code | Colour  | Price |
| Black                  | 4550030    |  | £0.89 |
| Brilliant Blue         | 4550044    |  | £0.89 |
| Brilliant Green        | 4550046    |  | £0.89 |
| Brilliant Red          | 4550049    |  | £0.89 |
| Brilliant Orange       | 4550051    |  | £0.89 |
| Brilliant Yellow       | 4550055    |  | £0.89 |
| Burnt Sienna           | 4550074    |  | £0.89 |
| Burnt Umber            | 4550076    |  | £0.89 |
| Cerise                 | 4550140    |  | £0.89 |
| Crimson                | 4550203    |  | £0.89 |
| Cyan                   | 4550207    |  | £0.89 |
| Leaf Green             | 4550341    |  | £0.89 |
| Lemon Yellow           | 4550343    |  | £0.89 |
| Purple                 | 4550542    |  | £0.89 |
| Turquoise              | 4550654    |  | £0.89 |
| White                  | 4550702    |  | £0.89 |
| Yellow Ochre           | 4550744    |  | £0.89 |

| Berol Meltdown Paint |              |               | £3.66 |
|----------------------|--------------|---------------|-------|
| Order Code           | Size         | Colour        |       |
| MD25027              | 250ml Bottle | Silver Stream |       |
| MD25028              | 250ml Bottle | Surfer Bronze |       |
| MD25050              | 250ml Bottle | Kettle Copper |       |
| MD25063              | 250ml Bottle | Egyptian Gold |       |









| Reeves Ready Mix Paint   |            |   |       |
|--------------------------|------------|---|-------|
| Plastic Bottle, 1 litre. |            |   |       |
| Colour                   | Order Code | Colour  | Price |
| Black                    | 4554030    |  | £1.80 |
| Brilliant Blue           | 4554044    |  | £1.80 |
| Brilliant Green          | 4554046    |  | £1.80 |
| Brilliant Red            | 4554049    |  | £1.80 |
| Brilliant Orange         | 4554051    |  | £1.80 |
| Brilliant Yellow         | 4554055    |  | £1.80 |
| Purple                   | 4554542    |  | £1.80 |
| White                    | 4554702    |  | £1.80 |

| Reeves Ready Mix Paint  |            |   |       |
|-------------------------|------------|---|-------|
| Plastic Bottle, 2kg Tub |            |   |       |
| Colour                  | Order Code | Colour  | Price |
| Black                   | 4474030    |    | £3.85 |
| Brilliant Blue          | 4474044    |    | £3.85 |
| Brilliant Green         | 4474046    |    | £3.85 |
| Brilliant Red           | 4474049    |    | £3.85 |
| Brilliant Orange        | 4474051    |   | £3.85 |
| Brilliant Yellow        | 4474055    |  | £3.85 |
| Burnt Sienna            | 4474074    |  | £3.85 |
| Burnt Umber             | 4474076    |  | £3.85 |
| Purple                  | 4474542    |  | £3.85 |
| White                   | 4474702    |  | £3.85 |



| Reeves Ready Mix Paint Assorted       |         |            |           |        |
|---------------------------------------|---------|------------|-----------|--------|
| Plastic Bottle with assorted Colours. |         |            |           |        |
| Description                           | Size    | Order Code | Pack Size | Price  |
| Metallic Paint                        | 500ml   | 4591286    | 10        | £18.99 |
| People Paint                          | 500ml   | 4591279    | 6         | £5.60  |
| Ready Mix                             | 500ml   | 4591273    | 20        | £17.30 |
| Ready Mix                             | 1 Litre | 4554AS8    | 8         | £13.82 |

| A Ocaldo Pearlescent Paint |   |            | £2.20 |
|----------------------------|---|------------|-------|
| Ready Mix Paint 284ml.     |   |            |       |
| Colour                     | Colour  | Order Code |       |
| Blue                       |  | 01210220   |       |
| Green                      |  | 01210221   |       |
| Pink                       |  | 01210222   |       |
| Red                        |  | 01210223   |       |
| Violet                     |  | 01210224   |       |
| Yellow                     |  | 01210225   |       |















| B Powder Paint  |   |                              |                              |
|---|---|------------------------------|------------------------------|
| Fine Ground, pure pigmentsm water soluble, non-toxic, various Colours. Made by Ocaldo. Sold in 2.5kg and 10Kg tubs. |   |                              |                              |
| Description   | Colour  | 2.5Kg<br>£3.20<br>Order Code | 10kg<br>£10.45<br>Order Code |
| Black   |    | -                            | 00176042                     |
| Brilliant Blue  |    | 00174031                     | 00176031                     |
| Brilliant Yellow  |    | 00174021                     | 00176021                     |
| Burnt Sienna  |    | 00174044                     | 00176044                     |
| Burnt Umber   |  | 00174043                     | -                            |
| Cobalt Blue   |  | 00174117                     | -                            |
| Crimson   |  | 00174027                     | -                            |
| Gamboge   |  | 00174022                     | -                            |
| Leaf Green  |  | 00174041                     | 00176041                     |
| Lemon   |  | 00174020                     | -                            |
| Ostwald Blue  |  | 00174033                     | -                            |
| Peach   |  | 00174024                     | -                            |
| Prussian Blue   |  | 00174034                     | -                            |
| Purple  |  | 00174029                     | 00176029                     |
| Sea Green   |  | 00174037                     | -                            |
| Sky Blue  |  | 00174067                     | -                            |
| Turquoise   |  | 00174036                     | 00176036                     |
| Vermillion  |  | 00174025                     | -                            |
| Violet  |  | 00174030                     | -                            |
| Emerald   |  | -                            | 00176038                     |
| Yellow Oche   |  | -                            | 00176045                     |

| C Acrylic Paint - 175ml |            |   |       |
|-------------------------|------------|---|-------|
| Plastic Bottle, 175ml.  |            |   |       |
| Colour                  | Order Code | Colour  | Price |
| Black                   | AK0801     |    | £1.50 |
| Brilliant Blue          | AK0802     |    | £1.50 |
| Brilliant Green         | AK0803     |    | £1.50 |
| Orange                  | AK0808     |    | £1.50 |
| Brilliant Yellow        | AK0805     |    | £1.50 |
| Burnt Sienna            | AK0806     |    | £1.50 |
| Crimson                 | AK0811     |  | £1.50 |
| Cyan                    | AK0843     |  | £1.50 |
| Lemon Yellow            | AK0812     |  | £1.50 |
| Purple                  | AK0838     |  | £1.50 |
| White                   | AK0807     |  | £1.50 |
| Red                     | AK0804     |  | £1.50 |
| Pack of 6 Assorted      | AK08AS6    |   | £8.65 |











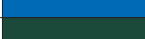



| Acrylic Paint - 500ml  |            |   |        |
|------------------------|------------|---|--------|
| Plastic Bottle, 500ml. |            |   |        |
| Colour                 | Order Code | Colour  | Price  |
| Black                  | AK08501    |  | £2.60  |
| Brilliant Blue         | AK08502    |  | £2.60  |
| Brilliant Green        | AK08503    |  | £2.60  |
| Orange                 | AK08508    |  | £2.60  |
| Brilliant Yellow       | AK08505    |  | £2.60  |
| Burnt Sienna           | AK08506    |  | £2.60  |
| Crimson                | AK08511    |  | £2.60  |
| Cyan                   | AK08538    |  | £2.60  |
| Lemon Yellow           | AK08512    |  | £2.60  |
| Purple                 | AK08514    |  | £2.60  |
| White                  | AK08507    |  | £2.60  |
| Red                    | AK08504    |  | £2.60  |
| Pack of 8 Assorted     | AK085AS8   |   | £20.15 |
| Pack of 12 Assorted    | AK085AS12  |   | £30.25 |

| Marabu Glitter Spray Paint |            |       |
|----------------------------|------------|-------|
| 150ml Spray Paint          |            |       |
| Colour                     | Order Code | Price |
| Silver                     | 210606-582 | £7.99 |
| Gold                       | 210606-584 | £7.99 |



| Block Printing Water Colours |   | £2.35      |
|------------------------------|---|------------|
| 300ml tubes. Single Colours  |   |            |
| Description                  | Colour  | Order Code |
| Black                        |  | AK0601     |
| Brilliant Blue               |  | AK0602     |
| Brilliant Green              |  | AK0603     |
| Brilliant Red                |  | AK0604     |
| Brilliant Yellow             |  | AK0605     |
| Burnt Sienna                 |  | AK0606     |
| Crimson                      |  | AK0611     |
| Lemon                        |  | AK0612     |
| Orange                       |  | AK0608     |
| Purple                       |  | AK0614     |
| Turquoise                    |  | AK0616     |
| White                        |  | AK0607     |



**FREE DELIVERY**  
on orders over £50

Minimum order value of £50.00 ex.VAT or small order administration charge of £7.50 will apply

|  |                   |              |
|--|-------------------|--------------|
| <b>A WaterColour Paint Box</b>                                   |                   | <b>£2.50</b> |
| Metal box with lift-Off lid and 12 assorted waterColour tablets. |                   |              |
| <b>Description</b>   | <b>Order Code</b> |              |
| WaterColour Set  | 4791380           |              |

|  |                   |              |
|--|-------------------|--------------|
| <b>Arts Inks</b>   |                   | <b>£4.15</b> |
| Concentrated inks suitable for painting, drawing or writing. 28ml bottles in 6 assorted Colour. Colours: Black, Green, Orange, Red, Violet and Yellow. |                   |              |
| <b>Description</b>   | <b>Order Code</b> |              |
| Art Inks Set   | AK166             |              |

|   |                   |               |
|---|-------------------|---------------|
| <b>B Palettes</b>                                     |                   | <b>£10.20</b> |
| Plastic palettes, 6 well, stackable. 57mm Pack Of 10. |                   |               |
| <b>Description</b>                                    | <b>Order Code</b> |               |
| To fit 57mm dia Colour block                          | 7012              |               |

|   |                  |                   |
|---|------------------|-------------------|
| <b>C Plastic Mixing Palette</b>               |                  | <b>£9.40</b>      |
| Stackable Plastic Mixing Palette, Pack of 10. |                  |                   |
| <b>Description</b>                            | <b>Pack Size</b> | <b>Order Code</b> |
| 11 well, 200 x 150mm                          | 10               | 7034-10           |

|                               |                  |                   |
|-------------------------------|------------------|-------------------|
| <b>Plastic Mixing Palette</b> |                  | <b>£0.80</b>      |
| Plastic Mixing Palette.       |                  |                   |
| <b>Description</b>            | <b>Pack Size</b> | <b>Order Code</b> |
| 12 well (6 round, 6 square)   | Each             | 7002              |

|                               |                  |                   |
|-------------------------------|------------------|-------------------|
| <b>Plastic Mixing Palette</b> |                  | <b>£0.60</b>      |
| Plastic Mixing Palette.       |                  |                   |
| <b>Description</b>            | <b>Pack Size</b> | <b>Order Code</b> |
| Round 175mm diameter          | Each             | 7004              |

|  |                  |                   |
|--|------------------|-------------------|
| <b>Plastic Mixing Palette</b>  |                  | <b>£1.80</b>      |
| Plastic Mixing Palette, large 340mm long kidney shape with thumb hole. |                  |                   |
| <b>Description</b>   | <b>Pack Size</b> | <b>Order Code</b> |
| Large 340mm  | Each             | 7008              |

|  |                  |                   |
|--|------------------|-------------------|
| <b>D Plastic Pots with Lids</b>        |                  | <b>£0.52</b>      |
| Plastic paint pots with non-spill lid. |                  |                   |
| <b>Description</b>                     | <b>Pack Size</b> | <b>Order Code</b> |
| Non-spill Plastic Paint Pots           | Each             | NSPPL             |

|  |                  |                   |
|--|------------------|-------------------|
| <b>Plastic Mixing Palette</b>  |                  | <b>£1.35</b>      |
| Plastic Mixing Palette. Flower shape 175mm diameter, 7 compartments. |                  |                   |
| <b>Description</b>   | <b>Pack Size</b> | <b>Order Code</b> |
| Flower Shape 175mm   | 2                | 7010              |



|  |                   |              |          |
|--|-------------------|--------------|----------|
| <b>Double Paint Roller Tray</b>        |                   | <b>£2.06</b> | <b>E</b> |
| Plastic double paint roller tray. Each |                   |              |          |
| <b>Description</b>                     | <b>Order Code</b> |              |          |
| 260 x 230 mm                           | 7000              |              |          |



|  |                  |                   |          |
|--|------------------|-------------------|----------|
| <b>Plastic Finger Bowl</b>   |                  | <b>£1.90</b>      | <b>F</b> |
| Plastic non-spill waterpot for storing Pencils Crayons etc. Assorted Colours set of 4. |                  |                   |          |
| <b>Description</b>   | <b>Pack Size</b> | <b>Order Code</b> |          |
| 130mm dia x 30mm Deep.   | 4                | 7015-4            |          |



|  |                  |                   |          |
|--|------------------|-------------------|----------|
| <b>Plastic Waterpot</b>  |                  | <b>£1.10</b>      | <b>G</b> |
| Plastic non-spill waterpot for storing Pencils Crayons etc. Assorted Colours set of 4. |                  |                   |          |
| <b>Description</b>   | <b>Pack Size</b> | <b>Order Code</b> |          |
| 110mm diameter at base.  | 4                | 7014              |          |



|  |               |                       |                   |
|--|---------------|-----------------------|-------------------|
| <b>Colour Paint Blocks - Single Colours</b>  |               |                       | <b>H</b>          |
| Fine Ground, pure pigments water soluble, non-toxic, various Colours. Made by Ocaldo. Sold in 2.5kg and 10Kg tubs. |               |                       |                   |
| <b>Description</b><br>57mm x 19mm  | <b>Colour</b> | <b>£1.58 Per Pack</b> | <b>Order Code</b> |
| Black  |               |                       | AL0201            |
| Blue   |               |                       | AL0202            |
| Sky Blue   |               |                       | AL0210            |
| Turquoise  |               |                       | AL0216            |
| Green  |               |                       | AL0203            |
| Leaf Green   |               |                       | AL0209            |
| Red  |               |                       | AL0204            |
| Yellow   |               |                       | AL0205            |
| Burnt Sienna   |               |                       | AL0206            |
| White  |               |                       | AL0207            |
| Orange   |               |                       | AL0208            |
| Crimson  |               |                       | AL0211            |
| Vermillion   |               |                       | AL0213            |
| Lemon  |               |                       | AL0212            |
| Purple   |               |                       | AL0214            |
| Burnt Umber  |               |                       | AL0221            |
| Yellow Ochre   |               |                       | AL0222            |

|   |                   |              |
|---|-------------------|--------------|
| <b>Colour Paint Blocks - Assorted</b>   |                   |              |
| Solid cakes Of compressed powder paint, water soluble, non-toxic . Assorted Colours. Box Of 6 cakes. Colours: Black, White, Red, Blue, Green & Yellow |                   |              |
| <b>Description</b>  | <b>Order Code</b> | <b>Price</b> |
| Size: 57mm x 19mm   | AL04              | £1.62        |

|   |                   |               |
|---|-------------------|---------------|
| <b>Reeves Paint Blocks</b>                                |                   | <b>£32.40</b> |
| Solid cakes Of compressed powder paint - Assorted Colours |                   |               |
| <b>Pack Size</b>  | <b>Order Code</b> |               |
| Class Pack Of 144 57mm x 19mm                             | 4792374           |               |

| A Crayola - Crayons Standard Size   |            |        |
|-------------------------------------|------------|--------|
| 90mm x 8mm, Assorted Strong Colours |            |        |
| Pack Size                           | Order Code | Price  |
| 8                                   | 8          | £0.72  |
| 24                                  | 24         | £1.47  |
| 288                                 | 244        | £17.46 |

| B Crayons - Scola Chubbi Stumps |            |       |
|---------------------------------|------------|-------|
| 57mm x 14mm, Assorted Colours.  |            |       |
| Pack Size                       | Order Code | Price |
| 8                               | AS818      | £0.91 |
| 40                              | AS40       | £2.66 |

| Crayola - Crayons Multicultural Pack |            | £1.85 |
|--------------------------------------|------------|-------|
| 90mm x 8mm, Assorted Colours         |            |       |
| Pack Size                            | Order Code |       |
| 8                                    | 844        |       |

| C Crayola My First Crayon     |            | £16.88 |
|-------------------------------|------------|--------|
| Classpack Of 144 (24 Colours) |            |        |
| Pack Size                     | Order Code |        |
| 144                           | 744        |        |

| Reeves Standard Crayons                       |            |       |
|---|------------|-------|
| Packs of 8 & 24 assorted coloured wax crayons |            |       |
| Pack Size                                     | Order Code | Price |
| 8   | 52042005   | £0.42 |
| 24  | 52026005   | £1.06 |

| Scola Plastic Crayons            |            |       |
|----------------------------------|------------|-------|
| 115 x 8mm dia, Assorted Colours. |            |       |
| Pack Size                        | Order Code | Price |
| 12                               | PXP12      | £1.26 |
| 300                              | PXP300     | £2.30 |



Crayons - Standard Size



Scola Chubbi Stumps

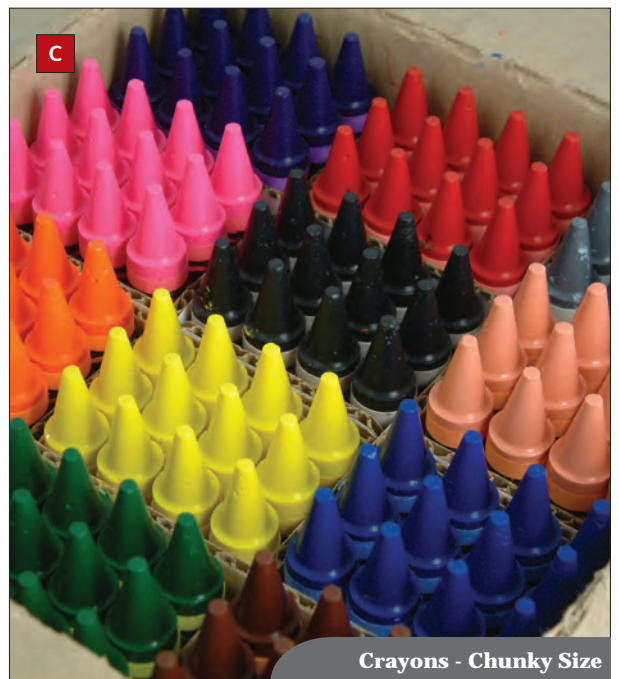

Crayons - Chunky Size

**Crayola Pencils - Full Length**

Full Length, Assorted Colours

| Pack Size | Order Code | Price |
|-----------|------------|-------|
| 12        | 3612       | £2.22 |
| 24        | 3624       | £3.94 |
| 36        | 3636       | £5.63 |

D



Crayola Pencils - Full Length

**Crayola Pencils - Half Length**

£1.29

Short Length, 12 Assorted Colours

| Pack Size | Order Code |
|-----------|------------|
| 12        | 4112       |

E



Crayola Pencils - Half Length

**Reeves Standard Soft Pastels**

Assorted Colours.

| Pack Size  | Order Code | Price  |
|------------|------------|--------|
| Box Of 12  | 8790125    | £2.20  |
| Box Of 288 | 4910212    | £33.30 |

**Crayons - Scola Chubblets**

Assorted Colours.

| Pack Size | Order Code | Size        | Price |
|-----------|------------|-------------|-------|
| 12        | CEP12      | 57mm x 14mm | £0.82 |
| 96        | CEP96      | 57mm x 14mm | £3.65 |

**Crayola Water Colour Marker Pen**

£27.58

Assorted Colours, ClassPack

| Pack Size | Order Code |
|-----------|------------|
| 144       | 7523       |

**Artist Pastel Sticks**

£6.80

Assorted Colours.

| Pack Size | Order Code |
|-----------|------------|
| 72        | 07850000   |

**Chalk Jumbo Sticks**

100mm x 25mm, Assorted Colours.

| Pack Size | Order Code | Price |
|-----------|------------|-------|
| 52        | CS1752     | £4.50 |
| 20        | CS1700     | £1.95 |

**Reeves Standard Oil Pastels**

Assorted Colours.

| Pack Size | Order Code | Price |
|-----------|------------|-------|
| Box Of 12 | 4880080    | £1.30 |
| Box Of 24 | 4881081    | £2.50 |



Reeves Standard Oil Pastels

**Crayola Water Colour Maker**

£36.36

Broad Tip ClassPack Of 144 - Assorted

| Pack Size | Order Code |
|-----------|------------|
| 144       | 7823       |

| Ocaldo Landscape Sketching Sticks                             |            | £1.80 |
|---|------------|-------|
| 12 Assorted square sketching sticks ideal for scetching work. |            |       |
| Description   | Order Code |       |
| Square Sticks   | 01964000   |       |

| Ocaldo Artist Pastel Sticks |            |       |
|-----------------------------|------------|-------|
| Assorted Colours.           |            |       |
| Description                 | Order Code | Price |
| Pack Of 12                  | 07849000   | £1.99 |
| Pack Of 24                  | 07854000   | £3.99 |

| A Crayola Chalk                              |            |       |
|--|------------|-------|
| Anti-dust. 12x 12 boxes. Pack Of 144 sticks. |            |       |
| Description                                  | Order Code | Price |
| White  | 280        | £7.98 |
| Assorted Colours                             | 281        | £9.36 |

| B Charcoal Sticks   |            |       |
|---------------------|------------|-------|
| Rowney Willow.      |            |       |
| Description         | Order Code | Price |
| Thin - Pack Of 15.  | 808010015  | £3.22 |
| Medium - Pack Of 25 | 808020025  | £5.86 |



| Charcoal Fixative |            | £8.66 |
|-------------------|------------|-------|
| Daler Rowney      |            |       |
| Description       | Order Code |       |
| 400ml Aerosol     | 114280000  |       |

| Black & White Board Duster                |            | £1.60 |
|---|------------|-------|
| Soft felt duster with plastic grip. Helix |            |       |
| Description                               | Order Code |       |
| 128 x 40 x 14mm                           | X43040     |       |

| Staedtler Noris Club Jumbo Oil Pastels                                     |            |       |
|--|------------|-------|
| Staedtler Jumbo Oil Pastels from their Noris Club Range. Assorted Colours. |            |       |
| Description  | Order Code | Price |
| Pack Of 12   | 243 NC12   | £1.80 |
| Pack Of 24   | 243 NC24   | £3.55 |

| Staedtler Noris Club Oil Pastels                                     |            |       |
|--|------------|-------|
| Staedtler Oil Pastels from their Noris Club Range. Assorted Colours. |            |       |
| Description  | Order Code | Price |
| Pack Of 12   | 241 NC12   | £1.05 |
| Pack Of 16   | 241 NC16   | £1.25 |
| Pack Of 25   | 241 NC25   | £1.95 |



| Berol Oil Pastels |            |        |
|-------------------|------------|--------|
| Assorted Colours. |            |        |
| Description       | Order Code | Price  |
| Pack Of 24        | OP24       | £3.15  |
| Pack Of 432       | OP3G       | £41.12 |

| C Berol Oil Pastels Black & White |            | £1.80 |
|-----------------------------------|------------|-------|
| Pack Of 12. 6 Of Each.            |            |       |
| Description                       | Order Code |       |
| Black & White                     | OPJBW12    |       |



| Mod Roc                |            |            |        |
|------------------------|------------|------------|--------|
| Plaster in Paris Rolls |            |            |        |
| Description            | Order Code | Pack Size  | Price  |
| ClassPack              | PB6000     | 36 Rolls   | £32.38 |
| Roll                   | PB2520     | 6cm x 2m   | £0.52  |
| Dispenser Pack 1 Roll  | AA8431     | 15cm x 80m | £18.55 |

| Mod Roc                |            |           |        |
|------------------------|------------|-----------|--------|
| Plaster Of Paris pack. |            |           |        |
| Description            | Order Code | Pack Size | Price  |
| White                  | PB7000     | 6.5kg pk  | £24.50 |

| Plaster of Paris                               |            |            |       |
|--|------------|------------|-------|
| Plaster of Paris for schools or home crafting. |            |            |       |
| Description                                    | Order Code | Pack Size  | Price |
| White  | CT5960     | 1 Kilo Bag | £1.65 |

| Modelling Material (Scola) - Assorted |                  |              | £7.66 |
|---------------------------------------|------------------|--------------|-------|
| 115mm x 8mm Bucket                    |                  |              |       |
| Pack Size                             | Colour           | Order Code   |       |
| 8 x 300g                              | Assorted Colours | OD2.4KG/8/AC |       |

| Modelling Material (Scola)                         |   |            |       |
|--|---|------------|-------|
| 500g Bar. Single Colours. Non toxic, film wrapped. |   |            |       |
| Description  | Colour  | Order Code | Price |
| Pink   |  | 1010303    | £1.05 |
| Stone  |  | 1010306    | £1.05 |
| Light Brown  |  | 1010315    | £1.05 |
| Yellow   |  | 1010321    | £1.05 |
| Orange   |  | 1010322    | £1.05 |
| Peach  |  | 1010323    | £1.05 |
| Red  |  | 1010324    | £1.05 |
| Purple   |  | 1010327    | £1.05 |
| Violet   |  | 1010328    | £1.05 |
| Dark Blue  |  | 1010329    | £1.05 |
| Light Blue   |  | 1010333    | £1.05 |
| Dark Green   |  | 1010336    | £1.05 |
| Light Green  |  | 1010337    | £1.05 |
| Black  |  | 1010338    | £1.05 |
| Dark Brown   |  | 1010339    | £1.05 |
| Terracotta   |  | 1010340    | £1.05 |
| Grey   |  | 1010342    | £1.05 |
| White  |  | 1010343    | £1.05 |
| Rainbow  |  | 1010348    | £1.17 |
| Assorted - Pk 20                                   |  | 10103/20/A | 18.23 |



| Modelling Material (Air Dying)       |            |           |       |
|--------------------------------------|------------|-----------|-------|
| Can be decorated using poster paints |            |           |       |
| Description                          | Order Code | Pack Size | Price |
| Newclay                              | H1125      | 12.5Kg    | £8.25 |
| Newclay - Stone                      | H225G      | 2.5Kg     | £4.25 |
| Newclay - Terracotta                 | H225T      | 2.5Kg     | £4.25 |

| Modelling Dough (Crayola Model Magic)         |            |           |        |
|---|------------|-----------|--------|
| Air drying, can be glued, carved and painted. |            |           |        |
| Description                                   | Order Code | Pack Size | Price  |
| White   | 4400       | 907g tub  | £17.46 |
| 4 Colour                                      | 4418       | 900g tub  | £18.82 |



| Modelling Dough (Soft-Mo)                                    |            |               |        |
|--|------------|---------------|--------|
| 2 kilo bucket of soft modelling dough with assorted colours. |            |               |        |
| Description  | Order Code | Pack Size     | Price  |
| Assorted Colours   | HA8202     | 2 Kilo Bucket | £26.50 |

| Helix Modelling Tools  |            |       |
|--|------------|-------|
| A fine set of 14 double ended plastic tools. Ideal for sculpting and contouring. |            |       |
| Description  | Order Code | Price |
| Double ended tools   | Q61020     | £2.40 |

| Plastic Knife Set                                |           | £1.10      |
|--|-----------|------------|
| Plastic Palette Knife set of 4 different Shapes. |           |            |
| Description                                      | Pack Size | Order Code |
| 4 Different Shapes                               | Each      | 740-4      |

| A Berol Colourmaker  |            |           |       |
|--|------------|-----------|-------|
| All round marker pen, reversible chisel tips for increased durability. |            |           |       |
| Description  | Order Code | Pack Size | Price |
| Assorted Colours (Chisel)  | CMID       | 12        | £6.99 |



Berol Colourmaker

| Berol Finewriter Pens          |                |           | £4.80 |
|--------------------------------|----------------|-----------|-------|
| Makes a superb sketching tool. |                |           |       |
| Description                    | Order Code     | Pack Size |       |
| Black                          | FW01           | 12        |       |
| Green                          | FW31 (S037822) | 12        |       |

| Berol Verithin Pencils   |            |           |        |
|--|------------|-----------|--------|
| Hard lead, ideal for detailing, can be sharpened to a pin-point. |            |           |        |
| Description  | Order Code | Pack Size | Price  |
| Black  | VT01       | 12        | £2.58  |
| Sky Blue   | VT08       | 12        | £2.58  |
| Carmine Red  | VT21       | 12        | £2.58  |
| Green  | VT31       | 12        | £2.58  |
| Light Green  | VT40       | 12        | £2.58  |
| Orange   | VT46       | 12        | £2.58  |
| Sienna Brown   | VT62       | 12        | £2.58  |
| Violet   | VT75       | 12        | £2.58  |
| White  | VT78       | 12        | £2.58  |
| Yellow Ochre   | VT89       | 12        | £2.58  |
| Canary Yellow  | VT80       | 12        | £2.58  |
| Assorted Colours   | VTW12      | 12        | £2.58  |
| Assorted ClassPack   | VTCP2G     | 288       | £60.50 |

| Berol Notewriter     |            |           | £4.80 |
|----------------------|------------|-----------|-------|
| General purpose pen. |            |           |       |
| Description          | Order Code | Pack Size |       |
| Black Ink            | NW01       | 12        |       |

| Berol Handwriting Pens       |            |           |        |
|------------------------------|------------|-----------|--------|
| Medium Nib, None fading ink. |            |           |        |
| Description                  | Order Code | Pack Size | Price  |
| Black                        | HP01       | 12        | £4.25  |
| Blue                         | HP02       | 12        | £4.25  |
| Black                        | HPBP01     | 200       | £69.10 |

| Berol Italic Pens                       |            |           | £8.50 |
|---|------------|-----------|-------|
| Ideal for Italic lettering. Medium Nib. |            |           |       |
| Colour                                  | Order Code | Pack Size |       |
| Black                                   | IPM01      | 12        |       |

| B Edding Colourfine Pens                    |            |           |        |
|---|------------|-----------|--------|
| Edding Colourfine, Colouring & Drawing Pens |            |           |        |
| Description                                 | Order Code | Pack Size | Price  |
| Black                                       | 1409001    | 12        | £2.85  |
| Red   | 1409002    | 12        | £2.85  |
| Assorted                                    | 1416999    | 12        | £2.85  |
| Assorted                                    | 1405000    | 42        | £8.99  |
| Assorted                                    | 300460000  | 288       | £55.60 |



Edding Colourfine Pens

| Edding Colourbroad Pens                     |            |           |        |
|---|------------|-----------|--------|
| Edding Colourfine, Colouring & Drawing Pens |            |           |        |
| Description                                 | Order Code | Pack Size | Price  |
| Black                                       | 1410001    | 12        | £2.85  |
| Red   | 1410002    | 12        | £2.85  |
| Assorted                                    | 1417999    | 12        | £2.85  |
| Assorted                                    | 1406000    | 42        | £8.99  |
| Assorted                                    | 300461000  | 288       | £55.60 |





**Berol Handhuggers Pencils**

## Crayola Pencils

General school use.

| Description      | Order Code | Pack Size | Price |
|------------------|------------|-----------|-------|
| Assorted Colours | 3612       | 12        | £2.22 |
| Assorted Colours | 3624       | 24        | £3.94 |

## Crayola Coloured Pencils

Half and full lengths available, assorted Colours.

| Description              | Order Code | Pack Size | Price |
|--------------------------|------------|-----------|-------|
| Half Length              | 4112       | 12        | £1.29 |
| Full Length - 36 Colours | 3636       | 36        | £5.63 |

## Lakeland Colouring Pencils

Traditional round barrelled colour pencils.

| Description         | Order Code | Pack Size | Price  |
|---------------------|------------|-----------|--------|
| Assorted Wallet     | 33356      | 12        | £1.50  |
| Assorted Class Pack | 33329      | 360       | £39.75 |

## Lakeland Colourland Pencils

Round barrelled colour pencils.

| Description         | Order Code | Pack Size | Price  |
|---------------------|------------|-----------|--------|
| Assorted Class Pack | 0700078    | 360       | £36.90 |

## Helix Erasers

Pencil erasers.

| Description           | Order Code | Pack Size | Price |
|-----------------------|------------|-----------|-------|
| 30 x 12 x 6mm erasers | Y72100     | 30 Pack   | £5.28 |
| 34 x 20 x 8mm erasers | Y94040     | 40 Pack   | £2.60 |
| 10 x 12 x 6mm erasers | Y97040     | 72 Pack   | £3.25 |

## Berol Handhuggers Pencils

Ideal for small hands.

| Description      | Order Code | Pack Size | Price |
|------------------|------------|-----------|-------|
| Assorted Colours | HHCLW12    | 12        | £6.12 |

## Coloured Half Length Pencils

£0.55

| Order Code | Pack Size | Colour   |
|------------|-----------|----------|
| ITR00002   | 12        | Assorted |

## Coloured Pencils - Assorted Colours

| Order Code | Pack Size | Price  |
|------------|-----------|--------|
| EDU076     | 24        | £1.72  |
| EDU077     | 144       | £10.24 |
| EDU078     | 288       | £20.20 |



**Lakeland Colouring Pencils**



**Helix Erasers**

| A Blacklead Pencils - HB Grattells Tray |           |        |
|---|-----------|--------|
| Order Code                              | Pack Size | Price  |
| RJG95                                   | 720       | £38.30 |
| RJG96                                   | 1440      | £72.82 |



Blacklead Pencils

| B Blacklead Pencils - HB |           |       |
|--------------------------|-----------|-------|
| Order Code               | Pack Size | Price |
| EDU057                   | 12        | £0.75 |
| EDU057/144               | 144       | £8.99 |



Blacklead Pencils

| C Thick Blacklead Pencils |           |       |
|---------------------------|-----------|-------|
| Order Code                | Pack Size | Price |
| EDU056                    | Tub of 36 | £7.82 |



Thick Blacklead Pencils

| Marbling Inks |           |             |       |
|---------------|-----------|-------------|-------|
| Order Code    | Pack Size | Colour      | Price |
| MI256A        | 6 x 25ml  | Standard    | £4.92 |
| MIF256A       | 6 x 25ml  | Fluorescent | £5.80 |
| MIM256A       | 6 x 25ml  | Metallic    | £5.80 |

| D Waterproof Drawing Ink |           |        | £3.45 |
|--------------------------|-----------|--------|-------|
| Order Code               | Pack Size | Colour |       |
| AK1401                   | 600ml     | Black  |       |



Drawing Ink

| E Waterproof Drawing Ink |           |                  | £0.99 |
|--------------------------|-----------|------------------|-------|
| Order Code               | Pack Size | Colour           |       |
| 03288020                 | 28ml      | Lemon            |       |
| 03288021                 | 28ml      | Brilliant Yellow |       |
| 03288023                 | 28ml      | Orange           |       |
| 03288025                 | 28ml      | Vermillion       |       |
| 03288026                 | 28ml      | Brilliant Red    |       |
| 03288027                 | 28ml      | Crimson          |       |
| 03288030                 | 28ml      | Violet           |       |
| 03288031                 | 28ml      | Brilliant Blue   |       |
| 03288034                 | 28ml      | Prussian Blue    |       |
| 03288038                 | 28ml      | Emerald          |       |
| 03288040                 | 28ml      | Brilliant Green  |       |
| 03288043                 | 28ml      | Burnt Umber      |       |
| 03288044                 | 28ml      | Burnt Sienna     |       |
| 03288046                 | 28ml      | White            |       |
| 03288048                 | 28ml      | Gold             |       |
| 03288049                 | 28ml      | Silver           |       |
| 03288108                 | 28ml      | Viridian         |       |
| 03288117                 | 28ml      | Colbalt Blue     |       |



| Scissors          |              |       |
|-------------------|--------------|-------|
| Training Scissors |              |       |
| Order Code        | Type         | Price |
| 4019              | Right Handed | £0.60 |
| 4065              | Left Handed  | £1.99 |

| Scissors    |             |              |
|-------------|-------------|--------------|
| Left Handed |             |              |
| Order Code  | Type        | Size         |
| 4004        | Left Handed | 4" Blunt End |



| Scissors                          |           |      |
|-----------------------------------|-----------|------|
| Plastic Safety Scissors Pack of 8 |           |      |
| Order Code                        | Type      | Size |
| 4022                              | Round End | 5.5" |

| School Scissors & Wooden Block                 |                   |  |
|--|-------------------|--|
| Pack Of both right and left handed. Pack of 32 |                   |  |
| Order Code                                     | Type              |  |
| 4091   | 28 Right & 4 Left |  |

| School Scissors                                       |              |  |
|---|--------------|--|
| Bulk Pack Of both right and left handed. Pack of 100. |              |  |
| Order Code  | Type         |  |
| 4005C   | Right & Left |  |

| Scissors            |             |  |
|---------------------|-------------|--|
| Easy Grip Scissors. |             |  |
| Order Code          | Type        |  |
| 4163                | Left Handed |  |

| Scissors                  |                 |  |
|---------------------------|-----------------|--|
| Spring assisted Scissors. |                 |  |
| Order Code                | Type            |  |
| 4177                      | Spring Assisted |  |

| Scissors          |           |             |
|-------------------|-----------|-------------|
| Cold forged steel |           |             |
| Order Code        | Type      | Size        |
| 4084              | Round End | 12cm (4.5") |



| Scissors                                  |           |           |
|---|-----------|-----------|
| School Scissor with Blunt End - 10cm (5") |           |           |
| Order Code                                | Type      | Size      |
| 4002                                      | Blunt End | 10cm (5") |

| Scissors Westcott Kids                                 |             |           |
|--|-------------|-----------|
| Westcott Kids scissors pointed 5" with Plastic Handles |             |           |
| Order Code   | Type        | Size      |
| E-20548  | Pointed End | 10cm (5") |



## Berol Dry White Board Cleaners

| Order Code | Type                    | Price  |
|------------|-------------------------|--------|
| DWCI       | 8oz Bottle              | £2.77  |
| DWEM30     | Mini Erasers, Bag Of 30 | £26.10 |

## Berol Dry Wipe Marker Pens

Marker pens for wipe boards, Round Tips.

| Order Code | Colour   | Pack Size | Price  |
|------------|----------|-----------|--------|
| DWWMR01    | Black    | 12        | £7.37  |
| DWWMR02    | Blue     | 12        | £7.37  |
| DWWMR54    | Red      | 12        | £7.37  |
| DWWMRBP01  | Black    | 48        | £25.35 |
| DWWMRBPA   | Assorted | 48        | £25.35 |
| DWWMRW4    | Assorted | 4         | £3.15  |
| DWWMRW8    | Assorted | 8         | £5.72  |

A

## Berol Dry Wipe Marker Chisel Pens

Marker pens for wipe boards, Chisel Tips.

| Order Code | Colour   | Pack Size | Price  |
|------------|----------|-----------|--------|
| DWMMW01    | Black    | 12        | £7.37  |
| DWMMW02    | Blue     | 12        | £7.37  |
| DWMMW31    | Green    | 12        | £7.37  |
| DWMMW54    | Red      | 12        | £7.37  |
| DWMMWBP01  | Black    | 48        | £25.32 |
| DWMMWBPA   | Assorted | 48        | £25.32 |
| DWMMWW8    | Assorted | 8         | £5.72  |



Dry Wipe Markers

B

## Staedtler White Board Markers

Bullet Tip, pack of 10 black white board markers.

| Order Code | Pack Size | Price |
|------------|-----------|-------|
| 3419       | 10        | £4.60 |



White Board Marker

C

## Staedtler Highlighter Markers

Assorted Colours

| Order Code | Pack Size | Price |
|------------|-----------|-------|
| 364WP4     | 4         | £2.40 |
| 364WP6     | 6         | £3.50 |
| 364WP8     | 8         | £4.65 |



Highlighter Markers

## Berol - White Board Pens

Bullet tip - Assorted Colours: Black, Blue, Green & Red

| Description           | Order Code | Pack Size | Price  |
|-----------------------|------------|-----------|--------|
| Assorted Colours Fine | DWPPW8     | 8         | £3.75  |
| Black - Fine          | DWPP01     | 12        | £5.72  |
| Black - Broad         | DWPPBT01   | 12        | £5.72  |
| Black - Fine          | DWPPBP01   | 200       | £88.30 |



| Staedtler Maths Set   |            | £1.95     |
|---|------------|-----------|
| Staedtler Maths set in sturdy lightweight tin containing ruler, protractor, 90 & 45 degree set squares, pencil, sharpener, rubber, compass and stencil. |            |           |
| Description   | Order Code | Pack Size |
| Matths Set  | 557-10     | Each      |

| Set Squares                                   |            |           |       |
|---|------------|-----------|-------|
| Clear plastic, available in 60 and 45 degree. |            |           |       |
| Description                                   | Order Code | Pack Size | Price |
| 60 degrees Geometrix                          | 40260      | 10 Pack   | £1.05 |
| 45 degrees Geometrix                          | 40245      | 10 Pack   | £1.05 |

| Helix Whiteboard / Blackboard Compass              |            | £5.99     |
|--|------------|-----------|
| Helix Compass to use on Blackboards & Whiteboards. |            |           |
| Description  | Order Code | Pack Size |
| Whiteboard / Blackboard Compass                    | X20040     | Each      |

| Helix Compass - Pupil                   |            |           |       |
|---|------------|-----------|-------|
| Traditional and safety variants. Helix. |            |           |       |
| Description                             | Order Code | Pack Size | Price |
| Metal, safe short pin.                  | G05030     | 10 Pack   | £7.40 |
| Coloured safety compass                 | G03040     | 5 Pack    | £5.90 |

| Helix Geometry Sets                 |            | £1.40     |
|-------------------------------------|------------|-----------|
| Boxed sets Of geometry instruments. |            |           |
| Description                         | Order Code | Pack Size |
| Value Maths Set                     | A54000     | Each      |

| Helix 1m Rulers                     |            | Each  |
|-------------------------------------|------------|-------|
| Helix Metrix 1 metre Ruler (1000mm) |            |       |
| Description                         | Order Code | Price |
| White                               | Z83040     | £2.58 |
| Yellow                              | X47040     | £4.16 |

| Shatterproof Rulers - White Plastic |            | £1.52     |
|-------------------------------------|------------|-----------|
| 30cm High Impact.                   |            |           |
| Description                         | Order Code | Pack Size |
| Metric (Geometrix)                  | 30RW37     | 10 Pack   |

| Protractors                      |            | £0.95     |
|----------------------------------|------------|-----------|
| 10cm, Clear plastic, 180 degree. |            |           |
| Description                      | Order Code | Pack Size |
| Geometrix                        | 402180     | 10 Pack   |

| Shatterproof Rulers - Clear Plastic |            | £1.52     |
|-------------------------------------|------------|-----------|
| 30cm High Impact.                   |            |           |
| Description                         | Order Code | Pack Size |
| Metric ( Geometric )                | 30NSC37    | 10        |
| Metric & Imperial ( Geometric )     | 12NSC37    | 10        |

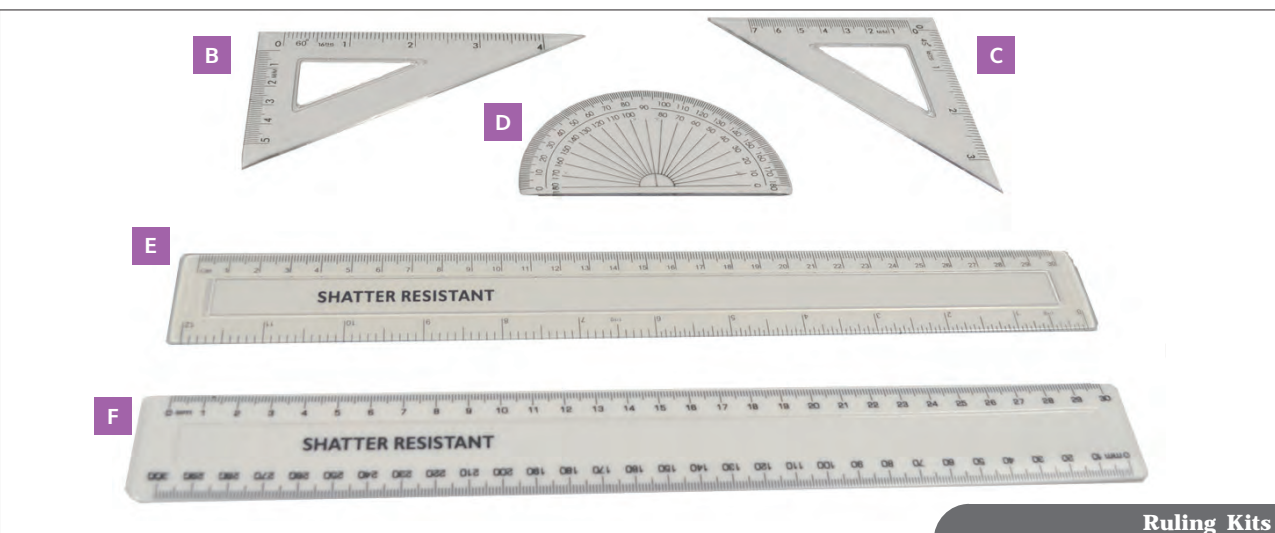

## Swann-Morton Craft Knives & Blades

Knives and Blades

| Description                 | Order Code | Pack Size | Price |
|-----------------------------|------------|-----------|-------|
| Straight & Curved Knife     | 1231       | 1         | £0.86 |
| Straight Blades to fit 1231 | 1241       | 50        | £4.38 |
| Curved to fit 1231          | 1242       | 50        | £4.38 |

## Swann-Morton Arts, Craft & Modellers Set

10 Precision Carbon Steel Blades and 3 Handles, Ideal for Cutting Requirements

| Order Code | Price  |
|------------|--------|
| 9101       | £18.75 |

## Swann-Morton Arts, Craft & Modellers

No1 Handle, No11 Size Blade.

| Order Code | Price |
|------------|-------|
| 9105       | £2.55 |

## Swann-Morton Arts, Craft & Modellers

Spare Blades for No1 Handle, No11 Size Blade Pack Of 5

| Order Code | Price |
|------------|-------|
| 9131       | £1.69 |

## Swann-Morton Arts, Craft & Modellers

Knife with Retractable Blade, supplied with 5 x No10A Sized blades.

| Order Code | Price |
|------------|-------|
| 9201       | £5.04 |

## Swann-Morton Arts, Craft & Modellers

Trimaway Knife Set, 3 x Handles Each fitted with a No25A blade & Guard

| Order Code | Price |
|------------|-------|
| 9205       | £2.55 |

## Swann-Morton Arts, Craft & Modellers

No3 Handle with 5 x No10A Size Blades

| Order Code | Price |
|------------|-------|
| 9210       | £3.40 |

## Swann-Morton Arts, Craft & Modellers

Spare Blades No10A Blades Pack Of 5.

| Order Code | Price |
|------------|-------|
| 9272       | £1.69 |

## A Pom-Poms

Assorted Colours and Sizes

| Description       | Order Code | Pack Size | Price |
|-------------------|------------|-----------|-------|
| Standard Pom-Poms | 2567BX     | 100       | £2.99 |
| Glitter Pom-Poms  | PG0100PK   | 100       | £3.50 |

## B Pipe Cleaners

Assorted Colours.

| Description         | Order Code | Pack Size | Price |
|---------------------|------------|-----------|-------|
| 15cm Standard       | CT4060     | 100       | £0.80 |
| 30cm Chenille       | CT4065     | 100       | £1.48 |
| 30cm Tinsel         | CT4080     | 100       | £2.05 |
| 15cm x 4mm Assorted | CT4057     | 1000      | £5.90 |
| 15cm x 4mm Assorted | CT4055     | 250       | £1.65 |



Pipe Cleaners

## C Art Straws

Plastic straws for creative paint effects, modelling and creative design.

| Description           | Order Code | Pack Size | Price  |
|-----------------------|------------|-----------|--------|
| Regular 4mm diameter  | AA9030     | 1800      | £14.99 |
| Coloured 4mm diameter | AA9035     | 1800      | £17.80 |
| Assorted 6mm diameter | AA9036     | 900       | £17.80 |
| White 6mm diameter    | AA9031     | 900       | £14.99 |

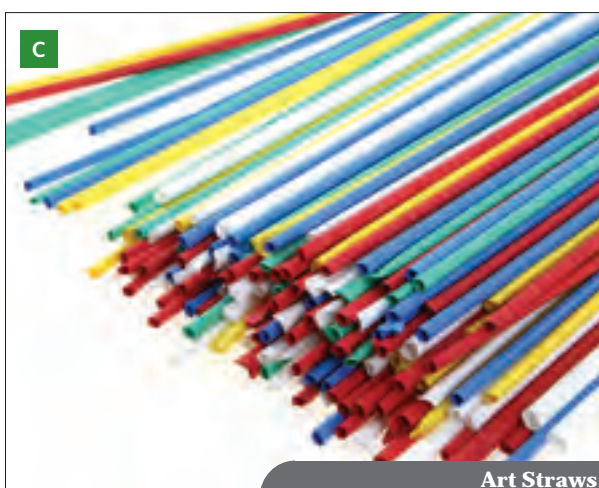

Art Straws



A

Pom-Poms



D

Glitter Tubs - 500g



E

Glitter Tubs - 150g

| Glue Spreaders                             |       |
|--|-------|
| Plastic Spatula Glue Spreaders pack of 75. |       |
| Order Code                                 | Price |
| 6003-75                                    | £4.80 |

| Disposable Aprons                     |        |
|---------------------------------------|--------|
| Disposable Plastic aprons Pack Of 100 |        |
| Order Code                            | Price  |
| 91240                                 | £15.99 |

| Glitter Tubs                      |            |           |       |
|-----------------------------------|------------|-----------|-------|
| 500g Of sparkling glitter Per tub |            |           |       |
| Description                       | Order Code | Pack Size | Price |
| Gold                              | AG8555     | 1 Tub     | £6.99 |
| Silver                            | AG8556     | 1 Tub     | £6.99 |
| Red                               | AG8504     | 1 Tub     | £6.99 |
| Blue                              | AG8502     | 1 Tub     | £6.99 |
| Green                             | AG8503     | 1 Tub     | £6.99 |
| Lavender                          | AG8559     | 1 Tub     | £6.99 |
| Purple                            | AG8514     | 1 Tub     | £6.99 |
| Bronze                            | AG8557     | 1 Tub     | £6.99 |

| Glitter Tubs                      |            |           |       |
|-----------------------------------|------------|-----------|-------|
| 150g Of sparkling glitter Per tub |            |           |       |
| Description                       | Order Code | Pack Size | Price |
| Gold                              | AG1355     | 1 Tub     | £3.38 |
| Silver                            | AG1356     | 1 Tub     | £3.38 |
| Red                               | AG1304     | 1 Tub     | £3.38 |
| Blue                              | AG1302     | 1 Tub     | £3.38 |
| Green                             | AG1303     | 1 Tub     | £3.38 |
| Lilac                             | AG1359     | 1 Tub     | £3.38 |
| Purple                            | AG1314     | 1 Tub     | £3.38 |
| Bronze                            | AG1357     | 1 Tub     | £3.38 |
| Multi-Coloured                    | AG1358     | 1 Tub     | £3.38 |

| Glitter Glue Pens                   |                  |           |        |
|-------------------------------------|------------------|-----------|--------|
| Assorted Pack of Glitter Glue pens. |                  |           |        |
| Order Code                          | Pack Type        | Pack Size | Price  |
| CT2065                              | Assorted - 12ml  | 30        | £4.85  |
| CS3380                              | ClassPack - 10ml | 72        | £12.50 |



F

Glitter Glue Pens

|                                  |                   |              |
|----------------------------------|-------------------|--------------|
| <b>Glitter Snow Flake</b>        |                   | <b>£3.66</b> |
| White Snow Flake in a Shaker Jar |                   |              |
| <b>Size</b>                      | <b>Order Code</b> |              |
| 150 Grammes                      | AG12100           |              |

|                              |                   |              |
|------------------------------|-------------------|--------------|
| <b>Feathers &amp; Quills</b> |                   |              |
| Assorted Colours.            |                   |              |
| <b>Description</b>           | <b>Order code</b> | <b>Price</b> |
| 14g - Assorted               | 259980            | £1.72        |
| 25g - Natural                | FT720010          | £2.60        |
| 25g - Exotic                 | FT750010          | £2.60        |
| 50g - Assorted               | FT613010          | £4.50        |
| Pack Of 14 Quills - Turkey   | FT7400            | £3.48        |
| Pack Of 10 Peacock           | FT7300            | £3.48        |
| ClassPack Assorted           | FT8000            | £12.95       |

|                                     |  |              |
|-------------------------------------|--|--------------|
| <b>A</b>                            | <b>Helix Drawing Board Metal Clips</b> | <b>£0.13</b> |
| Multi-purpose / Drawing Board clips |  |              |
| <b>Pack Size</b>                    | <b>Order Code</b>                      |              |
| Each                                | Q58050                                 |              |



|                                   |                   |              |
|-----------------------------------|-------------------|--------------|
| <b>White Cotton String</b>        |                   | <b>£5.40</b> |
| White Cotton String Medium, 500g. |                   |              |
| <b>Description</b>                | <b>Order Code</b> |              |
| White Cotton                      | 78702             |              |

|                        |               |              |              |
|------------------------|---------------|--------------|--------------|
| <b>B</b>               |               |              |              |
| <b>Sentence Strips</b> |               |              |              |
| Pack of 100            |               |              |              |
| <b>Order Code</b>      | <b>Type</b>   | <b>Size</b>  | <b>Price</b> |
| 73400                  | Rainbow Kraft | 76mm x 609mm | £4.10        |
| 73490                  | Kaleidoscope  | 76mm x 609mm | £4.90        |



|                           |                   |              |
|---------------------------|-------------------|--------------|
| <b>Sequins Stack Pack</b> |                   | <b>£4.25</b> |
| Assorted Colours & Shapes |                   |              |
| <b>Pack Size</b>          | <b>Order Code</b> |              |
| 5                         | 25010             |              |

|                  |                         |              |
|------------------|-------------------------|--------------|
| <b>C</b>         | <b>Assorted Sequins</b> | <b>£3.30</b> |
| <b>Pack Size</b> | <b>Order Code</b>       |              |
| 85 grammes       | 1585599                 |              |



|                              |                    |              |
|------------------------------|--------------------|--------------|
| <b>Carry Craft Container</b> |                    |              |
| To store pencils, pens etc.  |                    |              |
| <b>Order Code</b>            | <b>Description</b> | <b>Price</b> |
| RBDL                         | 226 x 116 x 55mm   | £1.10        |
| RBA4                         | 304 x 216 x 55mm   | £2.30        |



|  |                   |              |          |
|--|-------------------|--------------|----------|
| <b>White Face Masks</b>                            |                   | <b>£5.75</b> | <b>D</b> |
| Pe Elasticated Masks that can be easily decorated. |                   |              |          |
| <b>Pack Size</b>                                   | <b>Order Code</b> |              |          |
| 10   | L-MU0001          |              |          |



|  |                   |               |          |
|--|-------------------|---------------|----------|
| <b>Acrylic Shiny Jewels</b>              |                   | <b>£13.60</b> | <b>G</b> |
| Flat Backed, Assorted Colours and Sizes. |                   |               |          |
| <b>Pack Size</b>                         | <b>Order Code</b> |               |          |
| 450g                                     | 1859959           |               |          |

|                                |                   |              |
|--------------------------------|-------------------|--------------|
| <b>Assorted Acrylic Jewels</b> |                   | <b>£3.30</b> |
| <b>Pack Size</b>               | <b>Order Code</b> |              |
| 70 grammes                     | 1585629           |              |

|                                    |                   |                  |
|------------------------------------|-------------------|------------------|
| <b>Pearls</b>                      |                   | <b>£4.25</b>     |
| Bright assorted Colours and Sizes. |                   |                  |
| <b>Description</b>                 | <b>Order Code</b> | <b>Pack Size</b> |
| 156g Pack                          | 1585582           | Each             |

|                                    |                   |              |          |
|------------------------------------|-------------------|--------------|----------|
| <b>Wiggly Eyes</b>                 |                   | <b>£5.50</b> | <b>E</b> |
| 5mm, 7mm, 10mm & 15mm & Oval 20mm. |                   |              |          |
| <b>Pack Size</b>                   | <b>Order Code</b> |              |          |
| 560                                | 1842895           |              |          |

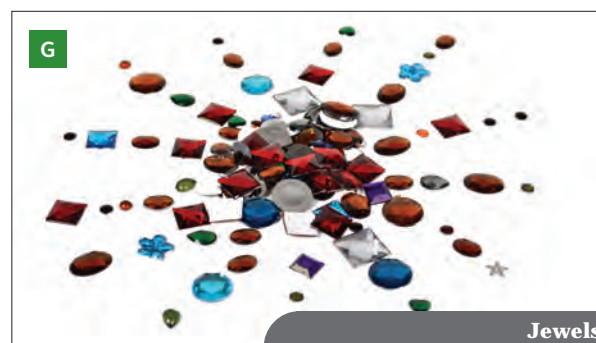

|   |                   |                  |          |
|---|-------------------|------------------|----------|
| <b>Iridescent Shreds</b>                  |                   | <b>£6.95</b>     | <b>H</b> |
| Light refracting, multi-Colour film roll. |                   |                  |          |
| <b>Description</b>                        | <b>Order Code</b> | <b>Pack Size</b> |          |
| 200g Pack                                 | 7318-SHRED        | Each             |          |

|                                    |                   |              |          |
|------------------------------------|-------------------|--------------|----------|
| <b>Buttons</b>                     |                   |              | <b>F</b> |
| Bright assorted Colours and Sizes. |                   |              |          |
| <b>Description</b>                 | <b>Order Code</b> | <b>Price</b> |          |
| 450g Pack                          | 25100             | £6.20        |          |



|   |                   |                  |
|---|-------------------|------------------|
| <b>Iridescent Film</b>                    |                   | <b>£4.60</b>     |
| Light refracting, multi-Colour film roll. |                   |                  |
| <b>Description</b>                        | <b>Order Code</b> | <b>Pack Size</b> |
| 914mm x 3.8m roll                         | 73180             | Each             |

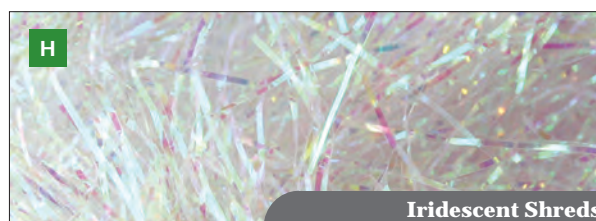

|  |                  |                   |
|--|------------------|-------------------|
| <b>Plastic Knife Set</b>                         |                  | <b>£1.10</b>      |
| Plastic Palette Knife set of 4 different Shapes. |                  |                   |
| <b>Description</b>                               | <b>Pack Size</b> | <b>Order Code</b> |
| 4 Different Shapes                               | 4                | 740-4             |

| Stick It! Glue Guns |             |                           |       |
|---------------------|-------------|---------------------------|-------|
| Order Code          | Description | Price                     |       |
| A                   | STI1000     | Cool Melt Glue Gun - Blue | £8.69 |
| B                   | STI2000     | Hot Melt Glue Gun - Red   | £8.69 |



| Glue Sticks       |                      |        |
|-------------------|----------------------|--------|
| Glue Sticks - 40g |                      |        |
| Order Code        | Pack Size            | Price  |
| G12E              | 12                   | £5.64  |
| G12E100           | 100 - Gratnells Tray | £48.70 |



| Clu Tac - Blue           |            | £0.90     |
|--------------------------|------------|-----------|
| Adhesive reusable putty. |            |           |
| Description              | Order Code | Pack Size |
| Blue                     | GL17       | 90g       |



| Stick It! Glue Gun Sticks |             |                              |       |
|---------------------------|-------------|------------------------------|-------|
| Order Code                | Description | Price                        |       |
| E                         | STI1001     | Cool Melt Glue Sticks - Blue | £1.96 |
|                           | STI2001     | Hot Melt Glue Sticks - Red   | £1.96 |



| Photomount Adhesive Spray Cans    |       |        |
|-----------------------------------|-------|--------|
| 3M Photomount adhesive spray can. |       |        |
| Order Code                        | Size  | Price  |
| 043029                            | 200ml | £8.45  |
| 043010                            | 400ml | £12.15 |

| Spraymount Adhesive Spray Cans    |       |        |
|-----------------------------------|-------|--------|
| 3M Spraymount adhesive spray can. |       |        |
| Order Code                        | Size  | Price  |
| 36001200                          | 200ml | £8.75  |
| 36001400                          | 400ml | £13.85 |



Adhesive Spray Cans

| Cellulose Paste Powder  | £0.67      |           |
|---|------------|-----------|
| Water soluble, forms a thick paste. For Paper and Card. Also thickens poster paint. Non toxic. 1 Pack makes 5 litres, for students that are unable to use regular PVA Glue. |            |           |
| Description   | Order Code | Pack Size |
| Paste Powder 45g  | GL15       | Each      |

| Masking Tape             | £1.00      |           |
|--------------------------|------------|-----------|
| 25mm x 50m Masking Tape. |            |           |
| Description              | Order Code | Pack Size |
| 25mm x 50m roll          | 22521      | Each      |

| Finger Lift Adhesive Tape  |            |       |
|----------------------------|------------|-------|
| Double Sided Adhesive Tape |            |       |
| Order Code                 | Size       | Price |
| FLT1250                    | 12mm x 50  | £1.99 |
| FLT1850                    | 18mm x 50m | £2.65 |
| FLT650                     | 6mm x 50m  | £1.32 |

| PVA Glue - Red Label |         |       |
|----------------------|---------|-------|
| Washable PVA Glue    |         |       |
| Order Code           | Size    | Price |
| GL01                 | 5 Litre | £9.75 |
| GL07                 | 1 Litre | £2.52 |
| GL22                 | 500ml   | £1.63 |
| GL08                 | 180ml   | £0.86 |

| PVA Glue - Blue Label                   |         |       |
|---|---------|-------|
| Washable PVA Glue, Suitable for Infants |         |       |
| Order Code                              | Size    | Price |
| GL18                                    | 5 Litre | £6.82 |
| GL19                                    | 1 Litre | £1.80 |
| GL14                                    | 500ml   | £1.23 |
| GL16                                    | 180ml   | £0.76 |



PVA Glue

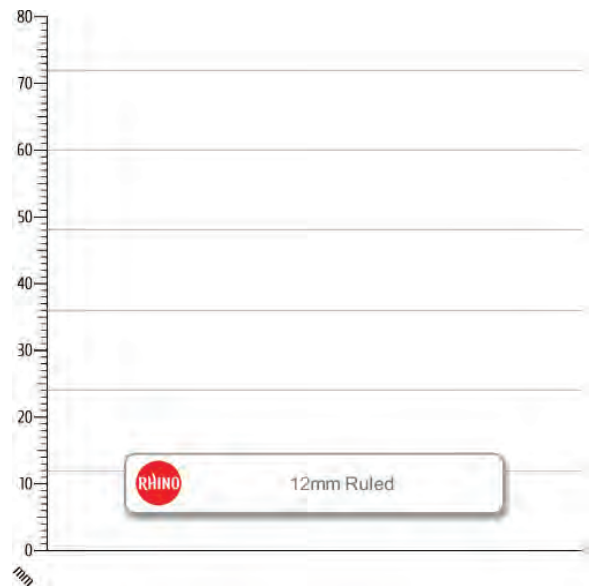
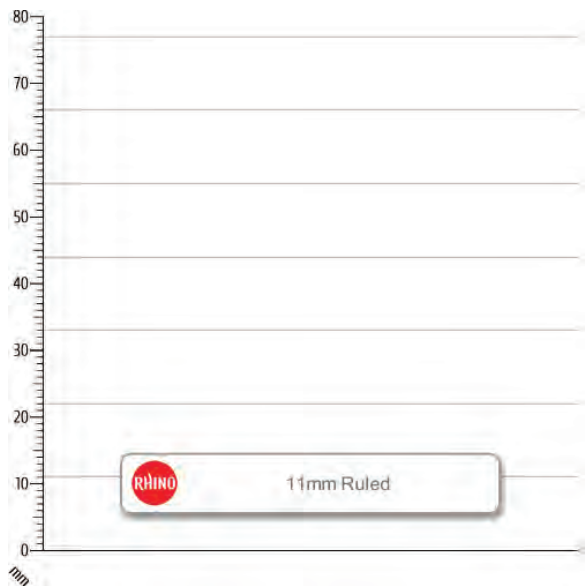
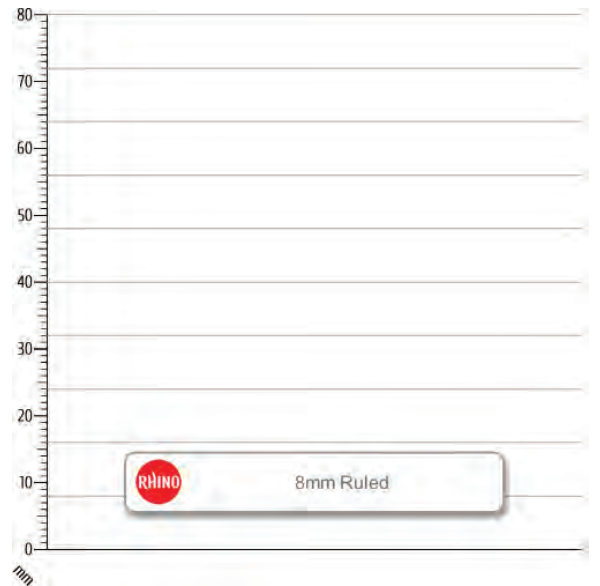
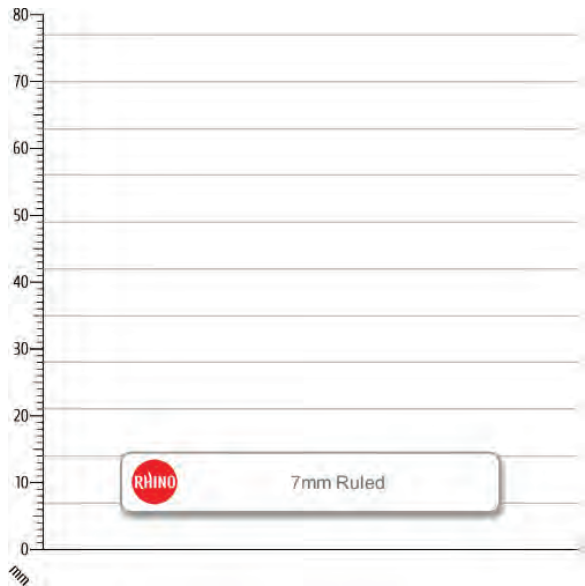
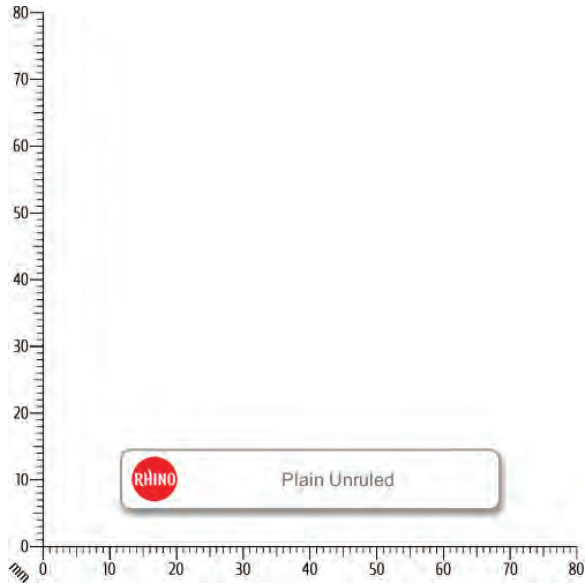

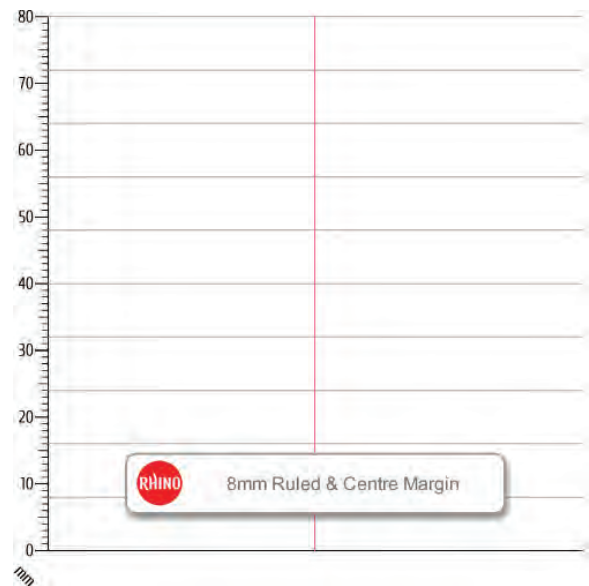
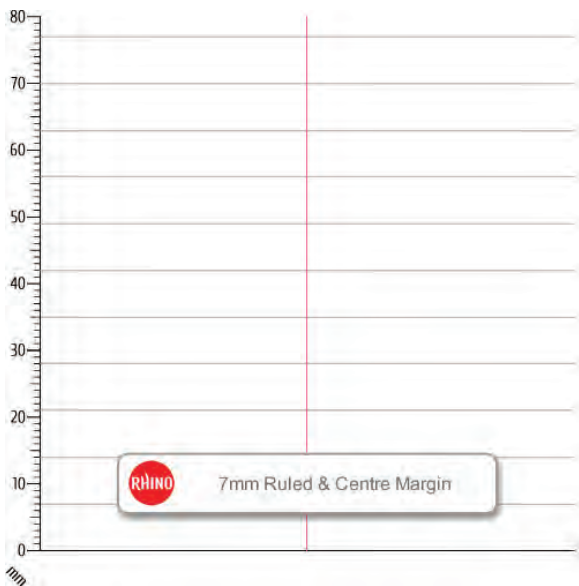
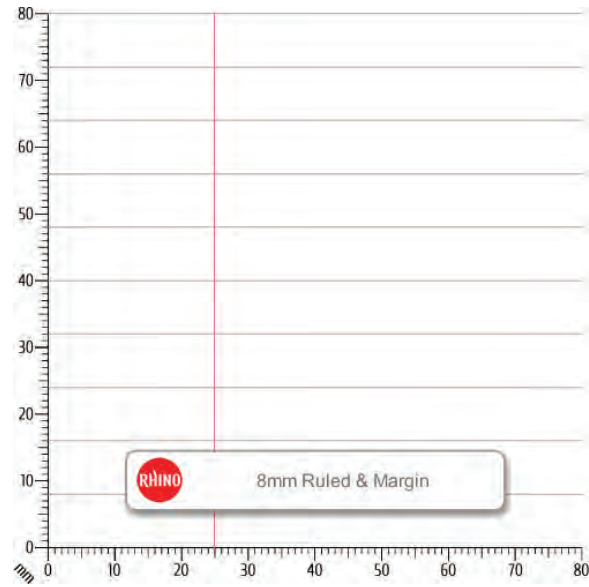
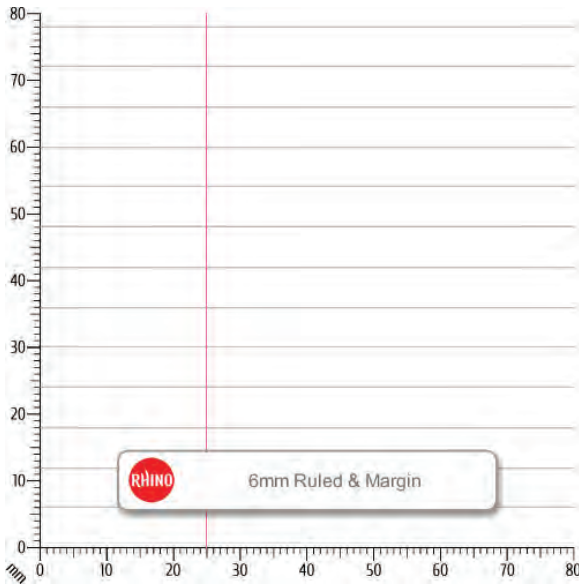
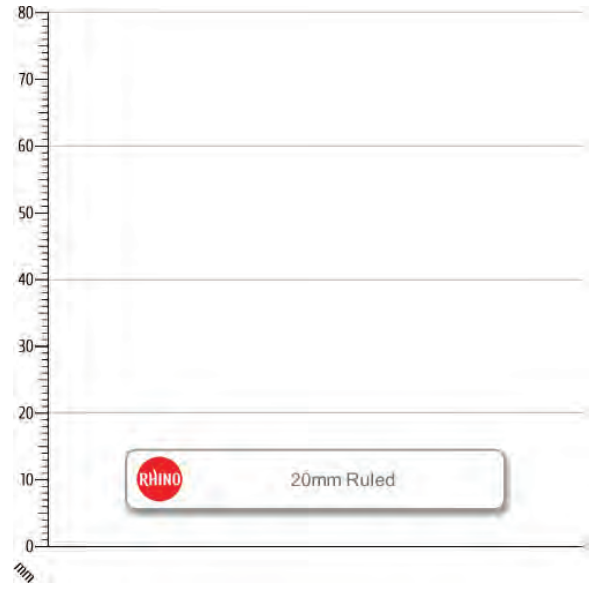
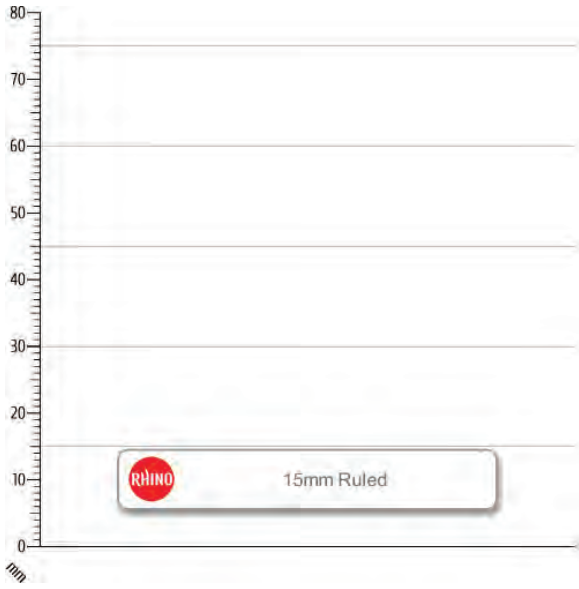

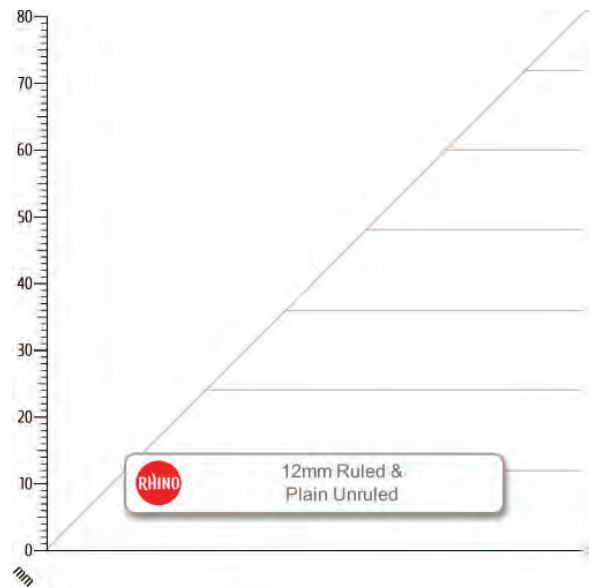
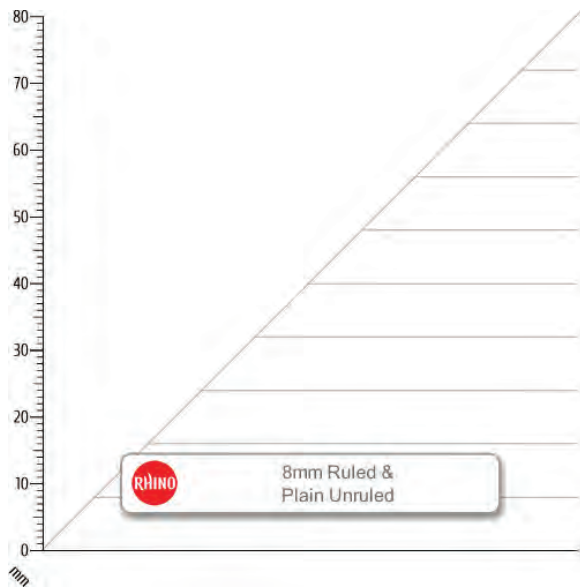
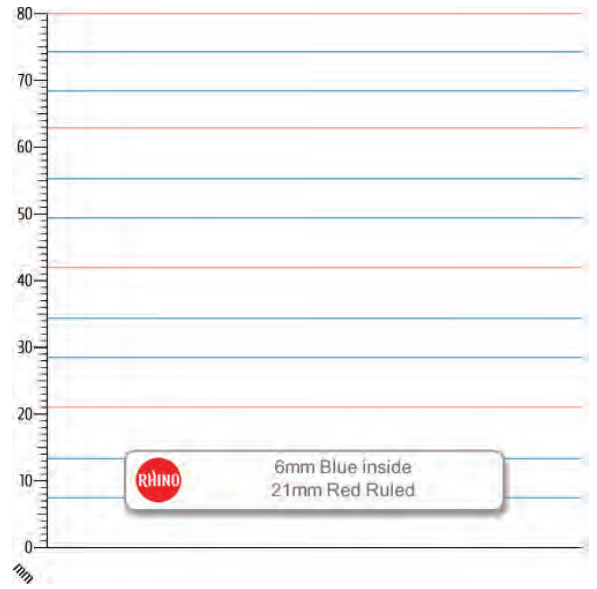
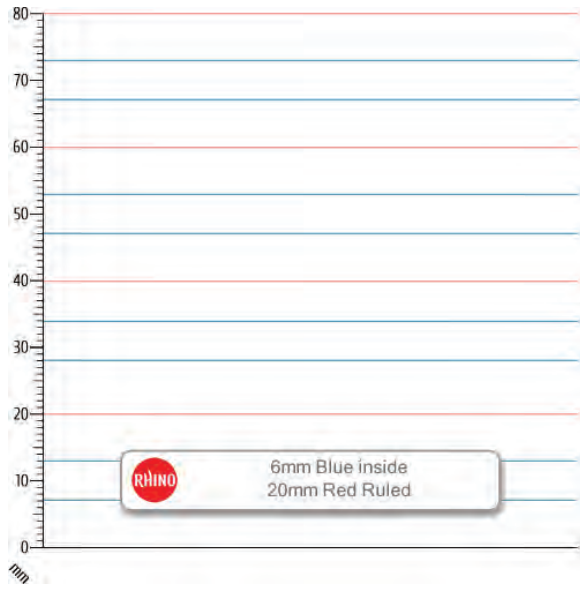
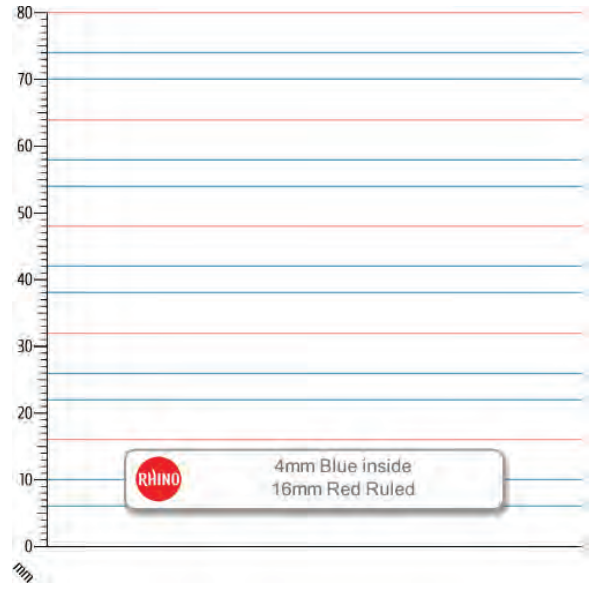
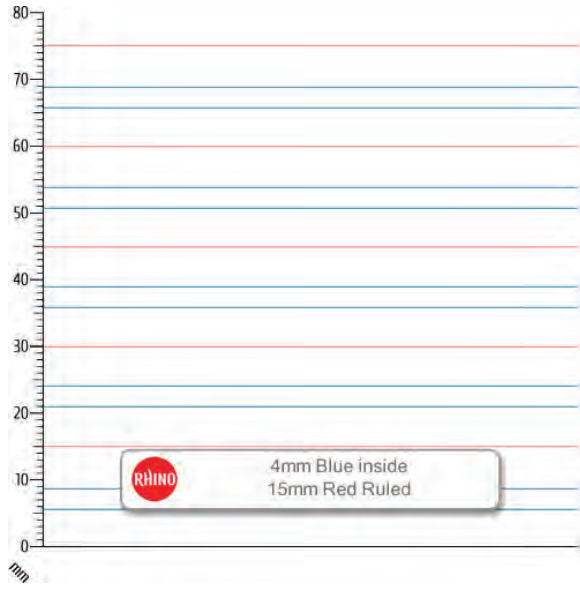

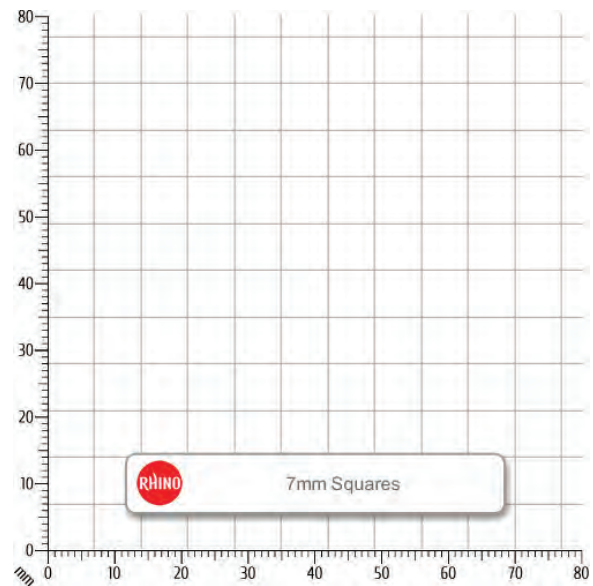
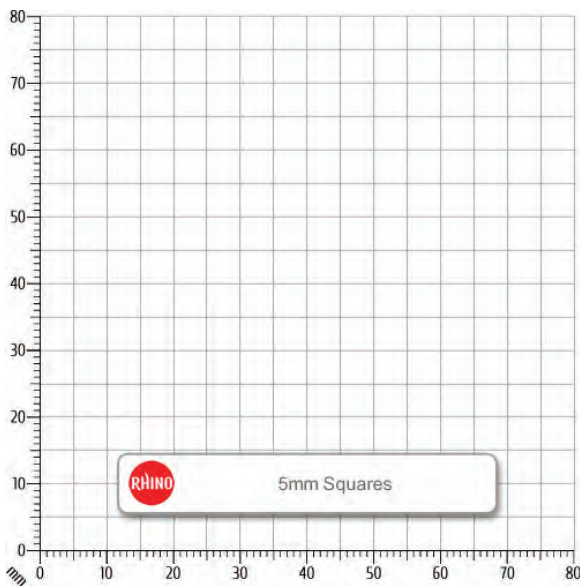
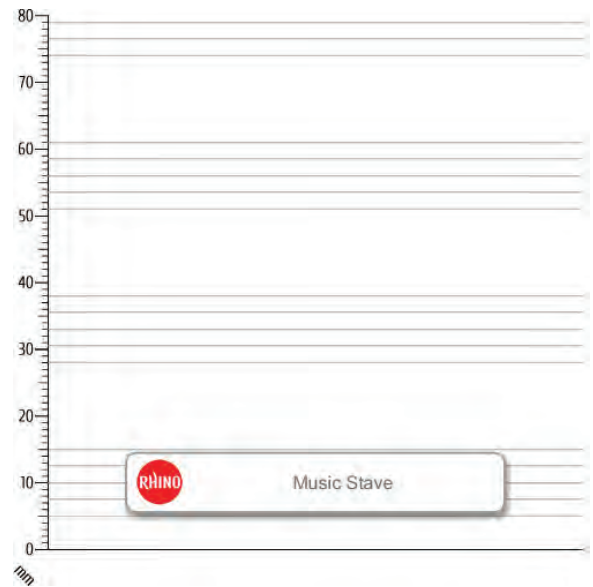
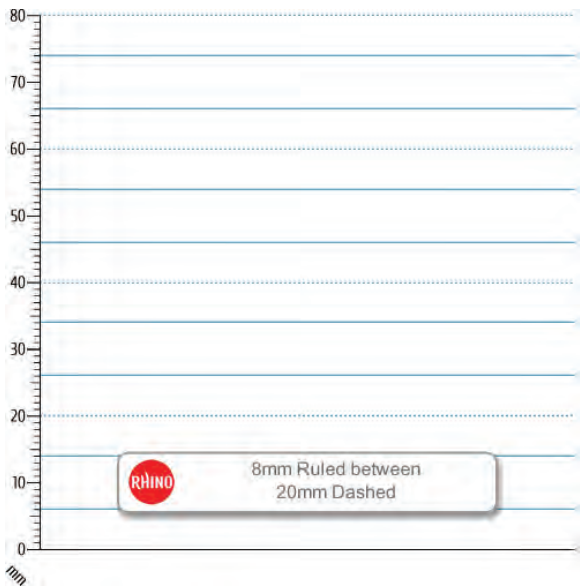
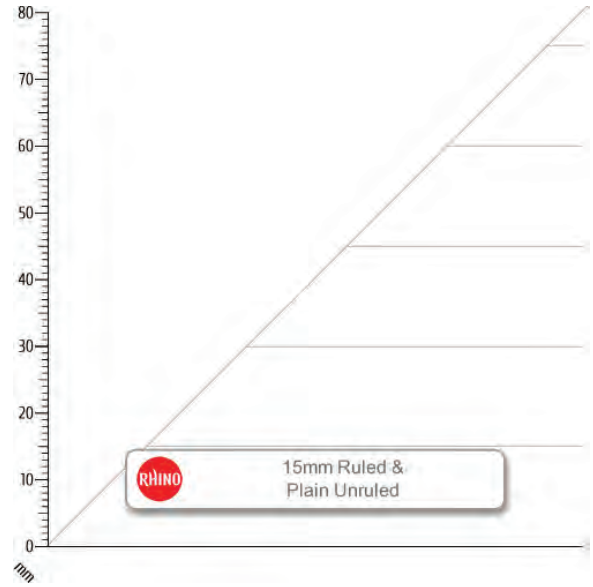
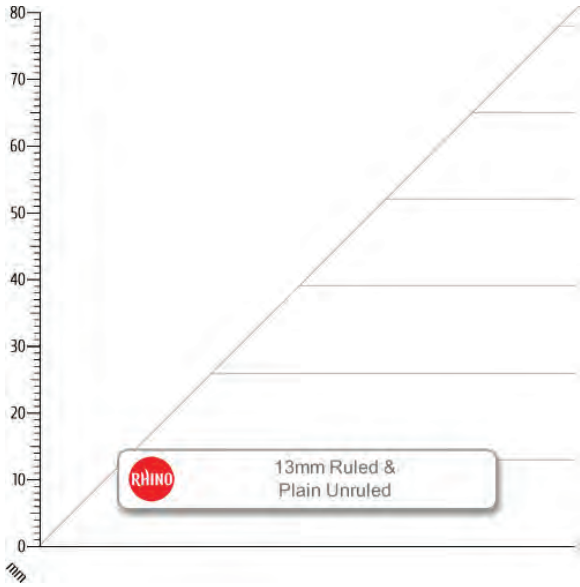

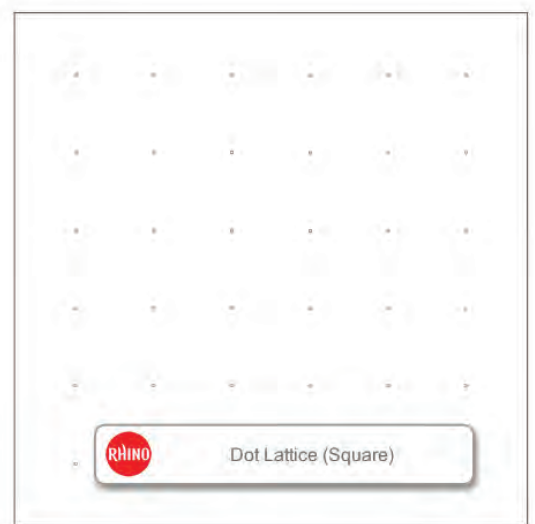
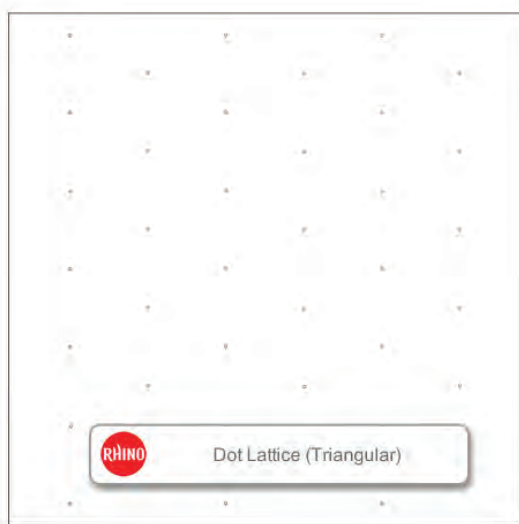
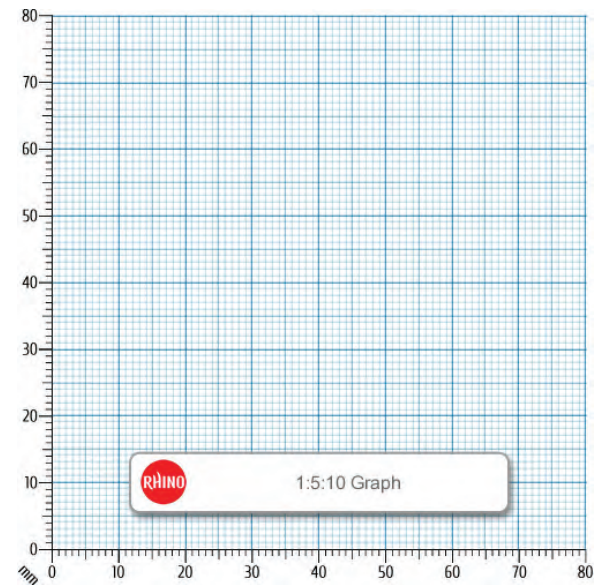
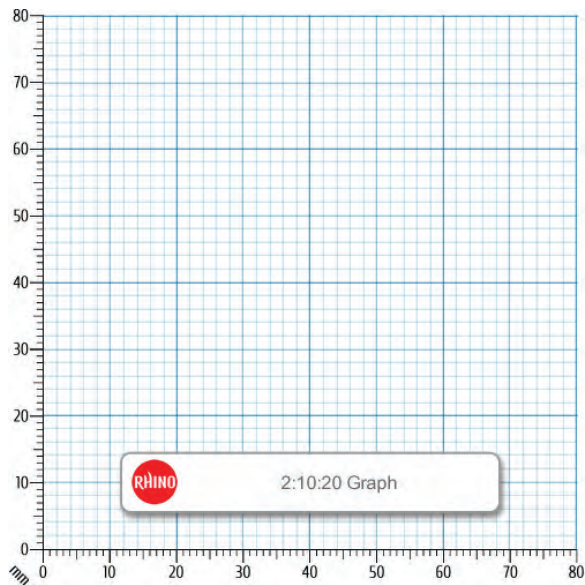
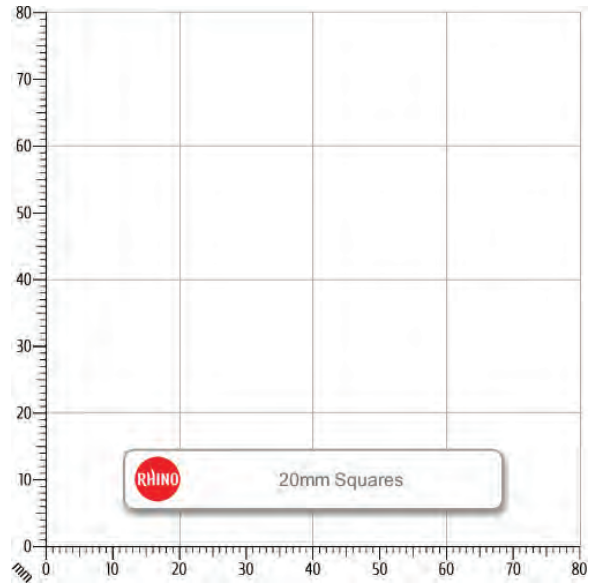
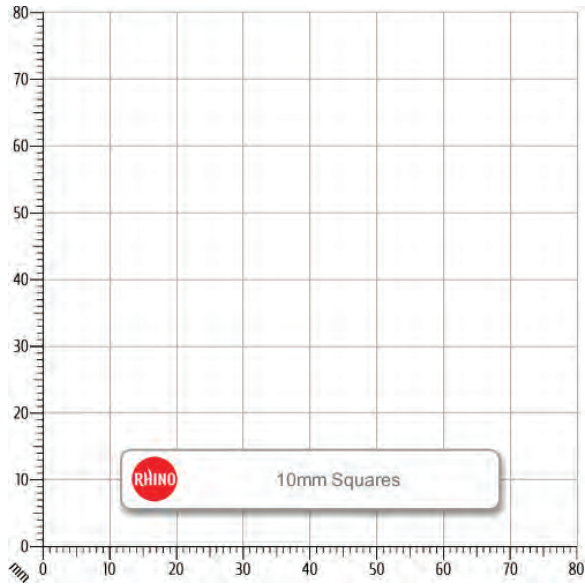



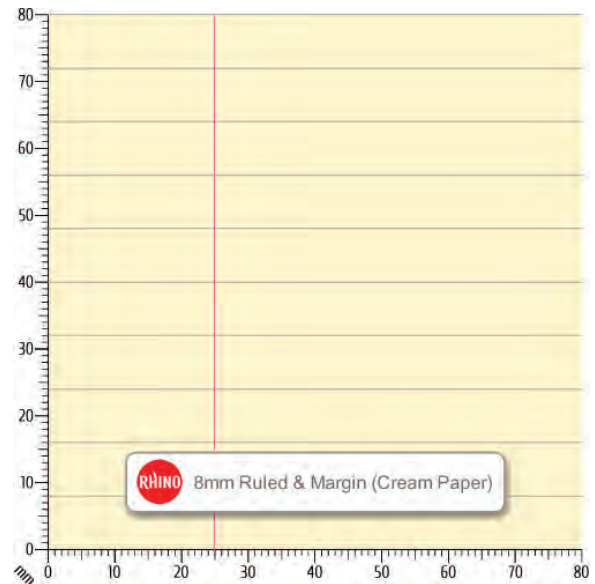
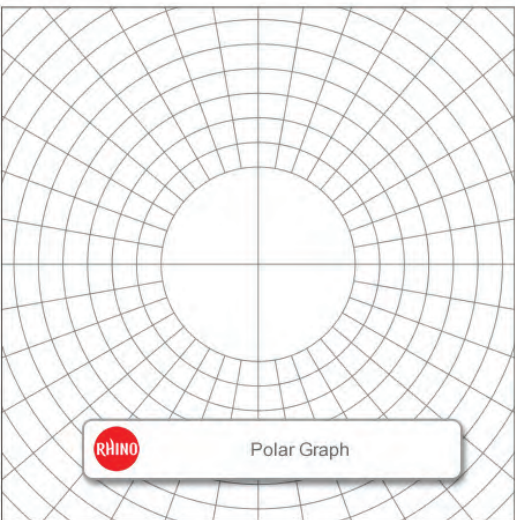
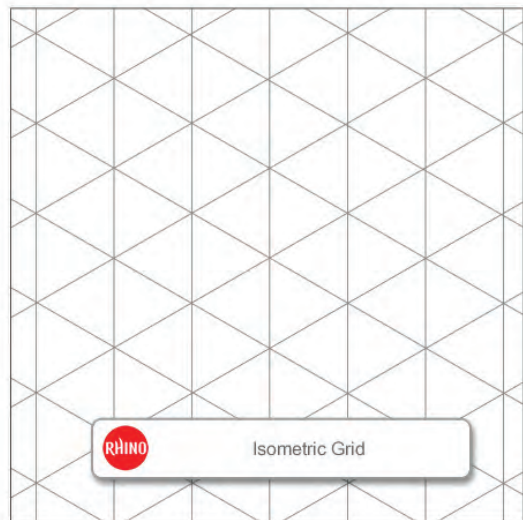

## Books & Pads Binding Guide

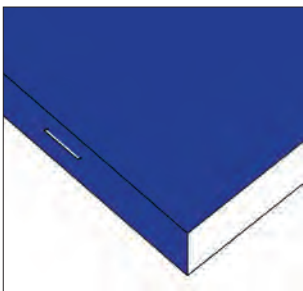

**Staplebound**

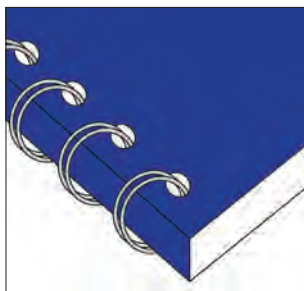

**Wirebound**

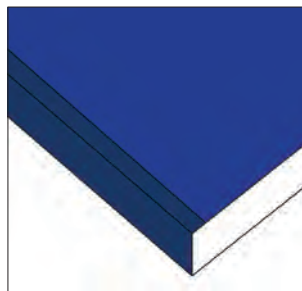

**Tapebound**

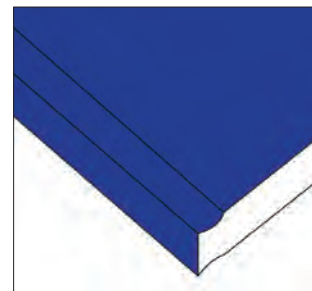

**Hard Cover**



Dark Green



Light Blue



Light Green



Buff



Dark Blue



Orange



Pink



Red



Yellow



Purple



Grey



Assorted  
(Colours Vary)

| Ref        | Ruling                          | Size                       | Cover Colour | Pages | Packed | Price Per Pack | Page No. |
|------------|---------------------------------|----------------------------|--------------|-------|--------|----------------|----------|
| EX032130   | Blank Unruled                   | 5.25" x 6.5" (133 x 165mm) | Purple       | 24    | 100    | £10.75         | 4        |
| NB01250    | Blank Unruled                   | 6.5" x 4" (165 x 102mm)    | Yellow       | 48    | 100    | £13.65         | 14       |
| AA004      | Blank Unruled                   | 6.25" x 8" (160 x 203mm)   | Yellow       | 32    | 100    | £17.99         | 4        |
| NB005106   | Blank Unruled                   | 8" x 4" (203 x 102mm)      | Green        | 32    | 100    | £12.90         | 12       |
| EX142152   | Blank Unruled                   | 8" x 6.5" (203 x 165mm)    | Pink         | 32    | 100    | £14.40         | 4        |
| EX34224    | Blank Unruled                   | 8" x 6.5" (203 x 165mm)    | Pink         | 48    | 100    | £11.99         | 4        |
| EX342448   | Blank Unruled                   | 8" x 6.5" (203 x 165mm)    | Yellow       | 48    | 100    | £11.99         | 4        |
| EX67640    | Blank Unruled                   | 8" x 6.5" (203 x 165mm)    | Pink         | 64    | 100    | £23.75         | 6        |
| EX54415    | Blank Unruled                   | 8" x 6.5" (203 x 165mm)    | Pink         | 80    | 100    | £25.40         | 6        |
| VRE01114   | Blank Unruled (Rough Work Book) | 8" x 6.5" (203 x 165mm)    | Pink         | 96    | 100    | £28.10         | 6        |
| PW02346    | Blank Unruled                   | 9" x 7" (230 x 178mm)      | Blue         | 32    | 100    | £23.70         | 7        |
| EX35221    | Blank Unruled                   | 9" x 7" (230 x 178mm)      | Pink         | 48    | 100    | £21.00         | 7        |
| VEX352-105 | Blank Unruled                   | 9" x 7" (230 x 178mm)      | Orange       | 48    | 100    | £21.00         | 7        |
| EX55412    | Blank Unruled                   | 9" x 7" (230 x 178mm)      | Dark Blue    | 80    | 100    | £19.99         | 8        |
| EX55425    | Blank Unruled                   | 9" x 7" (230 x 178mm)      | Pink         | 80    | 100    | £19.99         | 8        |
| EX554368   | Blank Unruled                   | 9" x 7" (230 x 178mm)      | Yellow       | 80    | 100    | £19.99         | 8        |
| VRE02812   | Blank Unruled (Rough Work Book) | 9" x 7" (230 x 178mm)      | Pink         | 96    | 100    | £31.65         | 14       |
| DU01484    | Blank Unruled                   | A4 (300 x 210mm)           | Blue         | 32    | 100    | £23.20         | 9        |
| DU01471    | Blank Unruled                   | A4 (300 x 210mm)           | Green        | 32    | 100    | £23.20         | 9        |
| Du014123   | Blank Unruled                   | A4 (300 x 210mm)           | Pink         | 32    | 100    | £23.20         | 9        |
| DU04110    | Blank Unruled                   | A4 (300 x 210mm)           | Purple       | 32    | 100    | £23.20         | 9        |
| DU01497    | Blank Unruled                   | A4 (300 x 210mm)           | Red          | 32    | 100    | £23.20         | 9        |
| DU014107   | Blank Unruled                   | A4 (300 x 210mm)           | Yellow       | 32    | 100    | £23.20         | 9        |
| EX68113    | Blank Unruled                   | A4 (300 x 210mm)           | Red          | 48    | 100    | £29.70         | 9        |
| EX68126    | Blank Unruled                   | A4 (300 x 210mm)           | Dark Green   | 48    | 100    | £29.70         | 9        |
| EX68125    | Blank Unruled                   | A4 (300 x 210mm)           | Pink         | 48    | 100    | £29.70         | 9        |
| EX681368   | Blank Unruled                   | A4 (300 x 210mm)           | Yellow       | 48    | 100    | £29.70         | 9        |
| VRE01078-5 | Blank Unruled                   | A4 (300 x 210mm)           | Red          | 60    | 50     | £12.25         | 9        |
| EX677400-5 | Blank Unruled                   | A4 (300 x 210mm)           | Buff         | 64    | 50     | £16.45         | 10       |
| EX677409-5 | Blank Unruled                   | A4 (300 x 210mm)           | Light Blue   | 64    | 50     | £16.45         | 10       |

| Ref        | Ruling             | Size                    | Cover Colour  | Pages | Packed | Price Per Pack | Page No. |
|------------|--------------------|-------------------------|---------------|-------|--------|----------------|----------|
| EX677410-5 | Blank Unruled      | A4 (300 x 210mm)        | Light Green   | 64    | 50     | £16.45         | 10       |
| EX67785-5  | Blank Unruled      | A4 (300 x 210mm)        | Red           | 64    | 50     | £16.45         | 10       |
| EX677136-5 | Blank Unruled      | A4 (300 x 210mm)        | Yellow        | 64    | 50     | £16.45         | 10       |
| EX668409-5 | Blank Unruled      | A4 (300 x 210mm)        | Light Blue    | 80    | 50     | £16.55         | 11       |
| EX66823-5  | Blank Unruled      | A4 (300 x 210mm)        | Pink          | 80    | 50     | £16.55         | 11       |
| EX66820-5  | Blank Unruled      | A4 (300 x 210mm)        | Red           | 80    | 50     | £16.55         | 11       |
| EX668136-5 | Blank Unruled      | A4 (300 x 210mm)        | Yellow        | 80    | 50     | £16.55         | 11       |
| DU01770    | Blank Unruled      | 8" x 10" (200 x 250mm)  | Yellow        | 32    | 100    | £24.75         | 15       |
| Du01783    | Blank Unruled      | 8" x 10" (200 x 250mm)  | Light Blue    | 32    | 100    | £24.75         | 15       |
| Du01796    | Blank Unruled      | 8" x 10" (200 x 250mm)  | Red           | 32    | 100    | £24.75         | 15       |
| DU01740    | Blank Unruled      | 8" x 10" (200 x 250mm)  | Light Green   | 32    | 100    | £24.75         | 15       |
| DU01716    | Blank Unruled      | 8" x 10" (200 x 250mm)  | Pink          | 32    | 100    | £24.75         | 15       |
| DU017119   | Blank Unruled      | 8" x 10" (200 x 250mm)  | Asstd Colours | 32    | 100    | £24.75         | 15       |
| DU02410    | Blank Unruled      | 13" x 10" (330 x 250mm) | Red           | 40    | 100    | £36.50         | 15       |
| DU02812    | Blank Unruled      | 13" x 10" (330 x 250mm) | Blue          | 40    | 100    | £36.50         | 15       |
| DU02423    | Blank Unruled      | 13" x 10" (330 x 250mm) | Purple        | 40    | 100    | £36.50         | 15       |
| DU02436    | Blank Unruled      | 13" x 10" (330 x 250mm) | Green         | 40    | 100    | £36.50         | 15       |
| DU02449    | Blank Unruled      | 13" x 10" (330 x 250mm) | Pink          | 40    | 100    | £36.50         | 15       |
| DU02452    | Blank Unruled      | 13" x 10" (330 x 250mm) | Yellow        | 40    | 100    | £36.50         | 15       |
| DU0218     | Blank Unruled      | 13" x 10" (330 x 250mm) | Asstd Colours | 40    | 100    | £36.50         | 15       |
| NB02220    | 6mm Ruled          | 8" x 4.5" (200 x 115mm) | Light Blue    | 80    | 100    | £29.20         | 14       |
| EX342150   | 6mm Ruled          | 8" x 6.5" (203 x 165mm) | Red           | 48    | 100    | £11.99         | 4        |
| EX54444    | 6mm Ruled          | 8" x 6.5" (203 x 165mm) | Grey          | 80    | 100    | £25.40         | 6        |
| EX55454    | 6mm Ruled          | 9" x 7" (230 x 178mm)   | Grey          | 80    | 100    | £19.99         | 8        |
| EX342244   | 6mm Ruled & Margin | 8" x 6.5" (203 x 165mm) | Light Green   | 48    | 100    | £11.99         | 4        |
| EX342422   | 6mm Ruled & Margin | 8" x 6.5" (203 x 165mm) | Red           | 48    | 100    | £11.99         | 4        |
| EX67679    | 6mm Ruled & Margin | 8" x 6.5" (203 x 165mm) | Red           | 64    | 100    | £23.75         | 6        |
| EX544167   | 6mm Ruled & Margin | 8" x 6.5" (203 x 165mm) | Light Green   | 80    | 100    | £25.40         | 6        |
| EX544170   | 6mm Ruled & Margin | 8" x 6.5" (203 x 165mm) | Light Blue    | 80    | 100    | £25.40         | 6        |
| EX35292    | 6mm Ruled & Margin | 9" x 7" (230 x 178mm)   | Light Green   | 48    | 100    | £21.00         | 7        |
| EX67859    | 6mm Ruled & Margin | 9" x 7" (230 x 178mm)   | Red           | 64    | 100    | £26.75         | 7        |
| DD030094   | 6mm Ruled & Margin | 9" x 7" (230 x 178mm)   | Orange        | 80    | 100    | £19.50         | 8        |
| EX554355   | 6mm Ruled & Margin | 9" x 7" (230 x 178mm)   | Light Blue    | 80    | 100    | £19.99         | 8        |

| Ref         | Ruling                       | Size                       | Cover Colour | Pages | Packed | Price Per Pack | Page No. |
|-------------|------------------------------|----------------------------|--------------|-------|--------|----------------|----------|
| EX554177    | 6mm Ruled & Margin           | 9" x 7" (230 x 178mm)      | Light Green  | 80    | 100    | £19.99         | 8        |
| EX554193    | 6mm Ruled & Margin           | 9" x 7" (230 x 178mm)      | Red          | 80    | 100    | £19.99         | 8        |
| EX677328-5  | 6mm Ruled & Margin           | A4 (300 x 210mm)           | Light Blue   | 64    | 50     | £16.45         | 10       |
| EX677315-5  | 6mm Ruled & Margin           | A4 (300 x 210mm)           | Red          | 64    | 50     | £16.45         | 10       |
| EX668191-5  | 6mm Ruled & Margin           | A4 (300 x 210mm)           | Red          | 80    | 50     | £16.55         | 11       |
| EX66865-5   | 6mm Ruled & Margin           | A4 (300 x 210mm)           | Light Green  | 80    | 50     | £16.55         | 11       |
| NB01265     | 7mm Ruled                    | 6.5" x 4" (165 x 102mm)    | Blue         | 48    | 100    | £13.65         | 14       |
| NB01281     | 7mm Ruled                    | 6.5" x 4" (165 x 102mm)    | Green        | 48    | 100    | £13.65         | 14       |
| NB01278     | 7mm Ruled                    | 6.5" x 4" (165 x 102mm)    | Red          | 48    | 100    | £13.65         | 14       |
| NB01252     | 7mm Ruled With Centre Margin | 6.5" x 4" (165 x 102mm)    | Blue         | 48    | 100    | £13.65         | 14       |
| NB01294     | 7mm Ruled With Centre Margin | 6.5" x 4" (165 x 102mm)    | Yellow       | 48    | 100    | £13.65         | 14       |
| EX032169    | 8mm Ruled                    | 5.25" x 6.5" (133 x 165mm) | Blue         | 24    | 100    | £10.75         | 4        |
| NB00583     | 8mm Ruled                    | 8" x 4" (203 x 102mm)      | Yellow       | 32    | 100    | £12.90         | 14       |
| NB02217     | 8mm Ruled                    | 8" x 4.5" (200 x 115mm)    | Dark Blue    | 80    | 100    | £29.20         | 14       |
| AB005       | 8mm Ruled                    | 8" x 5" (200 x 125mm)      | Dark Blue    | 64    | 100    | £23.30         | 4        |
| EX142181    | 8mm Ruled                    | 8" x 6.5" (203 x 165mm)    | Blue         | 32    | 100    | £14.40         | 4        |
| EX342105    | 8mm Ruled                    | 8" x 6.5" (203 x 165mm)    | Light Blue   | 48    | 100    | £11.99         | 4        |
| EX342118    | 8mm Ruled                    | 8" x 6.5" (203 x 165mm)    | Orange       | 48    | 100    | £11.99         | 4        |
| EX342626    | 8mm Ruled                    | 8" x 6.5" (203 x 165mm)    | Red          | 48    | 100    | £11.99         | 4        |
| EX544219    | 8mm Ruled                    | 8" x 6.5" (203 x 165mm)    | Light Blue   | 80    | 100    | £25.40         | 6        |
| VRE01127    | 8mm Ruled (Rough Work Book)  | 8" x 6.5" (203 x 165mm)    | Light Blue   | 96    | 100    | £28.10         | 6        |
| EX35234     | 8mm Ruled                    | 9" x 7" (230 x 178mm)      | Light Blue   | 48    | 100    | £21.00         | 7        |
| VEX352-1315 | 8mm Ruled                    | 9" x 7" (230 x 178mm)      | Light Green  | 48    | 100    | £21.00         | 7        |
| VRE02010-5  | 8mm Ruled (Rough Work Book)  | 9" x 7" (230 x 178mm)      | Brown        | 48    | 50     | £9.60          | 14       |
| EX55438     | 8mm Ruled                    | 9" x 7" (230 x 178mm)      | Light Blue   | 80    | 100    | £19.99         | 8        |
| VRE02825    | 8mm Ruled (Rough Work Book)  | 9" x 7" (230 x 178mm)      | Light Blue   | 96    | 100    | £31.65         | 14       |
| DU014160    | 8mm Ruled                    | A4 (300 x 210mm)           | Blue         | 32    | 100    | £23.20         | 9        |

| Ref       | Ruling                       | Size                    | Cover Colour | Pages | Packed | Price Per Pack | Page No. |
|-----------|------------------------------|-------------------------|--------------|-------|--------|----------------|----------|
| EX681437  | 8mm Ruled                    | A4 (300 x 210mm)        | Red          | 48    | 100    | £29.70         | 9        |
| EX66810-5 | 8mm Ruled                    | A4 (300 x 210mm)        | Light Blue   | 80    | 50     | £16.55         | 11       |
| DU024160  | 8mm Ruled                    | 13" X 10" (330 X 250mm) | Light Blue   | 40    | 100    | £37.60         | 15       |
| DU024120  | 8mm Ruled                    | 13" X 10" (330 X 250mm) | Light Green  | 40    | 100    | £37.60         | 15       |
| DU024150  | 8mm Ruled                    | 13" X 10" (330 X 250mm) | Pink         | 40    | 100    | £37.60         | 15       |
| DU024130  | 8mm Ruled                    | 13" X 10" (330 X 250mm) | Purple       | 40    | 100    | £37.60         | 15       |
| DU024110  | 8mm Ruled                    | 13" X 10" (330 X 250mm) | Red          | 40    | 100    | £37.60         | 15       |
| DU024100  | 8mm Ruled                    | 13" X 10" (330 X 250mm) | Yellow       | 40    | 100    | £37.60         | 15       |
| NB005122  | 8mm Ruled With Centre Margin | 8" x 4" (203 x 102mm)   | Purple       | 32    | 100    | £12.90         | 14       |
| EX142194  | 8mm Ruled & Margin           | 8" x 6.5" (203 x 165mm) | Blue         | 32    | 100    | £14.40         | 4        |
| EX342202  | 8mm Ruled & Margin           | 8" x 6.5" (203 x 165mm) | Dark Blue    | 48    | 100    | £11.99         | 4        |
| EX342192  | 8mm Ruled & Margin           | 8" x 6.5" (203 x 165mm) | Dark Green   | 48    | 100    | £11.99         | 4        |
| EX342354  | 8mm Ruled & Margin           | 8" x 6.5" (203 x 165mm) | Light Blue   | 48    | 100    | £11.99         | 4        |
| EX342354  | 8mm Ruled & Margin           | 8" x 6.5" (203 x 165mm) | Light Green  | 48    | 100    | £11.99         | 4        |
| EX342367  | 8mm Ruled & Margin           | 8" x 6.5" (203 x 165mm) | Orange       | 48    | 100    | £11.99         | 4        |
| EX342370  | 8mm Ruled & Margin           | 8" x 6.5" (203 x 165mm) | Purple       | 48    | 100    | £11.99         | 4        |
| EX342419  | 8mm Ruled & Margin           | 8" x 6.5" (203 x 165mm) | Red          | 48    | 100    | £11.99         | 4        |
| AA114     | 8mm Ruled & Margin           | 8" x 6.5" (203 x 165mm) | Yellow       | 48    | 100    | £11.99         | 4        |
| EX342228  | 8mm Ruled & Margin           | 8" x 6.5" (203 x 165mm) | Red          | 48    | 100    | £11.99         | 4        |
| EX67624   | 8mm Ruled & Margin           | 8" x 6.5" (203 x 165mm) | Light Blue   | 64    | 100    | £23.75         | 6        |
| EX67637   | 8mm Ruled & Margin           | 8" x 6.5" (203 x 165mm) | Light Green  | 64    | 100    | £23.75         | 6        |
| EX67611   | 8mm Ruled & Margin           | 8" x 6.5" (203 x 165mm) | Red          | 64    | 100    | £23.75         | 6        |
| EX67666   | 8mm Ruled & Margin           | 8" x 6.5" (203 x 165mm) | Yellow       | 64    | 100    | £23.75         | 6        |
| EX544125  | 8mm Ruled & Margin           | 8" x 6.5" (203 x 165mm) | Red          | 80    | 100    | £25.40         | 6        |
| EX544235  | 8mm Ruled & Margin           | 8" x 6.5" (203 x 165mm) | Light Green  | 80    | 100    | £25.40         | 6        |
| EX54473   | 8mm Ruled & Margin           | 8" x 6.5" (203 x 165mm) | Dark Green   | 80    | 100    | £25.40         | 6        |
| EX54499   | 8mm Ruled & Margin           | 8" x 6.5" (203 x 165mm) | Dark Blue    | 80    | 100    | £25.40         | 6        |
| EX544109  | 8mm Ruled & Margin           | 8" x 6.5" (203 x 165mm) | Light Blue   | 80    | 100    | £25.40         | 6        |
| EX544112  | 8mm Ruled & Margin           | 8" x 6.5" (203 x 165mm) | Orange       | 80    | 100    | £25.40         | 6        |
| EX544138  | 8mm Ruled & Margin           | 8" x 6.5" (203 x 165mm) | Yellow       | 80    | 100    | £25.40         | 6        |
| EX36215   | 8mm Ruled & Margin           | 8" x 6.5" (203 x 165mm) | Red          | 120   | 100    | £38.99         | 6        |
| EX35276   | 8mm Ruled & Margin           | 9" x 7" (230 x 178mm)   | Dark Blue    | 48    | 100    | £21.00         | 7        |
| EX35263   | 8mm Ruled & Margin           | 9" x 7" (230 x 178mm)   | Dark Green   | 48    | 100    | £21.00         | 7        |
| EX352157  | 8mm Ruled & Margin           | 9" x 7" (230 x 178mm)   | Light Blue   | 48    | 100    | £21.00         | 7        |
| EX352131  | 8mm Ruled & Margin           | 9" x 7" (230 x 178mm)   | Light Green  | 48    | 100    | £21.00         | 7        |
| EX352160  | 8mm Ruled & Margin           | 9" x 7" (230 x 178mm)   | Orange       | 48    | 100    | £21.00         | 7        |

| <i>Ref</i> | <i>Ruling</i>      | <i>Size</i>           | <i>Cover Colour</i> | <i>Pages</i> | <i>Packed</i> | <i>Price Per Pack</i> | <i>Page No.</i> |
|------------|--------------------|-----------------------|---------------------|--------------|---------------|-----------------------|-----------------|
| EX352144   | 8mm Ruled & Margin | 9" x 7" (230 x 178mm) | Pink                | 48           | 100           | £21.00                | 7               |
| EX35289    | 8mm Ruled & Margin | 9" x 7" (230 x 178mm) | Red                 | 48           | 100           | £21.00                | 7               |
| EX352115   | 8mm Ruled & Margin | 9" x 7" (230 x 178mm) | Yellow              | 48           | 100           | £21.00                | 7               |
| VRE025106  | 8mm Ruled & Margin | 9" x 7" (230 x 178mm) | Dark Blue           | 60           | 100           | £15.99                | 8               |
| VRE02583   | 8mm Ruled & Margin | 9" x 7" (230 x 178mm) | Dark Green          | 60           | 100           | £15.99                | 8               |
| VRE02527   | 8mm Ruled & Margin | 9" x 7" (230 x 178mm) | Light Blue          | 60           | 100           | £15.99                | 8               |
| VRE02573   | 8mm Ruled & Margin | 9" x 7" (230 x 178mm) | Light Green         | 60           | 100           | £15.99                | 8               |
| VRE02598   | 8mm Ruled & Margin | 9" x 7" (230 x 178mm) | Purple              | 60           | 100           | £15.99                | 8               |
| VRE02511   | 8mm Ruled & Margin | 9" x 7" (230 x 178mm) | Red                 | 60           | 100           | £15.99                | 8               |
| VRE02556   | 8mm Ruled & Margin | 9" x 7" (230 x 178mm) | Yellow              | 60           | 100           | £15.99                | 8               |
| EX67817    | 8mm Ruled & Margin | 9" x 7" (230 x 178mm) | Light Blue          | 64           | 100           | £26.75                | 7               |
| EX67820    | 8mm Ruled & Margin | 9" x 7" (230 x 178mm) | Light Green         | 64           | 100           | £26.75                | 7               |
| EX67830    | 8mm Ruled & Margin | 9" x 7" (230 x 178mm) | Orange              | 64           | 100           | £26.75                | 7               |
| EX67833    | 8mm Ruled & Margin | 9" x 7" (230 x 178mm) | Red                 | 64           | 100           | £26.75                | 7               |
| EX67846    | 8mm Ruled & Margin | 9" x 7" (230 x 178mm) | Yellow              | 64           | 100           | £26.75                | 7               |
| EX55470    | 8mm Ruled & Margin | 9" x 7" (230 x 178mm) | Buff                | 80           | 100           | £19.99                | 8               |
| EX554106   | 8mm Ruled & Margin | 9" x 7" (230 x 178mm) | Dark Blue           | 80           | 100           | £19.99                | 8               |
| EX55483    | 8mm Ruled & Margin | 9" x 7" (230 x 178mm) | Dark Green          | 80           | 100           | £19.99                | 8               |
| EX554258   | 8mm Ruled & Margin | 9" x 7" (230 x 178mm) | Grey                | 80           | 100           | £19.99                | 8               |
| EX554119   | 8mm Ruled & Margin | 9" x 7" (230 x 178mm) | Light Blue          | 80           | 100           | £19.99                | 8               |
| EX55496    | 8mm Ruled & Margin | 9" x 7" (230 x 178mm) | Light Green         | 80           | 100           | £19.99                | 8               |
| EX554122   | 8mm Ruled & Margin | 9" x 7" (230 x 178mm) | Orange              | 80           | 100           | £19.99                | 8               |
| EX554164   | 8mm Ruled & Margin | 9" x 7" (230 x 178mm) | Pink                | 80           | 100           | £19.99                | 8               |
| EX554300   | 8mm Ruled & Margin | 9" x 7" (230 x 178mm) | Purple              | 80           | 100           | £19.99                | 8               |
| EX554135   | 8mm Ruled & Margin | 9" x 7" (230 x 178mm) | Red                 | 80           | 100           | £19.99                | 8               |
| EX554148   | 8mm Ruled & Margin | 9" x 7" (230 x 178mm) | Yellow              | 80           | 100           | £19.99                | 8               |
| AA037      | 8mm Ruled & Margin | 9" x 7" (230 x 178mm) | Dark Blue           | 96           | 100           | £33.35                | 8               |
| EX65855    | 8mm Ruled & Margin | 9" x 7" (230 x 178mm) | Dark Blue           | 120          | 100           | £48.80                | 8               |
| EX65826    | 8mm Ruled & Margin | 9" x 7" (230 x 178mm) | Dark Green          | 120          | 100           | £48.80                | 8               |
| EX658122   | 8mm Ruled & Margin | 9" x 7" (230 x 178mm) | Orange              | 120          | 100           | £48.80                | 8               |
| EX65884    | 8mm Ruled & Margin | 9" x 7" (230 x 178mm) | Red                 | 120          | 100           | £48.80                | 8               |
| EX658148   | 8mm Ruled & Margin | 9" x 7" (230 x 178mm) | Yellow              | 120          | 100           | £48.80                | 8               |
| DU014178   | 8mm Ruled & Margin | A4 (300 x 210mm)      | Blue                | 32           | 100           | £23.20                | 9               |
| DU014136   | 8mm Ruled & Margin | A4 (300 x 210mm)      | Green               | 32           | 100           | £23.20                | 9               |
| DU014165   | 8mm Ruled & Margin | A4 (300 x 210mm)      | Red                 | 32           | 100           | £23.20                | 9               |
| EX68171    | 8mm Ruled & Margin | A4 (300 x 210mm)      | Dark Green          | 48           | 100           | £29.70                | 9               |
| EX68197    | 8mm Ruled & Margin | A4 (300 x 210mm)      | Light Blue          | 48           | 100           | £29.70                | 9               |
| EX681106   | 8mm Ruled & Margin | A4 (300 x 210mm)      | Dark Blue           | 48           | 100           | £29.70                | 9               |

| Ref         | Ruling   | Size             | Cover Colour | Pages | Packed | Price Per Pack | Page No. |
|-------------|--|------------------|--------------|-------|--------|----------------|----------|
| EX68168     | 8mm Ruled & Margin                             | A4 (300 x 210mm) | Light Green  | 48    | 100    | £29.70         | 9        |
| EX68155     | 8mm Ruled & Margin                             | A4 (300 x 210mm) | Orange       | 48    | 100    | £29.70         | 9        |
| EX68142     | 8mm Ruled & Margin                             | A4 (300 x 210mm) | Purple       | 48    | 100    | £29.70         | 9        |
| EX68184     | 8mm Ruled & Margin                             | A4 (300 x 210mm) | Red          | 48    | 100    | £29.70         | 9        |
| EX68139     | 8mm Ruled & Margin                             | A4 (300 x 210mm) | Yellow       | 48    | 100    | £29.70         | 9        |
| EX68197B    | 8mm Ruled & Margin Special Needs - Blue Paper  | A4 (300 x 210mm) | Light Blue   | 48    | 10     | £5.99          | 21       |
| EX68197CV   | 8mm Ruled & Margin Special Needs - Cream Paper | A4 (300 x 210mm) | Light Blue   | 48    | 10     | £5.99          | 21       |
| EX68197G    | 8mm Ruled & Margin Special Needs - Green Paper | A4 (300 x 210mm) | Light Blue   | 48    | 10     | £5.99          | 21       |
| EX68197PP   | 8mm Ruled & Margin Special Needs - Pink Paper  | A4 (300 x 210mm) | Light Blue   | 48    | 10     | £5.99          | 21       |
| EX68184B    | 8mm Ruled & Margin Special Needs - Blue Paper  | A4 (300 x 210mm) | Red          | 48    | 10     | £5.99          | 21       |
| EX68184CV   | 8mm Ruled & Margin Special Needs - Cream Paper | A4 (300 x 210mm) | Red          | 48    | 10     | £5.99          | 21       |
| EX68184G    | 8mm Ruled & Margin Special Needs - Green Paper | A4 (300 x 210mm) | Red          | 48    | 10     | £5.99          | 21       |
| EX68184PP   | 8mm Ruled & Margin Special Needs - Pink Paper  | A4 (300 x 210mm) | Red          | 48    | 10     | £5.99          | 21       |
| EX68139B    | 8mm Ruled & Margin Special Needs - Blue Paper  | A4 (300 x 210mm) | Yellow       | 48    | 10     | £5.99          | 21       |
| EX68139B    | 8mm Ruled & Margin Special Needs - Cream Paper | A4 (300 x 210mm) | Yellow       | 48    | 10     | £5.99          | 21       |
| EX68139B    | 8mm Ruled & Margin Special Needs - Green Paper | A4 (300 x 210mm) | Yellow       | 48    | 10     | £5.99          | 21       |
| EX68139B    | 8mm Ruled & Margin Special Needs - Pink Paper  | A4 (300 x 210mm) | Yellow       | 48    | 10     | £5.99          | 21       |
| VRE01027-5  | 8mm Ruled & Margin                             | A4 (300 x 210mm) | Light Blue   | 60    | 50     | £12.25         | 9        |
| VRE010730-5 | 8mm Ruled & Margin                             | A4 (300 x 210mm) | Light Green  | 60    | 50     | £12.25         | 9        |
| VRE01011-5  | 8mm Ruled & Margin                             | A4 (300 x 210mm) | Red          | 60    | 50     | £12.25         | 9        |
| VRE01098-5  | 8mm Ruled & Margin                             | A4 (300 x 210mm) | Purple       | 60    | 50     | £12.25         | 9        |
| VRE01056-5  | 8mm Ruled & Margin                             | A4 (300 x 210mm) | Yellow       | 60    | 50     | £12.25         | 9        |
| EX677149-5  | 8mm Ruled & Margin                             | A4 (300 x 210mm) | Buff         | 64    | 50     | £16.45         | 10       |
| EX677108-5  | 8mm Ruled & Margin                             | A4 (300 x 210mm) | Dark Blue    | 64    | 50     | £16.45         | 10       |
| EX677165-5  | 8mm Ruled & Margin                             | A4 (300 x 210mm) | Dark Green   | 64    | 50     | £16.45         | 10       |
| EX67727-5   | 8mm Ruled & Margin                             | A4 (300 x 210mm) | Light Blue   | 64    | 50     | £16.45         | 10       |
| EX67730-5   | 8mm Ruled & Margin                             | A4 (300 x 210mm) | Light Green  | 64    | 50     | £16.45         | 10       |
| EX677110-5  | 8mm Ruled & Margin                             | A4 (300 x 210mm) | Orange       | 64    | 50     | £16.45         | 10       |
| EX677152-5  | 8mm Ruled & Margin                             | A4 (300 x 210mm) | Pink         | 64    | 50     | £16.45         | 10       |
| EX67798-5   | 8mm Ruled & Margin                             | A4 (300 x 210mm) | Purple       | 64    | 50     | £16.45         | 10       |
| EX67714-5   | 8mm Ruled & Margin                             | A4 (300 x 210mm) | Red          | 64    | 50     | £16.45         | 10       |
| EX67756-5   | 8mm Ruled & Margin                             | A4 (300 x 210mm) | Yellow       | 64    | 50     | £16.45         | 10       |
| EX66870-5   | 8mm Ruled & Margin                             | A4 (300 x 210mm) | Buff         | 80    | 50     | £16.55         | 11       |
| EX66849-5   | 8mm Ruled & Margin                             | A4 (300 x 210mm) | Red          | 80    | 50     | £16.55         | 11       |
| EX668133-5  | 8mm Ruled & Margin                             | A4 (300 x 210mm) | Light Blue   | 80    | 50     | £16.55         | 11       |
| EX66836-5   | 8mm Ruled & Margin                             | A4 (300 x 210mm) | Dark Blue    | 80    | 50     | £16.55         | 11       |
| EX668120-5  | 8mm Ruled & Margin                             | A4 (300 x 210mm) | Light Green  | 80    | 50     | £16.55         | 11       |
| EX668104-5  | 8mm Ruled & Margin                             | A4 (300 x 210mm) | Dark Green   | 80    | 50     | £16.55         | 11       |
| EX668146-5  | 8mm Ruled & Margin                             | A4 (300 x 210mm) | Orange       | 80    | 50     | £16.55         | 11       |
| EX66811-5   | 8mm Ruled & Margin                             | A4 (300 x 210mm) | Pink         | 80    | 50     | £16.55         | 11       |
| EX668159-5  | 8mm Ruled & Margin                             | A4 (300 x 210mm) | Purple       | 80    | 50     | £16.55         | 11       |
| EX66894-5   | 8mm Ruled & Margin                             | A4 (300 x 210mm) | Yellow       | 80    | 50     | £16.55         | 11       |
| EX696120-5  | 8mm Ruled & Margin                             | A4 (300 x 210mm) | Light Green  | 96    | 50     | £21.99         | 11       |



| <b>Ref</b> | <b>Ruling</b>                                   | <b>Size</b>                | <b>Cover Colour</b> | <b>Pages</b> | <b>Packed</b> | <b>Price Per Pack</b> | <b>Page No.</b> |
|------------|---|----------------------------|---------------------|--------------|---------------|-----------------------|-----------------|
| EX696159-5 | 8mm Ruled & Margin                              | A4 (300 x 210mm)           | Purple              | 96           | 50            | £21.99                | 11              |
| EX69649-5  | 8mm Ruled & Margin                              | A4 (300 x 210mm)           | Red                 | 96           | 50            | £21.99                | 11              |
| EX69694-5  | 8mm Ruled & Margin                              | A4 (300 x 210mm)           | Yellow              | 96           | 50            | £21.99                | 11              |
| EX032156   | 11mm Ruled                                      | 5.25" x 6.5" (133 x 165mm) | Yellow              | 24           | 100           | £10.75                | 4               |
| NB00596    | 12mm Ruled                                      | 8" x 4" (203 x 102mm)      | Blue                | 32           | 100           | £12.90                | 14              |
| NB00596R   | 12mm Ruled                                      | 8" x 4" (203 x 102mm)      | Red                 | 32           | 100           | £12.90                | 14              |
| EX142178   | 12mm Ruled                                      | 8" x 6.5" (203 x 165mm)    | Red                 | 32           | 100           | £14.40                | 4               |
| EX34270    | 12mm Ruled                                      | 8" x 6.5" (203 x 165mm)    | Dark Blue           | 48           | 100           | £11.99                | 4               |
| EX34266    | 12mm Ruled                                      | 8" x 6.5" (203 x 165mm)    | Red                 | 48           | 100           | £11.99                | 4               |
| DU01480    | 12mm Ruled                                      | A4 (300 x 210mm)           | Red                 | 32           | 100           | £23.20                | 9               |
| EX681110   | 12mm Ruled                                      | A4 (300 x 210mm)           | Dark Blue           | 48           | 100           | £29.70                | 9               |
| EX681107   | 12mm Ruled                                      | A4 (300 x 210mm)           | Purple              | 48           | 100           | £29.70                | 9               |
| EX681109   | 12mm Ruled                                      | A4 (300 x 210mm)           | Red                 | 48           | 100           | £29.70                | 9               |
| EX681111B  | 12mm Ruled & Margin Special Needs - Blue Paper  | A4 (300 x 210mm)           | Light Blue          | 48           | 10            | £5.99                 | 21              |
| EX681111CV | 12mm Ruled & Margin Special Needs - Cream Paper | A4 (300 x 210mm)           | Light Blue          | 48           | 10            | £5.99                 | 21              |
| EX681111G  | 12mm Ruled & Margin Special Needs - Green Paper | A4 (300 x 210mm)           | Light Blue          | 48           | 10            | £5.99                 | 21              |
| EX681111PP | 12mm Ruled & Margin Special Needs - Pink Paper  | A4 (300 x 210mm)           | Light Blue          | 48           | 10            | £5.99                 | 21              |
| EX681109B  | 12mm Ruled & Margin Special Needs - Blue Paper  | A4 (300 x 210mm)           | Red                 | 48           | 10            | £5.99                 | 21              |
| EX681109CV | 12mm Ruled & Margin Special Needs - Cream Paper | A4 (300 x 210mm)           | Red                 | 48           | 10            | £5.99                 | 21              |
| EX681109G  | 12mm Ruled & Margin Special Needs - Green Paper | A4 (300 x 210mm)           | Red                 | 48           | 10            | £5.99                 | 21              |
| EX681109PP | 12mm Ruled & Margin Special Needs - Pink Paper  | A4 (300 x 210mm)           | Red                 | 48           | 10            | £5.99                 | 21              |
| EX681108B  | 12mm Ruled & Margin Special Needs - Blue Paper  | A4 (300 x 210mm)           | Yellow              | 48           | 10            | £5.99                 | 21              |
| EX681108B  | 12mm Ruled & Margin Special Needs - Cream Paper | A4 (300 x 210mm)           | Yellow              | 48           | 10            | £5.99                 | 21              |
| EX681108B  | 12mm Ruled & Margin Special Needs - Green Paper | A4 (300 x 210mm)           | Yellow              | 48           | 10            | £5.99                 | 21              |
| EX681108B  | 12mm Ruled & Margin Special Needs - Pink Paper  | A4 (300 x 210mm)           | Yellow              | 48           | 10            | £5.99                 | 21              |
| DU024260   | 12mm Ruled                                      | 13" X 10" (330 X 250mm)    | Light Blue          | 40           | 100           | £37.60                | 15              |
| DU024220   | 12mm Ruled                                      | 13" X 10" (330 X 250mm)    | Light Green         | 40           | 100           | £37.60                | 15              |
| DU024250   | 12mm Ruled                                      | 13" X 10" (330 X 250mm)    | Pink                | 40           | 100           | £37.60                | 15              |
| DU024230   | 12mm Ruled                                      | 13" X 10" (330 X 250mm)    | Purple              | 40           | 100           | £37.60                | 15              |
| DU024210   | 12mm Ruled                                      | 13" X 10" (330 X 250mm)    | Red                 | 40           | 100           | £37.60                | 15              |
| DU024200   | 12mm Ruled                                      | 13" X 10" (330 X 250mm)    | Yellow              | 40           | 100           | £37.60                | 15              |
| EX032143   | 15mm Ruled                                      | 5.25" x 6.5" (133 x 165mm) | Red                 | 24           | 100           | £10.75                | 4               |
| EX142165   | 12mm Ruled                                      | 8" x 6.5" (203 x 165mm)    | Red                 | 32           | 100           | £14.40                | 4               |
| EX342480   | 15mm Ruled                                      | 8" x 6.5" (203 x 165mm)    | Light Green         | 48           | 100           | £11.99                | 4               |
| EX34240    | 15mm Ruled                                      | 8" x 6.5" (203 x 165mm)    | Red                 | 48           | 100           | £11.99                | 4               |
| AA007      | 15mm Ruled                                      | 6.25" x 8" (160 x 203mm)   | Green               | 32           | 100           | £17.99                | 4               |

| Ref         | Ruling      | Size                    | Cover Colour | Pages | Packed | Price Per Pack | Page No. |
|-------------|-------------|-------------------------|--------------|-------|--------|----------------|----------|
| DU014149    | 15mm Ruled  | A4 (300 x 210mm)        | Blue         | 32    | 100    | £23.20         | 9        |
| DU014148    | 15mm Ruled  | A4 (300 x 210mm)        | Red          | 32    | 100    | £23.20         | 9        |
| EX681150    | 15mm Ruled  | A4 (300 x 210mm)        | Red          | 48    | 100    | £29.70         | 9        |
| EX677425-5  | 15mm Ruled  | A4 (300 x 210mm)        | Light Blue   | 64    | 50     | £16.45         | 10       |
| EX668425-5  | 15mm Ruled  | A4 (300 x 210mm)        | Light Blue   | 80    | 50     | £16.55         | 10       |
| PW02928     | 15mm Ruled  | 8" x 10" (200 x 250mm)  | Yellow       | 32    | 100    | £24.75         | 15       |
| PW02931     | 15mm Ruled  | 8" x 10" (200 x 250mm)  | Dark Blue    | 32    | 100    | £24.75         | 15       |
| PW02944     | 15mm Ruled  | 8" x 10" (200 x 250mm)  | Red          | 32    | 100    | £24.75         | 15       |
| EX342602    | 5mm Squares | 8" x 6.5" (203 x 165mm) | Dark Green   | 48    | 100    | £11.99         | 4        |
| EX342396    | 5mm Squares | 8" x 6.5" (203 x 165mm) | Light Blue   | 48    | 100    | £11.99         | 4        |
| EX342312    | 5mm Squares | 8" x 6.5" (203 x 165mm) | Orange       | 48    | 100    | £11.99         | 4        |
| EX67682     | 5mm Squares | 8" x 6.5" (203 x 165mm) | Buff         | 64    | 100    | £23.75         | 6        |
| EX544248    | 5mm Squares | 8" x 6.5" (203 x 165mm) | Light Blue   | 80    | 100    | £25.40         | 6        |
| EX544206    | 5mm Squares | 8" x 6.5" (203 x 165mm) | Orange       | 80    | 100    | £25.40         | 6        |
| EX352102    | 5mm Squares | 9" x 7" (230 x 178mm)   | Orange       | 48    | 100    | £21.00         | 7        |
| VRE025743   | 5mm Squares | 9" x 7" (230 x 178mm)   | Orange       | 60    | 100    | £15.99         | 8        |
| EX67875     | 5mm Squares | 9" x 7" (230 x 178mm)   | Orange       | 64    | 100    | £26.75         | 7        |
| EX554371    | 5mm Squares | 9" x 7" (230 x 178mm)   | Dark Green   | 80    | 100    | £19.99         | 8        |
| EX554290    | 5mm Squares | 9" x 7" (230 x 178mm)   | Light Blue   | 80    | 100    | £19.99         | 8        |
| EX554232    | 5mm Squares | 9" x 7" (230 x 178mm)   | Orange       | 80    | 100    | £19.99         | 8        |
| EX554274    | 5mm Squares | 9" x 7" (230 x 178mm)   | Yellow       | 80    | 100    | £19.99         | 8        |
| EX554382    | 5mm Squares | 9" x 7" (230 x 178mm)   | Red          | 80    | 100    | £19.99         | 8        |
| EX681371    | 5mm Squares | A4 (300 x 210mm)        | Dark Green   | 48    | 100    | £29.70         | 9        |
| EX681232    | 5mm Squares | A4 (300 x 210mm)        | Orange       | 48    | 100    | £29.70         | 9        |
| EX681290    | 5mm Squares | A4 (300 x 210mm)        | Light Blue   | 48    | 100    | £29.70         | 9        |
| VRE010743-5 | 5mm Squares | A4 (300 x 210mm)        | Orange       | 60    | 50     | £12.25         | 9        |
| EX677357-5  | 5mm Squares | A4 (300 x 210mm)        | Light Blue   | 64    | 50     | £16.45         | 10       |
| EX67743-5   | 5mm Squares | A4 (300 x 210mm)        | Orange       | 64    | 50     | £16.45         | 10       |
| EX668162-5  | 5mm Squares | A4 (300 x 210mm)        | Light Blue   | 80    | 50     | £16.55         | 11       |
| EX66852-5   | 5mm Squares | A4 (300 x 210mm)        | Orange       | 80    | 50     | £16.55         | 11       |

| Ref        | Ruling                        | Size                       | Cover Colour | Pages | Packed | Price Per Pack | Page No. |
|------------|-------------------------------|----------------------------|--------------|-------|--------|----------------|----------|
| EX668221-5 | 5mm Squares                   | A4 (300 x 210mm)           | Red          | 80    | 50     | £16.55         | 11       |
| EX67790-5  | 5mm Squares & Blank Alternate | A4 (300 x 210mm)           | Red          | 64    | 50     | £16.45         | 10       |
| EX142204   | 7mm Squares                   | 8" x 6.5" (203 x 165mm)    | Yellow       | 32    | 100    | £14.40         | 4        |
| EX342619   | 7mm Squares                   | 8" x 6.5" (203 x 165mm)    | Dark Green   | 48    | 100    | £11.99         | 4        |
| EX342406   | 7mm Squares                   | 8" x 6.5" (203 x 165mm)    | Light Blue   | 48    | 100    | £11.99         | 4        |
| EX342341   | 7mm Squares                   | 8" x 6.5" (203 x 165mm)    | Orange       | 48    | 100    | £11.99         | 4        |
| EX342299   | 7mm Squares                   | 8" x 6.5" (203 x 165mm)    | Yellow       | 48    | 100    | £11.99         | 4        |
| EX67695    | 7mm Squares                   | 8" x 6.5" (203 x 165mm)    | Red          | 64    | 100    | £23.75         | 6        |
| EX544251   | 7mm Squares                   | 8" x 6.5" (203 x 165mm)    | Light Blue   | 80    | 100    | £25.40         | 6        |
| EX544196   | 7mm Squares                   | 8" x 6.5" (203 x 165mm)    | Yellow       | 80    | 100    | £25.40         | 6        |
| VEX352-245 | 7mm Squares                   | 9" x 7" (230 x 178mm)      | Red          | 48    | 100    | £21.00         | 7        |
| EX352128   | 7mm Squares                   | 9" x 7" (230 x 178mm)      | Yellow       | 48    | 100    | £21.00         | 7        |
| VRE025287  | 7mm Squares                   | 9" x 7" (230 x 178mm)      | Yellow       | 60    | 100    | £15.99         | 8        |
| EX554313   | 7mm Squares                   | 9" x 7" (230 x 178mm)      | Light Blue   | 80    | 100    | £19.99         | 8        |
| EX554229   | 7mm Squares                   | 9" x 7" (230 x 178mm)      | Orange       | 80    | 100    | £19.99         | 8        |
| EX554287   | 7mm Squares                   | 9" x 7" (230 x 178mm)      | Yellow       | 80    | 100    | £19.99         | 8        |
| DU014100   | 7mm Squares                   | A4 (300 x 210mm)           | Yellow       | 32    | 100    | £23.20         | 9        |
| EX681303   | 7mm Squares                   | A4 (300 x 210mm)           | Dark Green   | 48    | 100    | £29.70         | 9        |
| EX681287   | 7mm Squares                   | A4 (300 x 210mm)           | Yellow       | 48    | 100    | £29.70         | 9        |
| EX677438-5 | 7mm Squares                   | A4 (300 x 210mm)           | Light Blue   | 64    | 50     | £16.45         | 10       |
| EX67770-5  | 7mm Squares                   | A4 (300 x 210mm)           | Orange       | 64    | 50     | £16.45         | 10       |
| EX677300-5 | 7mm Squares                   | A4 (300 x 210mm)           | Purple       | 64    | 50     | £16.45         | 10       |
| EX67772-5  | 7mm Squares                   | A4 (300 x 210mm)           | Yellow       | 64    | 50     | £16.45         | 10       |
| EX668175-5 | 7mm Squares                   | A4 (300 x 210mm)           | Light Blue   | 80    | 50     | £16.55         | 11       |
| EX66833-5  | 7mm Squares                   | A4 (300 x 210mm)           | Purple       | 80    | 50     | £16.55         | 11       |
| EX668117-5 | 7mm Squares                   | A4 (300 x 210mm)           | Yellow       | 80    | 50     | £16.55         | 11       |
| DU024360   | 7mm Squares                   | 13" X 10" (330 X 250mm)    | Light Blue   | 40    | 100    | £37.60         | 15       |
| DU024320   | 7mm Squares                   | 13" X 10" (330 X 250mm)    | Light Green  | 40    | 100    | £37.60         | 15       |
| DU024350   | 7mm Squares                   | 13" X 10" (330 X 250mm)    | Pink         | 40    | 100    | £37.60         | 15       |
| DU024330   | 7mm Squares                   | 13" X 10" (330 X 250mm)    | Purple       | 40    | 100    | £37.60         | 15       |
| DU024310   | 7mm Squares                   | 13" X 10" (330 X 250mm)    | Red          | 40    | 100    | £37.60         | 15       |
| DU024300   | 7mm Squares                   | 13" X 10" (330 X 250mm)    | Yellow       | 40    | 100    | £37.60         | 15       |
| EX032172   | 10mm Squares                  | 5.25" x 6.5" (133 x 165mm) | Green        | 24    | 100    | £10.75         | 4        |

| Ref         | Ruling                                  | Size                    | Cover Colour | Pages | Packed | Price Per Pack | Page No. |
|-------------|---|-------------------------|--------------|-------|--------|----------------|----------|
| NB005119    | 10mm Squares                            | 8" x 4" (203 x 102mm)   | Pink         | 32    | 100    | £12.90         | 14       |
| EX142217    | 10mm Squares                            | 8" x 6.5" (203 x 165mm) | Green        | 32    | 100    | £14.40         | 4        |
| EX342325    | 10mm Squares                            | 8" x 6.5" (203 x 165mm) | Dark Green   | 48    | 100    | £11.99         | 4        |
| EX342383    | 10mm Squares                            | 8" x 6.5" (203 x 165mm) | Light Blue   | 48    | 100    | £11.99         | 4        |
| EX342558    | 10mm Squares                            | 8" x 6.5" (203 x 165mm) | Red          | 48    | 100    | £11.99         | 4        |
| EX67653     | 10mm Squares                            | 8" x 6.5" (203 x 165mm) | Light Green  | 64    | 100    | £23.75         | 6        |
| EX544264    | 10mm Squares                            | 8" x 6.5" (203 x 165mm) | Light Blue   | 80    | 100    | £25.40         | 6        |
| EX544222    | 10mm Squares                            | 8" x 6.5" (203 x 165mm) | Light Green  | 80    | 100    | £25.40         | 6        |
| EX352260    | 10mm Squares                            | 9" x 7" (230 x 178mm)   | Red          | 48    | 100    | £21.00         | 7        |
| VRE025261   | 10mm Squares                            | 9" x 7" (230 x 178mm)   | Orange       | 60    | 100    | £15.99         | 8        |
| EX554339    | 10mm Squares                            | 9" x 7" (230 x 178mm)   | Light Blue   | 80    | 100    | £19.99         | 8        |
| EX554261    | 10mm Squares                            | 9" x 7" (230 x 178mm)   | Orange       | 80    | 100    | £19.99         | 8        |
| EX554340    | 10mm Squares                            | 9" x 7" (230 x 178mm)   | Purple       | 80    | 100    | £19.99         | 8        |
| DU014151    | 10mm Squares                            | A4 (300 x 210mm)        | Light Green  | 32    | 100    | £23.20         | 9        |
| DU014155    | 10mm Squares                            | A4 (300 x 210mm)        | Orange       | 32    | 100    | £23.20         | 9        |
| DU014152    | 10mm Squares                            | A4 (300 x 210mm)        | Yellow       | 32    | 100    | £23.20         | 9        |
| EX681340    | 10mm Squares                            | A4 (300 x 210mm)        | Dark Green   | 48    | 100    | £29.70         | 9        |
| EX681339    | 10mm Squares                            | A4 (300 x 210mm)        | Light Blue   | 48    | 100    | £29.70         | 9        |
| EX681339B   | 10mm Squares Special Needs - Blue Paper | A4 (300 x 210mm)        | Light Blue   | 48    | 10     | £5.99          | 21       |
| EX681339CV  | 10mm Squares Special Needs - Blue Paper | A4 (300 x 210mm)        | Light Blue   | 48    | 10     | £5.99          | 21       |
| EX681339G   | 10mm Squares Special Needs - Blue Paper | A4 (300 x 210mm)        | Light Blue   | 48    | 10     | £5.99          | 21       |
| EX681339PP  | 10mm Squares Special Needs - Blue Paper | A4 (300 x 210mm)        | Light Blue   | 48    | 10     | £5.99          | 21       |
| EX681260B   | 10mm Squares Special Needs - Blue Paper | A4 (300 x 210mm)        | Red          | 48    | 10     | £5.99          | 21       |
| EX681260CV  | 10mm Squares Special Needs - Blue Paper | A4 (300 x 210mm)        | Red          | 48    | 10     | £5.99          | 21       |
| EX681260G   | 10mm Squares Special Needs - Blue Paper | A4 (300 x 210mm)        | Red          | 48    | 10     | £5.99          | 21       |
| EX681260PP  | 10mm Squares Special Needs - Blue Paper | A4 (300 x 210mm)        | Red          | 48    | 10     | £5.99          | 21       |
| EX68192B    | 10mm Squares Special Needs - Blue Paper | A4 (300 x 210mm)        | Yellow       | 48    | 10     | £5.99          | 21       |
| EX68192CV   | 10mm Squares Special Needs - Blue Paper | A4 (300 x 210mm)        | Yellow       | 48    | 10     | £5.99          | 21       |
| EX68192G    | 10mm Squares Special Needs - Blue Paper | A4 (300 x 210mm)        | Yellow       | 48    | 10     | £5.99          | 21       |
| EX68192PP   | 10mm Squares Special Needs - Blue Paper | A4 (300 x 210mm)        | Yellow       | 48    | 10     | £5.99          | 21       |
| VRE010292-5 | 10mm Squares                            | A4 (300 x 210mm)        | Yellow       | 60    | 50     | £12.25         | 9        |
| EX67799-5   | 10mm Squares                            | A4 (300 x 210mm)        | Light Blue   | 64    | 50     | £16.45         | 10       |
| EX677360-5  | 10mm Squares                            | A4 (300 x 210mm)        | Light Green  | 64    | 50     | £16.45         | 10       |
| EX677361-5  | 10mm Squares                            | A4 (300 x 210mm)        | Purple       | 64    | 50     | £16.45         | 10       |
| EX677292-5  | 10mm Squares                            | A4 (300 x 210mm)        | Yellow       | 64    | 50     | £16.45         | 10       |

|             |  |                         |             |    |     |        |    |
|-------------|--|-------------------------|-------------|----|-----|--------|----|
| EX668188-5  | 10mm Squares                           | A4 (300 x 210mm)        | Light Blue  | 80 | 50  | £16.55 | 11 |
| EX668361-5  | 10mm Squares                           | A4 (300 x 210mm)        | Purple      | 80 | 50  | £16.55 | 11 |
| EX66821-5   | 10mm Squares                           | A4 (300 x 210mm)        | Yellow      | 80 | 50  | £16.55 | 11 |
| PW02333     | 20mm Squares                           | 9" x 7" (230 x 178mm)   | Yellow      | 32 | 100 | £23.70 | 15 |
| DU014300    | 20mm Squares                           | A4 (300 x 210mm)        | Purple      | 32 | 100 | £23.20 | 9  |
| DU014200    | 20mm Squares                           | A4 (300 x 210mm)        | Red         | 32 | 100 | £23.20 | 9  |
| EX677373-5  | 20mm Squares                           | A4 (300 x 210mm)        | Light Blue  | 64 | 50  | £16.45 | 10 |
| EX67710-5   | 20mm Squares                           | A4 (300 x 210mm)        | Yellow      | 64 | 50  | £16.45 | 10 |
| EX668373-5  | 20mm Squares                           | A4 (300 x 210mm)        | Light Blue  | 80 | 50  | £16.55 | 11 |
| PW02513     | Top Half Plain, Bottom Half 8mm Ruled  | 8" x 6.5" (203 x 165mm) | Green       | 32 | 100 | £14.40 | 4  |
| EX342287    | Top Half Plain, Bottom Half 8mm Ruled  | 8" x 6.5" (203 x 165mm) | Dark Green  | 48 | 100 | £11.99 | 4  |
| PW02410     | Top Half Plain, Bottom Half 8mm Ruled  | A4 (300 x 210mm)        | Green       | 32 | 100 | £23.20 | 9  |
| EX67710-5   | Top Half Plain, Bottom Half 8mm Ruled  | A4 (300 x 210mm)        | Red         | 64 | 50  | £16.45 | 10 |
| EX67712-5   | Top Half Plain, Bottom Half 8mm Ruled  | A4 (300 x 210mm)        | Light Green | 64 | 50  | £16.45 | 10 |
| EX67713-5   | Top Half Plain, Bottom Half 8mm Ruled  | A4 (300 x 210mm)        | Light Blue  | 64 | 50  | £16.45 | 10 |
| PW02526     | Top Half Plain, Bottom Half 12mm Ruled | 8" x 6.5" (203 x 165mm) | Blue        | 32 | 100 | £14.40 | 4  |
| PW02568     | Top Half Plain, Bottom Half 12mm Ruled | 8" x 6.5" (203 x 165mm) | Red         | 32 | 100 | £14.40 | 4  |
| EX342290    | Top Half Plain, Bottom Half 12mm Ruled | 8" x 6.5" (203 x 165mm) | Orange      | 48 | 100 | £11.99 | 4  |
| PW02317     | Top Half Plain, Bottom Half 12mm Ruled | 9" x 7" (230 x 178mm)   | Green       | 32 | 100 | £23.70 | 7  |
| EX681400    | Top Half Plain, Bottom Half 12mm Ruled | A4 (300 x 210mm)        | Orange      | 48 | 100 | £29.70 | 9  |
| PW02812     | Top Half Plain, Bottom Half 12mm Ruled | 13" x 10" (330 x 250mm) | Blue        | 40 | 100 | £36.50 | 13 |
| VEX352-95-4 | Top Half Plain, Bottom Half 12mm Ruled | 9" x 7" (230 x 178mm)   | Light Green | 48 | 100 | £21.00 | 7  |
| PW02423     | Top Half Plain, Bottom Half 13mm Ruled | A4 (300 x 210mm)        | Blue        | 32 | 100 | £23.20 | 9  |
| PW02414     | Top Half Plain, Bottom Half 13mm Ruled | A4 (300 x 210mm)        | Red         | 32 | 100 | £23.20 | 9  |
| PW02415     | Top Half Plain, Bottom Half 13mm Ruled | A4 (300 x 210mm)        | Yellow      | 32 | 100 | £23.20 | 9  |
| EX67715-5   | Top Half Plain, Bottom Half 13mm Ruled | A4 (300 x 210mm)        | Red         | 64 | 50  | £16.45 | 10 |
| EX67717-5   | Top Half Plain, Bottom Half 13mm Ruled | A4 (300 x 210mm)        | Yellow      | 64 | 50  | £16.45 | 10 |
| EX67718-5   | Top Half Plain, Bottom Half 13mm Ruled | A4 (300 x 210mm)        | Light Green | 64 | 50  | £16.45 | 10 |
| EX67721-5   | Top Half Plain, Bottom Half 13mm Ruled | A4 (300 x 210mm)        | Light Blue  | 64 | 50  | £16.45 | 10 |
| PW02539     | Top Half Plain, Bottom Half 15mm Ruled | 8" x 6.5" (203 x 165mm) | Red         | 32 | 100 | £14.40 | 4  |
| EX342532    | Top Half Plain, Bottom Half 15mm Ruled | 8" x 6.5" (203 x 165mm) | Yellow      | 48 | 100 | £11.99 | 4  |
| PW02320     | Top Half Plain, Bottom Half 15mm Ruled | 9" x 7" (230 x 178mm)   | Red         | 32 | 100 | £23.70 | 7  |

|              |  |                         |             |    |     |        |    |
|--------------|--|-------------------------|-------------|----|-----|--------|----|
| PW02424      | Top Half Plain, Bottom Half 15mm Ruled             | A4 (300 x 210mm)        | Red         | 32 | 100 | £23.20 | 9  |
| PW02425      | Top Half Plain, Bottom Half 15mm Ruled             | A4 (300 x 210mm)        | Yellow      | 32 | 100 | £23.20 | 9  |
| EX677302-5   | Top Half Plain, Bottom Half 15mm Ruled             | A4 (300 x 210mm)        | Light Green | 64 | 50  | £16.45 | 10 |
| PW02960      | Top Half Plain, Bottom Half 15mm Ruled             | 8" x 10" (200 x 250mm)  | Dark Blue   | 32 | 100 | £24.75 | 15 |
| PW02430      | Top Half Plain, Bottom Half 20mm Ruled             | A4 (300 x 210mm)        | Green       | 32 | 100 | £23.20 | 9  |
| EX342189     | Plain Unruled & 8mm Ruled Alternate Pages          | 8" x 6.5" (203 x 165mm) | Dark Green  | 48 | 100 | £11.99 | 4  |
| EX342504     | Plain Unruled & 8mm Ruled Alternate Pages          | 8" x 6.5" (203 x 165mm) | Yellow      | 48 | 100 | £11.99 | 4  |
| EX54457      | Plain Unruled & 8mm Ruled Alternate Pages          | 8" x 6.5" (203 x 165mm) | Dark Green  | 80 | 100 | £25.40 | 6  |
| AG011        | Plain Unruled & 8mm Ruled Alternate Pages          | 9" x 7" (230 x 178mm)   | Orange      | 48 | 100 | £21.00 | 7  |
| EX67862      | Plain Unruled & 8mm Ruled Alternate Pages          | 9" x 7" (230 x 178mm)   | Light Green | 64 | 100 | £26.75 | 7  |
| EX55467      | Plain Unruled & 8mm Ruled Alternate Pages          | 9" x 7" (230 x 178mm)   | Dark Green  | 80 | 100 | £19.99 | 8  |
| EX68167      | Plain Unruled & 8mm Ruled Alternate Pages          | A4 (300 x 210mm)        | Dark Green  | 48 | 100 | £29.70 | 9  |
| EX677344-5   | Plain Unruled & 8mm Ruled Alternate Pages          | A4 (300 x 210mm)        | Light Blue  | 64 | 50  | £16.45 | 10 |
| EX67769-5    | Plain Unruled & 8mm Ruled Alternate Pages          | A4 (300 x 210mm)        | Light Green | 64 | 50  | £16.45 | 10 |
| EX677123-5   | Plain Unruled & 8mm Ruled Alternate Pages          | A4 (300 x 210mm)        | Red         | 64 | 50  | £16.45 | 10 |
| EX677331-5   | Plain Unruled & 8mm Ruled Alternate Pages          | A4 (300 x 210mm)        | Yellow      | 64 | 50  | £16.45 | 10 |
| EX66875-5    | Plain Unruled & 8mm Ruled Alternate Pages          | A4 (300 x 210mm)        | Light Green | 80 | 50  | £16.55 | 11 |
| EX66878-5    | Plain Unruled & 8mm Ruled Alternate Pages          | A4 (300 x 210mm)        | Dark Green  | 80 | 50  | £16.55 | 11 |
| EX668123-5   | Plain Unruled & 8mm Ruled Alternate Pages          | A4 (300 x 210mm)        | Red         | 80 | 50  | £16.55 | 11 |
| EX554245     | Plain Unruled & 8mm Ruled & Margin Alternate Pages | 9" x 7" (230 x 178mm)   | Orange      | 80 | 100 | £19.99 | 8  |
| VEX352-200-6 | Plain Unruled & 8mm Ruled & Margin Alternate Pages | 9" x 7" (230 x 178mm)   | Brown       | 48 | 100 | £21.00 | 7  |
| PW02550      | Plain Unruled & 12mm Ruled Alternate Pages         | 8" x 6.5" (203 x 165mm) | Green       | 32 | 100 | £14.40 | 4  |
| AG014        | Plain Unruled & 12mm Ruled Alternate Pages         | 9" x 7" (230 x 178mm)   | Orange      | 48 | 100 | £21.00 | 7  |
| PW02555      | Plain Unruled & 15mm Ruled Alternate Pages         | 8" x 6.5" (203 x 165mm) | Yellow      | 32 | 100 | £14.40 | 4  |
| PW0263       | Plain Unruled & 15mm Ruled Alternate Pages         | 9" x 7" (230 x 178mm)   | Purple      | 32 | 100 | £23.70 | 7  |
| PW02421      | Plain Unruled & 15mm Ruled Alternate Pages         | A4 (300 x 210mm)        | Yellow      | 32 | 100 | £23.20 | 9  |
| PW02420      | Plain Unruled & 15mm Ruled Alternate Pages         | A4 (300 x 210mm)        | Red         | 32 | 100 | £23.20 | 9  |
| VRE01026-5   | Plain Unruled & 15mm Ruled Alternate Pages         | A4 (300 x 210mm)        | Purple      | 60 | 50  | £12.25 | 9  |
| EX67722-5    | Plain Unruled & 15mm Ruled Alternate Pages         | A4 (300 x 210mm)        | Red         | 64 | 50  | £16.45 | 10 |
| EX67723-5    | Plain Unruled & 15mm Ruled Alternate Pages         | A4 (300 x 210mm)        | Yellow      | 64 | 50  | £16.45 | 10 |



# Save The Rhino International

*Save the Rhino works to conserve viable populations of critically endangered rhinos in Africa and Asia. We recognise that the future of wildlife is inextricably*

*linked to the communities that share its habitat. By funding field projects and through education, our goal is to deliver material, long-lasting and widespread benefits to rhinos and other endangered species, ecosystems and to the people living in these areas.*

## Aims

- To increase the number of rhinos in genetically viable populations in the wild.
- To enhance the integrity of ecosystems.
- To ensure that local communities benefit from conservation activities.

## Primary objectives

- To provide financial and in-kind support for in situ projects focused on all five of the rhinoceros species.
- To encourage and enable the sharing of information, experience and skills between rhino projects.
- To measure and improve the effectiveness of our grant-making activities.

## Our grant-making activities

The funds we raise are used to support projects that address rhino conservation through a number of measures:

- Community conservation programmes that develop sustainable methods by which local communities can creatively manage natural resources.
- Environmental education programmes that teach children and adults about the importance of preserving natural resources and address human-wildlife conflict issues.
- Anti-poaching and monitoring patrols, which detect and deter poachers and gather information about rhino ranges and numbers.
- Translocations, so that rhinos from established populations can be reintroduced to former habitats.

- Research into the threats to rhino survival and alternatives to the use of rhino horn.
- Veterinary work, such as the implanting of transmitters into horns, or removal of snares.

## Our approach

- We employ a pragmatic approach focused on viable populations, and are not sentiment-driven.
- We support the sustainable use of natural resources for the mutual benefit of wildlife, habitat and local communities.
- We do not create or run our own projects in the field; rather, we find rhino conservation projects that we think are doing a good job, and then fund them.
- We prefer to work with projects on a long-term basis, rather than making one-off or ad hoc grants.
- SRI is a fundraising organisation, not a campaigning one: we do not get involved in political lobbying or petitioning.
- We believe in the value of partnership working with other in situ and ex situ NGOs and conservation organisations.

## Buying Rhino branded stationery saves Rhinos



When you purchase Rhino branded stationery, you are directly supporting the work of Save The Rhino International.

Substantial financial support is given to SRI through the sale of ethically produced educational and office stationery products from the Rhino range.

Rhino stationery's strong brand image serves as an extremely effective tool in raising the awareness of the work done by SRI.

For more information about the work of Save The Rhino International visit the official website at:

[www.savetherhino.org](http://www.savetherhino.org)



Grosvenor House Papers has been supplying exercise books, paper, card and classroom materials to the education sector since 1947.

Our well established family run business is the preferred choice for many of the largest education authorities in the United Kingdom.

We carry the complete range and are the sole stockist for the internationally renowned Rhino brand which manufactures superior quality exercise books, notepads and school papers.

Contact our friendly and helpful Customer Service team for more information about our products and services.



Grosvenor House Papers Limited  
Westmorland Business Park,  
Kendal,  
Cumbria  
LA9 6NP

T: 01539 726161  
F: 01539 733678  
E: [info@ghpkendal.co.uk](mailto:info@ghpkendal.co.uk)  
W: [www.ghpkendal.co.uk](http://www.ghpkendal.co.uk)

papermilldirect  
.co.uk

