

# Crystals

## Table of Contents

NONLINEAR CRYSTALS

LASER CRYSTALS

TERAHERTZ CRYSTALS

RAMAN CRYSTALS

POSITIONERS & HOLDERS

CRYSTAL OVENS

### NONLINEAR CRYSTALS

Lithium Triborate – LBO .....	2.2
Beta Barium Borate – BBO .....	2.4
Potassium Dideuterium Phosphate – KDP, DKDP .....	2.6
Potassium Titanyl Phosphate – KTP .....	2.8
Potassium Titanyle Arsenate – KTA .....	2.10
Lithium Niobate – LiNbO <sub>3</sub> .....	2.11
Lithium Iodate – LiIO <sub>3</sub> .....	2.12
Infrared Nonlinear Crystals .....	2.13
Ultrathin Nonlinear Crystals .....	2.16

### LASER CRYSTALS

Neodymium Doped Yttrium Aluminium Garnet – Nd:YAG .....	2.18
Yb-Doped Potassium Gadolinium Tungstate – Yb:KGW, Yb:KYW .....	2.19
Nd-Doped Potassium Gadolinium Tungstate – Nd:KGW .....	2.20
Titanium Doped Sapphire – Ti:Sapphire .....	2.20

### TERAHERTZ CRYSTALS

Semiconductor Terahertz Crystals – GaSe, ZnTe .....	2.21
---	------

### RAMAN CRYSTALS

Crystals for Stimulated Raman Scattering – KGW, Ba(NO <sub>3</sub> ) <sub>2</sub> .....	2.22
Barium & Strontium Tungstate-Molybdate – BaWO <sub>4</sub> .....	2.23
Passive Q-switching Crystals – Co <sup>2+</sup> :MgAl <sub>2</sub> O <sub>4</sub> , Cr <sup>4+</sup> :YAG .....	2.24

### POSITIONERS & HOLDERS

Ring Holders for Nonlinear Crystals 830-0001 .....	2.25
Kinematic Positioning Mount 840-0193 .....	2.26
Positioning Mount for Nonlinear Crystal Housing 840-0199 .....	2.26

### CRYSTAL OVENS

Temperature Controller TC2 with Oven CO1 .....	2.27
Heatpoint Crystal Ovens .....	2.28
Oven for Nonlinear Crystals CH8 .....	2.29
Oven for Nonlinear Crystals CH9 .....	2.30



# Nonlinear Crystals

NONLINEAR CRYSTALS

LASER CRYSTALS

TERAHERTZ CRYSTALS

RAMAN CRYSTALS

POSITIONERS & HOLDERS

CRYSTAL OVENS

## LBO

## LITHIUM TRIBORATE

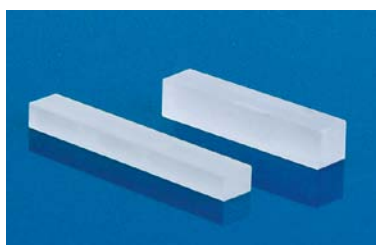

- Wide transparency region
- Broad Type 1 and Type 2
- Non-critical phase-matching (NCPM) range
- Small walk-off angle
- High damage threshold
- Wide acceptance angle
- High optical homogeneity

LBO is well suited for various nonlinear optical applications:

- frequency doubling and tripling of high peak power pulsed Nd doped, Ti:Sapphire and Dye lasers
- optical parametric oscillators (OPO) of both Type 1 and Type 2 phase-matching
- non-critical phase-matching for frequency conversion of CW and quasi-CW radiation.

### STANDARD SPECIFICATIONS

Flatness	$\lambda/8$ at 633 nm
Parallelism	< 20 arcsec
Surface quality	10-5 scratch & dig (MIL-PRF-13830B)
Perpendicularity	< 5 arcmin
Angle tolerance	< 30 arcmin
Aperture tolerance	$\pm 0.1$ mm
Clear aperture	90% of full aperture

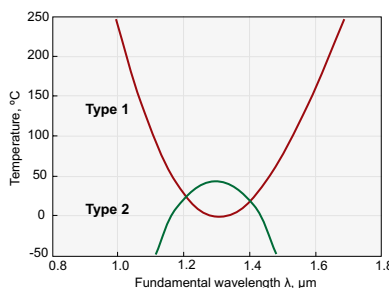

NCPM SHG temperature dependence of LBO

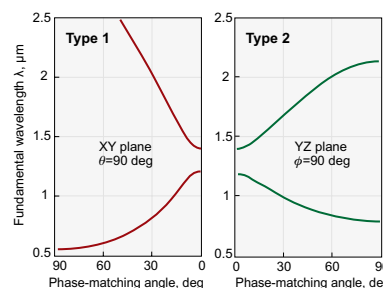

SHG tuning curves of LBO

### WE OFFER:

- Crystals length up to 90 mm and aperture up to 60×60 mm
- Thin crystals down to 10 μm thickness
- AR, BBAR, P-coatings
- Different mounting and repolishing services

### STANDARD CRYSTALS LIST

Code	Size, mm	$\theta$ , deg	$\phi$ , deg	Coating	Application	Price, EUR
LBO-401	3x3x10	90	11.6	AR/AR @ 1064+532 nm	SHG @ 1064 nm	245
LBO-402	3x3x15	90	11.6	AR/AR @ 1064+532 nm	SHG @ 1064 nm	325
LBO-301	4x4x10	90	11.6	AR/AR @ 1064+532 nm	SHG @ 1064 nm	510
LBO-302	4x4x15	90	11.6	AR/AR @ 1064+532 nm	SHG @ 1064 nm	630
LBO-303	4x4x20	90	11.6	AR/AR @ 1064+532 nm	SHG @ 1064 nm	745
LBO-501	5x5x10	90	11.6	AR/AR @ 1064+532 nm	SHG @ 1064 nm	655
LBO-503	5x5x15	90	11.6	AR/AR @ 1064+532 nm	SHG @ 1064 nm	765
LBO-502	5x5x20	90	11.6	AR/AR @ 1064+532 nm	SHG @ 1064 nm	940
LBO-404	3x3x15	90	0	AR/AR @ 1064+532 nm	NCPM SHG @ 1064 nm, T = 149 °C	325
LBO-405	3x3x20	90	0	AR/AR @ 1064+532 nm	NCPM SHG @ 1064 nm, T = 149 °C	405
LBO-409	3x3x30	90	0	AR/AR @ 1064+532 nm	NCPM SHG @ 1064 nm, T = 149 °C	710
LBO-410	3x3x50	90	0	AR/AR @ 1064+532 nm	NCPM SHG @ 1064 nm, T = 149 °C	1300
LBO-304	4x4x10	90	0	AR/AR @ 1064+532 nm	NCPM SHG @ 1064 nm, T = 149 °C	510
LBO-305	4x4x15	90	0	AR/AR @ 1064+532 nm	NCPM SHG @ 1064 nm, T = 149 °C	630
LBO-306	4x4x20	90	0	AR/AR @ 1064+532 nm	NCPM SHG @ 1064 nm, T = 149 °C	745
LBO-406	3x3x10	42.2	90	AR/AR @ 1064+532/355 nm	THG @ 1064 nm	245
LBO-407	3x3x15	42.2	90	AR/AR @ 1064+532/355 nm	THG @ 1064 nm	325
LBO-307	4x4x10	42.2	90	AR/AR @ 1064+532/355 nm	THG @ 1064 nm	510
LBO-308	4x4x15	42.2	90	AR/AR @ 1064+532/355 nm	THG @ 1064 nm	630
LBO-507	5x5x10	42.2	90	AR/AR @ 1064+532/355 nm	THG @ 1064 nm	655
LBO-508	5x5x15	42.2	90	AR/AR @ 1064+532/355 nm	THG @ 1064 nm	765

Please contact EK SMA OPTICS for special OEM and large volume pricing.

**PHYSICAL AND OPTICAL PROPERTIES**

Chemical formula	LiB <sub>3</sub> O <sub>5</sub>		
Crystal structure	orthorhombic, mm2		
Optical symmetry	Negative biaxial		
Space group	Pna2 <sub>1</sub>		
Density	2.47 g/cm <sup>3</sup>		
Mohs hardness	6		
Optical homogeneity	$\delta n = 10^{-6} \text{ cm}^{-1}$		
Transparency region at "0" transmittance level	155 – 3200 nm		
Linear absorption coefficient at 1064 nm	< 0.01 % cm <sup>-1</sup>		
Refractive indices:	$n_x$	$n_y$	$n_z$
at 1064 nm	1.5656	1.5905	1.6055
at 532 nm	1.5785	1.6065	1.6212
at 355 nm	1.5971	1.6275	1.6430
Sellmeier equations ( $\lambda$ , $\mu\text{m}$ )	$n_x^2 = 2.4542 + 0.01125 / (\lambda^2 - 0.01135) - 0.01388 \lambda^2$ $n_y^2 = 2.5390 + 0.01277 / (\lambda^2 - 0.01189) - 0.01849 \lambda^2 + 4.3025 \times 10^{-5} \lambda^4 - 2.9131 \times 10^{-5} \lambda^6$ $n_z^2 = 2.5865 + 0.0131 / (\lambda^2 - 0.01223) - 0.01862 \lambda^2 + 4.5778 \times 10^{-5} \lambda^4 - 3.2526 \times 10^{-5} \lambda^6$		
Phase matching range Type 1 SHG	554 – 2600 nm		
Phase matching range Type 2 SHG	790 – 2150 nm		
NCPM SHG temperature dependence:			
Type 1 range 950 – 1300 nm	T1 = - 1893.3 $\lambda^4$ + 8886.6 $\lambda^3$ - 13019.8 $\lambda^2$ + 5401.5 $\lambda$ + 863.9		
Type 1 range 1300 – 1800 nm	T2 = 878.1 $\lambda^4$ - 6954.5 $\lambda^3$ + 20734.2 $\lambda^2$ - 26378 $\lambda$ + 12020		
Type 2 range 1100 – 1500 nm	T3 = - 21630.6 $\lambda^4$ + 112251 $\lambda^3$ - 220460 $\lambda^2$ + 194153 $\lambda$ - 64614.5		
NCPM SHG at 1064 nm Type 1 temperature	149 °C		
NCPM SHG at 1319 nm Type 2 temperature	43 °C		
Walk-off angle	7 mrad (Type 1 SHG 1064 nm)		
Thermal acceptance	6.4 K×cm (Type 1 SHG 1064 nm)		
Angular acceptance	6.5 mrad×cm (Type 1 SHG 1064 nm)		
	248 mrad×cm (Type 1 NCPM SHG 1064 nm)		
Nonlinearity coefficients	$d_{31} = -(0.98 \pm 0.09) \text{ pm/V}$ ; $d_{32} = (1.05 \pm 0.09) \text{ pm/V}$ ; $d_{33} = (0.05 \pm 0.006) \text{ pm/V}$		
Effective nonlinearity:			
XY plane	$d_{\text{ooe}} = d_{32} \cos\phi$		
YZ plane	$d_{\text{ooo}} = d_{\text{eoo}} = d_{31} \cos\theta$		
Expansion coefficients	$\alpha_x = 10.8 \times 10^{-5} \text{ K}^{-1}$ ; $\alpha_y = -8.8 \times 10^{-5} \text{ K}^{-1}$ ; $\alpha_z = 3.4 \times 10^{-5} \text{ K}^{-1}$		
Laser induced damage threshold (LIDT)	>5 J/cm <sup>2</sup> (>500 MW/cm <sup>2</sup> ), 1064 nm, 10 ns, 10 Hz		

Please contact EKSMA OPTICS  
for further information or nonstandard specifications.

**RELATED PRODUCTS**

LBO crystals for SHG of Yb:KGW/KYW laser frequency conversion. See page 5.38

**Crystal Oven TC2**

See page 2.27



149 °C temperature is required to achieve Non-Critical Phase Matching (NCPM) in LBO at type 1 SHG of 1064 nm application. **TC2 oven** is specially designed for this purpose (see technical specifications, p. 2.27).

**Heatpoint Crystal Oven**

See page 2.28



**Heatpoint** is a compact round oven designed for heating (30 – 80 °C) of humidity sensitive nonlinear crystals. It is used to prevent moisture condensation on crystal faces or for thermostabilization of the crystals.

**BBO BETA BARIUM BORATE**



- Wide transparency region
- Broad phase-matching range
- Large nonlinear coefficient
- High damage threshold
- Wide thermal acceptance bandwidth
- High optical homogeneity

**WE OFFER:**

- Crystal aperture up to 22 × 22 mm
- Crystal length up to 25 mm
- Thin crystals down to 5 μm thickness
- AR, BBAR, P-coating
- BBO with gold electrodes for e/o applications
- Different mounting and repolishing services

As a result of its excellent properties BBO has a number of advantages for different applications:

- harmonic generations (up to fifth) of Nd doped lasers
- frequency doubling and tripling of ultrashort pulse Ti:Sapphire and Dye lasers
- optical parametric oscillators (OPO) at both Type 1(ooe) and Type 2 (eoe) phase-matching
- frequency doubling of Argon ion and Copper vapour laser radiation
- electro-optic crystal for Pockels cells
- ultrashot pulse duration measurements by autocorrelation.

**STANDARD SPECIFICATIONS**

Flatness	λ/8 at 633 nm
Parallelism	< 20 arcsec
Surface quality	10-5 scratch & dig (MIL-PRF-13830B)
Perpendicularity	<5 arcmin
Angle tolerance	<30 arcmin
Aperture tolerance	± 0.1 mm
Clear aperture	90% of full aperture

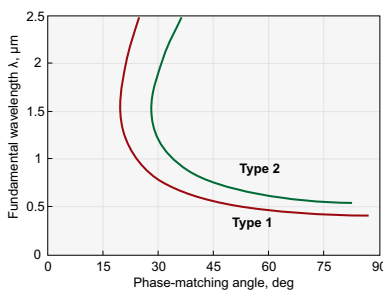

SHG tuning curve of BBO

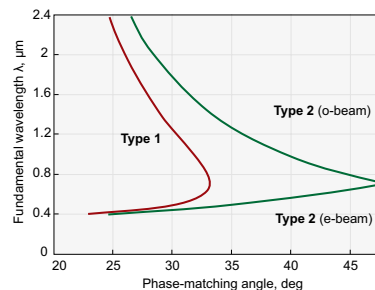

OPO tuning curves of BBO at 355 nm pump

**STANDARD CRYSTALS LIST**

Catalogue number	Size, mm	θ, deg	φ, deg	Coating	Application	Price, EUR
BBO-601H	6×6×0.1	29.2	90	P/P @ 400-800 nm	SHG @ 800 nm, Type 1	505
BBO-602H	6×6×0.2	29.2	90	P/P @ 400-800 nm	SHG @ 800 nm, Type 1	505
BBO-603H	6×6×0.5	29.2	90	P/P @ 400-800 nm	SHG @ 800 nm, Type 1	440
BBO-604H	6×6×1	29.2	90	P/P @ 400-800 nm	SHG @ 800 nm, Type 1	390
BBO-605H	6×6×2	29.2	90	P/P @ 400-800 nm	SHG @ 800 nm, Type 1	360
BBO-609H	6×6×0.1	44.3	90	P/P @ 400-800/266 nm	THG @ 800 nm, Type 1	505
BBO-610H	6×6×0.2	44.3	90	P/P @ 400-800/266 nm	THG @ 800 nm, Type 1	505
BBO-611H	6×6×0.5	44.3	90	P/P @ 400-800/266 nm	THG @ 800 nm, Type 1	440
BBO-612H	6×6×1	44.3	90	P/P @ 400-800/266 nm	THG @ 800 nm, Type 1	390
BBO-1001H	10×10×0.1	29.2	90	P/P @ 400-800 nm	SHG @ 800 nm, Type 1	800
BBO-1002H	10×10×0.2	29.2	90	P/P @ 400-800 nm	SHG @ 800 nm, Type 1	790
BBO-1003H	10×10×0.5	29.2	90	P/P @ 400-800 nm	SHG @ 800 nm, Type 1	760
BBO-1004H	10×10×1	29.2	90	P/P @ 400-800 nm	SHG @ 800 nm, Type 1	765
BBO-1005H	10×10×2	29.2	90	P/P @ 400-800 nm	SHG @ 800 nm, Type 1	830
BBO-1009H	10×10×0.1	44.3	90	P/P @ 400-800/266 nm	THG @ 800 nm, Type 1	800
BBO-1010H	10×10×0.2	44.3	90	P/P @ 400-800/266 nm	THG @ 800 nm, Type 1	790
BBO-1011H	10×10×0.5	44.3	90	P/P @ 400-800/266 nm	THG @ 800 nm, Type 1	760
BBO-1012H	10×10×1	44.3	90	P/P @ 400-800/266 nm	THG @ 800 nm, Type 1	785



Wide selection of non-standard size and cut angle BBO crystals is available at [www.eksmaoptics.com](http://www.eksmaoptics.com)



Please contact EKSMA OPTICS for special OEM and large volume pricing.

**PHYSICAL AND OPTICAL PROPERTIES**

Chemical formula	BaB <sub>2</sub> O <sub>4</sub>	
Crystal structure	trigonal, 3m	
Optical symmetry	Negative Uniaxial (n <sub>o</sub> >n <sub>e</sub> )	
Space group	R3c	
Density	3.85 g/cm <sup>3</sup>	
Mohs hardness	5	
Optical homogeneity	Δn = 10 <sup>-6</sup> cm <sup>-1</sup>	
Transparency region at "0" transmittance level	189 – 3500 nm	
Linear absorption coefficient at 1064 nm	< 0.1% cm <sup>-1</sup>	
Refractive indices	n <sub>o</sub>	n <sub>e</sub>
at 1064 nm	1.6551	1.5426
at 532 nm	1.6750	1.5555
at 355 nm	1.7055	1.5775
at 266 nm	1.7571	1.6139
at 213 nm	1.8465	1.6742
Sellmeier equations (λ, μm)	n <sub>o</sub> <sup>2</sup> = 2.7366122 + 0.0185720 / (λ <sup>2</sup> - 0.0178746) - 0.0143756 λ <sup>2</sup>	
	n <sub>e</sub> <sup>2</sup> = 2.3698703 + 0.0128445 / (λ <sup>2</sup> - 0.0153064) - 0.0029129 λ <sup>2</sup>	
Phase matching range Type 1 SHG	410 – 3300 nm	
Phase matching range Type 2 SHG	530 – 3300 nm	
Walk-off angle	55.9 mrad (Type 1 SHG 1064 nm)	
Angular acceptance	1.2 mrad × cm (Type 1 SHG 1064 nm)	
Thermal acceptance	70 K × cm (Type 1 SHG 1064 nm)	
Nonlinearity coefficients	d <sub>22</sub> = ± 2.2 pm/V; d <sub>15</sub> = d <sub>31</sub> = ± 0.08 pm/V	
Effective nonlinearity expressions	d <sub>00e</sub> = d <sub>31</sub> sinθ - d <sub>22</sub> cosθ sin3φ d <sub>0ee</sub> = d <sub>0ee</sub> = d <sub>22</sub> cos <sup>2</sup> θ cos3φ	
Thermal expansion coefficient	α <sub>11</sub> = 4 × 10 <sup>-6</sup> K <sup>-1</sup> ; α <sub>33</sub> = 36 × 10 <sup>-6</sup> K <sup>-1</sup>	
Damage threshold for TEM <sub>00</sub>	> 0.5 GW/cm <sup>2</sup> at 1064 nm, 10 ns ~ 50 GW/cm <sup>2</sup> at 1064 nm, 1 ps > 200 GW/cm <sup>2</sup> at 800 nm, 100 fs, 50 Hz	

P-protective coating. It's a single or two layers antireflection coating made at specified wavelength range. Typical reflection values are R≈2% in the mid range, R<4%

at the edges. P coating is recommended for ultrashort pulses applications and features low dispersion.

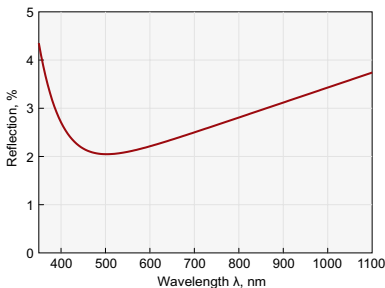

Typical P-coating for BBO SHG@800 nm application

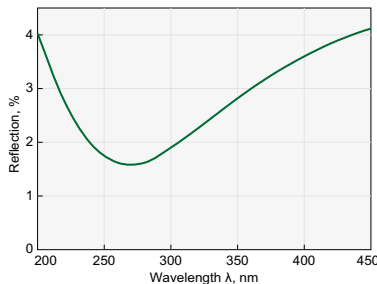

Typical coating for BBO THG@800 nm or SHG@532 nm applications (output face P@266 nm)

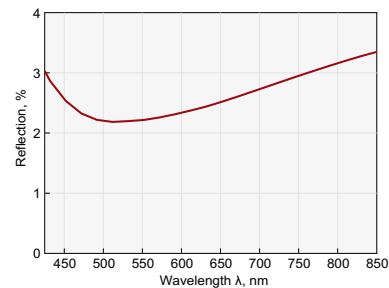

Typical coating for BBO SHG@532 nm application (input face P@532 nm)

**RELATED PRODUCTS**

Thin BBO crystals for SHG and THG of Ti:Sapphire laser wavelength  
See page 5.31

BBO crystals for SHG of Yb:KGW/KYW laser frequency conversion  
See page 5.38

**HOUSING ACCESSORIES**

Ring Holders for Nonlinear Crystals  
See page 2.25



Positioning Mount 840-0199 for Nonlinear Crystal Housing  
Accepts crystals with aperture up to 12x12 mm and thickness up to 3 mm.  
See page 2.26



**KDP • DKDP POTASSIUM DIDEUTERIUM PHOSPHATE**

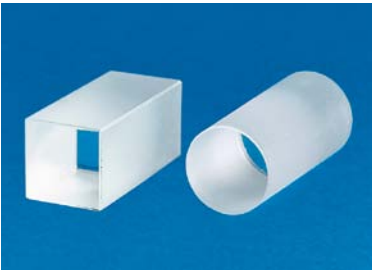

- **Laser frequency conversion – harmonic generation for high pulse energy, low repetition (<100 Hz) rate lasers**
- **Electro-optical modulation**
- **Q-switching crystal for Pockels cells**

**ELECTRO-OPTICAL/Q-SWITCHING APPLICATION**

- EKSMA OPTICS offers highly deuterated  $D > 96\%$  **electro-optic crystal – DKDP** for Q-switching application;
- Standard dimensions of **electro-optic DKDP crystals** for Q-switching are cylinders dia 9x20 mm and dia 12x24 mm however manufacturing of custom size and rectangular shape crystals is available;
- Gold evaporated or silver paste electrodes are available;
- **Dielectric thin film AR coatings** for specified laser wavelengths are available;
- Typical quarter wave voltage 3.4 kV at 1064 nm;
- Typical contrast ratio between crossed polarizers better than 1:2000;
- Damage threshold of AR coated DKDP surface  $> 5 \text{ J/cm}^2$  at 1064 nm, 10 ns pulses.

**FREQUENCY CONVERSION APPLICATIONS**

- **DKDP crystals** are used for second harmonic generation of high pulse energy low repetition rate (<100 Hz) Q-switched and mode-locked Nd:YAG lasers. Cut angle of crystal for operation at room temperature is  $36.6^\circ$  for Type 1 phase matching and  $53.7^\circ$  deg for Type 2 phase matching.
- **DKDP crystals** are used for third harmonic generation of high pulse energy Q-switched and mode-locked Nd:YAG lasers via sum frequency generation. Cut angle of crystal for operation at room temperature is  $59.3^\circ$  for Type 2 phase matching.

**STANDARD SPECIFICATIONS**

Flatness	$\lambda/6$ at 633 nm
Parallelism	$< 20$ arcsec
Surface quality	20-10 scratch & dig (MIL-PRF-13830B)
Perpendicularity	$< 5$ arcmin
Angle tolerance	$< 30$ arcmin
Aperture tolerance	$\pm 0.1$ mm
Clear aperture	90% of full aperture

- Type 1 **DKDP crystals** with non-critical cut angle  $\theta = 90^\circ$  are used for fourth harmonic generation (532 nm  $\rightarrow$  266 nm) of high pulse energy Q-switched and mode-locked Nd:YAG lasers. Crystal must be heated at  $\sim 50^\circ \text{C}$  temperature to match NCPM conditions.
- Type 1 **KDP crystals** with close to non-critical cut angle  $\theta = 76.5^\circ$  are used for fourth harmonic generation (532 nm  $\rightarrow$  266 nm) of high pulse energy Q-switched and mode-locked Nd:YAG lasers. KDP has lower absorption at UV wavelengths comparing to DKDP.
- **KDP thin crystals** are used for second harmonic generation of Ti:Sapphire laser radiation or pulse duration measurement in single shot autocorrelators. KDP possesses  $\sim 2.4$  times larger spectral acceptance and correspondingly smaller group velocity mismatch comparing to BBO crystal for SHG of 800 nm, what sometime is very critical parameter for femtosecond wide spectrum pulses.
- KDP crystals can be supplied by EKSMA OPTICS of aperture up to  $\varnothing 80$  mm. Actually KDP remains the only solution for harmonic generation of very high intensity femtosecond Ti:Sapphire lasers featuring sub-tera Watt or tera Watt peak power pulses in large  $> 30$  mm diameter beams.

**STANDARD CRYSTALS LIST**

Code	Size, mm	$\theta$ , deg	$\phi$ , deg	Coating	Application	Price, EUR
DKDP-401	15x15x13	36.5	45	AR/AR @ 1064+532 nm	SHG @ 1064 nm, Type 1	485
DKDP-402	15x15x13	53.5	0	AR/AR @ 1064+532 nm	SHG @ 1064 nm, Type 2	485
DKDP-403	12x12x20	59.3	0	AR/AR @ 1064+532 / 355 nm	THG @ 1064 nm, Type 2	475
DKDP-404	12x12x20	53.5	0	AR/AR @ 1064 / 1064+532 nm	SHG @ 1064 nm	475
DKDP-405	15x15x20	53.5	0	AR/AR @ 1064 / 1064+532 nm	SHG @ 1064 nm	579
DKDP-406	15x15x20	59.3	0	AR/AR @ 1064+532 / 355 nm	THG @ 1064 nm	579
KDP-401	12x12x5	76.5	45	AR/AR @ 532/266 nm	SHG @ 532 nm	405
KDP-402	15x15x7	76.5	45	AR/AR @ 532/266 nm	SHG @ 532 nm	480



Wide selection of non-standard size and cut angle DKDP crystals is available at [www.eksmaoptics.com](http://www.eksmaoptics.com)



Please contact EKSMA OPTICS for special OEM and large volume pricing.

NONLINEAR CRYSTALS

LASER CRYSTALS

TERAHERTZ CRYSTALS

RAMAN CRYSTALS

POSITIONERS & HOLDERS

CRYSTAL OVENS

**PHYSICAL AND OPTICAL PROPERTIES**

Crystals		KDP	DKDP
Chemical formula		KH <sub>2</sub> PO <sub>4</sub>	KD <sub>2</sub> PO <sub>4</sub>
Symmetry		42 m	42 m
Hygroscopicity		high	high
Density, g/cm <sup>3</sup>		2.332	2.355
Thermal conductivity, W/cm×K		k <sub>11</sub> = 1.9×10 <sup>-2</sup>	k <sub>11</sub> = 1.9×10 <sup>-2</sup> k <sub>33</sub> = 2.1×10 <sup>-2</sup>
Thermal expansion coefficients, K <sup>-1</sup>		a <sub>11</sub> = 2.5×10 <sup>-5</sup> a <sub>33</sub> = 4.4×10 <sup>-5</sup>	a <sub>11</sub> = 1.9×10 <sup>-5</sup> a <sub>33</sub> = 4.4×10 <sup>-5</sup>
Transmission range, μm		0.18–1.5	0.2–2.0
Residual absorption, cm <sup>-1</sup> (at 1.06 μm)		0.04	0.005
Measured refractive index (at 1.06 μm)		n <sub>o</sub> = 1.4938 n <sub>e</sub> = 1.4599	n <sub>o</sub> = 1.4931 n <sub>e</sub> = 1.4582
Sellmeier coeff., λ – wavelength in μm		$n^2 = A + \frac{B \lambda^2}{\lambda^2 - C} + \frac{D}{\lambda^2 - E}$	
A	n <sub>o</sub>	2.259276	2.2409
	n <sub>e</sub>	2.132668	2.1260
B	n <sub>o</sub>	13.00522	2.2470
	n <sub>e</sub>	3.2279924	0.7844
C	n <sub>o</sub>	400	126.9205
	n <sub>e</sub>	400	123.4032
D	n <sub>o</sub>	0.01008956	0.0097
	n <sub>e</sub>	0.008637494	0.0086
E	n <sub>o</sub>	0.012942625	0.0156
	n <sub>e</sub>	0.012281043	0.0120
Nonlinear coeff. d <sub>36</sub> , pm/V (at 1.06 μm)		0.43	0.40
Effective nonlinear coefficient		d <sub>ooe</sub> = d <sub>36</sub> × sinθ × sin2φ d <sub>oee</sub> = d <sub>36</sub> × sinθ × cos2φ	
Type 1		10 ps – 100	250 ps – 6
Type 2		1 ns – 10	10 ns – 0.5
Laser damage threshold, GW/cm <sup>2</sup> at 1.06 μm		15 ns – 14.4	

**PHASE MATCHING ANGLES AND BANDWIDTHS FOR SHG OF 1064 nm**

Crystal	KDP		DKDP	
	Type 1 ooe	Type 2 eoe	Type 1 ooe	Type 2 eoe
Type of phase matching				
Cut angle θ, deg	41.2	59.1	36.6	53.7
Acceptances for crystal of 1 cm length (FWHM):				
Δθ (angular), mrad	1.1	2.2	1.2	2.3
ΔT thermal, K	10	11.8	32.5	29.4
Δλ spectral, nm	21	4.5	6.6	4.2
Walk off, mrad	28	25	25	25

**ADP, DADP, RDP, CDA and DCDA crystals are available upon request!**

**RELATED PRODUCTS**

Nonlinear Crystal Oven CH8

See page 2.29



Nonlinear Crystal Oven CH9

See page 2.30



DKDP and KDP crystals are highly hygroscopic. CH8 and CH9 ovens help to protect hygroscopic crystals from moisture. The raised working temperature (40-60 °C) allows to extend crystal lifetime and to keep it thermostable. This helps to stabilise SHG efficiency.

**KTP POTASSIUM TITANYL PHOSPHATE**

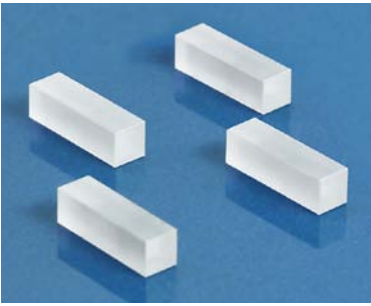

- Excellent nonlinear, electro-optical and acousto-optical properties
- High nonlinear coefficient
- Wide transparency range
- Broad angular acceptance
- Broad thermal acceptance

**WE OFFER:**

- Crystal size up to 10×10×20 mm
- Singleband and dualband AR and BBAR coatings
- Standard and customised mounts and housings
- Free technical consulting.

KTP is a standard crystal mostly used in extracavity configuration when a single pass through the crystal is required. KTP crystals are optimised for SHG intracavity configuration in low peak power CW lasers. Due to the large number of passes through the crystal, low insertion losses and high homogeneity are essential for conversion efficiency. The special highest quality material selected by SHG efficiency mapping of each crystal, fine surface polishing and dual band AR coatings with very low losses allow EK SMA OPTICS to produce KTP crystals suitable for intracavity SHG application.

**STANDARD SPECIFICATIONS**

Flatness	λ/8 at 633 nm
Parallelism	< 20 arcsec
Surface quality	10-5 scratch & dig (MIL-PRF-13830B)
Perpendicularity	< 5 arcmin
Angle tolerance	< 30 arcmin
Aperture tolerance	± 0.1 mm
Clear aperture	90% of full aperture

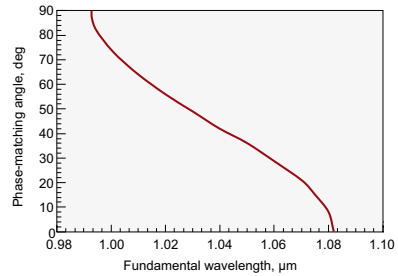

Fig. 1. Type 2 SHG in x-y plane

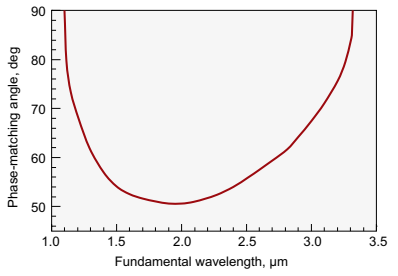

Fig. 2. Type 2 SHG in x-z plane

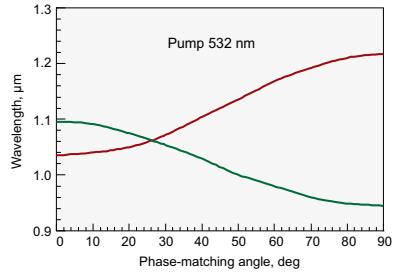

Fig. 3. OPO tuning curve in x-y plane

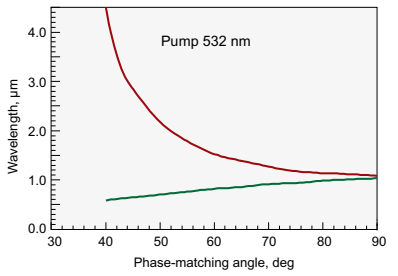

Fig. 4. OPO tuning curve in x-z plane

Fig. 1 represents Type 2 SHG tuning curve of KTP in x-y plane. In x-y plane the slope  $\partial(\Delta k)/\partial\theta$  is small. This corresponds to quasi-angular noncritical phase-matching, which ensures the double advantage of a large acceptance angle and a small walk off. Otherwise in x-z plane the slope  $\partial(\Delta k)/\partial\lambda$  is almost zero for wavelengths in the range 1.5–2.5 μm and this corresponds to quasi-wavelength noncritical phase-matching, which ensures a large spectral

acceptance (see Fig. 2). Wavelength non-critical phase-matching is highly desirable for frequency conversion of short pulses. As a lasing material for OPG, OPA or OPO, KTP can most usefully be pumped by Nd lasers and their second harmonic or any other source with intermediate wavelength, such as a dye laser (near 600 nm). Fig. 3 and Fig. 4 show the phase-matching angles for OPO/OPA pumped at 532 nm in x-y and x-z plane respectively.

**STANDARD CRYSTALS LIST**

Code	Size, mm	θ, deg	φ, deg	Coating	Application	Price, EUR
KTP-401	3x3x5	90	23.5	AR/AR @ 1064+532 nm	SHG @ 1064 nm	76
KTP-402	3x3x10	90	23.5	AR/AR @ 1064+532 nm	SHG @ 1064 nm	109
KTP-403	4x4x6	90	23.5	AR/AR @ 1064+532 nm	SHG @ 1064 nm	118
KTP-404	7x7x9	90	23.5	AR/AR @ 1064+532 nm	SHG @ 1064 nm	529

Please contact EK SMA OPTICS for special OEM and large volume pricing.

NONLINEAR CRYSTALS  
LASER CRYSTALS  
TERAHERTZ CRYSTALS  
RAMAN CRYSTALS  
POSITIONERS & HOLDERS  
CRYSTAL OVENS



**PHYSICAL PROPERTIES**

Crystal structure	orthorhombic	
Point group	mm2	
Space group	Pna2 <sub>1</sub>	
Lattice constants, Å	a = 6.404, b = 10.616, c = 12.814, z = 8	
Density, g/cm <sup>3</sup>	3.01	
Melting point, °C	1172	
Transition temperature, °C	936	
Mohs hardness	5	
Thermal expansion coefficients, °C <sup>-1</sup>	a <sub>x</sub> = 11×10 <sup>-6</sup> , a <sub>y</sub> = 9×10 <sup>-6</sup> , a <sub>z</sub> = 0.6×10 <sup>-6</sup>	
Thermal conductivity, W/cm <sup>2</sup> °C	13	
Not hygroscopic		

**OPTICAL PROPERTIES**

Transparency	350–4400 nm	
Refractive indices	at 1064 nm	at 532 nm
	n <sub>x</sub> = 1.7404	n <sub>x</sub> = 1.7797
	n <sub>y</sub> = 1.7479	n <sub>y</sub> = 1.7897
	n <sub>z</sub> = 1.8296	n <sub>z</sub> = 1.8877
Thermo-optic coefficients in 0.4 – 1.0 μm range	∂n <sub>x</sub> /∂T = 1.1×10 <sup>-5</sup> (K) <sup>-1</sup>	
	∂n <sub>y</sub> /∂T = 1.3×10 <sup>-5</sup> (K) <sup>-1</sup>	
	∂n <sub>z</sub> /∂T = 1.6×10 <sup>-5</sup> (K) <sup>-1</sup>	
Wavelength dispersion of refractive indices	n <sub>x</sub> <sup>2</sup> = 3.0067 + 0.0395/(λ <sup>2</sup> - 0.04251) - 0.01247×λ <sup>2</sup>	
	n <sub>y</sub> <sup>2</sup> = 3.0319 + 0.04152/(λ <sup>2</sup> - 0.04586) - 0.01337×λ <sup>2</sup>	
	n <sub>z</sub> <sup>2</sup> = 3.3134 + 0.05694/(λ <sup>2</sup> - 0.05941) - 0.016713×λ <sup>2</sup>	

**NONLINEAR PROPERTIES**

Phase matching range for:	
Type 2 SHG in x-y plane	0.99÷1.08 μm
Type 2 SHG in x-z plane	1.1÷3.4 μm
For Type 2, SHG @ 1064 nm, cut angle θ=90°, φ=23.5°	
Walk-off	4 mrad
Angular acceptances	Δθ = 55 mrad × cm
	Δφ = 10 mrad × cm
Thermal acceptance	ΔT = 22 K × cm
Spectral acceptance	Δν = 0.56 nm × cm
Up to 80% extracavity SHG efficiency	
Effective nonlinearity	
x-y plane	d <sub>00e</sub> = d <sub>0ee</sub> = d <sub>15</sub> sin <sup>2</sup> φ + d <sub>24</sub> cos <sup>2</sup> φ
x-z plane	d <sub>0e0</sub> = d <sub>e00</sub> = d <sub>24</sub> sinθ
	d <sub>31</sub> = ± 1.95 pm/V    d <sub>32</sub> = ± 3.9 pm/V
	d <sub>33</sub> = ± 15.3 pm/V    d <sub>24</sub> = d <sub>32</sub> d <sub>15</sub> = d <sub>31</sub>
Damage threshold	>500 MW/cm <sup>2</sup> for pulses λ=1064 nm, τ=10 ns, 10 Hz, TEM <sub>00</sub>

**RELATED PRODUCTS**

Crystal Oven TC2

See page 2.27



Ring Holders for Nonlinear Crystals

See page 2.25



Heatpoint Crystal Oven

See page 2.28



Positioning Mount 840-0199 for Nonlinear Crystal Housing

See page 2.26



## KTA POTASSIUM TITANYLE ARSENATE

- **Significantly reduced absorption in band range of 2.0 – 5.0 μm**
- **Broad angular bandwidth**
- **Broad temperature bandwidth**
- **Low dielectric constants**

Potassium titanyle arsenate (KTiOAsO<sub>4</sub>), or KTA, is a nonlinear optical crystal for Optical Parametric Oscillation (OPO) application. It has good nonlinear optical and electro-optical properties, e.g. significantly reduced absorption in band range of 2.0-5.0 μm, broad angular and temperature bandwidth, low dielectric constants.

### SPECIFICATIONS

Flatness	λ/8 at 633 nm
Parallelism	< 20 arcsec
Surface quality	10-5 scratch & dig (MIL-PRF-13830B)
Perpendicularity	< 15 arcmin
Angle tolerance	< ± 0.2°
Aperture tolerance	± 0.1 mm
Clear aperture	> 90% central area
Transmitting wavefront distortion	less than λ/8 @ 633 nm

### WE OFFER:

- KTA crystals size up to 15×15×30 mm
- AR and BBAR coatings for VIS-IR and mid IR ranges

### PRIMARY APPLICATIONS

- OPO for mid IR generation – up to 4 μm
- Sum and Difference Frequency Generation in mid IR range
- Electro-optical modulation and Q-switching

### STANDARD CRYSTALS LIST

Code	Size, mm	θ, deg	φ, deg	Coating	Application	Price, EUR
KTA-503	5×5×20	45	0	AR/AR @ 1064+(1500-4500) nm	Nanosecond OPO @ 1064 nm	1985
KTA-504	5×5×10	45	0	AR/AR @ 1064+(1500-4500) nm	Picosecond OPG/A @ 1064 nm	1060
KTA-601H	6×6×1	47	0	AR/AR @ 1.2-2.4/2.6-5.0 μm	DFG @ 1.2-2.4 μm	675
KTA-602H	6×6×3	46	0	AR/AR @ 1030+(1700-5000) nm	OPO @ 1030 nm	590

*Please contact EK SMA OPTICS for special OEM and large volume pricing.*

### PHYSICAL PROPERTIES

Crystal structure	orthorhombic
Point group	mm2
Space group	Pna21
Lattice constants, Å	a = 13.125, b = 6.5716, c = 10.786
Density, g/cm <sup>3</sup>	3.45
Melting point, °C	1130
Mohs hardness	5
Thermal conductivity, W/m×K	k <sub>1</sub> =1.8, k <sub>2</sub> =1.9, k <sub>3</sub> =2.1
Not hygroscopic	

### NONLINEAR & OPTICAL PROPERTIES

Transparency	350 – 5300 nm
Wavelength dispersion of refractive indices	$n_x^2 = 1.90713 + 1.23522 \times \lambda^2 / (\lambda^2 - 0.196922^2) - 0.01025 \times \lambda^2$
	$n_y^2 = 2.15912 + 1.00099 \times \lambda^2 / (\lambda^2 - 0.218442^2) - 0.01096 \times \lambda^2$
	$n_z^2 = 2.14768 + 1.29559 \times \lambda^2 / (\lambda^2 - 0.227192^2) - 0.01436 \times \lambda^2$
Electro optical constants	r <sub>33</sub> = 37.5 pm/V, r <sub>23</sub> = 15.4 pm/V, r <sub>13</sub> = 11.5 pm/V
Effective nonlinearity	x-y plane
	$d_{00e} = d_{0ee} = d_{15}\sin^2\phi + d_{24}\cos^2\phi$
	x-z plane
	$d_{0e0} = d_{e00} = d_{24}\sin\theta$
	d <sub>31</sub> =2.3 pm/V, d <sub>32</sub> =3.66 pm/V, d <sub>33</sub> =15.5 pm/V
	d <sub>24</sub> = 3.64 pm/V, d <sub>15</sub> = 2.3 pm/V
Damage threshold	>500 MW/cm <sup>2</sup> for pulses λ=1064 nm, τ=10 ns, 10 Hz, TEM <sub>00</sub>

NONLINEAR CRYSTALS  
LASER CRYSTALS  
TERAHERTZ CRYSTALS  
RAMAN CRYSTALS  
POSITIONERS & HOLDERS  
CRYSTAL OVENS

**LiNbO<sub>3</sub>**
**LITHIUM NIOBATE**

Lithium Niobate (LiNbO<sub>3</sub>) nonlinear optical crystals are well suited for a wide range of applications:

- Electro-optical modulation
- Q-switching
- Laser frequency conversion of wavelengths >1 μm

**SPECIFICATIONS**

Flatness	λ/8 at 633 nm
Parallelism	< 20 arcsec
Surface quality	10-5 scratch & dig (MIL-PRF-13830B)
Perpendicularity	< 5 arcmin
Angle tolerance	< 30 arcmin
Clear aperture	90% of full aperture

**STANDARD CRYSTALS LIST**

Code	Size, mm	Orientation	Coating	Price, EUR
<b>LNO-602</b>	6×6×25	z-cut	AR/AR @ 1064 nm	550
<b>LNO-901</b>	9×9×25	z-cut	AR/AR @ 1064 nm	620

**PHYSICAL AND OPTICAL PROPERTIES**

Chemical formula	LiNbO <sub>3</sub>
Crystal structure	trigonal
Space group	R3C
Density	4.64 g/cm <sup>3</sup>
Mohs hardness	5
Optical homogeneity	~ 5 × 10 <sup>-5</sup> / cm
Transparency range	420 – 5200 nm
Absorption coefficient	~ 0.1 % / cm @ 1064 nm
Refractive indices at 1064 nm	n <sub>e</sub> = 2.146, n <sub>o</sub> = 2.220 @ 1300 nm n <sub>e</sub> = 2.156, n <sub>o</sub> = 2.232 @ 1064 nm n <sub>e</sub> = 2.203, n <sub>o</sub> = 2.286 @ 632.8 nm
Sellmeier equations (λ, μm)	n <sub>o</sub> <sup>2</sup> = 4.9048 + 0.11768 / (λ <sup>2</sup> - 0.04750) - 0.027169 λ <sup>2</sup> n <sub>e</sub> <sup>2</sup> = 4.5820 + 0.099169 / (λ <sup>2</sup> - 0.04443) - 0.021950 λ <sup>2</sup>
Thermal expansion coefficient @ 25 °C	//a, 2.0 × 10 <sup>-6</sup> / K //c, 16.7 × 10 <sup>-6</sup> / K
Thermal conductivity	~ 5 W/m/K @ 25 °C
Thermal optical coefficient	dn <sub>o</sub> /dT = -0.874 × 10 <sup>-6</sup> / K at 1.4 μm dn <sub>e</sub> /dT = 39.073 × 10 <sup>-6</sup> / K at 1.4 μm

**LiIO<sub>3</sub> LITHIUM IODATE**

- High nonlinear optical coefficients
- Wide transparency range
- Low damage threshold – not recommended for high power applications

**APPLICATIONS**

- Harmonic generators
- Thin LiIO<sub>3</sub> for autocorrelation measurements

**SPECIFICATIONS**

Flatness	λ/6 at 633 nm
Parallelism	< 30 arcsec
Surface quality	20-10 scratch & dig (MIL-PRF-13830B)
Perpendicularity	< 5 arcmin
Angle tolerance (Δθ & Δφ)	< 30 arcmin
Clear aperture	90% of full aperture

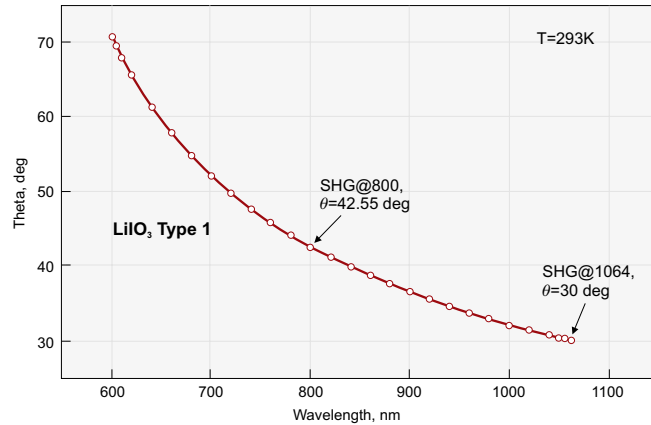

LiIO<sub>3</sub> Second harmonic generation phase matching

**PHYSICAL AND OPTICAL PROPERTIES**

Crystal structure	hexagonal
Point group	6
Density, g/cm <sup>3</sup>	4.487
Mohs hardness	3.5–4.0
Transparency range, nm	280–4000
Absorption at 1064 nm, cm <sup>-1</sup>	< 0.05
Refractive indices	at 1064 nm: n <sub>o</sub> = 1.8571, n <sub>e</sub> = 1.7165
	at 800 nm: n <sub>o</sub> = 1.8676, n <sub>e</sub> = 1.7245
	at 532 nm: n <sub>o</sub> = 1.8982, n <sub>e</sub> = 1.7480
Phase matching range for Type 1 SHG, nm	570–4000
Acceptances for Type 1 SHG at 1064 nm	
Angular, mrad×cm	0.77
Spectral, cm <sup>-1</sup> ×cm	12.74
Walk-off for Type 1 SHG at 1064 nm, mrad	74.30
Nonlinear optical coefficient d <sub>15</sub> , pm/V	2.2 (at 1064 nm)
Effective nonlinearity	d <sub>00e</sub> = d <sub>15</sub> sinθ
Damage threshold, MW/cm <sup>2</sup>	> 100 for TEM <sub>00</sub> , 1064 nm, 10 ns, 10 Hz
Wavelength dispersion of refractive indices (λ – in μm)	
	$n_o^2 = 2.083648 + \frac{1.332068 \lambda^2}{\lambda^2 - 0.035306} - 0.008525 \lambda^2$
	$n_e^2 = 1.673463 + \frac{1.245229 \lambda^2}{\lambda^2 - 0.028224} - 0.003641 \lambda^2$

**HOUSING ACCESSORIES**

Ring Holders for Nonlinear Crystals  
See page 2.25



Positioning Mount 840-0199 for Nonlinear Crystal Housing  
See page 2.26



NONLINEAR CRYSTALS

LASER CRYSTALS

TERAHERTZ CRYSTALS

RAMAN CRYSTALS

POSITIONERS & HOLDERS

CRYSTAL OVENS

**ZnGeP<sub>2</sub> • AgGaSe<sub>2</sub>  
AgGaS<sub>2</sub> • GaSe**

**INFRARED NONLINEAR CRYSTALS**

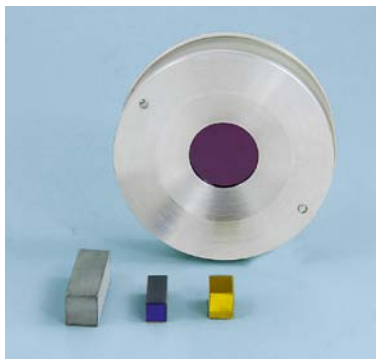

Optical nonlinear crystals **ZnGeP<sub>2</sub>**, **AgGaSe<sub>2</sub>**, **AgGaS<sub>2</sub>**, **GaSe** have gained tremendous interest for middle and deep infrared applications due to their unique features. The crystals have large effective optical nonlinearity, wide spectral and angular acceptances, broad transparency range, non-critical requirements for temperature stabilization and vibration control, are well mechanically processed (except GaSe).

**ZnGeP<sub>2</sub>**

ZnGeP<sub>2</sub> (ZGP) crystal has transmission band edges at 0.74 and 12 μm. However it's useful transmission range is from 1.9 to 8.6 μm and from 9.6 to 10.2 μm. ZGP crystal has the largest nonlinear optical coefficient and relatively high laser damage threshold. The crystal is successfully used in diverse applications:

- up-conversion of CO<sub>2</sub> and CO laser radiation to near IR range via harmonics generation and mixing processes;
- efficient SHG of pulsed CO, CO<sub>2</sub> and chemical DF-laser;
- efficient down conversion of Holmium, Thulium and Erbium and laser wavelengths to mid infrared wavelength ranges by OPO process.

Crystals with high damage threshold BBAR coatings and the lowest absorption coefficient  $\alpha < 0.05 \text{ cm}^{-1}$  at pump wavelengths 2.05 - 2.1 μm „o“- polarisation are available for OPO applications.

Typical absorption coefficient is  $< 0.03 \text{ cm}^{-1}$  at 2.5 - 8.2 μm range.

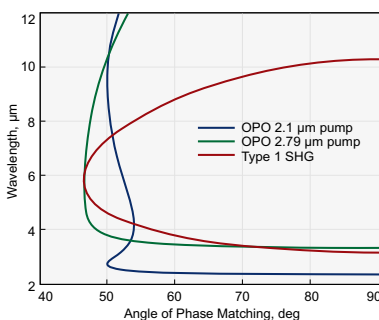

Type 1 OPO and SHG tuning curves in ZnGeP<sub>2</sub>

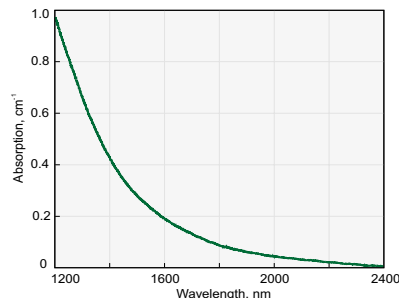

Absorption spectra of ZnGeP<sub>2</sub> crystal near 2 μm

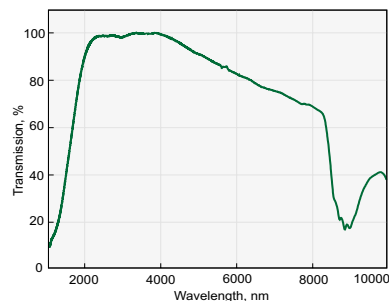

Transmission spectra of 15 mm long AR coated ZnGeP<sub>2</sub> crystal for OPO @ 2.1 μm

**TYPE 1 ZnGeP<sub>2</sub> CRYSTALS for OPO at 3.5-5 μm range pumped at ~2.1 μm**

Catalogue number	Size, mm	θ, deg	φ, deg	Coating	Application
ZGP-401	7×5×15	54	0	AR @ 2.1 μm + BBAR @ 3.5-5 μm	OPO@2.1 → 3.5-5 μm
ZGP-402	7×5×20	54	0	AR @ 2.1 μm + BBAR @ 3.5-5 μm	OPO@2.1 → 3.5-5 μm
ZGP-403	7×5×25	54	0	AR @ 2.1 μm + BBAR @ 3.5-5 μm	OPO@2.1 → 3.5-5 μm

**AgGaSe<sub>2</sub>**

AgGaSe<sub>2</sub> has band edges at 0.73 and 18 μm. Its useful transmission range of 0.9–16 μm and wide phase matching capability provide excellent potential for OPO applications when pumped by a variety of currently available lasers. Tuning from

2.5–12 μm has been obtained when pumping by Ho:YLF laser at 2.05 μm; as well as NCPM operation from 1.9–5.5 μm when pumping at 1.4–1.55 μm. Efficient SHG of pulsed CO<sub>2</sub> laser has been demonstrated.

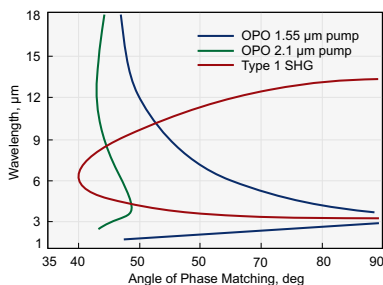

Type 1 OPO and SHG tuning curves in AgGaSe<sub>2</sub>

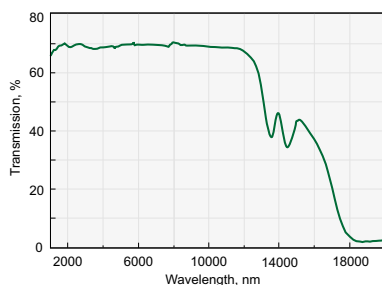

Transmission spectra of 18 mm long uncoated AgGaSe<sub>2</sub> crystal

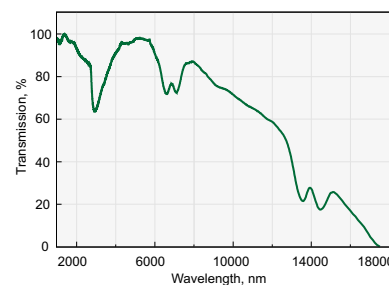

Transmission spectra of 25 mm long AR coated AgGaSe<sub>2</sub> crystal

## AgGaS<sub>2</sub>

AgGaS<sub>2</sub> is transparent from 0.53 to 12 μm. Although nonlinear optical coefficient is the lowest among the above mentioned infrared crystals, its high short wavelength transparency edging at 550 nm is used in OPOs pumped by Nd:YAG laser; in numerous difference frequency mixing experiments using diode, Ti:Sapphire, Nd:YAG and IR dye lasers covering 3–12 μm range; direct infrared counter-measure systems, and SHG of CO<sub>2</sub> laser.

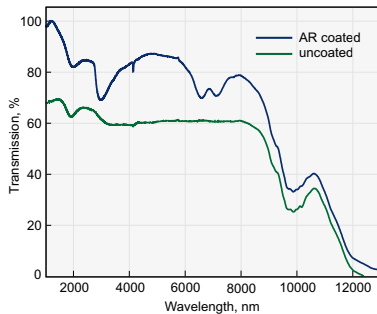

Transmission spectra of 14 mm long AR coated and uncoated AgGaS<sub>2</sub> crystal used for OPO pumped by Nd:YAG laser

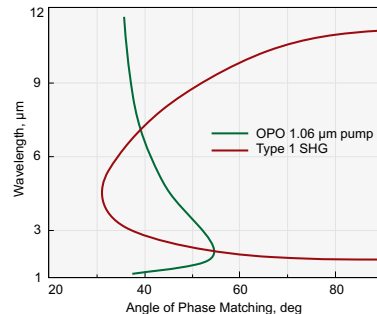

Type 1 OPO and SHG tuning curves in AgGaS<sub>2</sub>

### LIST OF STANDARD AgGaS<sub>2</sub> CRYSTALS

Code	Size, mm	θ, deg	φ, deg	Coating	Application	Price, EUR
AGS-401H	5×5×1	39	45	BBAR/BBAR @ 1.1-2.6 / 2.6-11 μm	DFG @ 1.2-2.4 μm → 2.4-11 μm	835
AGS-402H	6×6×2	50	0	BBAR/BBAR @ 1.1-2.6 / 2.6-11 μm	DFG @ 1.2-2.4 μm → 2.4-11 μm	1345
AGS-403H	5×5×0.4	34	45	BBAR/BBAR @ 3-6 / 1.5-3 μm	SHG @ 3-6 μm, Type 1	995
AGS-404H	5×5×0.4	39	45	BBAR/BBAR @ 1.1-2.6 / 2.6-11 μm	DFG @ 1.2-2.4 μm → 2.4-11 μm	995
AGS-801H	8×8×0.4	39	45	BBAR/BBAR @ 1.1-2.6 / 2.6-11 μm	DFG @ 1.2-2.4 μm, Type 1	2340
AGS-802H	8×8×1	39	45	BBAR/BBAR @ 1.1-2.6 / 2.6-11 μm	DFG @ 1.2-2.4 μm, Type 1	2140

Crystals are mounted into open ring holders (see page 2.25).

## GaSe

GaSe has band edges at 0.65 and 18 μm. GaSe has been successfully used for efficient SHG of CO<sub>2</sub> laser, for SHG of pulsed CO, CO<sub>2</sub> and chemical DF-laser (λ = 2.36 μm) radiation; up conversion of CO and CO<sub>2</sub> laser radiation into the visible range; infrared pulses generation via difference frequency mixing of Neodymium

and infrared dye laser or (F-)centre laser pulses; OPG light generation within 3.5–18 μm; efficient TeraHertz generation in 100–1600 μm range. It is impossible to cut crystals for certain phase matching angles because of material structure (cleave along (001) plane) limiting areas of applications.

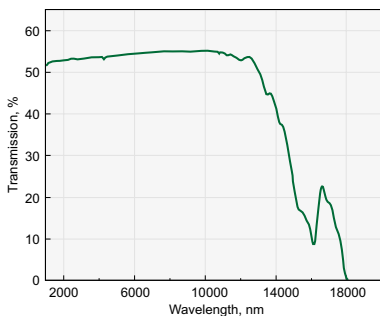

Transmission spectra of 17 mm long uncoated GaSe crystal

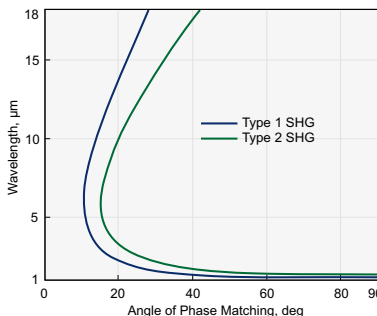

Type 1 and Type 2 SHG tuning curves in GaSe

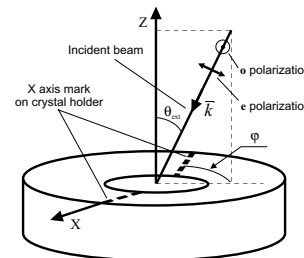

### RELATED PRODUCTS

Ring Holders for Nonlinear Crystals

See page 2.25



### GaSe, Z-CUT

Catalogue number	Clear aperture, mm	Thickness, μm	Holder, mm	Price, EUR
GaSe-10H1	Ø7	10	Ø25.4	1950
GaSe-30H1	Ø7	30	Ø25.4	1625
GaSe-100H1	Ø7	100	Ø25.4	1475
GaSe-500H1	Ø7	500	Ø25.4	1460
GaSe-1000H1	Ø7	1000	Ø25.4	1635
GaSe-2000H1	Ø7	2000	Ø25.4	1810

Please note that from now all standard GaSe crystals are provided mounted into Ø25.4 mm ring holders. Crystals could be mounted into Ø40 mm holders under your request.

**PHYSICAL PROPERTIES**

Crystal		ZnGeP <sub>2</sub>	AgGaSe <sub>2</sub>	AgGaS <sub>2</sub>	GaSe
Crystal Symmetry		Tetragonal	Tetragonal	Tetragonal	Hexagonal
Point Group		42m	42m	42m	62m
Lattice Constants, Å	a	5.465	5.9901	5.757	3.742
	c	10.771	10.8823	10.305	15.918
Density, g/cm <sup>3</sup>		4.175	5.71	4.56	5.03

**OPTICAL PROPERTIES**

Crystal		ZnGeP <sub>2</sub>	AgGaSe <sub>2</sub>	AgGaS <sub>2</sub>	GaSe
Optical transmission, μm		0.74–12	0.73–18	0.53–12	0.65–18
Indices of Refraction at					
1.06 μm	n <sub>o</sub>	3.2324	2.7005	2.4508	2.9082
	n <sub>e</sub>	3.2786	2.6759	2.3966	2.5676
5.3 μm	n <sub>o</sub>	3.1141	2.6140	2.3954	2.8340
	n <sub>e</sub>	3.1524	2.5823	2.3421	2.4599
10.6 μm	n <sub>o</sub>	3.0725	2.5915	2.3466	2.8158
	n <sub>e</sub>	3.1119	2.5585	2.2924	2.4392
Absorption Coefficient, cm <sup>-1</sup> at					
1.06 μm		3.0	<0.02	<0.09	0.25
2.5 μm		0.03	<0.01	0.01	0.05
5.0 μm		0.02	<0.01	0.01	0.05
7.5 μm		0.02	–	0.02	0.05
10.0 μm		0.4	–	<0.6	0.05
11.0 μm		0.8	–	0.6	0.05

**NONLINEAR OPTICAL PROPERTIES**

Crystal	ZnGeP <sub>2</sub>	AgGaSe <sub>2</sub>	AgGaS <sub>2</sub>	GaSe
Laser damage threshold, MW/cm <sup>2</sup>	60	25	10	28
at pulse duration, ns	100	50	20	150
at wavelength, μm	2.05	10.6	1.06	9.3
Nonlinearity, pm/V	111	43	31	63
Phase matching angle for Type 1 SHG at 10.6 μm, deg	76	55	67	14
Walk-off angle at 5.3 μm, deg	0.57	0.67	0.85	3.4

**THERMAL PROPERTIES**

Crystal		ZnGeP <sub>2</sub>	AgGaSe <sub>2</sub>	AgGaS <sub>2</sub>	GaSe
Melting point, °C		1298	851	998	1233
Thermal Expansion Coefficient, 10 <sup>-6</sup> /°K					
	⊥	17.5 <sup>(a)</sup>	23.4 <sup>(c)</sup>	12.5	9.0
	⊥	9.1 <sup>(b)</sup>	18.0 <sup>(d)</sup>		
		1.59 <sup>(a)</sup>	-6.4 <sup>(c)</sup>	-13.2	8.25
		8.08 <sup>(b)</sup>	-16.0 <sup>(d)</sup>		

a) at 293–573 K, b) at 573–873 K, c) at 298–423 K, d) at 423–873 K

**SELLMEIER EQUATIONS FOR CALCULATION OF INDICES OF REFRACTION**

Crystal		A	B	C	D	E	F	Expression
ZnGeP <sub>2</sub>	n <sub>o</sub>	8.0409	1.68625	0.40824	1.2880	611.05	–	n <sup>2</sup> = A + Bλ <sup>2</sup> / (λ <sup>2</sup> - C) + Dλ <sup>2</sup> / (λ <sup>2</sup> - E)
	n <sub>e</sub>	8.0929	1.8649	0.41468	0.84052	452.05	–	
AgGaSe <sub>2</sub>	n <sub>o</sub>	6.8507	0.4297	0.15840	0.00125	–	–	n <sup>2</sup> = A + B / (λ <sup>2</sup> - C) - Dλ <sup>2</sup>
	n <sub>e</sub>	6.6792	0.4598	0.21220	0.00126	–	–	
AgGaS <sub>2</sub>	n <sub>o</sub>	3.3970	2.3982	0.09311	2.1640	950.0	–	n <sup>2</sup> = A + B / (1 - C / λ <sup>2</sup> ) + D / (1 - E / λ <sup>2</sup> )
	n <sub>e</sub>	3.5873	1.9533	0.11066	2.3391	1030.7	–	
GaSe	n <sub>o</sub>	7.443	0.405	0.0186	0.0061	3.1485	2194	n <sup>2</sup> = A + B/λ <sup>2</sup> + C/λ <sup>4</sup> + D/λ <sup>6</sup> + E/(1 - F/λ <sup>2</sup> )
	n <sub>e</sub>	5.76	0.3879	-0.2288	0.1223	1.855	1780	

**BBO · LBO · KDP**  
**LiIO<sub>3</sub> · AgGaS<sub>2</sub> · GaSe**

**ULTRATHIN NONLINEAR CRYSTALS**



Thin crystals are used in different applications with femtosecond pulses:

- Harmonic generation (SHG, SFG)
- Optical parametric generation and amplification (OPG, OPA)
- Difference frequency generation (DFG)
- Pulse width measurements by auto and cross correlation
- THz frequency generation (in GaSe crystal)

The propagation of an ultrashort optical pulse through the crystal results in a delay of the pulses because of Group Velocities Mismatch (GVM), a duration broadening because of Group Delay Dispersion (GDD) and a frequency chirp.

Unfortunately these effects force to limit nonlinear crystal thickness in frequency generation schemes.

For two collinearly propagating pulses with different group velocities their quasistatic interaction length ( $L_{qs}$ ) is defined as distance over which they separate by a path equal to the one of the pulses duration (or to the desired pulse duration):

$$L_{qs} = \tau / \text{GVM} ;$$

where GVM is the group velocity mismatch and  $\tau$  is the duration of the pulse. GVM calculations are presented for the most popular Type 1 phase matching applications for different crystals in Table 2.

Optimal BBO, LBO, KDP and LiIO<sub>3</sub> crystal thicknesses which are limited by GVM for Type 1 SHG of 800 nm at different fundamental pulse duration are presented in the Table 3. Also effective coefficients and phase matching angles at room temperature (20 °C) are calculated. If longer crystal will be used this will cause second harmonic pulse broadening to the duration longer than fundamental pulse duration (or desired pulse duration).

Group delay dispersion (GDD) has an important impact on the propagation of pulses, because a pulse always has certain spectral width, so that dispersion will cause its frequency components to propagate with different velocities. In case of crystals where we have normal dispersion when refractive index decreases with increasing wavelength this leads to a lower group velocity of higher-frequency components, and thus to a positive chirp.

The frequency dependence of the group velocity also has an influence on the pulse duration. If the pulse is initially unchirped, dispersion in a crystal will always increase its duration. This is called dispersive pulse broadening. For an originally unchirped Gaussian pulse with the duration  $\tau_0$ , the pulse duration is increased according to:

$$t = \tau_0 \sqrt{1 + \left( \frac{4 \ln 2 \cdot D \cdot L}{\tau_0^2} \right)^2}$$

$L$  – thickness of the crystal in mm.  $D$  – second order group delay dispersion or dispersion parameter. Table 1 gives  $D$  parameter for Type 1 phase matching SHG @ 800 nm for 800 nm pulse with „o“ polarization and 400 nm pulse with „e“ polarization in different crystals.

**Table 1. D parameter for Type 1 SHG @ 800 nm orientation crystals for 800 nm (o-pol) and 400 nm (e-pol) pulses**

Crystal	D at 800 nm	D at 400 nm
BBO	75 fsec <sup>2</sup> /mm	196 fsec <sup>2</sup> /mm
LBO	47 fsec <sup>2</sup> /mm	128 fsec <sup>2</sup> /mm
KDP	27 fsec <sup>2</sup> /mm	107 fsec <sup>2</sup> /mm
LiIO <sub>3</sub>	196 fsec <sup>2</sup> /mm	589 fsec <sup>2</sup> /mm

We may calculate that spectrum limited initial 30 fsec Gaussian pulse at 400 nm will be broadened to 35 fsec pulse after passing 1 mm thickness BBO crystal.

**Table 2. Group velocity mismatch between shortest and longest wave pulse for Type 1 phase matching**

Crystal	SFM 800+266 nm	SFM 800+400 nm	SHG 800 nm	SHG 1030 nm	SHG 1064 nm	DFG 1.26-2.18 → 3 μm	DFG 1.48-1.74 → 10 μm
BBO	2074 fs/mm	737 fs/mm	194 fs/mm	94 fs/mm	85 fs/mm	–	–
LBO	–	448 fs/mm	123 fs/mm	51 fs/mm	44 fs/mm	–	–
KDP	–	370 fs/mm	77 fs/mm	1 fs/mm	-7 fs/mm	–	–
LiIO <sub>3</sub>	–	–	559 fs/mm	285 fs/mm	262 fs/mm	–	–
AgGaS <sub>2</sub>	–	–	–	–	–	170 fs/mm	-10 fs/mm

**Table 3. Quasistatic interaction length for Type 1 SHG of 800 nm**

Crystal	200 fs	100 fs	50 fs	20 fs	10 fs	Cut angles θ, φ	Coefficient deff
BBO	1.0 mm	0.5 mm	0.26 mm	0.1 mm	0.05 mm	29.2°, 90°	2.00 pm/V
LBO	1.6 mm	0.8 mm	0.4 mm	0.16 mm	0.08 mm	90°, 31.7°	0.75 pm/V
KDP	2.6 mm	1.3 mm	0.6 mm	0.26 mm	0.13 mm	44.9°, 45°	0.30 pm/V
LiIO <sub>3</sub>	0.4 mm	0.18 mm	0.01 mm	0.04 mm	0.018 mm	42.5°, 0°	3.59 pm/V

NONLINEAR CRYSTALS

LASER CRYSTALS

TERAHERTZ CRYSTALS

RAMAN CRYSTALS

POSITIONERS & HOLDERS

CRYSTAL OVENS



### Free standing crystals

The crystals of thickness down to 100 µm can be supplied as free standing crystals not attached to the support. However the ring mounts are highly recommended for safe handling of these thin crystals. The tolerance is

±50 µm for crystals of thickness down to 300 µm and ±20 µm for crystals of thickness down to 100 µm.

GaSe crystal is supplied glued in to dia Ø40 mm ring holder only.

Crystal	Minimal aperture	Maximal aperture	Minimal thickness
BBO	5×5 mm	20×20 mm	0.1 mm
LBO	5×5 mm	30×30 mm	0.1 mm
KDP	4×4 mm	100×100 mm	0.1 mm*
LiIO <sub>3</sub>	4×4 mm	50×50 mm	0.1 mm*
AgGaS <sub>2</sub>	5×5 mm	15×15 mm	0.1 mm
GaSe	Ø5 mm	Ø7 mm	0.01 mm

\* the thickness should be about 0.5 mm for max aperture KDP and LiIO<sub>3</sub>

### Optically contacted crystals

BBO crystals of thickness less than 100 µm can be supplied optically contacted on UV Fused Silica substrates sizes 10×10×2 mm

or 12×12×2 mm. Other sizes of substrates are also available on request. The tolerances of BBO crystal thickness is +10/-5 µm.

Crystal	Minimal aperture	Maximal aperture	Minimal thickness
BBO	5×5 mm	10×10 mm	10±5 µm

EKSMA OPTICS provides various AR, BBAR and protective coatings for all free standing crystals and optically contacted crystals.

Ring mounts made from anodized aluminium and teflon are available for safe and convenient handling of ultrathin crystals.

### STANDARD SPECIFICATIONS OF CRYSTALS

Crystals	BBO, LBO	KDP, LiIO <sub>3</sub> , AgGaS <sub>2</sub>	GaSe
Flatness	λ/6 at 633 nm	λ/4 at 633 nm	cleaved
Parallelism	< 10 arcsec	< 30 arcsec	perpendicularly to optical axis.
Angle tolerance	< 15 arcmin	< 30 arcmin	Polish is not available
Surface quality	10/5 scratch/dig	20/10 scratch/dig	

### RELATED PRODUCTS

Other Ultrathin BBO crystals available. See pages 5.31; 5.38

Ring Holders for Nonlinear Crystals

See page 2.25



Positioning Mount 840-0199 for Nonlinear Crystal Housing

See page 2.26



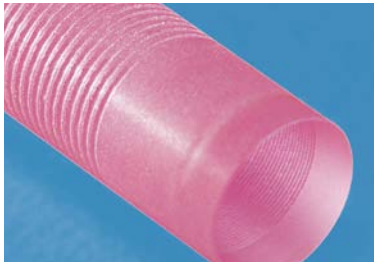

# Laser Crystals

NONLINEAR CRYSTALS

LASER CRYSTALS

TERAHERTZ CRYSTALS

RAMAN CRYSTALS

POSITIONERS & HOLDERS

CRYSTAL OVENS

## Nd:YAG NEODYMIUM DOPED YTTRIUM ALUMINIUM GARNET



Nd:YAG crystal is the most popular lasing media for solid-state lasers. EK SMA OPTICS offers standard specifications high optical quality Nd:YAG rods with high damage threshold AR @ 1064 nm coatings.

Please contact EK SMA OPTICS for further information or non-standard specifications.

### PROPERTIES OF 1.0% Nd:YAG AT 25°C

Formula	$Y_{2.97}Nd_{0.03}Al_5O_{12}$
Crystal structure	Cubic
Density	4.55 g/cm <sup>3</sup>
Melting point	1970 °C
Mohs hardness	8.5
Transition	$^4F_{3/2} \rightarrow ^4I_{11/2}$ @ 1064 nm
Fluorescence lifetime	230 μs for 1064 nm
Thermal conductivity	0.14 Wcm <sup>-1</sup> K <sup>-1</sup>
Specific heat	0.59 Jg <sup>-1</sup> K <sup>-1</sup>
Thermal expansion	$6.9 \times 10^{-6}$ °C <sup>-1</sup>
dn/dt	$7.3 \times 10^{-6}$ °C <sup>-1</sup>
Young's modulus	$3.17 \times 10^4$ Kg/mm <sup>2</sup>
Poisson ratio	0.25
Thermal shock resistance	790 Wm <sup>-1</sup>
Refractive index	1.818 @ 1064 nm

### STANDARD RODS SIZES

Code	Diameter, mm	Length, mm	Doping, %	Wedge of the ends, deg	Price, EUR
E-Y-3-0.9-A/A	3	53	0.9	0/0	215
E-Y-3-0.8-A/A	3	65	0.8	0/0	265
E-Y-3-1.1-A/A	3	65	1.1	0/0	325
E-Y-4-0.8-A/A	4	65	0.8	3/3 parallel	530
E-Y-4-1.1-A/A	4	65	1.1	3/3 parallel	530
E-Y-6.35-1.1-A/A	6.35	85*	1.1	3/3 parallel	890
E-Y-8-1.1-A/A	8	85*	1.1	3/3 parallel	1340
E-Y-10-1.1-A/A	10	85*	1.1	3/3 parallel	2200
E-Y-12-0.8-A/A	12	100*	0.8	3/3 parallel	4740
E-Y-12-1.1-A/A	12	100*	1.1	3/3 parallel	4740

\* rods with barrel grooving, except 10 mm at both ends of the rod without grooving.

### RELATED PRODUCTS

Laser Safety Eyewear  
See page 1.17



Visualizator 990-0840  
See page 1.17

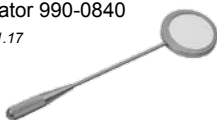

### SPECIFICATIONS OF STANDARD Nd:YAG LASER RODS

Nd Doping Level	0.8% or 1.1%
Orientation	<111> crystalline direction
Surface Quality	10-5 scratch & dig (MIL-PRF-13830B)
Surface Flatness	λ/10 at 633 nm
Parallelism	< 10 arcsec
Perpendicularity	< 5 arcmin for plano/plano ends
Diameter Tolerance	+0/-0.05 mm
Length Tolerance	+1/-0.5 mm
Clear Aperture	> 90 % of full aperture
Chamfers	0.1 mm at 45 deg
Coating	both sides coated AR @ 1064 nm, R < 0.2%, AOI = 0 deg
Barrel grooving	all dia 6.35, 8, 10, 12 mm rods with barrel grooving

Yb:KGW • Yb:KYW

Yb-DOPED POTASSIUM GADOLINIUM TUNGSTATE



- High absorption coefficient @ 981 nm
- High stimulated emission cross section
- Low laser threshold
- Extremely low quantum defect  $\lambda_{pump}/\lambda_{se}$
- Broad polarized output at 1023–1060 nm
- High slope efficiency with diode pumping (~ 60%)
- High Yb doping concentration

APPLICATIONS

- Yb:KGW and Yb:KYW thin (100–150  $\mu\text{m}$ ) crystals are used as lasing materials to generate ultrashort (hundreds of fsec) high power (>22 W) pulses. Standard pumping @ 981 nm, output: 1023–1060 nm
- Yb:KGW and Yb:KYW can be used as ultrashort pulses amplifiers
- Yb:KGW and Yb:KYW are some of the best materials for high power thin disk lasers

CUSTOM MANUFACTURING CAPABILITIES

- Various shapes (slabs, rods, cubes)
- Different dopant levels
- Diversified coatings

Yb-Doped Potassium Gadolinium Tungstate (**Yb:KGd(WO<sub>4</sub>)<sub>2</sub>**) and Yb-doped Potassium Itrium Tungstate (**Yb:KY(WO<sub>4</sub>)<sub>2</sub>**) single crystals are the laser crystals for diode or laser pumped solid-state laser applications.

PROPERTIES OF Yb:KGW AND Yb:KYW

Name	Yb:KGW	Yb:KYW
Yb <sup>3+</sup> concentration	0.5–5%	0.5–100%
Crystal structure	monoclinic	monoclinic
Point group	C2/c	C2/c
Lattice parameters	a=8.095 Å, b=10.43 Å, c=7.588 Å, $\beta=94.43^\circ$	a=8.05 Å, b=10.35 Å, c=7.54 Å, $\beta=94^\circ$
Thermal expansion	$\alpha_a=4 \times 10^{-6} / ^\circ\text{C}$ , $\alpha_b=3.6 \times 10^{-6} / ^\circ\text{C}$ , $\alpha_c=8.5 \times 10^{-6} / ^\circ\text{C}$	—
Thermal conductivity	$K_a=2.6 \text{ W/mK}$ , $K_b=3.8 \text{ W/mK}$ , $K_c=3.4 \text{ W/mK}$	—
Density	7.27 g/cm <sup>3</sup>	6.61 g/cm <sup>3</sup>
Mohs' hardness	4–5	4–5
Melting temperature	1075 °C	—
Transmission range	0.35–5.5 $\mu\text{m}$	0.35–5.5 $\mu\text{m}$
Refractive indices ( $\lambda=1.06 \mu\text{m}$ )	$n_y=2.037$ , $n_p=1.986$ , $n_m=2.033$	—
Thermo-optic coefficients @ 1064 nm	$\partial n_p / \partial T = -15.7 \times 10^{-6} \text{ K}^{-1}$ $\partial n_m / \partial T = -11.8 \times 10^{-6} \text{ K}^{-1}$ $\partial n_y / \partial T = -17.3 \times 10^{-6} \text{ K}^{-1}$	For 20% Yb:KYW $\partial n_p / \partial T = -13.08 \times 10^{-6} \text{ K}^{-1}$ $\partial n_m / \partial T = -7.61 \times 10^{-6} \text{ K}^{-1}$ $\partial n_y / \partial T = -11.83 \times 10^{-6} \text{ K}^{-1}$
Laser wavelength	1023–1060 nm	1025–1058 nm
Fluorescence lifetime	0.3 ms	0.3 ms
Stimulated emission cross section ( $E \parallel a$ )	$2.6 \times 10^{-20} \text{ cm}^2$	$3 \times 10^{-20} \text{ cm}^2$
Absorption peak and bandwidth	$\alpha_a=26 \text{ cm}^{-1}$ , $\lambda=981 \text{ nm}$ , $\Delta\lambda=3.7 \text{ nm}$	$\alpha_a=40 \text{ cm}^{-1}$ , $\lambda=981 \text{ nm}$ , $\Delta\lambda=3.5 \text{ nm}$
Absorption cross section	$1.2 \times 10^{-19} \text{ cm}^2$	$1.33 \times 10^{-19} \text{ cm}^2$
Lasing threshold	35 mW	70 mW
Stark levels energy (in cm <sup>-1</sup> ) of the <sup>2</sup> F <sub>5/2</sub> manifolds of Yb <sup>3+</sup> @ 77K	10682, 10471, 10188	10695, 10476, 10187
Stark levels energy (in cm <sup>-1</sup> ) of the <sup>2</sup> F <sub>7/2</sub> manifolds of Yb <sup>3+</sup> @ 77K	535, 385, 163, 0	568, 407, 169, 0

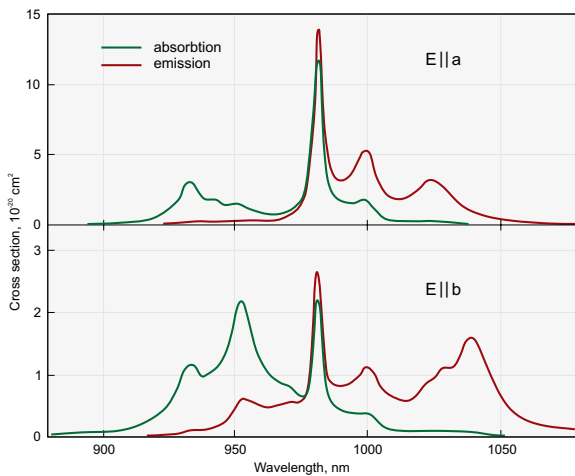

Absorption and emission spectra of Yb(5%):KYW

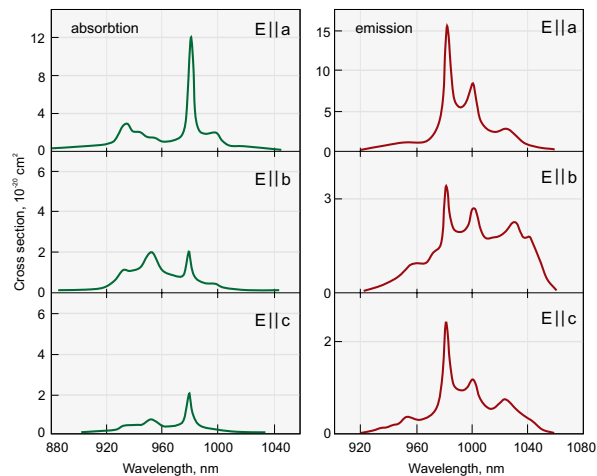

Absorption and emission spectrae of Yb(5%):KGW

**Nd:KGW Nd-DOPED POTASSIUM GADOLINIUM TUNGSTATE**

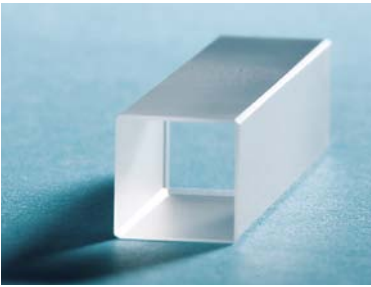

The efficiency of Nd:KGW lasers is 3–5 times higher than the one of Nd:YAG lasers. Nd:KGW laser medium is one of the best choices ensuring effective laser generation at low pump energies (0.5 – 1 J). These crystals supplied by EK SMA OPTICS feature high optical quality and great value of bulk resistans for laser radiation.

**Nd:KGW** crystals are low lasing threshold, highly efficient laser material exceptionally suitable for laser rangefinding applications.

**STANDARD SPECIFICATIONS**

Orientation	[010] ±30 min
Dopant concentration	2-10 at %
Diameter tolerance	+0.0/-0.1 mm
Length tolerance	+1.0/-0.0 mm
Chamfer	45(±10) deg × 0.2(±0.1) mm
Flatness	λ/10 @ 633 nm
Parallelism	better than 30 arcsec
Perpendicularity	better than 15 arcmin
Surface Quality	10-5 scratch & dig (MIL-PRF-13830B)
Absorption losses	< 0.005 cm <sup>-1</sup>

**PHYSICAL AND LASER PROPERTIES**

Chemical formula	KGd(WO <sub>4</sub> ):Nd
Lattice constants	a = 8.095 Å, b = 10 Å, c = 7.588 Å
Optical orientation	n <sub>g</sub> = b, n <sub>p</sub> c = 20 deg
Angle between optical axis	86.5 angular grad
Density	7.27 g/cm <sup>3</sup>
Mohs hardness	5
Thermal conductivity	2.8 W/(m×grad) [100] 2.2 W/(m×grad) [010] 3.5 W/(m×grad) [001]
Thermal expansion	4×10 <sup>-6</sup> grad <sup>-1</sup> [100] 3.6×10 <sup>-6</sup> grad <sup>-1</sup> [010] 8.5×10 <sup>-6</sup> grad <sup>-1</sup> [001]
Phase transition	1005 °C
Melting point	1075 °C
Transmission range	0.35–5.5 μm
Refractive index	n <sub>g</sub> = 2.033 @ 1.067 μm n <sub>p</sub> = 1.937 @ 1.067 μm n <sub>m</sub> = 1.986 @ 1.067 μm
Transition	<sup>4</sup> F <sub>3/2</sub> → <sup>4</sup> I <sub>11/2</sub>
Laser wavelength	1.0672 μm
Fluorescence lifetime	120 μs
Fluorescent width	24 cm <sup>-1</sup>
Emission cross-section	4.3×10 <sup>-19</sup> cm <sup>-2</sup>
Emission temperature drift	8.5×10 <sup>-4</sup> nm, K <sup>-1</sup>

**Ti:Sapphire TITANIUM DOPED SAPPHIRE**



Al<sub>2</sub>O<sub>3</sub>:Ti<sup>3+</sup> indefinitely long stability and useful lifetime added to the lasing over entire band of 660–1050 nm challenge “dirty” dyes in variety of applications. Medical laser systems, lidars, laser spectroscopy, direct femtosecond pulse generation by Kerr-type mode-locking – there are few of existing and potential applications.

The absorption band of Ti:Sapphire centered at 490 nm makes it suitable for variety of laser pump sources – argon ion, frequency doubled Nd:YAG and YLF, copper vapour lasers. Because of 3.2 μs fluorescence lifetime Ti:Sapphire crystals can be effectively pumped by short pulse flashlamps in powerful laser systems.

**Al<sub>2</sub>O<sub>3</sub>:Ti<sup>3+</sup>** – titanium-doped sapphire crystals combine outstanding physical and optical properties with broadest lasing range.

Ti <sub>2</sub> O <sub>3</sub> wt %	a, cm <sup>-1</sup> @ 490 nm	a, cm <sup>-1</sup> @ 514 nm	a, cm <sup>-1</sup> @ 532 nm
0.03	0.7*	0.6	0.5
0.05	1.1	0.9	0.8
0.07	1.5	1.3	1.2
0.10	2.2	1.9	1.7
0.12	2.6	2.2	2.0
0.15	3.3	2.8	2.5
0.20	4.3	3.7	3.4
0.25	5.4	4.6	4.1

\* Presented values are given with ±0.05 cm<sup>-1</sup> accuracy.

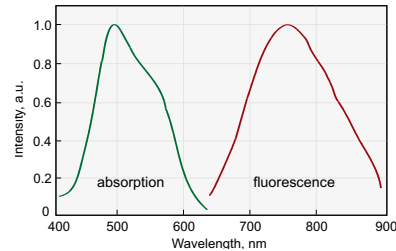

**STANDARD SPECIFICATIONS**

Orientation	optical axis C normal to rod axis
Ti <sub>2</sub> O <sub>3</sub> concentration	0.03–0.25 wt %
Figure Of Merit	> 150 (> 300 available on special requests)
Size	up to 15 mm dia and up to 30 mm length
End configurations	flat/flat or Brewster/Brewster ends
Flatness	λ/10 @ 633 nm
Parallelism	10 arcsec
Surface Quality	10-5 scratch & dig (MIL-PRF-13830B)
Wavefront distortion	λ/4 inch

**PHYSICAL AND LASER PROPERTIES**

Chemical formula	Ti <sup>3+</sup> :Al <sub>2</sub> O <sub>3</sub>
Crystal structure	Hexagonal
Lattice constants	a=4.748, c=12.957
Density	3.98 g/cm <sup>3</sup>
Mohs hardness	9
Thermal conductivity	0.11 cal/(°C×sec×cm)
Specific heat	0.10 cal/g
Melting point	2050 °C
Laser action	4-Level Vibronic
Fluorescence lifetime	3.2 μsec (T=300K)
Tuning range	660–1050 nm
Absorbtion range	400–600 nm
Emission peak	795 nm
Absorption peak	488 nm
Refractive index	1.76 @ 800 nm

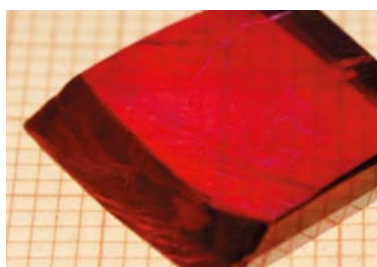

# Terahertz Crystals

## GaSe • ZnTe

## SEMICONDUCTOR TERAHERTZ CRYSTALS

### ZnTe

ZnTe (Zinc Telluride) crystals with <110> orientation are used for THz generation by optical rectification process. Optical rectification is a difference frequency generation in media with large second order susceptibility. For femtosecond laser pulses which have large bandwidth the frequency components interact with each other and their difference produce bandwidth from 0 to several THz.

Detection of the THz pulse occurs via free-space electro-optic detection in another <110> oriented ZnTe crystal. The THz

pulse and the visible pulse are propagated collinearly through the ZnTe crystal. The THz pulse induces a birefringence in ZnTe crystal which is read out by a linearly polarized visible pulse. When both the visible pulse and the THz pulse are in the crystal at the same time, the visible polarization will be rotated by the THz pulse. Using a  $\lambda/4$  waveplate and a beamsplitting polarizer together with a set of balanced photodiodes, it is possible to map THz pulse amplitude by monitoring the visible pulse polarization rotation after the ZnTe crystal

at a variety of delay times with respect to the THz pulse. The ability to read out the full electric field, both amplitude and delay, is one of the attractive features of time-domain THz spectroscopy.

ZnTe are also used for IR optical components substrates and vacuum deposition. NOTE: ZnTe crystal contains micro bubbles and they are visible in projection of illuminated crystal. However this does not affect the THz generation. We do not accept complains on presence of bubbles in crystal.



### ZnTe, <110> CUT

Catalogue number	Size, mm	Thickness, mm	Holder, mm	Price, EUR
ZnTe-100H	10×10	0.1	Ø25.4	890
ZnTe-200H	10×10	0.2	Ø25.4	730
ZnTe-500H	10×10	0.5	Ø25.4	620
ZnTe-1000H	10×10	1.0	Ø25.4	510
ZnTe-2000H	10×10	2.0	Ø25.4	750

### GaSe

GaSe (Gallium Selenide) crystals used for THz generation shows a large bandwidth of up to 41 THz. GaSe is a negative uniaxial layered semiconductor with a hexagonal structure of 62 m point group and a direct bandgap of 2.2 eV at 300 K. GaSe crystal features high damage threshold, large nonlinear optical coefficient (54 pm/V), suitable transparent

range, and low absorption coefficient, which make it an alternative solution for broadband mid infrared electromagnetic waves generation. Due to broadband THz generation and detection using a sub-20 fs laser source, GaSe emitter-detector system performance is considered to achieve comparable or even better results than using thin ZnTe crystals. In order to achieve

frequency selective THz wave generation and detection system, GaSe crystals of appropriate thickness should be used.

NOTE: because of material structure it is possible to cleave GaSe crystal along (001) plane only. Another disadvantage is softness and fragility of GaSe.



GaSe crystal mounted in Ø25.4 mm holder

### GaSe, Z-CUT

Catalogue number	Clear aperture, mm	Thickness, µm	Holder, mm	Price, EUR
GaSe-10H1	Ø7	10	Ø25.4	1950
GaSe-30H1	Ø7	30	Ø25.4	1625
GaSe-100H1	Ø7	100	Ø25.4	1475
GaSe-500H1	Ø7	500	Ø25.4	1460
GaSe-1000H1	Ø7	1000	Ø25.4	1635
GaSe-2000H1	Ø7	2000	Ø25.4	1810

Please note that from now all standard GaSe crystals are provided mounted into Ø25.4 mm ring holders. Crystals could be mounted into Ø40 mm holders under your request.

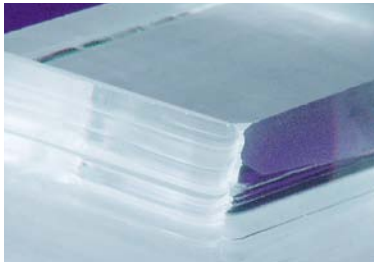

# Raman Crystals

## KGW • Ba(NO<sub>3</sub>)<sub>2</sub>

## CRYSTALS FOR STIMULATED RAMAN SCATTERING

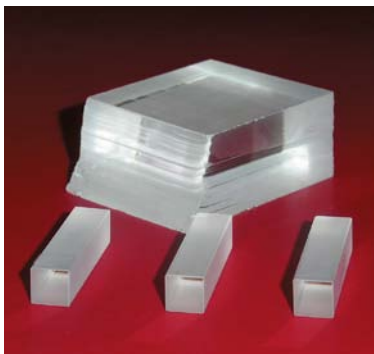

EKSMA OPTICS offers crystalline materials – **Barium Nitrate – Ba(NO<sub>3</sub>)<sub>2</sub>** and **undoped potassium gadolinium tungstate KGd(WO<sub>4</sub>)<sub>2</sub>** or KGW which have attracted much interest for stimulated Raman scattering (SRS). These materials can be used for frequency conversion in lasers for extending the tuning range. SRS in crystals is compatible with current all-solid-state technology and provides a very simple, compact means of frequency conversion.

Ba(NO<sub>3</sub>)<sub>2</sub> has a highest Raman gain coef-

ficient. The gain coefficient affects the threshold for Raman laser. However, the thermal lensing is particularly strong in this material. This is indicated by the large value  $\partial n/\partial T$  and low thermal conductivity. Thermal effects are significantly smaller in KGW. This along with the high damage threshold make the crystal an excellent candidate for power scaling. Comparing Ba(NO<sub>3</sub>)<sub>2</sub> and KGW for Raman application Ba(NO<sub>3</sub>)<sub>2</sub> is more optimal in case of ns and longer pulses, KGW – in case of shorter pulses.

### Ba(NO<sub>3</sub>)<sub>2</sub> PHYSICAL AND OPTICAL PROPERTIES

Crystal symmetry	cubic, P2 <sub>1</sub> 3
Transmission range	0.35–1.8 μm
Density	3.25 g/cm <sup>3</sup>
Hardness Mohs	2.5–3
Refractive indices @ 1064 nm	n = 1.555
Raman shift	1048 cm <sup>-1</sup>
Raman gain, pump 1064 nm	11 cm/GW
Thermal conductivity, W/mK	1.17
$\partial n/\partial T$	-20 × 10 <sup>-6</sup> K <sup>-1</sup>
Optical Damage Threshold	~ 0.4 GW/cm <sup>2</sup>

Raman wavelengths in KGW crystal (oscillation coefficient 901.5 cm<sup>-1</sup>) and Ba(NO<sub>3</sub>)<sub>2</sub> crystal (oscillation coefficient 1048.6 cm<sup>-1</sup>) are given in the table below.

Stokes	KGW pumped @ 532 nm	KGW pumped @ 1064 nm	Ba(NO <sub>3</sub> ) <sub>2</sub> pumped @ 532 nm	Ba(NO <sub>3</sub> ) <sub>2</sub> pumped @ 1064 nm	Typical efficiency, %
1 Stoke	558	1177	563	1197	35–70
2 Stoke	588	1316	598	1369	20–40
3 Stoke	621	1494	638	1599	10–15
4 Stoke	658	1726	684	1924	<10
1 Antistoke	507	970	503	957	10–30

### STANDARD KGW CRYSTALS, undoped, b-cut

Catalogue number	Dimensions, mm	Coating	Price, EUR
KGW-701	7 × 7 × 30	Uncoated	600
KGW-702	5 × 7.5 × 30	BBAR/BBAR@400-700 nm	785

### KGW PHYSICAL AND OPTICAL PROPERTIES

Crystal symmetry	monoclinic, C2/c
Transmission range	0.35–5.5 μm
Density	7.27 g/cm <sup>3</sup>
Hardness Mohs	4-5
Refractive indices @ 1064 nm	n <sub>o</sub> = 2.061; n <sub>m</sub> = 2.010; n <sub>p</sub> = 1.982
Raman shift	901 cm <sup>-1</sup> (p[mm]p) 768 cm <sup>-1</sup> (p[gg]p)
Raman gain, pump 1064 nm	3.3 cm/GW (901 cm <sup>-1</sup> ) 4.4 cm/GW (768 cm <sup>-1</sup> )
Thermal conductivity, W/mK	K <sub>a</sub> =2.6; K <sub>b</sub> =3.8; K <sub>c</sub> =3.4
$\partial n/\partial T$	0.4 × 10 <sup>-6</sup> K <sup>-1</sup>
Optical Damage Threshold	> 10 GW/cm <sup>2</sup>

### STANDARD SPECIFICATIONS

	Ba(NO <sub>3</sub> ) <sub>2</sub>	KGW
Surface Quality, scratch & dig (MIL-PRF-13830B)	40-20	10-5
Flatness @ 633 nm	λ/4	λ/8
Maximal element dimensions, mm	10×10×100	10×10×80

## Barium & Strontium tungstate-molybdate

## CRYSTALS FOR RAMAN SHIFT



- $Ba(MoO_4)_x(WO_4)_{1-x}$ ,  $0 < x < 0.01$
- $Sr(MoO_4)_x(WO_4)_{1-x}$ ,  $0 < x < 0.01$
- $Sr(MoO_4)_x(WO_4)_{1-x}$ ,  $0.99 < x < 1$

New Barium and Strontium tungstate-molybdate single crystals feature higher Raman gain as compared to KGW or  $CaCO_3$  and relatively higher thermal conductivity as compared to a  $Ba(NO_2)_3$ .

Barium and Strontium tungstate-molybdate single crystals are grown and provided with cut along a-direction.

Active elements do not require precise positioning since stimulated Raman scattering (SRS) threshold slightly depends on the crystal orientation relative to pump polarization (within a few percent) and minimum threshold is reached at  $E||c$ . In this case, the polarization of the pump and Stokes pulses are parallel to the optical axis (c-axis).

The crystals are water-insoluble and durable. Available sizes and shapes of active elements are rectangular up to  $10 \times 10 \times 100$  mm or with cylindrical cross-section up to  $\varnothing 10 \times 100$  mm.

### APPLICATIONS

- Raman converters – new crystals extend the capabilities of the Raman devices in addition to commercially available  $Ba(NO_2)_3$ ,  $CaCO_3$ , KGW crystals, since new crystals have different values of the Stokes shift and allow to obtain a laser radiation at the other wavelengths
- Raman lasers including self-Raman generation
- Laser pulse compressors based on stimulated Raman scattering effect

### RAMAN WAVELENGTHS GENERATION IN BARIUM TUNGSTATE, STRONTIUM TUNGSTATE AND STRONTIUM MOLYBDATE SINGLE CRYSTALS

Crystal	Barium tungstate		Strontium tungstate		Strontium molybdate	
Chemical formula	$Ba(MoO_4)_x(WO_4)_{1-x}$ $0 < x < 0.01$		$Sr(MoO_4)_x(WO_4)_{1-x}$ $0 < x < 0.01$		$Sr(MoO_4)_x(WO_4)_{1-x}$ $0.99 < x < 1$	
Oscillation coefficient	925 $cm^{-1}$		921.5 $cm^{-1}$		888 $cm^{-1}$	
Pump	1064 nm	532 nm	1064 nm	532 nm	1064 nm	532 nm
1 Stoke	1180	560	1180	559	1175	558
2 Stoke	1325	590	1324	590	1312	588
3 Stoke	1510	624	1507	624	1485	620
4 Stoke	1755	662	1751	662	1710	656
1 Antistoke	969	507	969	507	972	508

### PHYSICAL AND OPTICAL PROPERTIES

Crystal	Barium tungstate	Strontium tungstate	Strontium molybdate
Chemical formula	$Ba(MoO_4)_x(WO_4)_{1-x}$ $0 < x < 0.01$	$Sr(MoO_4)_x(WO_4)_{1-x}$ $0 < x < 0.01$	$Sr(MoO_4)_x(WO_4)_{1-x}$ $0.99 < x < 1$
Crystal structure	Tetragonal, space group $I4_1/a$	Tetragonal, space group $I4_1/a$	Tetragonal, space group $I4_1/a$
Density	6.35 $g/cm^3$	6.26 $g/cm^3$	4.65 $g/cm^3$
Thermal conductivity	2.3 $W/m \cdot K$	3 $W/m \cdot K$	4 $W/m \cdot K$
Transparency range	0.45 – 5.4 $\mu m$	0.25 – 5.4 $\mu m$	0.25 – 5.4 $\mu m$
Refractive index	$n_o = 1.806$ , $n_e = 1.804$ at 1064 nm $n_o = 1.848$ , $n_e = 1.846$ at 532 nm	$n_o = 1.84$ , $n_e = 1.85$ at 1064 nm $n_o = 1.87$ , $n_e = 1.88$ at 532 nm	$n_o = 1.878$ , $n_e = 1.88$ at 1064 nm $n_o = 1.919$ , $n_e = 1.924$ at 532 nm
Stokes shift	925 $cm^{-1}$	921.5 $cm^{-1}$	888 $cm^{-1}$
Steady-state Raman gain at 1064 nm	8.5 $cm/GW$	5 $cm/GW$	5.5 $cm/GW$
Can be supplied Nd doped: Nd <sup>3+</sup> concentration in the crystal	0 – 0.15 at. % (on Ba site)	0 – 1.5 at. % (on Sr site)	0 – 1.5 at. % (on Sr site)
Surface optical damage threshold (1064 nm, 4.2 ns)	2 $GW/cm^2$	1.9 $GW/cm^2$	0.8 $GW/cm^2$
Mohs hardness	4	4	4

### BaWO<sub>4</sub> CRYSTALS FOR RAMAN GENERATION, polished, a-cut

Catalogue number	Dimensions, mm	Coating	Price, EUR
BaWO-501	5 × 5 × 20	Uncoated	1300
BaWO-502	5 × 5 × 30	Uncoated	1700
BaWO-503	5 × 5 × 50	Uncoated	2060

## Co:Spinel Cr<sup>4+</sup>:YAG

## PASSIVE Q-SWITCHING CRYSTALS

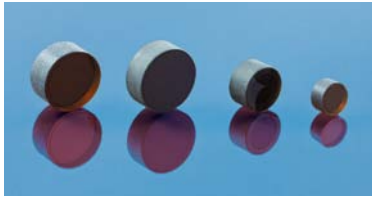

Cr<sup>4+</sup>:YAG crystals

**Fe:ZnSe, Cr:ZnSe, Co:ZnS**  
solid-state saturable absorbers  
also are available upon request

**Co:Spinel** (Co<sup>2+</sup>:MgAl<sub>2</sub>O<sub>4</sub>) is a relatively new material for passive Q-switching in lasers emitting from 1.2 to 1.6 μm, in particular, for eye-safe 1.54 μm Er:glass laser, but also works at 1.44 μm and 1.34 μm wavelengths. High absorption cross section ( $3.5 \times 10^{-19}$  cm<sup>2</sup>) permits Q-switching of Er:glass laser without intracavity focusing both with flash-lamp and diode-laser pumping. Negligible excited-state absorption results in high contrast of Q-switch, i.e.

the ratio of initial (small signal) to saturated absorption is higher than 10 (Fig. 1).

**Cr<sup>4+</sup>:YAG** is one of the best passive Q-switch for high power lasers emitting at ~1 μm wavelength. Standard diameter apertures – 5, 8, 9.5 mm and various initial transmission (or optical density) are available upon request. Also Cr<sup>4+</sup>:YAG laser rods for ultra-short pulse solid-state lasers are available.

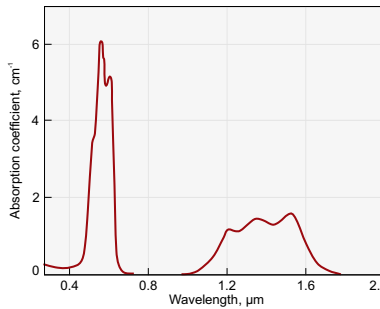

Fig. 1. Absorption spectra of the Co:Spinel crystal

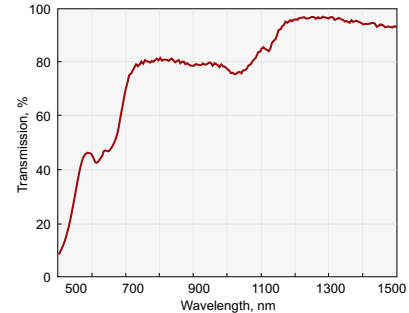

Fig. 2. Transmission of AR coated at 1064 nm Cr:YAG Q-switch with initial transmission of 80% at 1064 nm

### SPECIFICATIONS

	Co:Spinel	Cr <sup>4+</sup> :YAG
Working wavelength range, μm	1.2 – 1.6	0.8 – 1.2
Absorption cross-section, cm <sup>2</sup>	$3.5 \times 10^{-19}$ (at 1.54 μm)	$5 \times 10^{-18}$ (at 1.06 μm)
Initial transmittance, %	30 – 99	20 – 99
Transmission tolerances	±2 %	±2 %
Wavefront distortion	<λ/10 @ 632.8 nm	<λ/8 @ 632.8 nm
Diameter tolerances	+0.0 / -0.2 mm	+0.0 / -0.2 mm
Parallelism error	< 20 arcsec	≤ 30 arcsec
Perpendicularity	< 5 arcmin	≤ 15 arcsec
Surface quality	10 – 5 scratch & dig (per MIL-O-13830A)	20 – 10 scratch & dig (per MIL-O-13830A)
Chamfer	<0.1 mm @ 45°	<0.1 mm @ 45°
AR Coating reflectivity	<0.2 % @ 1540 nm	<0.2 % @ 1064 nm

### STANDARD Cr<sup>4+</sup>:YAG CRYSTALS

Catalogue number	Initial Transmission, %	Diameter, mm	Price, EUR
CrYAG-07-20	20	7	130
CrYAG-07-30	30	7	130
CrYAG-07-35	35	7	130
CrYAG-07-40	40	7	130
CrYAG-07-45	45	7	130
CrYAG-07-50	50	7	130
CrYAG-07-65	65	7	130
CrYAG-07-70	70	7	130
CrYAG-07-80	80	7	130
CrYAG-07-85	85	7	130

### STANDARD Co:SPINEL CRYSTALS

Catalogue number	Initial Transmission, %	Diameter, mm	Price, EUR
CoMALO-05-30	30	5	725
CoMALO-05-40	40	5	725
CoMALO-05-50	50	5	725
CoMALO-05-60	60	5	725
CoMALO-05-70	70	5	725
CoMALO-05-80	80	5	725
CoMALO-05-90	90	5	725





# Positioners & Holders

## 830-0001

## RING HOLDERS FOR NONLINEAR CRYSTALS



830-0001-10



830-0001-06

- Black anodized aluminium body
- Teflon or white anodized aluminium adapter for particular crystal size
- Easy assembling and disassembling

Ring mounts made from black anodized aluminium and Teflon or white anodized aluminium adapter are available for safe and convenient handling of nonlinear crystals. The crystals are glued into white anodized aluminium adapter (830-0001-06). No glue is used for fixation of the crystal into open ring holder with teflon adapter. The standard sizes are  $\varnothing 25.4$  or  $\varnothing 30$  mm and thickness – 6, 10.5, 13.5 or 17.5 mm depending on crystal size.

Please indicate the exact crystal size when ordering.

Part No	Diameter, mm	Thickness, mm	Max. acceptable crystal size, mm	Price, EUR
830-0001-06	25.4	6	12×12×0.5	50
830-0001-10	25.4	10.5	12×12×3	50
830-0001-13	25.4	13.5	12×12×6	50
830-0001-17	25.4	17.5	12×12×15	90
830-0002-10	30	10.5	15×15×3	50
830-0002-13	30	13.5	15×15×6	50
830-0002-17	30	17.5	15×15×15	90

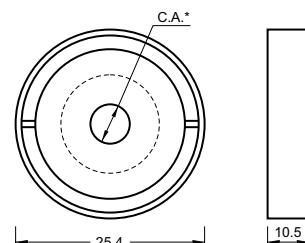

\* C.A. - depends on crystal aperture

830-0001-10

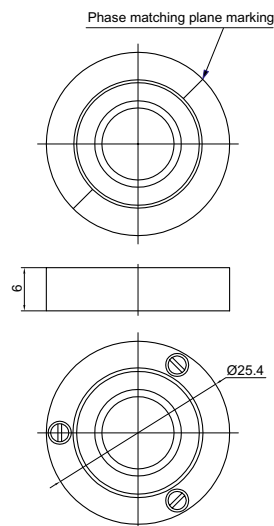

830-0001-06

### HOUSING ACCESSORIES

Positioning Mount  
840-0199 for  
Nonlinear  
Crystal Housing  
See page 2.26



**840-0193 KINEMATIC POSITIONING MOUNT**

- For Ø25.4 mm (1 inch) ring holders
- Kinematic design
- Tilt/tip range ±2°
- Sensitivity 3 arcsec
- Both tilt and tip controlled from aside the optical path
- Fine adjustment screws with 0.25 mm pitch
- Hardened seats under adjustment screws

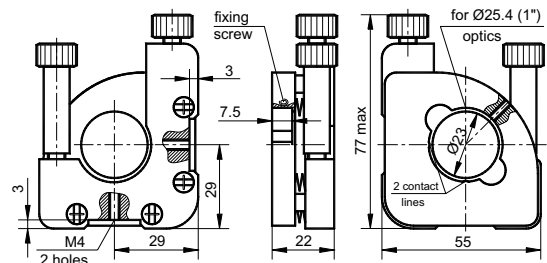

Code	Weight, kg	Price, EUR
840-0193	0.12	87

**840-0199 POSITIONING MOUNT FOR NONLINEAR CRYSTAL HOUSING**



840-0199 Positioning Mount with 830-0001 Ring Holder

- Accepts Ø25.4 mm and up to 10.5 mm thickness ring housings
- Kinematic design
- Wedge and ball drive mechanism
- Tilt/tip range: ±2°
- Sensitivity: 3 arcsec
- Fine adjustment screws with 0.25 mm pitch
- Hardened seats under adjustment screws
- Rotation range: 360°
- Scale gradation: 2°
- Compact and robust design
- Material: black anodized aluminum

This kinematic mount accepts crystal housings of Ø25.4 mm and thickness up to 10.5 mm.

Large knobs on the adjusting screws relieve the strain on operator fingers during adjustment. Both screws protrude from the top allowing convenient adjustment outside the laser beam path and providing easy access for adjustments in densely packed optical set-ups.

An extra M4 tapped hole on the side of the base allows you to operate the mount as a side-drive adjustment control mount. The mount is made of black anodized aluminium to help minimize reflections.

A retaining ring M27×1, two Teflon rings and a tightening key to fix the crystal ring housing is included.

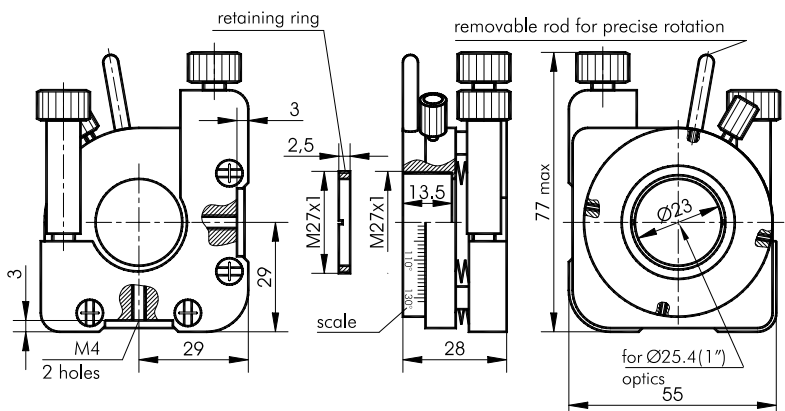

Code	Weight, kg	Price, EUR
840-0199	0.12	165

NONLINEAR CRYSTALS

LASER CRYSTALS

TERAHERTZ CRYSTALS

RAMAN CRYSTALS

POSITIONERS & HOLDERS

CRYSTAL OVENS



# Crystal Ovens

Many of widely used nonlinear crystals are susceptible to ambient humidity, for example KD\*P, BBO, LBO. Protective coatings applied to the surface can reduce degradation to some extent only. To improve the protection of surfaces of the crystals from the degradation it is desirable to keep

the crystals at higher than ambient temperature, which helps avoid condensation on the crystal surfaces.

In addition, if the crystal is used for harmonics generation, the phase-matching angle depends on crystal temperature. For example, the output power of second

harmonics generator based on KD\*P crystal can decrease by 50 % if the crystal temperature changes just by one degree, hence for good laser stability precise crystal temperature stabilization is necessary.

## TC2 • CO1

## TEMPERATURE CONTROLLER TC2 WITH OVEN CO1



TC2 and CO1 is high temperature set (up to 200 °C) consisting of thermocontroller TC2 and crystal oven CO1. TC2 has two independent outputs and can control two CO2-30 ovens simultaneously. Controller is equipped by LAN and USB computer control interfaces.

The nonlinear crystal is mounted into adapter before insertion into oven CO1. Such design facilitates handling and replacement of the crystal. The nonlinear crystal can be sealed with fused silica windows in order to provide extra protection. The standard adapters are 30 and 50 mm length with apertures of 3×3, 4×4, 5×5, 6×6 mm and up to 12×12 mm size. Oven is delivered with one, customer's specific size of adapter. Adapters for different sizes can be ordered separately.

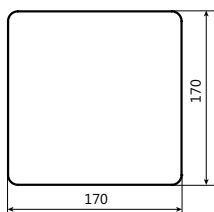
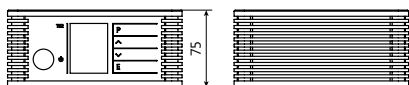

Temperature controller TC2 outline drawing

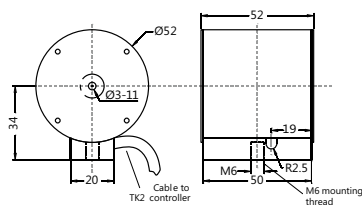

Crystal oven CO1 outline drawing

### SPECIFICATIONS

Model	TC2+CO1-30	TC2+CO1-50
Quantity of ovens possible to connect to one controller TC2	2	1
Temperature tuning range	RT – 200 °C	
Maximum crystals dimensions	12×12×30 mm	12×12×50 mm
Sealing (optional)	FS windows	
Accuracy	± 0.5 °C	
Long-term stability	± 0.05 °C	
Control interfaces	LAN, USB	
Mains	90–264 V, 47–66 Hz	
Power consumption	< 50 W	
Dimensions, Dia×D	Ø52×52 mm	Ø52×72 mm

Specifications are subject to changes without advance notice.

Code **	Description, features	Price, EUR
<b>Thermocontroller TC2</b>		
<b>TC2</b>	Thermocontroller, Fuzzy logic, RT-200 °C, can control two CO1 ovens, long-term stability $\pm 0.05$ °K, worldwide mains	1063
<b>Crystal Ovens for TC2</b>		
<i>For crystal length up to 30 mm</i>		
<b>CO1-30-y/y</b>	Standard crystal sizes *	622
<b>CO1-30-y/z</b>	Custom crystal sizes	672
<b>CO1-30S-y/y</b>	Sealed, standard crystal sizes *	1022
<i>For crystal length up to 50 mm</i>		
<b>CO1-50-y/y</b>	Standard crystal sizes *	766
<b>CO1-50-y/z</b>	Custom crystal size	828
<b>CO1-50S-y/y</b>	Sealed, standard crystal sizes *	1166
<b>Mounting accessories</b>		
<b>MS-4</b>	Adapter for CO1 oven mounting on tilt stage. Tilt stage should be ordered separately	150

\* Sizes 3×3, 4×4, 5×5, 6×6, 12×12 are standard.

\*\* y/y, y/z – crystal size.

## Heatpoint

## ROUND OVEN FOR NONLINEAR CRYSTALS



Heatpoint Crystal oven

Heatpoint is a compact round oven designed for heating of humidity sensitive nonlinear crystals. It is used to prevent moisture condensation on the crystal faces or for thermo-stabilization of the crystals.

The oven features precise long term stability and compact design. Heatpoint is designed to be used with common one-inch optics positioning mounts or with our special positioning mount PM1. A small thermocontroller is attached to the oven on a wiring.

Required temperature of the oven is preset in the factory and it can be chosen by the customer in the range between 30 °C and 80 °C. Preset temperature can be adjusted in  $\pm 5$  °C range.

Heatpoint oven has special crystal adapter and fits crystals of size up to 6×6×30 mm. The adapter is made exactly for particular crystal size and it cannot be used for a crystal of a different size.

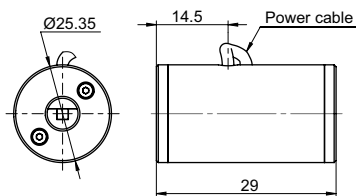

HP1 dimensions

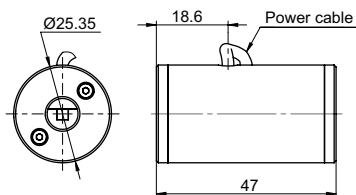

HP2 dimensions

### SPECIFICATIONS

Model	HP1	HP2
Maximum crystals dimensions	6 × 6 × 15 mm	6 × 6 × 30 mm
Preset temperature	30 – 80 °C	
Temperature tuning range near preset	$\pm 5$ °C	
Long-term stability	$\pm 0.15$ at 30-50 °C $\pm 0.2$ at 50-80 °C	
Powering requirements	12 – 16 V	
Power consumption (P <sub>MAX</sub> )	5.5 W	
Sensor type	PTC thermo resistor	
Output connector	2.5 mm mono plug	
Thermocontroller size	18 × 12 × 42.5 mm	
Distance (wiring length) from oven to thermocontroller	180 mm	
Oven dimension, dia × L	Ø25.4 × 29 mm	Ø25.4 × 47 mm

### MOUNT SPECIFICATIONS

Model	PM1
Adjusting angles, tilt and tip	$\pm 3.5^\circ$
Rotation along Z-axis	180°

Code	Description	Price, EUR
<b>HP1</b>	Heatpoint oven (Ø25.4 × 29 mm) with attached thermocontroller	200
<b>HP2</b>	Heatpoint oven (Ø25.4 × 47 mm) with attached thermocontroller	200
<b>PM1</b>	Positioning mount for Heatpoint ovens	250

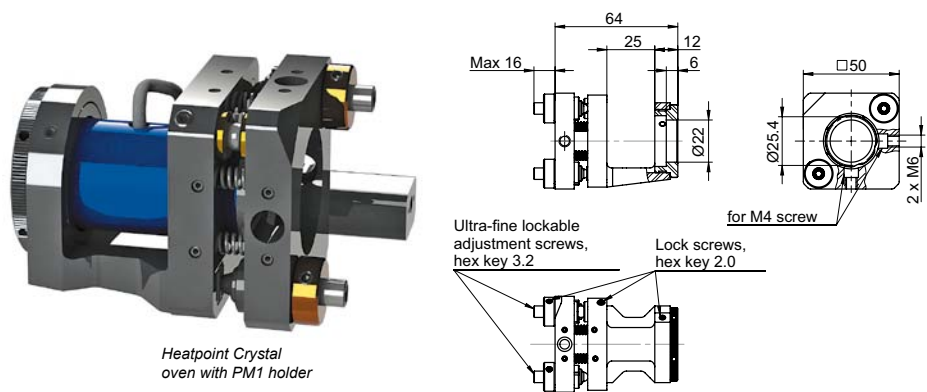

Heatpoint Crystal oven with PM1 holder

**CH8 OVEN FOR NONLINEAR CRYSTALS**



CH8 is compact oven with built-in thermo-controller for nonlinear crystals to keep them at stabilized temperature in range 30...60 °C. It is ideal for larger aperture crystals like KD\*P. The crystals with up to

15 × 15 mm dimensions can be mounted. Each oven is made exactly for specific crystal aperture size, so it cannot be used for different size crystals.

**SPECIFICATIONS**

Model	CH8-20	CH8-30	CH8-50
Temperature range		30 – 60 °C	
Maximum crystals dimensions	15×15×20 mm	15×15×30 mm	15×15×50 mm
Temperature stability		± 0.2 °C	
Power consumption	<6 W	<6 W	<9 W
Control interface		CAN	
Crystal center position above pad		16 mm	
Dimensions, W×H×D	48×44×26 mm	48×44×36 mm	48×44×56 mm

Specifications are subject to changes without advance notice.

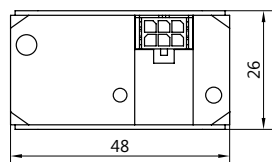
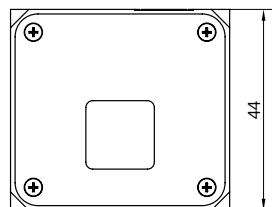

CH8 dimensions

Code **	Description, features	Price, EUR
<b>CH8-20 – crystal length up to 20 mm</b>		
CH8-20-y/y-x	Standard crystal sizes *	452
CH8-20-y/z-x	Non-standard crystal size	508
<b>CH8-30 – crystal length up to 30 mm</b>		
CH8-30-y/y-x	Standard crystal sizes *	509
CH8-30-y/z-x	Non-standard crystal size	572
<b>CH8-50 – crystal length up to 50 mm</b>		
CH8-50-y/y-x	Standard crystal sizes *	580
CH8-50-y/z-x	Non-standard crystal size	733
<b>Mounting accessories</b>		
MS-1	Two axis tilt adjustment 5 degrees range, suitable for all types of CH8 or CH9 crystal ovens	214
MS-2	Two axis tilt stage, adjustment in 5 degree range, fits two pc. of CH8 or CH9 ovens	358
MS-3	Adapter for CH8 or CH9 mounting on rotary stage, 15 degrees fine tuning, angle read-out. Rotary stage should be ordered separately	119
<b>Power supply PS-12</b>		
PS-12	Power supply for CH8 or CH9 crystal oven, 100 – 240 VAC mains, +12 VDC output	61

\* Sizes 3×3, 4×4, ..., 15×15 are standard.

\*\* y/y, y/z – crystal size, x – preset temperature in degrees of Celsius (30-60 °C range).

## CH9

## OVEN FOR NONLINEAR CRYSTALS



CH9 is compact oven with built-in thermo-controller for nonlinear crystals to keep them at stabilized temperature in range 30...80 °C. The crystals with aperture up to 12×12 mm and length up to 15 mm can be mounted. CH9-30 oven is designed for crystal length up to 30 mm.

Crystal oven is equipped with crystal adapters (holders), similar design as CO1, that can be easily replaceable for different crystal size. Crystal adapters can be ordered separately.

### SPECIFICATIONS

Model	CH9-15	CH9-30
Temperature range	30 – 60 °C	
Maximum crystals dimensions	12×12×15 mm	12×12×30 mm
Temperature stability	± 0.2 °C	
Power consumption	<6 W	<9 W
Control interface	CAN	
Crystal center position above pad	23 mm	
Dimensions, W×H×D	48×50×36 mm	48×50×56 mm

Specifications are subject to changes without advance notice.

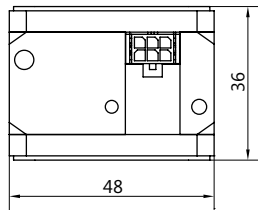
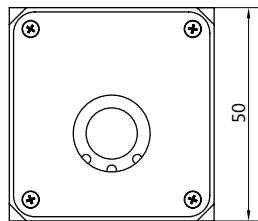

CH9 dimensions

Code **	Description, features	Price, EUR
<b>CH9-15 – crystal length up to 15 mm</b>		
CH9-15-y/y-x	Standard crystal sizes *	588
CH9-15-y/z-x	Non-standard crystal sizes	642
<b>CH9-30 – crystal length up to 30 mm</b>		
CH9-30-y/y-x	Standard crystal sizes *	659
CH9-30-y/z-x	Non-standard crystal sizes	733
<b>Mounting accessories</b>		
MS-1	Two axis tilt adjustment 5 degrees range, suitable for all types of CH8 or CH9 crystal ovens	214
MS-2	Two axis tilt stage, adjustment in 5 degrees range, fits two pc. of CH8 or CH9 ovens	358
MS-3	Adapter for CH8 or CH9 mounting on rotary stage, 15 degrees fine tuning, angle read-out. Rotary stage should be ordered separately	119
<b>Power supply PS-12</b>		
PS-12	Power supply for CH8 or CH9 crystal oven, 100-240 VAC mains, +12 VDC output	61

\* Sizes 3×3, 4×4, ..., 15×15 are standard.

\*\* y/y, y/z – crystal size, x – preset temperature in degrees of Celsius (30-60 °C range).

### RELATED PRODUCTS

**Mount MS-1**  
for fine tuning of CH8 or CH9 angle is available. The tuning range is ± 2.5°.

