



ENFit™

 medicina



Medicina syringe feeding system

The worldwide introduction of the new ENFit connector will reduce the risk of enteral tube feeding misconnections and improve patient safety throughout hospitals around the globe.



Enhancing patient safety

ENFit - The NEW international design standard for enteral tubing connectors is being launched as part of a phased initiative called 'Stay Connected'.

Stay Connected is led by an international group of clinicians, manufacturers and regulators, who together developed ISO 80369. This standard establishes requirements for small-bore connectors for liquids and gases, making it difficult, if not impossible, for unrelated delivery systems to be connected.

The introduction of this standard will mark a new milestone in the global effort to improve patient safety, starting with enteral feeding systems. With increasing

patient mobility and portability, a single global solution is required to ensure patient safety and prevent either a misconnection or no connection.

The new ISO standard connector system—called ENFit—will replace all connector systems to ensure one global enteral connector.

“a single global solution is required to ensure patient safety and prevent either a misconnection or no connection.”



Medicina is a Charter Member of GEDSA



ENFit®

The new ISO 80369-3 standard connector provides a simple way to reduce the risk of enteral tube feeding misconnections and improve patient safety.

The new connector:

- Addresses “patient side” connections between feeding tubes, administration sets, medication, flush and bolus feeding syringes and other enteral devices.
- Passes a rigorous validation process including computer aided design (CAD), human factors and usability testing as part of the pathway to ISO standards.

The new standard connector has a unique enteral-specific design that:

- Does not allow connectivity with any other connector for any other clinical use.
- Provides a locking feature that signals the appropriate connection and stays in place.
- Has a female connector end for any administration sets and syringes that fit into a male patient-access feeding tube port.

There is just one standard nutrition formula connector that will be utilized by all feeding set manufacturers and universally adopted into practice.

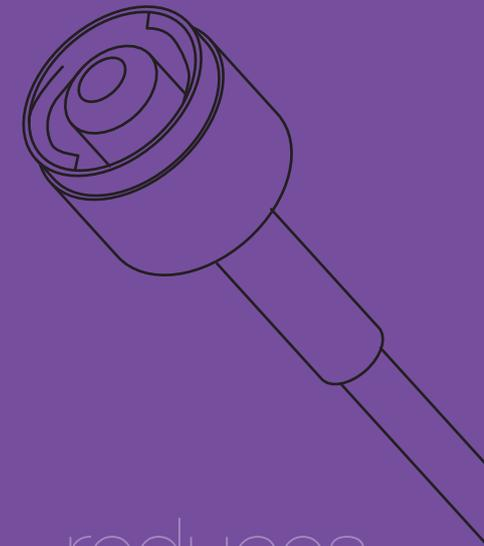

reduces
the risk of
harm to
patients



Medicina new enteral feeding system



The new ENFit ISO Standard range of enteral syringes has been developed to deliver enteral feeds, medicines and flushes safely to neonatal, paediatric and adult patients.

The syringes, tubes and accessories are all fitted with an ENFit connector and coloured purple to clearly differentiate the enteral feed lines from the other patient access lines. The ENFit connector will not fit intravenous equipment and eliminates the risk of harm to patients from accidental misconnections. In addition the use of a standard ENFit connector will allow the syringes to be connected and used with all other enteral equipment without the use of adapters.

This system of safety syringes and accessories provides a "hospital wide" solution for safer enteral access because all the components are compatible with all other enteral feeding systems used within the hospital. A compatible and complimentary home feeding system is also available ensuring a smooth transition from hospital to home. Significant cost advantages can be gained by the use of all the components of these systems. All the hospital products are sterile and single use only.

“ Significant cost advantages can be gained by the use of all the components of these systems ”



Patients

Firstly we would like to focus on particular patient groups in the hospital to understand their feeding and medication needs and show how the components of this syringe feeding system can be used to aspirate and safely deliver feeds, flushes and medicines to all hospital patients.

Neonates

The new ENFit ISO Standard syringe feeding system has all the necessary devices to feed babies safely.

ENFit syringes provide the widest internal tip diameter, which gives a better flow for the delivery of gravity or bolus feeds. Oral syringes and non-Luer syringes can only deliver gravity feeds very slowly because the feed has to pass through a very narrow syringe port. ENFit syringes also produce lower delivery pressures for medications. It is not simply by chance that the ENFit design has been chosen for ISO 80369-3.

All the necessary feeding tubes, low volume extension sets and other accessories like drainage bags are available to feed and aspirate all sizes of babies. Medicina is the only company in Europe that makes all the components necessary to safely feed and administer medicines to babies in the department of neonatal care.



Paediatric and adult patients

The Medicina enteral syringe system can be used safely to feed, flush and deliver enteral medicines to all types of patients. All patients can be at risk from the harm caused by misconnections of enteral feeds to intravenous devices.

Children needing enteral nutritional support are usually pump fed but some smaller children and some patients fed by pump overnight also use bolus or gravity feeds. The larger syringes can be used to gravity feed either directly into the tube or using the extension set. Feeding containers can be accessed by using the milk straw. The smaller syringes can be used to deliver feeds into the tubes or directly into pump administration sets.

Medicines can also be delivered using the smaller syringes into the feeding devices.

Adults are also often pump fed but it is important to maintain the patency of the enteral feeding device by flushing. All enteral devices should be flushed at least every six hours and also before and after medicines to prevent any drug-feed interaction. The smaller syringes are also used to deliver medicines accurately and safely into enteral feeding devices. It is also important to confirm the correct position of enteral feeding devices and the syringes are very useful for aspiration to check position with universal pH indicator strips.



Feeding tubes

Medicina has several ranges of feeding tubes for both short and long term indications.

The most popular tubes are designed to feed patients for short periods. There are also long term tubes with guidewires and wider bore tubes for aspiration. In addition there are several specialist nasojejunal tubes and double lumen feeding and aspiration tubes including a Replogle tube.

nasogastric tube priming volumes

diameter	length		
	50cm	80cm	120cm
4FR	0.25ml	0.6ml	0.9ml
5FR	0.5ml	0.8ml	1.1ml
6FR	0.7ml	1.1ml	1.6ml
8FR	0.9ml	1.4ml	2.1ml
10FR	1.7ml	2.8ml	4.2ml

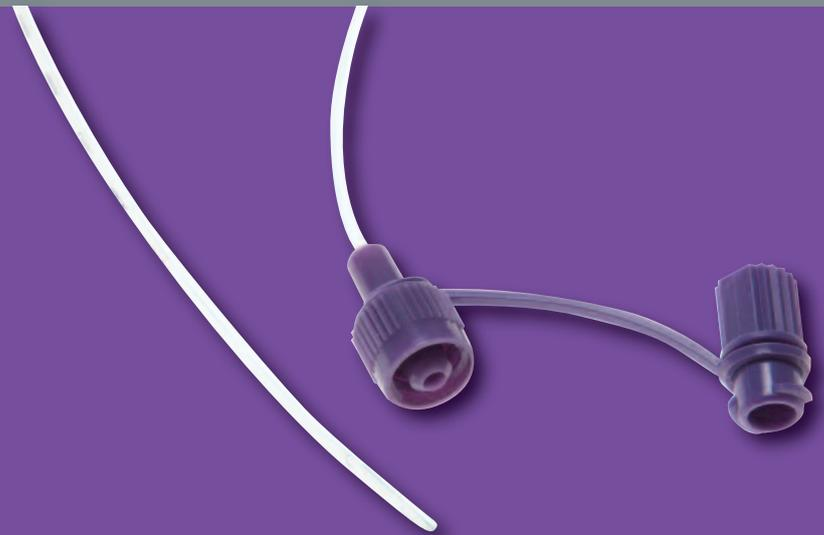

Short term

The short term tubes are mainly used in neonates and children but can be used in adults who need short term enteral support.

The tubes are used to feed, flush and deliver medicines. The tubes have an ENFit connector which fits ENFit syringes and administration sets. The tubing itself is smooth and carries distance marks to reference tube position. All tubes have a radiopaque stripe to confirm position with X-ray.

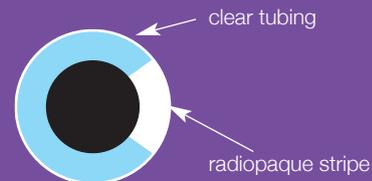

These tubes are made of polyurethane in a wide range of sizes. The radiopaque stripe is 40% Barium Sulphate and makes up 20% of the tube diameter so that all tubes show up clearly on X-ray. Additionally there are some specialist nasojejunal tubes and double lumen feeding and aspiration tubes including a Replogle tube.



Long term

These tubes are polyurethane with guidewires and are used longer term to feed adults and children.



Some popular sizes in 8FR and 10FR are also available weighted. Typical users would be critical care areas, medical and care of the elderly units, paediatric units and also community patients. The tubes have an ENFit connector which fits Medicina syringes and the female ends of pump administration sets. They also have an ENFit guidewire holder allowing aspiration to confirm correct position using Medicina syringes. The tubing itself is smooth and carries distance marks to reference tube position. All tubes are fully radiopaque (40% Barium Sulphate compounded into the tube), to confirm position with X-ray or a pH strip can be used.

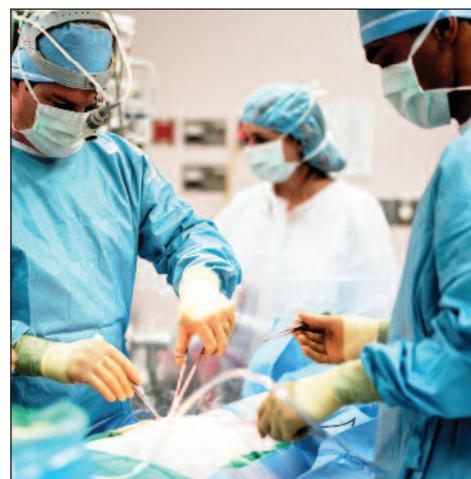

Short term wide bore

These tubes are polyurethane and available from 6FR - 20FR diameters with a length of 100cm.

These tubes are used to aspirate and feed adults and children. Typical use would be in intensive care, high dependency units, theatres, crash trolleys and surgical wards. The tubes have an ENFit connector which fits Medicina syringes. In addition they have a funnel or bladder type connector to fit suction equipment. The tubing itself is smooth and carries distance marks the full length of the tube to reference tube position. All tubes have a radiopaque stripe to confirm position with X-ray. These tubes are softer and smoother than normal PVC Ryles type tubes and are easier to pass and more comfortable for the patients.



Accessories

Medicina has put together the largest range of accessories to help with the delivery of feeds and medicines using the ENFit syringe feeding system.

There are straws, caps, bottle adapters, sets and a wide variety of small but important accessories to help with the access of enteral equipment. Several long and short extension sets with and without Y-sites are available which are used to connect between the feeding container or syringe and the nasogastric tube.

Medicina has developed a range of drainage bags with compatible connectors to allow gastric drainage from nasogastric tubes or other devices.

There are also several bottle and container adapters to help access medicine containers and feed containers.

A dedicated Medicine needle is available which can access multi dose vials with the rubber bung type cap. A filter needle is also available to filter out any possible glass particles when medicines arrive in glass ampoules.

A specialist Surfactant administration kit is also available for the drawing up and delivery of surfactant in babies.



The largest range of accessories to help with the delivery of feeds and medicines using the ENFit syringe feeding system



Connections

Priming connections

It is normal practice, with I.V. fluids, to prime the syringe and connectors with fluid to exclude air. This is not necessary with enteral connections.

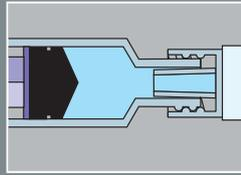

Enteral connections

It is important that enteral connections are not primed with feed or thick medicines as it can be difficult to separate the connections. The threads can sometimes become clogged with feed and debris.

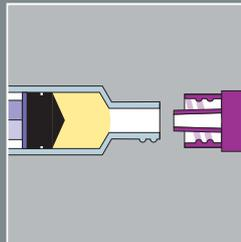

Flushing connector threads

It is also good routine practice, following feeds or the delivery of medicines, to flush the inside threads of the connector of Medicina NG tubes. This will prevent any disconnection problems.

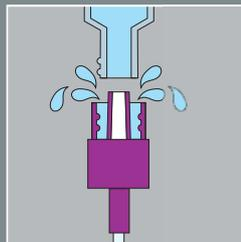

Priming Medicina enteral connections

It is therefore recommended that feeding tubes, lines and enteral syringes are only primed up to but not including the connection. The connection is left full of air which is not a problem for enteral nutrition. In this way the internal threads of the ENFit connector do not become clogged with feed or medicines.

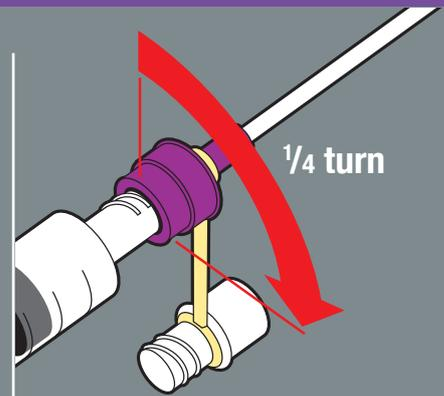
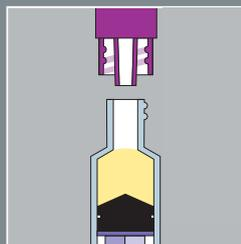

Making connections

When making connections to ENFit it is only necessary to tighten the connection by one quarter turn.

This will provide a good seal and will allow simple disconnection.



Adapters

The change to ISO 80369-3 ENFit connector will mean that users will have to run down stocks of 'old' product before moving to the ENFit system.

During this transition period Medicina will be supplying a range of transitional adapters to help ensure feeding can continue to take place and to allow better inventory management to avoid waste.

The following adapters are available:



UK

'Old' Reverse Luer Tube	Adapter TA01	New ENFit Syringe
New ENFit Tube	Adapter TA02	'Old' Reverse Luer Syringe
'Old' Funnel Tube	Adapter LK01	New ENFit Syringe

Europe/Rest of World

Enlock Tube	Adapter TA01	New ENFit Syringe
New ENFit Tube	Adapter TA05	Enlock Giving Set/Syringe
Large cone Tube (DW or Superlock)	Adapter TA03	New ENFit Syringe/Set
New ENFit Tube	Adapter TA04	Large cone Syringe (DW, Superlock)
Oral Tip Tube	Adapter ML01L	New ENFit Syringe/Set
New ENFit Tube	Adapter TA06	Oral Tip Syringe/Set



Enteral medicines

In general, liquid forms of medicine should be used where possible for enteral routes.

Soluble tablets or capsules can be used if they are thoroughly dissolved. Enteric coated medicines should never be crushed or dissolved. If the liquid and soluble forms are unavailable then tablets can be crushed or capsules opened and mixed in 10-15mls of water (5-10mls for children). The tablet crusher should be rinsed and the washings and residue flushed down the tube.

Delivery

Medicines should be delivered using an enteral syringe. Tubes should be flushed before and after medicines with 20-30mls of water in adults and 5-10mls in children. Each medicine should be administered separately and the tube and the syringe should be flushed between the dose of different medicines. In general medicines should not be added to feeds because of potential interactions. Timing may also be important as some medicines are designed to be absorbed by an empty stomach.

Medicine container access

Medicines can be drawn up using the medicine straw and the milk straw for larger volumes and thicker preparations. If glass ampoules are used, then a medicine filter straw is available.

Several bottle adapters are available to fit the various liquid bottles. The universal bottle adapter fits most and there are seven other sizes which fit flush into the bottle to allow the use of tamper-proof bottle caps. A blunt fill needle is also available for use with multi-dose bottles with a rubber bung.

Medicine and feed interactions

Some medicines can interact with enteral feeds, vitamins and electrolytes and some need to be given on an empty stomach. It is therefore important to flush before and after each feed to prevent any coagulation of the proteins in the feeds, which can block the feeding tubes.

Outpatient medicines

The bottle adapter can be provided non-sterile so that a suitable adapter can be packed with a suitable syringe for patients leaving hospital. A small instruction pad has also been produced so an instructions leaflet can be torn off for each outpatient as required.

Small volume medicines

It is advisable to use the medicine straw or bottle adapters for small volumes of medicines as the straw will occupy the dead space of the syringe in the same way as the male connector on the feeding tube. In this way medicines can be delivered accurately without considering the dead space. For very small doses (less than 0.5ml) the 1ml Low Dose Syringe should be used.



Caution

Medicina does not recommend the use of Cup Fill Technique for the drawing up of any medicine



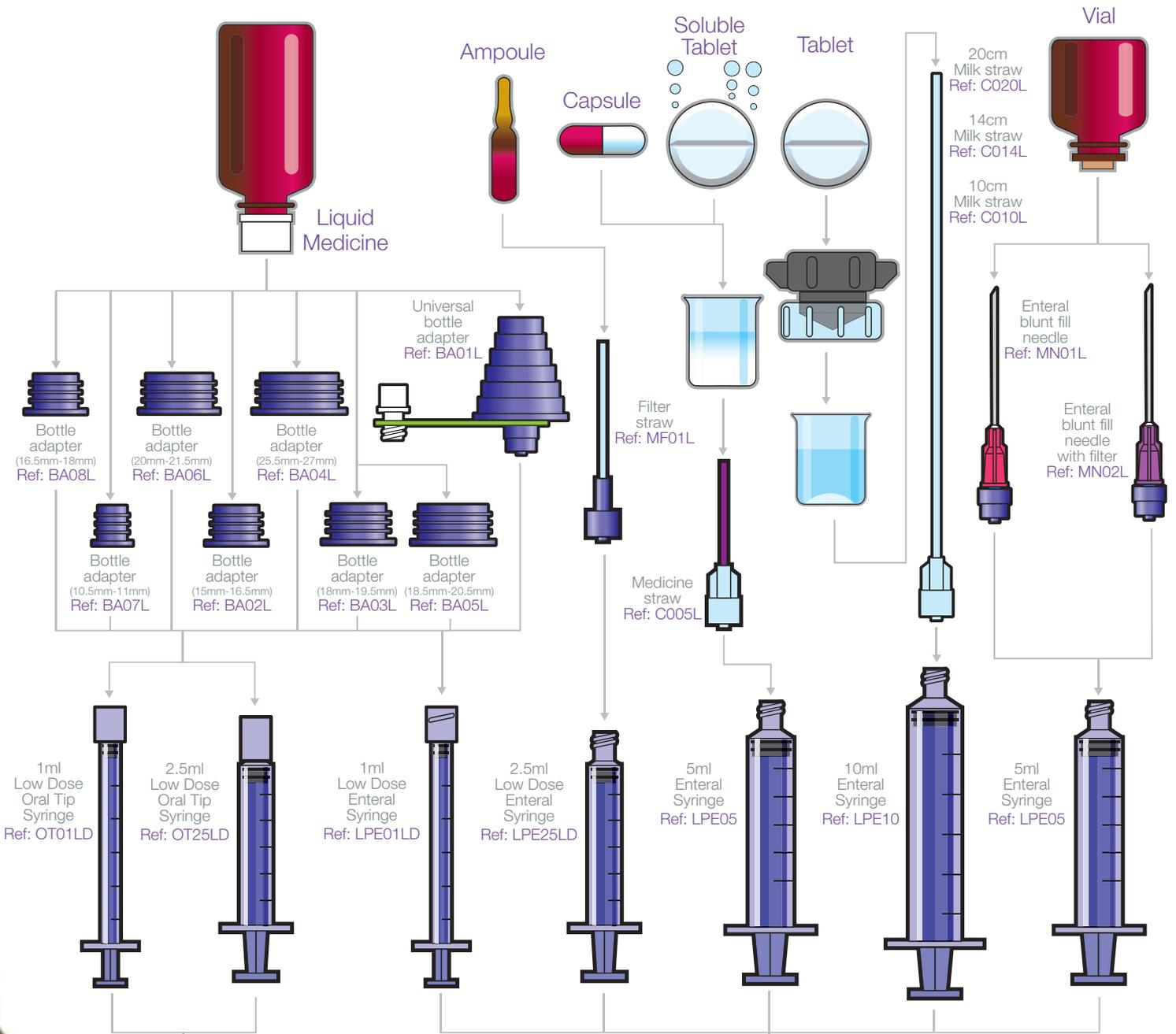

Oral

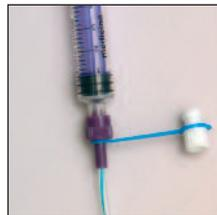

Enteral



Product range

enteral syringe pump



P1000 Enteral Syringe Pump (1)

ENFit syringes



LPE01LD 1ml low dose enteral syringe (100)

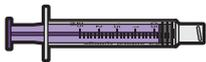

LPE25LD 2.5ml low dose enteral syringe (100)

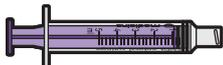

LPE05 5ml enteral syringe (100)



LPE10 10ml enteral syringe (100)

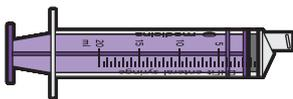

LPE20 20ml enteral syringe (80)

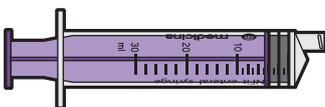

LPE30 30ml enteral syringe (80)

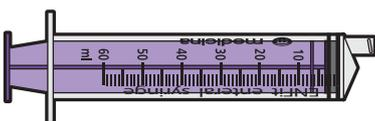

LPE60 60ml enteral syringe (60)

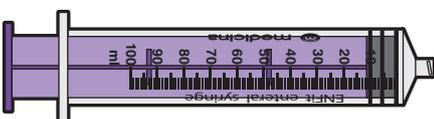

LPE100 100ml enteral syringe (30)

ENFit reusable syringes



LHE01LD 1ml low dose reusable enteral syringe (100)



LHE25LD 2.5ml low dose reusable enteral syringe (100)

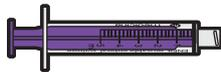

LHE05 5ml reusable enteral syringe (100)

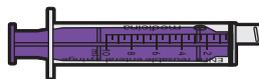

LHE10 10ml reusable enteral syringe (100)

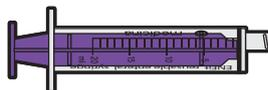

LHE20 20ml reusable enteral syringe (80)

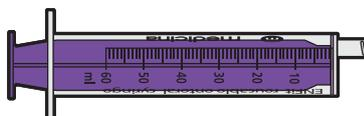

LHE60 60ml reusable enteral syringe (60)

Low dose oral syringes (ENFit compatible)



OT01LD 1ml low dose oral syringe (100)

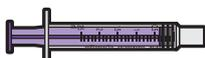

OT25LD 2.5ml low dose oral syringe (100)

ENFit extension sets

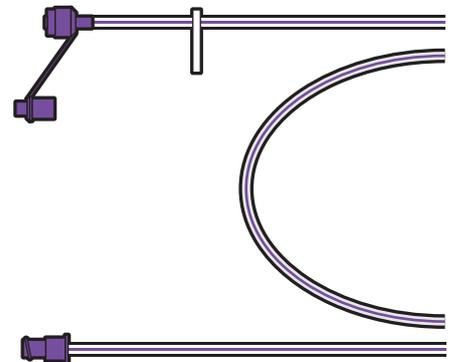

EP015L 15cm long short extension set (50)

EP075L 75cm long extension set (50)

EP075LW 75cm long wide bore extension set (50)

EP150L 150cm long extension set (50)

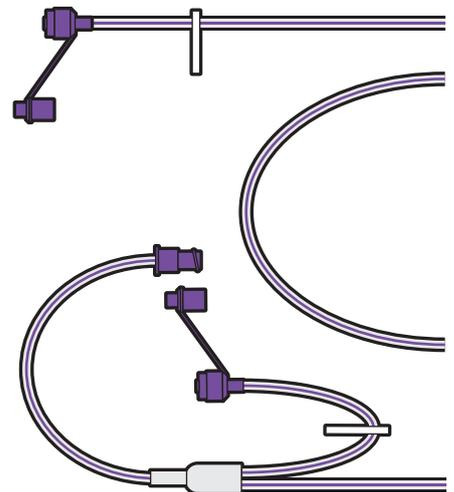

EP015LYW 15cm long wide bore Y-site short extension set (50)

EP075LY 75cm long Y-site extension set (50)

EP075LYW 75cm long wide bore Y-site short extension set (50)

EP150LY 150cm long Y-site extension set (50)

ENFit short-term polyurethane feeding tubes



LG4/40	4FR x 40cm (50)
LG4/50	4FR x 50cm (50)
LG4/80	4FR x 80cm (50)
LG4/90	4FR x 90cm (50)
LG4/120	4FR x 120cm (50)
LG4/125	4FR x 125cm (50)
LG4/160	4FR x 160cm (50)
LG5/40	5FR x 40cm (50)
LG5/50	5FR x 50cm (50)
LG5/80	5FR x 80cm (50)
LG6/40	6FR x 40cm (50)
LG6/50	6FR x 50cm (50)
LG6/80	6FR x 80cm (50)
LG6/90	6FR x 90cm (50)
LG6/120	6FR x 160cm (50)
LG6/160	6FR x 120cm (50)
LG8/40	8FR x 40cm (50)
LG8/50	8FR x 50cm (50)
LG8/80	8FR x 80cm (50)
LG8/90	8FR x 90cm (50)
LG8/120	8FR x 120cm (50)
LG8/160	8FR x 160cm (50)
LG10/80	10FR x 80cm (50)
LG10/120	10FR x 120cm (50)
LG10/160	10FR x 160cm (50)
LG12/80	12FR x 80cm (50)
LG12/120	12FR x 120cm (50)
LG14/80	14FR x 80cm (50)

Weighted

LG6/50W	6FR x 50cm (50)
LG6/80W	6FR x 80cm (50)
LG8/50W	8FR x 50cm (50)
LG8/80W	8FR x 80cm (50)
LG10/80W	10FR x 80cm (50)
LG12/80W	12FR x 80cm (50)

ENFit long-term polyurethane feeding tubes

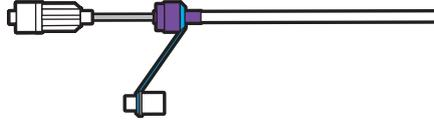

NGP6/55L	6FR x 55cm (25)
NGP6/75L	6FR x 75cm (25)
NGP6/85L	6FR x 85cm (25)
NGP8/55L	8FR x 55cm (25)
NGP8/75L	8FR x 75cm (25)
NGP8/85L	8FR x 85cm (25)
NGP8/120L	8FR x 120cm (25)
NGP10/85L	10FR x 85cm (25)
NGP10/120L	10FR x 120cm (25)
NGP12/100L	12FR x 100cm (25)
NGP12/120L	12FR x 120cm (25)
Weighted	
NGP8/85LW	8FR x 85cm (25)
NGP10/85LW	10FR x 85cm (25)

ENFit short-term polyurethane nasojejunal tubes

NJP6/120L	6FR x 120cm (10)
NJP8/120L	8FR x 120cm (10)
NJP8/130L	8FR x 130cm (10)
NJP10/130L	10FR x 130cm (10)
NJP12/130L	12FR x 130cm (10)
NJP14/130L	14FR x 130cm (10)
Weighted	
NJP10/130LW	10FR x 130cm (10)
NJP12/130LW	12FR x 130cm (10)
NJP14/130LW	14FR x 130cm (10)

ENFit long-term polyurethane Y-Site feeding tubes

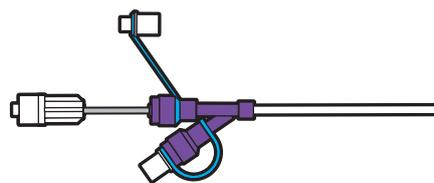

NGP6/95Y	6FR x 95cm (25)
NGP8/95Y	8FR x 95cm (25)
NGP10/95Y	10FR x 95cm (25)
NGP12/95Y	12FR x 95cm (25)

ENFit short-term polyurethane feeding/aspiration tubes

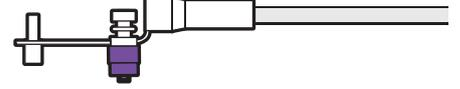

RT6/80L	6FR x 80cm (50)
RT8/80L	8FR x 80cm (50)
RT10/100L	10FR x 100cm (50)
RT12/100L	12FR x 100cm (50)
RT14/100L	14FR x 100cm (50)
RT16/100L	16FR x 100cm (50)
RT18/100L	18FR x 100cm (50)
RT20/100L	20FR x 100cm (50)

ENFit double lumen feeding tubes

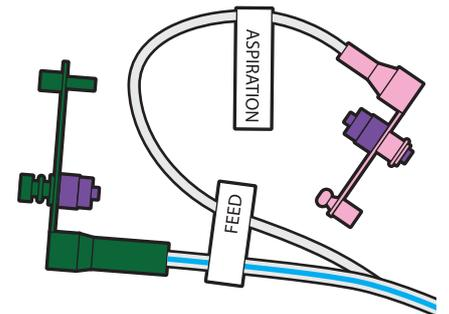

EF2L	Standard Nasojejunal Feed/Aspiration Tube 7/9FR x 130cm (5)
EF2EL	Endoscopic Nasojejunal Feed/Aspiration Tube 7/9FR x 130cm (5)

Accessories

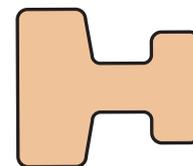

NP01	Adult nose plaster (100)
NP02	Paediatric nose plaster (100)



IN01	pH indicator strips (200)
IN02	pH indicator strips (100)

ENFit Gastrostomy extension set

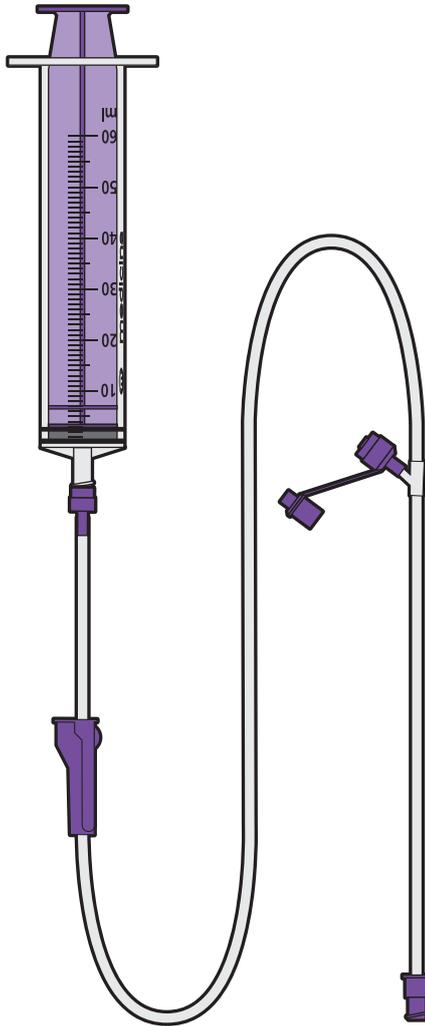

MGS02L Bolus or Gravity Gastrostomy Extension Set (30)

ENFit Gastric Decompression systems

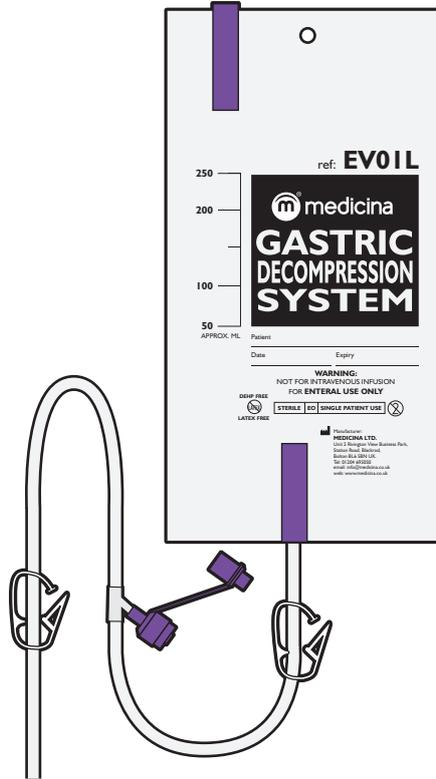

- EV01L** 250ml Gastric Decompression System (30)

- EV02L** 500ml Gastric Decompression System (30)

ENFit Enteral drainage bags

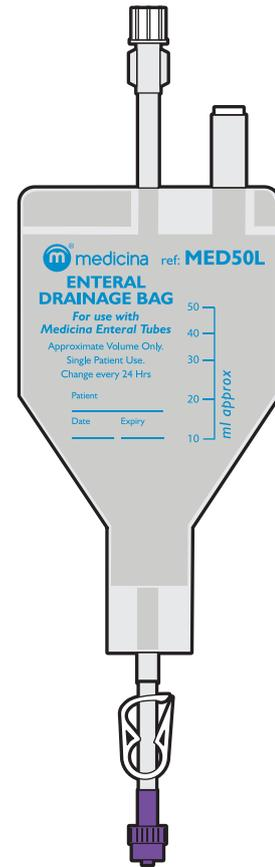

- MED50L** 50ml ENFit Drainage Bag (50)

- MED100L** 100ml ENFit Drainage Bag (50)

- MED250L** 250ml ENFit Drainage Bag (50)

- MED500L** 500ml ENFit Drainage Bag (50)

- MED1000W** 1000ml Enteral Wide Bore Drainage Bag (50)

surfactant kits

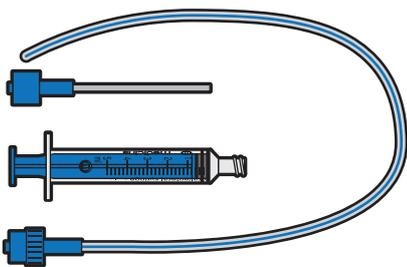

SF01 Surfactant Kit (25)

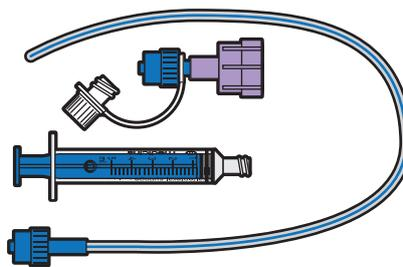

SF02 Needle Free Surfactant Kit (25)

ENFit Double Lumen Replogle tube

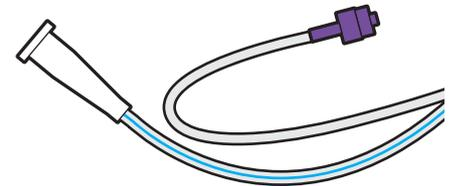

NF02L Double Lumen "Replogle Tube" 10FR (10)



ENFit Bottle adapters



BA01L Stepped Bottle Adapter (50)

BA01LB Bulk pack of Stepped Bottle Adapters (50)



BA02L 15-16.5mm Bottle Adapter (50)

BA02LB Bulk pack of 15-16.5mm Bottle Adapters (50)



BA03L 18-19.5mm Bottle Adapter (50)

BA03LB Bulk pack of 18-19.5mm Bottle Adapters (50)



BA04L 25.5-27mm Bottle Adapter (50)

BA04LB Bulk pack of 25.5-27mm Bottle Adapters (50)



BA05L 18.5-20.5mm Bottle Adapter (50) (Oramorph)



BA06L 20-21.5mm Bottle Adapter (50)



BA07L 10.5-11mm Bottle Adapter (50)



BA08L 15.5-18mm Bottle Adapter (50)

ENFit Transitional Adapters

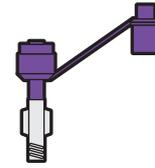

TA01 Transition Adapter for Reverse Luer Tube to ENFit Syringe (50)

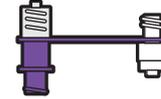

TA02 Transition Adapter for ENFit Tube to Reverse Luer Syringe (50)

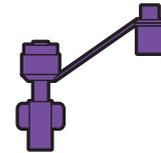

TA03 Transition Adapter for Large Cone Tube to ENFit Syringe/Set (50)

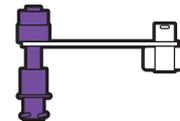

TA04 Transition Adapter for ENFit Tube to Large Cone Syringe (50)



TA05 Transition Adapter for ENFit Tube to Enlock Giving Set/Syringe (50)



TA06 Transition Adapter for ENFit Tube to Oral Tip Syringe/Set (50)



ML01L Transition Adapter for Oral Tip Tube to ENFit Syringe/Set (50)

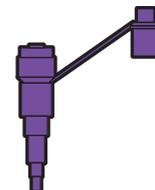

LK01 Transition Adapter for Funnel Tube to ENFit Syringe (50)

ENFit syringe accessories



RC075L 75mm Rectal Medicine Straw (50)



RC150L 150mm Rectal Medicine Straw (50)



C005L 5cm Medicine Straw (50)



C020L 20cm Milk Straw (50)



C014L 14cm Milk Straw (50)



C010L 10cm Milk Straw (50)



MF01L Filter Straw (50)



MN01L Enteral Blunt Fill Needle (100)



MN02L Enteral Blunt Fill Needle with Filter (100)



M158/1LD Male Caps (single) (50)

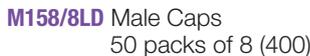

M158/8LD Male Caps 50 packs of 8 (400)



SA01L Pre-Filled Bag Spike Adapter (50)

Medicina new enteral feeding system

The new ENFit ISO Standard range of enteral syringes has been developed to deliver enteral feeds, medicines and flushes safely to neonatal, paediatric and adult patients.



Units 1-4, Rivington View Business Park,
Station Road, Blackrod, Bolton BL6 5BN, UK
Telephone: +44(0)1204 695050
www.medicina.co.uk



www.facebook.com/MedicinaUK



[@medicina_ltd](https://twitter.com/medicina_ltd)

leaders in enteral delivery

