

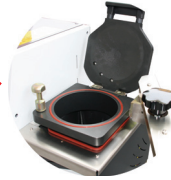

The new U8 Easy Series applicators for melt hot-melt adhesives made of polyamides and reactive polyurethane (PUR) are the top innovation on the international market for their simplicity of use, production flexibility, maintenance costs, quick installation, ease of safety standards, exceptional reliability and full integration with any packaging line, granting the maximum operational flexibility. The new microprocessor controls all those operations necessary to the system proper running: thermo-regulation in all different system areas, programming control of 8 glue tracks for each of the 4 independent channels. Additional features are: Economy Function, Clock, Weekly Program, Max. temperature alarm, Sequential Heating of all channels and delay Temperature Set Point lock.



HERMETIC MELTING TANK AND SAFETY LID

A large cylindrical, hermetically sealed loading inlet facilitates tank filling. The tank has a capacity of 8 kg. The tank lid is then blocked by a safety system that prevents it from opening involuntarily or accidentally, and also prevents material from spilling.



LCD DISPLAY

A new LCD display (specifically designed) graphically shows all the machine sections (tank, manifold, hoses and guns with respective parameters), allowing an immediate and extremely easy system programming also by unskilled operators, eliminating problems generated by codes and foreign languages to understand and meaning that the displays are all the same, independently of the country of use. A specific notification area controls the system status constantly and dynamically in all its operation phases. In case of eventual alarms or faults error messages are displayed.

INNOVATIVE PROGRAMMING

Another innovative feature of the new Easy Series is the "Rotary Switch": the selector through which it is possible, with extreme easiness, to program, modify and set section by section all those parameters intended for the system running.



GEAR MOTOR

The applicators are fitted with variable speed AC motors controlled by inverter positioned horizontally so as to have reduced overall dimensions and ease to access both for inspection and maintenance, thanks to a quick connector and to an easy to open body system.

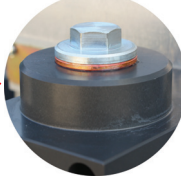

GLUE FILTER

Easy to access and replace, it ensures a better distribution of the adhesive preventing the nozzle clogging due to the presence of impurities in the adhesive.



AIR DRYING SYSTEM

An innovative automatic air drying system (provided as standard and connected to the applicator with a quick coupling connector) removes the air from the tank and replaces it with inert gas or dehumidified dry air to prevent oxidation and thus prevent that the product react irreversibly, in a very brief time, upon contact with humidity in the air.



PRESSURE CONTROL DEVICE

A sophisticated control system shows on the applicator display the adhesive output pressure in the manifold. This visualisation is comparable to a traditional digital pressure gauge indicating the adhesive pressure in bar.



HIGH PRECISION GEAR PUMP

With the same dimensions it is possible to choose between gear pumps of different capacity. Absolute precision and reliability, they are made of super-quick steel and are fully hardened. Like all the inside parts of the applicator, also the pump is easy to remove in case of maintenance or replacement.



QUICK PRESSURE RELEASE AND REGULATION VALVE

It keeps the pressure set constant and ensures the utmost safety during the system use by and releasing the adhesive pressure into the system in an automatic and safe manner, even in the event of an emergency.

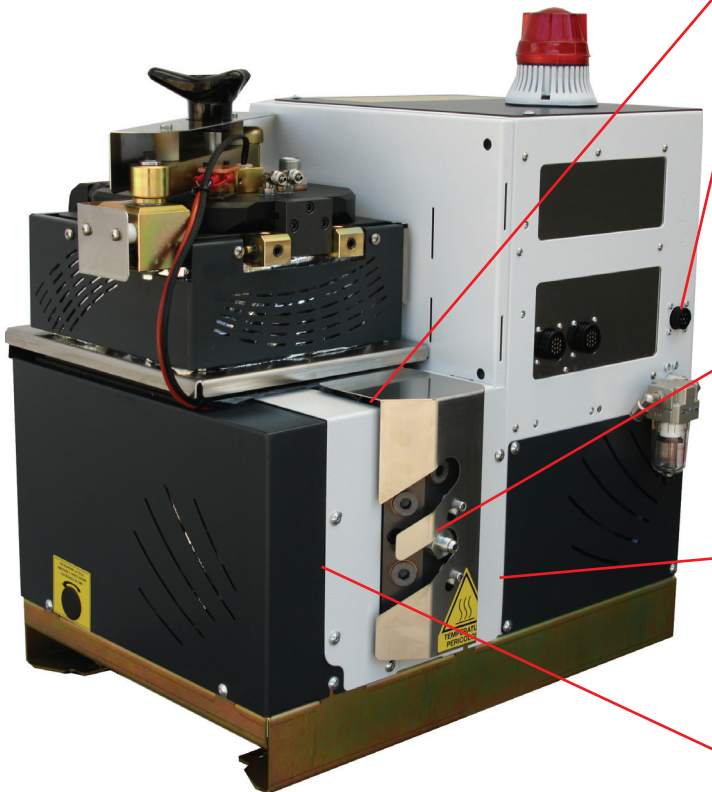

EASY SERIES U8



TECHNICAL SPECIFICATIONS

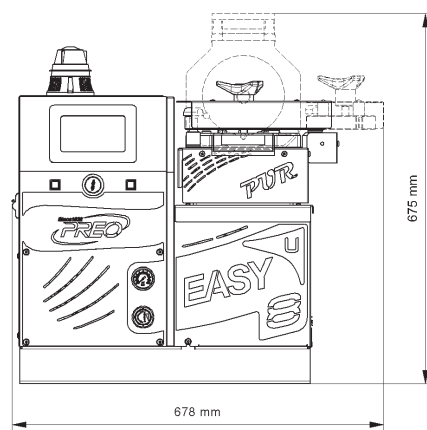
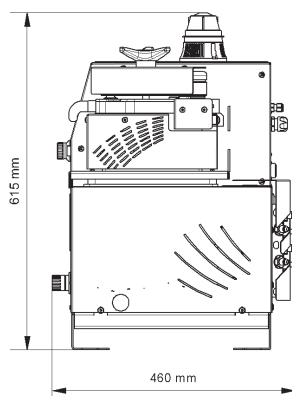
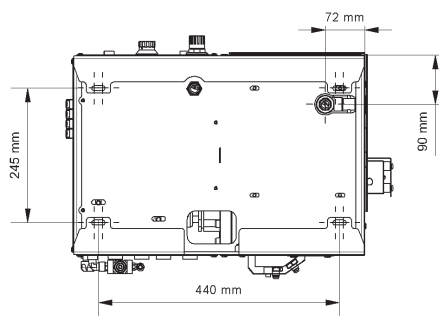
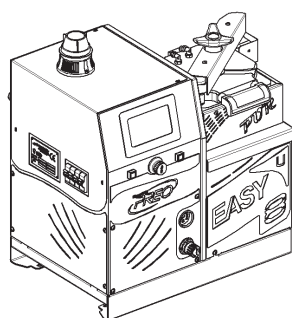

GENERAL SPECIFICATIONS

ADHESIVE TYPOLOGY AND VISCOSITY	hot-melt polyamides and reactive polyurethane (PUR) up to 70.000 Cps
OPERATING TEMPERATURE	50°C±210°C (120°F±410°F) standard version - 50°C±230°C (120°F±450°F) HT high temperature version
HOSE/GUN CONNECTIONS	2, 4 (fitting thread 1/2"x20 UNF)
TANK CAPACITY	8 kg (18 lb)
MELTING RATE	6 kg/h (depending on used adhesive)
WEIGHT (EMPTY)	61 kg (135 lb)
MACHINE DIMENSIONS (L x H x W)	680 x 675 x 460 mm
TANK OPENING DIMENSIONS (∅ MM)	155 mm
TANK	internally coated with PTFE scratch-resistant non-stick treatment, heated gills, quick drain valve and safety lid
MANIFOLD	coated with hard oxidation treatment and glue filter integrated
WARM-UP TIME	35'±40' starting from ambient temperature (0°C±45°C (32°F±113°F))
FASTENING	buttonhole for M8 screws

ELECTRICAL SPECIFICATIONS

VOLTAGE	1/N/PE AC 230 V ±10% 50/60 Hz, 3/N/PE AC 400 V ±10% 50/60 Hz
POWER CONSUMPTION	4.0 kW (18 A) (without hoses and guns)

MICROPROCESSOR SPECIFICATIONS

TEMPERATURE CONTROL	PT100 ±0,5°C (1°F) - RTD or Ni120 (on request)
MICROPROCESSOR TYPOLOGY	by graphic interface with LCD display 240x128 pixels LED back lighted and rotary switch programming selector
FUNCTIONS	Economy, Clock, Weekly Program, Maximum Temperature Alarm, Sequential Heating Zones
SAFETY	by-pass safety valve, over-temperature automatic protection, emergency stop input alarm, glue pressure release, lid open alarm
OPTIONS	quick pressure release valve and flow regulation, integrated glue pattern control

GEAR PUMP SPECIFICATIONS

PUMP TYPE	gear single flow
PUMP MAXIMUM SPEED	3,0-7,0 cc/rev (80 rpm)
MAXIMUM PUMP RATE	14 kg/h (3,0 cc/rev pump) - 33 kg/h (7,0 cc/rev pump) (depending on used adhesive)
MOTOR SPECIFICATIONS	0,25 kW variable speed reduction gear 1:20 inverter-controlled
MAXIMUM WORKING PRESSURE	55 bar

© Copyright 2012 PREO SRL - All rights reserved - Subject to change without advanced notice - Printed in Italy - Edition EN-120 EASY U08 - 30/07/2012

PREO S.r.l.

Via Alessandro Volta, 7 • 20094 Corsico (MI) • Italia
tel. (+39) 02 48601260 • fax (+39) 02 4503323
www.preo.it • italia@preo.it • world@preo.it



YOUR
QUALITY
CHOICE