



Owner's Manual

VIVARO

Operation, Safety and Maintenance



VIVARO

VAUXHALL Vivaro

Operation, Safety, Maintenance

Data specific to your vehicle

Please enter your vehicle's data here to keep it easily accessible.

This information is available under the section "Technical data" as well as on the identification plate.

Fuel

Designation

Engine oil

Grade

Viscosity

Tyre inflation pressure

Tyre size
Summer tyres

Winter tyres

with up to 4 persons

Front Rear

Front Rear

with full load

Front Rear

front Rear

Weights

Permissible Gross Vehicle Weight

- EC kerb weight

= Loading

Your Vivaro

Your vehicle represents an intelligent synthesis of advanced technology, outstanding safety, environmental compatibility and economy.

It now lies with you to drive your vehicle safely and to see it performs perfectly. This Owner's Manual provides you with all the necessary information to that end.

Make sure your passengers are aware of the possible risk of accident and injury which may result from improper use of the vehicle.

You must always comply with the laws of the country in which you are travelling. These could differ from the information in this Owner's Manual.

The Owner's Manual should always be kept in the vehicle: ready to hand in the glove compartment.

Make use of the Owner's Manual:

- Its "In Brief" section will give you an initial overview.
- The table of contents at the start of the Owner's Manual and in each individual chapter will help you find your way.
- Its index will help you find what you want.
- It will familiarise you with the sophisticated technology.
- It will increase your pleasure in your vehicle.
- It will help you to handle your vehicle expertly.

The Owner's Manual is designed to be clearly laid-out and easily understood.

This symbol signifies:

▶ Continue reading on next page.

* The asterisk signifies equipment not fitted to all vehicles (model variants, engine options, models specific to one country, optional equipment, Genuine Vauxhall Parts and Accessories).

Warning

 **Warning** is used to mark text regarding possible risks of accident or injury. Failure to follow the instructions could lead to injury or loss of life. Inform vehicle passengers accordingly.

Yellow arrows in the illustrations serve as points of reference or indicate some action to be performed.

Black arrows in the illustrations indicate a reaction or a second action to be performed.

Thank you for choosing a Vauxhall. We wish you many hours of pleasurable driving.

Your Vauxhall Team

Contents

Commitment to customer satisfaction:

Our aim: to keep you happy with your vehicle. All Vauxhall Authorised Repairers offer first class service at competitive prices. Experienced, factory-trained technicians work according to factory instructions. Your Authorised Repairer can supply you with GENUINE VAUXHALL-APPROVED PARTS, which have undergone stringent quality and precision checks, and of course useful and attractive VAUXHALL-APPROVED ACCESSORIES.

Our name is your guarantee!

**For details of the
Vauxhall Authorised Repairer Network
please ring this number; 0845 090 2044**

| | |
|---|-----|
| In brief | 2 |
| Instruments | 20 |
| Keys, doors, bonnet | 37 |
| Seats, interior | 47 |
| Safety systems | 56 |
| Lighting | 75 |
| Windows..... | 79 |
| Heating, ventilation | 81 |
| Tecshift..... | 89 |
| Driving hints..... | 95 |
| Save fuel, protect the environment | 97 |
| Fuel consumption, fuel, refuelling..... | 99 |
| Catalytic converter, exhaust emissions | 102 |
| Drive control systems | 106 |
| Dropside body | 109 |
| Brakes..... | 113 |
| Wheels, tyres..... | 117 |
| Roof rack, caravan and trailer towing | 122 |
| Self-help | 125 |
| If you have a problem | 142 |
| Service plan, maintenance | 144 |
| Vehicle care | 157 |
| Technical data | 161 |
| Index..... | 174 |

In brief

Key numbers, Code numbers

Remove key number from key.

The key number is given in the vehicle papers and in the Car Pass *.

Immobilizer, radio *: the code numbers are given in the Car Pass and Radio Pass respectively.

Do not keep the Car Pass and Radio Pass in the vehicle.

► Further information - see pages 37, 38.



Unlocking the vehicle:
Direct remote control unit *
towards vehicle,
press button ,
pull door handle

The doors are unlocked.

To unlock mechanically: insert key and turn in driver's door lock and pull door handle.

To lock doors from inside, press central locking button * located on the lower dashboard.

► Door locks - see page 37,
electronic immobilizer - see page 38,
remote control - see page 39,
central locking system - see page 41,
anti-theft locking system - see page 43,
Vauxhall alarm system - see page 43.



Seat adjustment *:
Pull handle, slide seat,
release handle,
allow seat to audibly latch into position

Never adjust the driver's seat whilst driving. It could move in an uncontrolled manner when the handle has been pulled.

Warning

Important: Do not sit nearer than 10 inches (25cm) from the steering wheel, to permit safe airbag deployment.

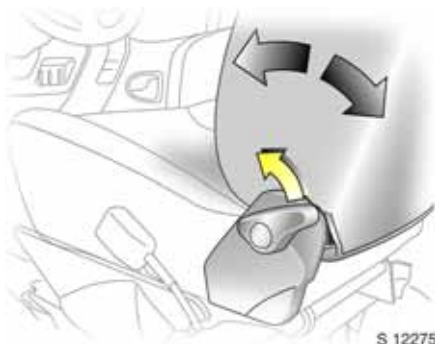

Adjusting the seat back: Pull release lever

Move seat back to suit seating position, it will lock in position when the lever is released.



Adjusting the lumbar support *: Turn handwheel

Adjust lumbar support to suit personal requirements.

Do not lean on seat backrest whilst adjusting it.



Adjusting arm rest support *:

Adjust arm rest support to suit personal requirements.

- Raise armrest in increments to desired height.
- To reposition, fully raise armrest before lowering.



**Adjusting seat height *:
Pull lever at side**

Lift lever and remove weight from seat to raise it or press down on seat with body weight to lower it.

Never adjust the driver's seat whilst driving. It could move in an uncontrolled manner when the lever has been pulled.

► Seat position – see page 47.

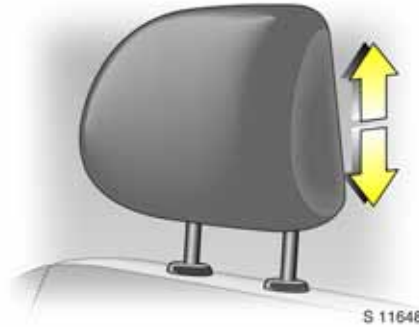

**Adjusting head restraint height:
hold firmly and adjust height,
then release**

► Head restraint position – see page 47, further information, removal – see page 48.

⚠ Warning

Disregard of these instructions may lead to injuries or endanger life. Vehicle passengers should be informed accordingly.

► Further information - see page 47.

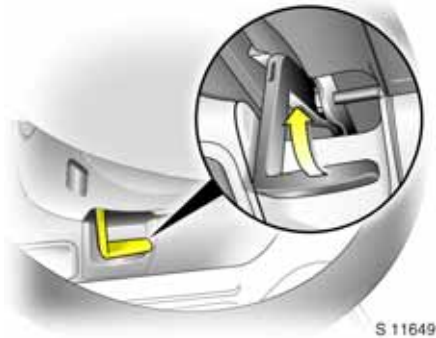

Steering wheel adjustment: Adjust position

Adjust the steering wheel only when the vehicle is stationary.

Move the unlocking lever upwards, adjust the wheel to the desired position, then release the lever.

Push the lever firmly downwards to ensure that the wheel is locked in position.

► Airbag systems - see page 61.



Fitting seat belt: Draw seat belt smoothly from inertia reel, guide over shoulder and engage in buckle

The belt must not be twisted at any point. The lap belt must lie snugly against the body. The backrest must not be tilted back too far (recommended tilting angle approx. 25°).

To release belt, press red button on belt buckle.

► Seat belts – see pages 57 to 59, airbag systems * – see page 61, seat position – see page 47.

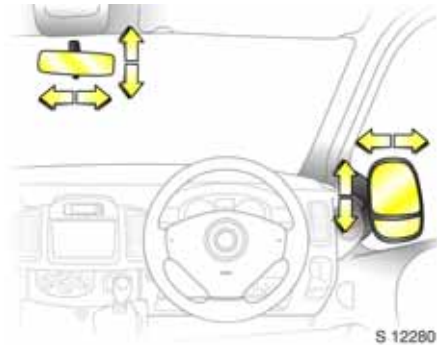

**Adjust interior * and exterior mirrors:
Swivel to appropriate position**

Move lever on underside of interior mirror housing to reduce dazzle at night.

► Further information - see page 74.

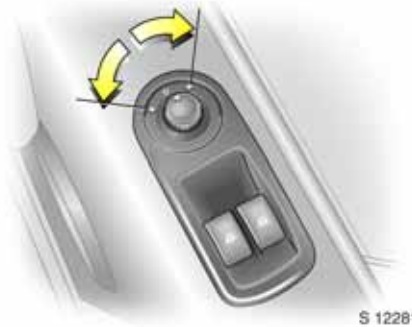

**Electrically adjustable exterior mirrors *:
Switch in door panel**

Operational with the ignition on or off.

Turn switch to left: switch operates left-hand mirror.

Turn switch to right: switch operates right-hand mirror.

Switch in central position: mirror adjustment is off.

The lower aspherical mirrors are not adjustable.



S 11653

Starter switch:

Diesel engine

- St = Ignition off
- A = Steering unlocked, ignition off
- M = Ignition on: preheat (page 17)
- D = Start - (transmission in neutral)

Petrol engine

- St = Ignition off
- A = Steering unlocked, ignition off
- M = Ignition on
- D = Start - (transmission in neutral)

► Electronic immobilizer - see page 38.



S 11654

Releasing the steering column lock:

To release the lock, move steering wheel slightly and turn key to position 'A'





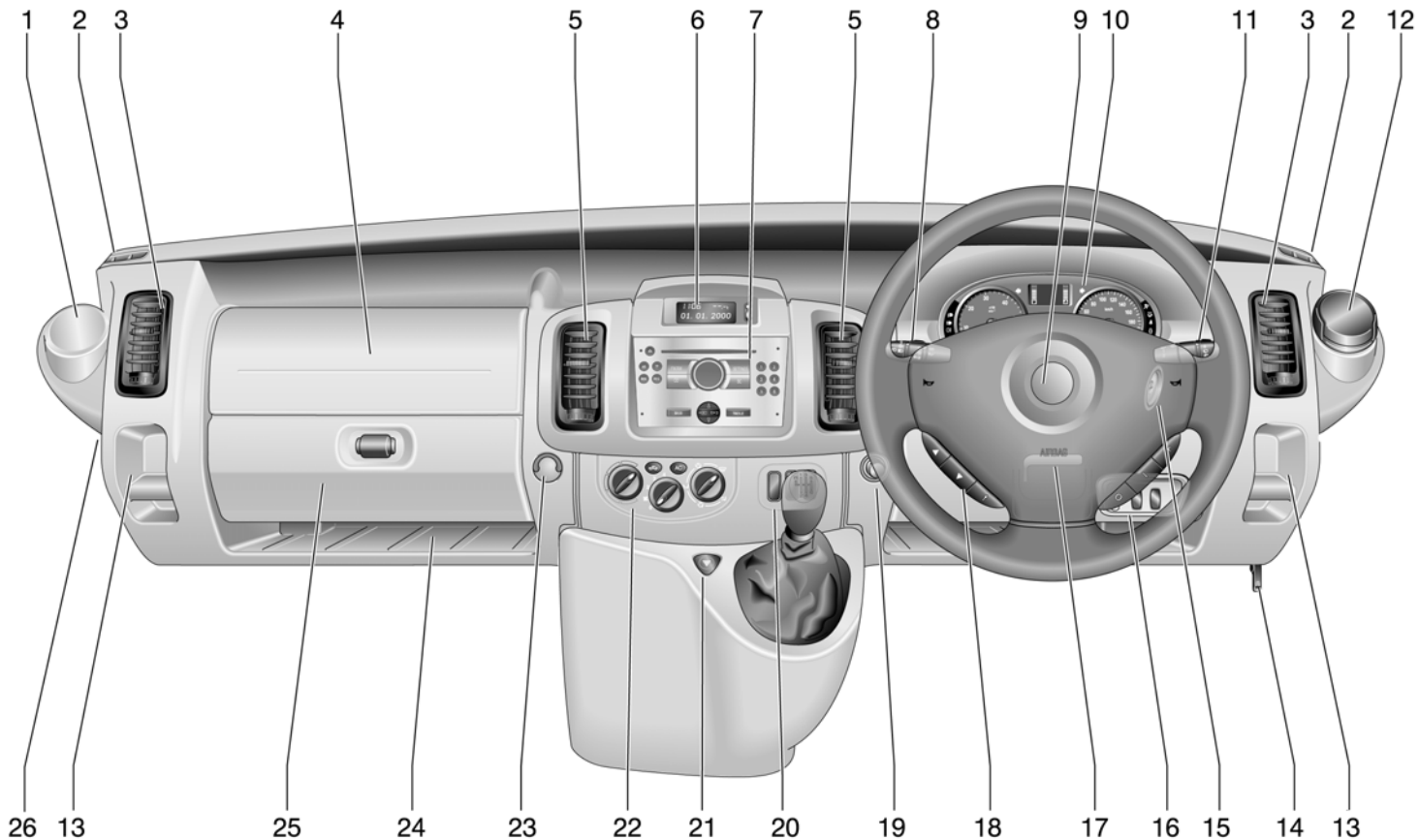





► Remove key and lock steering wheel - see page 18.











8 In brief







| | Page | | Page |
|----|------|----|--|
| 1 | 55 | 13 | Coin tray |
| 2 | 83 | 14 | Bonnet release lever 46 |
| 3 | 83 | 15 | Starter switch 7 |
| 4 | 61 | 16 | Switches for headlight range adjustment 76 ESP (Electronic Stability Program) * 106 Parking distance sensor * 107 |
| 5 | 82 | 17 | Steering wheel adjustment lever 5 |
| 6 | 29 | 18 | Infotainment controls * 35 |
| | 31 | 19 | Cigarette lighter 54 |
| 7 | 35 | 20 | Switches for central locking * 41 heated rear window * 87 Tecshift * winter and laden programme 91 |
| | 36 | 21 | Hazard warning switch 13 |
| 8 | 12 | 22 | Heating and ventilation controls 81 Rear air conditioning * 86 |
| | 13 | 23 | Utility hook |
| 9 | 61 | 24 | Storage tray |
| | 13 | 25 | Glove compartment |
| 10 | 20 | 26 | Fuse box 137 |
| 11 | 14 | | |
| | 26 | | |
| 12 | 55 | | |





Control indicators

-  Not used
-  **Headlight dipped beam:**
see pages 12, 75.
-  **Headlight main beam:**
see pages 12, 75.
-  **Fog tail light:**
see pages 12, 77.
-  **Front fog lights *:**
see pages 12, 77.
-  **Anti-lock brake system *:**
see page 115.
-  **Diesel particle filter *:**
see page 104.
-  **Stop engine:**
see page 21.
-  **Engine immobiliser:**
see pages 21, 38.
-  **Service *:**
see page 21.
-  **Turn signal lights:**
see pages 13, 76.









-  **Fuel level:**
see pages 21, 100, 163.
-  **ESP (Electronic Stability Program) *:**
see page 106.
-  **Engine electronics/Preheating system *:**
see page 17.
-  **Engine stop:**
see page 21.
-  **Alternator:**
see page 22.
-  **Oil pressure:**
see page 22.
-  **Brake system:**
see pages 22, 151.
-  **Airbag systems:**
see page 61.
-  **Front passenger airbag deactivation *:**
see page 65.
-  **Driver's seat belt:**
see page 57.

-  **Door open *:**
see pages 23.
-  Not used
-  **Engine electronics, Exhaust emissions:**
see page 23.
-  Not used
-  **Engine oil life monitor *:**
see page 29.









Tecshift *

-  **Winter programme:**
see page 91.
-  **Laden programme:**
see page 92.
-  **Transmission electronics:**
see page 94.
-  **Brake pedal application:**
see page 89.
-  **Automatic mode:**
see page 90.





Lighting

-  **Light switch:**
see pages 12, 75.
-  **Parking lights:**
see pages 12, 75.
-  **Dipped beam:**
see pages 12, 75.
-  **Main beam:**
see pages 12, 75.
-  **Front fog lights *:**
see pages 12, 77.
-  **Fog tail light:**
see pages 12, 77.
-  **Turn signal lights:**
see pages 13, 21.
-  **Hazard warning flashers:**
see page 13, 76.
-  **Headlight range adjustment:**
see page 76.







Heating and ventilation

-  **Fan switch:**
see page 82.
- Air distribution:**
see page 81,
 -  to head area
 -  to head area and to foot area
 -  to foot area
 -  to head area and to demister
 -  to demister
-  **Heated rear windows and mirrors *:**
see pages 17, 87.
- A.C** **Air conditioning system *:**
see page 85.
-  **Air circulation:**
see page 85.

Windscreen wiper

- Lever positions:**
see page 14,
 -  Timed interval wipe or automatic wiping with rain sensor *
 - 1** Slow
 - 2** Fast
 -  Windscreen wash
 -  Tailgate window wiper *
 -  Tailgate window wash *

Miscellaneous

-  **Horn:**
see page 13.
-  **Bonnet:**
see page 46.
-  **Cigarette lighter:**
see page 54.
-  **Central locking *:**
see page 41.
-  **Glove compartment cooler *:**
see page 86.
-  **Parking distance sensor *:**
see page 107.



S 11657

Light switch:

0 = Off

★ = Parking lights

☰☑☑ = Dipped or main beam

- ▶ Headlight warning device - see page 18,
- further information - see page 75,
- Automatic dipped beam activation *
- see page 76,
- headlight range adjustment - see page 76,
- headlights when driving abroad
- see page 78,
- daytime running lights * - see page 75.

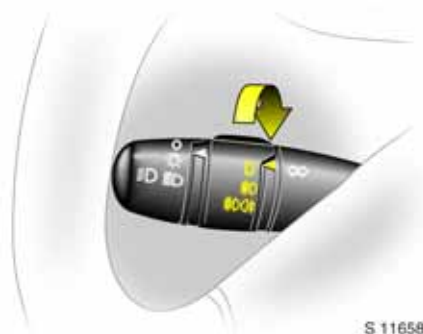

S 11658

Fog lights:

0 = Off

★☑ = On (front fog lights * only)

★☑☑ = On (front fog lights * and fog tail light)

The fog lights will only illuminate when the ignition and headlights are switched on.

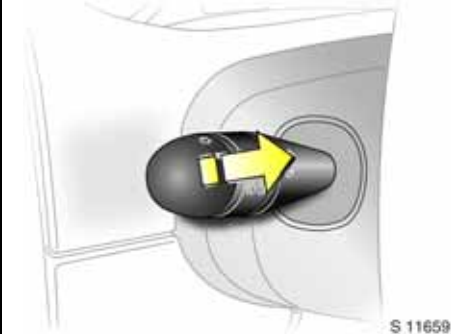

S 11659

Dipped and main beam:

Headlight flash:

Pull lever towards steering wheel

To change the headlight beam, pull the lever towards the steering wheel, then release when a click is felt.

Pulling the lever towards the steering wheel to the first stop operates the headlight flash.

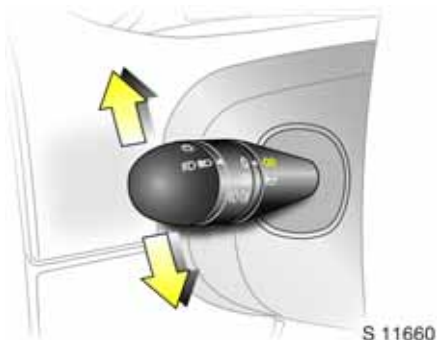

Turn signal lights:

Lever in rest position

Upwards = Right turn

Downwards = Left turn

When the steering wheel is turned back, the lever automatically returns to its original position. This will not happen when making a minor steering manoeuvre such as lane changing.

When lane changing, move lever part way to first stop. When released, lever will spring back.

For operation of the turn signal lights when towing - see pages 20 and 122.

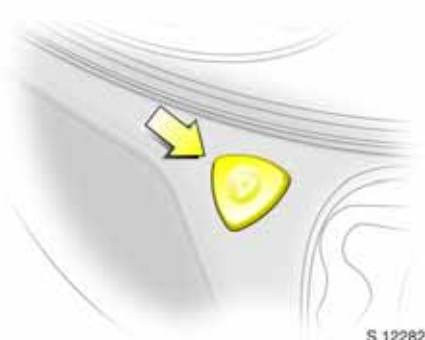

Hazard warning flashers:

On = Press button ▲

Off = Press ▲ again

When the hazard warning system is actuated, the button's control indicators flash in unison with the turn signal lights.



Horn:

Press any part of the steering wheel centre to activate the horn.



S 11663

Windscreen wiper:

Move lever downwards

 = Timed interval wipe

1 = Slow

2 = Fast

Return the lever to its original position to turn off.

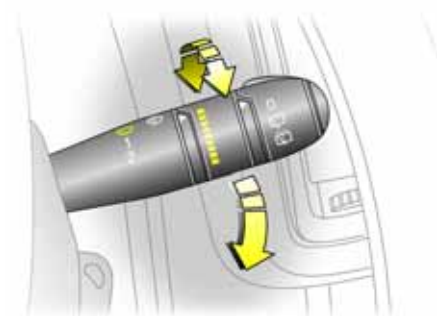

S 13020

Automatic wiping with

rain sensor :

Move lever downwards

 = Automatic wiping with rain sensor

1 = Slow

2 = Fast

The rain sensor detects the amount of water on the windscreen and automatically regulates the windscreen wiper frequency.

The sensitivity of the system can be adjusted by rotating the variable wiper:

Less sensitive = rotate down

More sensitive = rotate up

Upon starting the engine, automatic wiping will need to be reselected.

► Further information - see pages 153, 158.



S 11664

Windscreen wash system:

Pull lever towards steering wheel

Short pull

The wiper operates for one cycle.

Long pull

Wash fluid is sprayed onto the windscreen, at the same time the wiper is operated for four cycles.

Check regularly that the windscreen wash system is operating efficiently.

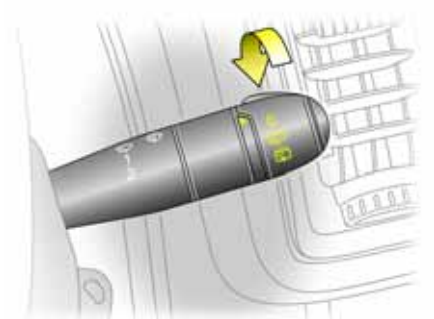

On vehicles with rain sensor , keep the sensor area clean.

► Further information - see page 153.



Back door and tailgate window wash wipe system *:

Rotate switch

- 0** = Off
-  = Wiper
-  = Wash

Wash fluid is sprayed onto the window when the lever is moved to the second position. The switch is spring loaded and will return to the 'wiper' position when released.

Check regularly that the window wash system is operating efficiently.

► Further information - see page 153.

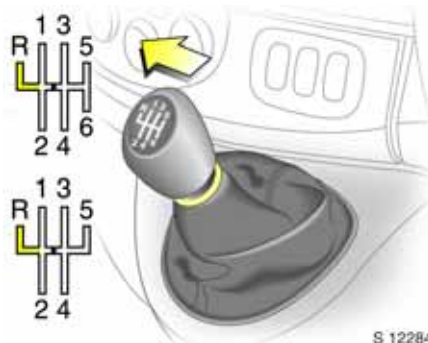

Manual transmission:

- = Neutral
- 1 to 5/6 = 1st to 5th or 6th * gear
- R = Reverse gear

When shifting up from 4th to 5th gear, pressure must be exerted towards the right at the beginning of the shift operation.

When shifting from 5th to 4th gear, do not exert any force towards the left.

Reverse gear: with vehicle stationary, declutch, pull up collar and move shift lever to the left against resistance.

If the gear does not engage: with lever in neutral, release clutch pedal and depress again, then repeat gear selection.

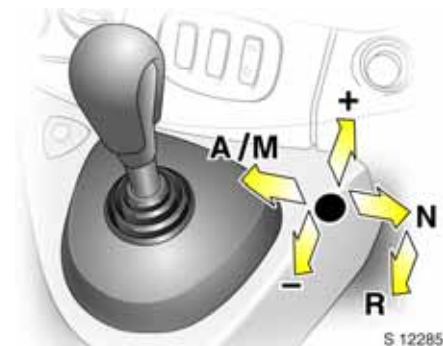

Tecshift *:

- N = Neutral
- = Centre position
- = Shift to lower gear
- + = Shift to higher gear
- A/M = Switch between automatic or manual mode
- R = Reverse

The selector lever must be moved in the appropriate direction as far as it will go. Upon release, it automatically returns to the centre position. Pay heed to the gear / mode indicator in the transmission display.

► Further information - see page 89.

Before driving check:

- Tyre pressures and condition.
- Engine oil level and fluid levels in engine compartment (see pages 145 to 148).
- All windows, mirrors, exterior lighting and number plates free from dirt, snow and ice and operational.
- Objects are securely located and will not be thrown forward in the event of sudden braking.
- Seats, seat belts and mirrors correctly adjusted.
- Brake operation.

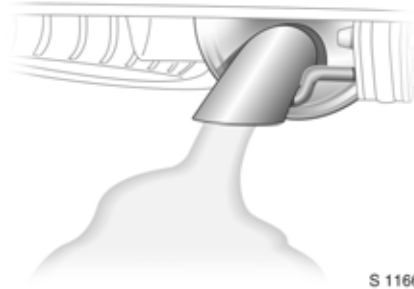

Exhaust gases are poisonous

Exhaust gases contain carbon monoxide, which is extremely poisonous but has no odour or colour.

Therefore, never inhale exhaust gases, and never run the engine in an enclosed space.

You should also avoid driving with the doors open, as exhaust gases could enter the passenger compartment.

- ▶ Exhaust gas - see page 105.



**Starting, petrol engine:
Transmission in neutral
Depress clutch
Do not accelerate
Turn key to D**

The increased engine speed automatically returns to normal idling speed as the engine temperature rises.

- ▶ Electronic immobilizer - see page 38, further information - see pages 96, 97, 99.

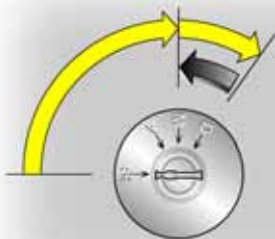

S 11670

Starting, diesel engine:
Transmission in neutral
Depress clutch
Do not accelerate
Turn key to M
When preheating control indicator goes out ¹⁾,
turn key to D

► Electronic immobilizer - see page 38,
 further information - see pages 96, 97, 99.

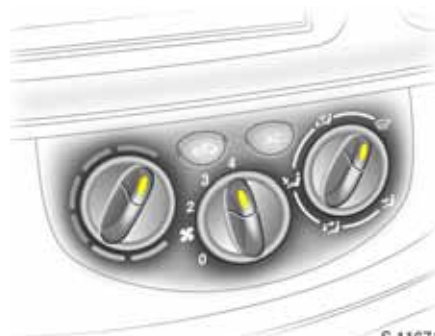

S 11671

Drying misted-up or iced-up windows:
Set the temperature switch to red
and fan to position 4,
set air distribution to 

Close centre ventilation jets; open side ventilation jets and direct them towards the door windows.

► Heating, ventilation - see page 81,
 air conditioning system - see page 85.



S 12286

Heated rear windows *,
heated exterior mirrors *

Press  = On
 Press  again = Off

► Further information - see page 87.

¹⁾ Preheating system switches on only if outside temperature is low.

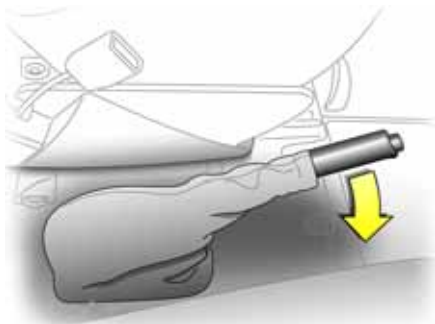

S 11673

Releasing the hand brake:
Raise lever slightly,
press lock button,
lower lever fully

Drive carefully, economically and with the environment in mind. While driving, do not do anything that could distract you.

Warning buzzers

While driving:

- Operating the indicators.
- Illumination of low fuel control indicator.
- Tecshift ✱, high clutch temperature.
- Seat belt not fastened ✱.

When the vehicle is parked and driver's door is opened:

- Headlights switched on.
- Tecshift ✱: neutral not selected, foot brake not depressed or handbrake not applied.

► Driving hints - see page 95,
 Save fuel, protect the environment - see page 97.

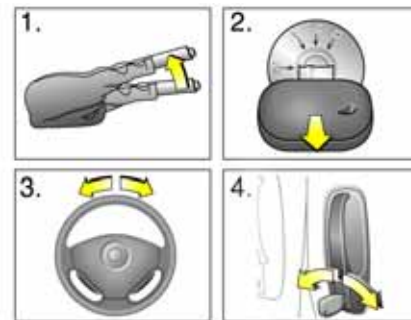

S 12267

Parking the vehicle:
Apply hand brake firmly
Close windows
Switch off engine
Remove key
Engage steering wheel lock
Lock doors

► Further information - see pages 38, 96,
 remote control - see page 39,
 central locking system - see page 41,
 Vauxhall alarm system - see page 43.

Advice when parking:

- Always apply hand brake firmly. Engage first gear or reverse gear. On slopes apply the hand brake as far as it will go.
- Turn steering wheel until lock is felt to engage (anti-theft protection).
- Switch off exterior lights, otherwise the headlight warning device will sound when the driver's door is opened.
- Cooling fans may run on after the engine has been switched off.
- Do not park vehicle on easily ignitable surfaces as the hot exhaust system could cause the surface to ignite.

Service work, maintenance

We recommend that you entrust all work to your Vauxhall Authorised Repairer, who can provide you with reliable service and correctly perform all work according to factory instructions.

Vauxhall Service - see page 142.

Genuine Vauxhall Parts and Accessories

We recommend "Genuine Vauxhall Parts and Accessories" and conversion parts released expressly for your vehicle type.

These parts have undergone special tests to establish their reliability, safety and specific suitability for your vehicle. Despite continuous market monitoring, we cannot assess or guarantee these attributes for other products, even if they have been granted approval by the relevant authorities or in some other form.

"Genuine Vauxhall Parts and Accessories" and conversion parts approved by Vauxhall can be obtained from your Vauxhall Authorised Repairer, who can give advice about permitted technical changes and correct installation.

Warning

Carry out regularly the checks recommended in this Owner's Manual.

Ensure that your vehicle is serviced at the service intervals specified in the Service Booklet. We recommend that you entrust this work to your Vauxhall Authorised Repairer.

Have faults remedied without delay! Consult a workshop. We recommend your Vauxhall Authorised Repairer. If necessary, interrupt your journey.

► Maintenance - see pages 144 to 155.

That was a brief overview of the most important information for your first drive in your Vivaro.

Your vehicle has still more instruments and controls, possibly also optional equipment.

The remaining chapters of the Owner's Manual contain important information on operation, safety and maintenance as well as a complete index.

Instruments

| | |
|--|----|
| Control indicators | 20 |
| Tachometer..... | 23 |
| Speedometer..... | 23 |
| Fuel gauge | 24 |
| Coolant temperature gauge..... | 24 |
| Multifunction display | 25 |
| Electronic odometer/clock *..... | 26 |
| Trip computer * | 26 |
| Engine oil life monitor *..... | 29 |
| Triple information display *..... | 29 |
| Colour information display *, selecting functions | 31 |
| Radio *..... | 35 |



S 13464

Control indicators

The control indicators described here are not present in all vehicles. The description applies to all instrument versions.



Not used



Headlight dipped beam

Lights up when dipped beam is on.



Headlight main beam

Lights up when main beam is on and when headlight flash is operated.



Fog tail light

Lights up when the fog tail light is switched on.



Front fog lights *

Lights up when front fog lights are switched on.



Anti-lock brake system

see page 115.



Diesel particle filter *

Lights up when regeneration of diesel particle filter is required - see page 104.



Not used

**ESP (Electronic Stability Program) ***

see page 106.

**Engine oil life monitor ***

See page 29.

**Tecshift Laden programme ***

Control indicator illuminates in transmission display when Laden programme is enabled - see page 92.

**Tecshift foot brake application ***

see page 89.

**Tecshift electronics ***

Lights up briefly when ignition is switched on. Illuminates in transmission display when fault has occurred - see page 94.

**Tecshift automatic mode ***

Control indicator illuminates in transmission display when automatic mode is selected - see page 90.

**Tecshift Winter programme ***

Control indicator illuminates in transmission display when Winter programme is enabled - see page 91.

**Turn signal lights**

Flashes when turn signal lights are on.

Flashes rapidly: a turn signal bulb has failed.

An audible warning can be heard when the turn signal lights are on. When towing a caravan or trailer, the pitch of the audible warning changes.

STOP

Stop engine

If lights up in conjunction with , , or , stop engine immediately and consult a workshop. We recommend your Vauxhall Authorised Repairer.

**Engine immobilizer**

If the indicator flashes when the ignition is on, there is a fault in the immobilizer system; the engine cannot be started - see page 38.

**Service / engine electronics ***

If lights up in conjunction with or , interrupt your journey. Consult a workshop. We recommend your Vauxhall Authorised Repairer.

**Preheating/Fuel filter/Engine electronics**

Lights up briefly during engine preheating.

If illuminated constantly it indicates:

- The presence of water in the diesel fuel filter *. Drain fuel filter of residual water, see page 149.
- An electronic system failure, consult a workshop. We recommend your Vauxhall Authorised Repairer.

**Fuel level**

If it lights up: fuel level low, fill up.

Never let the tank become empty!

With diesel engines it is not possible to start the engine after the tank has been run empty. The fuel system must be bled first.



Engine stop

Will light up in conjunction with STOP engine if coolant temperature is too high. Stop vehicle - consult a workshop. We recommend your Vauxhall Authorised Repairer.



Alternator

Lights up when ignition is switched on. Goes out after engine is started.

If illuminated during driving: Stop vehicle and switch off engine. The battery is not being charged and the engine cooling may be interrupted. The brake servo unit may cease to be effective. Interrupt your journey, consult a workshop. We recommend your Vauxhall Authorised Repairer.



Oil pressure

Lights up when ignition is switched on. Goes out after a short period of time. Can light up intermittently when idling with hot engine; must go out when engine speed is increased.

If illuminated during driving: Engine lubrication may be interrupted, resulting in damage to the engine and/or locking of the driving wheels:

- Depress clutch.
- Move gear shift lever to neutral.
- Switch off ignition (to position A). Considerably greater force will be required for braking and steering.

Warning

Do not remove key until vehicle has come to a standstill, otherwise the steering column lock could engage unexpectedly.

Consult a workshop. We recommend your Vauxhall Authorised Repairer.



Brake system

Lights up when ignition is switched on if hand brake is applied and/or fluid level for brake hydraulics is too low.

Warning

If it lights up when the hand brake is not applied: stop vehicle; interrupt your journey immediately. Consult a workshop. We recommend your Vauxhall Authorised Repairer.

► Further information - see page 113.



Airbag *

see page 61.



Front passenger airbag deactivation *

Lights up when the ignition is switched on and remains illuminated when the front passenger airbag has been deactivated.

If illuminated in conjunction with or , consult a workshop. We recommend your Vauxhall Authorised Repairer.

► Further information - see page 65.

**Driver's seat belt**

Lights up when ignition is switched on and if driver's seat belt is not engaged.

Seat belts, see page 57.

**Door open ***

Operational only when ignition is switched on. Lights up when driver's, passenger's or side loading doors are open.



Not used.

**Exhaust emissions ***

Control indicator lights up when ignition is switched on. Goes out shortly after engine starts.

If it lights up when the engine is running: Fault in emission control system. The permitted emission limits may be exceeded. Consult a workshop. We recommend your Vauxhall Authorised Repairer.

If it flashes when the engine is running: For fault that can lead to destruction of the catalytic converter, see page 102. Consult a workshop immediately. We recommend that you consult your Vauxhall Authorised Repairer.

LPG

Not used

**Tachometer**

Making use of the tachometer helps to save fuel; it indicates the engine speed in revolutions per minute.

Warning zone on right: maximum permissible engine speed exceeded, danger to engine.

If possible, drive in each gear in the low engine speed range (between approx. 2000 and 3000 rpm) and maintain an even vehicle speed.

**Speedometer**

Indicates the vehicle speed.

Certain vehicle variants feature a speed regulator *¹⁾ which restricts the vehicle maximum speed. As a visible indication of this, a warning label is located on the instrument panel.

¹⁾ Depending on driving environment (e.g. when descending steep inclines) the vehicle speed can exceed set limits. In such instances it remains the driver's responsibility to adhere to the specific speed limits.



Fuel gauge

Display of fuel level:

Illumination of bars displays fuel level.

When gauge indicates fuel supply low, fuel warning  illuminates = fill up.

See page 99.

Never let tank become empty!



Coolant temperature gauge

Display of coolant temperature:

Bars illuminated in lower area = Engine operating temperature not yet reached

Bars illuminated up to central area = Normal operating temperature

Bars illuminated into uppermost zone or indicator  illuminates * = Temperature too high. Stop vehicle, switch off engine. Danger to engine. Check coolant level immediately. See page 150.

For physical reasons, the coolant temperature gauge shows the coolant temperature only if the coolant level is adequate.



Multifunction display

Transmission display *

Display of the selected gear and mode with Tecshift *.

- N** Neutral or idling position.
- R** Reverse gear.
- A** Automatic mode.
- kg** Laden programme.
- ⚙️** Winter programme.
- 🚫** Foot brake application.
- ⚡** Transmission electronics.



Oil level display *

The oil level display is correct only if the vehicle is parked on level ground with a cold engine. The oil level display will only be reset if the ignition has been switched off for more than two minutes.

If "oil" appears in the display the oil level may need topping up. To gain a more accurate indication of the oil level, press and hold the reset button - see page 28.

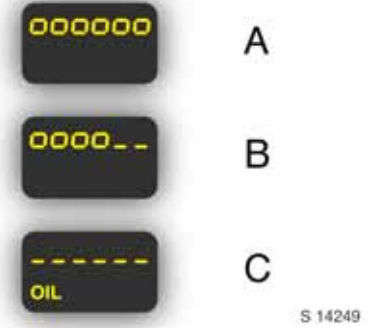

The squares that appear on the display indicate the level. As the oil level diminishes, the squares in the display disappear and are replaced with dashes.

- A:** Maximum level
- B:** Intermediate level
- C:** Minimum level = check and top up engine oil¹⁾

¹⁾  illuminates if oil level is too low.

To return to the normal display, press the reset button again.

Checking and topping up fluids - see page 145.



S 12293

Electronic odometer/clock *

Normal mode:

The odometer and clock are visible.

Reset:

The reset button is located alongside the speedometer. Press button once to display the trip odometer.

Press the button and hold, the display will flash and after 1 second will reset to zero. Press the button again to return the odometer to normal mode.

Clock adjust mode:

With the display in normal mode press and hold the button, and the minutes reading will begin to increase.

After the button is released the clock will continue to flash for a further 5 seconds to enable further adjustments to be made.



S 11684

Trip computer *

In addition to the electronic odometer functions, the trip computer can also display additional monitored vehicle data;

- Fuel used,
- Average consumption,
- Instantaneous consumption,
- Range,
- Distance travelled,
- Average speed.

Pressing the selection switch located on the end of the windscreen wash control lever will cycle through these displays.



S 12295

Fuel used

Displays the amount of fuel consumed since the last reset. The measurement can be restarted at any time – see page 28.

**Average consumption**

Is displayed, taking into consideration the distance travelled and the fuel used since the last reset. The measurement can be restarted at any time - see page 28.

**Instantaneous consumption**

The value is displayed after reaching a speed of 15 mph (25 km/h).

**Range**

The range is calculated from the current contents of the fuel tank and the average consumption since the last reset - see page 28.



Distance travelled

Displays the distance driven since the last reset. The measurement can be restarted at any time.



Average speed

The average speed is displayed, since the last reset. The measurement can be restarted at any time.

Stoppages in the journey with the ignition off are not included in the calculations.



Reset current trip computer information

The following trip computer information can be reset:

- Fuel used,
- Average consumption,
- Range,
- Distance travelled,
- Average speed.

To reset the trip computer, select one of its functions then press and hold the reset button, the display will flash and after 1 second will reset.

Interruption of power supply

If the power supply has been interrupted or if the battery voltage has dropped too low, the values stored in the trip computer will be lost.



S 13465

Engine oil life monitor*

Each time the ignition is switched on, the remaining distance before the next engine oil and filter change is due may be shown in the display for approx. 5 seconds.

Within 1 800 miles (3 000 km) of the next engine oil change being due, the remaining distance and  will be displayed for approx. 30 seconds as a reminder. Make an appointment with a workshop for service work as soon as possible. We recommend your Vauxhall Authorised Repairer.

► Further information - see page 105.



S 11692

Triple information display*



Display for time, outside temperature, radio/date.

When the ignition is off, the time, date and outside temperature can be made to appear for approx. 15 seconds by briefly pressing one of the two buttons beside the display.













S 11693

Setting date and time

Switch off radio. Press  and  beside display as follows:

Press  for approx. 2 seconds:

Day flashes

- : Set day
- : Month flashes
- : Set month
- : Year flashes
- : Set year
- : Hours flash
- : Set hours
- : Minutes flash
- : Set minutes
- : Clock starts at 0 seconds.

If only the time is to be set, repeatedly press  with display in setting mode until hours/minutes flash.

Automatic date and time setting *



Possible in the case of radio reception from RDS stations¹⁾ which broadcast a time signal.

Automatic setting is carried out once the radio has been switched on and a RDS time signal has been received. The setting is indicated by  in the display. If no time signal is received, or the time signal is inaccurate, the date and time must be set manually.

Deactivating and activating the automatic setting function (e.g. if an inaccurate time signal is received from the broadcasting station):

Press  for approx. 2 seconds; the time display is now in setting mode.

Press  twice (until year flashes).

Press  for approx. 3 seconds until  in display flashes and the display “RDS TIME” appears (years flash while button is depressed).

Press  Display indicates:
 RDS TIME 0 = Deactivated
 RDS TIME 1 = Activated

Press  three times.

Fault display

Display --.-°C or an F in the display indicates a fault. Have the cause eliminated, consult a workshop. We recommend your Vauxhall Authorised Repairer.

Interruption of power supply

If the power supply has been interrupted or if the battery voltage has dropped too low, the date and time must be reset.

When the battery has been reconnected or charged, set the date and time as described under “Setting date and time”. In the case of radios with RDS , the time is set automatically when the radio is receiving an RDS station which broadcasts a time signal (see page 30).



Outside temperature

A fall in temperature is indicated immediately and a rise in temperature after a time delay.

| |
|--|
|  Warning |
| Caution: The road surface may already be icy even though the display indicates a few degrees above 0 °C. |

If the external temperature falls to 3 °C, to warn of ice on the road the symbol  appears on the Triple Info display.

When the temperature climbs, the symbol  goes out above 5 °C.

¹⁾ RDS = Radio Data System.



In vehicles with colour information display *, a warning message appears in the display as a warning for icy road surfaces. There is no message below -5 °C

Warning

Caution: The road surface may already be icy even though the display indicates a few degrees above 0 °C.



Colour information display *, selecting functions

Functions and their menus are depicted in the information display.

These functions are marked or executed in the menu display via the cross switch, the multifunction knob * on the Infotainment System or buttons * on the steering wheel.

To select with four-way button:

Select menu items via menus and with the buttons/four-way button of the Infotainment system.



Selection with the multifunction knob *:

Turn Mark menu items or commands, select functions.

Press Select marked item, confirm command.

To exit a menu, turn the multifunction button left or right to **Return** or **Main** and select.



Selection using buttons * on steering wheel:

Select menu options via menus and with the buttons.

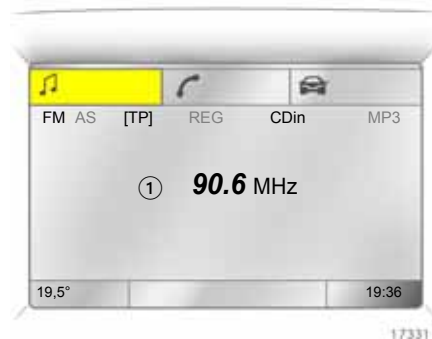

For each functional area there is a main page (Main), which is selected at the top edge of the display (not with the Infotainment system CD 30):

- Audio
- Navigation *

Function areas audio and navigation *
– see Infotainment System Instructions.



System settings

The settings are accessed via the **Settings** menu.

Press the **Main** button * (not found on all Infotainment systems) on the Infotainment system (call up main display).

Press the **Settings** button on the Infotainment system. For Infotainment system CD 30, no menu may be selected.

The **Settings** menu is displayed.

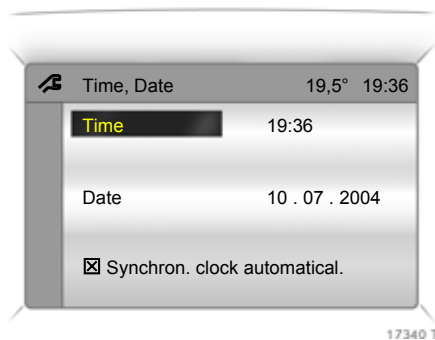

Setting date and time

Select menu item **Time, Date**, from the **Settings** menu.

The menu for **Time, Date**, is displayed.

Select the menu items required:

Make the desired setting.

Correcting time ✱

Some RDS transmitters¹⁾ do not send correct time signals. If the incorrect time is frequently displayed, deactivate automatic time synchronisation ✱ and set the time manually.

To correct time with the help of RDS, select menu item **Synchron. clock automatical.** from the **Time, Date**, menu.

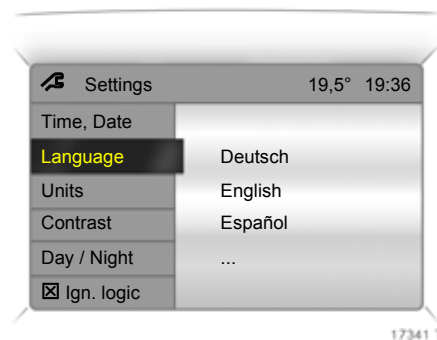

Language selection

You can select the display language for some functions.

Select menu item **Language** from the **Settings** menu.

The available languages are displayed.

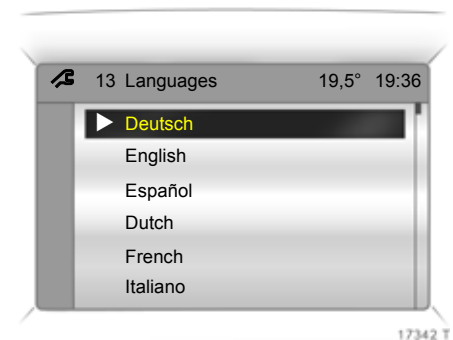

Select the desired language.

Selections are indicated by a ► in front of the menu item.

In systems with voice output ✱, when the language setting of the display is changed the system will ask whether the announcement language should also be changed – see Infotainment system instructions.

¹⁾ RDS = Radio Data System.



Setting units of measure

You can select which units of measure are to be used.

Select menu item **Units** from the **Settings** menu.

The available units are displayed.

Select the desired unit.

Selections are indicated by a ● in front of the menu item.

Setting display mode *

The display can be adapted to light conditions: Dark coloured text on a light background or light coloured text on a dark background.

Select menu item **Day / Night** from the **Settings** menu.

The options are displayed.

Automatic: Adapted based on vehicle lighting.

Always day design: Dark coloured text on light background.

Always night design: Light coloured text on dark background.

Selections are indicated by a ● in front of the menu item.

Ign. logic *

See Infotainment system instructions.

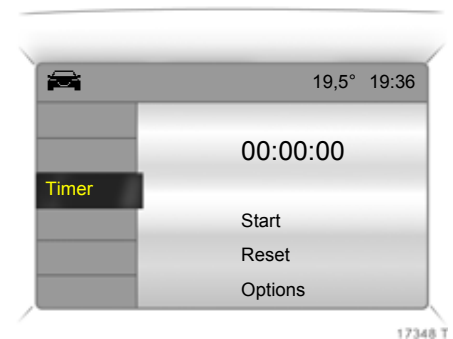

Stop watch *

Press **BC** button on the infotainment system

The **Timer** menu is displayed.

To start, select menu item **Start**.

To reset, select menu item **Reset**.

The stop watch information to be displayed can be selected via menu

Options ✱:

Driving Time excl. Stops

Measurement of the time the vehicle is in motion. Stationary time is not included.

Driving Time incl. Stops

Measurement of the time the vehicle is in motion. The time the vehicle is stationary with the key in the ignition switch is included.

Travel Time

Measurement of the time from manual activation via **Start** to manual deactivation via **Reset**.

Radio ✱

The radio is operated as described in the operating instructions supplied.

Vehicle radio reception will differ from that obtained with domestic radios.

As the vehicle antenna is relatively near the ground, the broadcasting companies cannot guarantee the same quality of reception as is obtained with a domestic radio using an overhead antenna.

- Changes in distance from the transmitter
 - Multi-path reception due to reflection and
 - Shadowing
- may cause hissing, noise, distortion or loss of reception altogether.



Steering wheel mounted remote control ✱

Radio and infotainment system functions can be operated by the buttons mounted on the steering wheel.

The radio ✱ and infotainment system ✱ are operated as described in the respective operating instructions supplied.



Electronic tachograph *

The tachograph is operated as described in the operating instructions supplied.

Observe regulations regarding use.

Infotainment and navigation systems *

The systems are operated as described in the operating instructions supplied.

The navigation system is supplied with a CD or DVD detailing the local territory.

For additional countries/territories, separate CD's or DVD's are available from your Vauxhall Authorised Repairer.

Mobile telephones and radio equipment (CB) *

The Vauxhall installation instructions and the operating guidelines provided by the telephone manufacturer must be observed when fitting and operating a mobile telephone. Failure to do so could invalidate the vehicle's operating permit (EU Directive 95/54/EG).

Requirements to ensure trouble-free operation:

- Professionally installed exterior aerial to obtain the maximum range possible
- Maximum transmission power 10 W
- Installation of the telephone in a suitable spot (see note on page 66).

Obtain advice on predetermined installation locations for the external antenna and equipment holder and ways of using devices with transmission power of more than 10 Watts. We recommend that you consult your Vauxhall Authorised Repairer, who will have consoles and various installation kits and install them in accordance with regulations.

Use a hands-free attachment if you must use your phone while driving. Even with a handsfree attachment, the telephone could distract you from the traffic situation. Follow the national regulations of the country in which you are driving.

Warning

When used in the vehicle interior, mobile telephones and radio equipment (CB) with integrated antenna may cause malfunctions in the vehicle electronics.

Mobile telephones and radio equipment (CB) should only be used with an antenna fitted on the vehicle exterior.

Keys, doors, bonnet

Replacement keys 37
 Door locking and unlocking..... 37
 Child safety lock 37
 Electronic immobilizer 38
 Radio frequency remote control *... 39
 Central locking system * 41
 Mechanical anti-theft locking system * 43
 Vauxhall alarm system *..... 43
 Sliding side doors *..... 44
 Back doors *..... 45
 Tailgate * 45
 Bonnet release 46

Replacement keys

The key is a constituent of the electronic immobiliser. Ordering keys from a Vauxhall Authorised Repairer guarantees problem-free operation of the electronic immobiliser.

Keep the spare key accessible in a safe place.

Locks - see page 160.

Door locking and unlocking

From outside:

Pull the outside handle to open the front door.

remote control * - see page 39,
 central locking system * - see page 41,
 anti-theft locking * - see page 43.

From inside:

Pull the inside lever to open the front door.

The door can be locked or unlocked by pushing the lock button * or using the central locking switch * - see page 42.

To prevent the driver from being inadvertently locked out, the front doors cannot be locked when they are open.

The tailgate can be opened by pushing down the tailgate interior release * .

► Further information - see page 2.



Child safety lock

The child safety lock for the sliding side door * is located on its rearward facing edge.

| |
|--|
|  Warning |
| <p>Use the child safety lock whenever children are occupying the rear seats *. Disregard may lead to injuries or endanger life. Vehicle passengers should be informed accordingly.</p> |

To engage, turn knob from the vertical position: anti-clockwise for right hand side door or clockwise for left hand side door. Door cannot then be opened from inside.



Electronic immobilizer

The system checks whether the vehicle may be started using the key that has been inserted. If the key is recognised as "authorised" the vehicle can be started. The check is carried out via a transponder housed in the key.

The electronic immobiliser is automatically activated when the key is removed from the ignition switch.



Control indicator for immobilizer

The control indicator lights up when the ignition is switched on then goes out.

If the control indicator flashes rapidly after the ignition is switched on, there is a fault in the immobilizer system.

- Turn ignition off and remove key,
- wait approximately two seconds,
- then repeat starting procedure.

If the control indicator fails to extinguish, try to start the engine using the spare key. Obtain assistance from a workshop. We recommend that you consult your Vauxhall Authorised Repairer.

Note

The immobilizer does not lock the doors. Therefore, after leaving the vehicle, always lock it and switch on the Vauxhall alarm system ✱.

The Car Pass contains all the vehicle's data and therefore must not be kept in the vehicle.

Have your Car Pass ready to hand when consulting a Vauxhall Authorised Repairer.

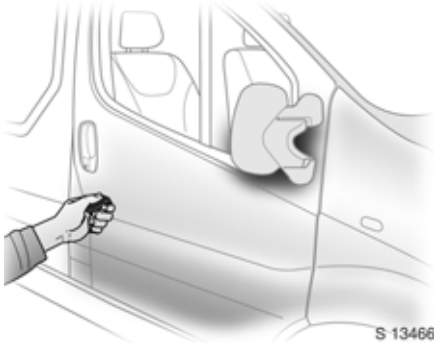

Radio frequency remote control *

The remote control is used to operate the central locking system *.

Depending on model the vehicle may use a remote control with two or three buttons (selective door locking).

The remote control has a range of approx. 3 metres. The range may be reduced owing to shadowing and reflection of the radio waves. To operate the remote control, direct the remote control unit at the vehicle.



For your convenience we recommend that the central locking system is always operated using the remote control unit.

Treat the remote control unit with care; it should be protected against moisture and should not be operated unnecessarily.

Central locking system *
see page 41.

Mechanical anti-theft locking system *
see page 43.

Vauxhall alarm system *
see page 43.

Note

If the central locking system * cannot be operated with the remote control, this may be due to the following reasons:

- The remote control is out of range.
- The battery voltage of the remote control is too low. Change the battery in the remote control unit.
- The remote control has been operated too many times in succession outside the vehicle's reception range (e.g. at too great a distance from the vehicle).

The remote control must be reprogrammed, we recommend your Vauxhall Authorised Repairer.

- Interference from higher power radio waves from other sources.

Lock or unlock the doors manually using the key or central locking switch. Manual locking does not operate the central locking system. Have cause of fault remedied. We recommend that you consult your Vauxhall Authorised Repairer.



Changing the battery in remote control unit

Replace the battery in accordance with the Service Booklet or when the range of the remote control starts to become reduced.

Two function remote control unit:

Open the battery compartment by inserting a coin into the slot and twisting.

Ensure the new battery is installed correctly.

Replace the cover and press until it is fully engaged.



Selective door locking remote control unit

Open the battery compartment by removing the screw on the rear cover, then inserting a coin into the slot and twisting.

Ensure the new battery is installed correctly.

Replace the cover and press until it is fully engaged, then replace and secure screw.

Make sure that you dispose of old batteries in accordance with environmental protection regulations.



S 13026

Central locking system *

For front, side and back doors *, tailgate * and fuel filler flap *. With selective door locking *, the passenger compartment and rear load compartment are locked and unlocked separately.

To unlock - two function remote control:

Press button on remote control unit:

- Hazard warning lights flash once.
- Doors are unlocked.

To unlock - selective door locking:

Press button on remote control unit:

- Hazard warning lights flash once.
- Doors of the passenger compartment only are unlocked.

To lock - two function remote control:

Press button on remote control unit:

- Hazard warning lights flash twice.
- Doors are locked.

To lock - selective door locking:

Press button on remote control unit:

- Hazard warning lights flash twice.
- Passenger compartment doors only are locked.

Always ensure that the side door *, tailgate * or back doors are properly closed before locking the vehicle with the remote control.

⚠ Warning

For safety reasons, the vehicle cannot be locked if the ignition key is in the ignition.

Manually locking or unlocking a door with the key does not operate the central locking system.

For manual operation of the fuel filler flap - see page 101.



S 13078

Rear load compartment doors/tailgate - selective door locking

To unlock

Press button on remote control unit.

If no door is opened within 30 seconds (approximately) after the vehicle has been unlocked by the remote control the vehicle is re-locked automatically.



To lock

Press button on remote control unit. The rear load compartment doors / tailgate are now locked.



Central locking switch *

Use the central locking switch to lock or unlock the doors from inside the vehicle.

Press  on the switch to lock or  on the switch to unlock.

Automatic locking *

The central locking system can be activated to automatically lock the doors as soon as a speed of approximately 4 mph (6 km/h) is reached.

To activate

With the ignition switched on, press  on the central locking switch and hold for approx. 5 seconds, until audible confirmation is heard.

To deactivate

With the ignition switched on, press  on the central locking switch and hold for approximately 5 seconds, until audible confirmation is heard.

Unlocking the door

The doors are unlocked by opening any door from inside the vehicle or by operating the central locking switch.

⚠ Warning

If a rear door is opened, it will automatically be relocked when the vehicle reaches a speed of approx. 4 mph (6 km/h).

Fault

In the event of a fault e.g. automatic locking doesn't take place, ensure all the doors have been properly closed. Check to ensure that the automatic locking function has not been deactivated inadvertently. If this is the case, switch the ignition off and on again and reactivate the system as described previously.

If the automatic locking function still fails to operate we recommend that you contact your Vauxhall Authorised Repairer.

⚠ Warning

If you decide on having the system active (with the doors closed) whilst driving, it may become difficult for those assisting you in gaining access to your vehicle in the event of an emergency.

Slam door locks *

For certain Van models¹⁾ the sliding side door and back door locks are isolated for added security.

Whilst the front doors are locked and unlocked using the remote control key in the normal way, the sliding side door and back door can only be opened by manual operation of the vehicle key.

¹⁾ Not available with deadlock option.

Mechanical anti-theft locking system *

To lock:

All doors must be closed; press the  button on the remote control unit again within 10 seconds after locking. Hazard warning lights flash 5 times.

-or-

turn key in driver's door lock towards front of vehicle again within 10 seconds after locking, then turn it back to the vertical position and remove.

Lock buttons * on all doors are positioned such that doors cannot be opened.

Warning

Do not use the system if there are people in the vehicle! The doors cannot be unlocked from inside.

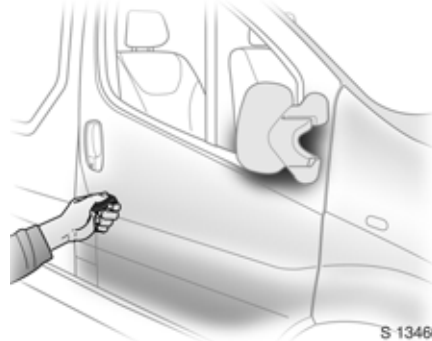

To unlock:

Press  button on remote control unit. Hazard warning lights flash once.

-or-

turn key in driver's door lock towards rear of vehicle, then turn it back to the vertical position and remove.

Warning

Unlocking is not possible in any other way, so keep spare key to hand in a safe place!

Vauxhall alarm system *

The system monitors:

- Front and side doors.
- Back doors or tailgate *, bonnet.
- Passenger compartment.
- Ignition switch.
- Siren power supply *.

The remote control unit is used to operate the Vauxhall alarm system.

To activate

All doors must be fully closed; press the  button on the remote control, the turn signal indicators flash twice. If the turn signal indicators do not flash on activation, this may indicate that a door or the bonnet is not fully closed.

To deactivate

Press the  button on the remote control, the turn signal indicators flash once.

If the alarm has been triggered, the turn signal indicators will not flash upon deactivation.

When unlocking the vehicle using the key, the alarm will sound; to deactivate, insert the key and switch on the ignition.

Note

The Vauxhall alarm system cannot be deactivated in any other way so keep a spare key in a safe place.

Alarm

During a switch-on phase the sensors can trigger a maximum of 10 times¹⁾.

The alarm takes the form of:

- an acoustic signal (horn, 25 seconds) and
- a visual signal¹⁾ (turn signal indicators, 25 seconds).

¹⁾ Varies from country to country on account of national regulations.

Passenger compartment monitoring

When the anti-theft alarm is activated, the system automatically monitors the inside of the vehicle for movement.

To disable the passenger compartment monitoring, (for example if an animal is left in the vehicle):

- Press and hold the  button on the remote control.
- An audible beep will sound to confirm that the passenger compartment monitoring function is disabled.

The disable monitoring function will remain until the alarm is deactivated or the doors unlocked.

Alarm back-up system *

The alarm system has a battery back-up siren unit which, in the event of its power supply being disconnected or disconnection of the vehicle battery, will sound for approx. 5 minutes on its internal batteries.

If the vehicle battery has to be disconnected it will be necessary to deactivate the alarm system.



To stop the siren if activated, reconnect the vehicle battery and press the rear  button on remote control unit.



Sliding side doors *

Open the door by pulling the outside handle, or by pulling the interior lever to the rear, then sliding the door rearwards.

To close the door, slide it fully forwards and ensure it is fully closed.

The door can be locked or unlocked with the remote control , the central locking switch  or by the interior lock switch.

Ensure the side door is closed before driving the vehicle.

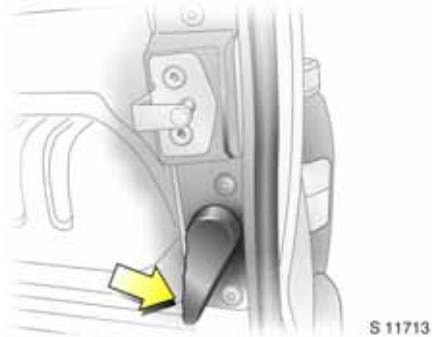

Back doors *

The doors can be locked or unlocked with the remote control *, the central locking switch *, or the key *.

To open the left-hand back door pull the outside handle. The door is opened from inside the vehicle by pulling the interior handle.

The right-hand rear door is released using the lever (arrowed).

Warning

The rear lights may be obscured if the rear doors are open and the vehicle is parked on the roadside. You should make other road users aware of your vehicle, by using a warning triangle or other equipment specified by your country's road traffic regulations.

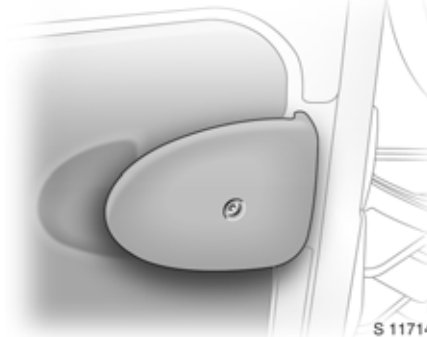

The doors are retained in the 90° position by locking stays.

To open the doors to 180° or further *, pull the door release handles and swing open to the desired position.

Warning

Ensure extended opening doors * are secured when fully opened.

Opened doors may slam closed due to the force of the wind!

Always close the right-hand door before the left-hand door.



Tailgate *

To open: press button and lift tailgate to fully open position.

In very cold climates, the opening assistance provided by the tailgate hydraulic struts may be reduced.

The tailgate can be locked or unlocked with the remote control *, the central locking switch *.

Warning

Ensure there is adequate clearance both above (at least 2.15 m) and behind when opening tailgate.

Close tailgate using the interior strap. Ensure tailgate is fully closed.



Bonnet release

To open the bonnet, pull the release lever located on the left-hand side below the instrument panel. The bonnet will then be unlocked and will partially open. Return release lever to its original position.

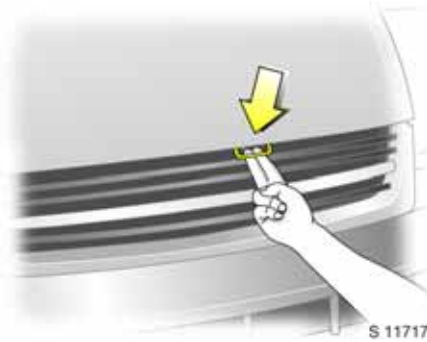

To open completely, locate the safety catch, located slightly to the right of centre - as viewed from the front - pull the catch and lift the bonnet.

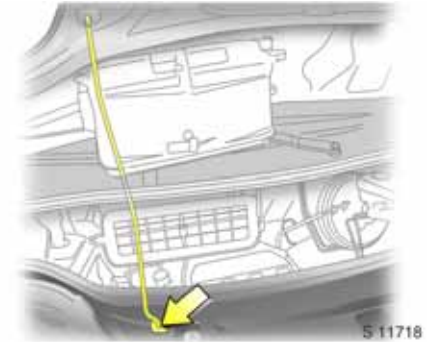

To hold bonnet in the open position, insert the support rod, located on the underside of the bonnet, into the slot provided.

Before closing bonnet, press the support rod firmly into its retainers. Lower bonnet gradually to be finally dropped by its own weight.

Check that the bonnet is locked in position by pulling at its front edge. If it is not locked in position, repeat closing procedure.

Seats, interior

Seat position 47
 Head restraints 48
 Rear seats *..... 48
 Load compartment net *..... 51
 Load compartment cover *..... 51
 Lashing eyes * 52
 Load anchorage rails *..... 52
 Notes on loading the vehicle..... 53
 Cigarette lighter  *..... 54
 Ashtray * 55
 Drink holders..... 55
 Over-cab storage area *..... 55

Seat adjustment

see page 2

Seat position

Adjust driver's seat such that with the driver sitting upright the steering wheel is held in the area of its upper spokes with the driver's arms slightly bent.

The seat backrests must not be tilted too far back (recommended tilting angle approx. 25°).

| |
|---|
|  Warning |
| Disregard can lead to injuries which could be fatal. Vehicle passengers should be informed accordingly. |

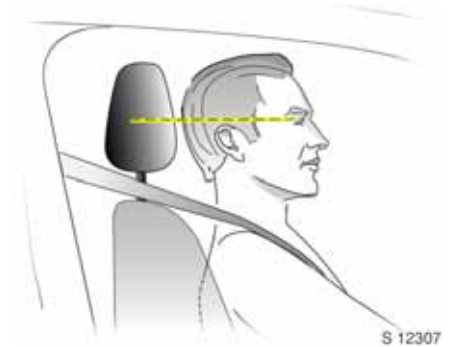

Head restraint position

The centre of the head restraint should be at eye level. Adjust to highest position if this is not possible for extremely tall people, and adjust to lowest position for extremely small people.

| |
|---|
|  Warning |
| Disregard can lead to injuries which could be fatal. Vehicle passengers should be informed accordingly. |

Setting – see page 4.

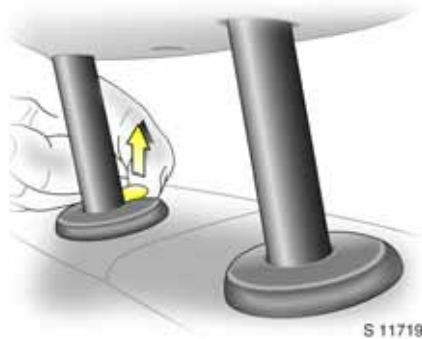

Head restraints

Adjustments - see page 4.

To remove the head restraints, pull lock tab and pull the restraint upwards.



Rear seats *

On some variants, the rear passenger compartment offers storage in the seat trims.

To enable long items to be stored under the seats the centre seat trim cover * can be unclipped.

The load capacity can be increased further by folding or removing the rear seats *.



When folding or removing the rear seat ensure the arm rests * are folded away in their most upright position. Also remove the lower seat trim side pockets * disconnecting them from the locating clips.



S 11722

Rear seat access ✳

To facilitate access to the rear seats, fold the seat backrest forwards. If necessary release the two-latch seat belt from its buckles.

⚠ Warning

Ensure that the backrest returns to its correct position and the seat belt buckles engage securely - see page 58.



S 11723

Folding seats ✳

On some variants, the cargo area can be increased by folding up the rear seats.

Remove the head restraints. Pull the side handle to release the backrest and fold forward onto the seatbase, if necessary releasing the two-latch seat belts from their buckles.

Release both locking bars at the rear base of the seat by pulling rearwards.

Lift and fold the seat assembly, until the seat frame rests in place.

⚠ Warning

When folding the seat use caution - beware of moving parts. Ensure the seat is secure when completely folded.

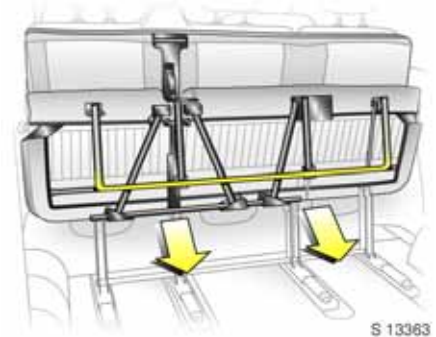

S 13363

To return the folding seat to the upright position, support the seat assembly and release the bar by pulling the bar directly towards you. Gradually lower the seat assembly, allowing the rear support legs to fold down. Lower the seat completely, ensuring the rear support legs are located, and latched. Raise the backrest, reinstall head restraints and connect the seat belts.

⚠ Warning

When installing the seat, ensure that the seat is properly located on the anchor points and that the locking catches are fully engaged, the backrest is returned to the correct position and the seat belts are engaged securely.

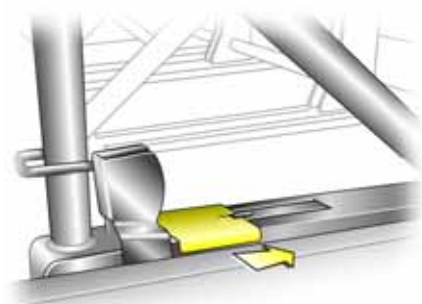

S 13276

Removable rear seats *

On some variants, the cargo area can be increased by removing the rear seats.

Release the seats by pressing down and sliding forward the locking catch located on the left and right hand seat mountings.

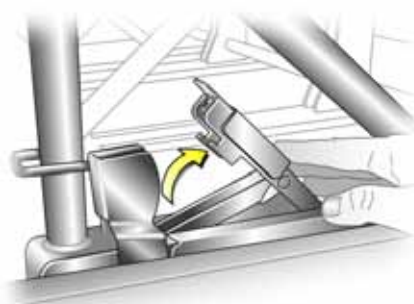

S 13287

With both catches raised, push the seat unit towards the rear and release them from the floor anchor points. The seat can then be lifted out.

The seats must be removed through the sliding door only.

⚠ Warning

Removable seats are heavy! Do not attempt to remove without assistance.

When installing the seats, ensure that the seats are properly located on the anchor points and that the locking catches are fully engaged.

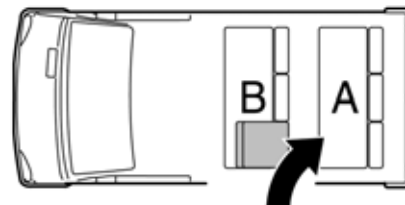

S 12309

⚠ Warning

When re-installing seats always ensure that the row with the folding access seat **B** is positioned correctly in front of the fixed seat row **A**.

If the seats are incorrectly positioned, access for passengers is seriously impeded. Disregard of these instructions may endanger life.

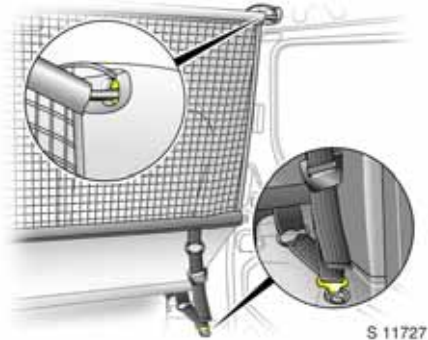

Load compartment net *

The load compartment net can be fitted behind the front or rear seats to separate compartments when transporting luggage or animals.

Installing (front or rear position)

Lift the covers to access the mountings, insert the load compartment net rod into the mounts and secure. Attach the straps to the lashing eyes behind the front seats; or to the rings on the rear seat frame, then tension the straps.

Removing

Tilt strap length adjuster upwards and unhook strap.

Warning

Loose objects in the luggage compartment should be secured safely.

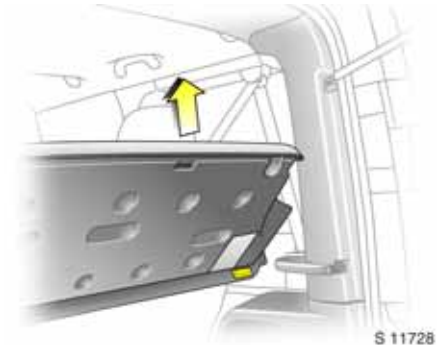

Load compartment cover *

To remove:

Lift cover and disconnect from the side guides.

Notes on loading

See page 53.

Warning

Do not place any heavy or sharp objects on the cover.

Loose objects in the load compartment should be secured safely.

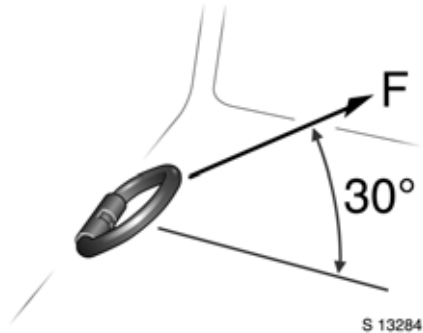

Lashing eyes *

Lashing eyes are mounted in the load compartment to enable cargo to be secured in position using lashing straps * or a luggage net *.

The maximum force applied to the lashing eyes should not exceed 5000 N at 30°.

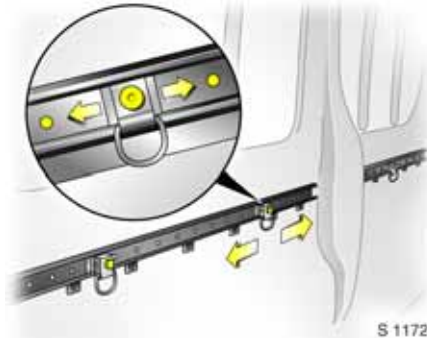

Load anchorage rails *

Load anchorage rails * mounted in the load compartment, provide adjustable anchorage points for securing cargo.

- release centre pin of the anchorage point, by pulling out against spring tension
- slide the anchorage point to the required location
- position the anchorage point directly over the nearest suitable "locking hole"
- release the centre pin of the anchorage point, ensuring the pin is located correctly and the anchorage point is securely locked

- cargo can then be secured in position using lashing straps * attached to the anchorage point

The maximum load of each anchorage point is 75 kg. To prevent the possibility of exceeding this maximum, the use of ratchet type lashing straps is to be avoided.

Warning

Loose objects in the luggage compartment should be secured safely.

Notes on loading the vehicle

- Heavy objects in the load compartment should be placed as far forward as possible. If objects are to be stacked, the heavier objects should be placed at the bottom. Unsecured objects in the load compartment would be thrown forward with great force in the event of heavy braking, for example.
- Secure heavy objects with lashing straps * attached to the lashing points. If heavy loads slip when the vehicle is braked heavily or driven around a bend, the handling of the vehicle may change.
- The warning triangle * and first aid kit * should always be freely accessible.
- No objects should be placed on the instrument panel. They are reflected in the glass, obstruct the driver's view and will be thrown through the vehicle in the event of heavy braking, for example.
- No objects should be stored in any of the airbag * inflation zones, as injuries may be caused when the airbag is triggered.
- Bulky objects should not be transported with the back doors open or ajar, otherwise poisonous exhaust fumes may enter the vehicle. In addition, the number plate is only distinguishable and lit correctly if the doors are closed.
- Weights, payload and roof load - see page 164.
- Driving with a roof load (see also page 95) increases the sensitivity of the vehicle to cross-winds and has a detrimental effect on vehicle handling owing to the higher centre of gravity of the vehicle.

 **Warning**

Disregard of these instructions may lead to injuries or endanger life. Vehicle passengers should be informed accordingly.



Cigarette lighter $\underline{\text{e}}$ *

With ignition switched on, press the cigarette lighter. Heating up ceases once element is glowing. Withdraw lighter.

Accessory socket

The socket for the cigarette lighter can be used to connect electrical accessories when the ignition is switched on.



An additional accessory socket * is located in the rear of the vehicle.

When the engine is not running using these accessory sockets will cause the battery to be discharged.

The maximum power requirement of electrical accessories must not exceed 120 watts.

Do not connect any current-delivering accessories, e.g. electrical charging devices or batteries.

Connected electrical accessories must comply with the EC standard in terms of electromagnetic compatibility requirements laid down in DIN VDE 40 839, otherwise vehicle malfunctions may occur.

The use of non-authorized accessories may cause damage to the socket.



Ashtray *

Removable to enable universal use for driver or passengers.

To be used only for ash and not for combustible rubbish.

Warning

Disregard of these instructions may lead to injuries or endanger life. Vehicle passengers should be informed accordingly.

To open: lift up the cover.

To empty: remove the ashtray from the drink holder recess and empty.

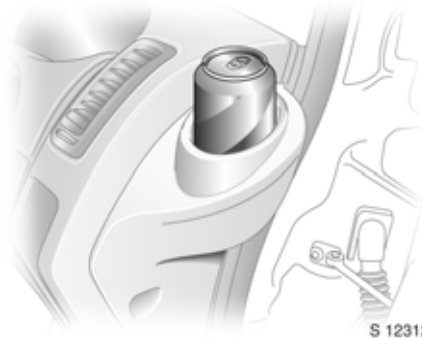

Drink holders

To use drink holders remove the ashtray unit.

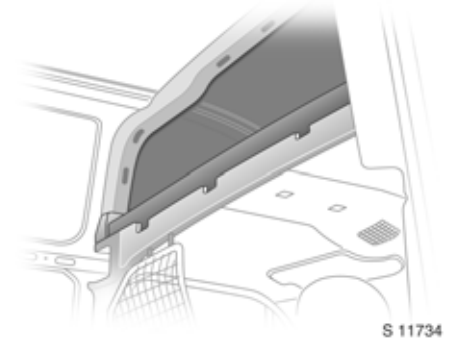

Over-cab storage area *

The total weight in this compartment must not exceed 30 kg.

Safety systems

Three-stage restraint system..... 56
 Seat belts..... 57
 Belt tensioners *..... 59
 Airbag systems * 61
 Child restraint systems * 68
 Exterior mirrors..... 74
 Aspherical exterior mirror 74
 Sun visors..... 74
 Head restraints 74
 Safety accessories * 74

Three-stage restraint system

The system comprises

- three-point seat belts
- belt tensioners on the front seats
- airbag systems for driver and front passenger *.

The three stages are activated in sequence depending on the seriousness of the accident:

- The automatic seat belt locking devices prevent the belt strap from being pulled out and thus ensure that the vehicle occupants are retained in their seats.
- The front seat belt buckles are pulled downwards. As a result, the seat belts are instantaneously tightened and the occupants are made aware of the deceleration of the vehicle at a very early stage. This reduces stress placed on the body.
- The airbag system is additionally triggered in the event of a serious accident involving a frontal impact and forms a safety cushion for the driver and front passenger *. The side airbag system * protects the occupants in the front of the vehicle in the event of side-on collisions.

Warning

The airbag system serves to supplement the three-point seat belts and belt tensioners. The seat belts must therefore always be worn. Disregard of these notes can lead to injuries which may be fatal. Vehicle passengers should be informed accordingly.

Be sure to read the detailed descriptions of all the restraint systems on the following pages!

Seat belts

Warning

Always wear your seat belt - and that means also in urban traffic and when you are a rear seat passenger. It can save your life!

Pregnant women too must always wear a seat belt.

In the event of an accident, persons not wearing seat belts endanger their fellow occupants and themselves.

Seat belts are designed to be used by only one person at a time. They are only suitable for children aged up to 12 or smaller than 150 cm if used in conjunction with a child seat.

Three-point seat belts

The vehicle is equipped with three-point seat belts with automatic retractors and locking devices, allowing freedom of body movement although the spring tensioned belts are always a snug fit.

The belt has a “vehicle sensitive retractor” which is designed to lock during heavy acceleration or deceleration in any direction.



S 12279

Using the belts

Fitting the belt

Pull the belt out evenly from the retractor and guide it across the body, making certain that it is not twisted.

Insert the latch plate into the buckle. The seat backrest must not be tilted back too far; the recommended angle of inclination is approx. 25°. The lap belt must not be twisted and must fit snugly across the body. Tension the belt frequently whilst driving by tugging the diagonal part of the belt.



S 12314

Warning

On pregnant women in particular the lap belt must be positioned as low as possible across the pelvis in order to prevent pressure on the abdomen.

Bulky clothing prevents the belt from fitting properly. The belt must not rest against hard or fragile objects in the pockets of your clothing (e.g. ballpoint pens, keys, spectacles) because these could cause injury. Do not place any objects (e.g. handbags) between the belt and your body.



Upper anchorage point height adjustment *

- Do not adjust height whilst driving
- Slide adjuster up or down to desired position

Adjust height such that the belt passes over the wearer's shoulder and rests against the shoulder. It must not pass over the neck or upper arm.



Removing the belt

To remove the belt, depress the red push-button on the buckle; the belt will retract automatically.



Two-latch belt *

Before fitting the belt, first insert lower latch plate into the buckle on the outside of the seat.

The belt can now be used in the same way as a standard seat belt.

⚠ Warning

The seat belt will not be effective in the event of an accident if the lower latch is not correctly fitted.

When releasing the seat belt, ensure that the central buckle is always released before the buckle on the side of the seat.

Always remove the lower latch plate from the outside buckle before removing seats from the vehicle or to facilitate access to the rear seats * - see page 48.

Inspection of belts

Periodically inspect all parts of the belt system for damage and to make sure they are functioning properly. Have damaged parts replaced. After an accident, overstretched belts must be replaced by new ones. We recommend consulting your Vauxhall Authorised Repairer.

Do not perform any alterations on the belts, their anchorages, the automatic retractors or the belt buckles.

Make sure that belts are not damaged or trapped by sharp-edged objects.

**Belt tensioners ***

The seat belt systems incorporate belt tensioners. In the event of a head-on or tail-end collision the belt buckles are pulled downwards; the diagonal and lap belts are instantaneously tightened.

Actuation of belt tensioners

The belt tensioners must be replaced after activation. We recommend that you consult your Vauxhall Authorised Repairer.

Warning

The belt tensioners are operational only when the control indicator is unlit.

The seat belts remain fully operational even when the belt tensioners have been actuated.



Belt tensioner control indicator

The seat belt tensioners are monitored electronically together with the airbag, and their operational readiness shown by the control indicator in the instrument panel. When the ignition is switched on, the control indicator lights up, then extinguishes. If it does not light up or if it lights up during driving, there is a fault in the airbag system or the belt tensioners (see also page 64).

Warning

Have the cause of the fault remedied. We recommend that you consult your Vauxhall Authorised Repairer.

The system's integrated self-diagnostics allows faults to be quickly remedied. Have Car Pass on hand when consulting a Vauxhall Authorised Repairer.

Important

- Accessories not released for your vehicle type and other objects must not be fixed or placed within the action zone of the belt tensioners as they may result in injury if the belt tensioners are triggered.
- Do not make any modifications to the components of the belt tensioners, as this will render the vehicle unroadworthy.

Warning

Improper handling (e.g. removal or installation) can activate the belt tensioners – risk of injury.

- The belt tensioner and airbag system control electronics can be found in the centre console area. In order to avoid malfunctions, do not store magnetic objects in this area.
- We recommend that you have the front seats removed by a Vauxhall Authorised Repairer.
- The belt tensioners only actuate once. Please replace belt tensioners that have been triggered. We recommend that you consult your Vauxhall Authorised Repairer.
- When disposing of the vehicle, please observe the applicable safety regulations. Please have the vehicle disposed of by a disposal company. We recommend that you consult your Vauxhall Authorised Repairer.



S 12283

Airbag systems ✱

Front airbag

The front airbag system is identified by the word “Airbag” on the steering wheel and above the glove compartment ✱.

The front airbag system comprises:

- an airbag with an inflator in the steering wheel, and a second one above the glove compartment ✱
- the control electronics with impact sensor
- the airbag system control indicator  in the instrument panel.
- Front passenger airbag deactivation ✱

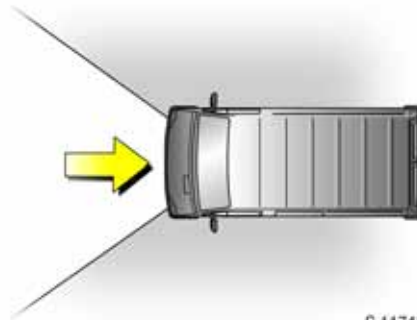

S 11741

The front airbag system is triggered:

- depending on the severity of the accident
- depending on the type of impact
- within the range shown in the illustration
- independently of the side airbag and curtain airbag systems ✱.

Examples:

- Impact against a non-yielding obstacle: the front airbag is triggered at low vehicle speed.
- Impact against a yielding obstacle (such as another vehicle): the front airbag is only triggered at a higher vehicle speed.

When triggered, the driver’s airbag and front passenger airbag ✱ inflate in milliseconds and form safety cushions for the driver and front passenger. The forward movement of the driver and front passenger is checked and the risk of injuries to the upper body and head thereby substantially reduced.

- No impairment of view will occur, because the airbags inflate and deflate so quickly.

Warning

The front airbag system provides optimum protection when the seat, backrest and head restraint are correctly adjusted. Adjust the driver's seat according to the occupant's height such that with the driver sitting upright, the steering wheel is held in the area of its upper spokes with the driver's arms slightly bent. The passenger seat should be as far back as possible, with the backrest upright. Do not place the head, body, hands or feet on the cover of the airbag system.

Do not place any objects in the area in which the airbags inflate.

The three-point seat belt must be correctly fitted (see page 57).



The front airbag system will not be triggered in the event of

- the ignition being switched off
- minor frontal collisions
- accidents in which the vehicle overturns
- collisions involving a side or rear impact where it would not be of benefit to the occupants.

Warning

Seat belts must therefore always be worn. The front airbag system serves to supplement the three-point seat belts. If you do not wear your seat belt you risk being seriously injured, or even thrown from the vehicle, in the event of an accident.

The belt helps to keep you in the correct seating position, in which the front airbag system will provide you with effective protection in the event of an accident.



Side airbag *

The side airbags are mounted on the outboard sides of the front seat backrests to protect the occupants in the event of a severe side impact.

The side airbag system comprises:

- an airbag with inflator in the back of the driver's and front passenger's seat respectively
- the control electronics
- side impact sensors
- the airbag systems control indicator  in the instrument panel.

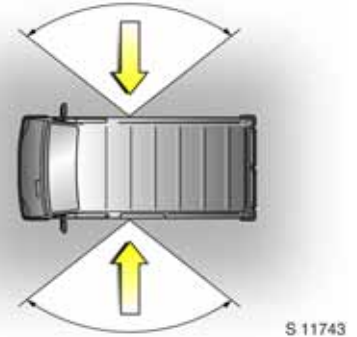

The side airbag system will be triggered:

- depending on the severity of the accident
- depending on the type of impact
- within the range shown in the illustration
- independently of the front airbag system.

When triggered the side airbag inflates in milliseconds and forms a safety cushion for driver and/or front passenger in the respective door area. The risk of injury to the upper body in the event of a side impact is thereby substantially reduced.

⚠ Warning

There must be no objects in the area in which the airbag inflates or in the area between the seat backs and the vehicle body. Do not place the hands or arms on the covers of the airbag systems. Important information - see page 66.

The three-point seat belt must be correctly fitted - see page 57.

The side airbags will not be triggered in the event of:

- the ignition being switched off,
- frontal collisions,
- accidents in which the vehicle overturns,
- collisions involving a rear impact,
- collisions involving a side impact outside the passenger cell.



Curtain airbag ☼

The curtain airbag system is identified by the badge **AIRBAG** on the head lining trim.

The curtain airbag system comprises:

- an airbag with inflator in the roof frame on the driver's and passenger's side respectively,
- the control electronics,
- the side impact sensors,
- the airbag systems control indicator  in the instrument panel.

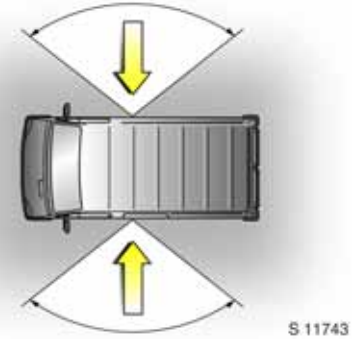

The curtain airbag system will be triggered:

- depending on the severity of the accident,
- depending on the type of impact,
- within the range shown in the illustration,
- together with the side airbag system,
- independently of the front airbag system.



When triggered the curtain airbag inflates within milliseconds and provides a safety barrier in the head area on the respective side of the vehicle. This reduces the risk of injury to the head considerably in case of a side impact.

Warning

There must be no objects in the area in which the airbag inflates. Do not place the hands or arms on the covers of the airbag systems. Important information – see page 66.

The three-point seat belt must always be correctly fitted – see page 57.

The curtain airbags will not be triggered in the event of:

- the ignition is switched off,
- frontal collisions,
- accidents in which the vehicle overturns,
- collisions involving a rear impact,
- collisions involving a side impact outside the passenger cell.



Airbag control indicator *

The front airbag system, side airbag system * and curtain airbag system * are monitored electronically together with the belt tensioners, and their operational readiness shown by the control indicator in the instrument panel. When the ignition is switched on, the control indicator lights up then extinguishes. If it does not light up, or if it lights up during driving, there is a fault in the airbag systems or the belt tensioners.

The systems might not be triggered in the event of an accident.

Warning

Have the cause of the fault remedied. We recommend that you consult your Vauxhall Authorised Repairer.

The system's integral self-diagnosis facility allows faults to be quickly remedied. Have your Car Pass ready to hand when consulting a Vauxhall Authorised Repairer.



S 12830

Front passenger airbag deactivation ✱

Front and side airbag systems must be deactivated if a child restraint system is to be mounted on the front passenger seat. The belt tensioners as well as all airbag systems for the driver's seat remain active when the front passenger seat's systems are disengaged.

The switch for deactivating or activating the airbag system is located on the front passenger door.

The chosen setting remains active after the ignition has been switched off. The control indicator  for front passenger airbag deactivation is located in the instrument panel.

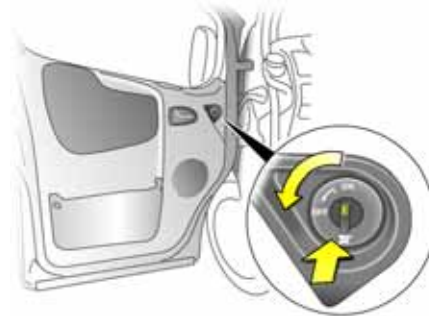

S 13469

To deactivate

With the front passenger door open, press switch in and rotate anti-clockwise to "OFF" position.

The airbag systems for the front passenger seat are now deactivated.





S 13670

With the ignition switched on the control indicator  will remain illuminated to indicate deactivation. It is now safe to place a child seat on the front passenger seat.



To activate:



With the front passenger door open press switch in and rotate clockwise "ON" position. Front passenger airbag is now activated. Upon switching the ignition on the control indicator  will illuminate briefly and then extinguish indicating the passenger airbag is active.

If  remains illuminated in conjunction with  indicates a fault within the system.

| |
|--|
|  Warning |
| Have the cause of the fault remedied. We recommend that you consult your Vauxhall Authorised Repairer. |

Important

- Accessories not released for your vehicle type and other objects must not be affixed or placed in the area in which the airbags inflate, as they could cause injury when the airbags are triggered.
- Do not place any objects between the airbag systems and the vehicle occupants; danger of injury.
- Do not stick or place anything on the steering wheel, instrument panel, front seat backrests in the vicinity of the airbags and seat areas or cover them with other materials.
- The airbag systems and belt tensioner control electronics can be found in the centre console area. In order to avoid malfunctions, do not store magnetic objects in this area.
- Use only a dry cloth or interior cleaner to clean the steering wheel, instrument panel, front seat backrests, roof frame and seat area of the front passenger seat. Do not use any aggressive cleaning agents.

- Only protective covers which are approved for your Vivaro with side airbag  may be fitted on the front seats. When fitting the protective covers, make sure that the airbag units on the outboard sides of the front seat backrests are not covered.
- The airbag systems are triggered independently of each other depending on the severity of the accident and the type of impact. The side airbag system  and the curtain airbag system  are triggered together.
- Each airbag can be triggered only once. Once triggered, an airbag must be replaced without delay. We recommend that you consult your Vauxhall Authorised Repairer.
- The speeds, directions of movement and deformation properties of the vehicles, and the properties of the obstacle concerned, determine the severity of the accident and triggering of the airbags. The degree of damage to your vehicle and the resulting repair costs alone are not indicative that the criteria for triggering of the side airbag were met.

- Do not perform any modifications to the components of the airbag systems, as this will render the vehicle unroadworthy.

⚠ Warning

The systems can be triggered abruptly and cause injury if they are handled improperly.

- We recommend having the steering wheel, the instrument panel, all panelling parts, the door seals, the handles and the front seats removed by your Vauxhall Authorised Repairer.
- When disposing of the vehicle, please observe the applicable safety regulations. Please have the vehicle disposed of by a disposal company. We recommend that you consult your Vauxhall Authorised Repairer.

⚠ Warning

Child restraint systems as well as other heavy objects must never be carried on the lap of passengers; risk of fatal injury.



The system for deactivating the front passenger seat's airbag systems is indicated a sticker on the side of the instrument panel, visible when passenger door is open.

⚠ Warning

While using a child restraint system on the front passenger seat, the airbag systems for the front passenger seat must be deactivated; if not, the triggering of the front or side airbag poses the risk of fatal injury to the child.

This is especially the case if backwards-facing child restraint systems are used on the front passenger seat.

Child restraint systems *

Vauxhall child restraint systems are designed specifically for your vehicle and thus provide optimum safety for your child in the event of impact. The use of a Vauxhall Child restraint system is therefore recommended.

 **Warning**

While using a child restraint system on the front passenger seat, the airbag systems for the front passenger seat must be deactivated; if not, the triggering of the front or side airbag poses the risk of fatal injury to the child.

This is especially the case if backwards-facing child restraint systems are used on the front passenger seat.

Selecting the right system

Your child should be transported facing rearwards in the vehicle as long as possible. It is appropriate to change the system when the child's head can no longer be properly supported at eye height. The child's cervical vertebrae are still very weak and in an accident they suffer less stress in the semi-prone rearward position than when sitting upright.

Note

- Children under 12 years or under 150 cm tall should only travel in an appropriate child safety seat.
- When transporting children, use the child restraint systems suitable for the child's weight.
- Ensure that the child restraint system to be installed is compatible with the vehicle type.
- The covers of the Vauxhall child restraint system can be wiped clean.
- Do not stick anything on the child restraint systems and do not cover them with any other materials.
- A child restraint system which has been subjected to stress in an accident must be replaced.
- Ensure that the mounting location of the child restraint system within the vehicle is correct.
- You should also observe the instructions on installation and use supplied with the child restraint system.

The following Vauxhall child restraint systems have been approved for installation in your Vivaro:

| Group, weight and age class ¹⁾ | Vauxhall system |
|--|-----------------|
| 0 From birth - 10 kg, 0 - 10 months | Baby Safe |
| 0+ From birth - 13 kg, 0 - 2 years | |
| I From 9 - 18 kg, 8 months - 4 years | Duo Isofix |
| II from 15 - 25 kg, 3 years - 7 years | Kid |
| III from 22 - 36 kg, 6 years - 12 years | |

¹⁾ We recommend the use of each system until the child reaches the upper weight limit.

If child restraint systems of other manufacture are to be installed, ensure that they conform to the appropriate safety regulations.

| |
|--|
|  Warning |
| Disregard of these instructions may lead to injuries or endanger life. |

The country in which you are travelling may prohibit child seat installation in certain locations. Always observe local or national regulations.



Front seats - all variants

| Group, weight and age class | Facing direction | Single seat - front passenger ¹⁾ | | | Bench seat - front passenger | | | |
|--|------------------|---|------------------------------|------------------|------------------------------|-------|-------------|-----------------|
| | | without airbag | with airbag - no side airbag | with side airbag | without airbag | | with airbag | |
| | | | | | centre | outer | centre | outer |
| 0: up to 10 kg or approx. 10 months | Rearward | U | U ²⁾ | U ²⁾ | X | U | X | U ²⁾ |
| 0+: up to 13 kg or approx. 2 years | | | | | | | | |
| I: 9 to 18 kg or approx. 8 months - 4 years | Forward | U | U ²⁾ | U ²⁾ | UF | U | UF | U ²⁾ |
| II: 15 to 25 kg or approx. 3 - 7 years | Forward | U | U ²⁾ | U ²⁾ | UF | U | UF | U ²⁾ |
| III: 22 to 36 kg or approx. 6 - 12 years | | | | | | | | |

¹⁾ If adjustable, ensure seat is in its rearmost position. Make sure vehicle seat belt is as straight as possible between shoulder and upper anchorage point.

²⁾ Ensure the front passenger airbag system is deactivated when installing a child seat in this position. See page 65.

U = Suitable for universal category restraint systems for use in this mass group, in conjunction with three-point seat belt.

UF = Suitable for universal category forward facing restraint systems for use in this mass group, in conjunction with three-point seat belt.

X = Seat position not suitable for children of this mass group.

 **Warning**

While using a child restraint system on the front passenger seat, the airbag systems for the front passenger seat must be deactivated; if not, the triggering of the front or side airbag poses the risk of fatal injury to the child.

This is especially the case if backwards-facing child restraint systems are used on the front passenger seat.

Combi - rear seats

| Group, weight and age class | Facing direction | 2nd row bench seat | | 3rd row bench seat | |
|--|------------------|--------------------|--------|--------------------|--------|
| | | Outer | Centre | Outer | Centre |
| 0: up to 10 kg or approx. 10 months 0+: up to 13 kg or approx. 2 years | Rearward | U | U,+ | X | X |
| I: 9 to 18 kg or approx. 8 months - 4 years | Forward | U | U,+ | X | X |
| II: 15 to 25 kg or approx. 3 - 7 years III: 22 to 36 kg or approx. 6 - 12 years | Forward | U | U | X | X |

U = Suitable for universal category restraint systems for use in this mass group, in conjunction with three-point seat belt.

L = Suitable only for specifically approved child restraints. Vauxhall has approved child restraint systems from the 'Baby-safe', 'Duo-Isfix' and 'Kid' ranges. We recommend that you consult a Vauxhall Authorised Repairer.

+ = Seat with Isfix mounting available. When mounting Isfix, only Isfix child restraint systems that have been approved for the vehicle may be used. We recommend that you consult a Vauxhall Authorised Repairer.

X = Seat position not suitable for children of this mass group.

Tour - rear seats

| Group, weight and age class | Facing direction | 2nd row bench seat | | 3rd row bench seat | |
|--|------------------|--------------------|--------|--------------------|--------|
| | | Outer | Centre | Outer | Centre |
| 0: up to 10 kg or approx. 10 months 0+: up to 13 kg or approx. 2 years | Rearward | U | U,+ | X ¹⁾ | X |
| I: 9 to 18 kg or approx. 8 months - 4 years | Forward | U | U,+ | X ¹⁾ | X |
| II: 15 to 25 kg or approx. 3 - 7 years III: 22 to 36 kg or approx. 6 - 12 years | Forward | U | U | X ¹⁾ | X |

¹⁾ On left-hand drive 7 seater models (2 seat bench in 2nd row) it is permissible to install a universal child seat on the third seat row but only on the right hand outboard side due to increased clearance in front of it.

- U = Suitable for universal category restraint systems for use in this mass group, in conjunction with three-point seat belt.
- L = Suitable only for specifically approved child restraints. Vauxhall has approved child restraint systems from the 'Baby-safe', 'Duo-Isfix' and 'Kid' ranges. We recommend that you consult a Vauxhall Authorised Repairer.
- + = Seat with Isofix mounting available. When mounting Isofix, only Isofix child restraint systems that have been approved for the vehicle may be used. We recommend that you consult a Vauxhall Authorised Repairer.
- X = Seat position not suitable for children of this mass group.

Crew Cab - rear seats

| Group, weight and age class | Facing direction | Rear bench seat | |
|--|------------------|-----------------|--------|
| | | Outer | Centre |
| 0: up to 10 kg or approx. 10 months 0+: up to 13 kg or approx. 2 years | Rearward | X | X |
| I: 9 to 18 kg or approx. 8 months - 4 years | Forward | X | X |
| II: 15 to 25 kg or approx. 3 - 7 years III: 22 to 36 kg or approx. 6 - 12 years | Forward | X | X |

X = Seat position not suitable for children of this mass group.



Exterior mirrors

For the safety of pedestrians, the exterior mirrors will swing out of their normal mounting position in the event of an accident-like impact.

Aspherical exterior mirror

Increases the field of vision. Slight distortion means that it is somewhat difficult to estimate the distance between the vehicle and those behind it.

Sun visors

The sun visors are padded and can be swung up and down and to the side for protection of driver and passenger against glare.

Head restraints

Do not attach objects or components that are not approved for the Vivaro, to the head restraints. These affect the protective effect of the head restraints and can be propelled through the vehicle in an uncontrolled manner if the driver brakes hard or an accident occurs.

Safety accessories *

The wide range of Vauxhall accessories allows you to equip your vehicle in accordance with your own wishes. In addition to safety accessories, items for improving comfort and a complete range of vehicle care products you will find many articles which will be of great value to you when needed.

All items are “Genuine Vauxhall Parts and Accessories”, guaranteeing high quality and an accurate fit.

Your Vauxhall Authorised Repairer will be happy to advise you, for example with regard to:

- Vauxhall child restraint system
- Tow rope
- Tow rod
- Jump leads
- Spare bulb kit
- Spare fuse kit
- Halogen fog lights
- Mud flaps
- Magnetic light
- Warning triangle
- First-aid kit (box)
- First-aid kit (cushion)

Lighting

| | |
|---|----|
| Exterior lights | 75 |
| Automatic dipped beam activation *..... | 76 |
| Headlight range adjustment D | 76 |
| Fog tail light O | 77 |
| Front fog lights D *..... | 77 |
| Reverse lights | 77 |
| Door-to-door illumination *..... | 77 |
| Interior light..... | 77 |
| Instruments, cigarette lighter | 78 |
| Headlights when driving abroad | 78 |

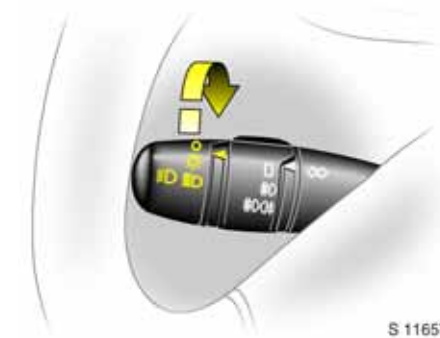

Exterior lights

Turn light switch:

- 0** = Off
- O = Parking lights
- D D = Dipped or main beam

Dipped/main beam and headlight flash, see page 12.

In positions O and D , the tail lights and number plate light are also illuminated.

Vehicles with daytime running lights *:
When the ignition is on, the dipped beam is on and the instrument illumination is subdued.

The daytime running lights go off when the ignition is switched off.

Follow the regulations of the country in which you are driving when using daytime running lights and front fog lights *.

Driving abroad - see page 78.



Automatic dipped beam activation *

Dipped beam switches on or off automatically when the engine is running based on the outside light conditions.

The exterior lights switch off when the ignition is switched off.

To activate:

1. Switch on the ignition.
2. Turn light switch to  and return **0**.
3. Repeat stage 2 within approximately 5 seconds.

This action is confirmed with a double audible warning.

To deactivate:

1. Switch on the ignition.
2. Turn light switch to  and return **0**.
3. Repeat stage 2 within approximately 5 seconds.

This action is confirmed with a single audible warning.

For reasons of safety it is advisable to have the automatic dipped beam function activated.

Turn signals, hazard warning flashers

See page 13.



Headlight range adjustment

With dipped beam switched on, adjust headlight range to suit vehicle load.

Correct adjustment of the headlight range reduces dazzle for other road users.

- No load = 0
- Loaded up to permissible maximum weight = 4

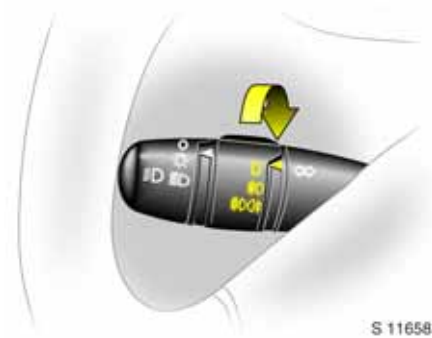

Fog tail light 0

Front fog lights 和 *

Rotate switch, control indicators 和 and 0 in instrument panel:

- 0 = Off
- 和 = Front fog lights on
- 和 and 0 = Fog tail light and front fog lights on

Reverse lights

Come on when reverse gear is engaged and ignition is switched on.

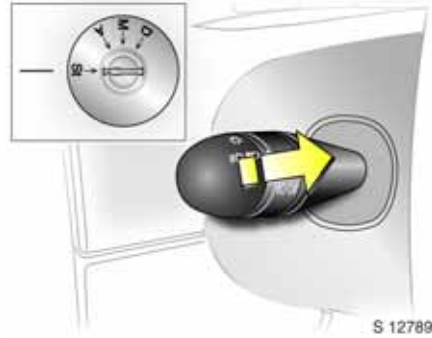

Door-to-door illumination *

The headlights are switched on and remain illuminated for a short time after the vehicle is parked.

To activate:

1. Switch off ignition.
2. Remove ignition key.
3. Open driver's door.
4. Pull lever towards steering wheel.

The dipped beam illuminates for approx. 30 seconds. This action can be repeated up to four times to a maximum period of two minutes.

Switching on the ignition or rotating the light switch cancels the function before the lights automatically switch off.



Interior light

Operated by tilting the light lens. With the light in its central position, the light functions as a courtesy light and illuminates when the front doors are opened.

Once the front doors are closed, the courtesy light goes out after a 15 second delay.

The interior light extinguishes immediately if the ignition is switched on.



S 11748

Load compartment lights

Van

Operated by tilting the light lens.



S 11749

Combi / Tour / Crew Cab

Operated by tilting the light lens to one of 3-positions:

- On constantly
- Controlled by the function of the interior light
- Off constantly

Instruments, cigarette lighter

Comes on when exterior lights are switched on.

Headlights when driving abroad

The asymmetrical dipped beam increases the field of vision on the near side of the lane.

When driving in countries which drive on the opposite side of the road, this causes glare for oncoming traffic.

To avoid glare, conventional headlight glasses must be provided with a black cover strip. Consult a workshop. We recommend your Vauxhall Authorised Repairer.

Windows

Door windows 79
 Electrically operated door windows * 80
 Sliding side windows *..... 80

⚠ Warning

Care must be taken when operating the electrically operated windows. There is a risk of injury, particularly for children, and a danger that articles could become trapped.

Vehicle passengers should be informed accordingly.

Make sure that all vehicle occupants know how to operate the windows correctly.

Keep a close watch on the windows when closing them. Ensure that nothing becomes trapped in them.

Before leaving the vehicle, remove the ignition key in order to prevent unauthorized operation.



S 11750

Door windows

The door windows can be operated with the crank.



S 12323

Electrically operated door windows *

The driver's window is operated by the switch located in the driver's door.

To open the window, push the top of the switch and to close, pull the top of the switch. The window stops when switch is released.

With the engine running: briefly pushing or pulling the switch fully opens or closes the driver's side window. Briefly press the switch again to stop the window during this operation.



S 12324

The passenger's window is operated by a switch in each front door.

To open the window, push the top of the switch and to close, pull the top of the switch. The window stops when the switch is released.

Warning

Before leaving the vehicle, remove the ignition key in order to prevent unauthorized operation of the windows (risk of injury).

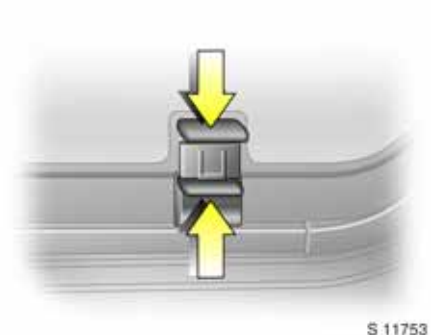

S 11753

Sliding side windows *

To open, pull up catch and slide open.

To close, pull up catch and slide window until catch engages.

Note: during window opening or closing, keep the catch raised to allow the glass sufficient clearance.

Heating, ventilation

Heating and ventilation system 81
 Rear air vents * 83
 Heating the foot area 84
 Window demisting and defrosting 84
 Re-circulation button..... 85
 Air conditioning system * 85
 Rear air conditioning system * 86
 Heated rear windows *, heated exterior mirrors * 87
 Heated front seats * 88

Heating and ventilation system

Vauxhall air mixture system: by mixing cold and hot air the temperature can be regulated without delay and held practically constant at all speeds.

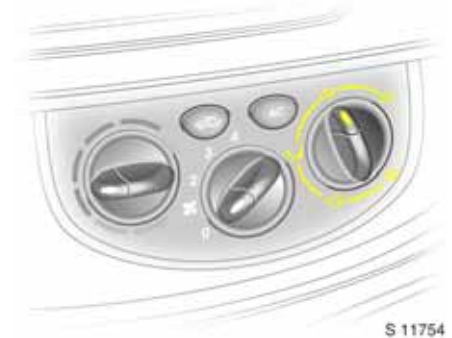

Heating and ventilation controls

Air distribution switch

- To head area
- To head and foot area
- To foot area
- To defrosters and foot area
- To defrosters

The rotary switch can be set to any intermediate position in order to adjust the air distribution to suit personal requirements.

Open the ventilation jets when the switch is set to or .



S 11755

Temperature switch

To red Hotter

To blue Colder

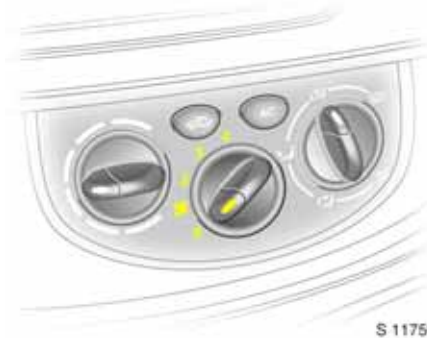

S 11756

Fan switch

Four speeds:

0 Off

4 High speed

The rate of air flow is determined by the fan. The fan should therefore also be switched on during driving.

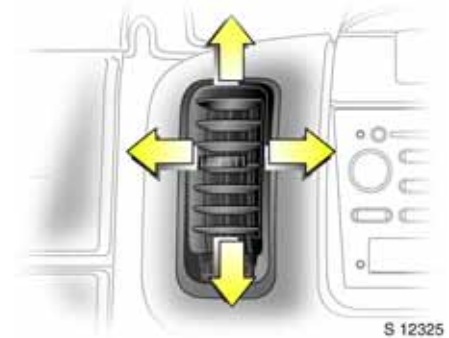

S 12325

Centre ventilation jets

Pleasant ventilation to the head area is controlled by the position of the temperature switch.

To open jets, turn regulating wheel:

Turn to left = Open

Turn to right = Closed

The air supply is increased by switching on the fan.

The air flow can be directed as desired by tilting and swivelling the fins.

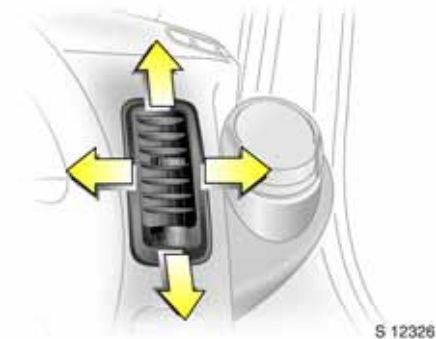

S 12326

Side ventilation jets



Depending upon the position of the temperature switch, air will be directed into the vehicle via these jets.

The jets are opened and closed by means of the regulating wheel.

The air flow can be directed as desired by tilting and swivelling fins.

To increase the air supply, switch on the fan.

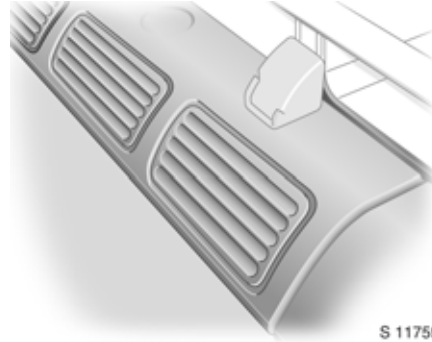

Door window defroster vents

Air distribution switch set to  or : cold or heated air will be directed onto the windscreen and onto the door windows (mainly in the area of the exterior mirrors).



S 11759

Rear air vents *

Operational when air distribution switch is set to ,  or .

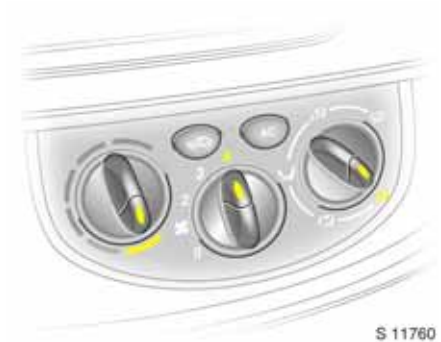

Unheated or heated air will be directed into the rear passenger compartment.

The air flow is biased towards the central and right hand vents for optimum distribution.



S 11760

Ventilation

- Turn temperature switch to blue.
- Switch on fan.
- For maximum ventilation in head area: set air distribution switch to  and open all jets.
- For ventilation to foot area: set air distribution switch to .
- For simultaneous ventilation to head and foot areas: set air distribution switch to .

Heating

The amount of heat is dependant on the engine temperature and is thus not fully attained until the engine is warm.

For rapid warming of the passenger compartment,

- Turn temperature switch to red.
- Switch on fan.
- Set the air distribution switch to the desired position.

The comfort and general well-being of the vehicle occupants are to a large extent dependent on a correct setting of the ventilation and heating.

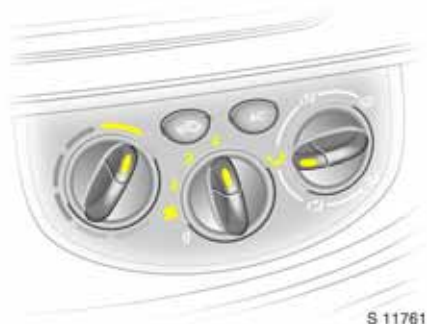

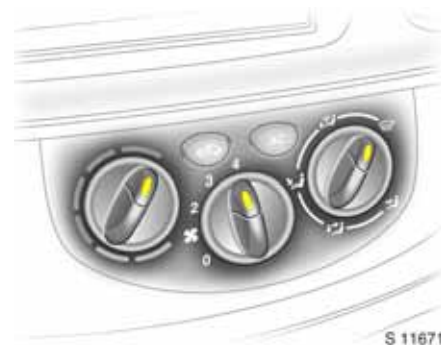

Heating the foot area

- Turn temperature switch to red.
- Set the air distribution switch to .
- Switch on fan.



Window demisting and defrosting

- Turn temperature switch to red.
- Switch on fan.
- Set air distribution switch to .
- Open side ventilation jets as required and direct them towards the door windows.
- Close centre ventilation jets.
- Switch on heated rear windows.

For simultaneous warming of the foot area, set air distribution switch to .

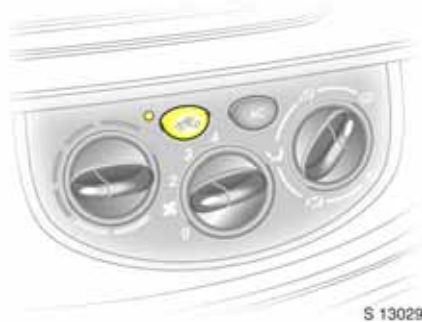

Re-circulation button

During 'normal' operation, the heating and ventilation and air conditioning systems use outside air, however, to prevent fumes from entering the vehicle when in stationary traffic press the  button, control indicator illuminates and air will be recirculated.

Recirculated air should only be used for brief periods due to the gradual deterioration in the air quality and increase in humidity.



Air conditioning system *

The air conditioning system is designed to operate in conjunction with the heating and ventilation system to provide maximum comfort under any weather conditions.

The air conditioning system cools the air and removes moisture from it. It is operational only in temperatures above approx. +4 °C, with the engine running and with the fan switched on:

- Press AC button - control indicator illuminates = on
- Press AC button again = off

Once activated the air conditioning system is operated via the normal heating and ventilation controls.

To improve efficiency of the air conditioning, always close the windows to prevent chilled air from escaping.

Switching on the air conditioning will assist in windscreen demisting.

In very hot temperatures, before switching on the air conditioning, allow hot air to escape from the vehicle by opening the windows.

When the system is switched on, at least one ventilation jet must be open so that the evaporator does not ice up due to lack of air movement.

When the air conditioning is on, fuel consumption increases. Switch off the system whenever it is not required.

Maintenance

To ensure efficient performance of the air conditioning system, it must be switched on once a month for a short time, irrespective of the weather and time of year (possible only when outside temperature is above +4 °C).

Malfunctions in the system must not be rectified by the owner; consult a workshop. We recommend your Vauxhall Authorised Repairer.



Glove compartment cooler *

Slide the control upwards to allow the air conditioning system to also keep the contents of the glove compartment cool.



Rear air conditioning system *

The rear air conditioning * system cools the air and removes moisture from it. It is operational only in temperatures above approx. +4 °C, with the engine running.

It is actuated in conjunction with the driver's compartment air conditioning:

- Press AC button = on
 - Press AC button = off
- again



Rear passenger compartment fan switch *

The fan assists air flow to the passenger compartment. Switching on the fan whilst the air conditioning is actuated, will allow conditioned air to be distributed.

The rate of air flow is determined by the fan.

3 speeds:

- 0** Off
- 3** High speed

When the system is switched on, at least one ventilation jet, located in the roof must be open so that the evaporator does not ice up due to lack of air movement.

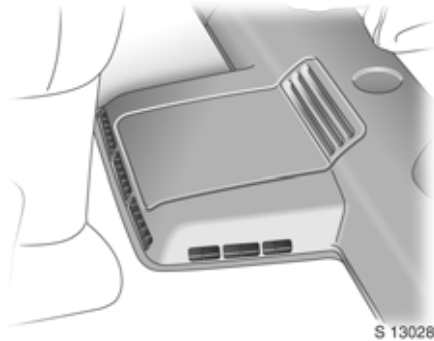

Rear passenger compartment heating *

The fan assists air flow to the rear passenger compartment via the rear air vents.

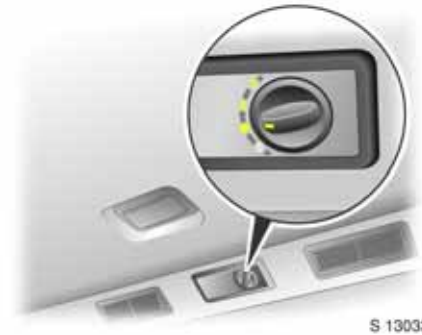

The rate of air flow is determined by the fan.

3 speeds:

- 0 Off
- 3 High speed



Heated rear windows *, heated exterior mirrors *

Operates only with engine running.

Pushbutton  on instrument panel.

Press = on

Press again = off

Control indicator on pushbutton illuminates when in use.

Turn off as soon as rear vision is clear. The heating switches off automatically after approx. 10 minutes.

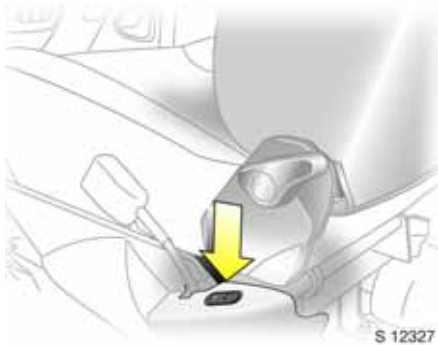

Heated front seats *

Pushbutton  in trim panels of the seat.
Operate only with engine running.

Press = on

Press again = off

Seat heating is thermostatically controlled and will automatically cease when the seat temperature is sufficient. The control indicator will illuminate when system is on, not just when heating.

Tecshift

Transmission display 89
 Starting the engine 89
 Tecshift operation 90
 Winter programme ❄️ 91
 Laden programme kg 92
 Kickdown 92
 Engine braking assistance 92
 Stopping the vehicle 93
 Parking 93
 Rocking the vehicle 93
 Manoeuvring the vehicle 93
 Fault ⚠️ 94
 Interruption of power supply 94

The semi-automatic Tecshift transmission permits manual (manual mode) or automatic gearshifting (automatic mode), both with fully automatic clutch control.

| |
|--|
| ⚠️ Warning |
| Disregard of these instructions may lead to injuries or endanger life. |



Transmission display

Shows the mode, programme and current gear.

Starting the engine

Depress foot brake, turn on ignition. If  is shown in the transmission display the foot brake is not depressed. When "N" is shown in the transmission display the engine can be started.

It is not necessary to select the neutral "N" position before starting. If a gear other than "N" is selected, depress the foot brake and there will be a short delay whilst the transmission automatically shifts into neutral.

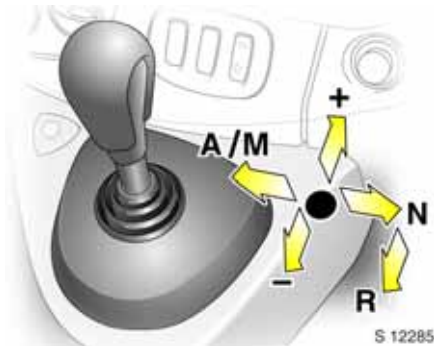

Tecshift operation

The selector lever needs to be moved in the appropriate direction only slightly. It then returns to the centre position. Observe the gear / mode indicator in the transmission display.

Selecting neutral

Move the selector lever toward **N**.

Automatic mode

When the engine is started, Tecshift is in automatic mode "A" is shown in the transmission display.

To engage 1st gear depress foot brake and move selector lever towards +.

The vehicle will begin to "creep" when the foot brake is released without accelerating.

It is possible to start off quickly by releasing the foot brake and accelerating.

In automatic mode the transmission shifts to other gears automatically dependent on driving conditions.

Manual mode

Manual gearshifting is possible in manual mode. If the vehicle is in automatic mode, manual mode can be selected by moving the selector lever toward **A/M**. The current gear will appear in the transmission display.

To engage 1st gear depress foot brake and move selector lever towards + or - and **1** will appear in the transmission display.

Moving selector lever toward:

- + Shifts to a higher gear.
- Shifts to a lower gear.

If the engine speed is too low Tecshift will automatically shift to a lower gear even in Manual mode. This prevents the engine from stalling.

If a higher gear is selected when the running speed is too low, or a lower gear when the speed is too high, no shift is effected. This prevents the engine from running at too low or too high revs.

Gears can be skipped by moving the selector lever repeatedly at short intervals.

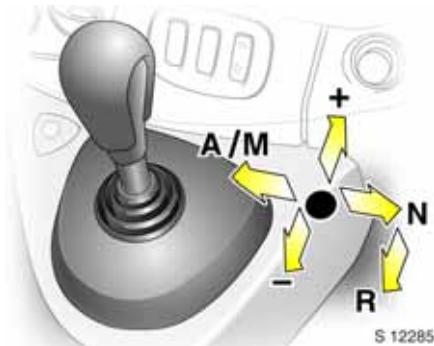

Selecting reverse

Engage only when the vehicle is stationary.

With the foot brake depressed, move the selector lever toward **R**. Reverse gear is engaged and "R" appears in the transmission display.

The vehicle begins to creep when the foot brake is released. Accelerate gently to move.



Winter programme ❄️

In the event of difficulties starting-off on slippery surfaces, press button ❄️ and ❄️: ❄️ is shown in the transmission display. Tecshift switches to automatic mode and the vehicle sets off in a suitable gear.

The Winter programme is switched off by:

- pressing button ❄️ again,
- turning off the ignition.

In order to protect Tecshift at extremely high clutch temperatures, an intermittent audible warning may sound. In such cases depress the foot brake, select "N" and apply the handbrake allowing the clutch to cool down.

If the vehicle is switched to manual mode while winter programme is active, the Winter programme is switched off.



S 12329

Laden programme kg

It is possible to use Laden programme in both manual and automatic modes. In both cases, the gear shifting patterns are adapted automatically for carrying an increased payload. Press button **kg**, Laden programme will be selected and **kg** will appear in the transmission display. Tecshift will then select optimized gear shift patterns.

The Laden programme is switched off by:

- pressing button **kg** again,
- turning off the ignition.

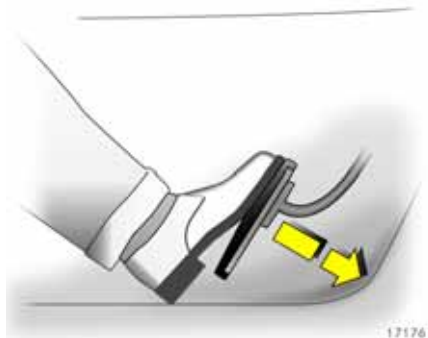

17176 T

Kickdown

Accelerator pedal pressed past the pressure point: below certain speeds, the transmission shifts down into a lower gear. Full engine power is available for acceleration.

When the engine speed approaches its upper limit, the transmission shifts to a higher gear during kickdown even in manual mode.

Without kickdown this automatic shift is not affected in manual mode.

Engine braking assistance

Automatic mode

When driving downhill Tecshift does not shift into the higher gears until a fairly high engine speed has been reached. During braking Tecshift shifts down to a lower gear in good time.

Manual mode

To utilize the engine braking effect, select a lower gear in good time when driving downhill.

Stopping the vehicle

In automatic or manual mode, once the vehicle is stationary first gear engages automatically and the clutch opens. In R, reverse remains engaged.

When stopping on gradients engage handbrake or depress brake pedal. To prevent overheating of the clutch, an intermittent, audible warning may sound as a signal to depress the foot brake or apply the handbrake.

Switch off engine if stopping for a lengthy period, e.g. in traffic jams.

Parking

Before leaving the vehicle:

- engage handbrake,
- remove ignition key.

The most recently engaged gear (indicator in transmission display) remains engaged. With **N**, no gear is engaged.

When the ignition is switched off Tecshift no longer responds to movements of the selector lever.

If the ignition is not switched off, or the handbrake has not been applied, an intermittent audible warning may sound upon opening the driver's door.

Rocking the vehicle

If it becomes necessary to rock the vehicle to free it from sand, mud, snow or a hole, move the selector lever between **R** and **A** (or + or -) in a repeat pattern while applying light pressure to the accelerator pedal. Do not race the engine and avoid sudden acceleration.

This applies only in exceptional circumstances mentioned above.



Manoeuvring the vehicle

To manoeuvre the vehicle back and forth during attempts to park or in garage entrances, the creeping movement can be utilized by releasing the foot brake.

Never actuate the accelerator and brake pedals simultaneously.

In order to protect Tecshift at extremely high clutch temperatures, an intermittent audible warning may sound. In such cases depress the foot brake, select "N" and apply the handbrake allowing the clutch to cool down.



Fault ⚡

If a fault occurs in Tecshift, control indicator ⚡ will be shown in the transmission display.

You can continue driving, provided you drive with care and anticipation. Consult a workshop to have the cause of the fault eliminated. We recommend your Vauxhall Authorised Repairer. The system's integral self-diagnosis facility allows faults to be quickly remedied.

Interruption of power supply

The clutch is not disengaged if the vehicle battery is discharged and a gear has been selected. The vehicle cannot move.

If the battery is flat, start the vehicle using jump leads - see page 126.

If the cause of the interruption to the power supply is not a discharged battery, consult a workshop. We recommend your Vauxhall Authorised Repairer.

Driving hints

The first 600 miles (1000 km)

Drive your vehicle at various speeds. Do not use full throttle. Never allow the engine to labour at low revs.

Make good use of all gears. Depress the accelerator pedal a maximum of around three quarters of the available pedal travel in all gears and drive ranges.

Do not drive faster than three quarters of maximum speed.

The information concerns the engine and parts of the power train, e.g. the final drive.

Never coast with engine not running

Many units will then not function (e.g. turn signal indicators, brake servo unit, power steering, airbag system). Driving in this manner is a danger to yourself and others.

Brake servo unit

With the engine not running the brake servo unit is no longer effective once the brake pedal has been depressed once or twice. The braking effect is not reduced but substantially greater foot pressure is necessary to stop the vehicle.

Power steering

Never leave the steering wheel on full lock when the vehicle is stationary as this may damage the power steering pump.

If the power steering should fail - e.g. when the vehicle is being towed with the engine switched off - the vehicle can still be properly steered but considerably greater effort is necessary.

Driving in mountainous terrain or with caravan/trailer

Electrically driven fan: The fan cooling capacity is not dependant on engine speed. It is not necessary, therefore, when driving uphill to shift down into a lower gear if the vehicle can climb in a higher gear.

Driving with a roof load

Do not exceed the permissible roof load. For safety reasons, distribute the load evenly and secure it tightly with straps so that it cannot slip. Set the tyre inflation pressure to the value given for full load. Do not drive faster than 75 mph (120 km/h). Check and retighten straps at frequent intervals.

Switching off the engine

If the engine temperature is very high, e.g. after driving in mountainous terrain: allow the engine to idle for approximately two minutes in order to prevent heat accumulation.

When you switch off, fans in the engine compartment may continue running for a time to cool the engine.

Vehicles with turbocharged engine

After running at high engine speeds or high engine loads, operate the engine briefly at a low load or run in neutral for approx. 30 seconds before switching off in order to protect the turbocharger.

Save energy – more miles

Please observe the running-in hints on the previous page and the tips for energy saving on the following pages.

Good, technically correct and economical driving ensures maximum durability and performance for your vehicle.

Overrun

The fuel supply is automatically shut off during overrun, e.g. when the vehicle is being driven down long gradients or during braking. To enable the overrun cut-off to come into action, do not accelerate or declutch during overrun.

Engine rpm

Under all driving conditions drive in a favourable engine speed range.

Warming up

Allow the engine to warm up while driving. Do not warm it up by letting it run at idling speed. Do not apply full throttle until the engine has reached operating temperature.

After a cold start, Tecshift * do not shift into higher gears until higher engine speeds have been reached. This allows the catalytic converter to quickly reach the temperature required for optimum pollutant reduction.

Correct gear selection

Do not race your engine whilst in neutral or with a low gear selected. Driving too fast in individual gears or drive ranges as well as stop-and-go traffic increase engine wear and fuel consumption.

Change down

When decreasing speed shift down into the next lowest gear. Do not slip the clutch with a high-revving engine. This is especially important when hill climbing.

Clutch operation

Always depress the clutch pedal hard to the floor to prevent shifting difficulties and transmission damage. There must be no mats in the area of the pedals.

When driving do not use the pedal as a foot rest; this will cause substantial clutch wear.

Pedals

Do not place any objects in the foot well which could slip under the pedals and inhibit the pedal travel.

To ensure the pedal travel is uninhibited, there must be no mats in the area of the pedals.

Battery care whilst driving

When driving slowly or when the vehicle is stationary, e.g. in slow urban traffic, stop-and-go traffic or traffic jams, turn off all unnecessary electrical loads where possible (heated rear window, auxiliary headlights etc.).

When starting the engine, depress the clutch pedal so that transmission resistance is eliminated and the starter motor and battery are relieved.

Save fuel, protect the environment

Trend-setting technology

When developing and manufacturing your vehicle, Vauxhall used environment-friendly and in the main recyclable materials. The production methods used to make your vehicle are likewise environmentally-compatible.

Recycling of production wastes keeps the circulation of material closed. Reduction of energy and water requirements also helps to conserve natural resources.

A highly advanced design means that your vehicle can be easily disassembled at the end of its working life, and the individual materials separated for subsequent re-use.

Materials such as asbestos and cadmium are not used. The refrigerant in the air conditioning system * is CFC-free.

New painting techniques employ water as a solvent.

End-of-life vehicle recovery

For detailed information on Vauxhall's ongoing commitment to achieving an environmentally sustainable future, including; design for recycling, take back of End-of-Life Vehicles (ELVs) and the recycling of ELVs view www.vauxhall.co.uk/recycling for details.

Drive in an energy and environment-conscious way

- High fuel consumption, noise levels and exhaust emission are often caused by a driving style that is not energy and environment-conscious.
- You should therefore drive with energy in mind: "more miles with less fuel".
- Reduce the noise level and exhaust emissions by adopting an environment-conscious driving style. This is extremely worthwhile and improves the quality of life.

Fuel consumption depends to a great extent on your own personal driving style. The following hints are intended to help you consume fuel at a rate that is as close as possible to the specified levels.

Check your vehicle's fuel consumption every time you refuel. This facilitates early detection of any irregularities causing increased fuel consumption.

Warming up

- Full throttle and warming up at idle speed increase wear, fuel consumption, fuel emission, the amount of pollutant in the exhaust and the amount of noise.
- Drive off immediately after starting. Warm up the engine by running it at moderate engine speeds.

Uniform speed

- Hectic driving significantly increases fuel consumption, the quantity of emission and the proportion of pollutant in the exhaust.
- Do not accelerate and brake unnecessarily. Drive at uniform speed. Avoid frequent starting off and stopping e.g. at traffic lights, in short distance traffic and in queues of traffic by means of clever planning. Select roads with good traffic flow.

Idling

- The engine also consumes fuel when idling.
- If you have to wait for more than one minute, it is worthwhile switching off the engine. Five minutes of idling corresponds to approx. 0.6 miles (1 km) of driving.

Overrun

- The fuel supply is automatically shut off during overrun, e.g. when the vehicle is being driven down long gradients or during braking - see page 96.
- To enable the overrun cut-off to take effect and save fuel, do not accelerate or declutch.

Correct gear selection

- High revs increase engine wear and fuel consumption.
- Do not race your engine. Avoid driving at high engine speeds.

Driving with an eye on the tachometer saves fuel. If possible, drive at low revs in each gear and at constant speed. Drive in top gear as much as possible, shift up as soon as possible and do not shift down prematurely.

High speed

- The faster the speed, the higher the consumption and noise level. Driving at full throttle uses up a great deal of fuel and generates excessive noise and high emission levels.

- Slightly releasing the accelerator pedal results in distinct fuel savings with no major loss of speed.

Drive at no more than around three quarters of maximum speed and you will use up to 50% less fuel, without losing a great deal of time.

Tyre inflation pressure

- Inadequate tyre pressure, leading to higher road resistance, costs money in two ways: for more fuel and increased tyre wear.
- Regular checks (every 14 days) pay off.

Electrical loads

- The power consumption of electrical equipment increases fuel consumption.
- Switch off all additional consumers (e.g. air conditioning ✱, heated rear window ✱) when they are no longer required.

Roof racks

- Roof racks can increase fuel consumption by approx. 3.5 gal / 1000 miles (1 l/100 km) due to air resistance.
- Remove them if they are not being used.

Repair and maintenance

- Improper repairs or adjustment and maintenance work can increase fuel consumption. Do not carry out work on the engine yourself.
You may out of ignorance infringe environmental laws by not disposing of materials properly.
Appropriate parts might not be recycled.
Contact with some of the materials involved may pose a health hazard.
- We recommend that repairs and maintenance be entrusted to a Vauxhall Authorised Repairer.

Extreme driving conditions

- Driving up steep gradients, cornering, driving on poor roads, and winter driving all increase fuel consumption.
Fuel consumption increases dramatically in urban traffic and at winter temperatures, especially on short trips when the engine operating temperature is not reached.
- Follow the hints given above to keep consumption to a minimum under such conditions.

Fuel consumption, fuel, refuelling

Fuel consumption 99
 Fuel for petrol engines 99
 Fuel for diesel engines..... 100
 Refuelling..... 100

Fuel consumption

Optional equipment (e.g. wide tyres, air conditioning system, towing equipment) increases the kerb weight and in some cases also the permissible gross vehicle weight. This in turn increases fuel consumption and reduces the maximum speed of the vehicle.

When the vehicle is new, there is increased friction between the engine and transmission components lasting for several thousand miles. This increases fuel consumption.

Fuel for petrol engines

Commercially available high-quality fuel with a maximum ethanol content of 5 % as per DIN EN 228 (catalytic converter - see page 102, octane numbers - see page 163). Fuel quality has a decisive influence on power output, running behaviour and service life of the engine. The additives contained in the fuel play an important role in this regard. You should therefore only use high-quality fuels containing additives.

Fuels with ethanol content greater than 5 % do not comply with DIN EN 228 and must not be used unless the vehicle has been specifically developed and approved for use of such.

Fuel with too low an octane number can cause pinking. Vauxhall cannot be held liable for resulting damage.

Petrol with a higher octane number can always be used.

Pump nozzles for leaded fuel cannot be inserted into the filler neck of vehicles that operate on unleaded fuel.

The ignition timing is automatically adjusted according to the grade of fuel used (octane number) – see page 163.

Use of petrol with an octane rating of 95 will ensure economical driving.

Fuel for diesel engines

Diesel engines must be operated only on commercially available diesel fuel meeting the specifications of DIN EN 590. Do not use marine diesel oils, heating oils or entirely or partially plant-based diesel fuels, such as rape seed oil or bio diesel, Aquazole and similar diesel-water emulsions.

The flow and filterability of diesel fuel are temperature-dependent.

Diesel fuels with improved low-temperature properties are therefore available on the market during the winter months. Make sure that you fill the tank with winter fuel before the start of the cold weather season.

Additives can be used with diesel fuels with winter properties that are guaranteed by the manufacturer and when using diesel fuel filters that are heated depending on the outside temperature.

Do not mix diesel fuel with fuel for petrol engines.

Refuelling

Warning

Care must be taken when handling fuel.

Before refuelling, switch off the engine and any external heaters with combustion chambers (identified by a sticker on the tank flap). Switch off mobile phones.

Fuel is flammable and explosive. Therefore, avoid naked flames and sparks when handling or in the vicinity of fuel. Do not smoke! This also applies in places where fuel can only be detected by its characteristic smell. If you can smell fuel in the vehicle, have the cause thereof remedied immediately. We recommend that you consult your Vauxhall Authorised Repairer.

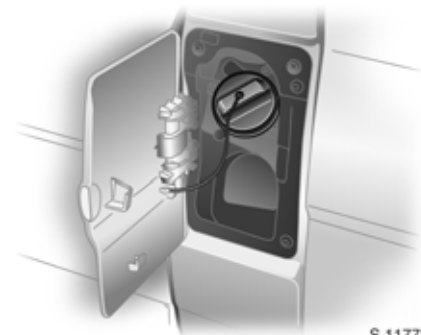

The fuel tank filler neck with bayonet cap is located on the left-hand side of the vehicle.

The fuel filler flap is locked  together with the doors - see page 41.

To unlock filler cap : insert key and turn anti-clockwise.

The fuel tank has a limiting system which prevents overfilling of the tank.

Correct refuelling is largely dependent on correct operation of the dispensing pump:

- Insert dispensing pump as far as it will go and switch on.
- After the first automatic cut-off, do not fill the tank any further.

Replace the filler cap and turn key clockwise as far as it will go.

Wipe off any overflowing fuel immediately.



S 11773

Should an interruption to the power supply occur, the fuel filler flap will not unlock in conjunction with the central locking ✱. In such cases release manually.

To open:

- Reposition left front seat to access the release cover.
- Remove the release cover and position the seat belt to one side.

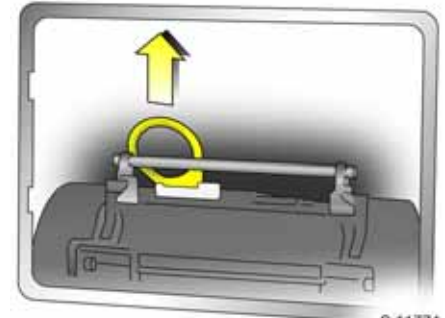

S 11774

- Raise fuel filler release to unlock the fuel filler flap.

To close:

- Close the fuel filler flap and lower fuel filler release to lock the fuel filler flap.
- Replace the release cover.

If the cause of the interruption to the power supply is not a discharged battery, consult a workshop. We recommend your Vauxhall Authorised Repairer.

Catalytic converter, exhaust emissions

| | |
|--|-----|
| Catalytic converter for petrol engines | 102 |
| Catalytic converter for diesel engines | 103 |
| Controlling exhaust emission..... | 103 |
| Diesel particle filter *..... | 104 |
| Engine oil life monitor *..... | 105 |
| Maintenance | 105 |

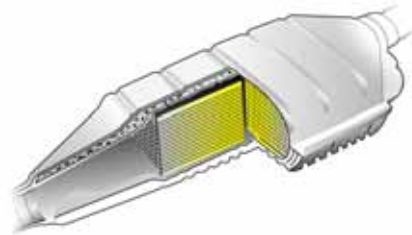

17199 T

Catalytic converter for petrol engines

Leaded fuel will damage the catalytic converter and parts of the electronic system, thereby rendering them inoperative.



On vehicles with a catalytic converter, the fuel tank filler neck is of a narrow design so that a dispensing pump for leaded fuel cannot be inserted.

Damage to the catalytic converter or the vehicle may result if the following points are not observed:

- If the engine misfires or runs roughly after a cold start, the engine power has reduced significantly or other unusual operating problems occur that indicate a fault in the ignition system, please contact a workshop as quickly as possible. We recommend that you consult your Vauxhall Authorised Repairer. Drive at a slower speed and with less engine revs for a short time if necessary.

- If unburnt fuel enters the catalytic converter, this may result in overheating and irreparable damage to the catalytic converter.

You should therefore avoid frequent coldstarts, unnecessarily long use of the starter when setting off, running the tank dry (an irregular fuel supply leads to overheating) and starting the engine by pushing or towing.

- If the control indicator for exhaust emission  flashes, lift your foot off the accelerator until the indicator stops flashing and is steadily lit. Contact a workshop immediately. We recommend that you consult your Vauxhall Authorised Repairer. Control indicator  for exhaust emissions - see page 23.

Catalytic converter for diesel engines

Damage to the catalytic converter or the vehicle may result if the following points are not observed:

- Consult a workshop, we recommend your Vauxhall Authorised Repairer, as quickly as possible in the event of irregular engine running, a significant loss of engine power or other unusual malfunctions. If necessary, driving may be continued for a short time at a low speed and with a low engine speed.

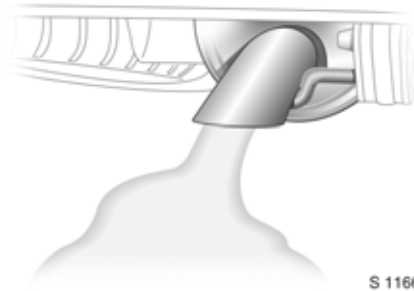

Controlling exhaust emission

Through design-related measures - mainly in the area of the mixture formation system - the proportion of noxious materials in the exhaust, such as carbon monoxide (CO), hydrocarbons (CH) and nitrogen oxides (NO_x), is reduced to a minimum.



Control indicator for exhaust

Lights up when the ignition is switched on and during the start attempt. Goes off shortly after the engine starts running.

If it lights while the engine is running there is a fault in the emission control system. The permitted emission values may be exceeded. Consult a workshop immediately. We recommend your Vauxhall Authorised Repairer.



Control indicator for engine electronics

Lights up for a few seconds when ignition is switched on.

If the light comes on when the engine is running, there is a fault in the engine electronics. The electronics switch to the emergency running programme, fuel consumption may increase and the driveability of the vehicle may be affected. In some cases the fault can be eliminated by switching the engine off and back on again. If the control indicator lights up again when the engine is running, consult a workshop to have the cause of the fault eliminated. We recommend your Vauxhall Authorised Repairer.



Diesel particle filter *

Even during normal use, there is still a possibility that the diesel particle filter may become partially blocked. The filter is automatically cleaned under certain driving conditions, however when  is illuminated the diesel particle filter requires driver induced regeneration¹⁾.

Warning



Before attempting regeneration of the diesel particle filter, ensure road conditions will allow the vehicle to safely travel at speeds in excess of approx. 40 mph (60 km/h) for up to 20 minutes.

¹⁾ During regeneration white smoke can be emitted from the exhaust which is not detrimental to the vehicle.

To carry out regeneration²⁾:

With the engine at normal operating temperature, maintain an average speed of approx. 40 mph (60 km/h) until  goes out. In some cases this can take up to 20 minutes.



Failing to achieve these speeds or an interruption to your journey may prevent regeneration taking place. The regeneration process will then need to be restarted.



If  fails to extinguish or  illuminates in conjunction with , consult a workshop to have the cause of the fault eliminated. We recommend your Vauxhall Authorised Repairer.

²⁾ Where speed limits and traffic conditions permit.



Engine oil life monitor *

If  illuminates and the  flashes continuously in the display, the engine oil has become oxidized.

If the engine oil has become diluted  will illuminate in conjunction with . In either case it is necessary to carry out an engine oil and oil filter change and to reset the engine oil life monitor.

Make an appointment with a workshop for service work as soon as possible. We recommend your Vauxhall Authorised Repairer.

Exhaust gases

Warning

Engine exhaust gases contain poisonous carbon monoxide, which has no colour or odour and can be lethal if inhaled.

If exhaust fumes penetrate the vehicle interior, open the windows and consult a workshop immediately. We recommend that you consult a Vauxhall Authorised Repairer.

When the vehicle is driven for the first time, wax and oil on the exhaust system may evaporate, producing smoke-like emissions which should not be inhaled. Allow wax and oil to evaporate while the vehicle is in the open air. Avoid inhaling.

Maintenance

Have all maintenance work carried out at the intervals specified by Vauxhall. We recommend that you entrust this work to your Vauxhall Authorised Repairer, who has proper equipment and trained personnel available. Electronic testing systems permit rapid diagnosis and remedy of faults. This way you can be certain that all components of the vehicle's electrical, injection and ignition systems operate correctly, that your vehicle has a low level of pollutant emission and that the catalytic converter system will have a long service life.

You are thereby making an important contribution towards keeping the air clean and compliance with emissions legislation.

Checking and adjustment of the fuel-injection and ignition systems is part of the scope of inspection. For this reason you should have all maintenance work carried out at the intervals specified in your Service Booklet.

Drive control systems

Electronic Stability Program (ESP) ✱. 106
Parking distance sensor ✱ 107

Electronic Stability Program (ESP) ✱

The ESP (Electronic Stability Program) ✱ improves driving stability when necessary, independently of the type of road surface and the tyre grip. It also includes the Traction Control system function.

The system monitors vehicle movements. As soon as the vehicle starts to swerve (understeers/oversteers) engine output is reduced (the sound of the engine changes) and individual wheels are specifically braked. This considerably improves the driving stability of the vehicle on slippery road surfaces.

The ESP is ready for operation as soon as the ignition is switched on and the control indicator ✱ goes out.

When the ESP comes into action, ✱ flashes.

The vehicle is now in a critical situation; the ESP assists you to keep control of the vehicle and reminds you to match your speed to the road conditions.

Warning

Do not let this special safety feature tempt you into taking risks when driving.

Traffic safety can only be achieved by adopting a responsible driving style.





Control indicator ✱

Lights up for a few seconds when ignition is switched on. The system is now ready for operation.

Flashing during driving:

This shows the system has come into action. The engine output may be reduced (the sound of the engine changes) and the vehicle may be braked automatically to a small degree.

Illuminated during driving:

If  illuminates in conjunction with  this indicates a fault in the system. Driving can be continued. Poor road surface conditions may however still cause vehicle stability to be impaired.

Have the cause of the fault remedied. We recommend that you consult your Vauxhall Authorised Repairer. The system's integrated self-diagnostics allows faults to be quickly remedied.

**Switching off**

The traction control function of ESP can be switched off by pressing the  button.

When deactivated, control indicator  in the instrument panel illuminates.

The function is switched on again by pressing the  button again or the next time the ignition is switched on.

**Parking distance sensor ***

The parking distance sensor makes reverse parking easier by measuring the distance between the rear of the vehicle and an obstacle through ultrasonic reflection and warning you with an acoustic signal in the passenger compartment.

The system records the distance using sensors in the rear bumper.

The parking distance sensor is automatically enabled when the ignition is switched on and reverse gear is selected. Readiness for operation is indicated by brief acoustic alarm.



As the vehicle slowly gets close to an object while reversing, an intermittent acoustic signal is audible in the passenger compartment.

The interval between the signals becomes shorter as the distance is reduced. If the distance is less than 25 cm, a continuous signal is audible.

Warning

Under certain circumstances, various reflective surfaces on objects or clothing as well as external noise sources may cause the system to fail to detect obstacles. For this reason, care must be taken when reversing even if the parking distance sensor is operational. This is of particular importance when in the vicinity of pedestrians.

The system registers the distance by means of sensors on the rear bumper.

To ensure that the sensors function correctly and that the information provided is accurate, they must be undamaged and free of dirt, snow and ice.



It is possible to permanently or temporarily deactivate the system.

Temporary deactivation

With the ignition on and reverse gear selected,  pushbutton on instrument panel. System is temporarily deactivated.

When reverse gear is selected, no acoustic signal will sound indicating deactivation.

The function is switched on again by pressing  pushbutton again or the next time the ignition is switched on.

Permanent deactivation

With the ignition on and reverse gear selected, press and hold  pushbutton on instrument panel for approx. 3 seconds.

The system is deactivated and will not operate. When reverse gear is selected, no acoustic signal will sound.

To reactivate permanent deactivation: Press again and hold  pushbutton for three seconds. The next time reverse gear is selected parking distance sensor will function.

Should the parking distance sensor system fail to operate consult a workshop. We recommend your Vauxhall Authorised Repairer.

If towing equipment is required for your vehicle we recommend contacting your Vauxhall Authorised Repairer.

Warning

When reversing the area should be free from obstacles which could impact on the underside of the vehicle.

Impact to the rear axle which may not be visible, could lead to uncharacteristic changes in the vehicle handling.

In the event of such an impact consult a workshop. We recommend that you consult your Vauxhall Authorised Repairer

Dropside body

Loading 106
 Using the step 111
 Lashing points 111
 Underfloor storage compartments ✱ 112
 Cleaning 112
 Service operations 112

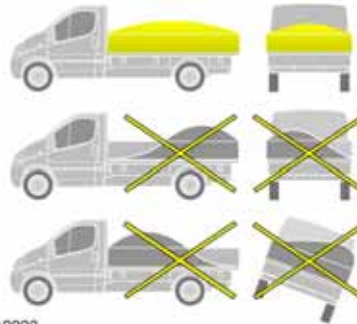

S 12233

Loading ¹⁾

- Load the vehicle evenly, distributing the load across the body.
- Secure any solid loads with additional lashing equipment. See page 111.
- Place loads onto the dropside body from the minimum practicable height. Do not drop loads onto the body floor.
- Do not overload the dropside body.

¹⁾ Observe the national regulations on securing loads.

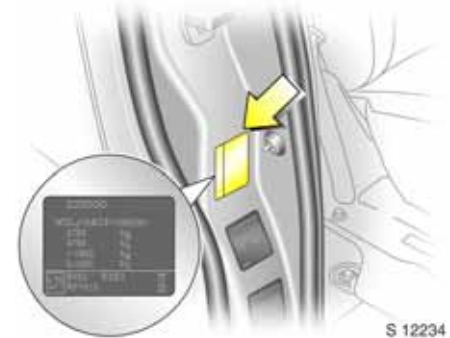

S 12234

- Ensure the load will not fall out or endanger other road users.
- Do not leave load deposits on public roads or footpaths.
- Do not drive with the tailboard or sideboards down.
- The gross vehicle weight and gross combined weight can be found on the vehicle identification plate²⁾, which is located on the right hand door pillar - see page 161.

²⁾ The VIN plate on your vehicle may differ from the illustration shown.



To lower the sideboard:

Release both sideboard levers by pulling the lever outwards.



Pull the lever down until it contacts the body and lower the sideboard carefully.

To lower the tailboard:

Release both tailboard levers.

Lower the tailboard carefully.

To raise:

Raise the sideboard or tailboard and push firmly against the body. Push the lever up into its recess until an audible click is heard. Check the sideboard or the tailboard is secure.

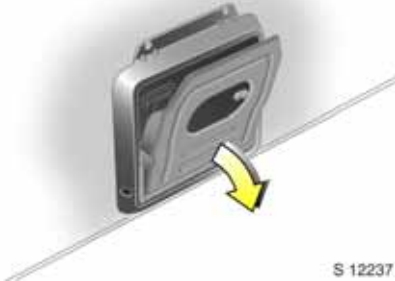

S 12237

Using the step

Lowering:

With the tailboard down, swing the step plate down to a horizontal position.

Stowing:

Swing the step plate up into the vertical position against the mounting bracket.

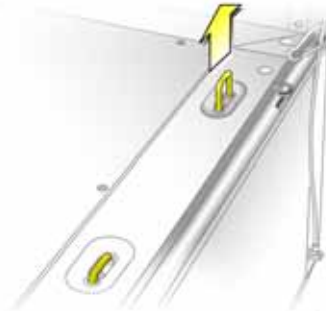

S 12239

Lashing points

Pull up the lashing eyes as required.

Secure heavy objects with lashing straps attached to the lashing points. If heavy loads slip when the vehicle is braked heavily or driven around a bend, the handling of the vehicle may change.

Warning

When loading heavy or bulk items, the lashing point eyes must be flush with the body floor to avoid causing any damage.

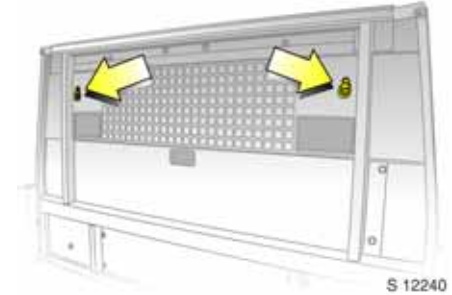

S 12240

The two additional lashing points on the bulkhead should also be used to secure the load whenever possible.

Observe the safety labels on the bulkhead to avoid overloading.



S 12241

Underfloor storage compartments ✳

Certain models feature five lockable underfloor storage compartments. For security these can be locked with the key provided.



To open pull latch and lower flap. Upon closing ensure the flap is pushed firmly until an audible click is heard.

Cleaning

Dirt or mud which remains dry on the body may become abrasive and can damage paint, seals, locks and hinges.

Clean the following parts of the dropside, if contaminated with dirt:

- Sideboard and tailboard locks, latches and hinges.

Service operations

In conjunction with the Service items detailed in the vehicle Service Booklet, the following checks are additionally required.

- Tail/sideboard latches and hinges: check operation.
- Bolts and nuts of sub-frame mounting: check tightening torque.

Your Vauxhall Authorised Repairer will also be able to advise you if additional service operations are recommended depending on the specific operating conditions of your vehicle.

These operations can be performed at the same time and intervals as a vehicle service. We recommend your Vauxhall Authorised Repairer.

Brakes

The effectiveness of the brakes is an important factor for traffic safety.

In the interest of effectiveness, do not brake unnecessarily hard during the first 200 km (120 miles) after new disc brake pads have been fitted.

Wear of the brake linings must not exceed a certain limit. Regular maintenance as detailed in the Service Booklet is therefore of the utmost importance for traffic safety.

Have worn brake pads replaced. We recommend that you consult your Vauxhall Authorised Repairer, who will fit parts that have been tested and approved by Vauxhall and guarantee optimum braking power.

Foot brake..... 114
 Hand brake 114
 ABS (®) * 115

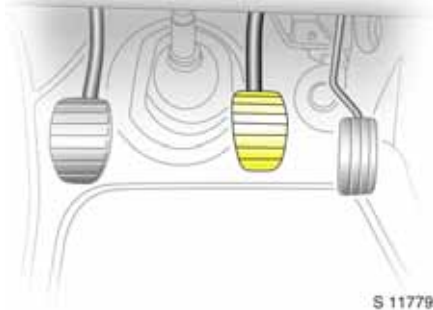

Foot brake

The braking system comprises two separate brake circuits. If one brake circuit should fail, the vehicle can still be stopped with the second remaining circuit. If this happens, the brake pedal must be fully depressed with greater pedal pressure. The distance required for braking will be greater. Consult a workshop before continuing to drive. We recommend that you consult a Vauxhall Authorised Repairer.

In order to utilise the full pedal travel - particularly in the event of a brake circuit fault - there must be no mats in the area of the pedals.

With the engine stopped the servo assistance is discontinued after the brake pedal has been depressed once or twice. The braking action will not be reduced but greater pedal pressure will be necessary. Take extra care when the vehicle is being towed.

Check the brake lights before starting out on a journey. Shortly after the start of each journey the brake system should be tested at low speed for its effectiveness, especially if the brakes are wet, e.g. after washing your vehicle.

The brake fluid level should be checked regularly - see page 151.

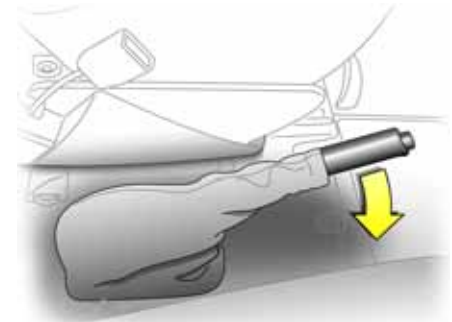

Hand brake

Always apply the hand brake firmly. On slopes apply the hand brake as firmly as possible.

The mechanical hand brake acts on the brakes on the rear wheels. It engages automatically when applied.

To release the hand brake pull the lever up slightly, press the ratchet knob, and fully lower and release.



Control indicator (ⓘ) for brake system

Control indicator lights up when ignition is switched on if hand brake is applied and/or fluid level for brake system is too low. Brake fluid level - see page 151.

Warning

If the control indicator lights up when the hand brake is not applied: stop vehicle; interrupt your journey immediately. Consult a workshop. We recommend your Vauxhall Authorised Repairer.

ABS (ABS) *

The ABS (anti-lock brake system) continuously monitors the vehicle's brake system and prevents the wheels from locking, irrespective of the road condition and tyre grip.

It starts to regulate the braking pressure as soon as a wheel shows a tendency to lock. The vehicle remains steerable, even in the event of very heavy braking, for instance on bends or when swerving to avoid an obstacle. Even in the case of full-on braking, the ABS makes it possible to drive round an obstacle without releasing the brakes.

ABS control is made apparent through a pulse in the brake pedal and the noise of the regulation process.

Warning

For optimum braking, keep the brake pedal fully depressed throughout the braking process, despite the fact that the pedal is pulsating. Do not reduce the pressure on the pedal.

Do not let this special safety feature tempt you into taking risks when driving.

Traffic safety can only be achieved by adopting a responsible driving style.



Control indicator (ABS) for ABS

When the ignition is switched on, the ABS control indicator lights up. At the same time, the system performs a self-check which may be audible. When the control indicator goes out the system is ready for operation.

If the control indicator does not go out after a few seconds, or if it lights up during driving, there is a fault in the ABS. The vehicle's brake system remains operational without ABS regulation.

⚠ Warning

If there is a fault in the ABS, the rear wheels may tend to lock in the event of unusually heavy braking. This may cause the vehicle to swerve. The benefits of the ABS are lost.

You can continue driving, provided you drive with care and anticipation

Have the cause of the fault remedied. We recommend that you consult your Vauxhall Authorised Repairer. The system's integrated self-diagnostics allows faults to be quickly remedied.

Wheels, tyres

| | |
|---------------------------------------|-----|
| Tyres | 117 |
| Changing tyre/wheel type..... | 117 |
| Tyre inflation pressure..... | 117 |
| Tyre condition, wheel condition | 118 |
| Winter tyres ❄️..... | 120 |
| Tyre chains ❄️..... | 121 |

Tyres

See page 167 for suitable tyres and restrictions.

Factory-fitted tyres are matched to the chassis and offer optimum driving comfort and safety.

Changing tyre/wheel type

Before switching to different tyres or wheels, seek advice on technical possibilities. We recommend that you consult your Vauxhall Authorised Repairer, who will be able to advise you of any necessary modifications.

Warning

Use of unsuitable tyres or wheels may lead to accidents and render the vehicle unroadworthy.

If tyres of a different size to those fitted at the factory are used (this includes winter tyres), the electronic speedometer may possibly need to be reprogrammed to ensure that the speed displayed is correct.

Fitting new tyres

New tyres should be fitted in pairs, or for preference in sets. Make sure that both tyres on an axle are

- the same size
- the same design
- the same make
- and have the same tread pattern.

Warning

We recommend that you consult your Vauxhall Authorised Repairer to have the tyres replaced. Your Vauxhall Authorised Repairer knows the legal regulations concerning the disposal of tyres and therefore protects the environment and your health.

Tyre inflation pressure

Check tyre pressures, including the spare wheel, at least every 14 days and prior to any long journey. The tyres should be checked when cold. Don't forget to check the spare.

Tyre pressures - see page 167.

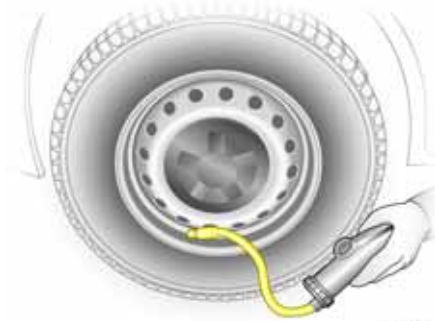

S 11782

Increased pressure resulting from tyre warm-up must not be reduced, otherwise the pressure may drop below the permissible minimum.

After having checked the tyre pressures, securely tighten the valve caps.

Incorrect inflation pressures will impair safety, vehicle handling, comfort and fuel economy and will increase tyre wear.

⚠ Warning

If the pressure is too low, this can result in considerable tyre warm-up and internal damage, leading to tread separation and even to tyre blow-out at high speeds.

Hidden tyre damage is not eliminated by subsequently adjusting the inflation pressure.



S 11783

Tyre condition, wheel condition

Driving over sharp edges can lead to hidden tyre damage and wheel damage which is only noticed later on: there is a danger of tyre blow-out.

Drive over edges slowly and at a right angle if possible. When parking, ensure that the tyres are not pressed against the edge of the kerb.

Check tyres regularly for damage (foreign bodies, punctures, cuts, cracks, bulges in sidewalls). Check wheels for damage. In the event of damage or abnormal wear, consult a workshop. We recommend that you consult your Vauxhall Authorised Repairer.

⚠ Warning

Damage may lead to tyre blowout.

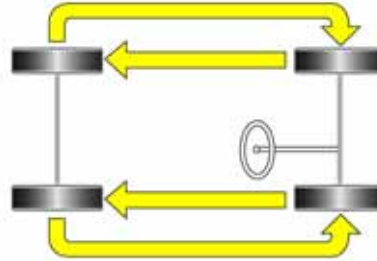

S 11568

Tread depth

Check tread depth regularly. Should the front tyres show greater wear than the rear tyres, have both front wheels exchanged with the rear wheels so that the tyres with deeper tread are on the front axle.



17216 T

For safety reasons, tyres should be replaced when their tread depth has worn down to 2 to 3 mm. The legal permissible minimum tread depth (1.6 mm) has been reached when the tread has worn down as far as one of the wear indicators. A number of wear indicators are spaced at equal intervals around the tyre within the tread. Their position is indicated by markings on the tyre sidewall.

General information

Note that the danger of aquaplaning is greater if the tyres are worn.

Tyres age, even if they are used only very little or not at all. A spare wheel * which has not been used for six years should be used only in emergencies; drive slowly when using such tyres.

Never fit used tyres the previous history and use of which you do not know.

Tyre designations

Meanings:

e.g. **195/65 R 16 C**

195 = Tyre width in mm

65 = Aspect ratio in %
(tyre height to tyre width in %)

R = Belt type: Radial

16 = Rim diameter in inches

C = Cargo or commercial use



S 11786

Winter tyres *

See page 167 for restrictions.

M+S tyres improve safety and should therefore be fitted on all wheels.

The design of summer tyres means they have limited qualities for winter driving.

If the maximum permissible speed for the winter tyres is less than that of the vehicle, a notice indicating the maximum permissible speed for the tyres must be affixed within the driver's field of vision *¹⁾.

If you use the spare wheel when it is fitted with a summer tyre: the vehicle's driveability may be affected, especially on slippery road surfaces. Obtain a replacement for the faulty tyre as soon as possible, and have the wheel balanced and fitted to the vehicle.

¹⁾ Varies from country to country on account of national regulations.



S 11787

Tyre chains *

See page 167 for restrictions.

Tyre chains may be used only on the drive wheels (front axle). They must be fitted symmetrically on the tyre to ensure that they are seated concentrically.

Only fine-linked chains - not protruding more than 15 mm on the tyre tread and inboard sides (including chain lock).

We recommend that you consult your Vauxhall Authorised Repairer, who will be pleased to give advice.

Wheel covers on steel wheels may come into contact with parts of the chains. In such cases, remove the wheel covers.

Tyre chains may only be used at speeds up to 30 mph (50 km/h)¹⁾ and, when travelling on roads that are free of snow, they may only be used for brief periods since they are subject to rapid wear on a hard road and may snap.

¹⁾ Varies from country to country on account of national regulations.

Roof rack, caravan and trailer towing

| | |
|--|-----|
| Roof racks *..... | 122 |
| Towing equipment *..... | 122 |
| Caravan/trailer loads | 122 |
| Coupling socket load..... | 123 |
| Rear axle load during towing | 123 |
| Tyre inflation pressure..... | 123 |
| Driving characteristics, towing tips ... | 124 |
| Starting on inclines | 124 |

Warning

Disregard of the instructions may lead to injuries or endanger life. Vehicle passengers should be informed accordingly.

Roof racks *

For reasons of safety and to avoid damaging the roof, we recommend that you use the Vauxhall roof rack system released for your vehicle. Your Vauxhall Authorised Repairer will be happy to advise you.

Note: The front roof rack fixing points located above the cab area are for installation of the full roof rack system only and must not be used to attach roof bars.

Driving hints - see page 95.

Towing equipment *

If the vehicle is not equipped with a trailer hitch, we recommend having this retrofitted by a Vauxhall Authorised Repairer, who will advise you on any possible towed load increases. Your Vauxhall Authorised Repairer has instructions on how to install the trailer hitch and making any changes to the vehicle that are needed that affect the cooling system or other equipment.

Mounting dimensions of towing equipment - see page 171.

Towing equipment audible warning *

For vehicles fitted with towing equipment * when connected to a caravan or trailer the pitch of the audible warning changes upon operating the turn signal lights. The pitch of the audible warning will change if the caravan/trailer or towing vehicle turn signal light fails.

Caravan/trailer loads¹⁾

The permissible caravan/trailer loads are vehicle and engine-dependent maximum values which must not be exceeded. The actual caravan/trailer load is the difference between the actual gross weight of the caravan/trailer and the actual coupling socket load with the caravan/trailer coupled.

When the caravan/trailer load is being checked, therefore, only the caravan/trailer wheels - and not the jockey wheel - must be standing on the weighing apparatus.

¹⁾ Observe national regulations.

The permissible caravan/trailer loads for your vehicle are given in the vehicle papers. Unless otherwise stated, they are valid for gradients up to max. 12%.

The permissible caravan/trailer load should be fully utilized only by drivers who are adequately experienced in towing large caravans/trailers.

In higher elevations the engine output and gradability may drop so that it may not be possible for the permissible caravan/trailer loads to be fully utilized in mountainous territory.

The actual caravan/trailer load plus the actual gross vehicle weight must not exceed the maximum permitted towing weight. For example, if the permitted gross vehicle weight is utilised, the caravan/trailer load must only be used until the maximum permitted towing weight is reached. The maximum permitted towing weight is shown on the identification plate, see page 161.

Coupling socket load

The coupling socket load is the load exerted by the caravan/trailer on the coupling ball. It can be varied by changing the weight distribution when loading the caravan/trailer.

The maximum permissible coupling socket load for the towing vehicle, stated on the label, should always be aimed for, particularly in the case of heavy caravans/trailers. The coupling socket load should never be below 25 kg.

In the case of caravan/trailer loads of 1200 kg or more, the coupling socket load should not be less than 50 kg.

When measuring the coupling socket load, make sure that the drawbar of the loaded caravan/trailer is at the same height as it will be when the caravan/trailer is coupled with the towing vehicle loaded. Particularly important for trailers/caravans with tandem axle.

Rear axle load during towing

When the caravan/trailer is coupled and the towing vehicle fully loaded (including all occupants), the permissible rear axle load must not be exceeded.

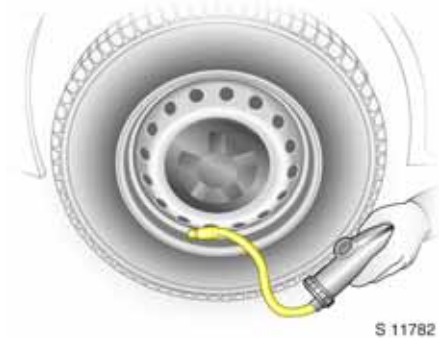

Tyre inflation pressure

Increase the tyre pressure on the towing vehicle to the value specified for full load (see page 167). Also check the pressure of the caravan/trailer tyres.

Driving characteristics, towing tips

In the case of caravans/trailers with brakes, attach the breakaway stopping cable.

Before coupling the caravan/trailer, lubricate the ball of the caravan/trailer towing device. However, do not do so if a stabilizer which acts on the coupling ball is being used to damp rolling motions.

Handling is greatly influenced by the loading of the caravan/trailer. Loads should therefore be secured so that they cannot slip and placed in the centre of the caravan/trailer if possible, i.e. above the axle.

Genuine Vauxhall Accessories which can be subsequently fitted aid trailer operation, e.g. large mirrors for wide trailers/caravans.

In the case of trailers/caravans with low directional stability, it is advisable to use a stabilizer to damp rolling motions.

Do not drive faster than 50 mph (80 km/h) if possible, even in countries where higher speeds are permitted.

Make sure that you have enough room when cornering and avoid sudden manoeuvres.

If the caravan/trailer starts to sway, drive more slowly, do not attempt to correct the steering and brake sharply if necessary.

Electrically driven fan: The fan cooling capacity is not dependant on engine speed. It is not necessary, therefore when driving uphill to shift down into a lower gear if the vehicle can climb in a higher gear.

When coupled to a caravan/trailer the vehicle requires more braking effort when driving down long gradients, so select the same gear as you would driving uphill and drive at roughly the same speed.

Remember that the braking distance for vehicles towing caravans/trailers is always greater than the braking distance for vehicles not towing a caravan/trailer.



S 11788

Starting on inclines

Hold engine rpm constant, engage clutch gradually (let slip), release brake and open throttle. If possible, the engine speed should not drop during this procedure.

For vehicles with Tecshift  in automatic mode, apply sufficient throttle.

Before starting off under extreme conditions (high combination weight, mountainous terrain with steep inclines), switch off all unnecessary electrical loads (e.g. heated rear window).

Self-help

| | |
|--|-----|
| Diesel fuel system, bleeding | 125 |
| Starting the engine with jump leads ✱ | 126 |
| Towing the vehicle..... | 129 |
| Jack and vehicle tools ✱..... | 130 |
| Warning triangle ▲ ✱, First-aid kit ☹ ✱..... | 130 |
| Wheel changing..... | 131 |
| Tyre repair kit ✱..... | 133 |
| Electrical system | 136 |
| Fuses..... | 137 |
| Bulb replacement | 138 |

⚠ Warning

Disregard of the instructions may lead to injuries or endanger life. Vehicle passengers should be informed accordingly.

Diesel fuel system, bleeding

If the fuel tank has been allowed to run dry, it will be necessary to air vent or bleed the system before attempting to start the engine.

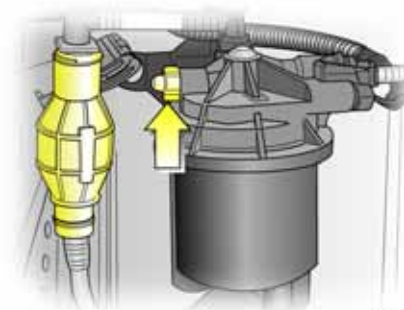

S 11789

Fill the tank with fuel and proceed as follows:

1. Place a suitable container underneath the vent screw (arrowed) to collect fuel.
 2. Loosen the fuel filter vent screw (arrowed) by one turn.
 3. Squeeze by hand the in-line supply pump slowly and steadily until fuel discharging from the loosened vent screw is free of air bubbles.
 4. Retighten the vent screw.
- Draining water from diesel fuel filter - see page 149.

Do not start with quick charger

This prevents damage to electronic components.

⚠ Warning

If the vehicle battery requires charging whilst still in the vehicle, ensure there is adequate ventilation in and around the battery compartment to prevent risk of explosion.

Do not start by pushing or towing

If your vehicle is fitted with a catalytic converter, it must not be started by pushing or towing - see page 102.

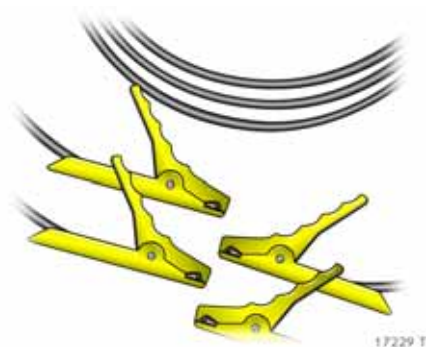
**Starting the engine with jump leads ***

A vehicle with a discharged battery can be started using jump leads and the battery of another vehicle.

⚠ Warning

This must be done with extreme care. Any deviation from the following instructions could lead to personal injury or damage resulting from battery explosion, as well as to damage to the electrical systems in both vehicles.

- Never expose the battery to naked flames or sparks.
- A discharged battery can freeze at temperatures as low as 0 °C. Defrost the battery before connecting the jump leads.
- Do not allow battery fluid to contact eyes, skin, fabrics or painted surfaces. The fluid contains sulphuric acid which can cause injuries and damage in the event of direct contact.
- Wear eye protection and protective clothing when handling a battery.
- Use auxiliary battery with same voltage (12 volts). Its capacity (Ah) must not be considerably less than that of the discharged battery. Voltage and capacity information can be found on the batteries.
- Use jump leads with insulated terminals and a width of at least 16 mm² (25 mm² for diesel engines).
- Do not disconnect the discharged battery from the vehicle.
- Switch off all unnecessary electrical consumers.

- Do not lean over the battery during jump starting.
 - Do not allow the terminals of one lead to touch those of the other lead.
 - Do not touch the vehicles while jump starting.
 - Apply hand brake. Transmission in neutral (Tecshift * in N).
 - Do not connect leads to negative terminal of discharged battery!
 - The connection point should be as far away from the discharged battery as possible.
- Route the leads so that they cannot catch on rotating parts in the engine compartment.
 - Start the engine of the vehicle providing the jump start.
 - After 5 minutes, start the other engine. Start attempts should be made at intervals of 1 minute and not last longer than 15 seconds.
 - After starting, allow both engines to idle for approx. 3 minutes with the leads connected.
 - In order to avoid excess voltage in the electrical system, before removing a lead, switch on an electrical consumer (e.g. light, heated rear window) in the vehicle receiving the jump start.
 - Reverse above sequence exactly when removing leads.



Battery access

The battery is located beneath the front left-hand seat floor panel. Lift the floor covering and use tool supplied in the tool kit to loosen 4 screws.

Note the position of the arrow facing forward on the battery cover when replacing.



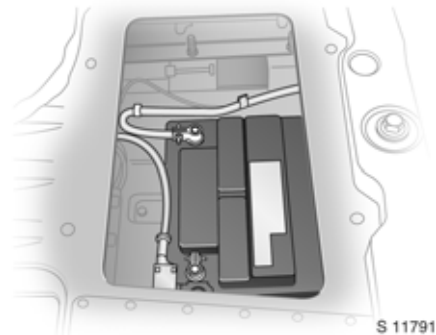

Remove cover plate to access battery.

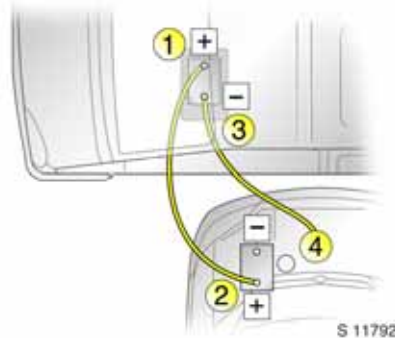

Connect the leads in the order shown in the picture:

1. Connect one end of the first jump lead to the positive terminal **1** of the discharged battery (identified by "+" sign on battery case or terminal).
2. Connect the other end of this lead to the positive terminal **2** of the battery providing the jump start ("+" sign).
3. Connect the first end of the second jump lead to the negative terminal **3** of the discharged battery ("- sign).
4. Connect the other end of this jump lead **4** to ground on the vehicle providing the jump start, e.g. engine block or screw connection in engine suspension.

Warning

Care must be taken to ensure that the leads do not inadvertently contact metal surfaces within the compartment area.

- Do not connect the lead to the negative terminal of the battery on the vehicle providing the jump start! The connection point should be as far away from the battery as possible.
- Route the leads so that they cannot catch on rotating parts in the engine compartment.
- Reverse above sequence exactly when removing leads.

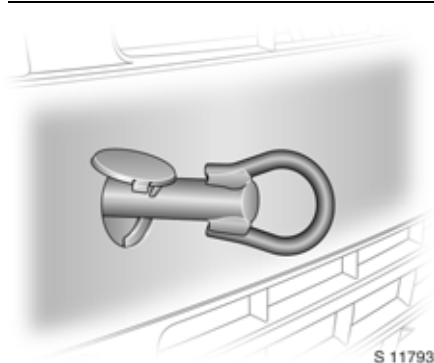

Towing the vehicle

Screw the towing eye (stowed in the tool kit - see page 130) fully into the front towing point.

Attach the tow rope * - or better still, a tow rod * - to the towing eye, never to the bumper or front suspension units.

Warning

Never lift the vehicle using the towing eye!

Place the gear shift lever in the neutral position (Tecshift * in **N**). Switch on the ignition to release the steering column lock and to permit the operation of the brake lights, horn and windscreen wiper.

Drive off slowly and avoid jerky movements. Impermissible tractive forces could damage the vehicles.

Warning

More brake pedal pressure is necessary when braking since the brake servo unit is operative only when the engine is running.

Considerably greater steering force is necessary since this unit is operative only when the engine is running.

To prevent the entry of exhaust fumes from the towing vehicle, switch on the air circulation system and close the windows.

Consult a workshop. We recommend your Vauxhall Authorised Repairer, who will serve you best to get your vehicle back on the road.

Towing service

Entrust your vehicle only to the towing service of your choice and obtain an estimate on towing costs before employing any towing service. This will prevent unnecessary expense and possible insurance problems during claim processing.

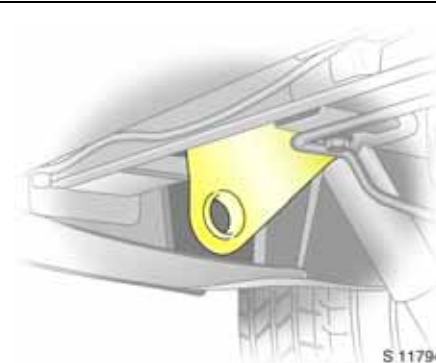

Towing another vehicle

Attach tow rope * - or better still a tow rod * - to the rear towing eye, never to the rear axle and suspension units.

Warning

Never lift the vehicle using the towing eye!

Drive off slowly and avoid jerky movements. Impermissible tractive forces could damage the vehicles.

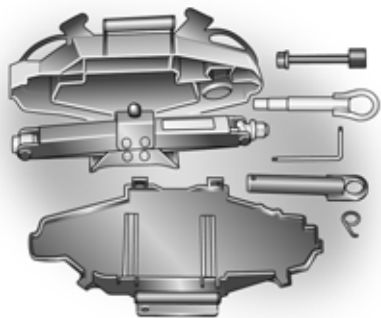

S 11795

Jack and vehicle tools *

The jack and the vehicle tools have been specially developed for your vehicle and must only be used on that vehicle. Only use jack for changing wheels.

The jack, adapters, ratchet, torx key, hub cap hook, towing eye and spare wheel security tool * are contained in a unit, stowed under the driver's seat.

Warning triangle ▲ *, First-aid kit ☺ *

Your first-aid kit and warning triangle can be accommodated in the space under the front seats.

▲ Warning

Ensure items stowed under the seats are securely restrained.

Spare wheel *

The spare wheel is mounted under the rear underbody. The spare wheel may be secured using a Vauxhall security bolt * that can only be removed using the tool supplied.

▲ Warning

Due to the weight of the tyre assembly it is recommended that you exercise caution when releasing the spare wheel carrier. Do not fully remove bolt 1.

Support the spare wheel with a suitable object to prevent the wheel falling suddenly when loosening the carrier bolts - risk of injury!

If in doubt seek technical assistance, consult a workshop. We recommend that you consult a Vauxhall Authorised Repairer.

It may be necessary to jack the vehicle up to gain access to the spare wheel on a fully loaded vehicle with a flat rear tyre.

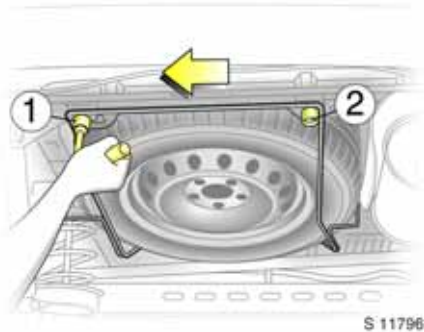

To release the spare wheel carrier, loosen bolt 1, ensuring it is not fully removed. Fully remove bolt 2, then pull the carrier to the left, until it clears bolt 1, and lower the carrier assembly.

When installing the wheel ensure that the spare wheel carrier is correctly positioned before tightening the bolts.

General information

If you use winter tyres ❄, the spare wheel may still be fitted with a summer tyre. If you use the spare wheel when it is fitted with a summer tyre the vehicle's driveability may be affected, especially on slippery road surfaces. Obtain a replacement for the faulty tyre as soon as possible, and have the wheel balanced and fitted to the vehicle.

Wheel changing

In order to reduce the chance of possible injuries, make the following preparations and note the procedure:

- Park on a level, firm and non-slippery surface.
- Switch on hazard warning flashers and apply hand brake. Engage 1st gear or reverse for manual transmission and Tecshift ❄.
- Correctly set up warning triangle.
- No people or animals may be in the vehicle when it is jacked up.
- Before lifting the vehicle, turn front wheels to straight-ahead position.

- Never change more than one wheel at a time.
- Block wheel diagonally opposite the wheel to be changed by placing wedge blocks, any available blocks of wood or rocks behind and in front of it.
- Use jack only when changing wheels.
- If the ground on which the vehicle is standing is soft, a solid board (max. 1 cm thick) should be placed under the jack. Using a thicker board could lead to damage of the jack and the vehicle.
- Never crawl under a jacked-up vehicle.
- Do not start or run the engine while the vehicle is on the jack.

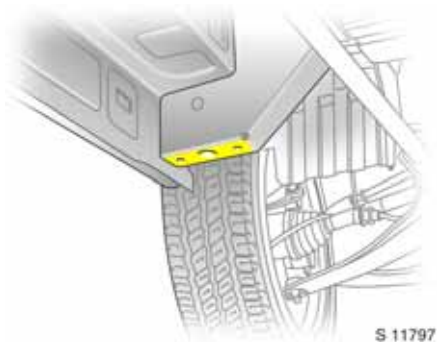

1. Remove wheel trim, loosen the wheel bolts with the ratchet and adapter. The ratchet should turn anti-clockwise to loosen the bolts - invert the ratchet if necessary.
2. To raise vehicle, place lifting pad spigot of the jack under the jacking hole located nearest the wheel concerned.

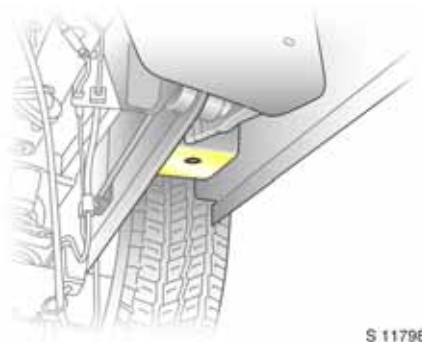

3. Install adapter onto the jack and raise the vehicle by turning the ratchet until the wheel is clear of the ground.
4. Remove wheel bolts and replace wheel.
5. Refit wheel bolts and lower vehicle.



6. Tighten wheel bolts in criss-cross sequence and refit wheel trim.
7. Stow the wheel, jacking equipment and warning triangle ❄.

Have the new wheel balanced on the vehicle and have the torque of the wheel bolts checked as soon as possible. Tightening torque - see page 167.

Have defective tyre repaired and balanced.

Tyre repair kit *

Minor damage to the tyre tread or side wall, e.g. from foreign bodies, can be repaired using the tyre repair kit.

Do not remove the foreign body from the tyre.

Use of the tyre repair kit does not constitute a permanent repair. Use of this system enables the owner to safely continue driving and seek technical assistance at the earliest opportunity so that the tyre can be renewed.

Warning

Driving with inadequate tyre pressure or a flat tyre can lead to hidden tyre damage, which cannot be eliminated by using the tyre repair kit. Park the vehicle and consult a workshop. We recommend your Vauxhall Authorised Repairer.

Important information – see page 135.

In the event of a flat tyre:

- Switch on hazard warning lights, apply hand brake, manual transmission or Tecshift * - engage 1st or reverse gear.
- Correctly set up the warning triangle. Warning triangle – see page 130.

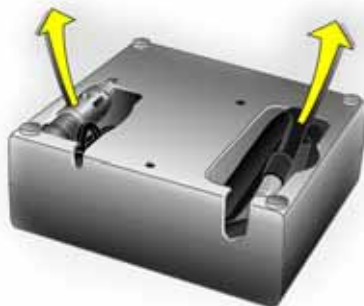

17251 T

Temporary puncture repair

The repair kit is located under the front seat.

1. Carefully remove the components from the case.
2. Remove the compressor.
3. Remove the electrical connection cable and air hose from the compartments on the underside of the compressor.



17252 T

4. Screw the compressor air hose to the connection on the sealant bottle.
5. Invert the sealant bottle in the retainer on the compressor.
Position the compressor near the tyre in such a way that the sealant bottle is upright.
6. Remove the valve cap from the defective tyre.

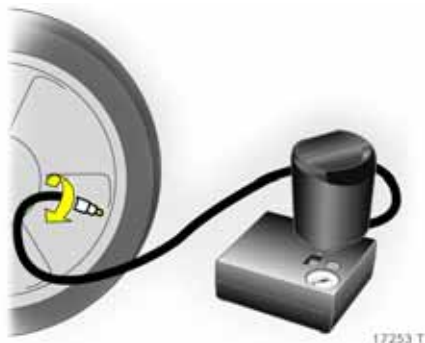

7. Screw the filler hose to the tyre valve.

Warning

Do not allow the sealant to contact skin, eyes or clothing. If swallowed seek medical assistance immediately.

- 8. The switch on the compressor must be set to **O**.
- 9. Connect the compressor plug to the accessory socket or cigarette lighter socket. Accessory socket – see page 54.



- 10. Switch on ignition.
- 11. Set the rocker switch on the compressor to **I**. The tyre is filled with sealant.
- 12. While the sealant bottle drains (approx. 30 seconds) the pressure indicator on the compressor briefly points to 6 bar. Pressure then sinks again.
- 13. All of the sealant is pumped into the tyre and then the tyre is filled with air.
- 14. The prescribed tyre pressure (see page 167) should be reached within 10 minutes. Switch off the compressor when the correct pressure is obtained.

Warning

Do not run the compressor for more than 10 minutes - see "Important information" on page 135.

If the prescribed tyre pressure is not reached within 10 minutes, detach the tyre repair kit. Move the vehicle one tyre revolution (approx. 2 metres) in a straight line. Reconnect the tyre repair kit and continue the filling procedure for 10 minutes. If the prescribed tyre pressure is still not reached, the tyre is too badly damaged. Park the vehicle and consult a workshop. We recommend your Vauxhall Authorised Repairer.



Reduce excess tyre pressure with the button above the pressure indicator.

15. Detach the tyre repair kit. Screw the filler hose to the free connection on the sealant bottle. This prevents sealant leakage. Stow the tyre repair kit in the vehicle.
16. Wipe away any sealant spill with a cloth.
17. Dismantle and stow the warning triangle ❄.
18. The sticker supplied in the kit shows the maximum permitted speed at which the tyre repair may be used. Apply sticker in the driver's field of vision.

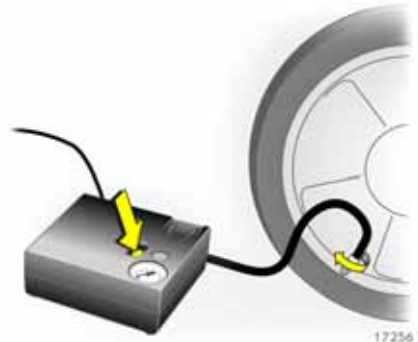

19. Continue driving immediately to allow the sealant to distribute evenly throughout the tyre. Stop after approx. 6 miles / 10 km (no more than 10 minutes) and check tyre pressure. Screw the compressor air hose directly onto the tyre valve.

If tyre pressure is more than 3.1 bar, adjust to the prescribed value. Repeat the procedure until there is no more pressure loss.

If tyre pressure is below 3.1 bar, the vehicle must not be driven. Consult a workshop. We recommend your Vauxhall Authorised Repairer.

20. Stow the tyre repair kit under the front seat.

Important

Warning

Do not drive faster than 50 mph (80 km/h). Have the tyre permanently repaired or replaced before subjecting it to prolonged usage.

Have the repaired tyre replaced as soon as possible. Do not drive with more than one repaired tyre.

Steerability and driving behaviour may be impaired. Take bends slowly.

If the compressor makes abnormal noises or heats up greatly, switch it off for at least 30 minutes.

Protect the compressor from moisture and rain.

The sealant can only be stored for approx. 4 years. After this time, the sealing properties can no longer be guaranteed. Heed the expiration date on the sealant bottle.

The sealant bottle can only be used once. Replace a used sealant bottle.

The compressor and sealant can be used from approx. -30 °C.

Dispose of a used tyre repair kit in accordance with applicable legislation.

Electrical system

Warning

Electronic ignition systems use a very high voltage. Do not touch; danger to life.

Fuse boxes

The fuse box is located on the left hand side of the instrument panel.

When replacing a fuse, turn off the respective switch and the ignition.

A defective fuse can be recognized by its melted wire. A new fuse should only be installed after the cause of the trouble has been eliminated.

Only fuses of the specified rating should be installed. The rating is given on all fuses.

It is advisable to carry a full set of fuses available from your Vauxhall Authorised Repairer.

Provision is made in the fuse box for the storing of spare fuses.

| Fuses, Colour | Fuses, Rating ¹⁾ |
|------------------|--------------------------------|
| Grey | 2 A |
| Light brown | 5 A |
| Brown | 7.5 A |
| Red | 10 A |
| Blue | 15 A |
| Yellow | 20 A |
| White | 25 A |
| Green | 30 A |
| Orange | 40 A |

¹⁾ Rating in Amperes.













Instrument panel fuse box











To open the cover, remove the ashtray from the left hand cup holder, pull open the fuse box cover.

To help in replacing fuses, a fuse remover is located in the fuse box.







Fuses

| Symbol | Application |
|--|-----------------------------------|
|  | Air conditioning |
|  | Heated rear view mirrors |
|  | Heated seats |
|  | Electric windows |
|  | Left hand main beam |
|  | Right hand main beam |
|  | Windscreen wiper |
|  | Radio |
|  | Cigarette lighter |
| Boiler | Rear passenger compartment heater |
|  | Horn |

Symbol Application

| | |
|---|---------------------------------|
|  | Left hand dipped beam |
|  | Right hand dipped beam |
|  | Instrument panel |
|  | Heating |
|  | Interior light |
|  | Anti-lock brake system |
|  | Heated rear windows |
|  | Clock / interior lights / radio |
| UCH | Fuel injection system |
| INJ | |
|  | Rear window wash |
|  | Rear window wiper |

Symbol Application

| | |
|---|--|
|  | Left hand side light |
|  | Right hand side light |
|  | Central locking |
|  | Electrically adjustable rear view mirrors |
| STOP | Stop control indicator Daytime running lights |
|  | Rear fog light |
|  | Front fog lights |
|  | Accessory socket |
| T | Tachograph |

Bulb replacement

Before replacing a bulb, turn off the respective light switch.

Only hold new bulb at base! Oil and grease stains on the glass evaporate, eventually resulting in a dull reflector. Inadvertently stained bulbs may be cleaned with a clean non-fluffy cloth, using alcohol or white spirit.

Replacement bulb must be in accordance with data on base of defective bulb. Do not exceed wattage given on bulb base.

Headlight aiming

We recommend that headlight aiming be carried out by your Vauxhall Authorised Repairer, who will have special equipment.

On vehicles with headlight range adjustment, carry out headlight aiming with switch in position 0.

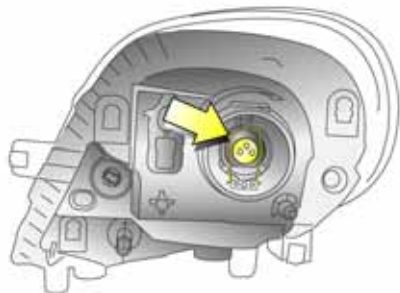

S 13038

Headlight dipped and main beam

1. Remove harness connector
2. Remove rubber seal
3. Release retaining clip and remove bulb
4. Renew bulb and install retaining clip ensuring that bulb is in correct orientation
5. Install rubber seal and harness connector.

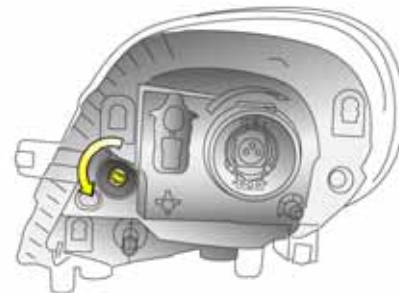

S 13039

Parking light

1. Remove bulb holder from light by rotating through 90°
2. Renew bulb
3. Install bulb holder in light.

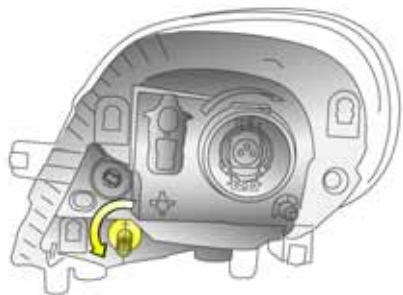

S 13040

Front turn signal indicator

1. Remove bulb holder from light by rotating through 90°
2. Renew bulb
3. Install bulb holder in light.

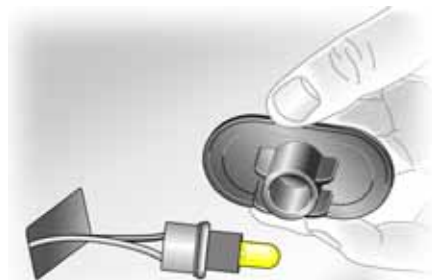

S 11807

Side repeater light

1. Release light clips from wing using a flat screwdriver and lift out.
2. Remove bulb holder from light by rotating through 90° and renew bulb.
3. Install bulb holder in light and install light assembly into aperture.

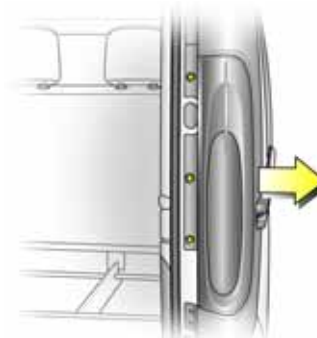

S 11808

Rear brake, turn signal and tail lights

1. Remove 3 screws (using the tool supplied).
2. Carefully pull light assembly from retaining pins on the outer side and remove.



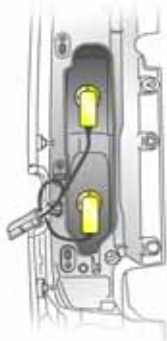

3. Twist bulb holder to separate from light assembly.
4. Renew bulb.
5. Push to install the bulb holder into the light assembly - then twist to secure.
6. Check that the wiring harness is located correctly.
7. Locate light assembly into position, ensuring that it is seated correctly.
8. Fit light assembly onto retaining pins and replace 3 screws.

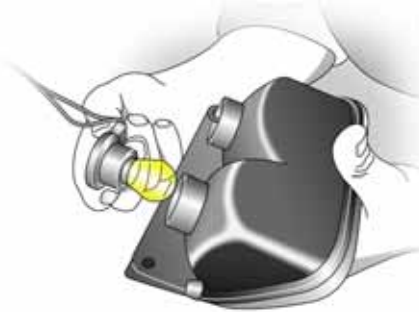

Reverse lights and fog tail light

1. Remove 2 screws (using the tool supplied) and remove light assembly.
2. Twist bulb housing to separate from light assembly.
3. Renew bulb.
4. Push to install the bulb holder into the light assembly - then twist to secure.
5. Install light assembly with 2 screws.



Number plate light

1. Remove 2 screws (arrowed) and remove lens.
2. Renew bulb.
3. Re-install lens; replace screws.

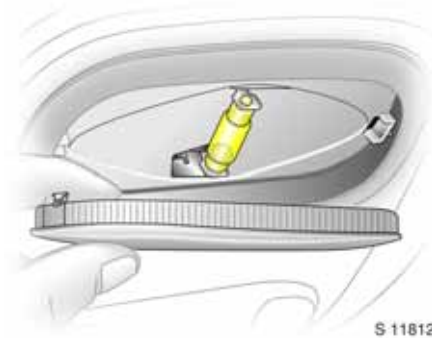

S 11812

Interior lights

1. Remove lens using a flat blade.
2. Renew bulb.
3. Reinstall lens assembly.

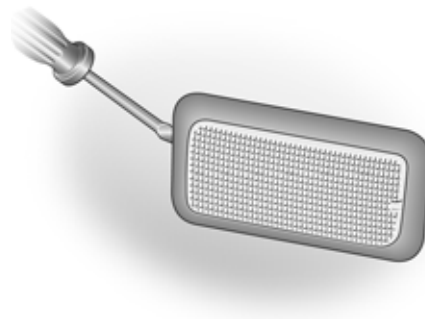

S 11813

Load compartment light *

1. Remove light assembly using a flat blade.
2. Gain access to bulb, by removing rear cover on light assembly.
3. Renew bulb, and install rear cover.
4. Reinstall lens assembly.

Third brake light, front fog lights *, instrument and glove compartment illumination

We recommend having bulb replacements carried out by your Vauxhall Authorised Repairer.

Rear courtesy lights *

We recommend having bulb replacements carried out by your Vauxhall Authorised Repairer.

If you have a problem

In our experience, the most common cause of all complaints is the result of misunderstanding or lack of communication between the customer and the Vauxhall Authorised Repairer.

We sincerely hope you will never have cause to complain about your vehicle. However, if things do go wrong, the best course of action for you to take is to contact your Vauxhall Authorised Repairer's Service Reception Staff and explain the difficulty you are having. We are confident they will do their utmost to resolve the problem to your complete satisfaction.

Sometimes, however, despite the best of intentions of all concerned, misunderstandings can occur. If your problem has not been resolved to your satisfaction, please make an appointment to discuss the matter with the Manager of the department concerned.

The majority of areas of concern can be quickly resolved in this way.

Should you wish to pursue the matter further, the Principal of the Vauxhall Authorised Repairer should be made

aware of your concern. It is advisable in cases such as this to write to him to confirm your problem and the solutions that have been offered.

You can be assured the Authorised Repairer's Principal will only be too anxious to fully investigate your problems and correct any errors made. After all, he has a large investment in his business and is proud of his reputation and professionalism and fully realises that satisfied customers are his key to success.

In the unlikely event that you are still not happy with the answer your Vauxhall Authorised Repairer has given, or the action he proposes to correct the problem, you may contact the Customer Care Department¹⁾ where a team of Customer Care Consultants will spare no effort to ensure your complete satisfaction.

Vauxhall Motors Ltd.

Customer Care,
Griffin House,
Osborne Road,
LUTON,
Beds., LU1 3YT
Telephone: 0845 090 2044

They will review all the facts involved. Then if it is felt some further action can be taken, the Vauxhall Authorised Repairer will be advised accordingly. In any case, your contact will be acknowledged confirming Vauxhall Motors' position in the matter.

¹⁾ Calls may be monitored and recorded for training purposes.

If you are not satisfied with the outcome, you can if you wish, seek advice from an independent third party such as:

Automobile Association (A.A.)

Fanum House,
BASINGSTOKE,
Hants., RG21 2EA

Royal Automobile Club (R.A.C.),

R.A.C. Motoring Services Ltd.,
89-91 Pall Mall,
LONDON, SW1Y 54S

The Customer Relations Department,
Society of Motor Manufacturers and Traders Ltd. (S.M.M.T.),
Forbes House, Halkin Street,
LONDON, SW1X 7DS

Customer Complaints Service,
Scottish Motor Trade Association,
(S.M.T.A.),
3 Palmerston Place,
EDINBURGH, EH12 5AQ

The National Conciliation Service,
Retail Motor Industry Federation,
9 North Street,
RUGBY, CV21 2AB

If you have a problem whilst abroad:

The Service Departments of Adam Opel GmbH and General Motors branches everywhere will provide information and assistance:

In **Luxembourg** please contact the General Motors Service Department in Antwerp – Belgium
Telephone 00 32-34 50 63 29

General Motors Austria GmbH
 Groß-Enzersdorfer Str. 59
1220 Vienna – Austria
 Tel. 00 43 1-2 88 77 444 or
 00 43-1-2 88 77 0

General Motors Belgium N.V.
 Noorderlaan 401 – Haven 500
2030 Antwerp – Belgium
 Telephone 00 32-34 50 63 29

General Motors Southeast Europe,
 org. složka Olbrachtova 9
140 00 Prague – Czech Republic
 Tel. 00 420-2 39 004 321

General Motors Denmark
 Jaegersborg Alle 4
2920 Charlottenlund – Denmark
 Telephone 00 45-39 97 85 00

Vauxhall Motors Ltd.
 Customer Care
 Griffin House, Osborne Road
Luton, Bedfordshire, LU1 3YT – England
 Tel. 00 44-845 090 2044

General Motors Finland Oy
 Pajuniityntie 5
00320 Helsinki – Finland
 Tel. 00 358-9 817 101 47

General Motors France
 1 – 9, avenue du Marais
 Angle Quai de Bezens
95101 Argenteuil Cedex – France
 Tel. 00 33-1-34 26 30 51

ADAM OPEL GmbH
 Bahnhofspatz 1
65423 Rüsselsheim – Germany
 Tel. 00 49-61 42-77 50 00 or
 00 49-61 42-7 70

General Motors Hellas S.A.
 56 Kifisias Avenue & Delfon str.
 Amarousion
151 25 Athens – Greece
 Tel 00 30-1-6 80 65 01

General Motors Southeast Europe Ltd.
 Szabadsag utca 117
2040 Budaörs – Hungary
 Tel. 00 36-23 446 100

General Motors India
 Sixth Floor, Tower A, Global Business Park
 Mehrauli – Gurgaon Road
Gurgaon – 122 022, Haryana – India
 Tel. 00 91-124 280 3333

General Motors Ireland Ltd.
 Opel House, Unit 60, Heather Road
Sandyford, Dublin 18 – Ireland
 Tel. 00 353-1-216 10 00

General Motors Italia Srl
 Piazzale dell'Industria 40
00144 Rome – Italy
 Tel. 00 39-06-5 46 51

General Motors Nederland B.V.
 Lage Mosten 49 – 63
4822 NK Breda – Netherlands
 Tel. 00 31-76-5 44 83 00

General Motors Norge AS
 Kjeller-Vest 6
2027 Kjeller – Norway
 Tel. 00 47-23 50 01 04

General Motors Poland Sp. z o. o.
 Domaniewska 41
06-672 Warsaw – Poland
 Tel. 00 48- 22-606 17 00

General Motors Portugal
 Quinta da Fonte
 Edifício Fernão Magalhães, Piso 2
2780-190 Paço d'Arcos – Portugal
 Tel. 00 351- 21 440 75 00

General Motors Southeast Europe,
 org. zložka
 Apollo Business Centre
 Mlynské Nivy 45
821 09 Bratislava – Slovakia
 Tel. 00 421-2 58 275 543

General Motors España S.L.
 Paseo de la Castellana, 91
28046 Madrid – Spain
 Tel. 00 34-902 25 00 25

General Motors Norden AB
 Årstaängvägen 17
100 73 Stockholm – Sweden
 Tel. 00 46-20 333 000

General Motors Suisse S.A.
 Stelzenstraße 4
8152 Glattbrugg – Switzerland
 Tel. 00 41-44 828 28 80

General Motors Türkiye Ltd. Sti.
 Kemalpaşa yolu üzeri
35861 Torbalı/Izmir – Turkey
 Tel. 00 90-2 32-8 53-14 53

In **Albania, Bosnia-Herzegovina, Bulgaria, Croatia, Estonia, Latvia, Lithuania, Macedonia, Romania, Serbia-Montenegro and Slovenia** please contact the General Motors Service Department in Budaörs – Hungary
 Tel. 00 36-23 446 100.

Service plan, maintenance

| | |
|--------------------------------------|-----|
| A note on safety | 145 |
| Checking and topping up fluids | 145 |
| Engine oil | 145 |
| Diesel fuel filter | 149 |
| Engine air flow indicator * | 149 |
| Coolant | 150 |
| Brake fluid | 151 |
| Windscreen wiper | 152 |
| Windscreen wash system | 154 |
| Power steering fluid | 154 |
| Battery | 155 |
| Protection of electronic components | 155 |
| Vehicle storage | 156 |

In order to guarantee economical and safe vehicle operation and to maintain the value of your vehicle it is of vital importance that all maintenance work is carried out at the proper intervals as specified by Vauxhall in the Service Booklet. Time or mileage intervals - whichever is reached first - determine when your vehicle is due for its next service.

In the case of low mileage accumulation with frequent cold starts or predominantly urban traffic and stop-and-go traffic, an additional engine oil and filter change is recommended.

You will find the Service Booklet in the literature pack.

Have service work – and repair work to body and equipment – carried out by professionals. We recommend that you consult your Vauxhall Authorised Repairer. Your Vauxhall Authorised Repairer has excellent knowledge of Vauxhall vehicles, and has the special tools and the latest Vauxhall service instructions. It is particularly advisable to use a Vauxhall Authorised Repairer during the warranty period to avoid loss of warranty claims. See Service Booklet for additional information.

Separate anti-perforation inspection

Have this inspection performed regularly, either within the scope of a Service or separately, see Service Booklet. We recommend that you consult your Vauxhall Authorised Repairer in order to avoid loss of warranty claims for repair.



S 11814

A note on safety

To avoid the possibility of injury, only carry out engine compartment checks (e.g. checking the brake fluid level or the engine oil level) when the ignition is switched off.

Warning

The cooling fan may be operated by a thermostich and can therefore start to operate unexpectedly even when the ignition is switched off. Risk of injury.

Electronic ignition systems generate very high voltages. Do not touch the ignition system; high voltage can be fatal.

Never carry out any repairs or adjustment and maintenance work on the vehicle yourself. This especially applies to the engine, chassis and safety parts. You may out of ignorance infringe the provisions of the law and, by not performing the work properly, you may endanger yourself and other road users.

Checking and topping up fluids

To aid identification, the engine oil filler cap, the coolant expansion tank cap, the lid of the fluid container for the windscreen wash system and the handle of the oil dipstick may be coloured yellow.

Engine oil

Information on engine oils is available in the Service Booklet.

Engine oil level

It is normal for every engine to consume some oil, and it is sometimes necessary to check and top up the engine oil level between oil changes.

Warning

Do not allow the engine oil level to drop below the minimum level!

For this reason the engine oil level should be checked every 300 miles (500 km) or before starting a long trip.

Warning

Important: It is the owner's responsibility to maintain the proper level of an appropriate quality oil in the engine.

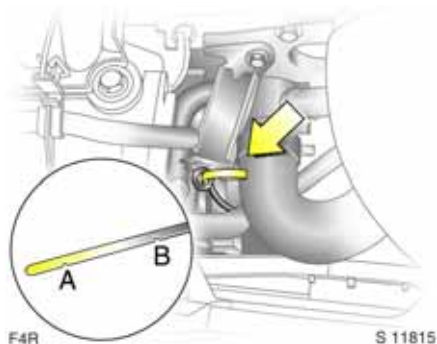

The illustrations show checking and replenishing the oil in the petrol and diesel engines respectively.

To check the level, remove the oil gauge (dipstick), wipe it clean and re-insert it as far as it will go.

Engine oil level check and topping up

The oil level must be checked with the vehicle horizontal and with the engine (which must be at operating temperature) switched off. Wait approximately 10 minutes before checking the level to allow the normal oil accumulation in the engine to drain back into the oil pan.

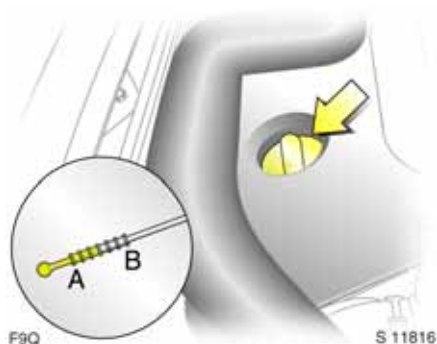

On F9Q engines the oil gauge is mounted on the oil filler cap which must be rotated anti-clockwise to open.

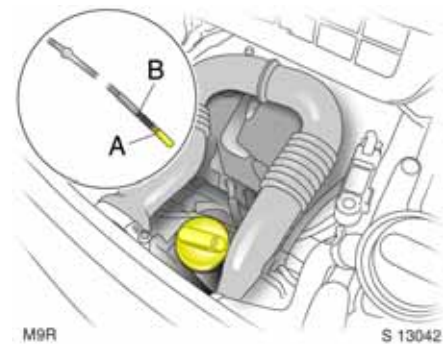

For M9R engines, rotate cap anti-clockwise, remove the oil gauge, wipe it clean and re-insert it as far as it will go.

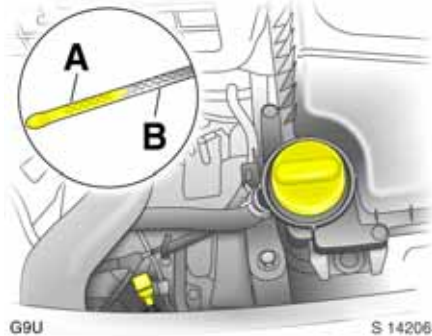

Top up if the oil level has dropped to the "add oil" mark **A**.

The oil level must not go above the upper mark **B** on the dipstick. This would lead, for example, to increased oil consumption, excessive formation of carbon residue and a possible risk of damage to the catalytic converter or engine.

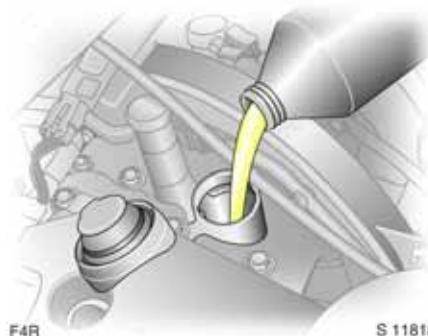

When replenishing, attempt to use the same type of oil as used at the last oil change.

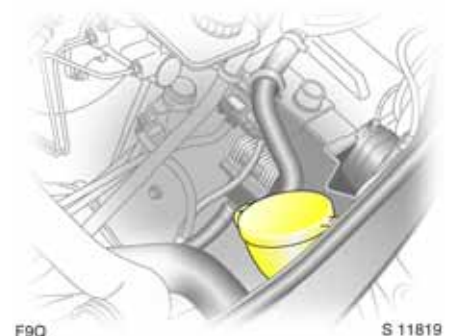

To prevent spillage when replenishing the engine oil on F9Q engines, use the funnel stored in the front of the engine compartment.

To release the funnel, raise the plastic catch on the funnel and lift upwards.

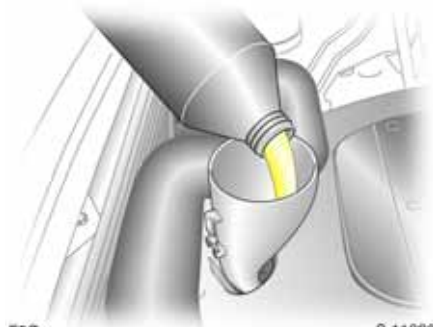

Remove the caps and ensure funnel is securely located onto the filler pipe.

Ensure the funnel is replaced securely together with both end caps fitted.

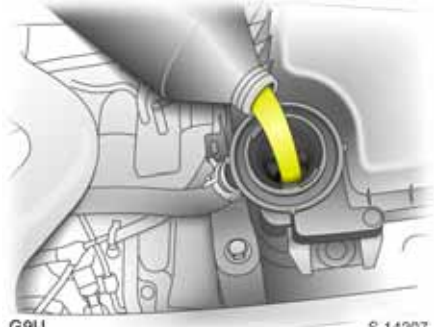

Capacities - see page 168.

A stabilization of the oil consumption will not take place until the vehicle has been driven several thousand miles. Only then can the actual degree of consumption be established.

If consumption exceeds more than 0.5 litre every 600 miles (1000 km) after this running-in period, consult a workshop. We recommend your Vauxhall Authorised Repairer.

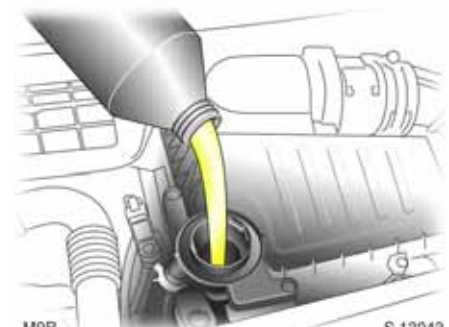

Remove the oil filler cap and top up as required. Do not overfill.

Oil change, oil filter change

Engine oil changes are to be carried out depending on time intervals or mileage intervals, since oil loses its lubrication properties not only through engine operation but also through ageing.

We recommend that you use genuine Vauxhall oil filters.

⚠ Warning

Used engine oil filters and empty oil containers should not be disposed of as domestic refuse. We recommend that you entrust oil and oil filter changes to a Vauxhall Authorised Repairer, who is familiar with legal requirements regarding disposal of used oil and can thus help to protect both the environment and your health.

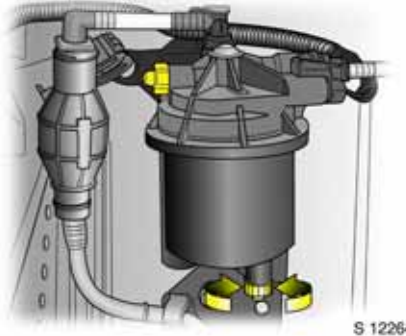
**Diesel fuel filter**

Drain fuel filter of residual water at every engine oil change.

Place a container underneath the filter housing. Loosen the knurled screws on the filter cover and on the lower part of filter by approx. one turn to drain off the water.

The filter is drained as soon as diesel emerges from the knurled screw at the bottom. Retighten the two screws.

Check fuel filter at shorter intervals if the vehicle is subjected to extreme operating conditions such as high humidity (primarily in coastal areas), extremely high or low outside temperatures and substantially varying daytime and night-time temperatures.

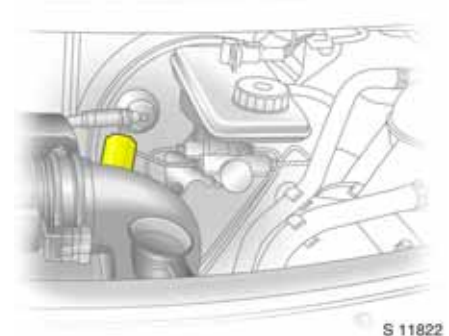
**Engine air flow indicator ***

On certain models, an indicator is located in the engine induction system and indicates if the air-intake to the engine is restricted.

Clear = No restriction
Red tell-tale = Restricted

If the red tell-tale is displayed when the engine is running consult a workshop. We recommend your Vauxhall Authorised Repairer.

Coolant

During operation the system is pressurized. The temperature may therefore rise to over 100 °C.

The anti-freeze provides excellent corrosion protection for the cooling and heating system, as well as freeze protection down to -28 °C.

Certain types of anti-freeze can lead to engine damage. We therefore strongly recommend the use of anti-freeze that has been approved by Vauxhall.

Warning

Anti-freeze is a danger to health; it must therefore be kept in the original container and out of the reach of children.

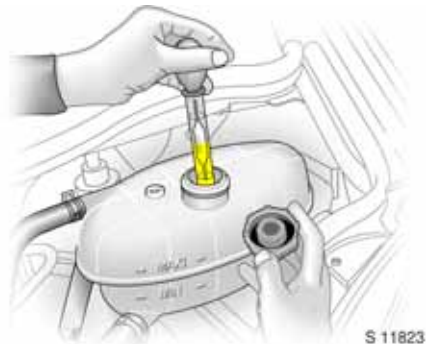

Freeze protection and corrosion protection

Before the start of the cold weather season, have the coolant checked for correct concentration. We recommend that you consult your Vauxhall Authorised Repairer. The amount of antifreeze must provide protection up to approx. -28 °C. If the antifreeze concentration is too low, this reduces protection from freezing and corrosion. Top up antifreeze if necessary.

If coolant loss is topped up with water, have anti-freeze concentration checked and more anti-freeze added as necessary.

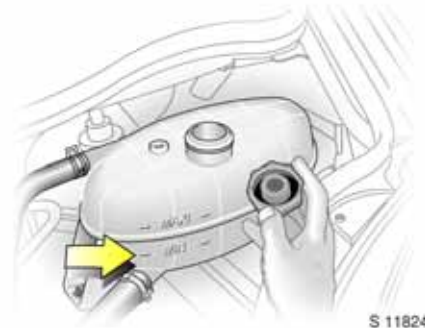

Coolant level

Hardly any losses occur since the cooling system is sealed and it is thus rarely necessary to top up the coolant.

The coolant level in the expansion tank should be slightly above the MIN mark when the system is cold. It rises at engine operating temperature and drops again when the engine cools down. If the level falls below the MIN mark, the coolant should be replenished to a little over the mark.

Warning

Allow engine to cool down before removing coolant filler cap. Remove filler cap carefully so that pressure can escape slowly, otherwise there is a risk of scalding.

Top up anti-freeze. If no anti-freeze is available, top up with clean tap water.

If tap water is unavailable, distilled water can be used.

After topping up with tap or distilled water, have the anti-freeze concentration checked, and anti-freeze added if necessary. Have the cause of the coolant loss remedied. We recommend that you consult your Vauxhall Authorised Repairer.

When closing, tighten coolant filler cap as far as it will go.

Coolant temperature

For physical reasons, the engine temperature gauge shows the coolant temperature only if the coolant level is adequate.

During operation the system is pressurized. The temperature may therefore rise to over 100 °C.

If the temperature gauge enters the uppermost zone, check the coolant level immediately.

■ Coolant level too low:

Top up coolant. Pay strict attention to the instructions given under "Anti-freeze and corrosion protection" and "Coolant level". Have the cause of coolant loss remedied. We recommend that you consult your Vauxhall Authorised Repairer.

■ Coolant level OK:

Have the cause of increased coolant temperature remedied. Contact a workshop. We recommend that you consult your Vauxhall Authorised Repairer.

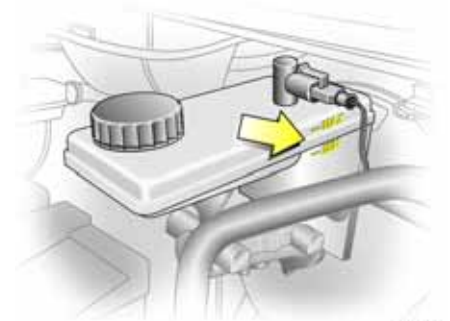

S 11825

Brake fluid

Brake fluid level

Warning

Caution - brake fluid is poisonous and corrosive. Do not allow it to contact eyes, skin, fabrics or painted surfaces. Direct contact may cause injuries and damage.

The fluid level in the container must not be higher than the "MAX" mark or lower than the "MIN" mark.

Use of some brake fluids could cause damage or impair braking effectiveness. Stay well informed. We recommend that you use Vauxhall-approved high performance brake fluid.

Extreme cleanliness is important, since brake fluid contamination can lead to brake system malfunctions.

After correcting the brake fluid level, have the cause of the loss remedied. We recommend that you consult your Vauxhall Authorised Repairer.

Brake fluid change

As brake fluid is hygroscopic, it absorbs water. Vapour bubbles which impair the braking effect may occur during braking.

The fluid change intervals specified in the Service Booklet must therefore be observed.

Warning

We recommend that you have brake fluid changed by a Vauxhall Authorised Repairer, who will be familiar with the requirements of the law as regards disposal of brake fluid and can thus help to protect the environment and your health.

Windscreen wiper

Clear vision is essential for safe driving.

Perform regular checks on the windscreen wipers to ensure they are operating correctly. We recommend wiper blade replacement at least once a year.

If the windscreen is dirty, operate the windscreen wash system before switching on the windscreen wiper. This will avoid wiper blade wear.

Do not switch on the windscreen wiper if the windscreen is iced up as this could damage the wiper blades or the wiper system.

If the wiper becomes frozen on to the glass, we recommend that they be released with the aid of Vauxhall De-icer Spray.

Smearing wiper blades can be cleaned with a soft cloth and Vauxhall Winscreen Wash Solvent.

Wiper blades whose lips have become hardened, cracked or covered with silicone must be replaced. This may be necessary as a result of the effects of ice, thawing salt or heat, or the incorrect use of cleaning agents.

Switch off the windscreen wiper in car washes – see pages 14 and 158.

Windscreen wiper care – see page 160.

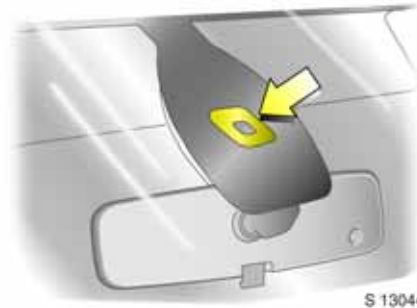

To ensure proper operation of the rain sensor ✱, the sensor area must be free from dust, dirt and ice. The windscreen wash system must also be operated at regular intervals and the sensor area must be de-iced. Vehicles with rain sensor can be identified by the sensor area near the top of the windscreen.

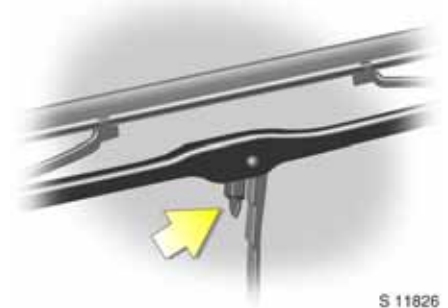

Front windscreen wiper

Lift wiper arm, move release lever and detach wiper blade.

Rear windscreen wiper ✱

Lift wiper arm, rotate wiper blade and detach.

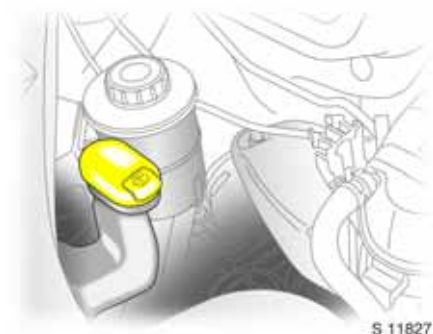

Windscreen wash system

The filler opening of the fluid container for the windscreen wash system is located on the front left-hand side - as seen from the front of the engine compartment.

Fill only with clean water to prevent the nozzles from clogging. To improve cleaning efficiency, we recommend that you add a little Vauxhall Windscreen Wash Solvent.

The windscreen wash system will not freeze in winter:

| Freeze protection down to | Mixture - Vauxhall Windscreen Wash Solvent : Water |
|---------------------------|--|
| - 5 °C | 1 : 3 |
| - 10 °C | 1 : 2 |
| - 20 °C | 1 : 1 |
| - 30 °C | 2 : 1 |

When closing the container, press the lid firmly over the beaded edge.

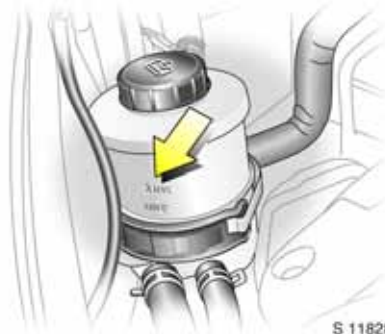

Power steering fluid

The power steering fluid does not require any additional maintenance than that detailed in the Service Booklet.

If the fluid in the reservoir falls below the MIN mark consult a workshop. We recommend your Vauxhall Authorised Repairer.

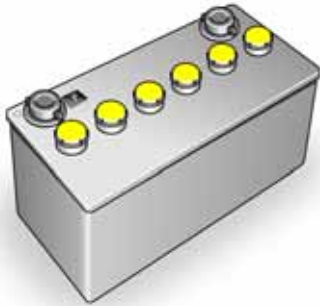

S 11829

Battery

Battery access

The battery is located beneath the front left-hand seat floor panel - see page 127.

Warning

Ensure adequate ventilation when charging the battery. There is a risk of explosion if gases generated during charging are allowed to accumulate!

Additional battery *

Depending on the vehicle auxiliary equipment certain models may have an additional battery located next to the vehicle battery.

Battery maintenance *

If the battery installed to your vehicle is not maintenance free:

Remove battery caps and ensure electrolyte level is 15 mm above the plates. Add distilled or demineralised water to correct the level.

If battery fluid level drops below the plates, do not attempt to test or recharge the battery or jump start the engine.

Warning

We recommend that you have battery changes carried out by a Vauxhall Authorised Repairer. He knows the laws concerning the disposal of used batteries and therefore protects the environment and your health.

Electrical or electronic accessories fitted at a later stage can place an additional load on the battery or discharge the battery. Consult a workshop. We recommend a Vauxhall Authorised Repairer, as regards technical possibilities, such as fitting a more powerful or an additional battery.



S 11814

Protection of electronic components

In order to avoid the breakdown of electronic components within the electrical system, never disconnect the battery with the engine running. Never start the engine while the battery is disconnected (e.g. when using jump leads).

The battery must be disconnected from the vehicle before being charged: first disconnect the negative cable and then the positive cable. The polarity of the battery, i.e. the connections for the positive and negative cables, must not be interchanged. When reconnecting, first connect the positive cable and then the negative cable.

To avoid damaging the vehicle, do not make any modifications to the electrical system, e.g. connecting additional consumers or tampering with electronic control units (chip tuning).

Warning

Electronic ignition systems generate very high voltages. Do not touch the ignition system; high voltage can be fatal.

Disconnecting/connecting the battery from/to the electrical system

Disconnect the battery from the vehicle electrical system before charging: First detach the negative and then the positive lead. Do not reverse the polarity of the battery, i.e. do not confuse the terminals for the positive and negative leads. When connecting, start with the positive lead and then connect the negative lead.

Vehicle storage

If your vehicle is to be stored for long periods without use, we recommend you consult your Vauxhall Authorised Repairer for advice.

Vehicle care

Consult a Vauxhall Authorised Repairer with regard to care aids tested and recommended by Vauxhall.

In caring for your vehicle observe all national environmental regulations, particularly when washing your vehicle.

Regular, thorough care contributes to improving the appearance of your vehicle and maintaining its value. It is also a prerequisite for claims made under the warranty in the event of paint or corrosion damage. In the following pages, we give you tips for vehicle care which, with correct use, will help to ward off unavoidable and harmful environmental influences.

Vehicle care aids *

Vehicle wash:

- Car Shampoo
- Sponges
- Chamois Leather
- Wheel Cleaners
- Engine Cleaners
- Glass Cleaners

Exterior care:

- Touch-up Paints
- Car Polishes/Colour Restorers
- Car Waxes/Sealers
- Rust Preventative
- Lubricant Sprays
- De-icer Sprays
- Tar Removal Spray
- Windscreen Wash Solvent

Interior care:

- Interior/Upholstery Cleaner

Washing

The paintwork of your vehicle is exposed to environmental influences, e.g. continuous changes in weather conditions, industrial waste gases and dust or thawing salts, so wash and wax your vehicle regularly. When using automatic car washes, select a programme which includes waxing.

Bird droppings, dead insects, resin, pollen and the like should be cleaned off immediately, as they contain aggressive constituents which can cause paint damage.

If using a car wash, comply with the pertinent instructions of the car wash manufacturer. The windscreen wiper, the automatic wiper with rain sensor ✱, and the back door / tailgate window wiper must be switched off – see page 14. Remove detachable rod antenna. Stand on the door sill to reach them more easily.

If you wash your vehicle by hand, make sure that the insides of the wings are also thoroughly rinsed out.

Clean edges and folds on opened doors and flaps as well as the areas they cover.

Thoroughly rinse off and leather-off the vehicle. Rinse leather frequently. Use separate leathers for paint and window surfaces: remnants of wax on the windows will impair vision.

Observe national regulations.

Waxing

Wax your vehicle regularly, in particular after it has been washed using shampoo and at the latest when water no longer forms beads on the paintwork, otherwise the paintwork will dry out.

Also wax edges and folds on opened doors and flaps as well as the areas they cover.

Polishing

Polishing is necessary only if the paint has become dull or if solid deposits have become attached to it.

Paintwork polish with silicone forms a protective film, making waxing unnecessary.

Plastic body parts should not be treated with wax and polish.

Use Metallic Paintwork Wax on vehicles with a metallic-effect paint finish.

Wheels

Use a pH-neutral wheel cleaning agent to clean the wheels.

Wheels are painted and can be treated with the same agents as the body. For alloy wheels we recommend use of Alloy Wheel Preserver.

Paintwork damage

Repair small areas of paint damage such as stone impacts, scratches etc. immediately using a Vauxhall touch-up applicator or Vauxhall spray and touch-up paint before rust can form. If rust has already formed, have the cause remedied. We recommend that you consult your Vauxhall Authorised Repairer. Please also pay attention to surfaces and edges beneath the vehicle where which rust may have formed unnoticed for some time.

Exterior lights

Headlight and other protective light bezels are made of plastic. If they require additional cleaning after the vehicle has been washed, clean them with Car Shampoo. Do not use any abrasive or caustic agents, do not use an ice scraper, and do not clean them dry.

Plastic and rubber parts

For additional cleaning of plastic and rubber parts use cleaner suitable for vehicle interiors. Do not use any other agent, and in particular do not use solvents or petrol.

Do not use high-pressure jet cleaners on wheels and tyres.

Wheels and tyres

Do not use high-pressure jet cleaners on wheels and tyres.

Interior and upholstery

Clean the vehicle interior, including the instrument panel fascia, using interior cleaner.

Clean fabric upholstery with a vacuum cleaner and brush. To remove stains, use cleaner that is suitable for both fabrics and vinyl.

Do not use cleaning agents such as acetone, carbon tetrachloride, paint thinner, paint remover, nail varnish remover, washing powder or bleach to clean fabrics, carpets, the dashboard or leather trim * in the vehicle interior. Petrol is also unsuitable.

Seat belts

Always keep seat belts clean and dry.

Clean only with lukewarm water or upholstery cleaner.

Windows

When cleaning the heated back door or tailgate windows, make sure that the heating element on the inside of the window is not damaged.

Use a soft lint-free cloth or chamois leather in conjunction with Window Cleaner and Insect Remover.

Vauxhall Winscreen Wash Solvent is suitable for de-icing windows.

For mechanical removal of ice, use a commercially available sharp-edged ice scraper. Press the scraper firmly against the glass so that no dirt can get under it and scratch the glass.

Windscreen wiper blades

Wax, such as that used in car washes, can cause streaks to form on the windscreen when the wiper is used.

Smearing wiper blades can be cleaned with a soft cloth and Vauxhall Windscreen Wash Solvent, and replaced if necessary – see page 152.

Locks

The locks are lubricated with a high-grade lock cylinder grease at the factory. Vauxhall lock cylinder grease prevents the locks from freezing up. Only use de-icing agent in emergencies, as they have a degreasing effect and will impair the function of the locks. After using a de-icing agent, have the locks re-greased. We recommend that you entrust this to your Vauxhall Authorised Repairer.

Engine compartment

Areas of the engine compartment that are painted in the same colour as the vehicle must be looked after like any other painted surface.

It is advisable to wash the engine compartment before and after winter and preserve it with wax. Cover alternator and brake fluid reservoir with plastic sheets before washing the engine.

When washing the engine with a steam-jet cleaner, do not direct the steam jet at components of the anti-lock brake system ❄️, the air conditioning system ❄️ or the belt drive and its components.

Protective wax that has been applied is also removed during the engine wash. For this reason, have the engine, brake system components in the engine compartment, axle components with steering, body parts and cavities thoroughly preserved with protective wax after the wash. We recommend that you consult your Vauxhall Authorised Repairer.

An engine wash can be performed in the spring in order to remove dirt that has adhered to the engine compartment, which may also have a high salt content. Check protective wax layer and make good if necessary.

Do not use high-pressure jet cleaners on wheels and tyres.

Underbody

Your vehicle has a factory-applied PVC undercoating in the wheel arches (including the longitudinal members) which provides permanent protection and needs no special maintenance. The surfaces of the vehicle underbody not covered by PVC are provided with a durable protective wax coating in critical areas.

On vehicles which are washed frequently in automatic car washes with underbody washing facility, the protective wax coating may be impaired by dirt-dissolving additives, so check the underbody after washing and have it waxed if necessary. Before the start of the cold weather season, check the PVC coating and protective wax coating and, if necessary, have them restored to perfect condition.

Caution – commercially available bitumen/rubber materials can damage the PVC coating. We recommend that you have underbody work carried out by a Vauxhall Authorised Repairer, who knows the prescribed materials and has experience in the use thereof.

The underbody should be washed following the end of the cold weather season to remove any dirt adhering to the underbody since this may also contain salt. Check protective wax coating and, if necessary, have it restored to perfect condition.

Technical data

Vehicle documents, identification plate 161

Engine identification..... 162

Coolant, brake fluid, oils 162

Engine data..... 163

Weights, payload and roof load 164

Tyre inflation pressures in bar/psi 167

Electrical system 168

Capacities 168

Dimensions (approx. mm)..... 169

Mounting dimensions of caravan/ trailer towing equipment..... 171

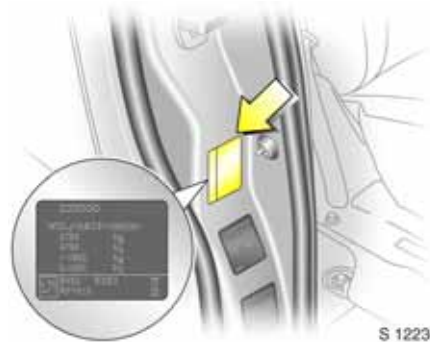

Vehicle documents, identification plate

The technical data is determined in accordance with European Community standards. We reserve the right to make modifications. Specifications in the vehicle documents always have priority over those given in this manual.

The vehicle identification number (VIN) is on the vehicle identification plate, located on the right hand door pillar.

The vehicle identification plate also lists, in kilograms, the Gross Vehicle Weight (GVW), the Gross Combination Weight (GCW) and the maximum front and rear axle loads respectively. Observe these limits when using the full load or towing capacity of your vehicle.



Information on identification plate¹⁾:

- 1 Manufacturer
Type approval number
(see separate plate below)
- 2 Vehicle identification number
- 3 Permissible gross vehicle weight
- 4 Permissible gross train weight
- 5 Maximum permissible front axle load
- 6 Maximum permissible rear axle load
- 7 Vehicle-specific or country-specific data

¹⁾ The VIN plate on your vehicle may differ from the illustration shown.

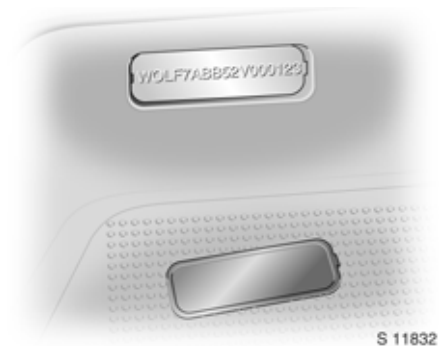

It is also displayed behind a removable plastic cover on the right hand side door step and on a fixed plate located on the left hand side of the dashboard top.

Engine identification

It is possible, using the Vehicle Identification number (VIN), to determine the engine type that is installed in your vehicle. The seventh digit denotes the engine type:

| 7th character | Engine |
|---------------|--------------------------------------|
| C: | 1.9 Diesel, F9Q 760 |
| H: | 2.0 Diesel, M9R 780 (high output) |
| J: | 2.5 Diesel, G9U 630 (high output) |
| K: | 1.9 Diesel, F9Q 760 (Turkey only) |
| L: | 2.0 Petrol, F4R 820 |
| M: | 2.0 Diesel, M9R 780 (low output) |
| _1) | 2.5 Diesel, G9U 630 (low output) |

¹⁾ Information not available at time of print.

Engine identifier code and engine number

Stamped on the lower rear of the engine block on an identification plate.

Coolant, brake fluid, oils

When topping up:

- Coolant,
- Brake fluid,
- Manual transmission oil,
- Power steering fluid.

We recommend that you consult your Vauxhall Authorised Repairer, who can advise you on the correct products to use.

Use of unsuitable fluids could cause severe damage to the vehicle.

Engine oils

Information on engine oils is available in the Service Booklet.

Engine data

| | | | | | | |
|---|----------------|-----------------------------|----------------|-----------------------------|----------------|------------------------|
| Sales designation | 1.9 | 2.0 | 2.0 | 2.5 | 2.5 | 2.0 |
| Engine identifier code | F9Q 760 | M9R 780¹⁾ | M9R 780 | G9U 630¹⁾ | G9U 630 | F4R 820 |
| Number of cylinders | 4 | 4 | 4 | 4 | 4 | 4 |
| Bore dia. (mm) | 80 | 84 | 84 | 89 | 89 | 82.7 |
| Stroke (mm) | 93 | 90 | 90 | 99 | 99 | 93 |
| Piston displacement (cm ³) | 1870 | 1995 | 1995 | 2464 | 2464 | 1998 |
| Max. engine power (kW) at rpm | 74 3500 | 66 3500 | 84 3500 | 84 3500 | 107 3500 | 86 4700 |
| Torque (Nm) at rpm | 240 1800 | 240 1500 | 290 1600 | 290 1600 | 310 2100 | 186 3750 |
| Compression ratio | 18.3 | 15.6 | 15.6 | 17.1 | 17.1 | 9.8 |
| Cetane requirement (CN) ²⁾³⁾ | 49 (D) | 49 (D) | 49 (D) | 49 (D) | 49 (D) | - |
| Octane requirement (RON) ⁴⁾ | - | - | - | - | - | |
| unleaded | | | | | | 95⁴⁾ |
| or unleaded | | | | | | 98⁴⁾ |
| or unleaded | | | | | | 91⁵⁾ |

1) Low output

2) Standard high quality fuels, e.g. diesel EN 590; value printed in bold: recommended fuel.

3) A lower value is possible with winter fuels

4) Standard high-quality fuels, e.g. unleaded EN 228; value printed in bold: recommended fuel.

5) If no unleaded premium-grade fuels are available, 91 RON can be used, taking care to avoid severe engine loads and driving at full throttle.

Weights, payload and roof load

The payload is the difference between the permissible gross vehicle weight and the EC kerb weight.

The combined total of front and rear axle loads (see vehicle identification plate) must not exceed the permissible gross vehicle weight, i.e. if the front axle load is being fully utilized, the rear axle load must not be such that the permissible gross vehicle weight is exceeded.

Optional equipment and accessories increase the kerb weight and in some cases also the permissible gross vehicle weight, which means that the payload will also change slightly.

Note the weights given on the vehicle identification plate. Both the Gross Vehicle Weight (GVW) and Gross Combination Weight (GCW) are shown on the VIN plate - see page 161.

The maximum permissible roof load (which includes the weight of the roof rack) is 280 kg for standard roof variants and 210 kg for high roof variants.

The maximum load on the Vauxhall full length roof rack system is 210 kg for standard roof variants and 140 kg for high roof variants.

Driving hints – page 95.

Vehicle weights (approx. kg)

| Model | Wheelbase | Roof | Payload Class | Engine ¹⁾ | Kerb weight ²⁾³⁾ |
|-------|-----------|----------|---------------|----------------------|-----------------------------|
| Van | Short | Standard | 1000 | F9Q | 1660 |
| | | | | M9R | 1678 |
| | | | | F4R | 1660 |
| | | G9U | 1736 | | |
| | | Standard | 1200 | F9Q | 1669 |
| | | | | M9R | 1688 |
| | F4R | | | 1660 | |
| | High | 1200 | G9U | 1737 | |
| | | | F9Q | 1713 | |
| | | | M9R | 1760 | |
| | | Standard | 1200 | F4R | 1695 |
| | | | | G9U | 1810 |
| F9Q | | | | 1676 | |
| Long | Standard | M9R | 1724 | | |
| | | F4R | 1660 | | |
| | | G9U | 1772 | | |

¹⁾ Sales designation: see page 163.

²⁾ Without driver, base model including all fluids (tank 90% full).

³⁾ Kerb weight and Gross Vehicle Weight (GVW) increase on models fitted with bad road equipment package - refer to VIN plate.

Vehicle weights (approx. kg)

| Model | Wheelbase | Roof | Payload Class | Engine ¹⁾ | Kerb weight ²⁾³⁾ | |
|-----------------|-----------|----------|---------------|----------------------|-----------------------------|------|
| Van (continued) | Long | High | 1200 | F9Q | 1761 | |
| | | | | M9R | 1810 | |
| | | | | F4R | 1745 | |
| | | | | G9U | 1860 | |
| Combi | Short | Standard | 1000 | F9Q | 1835 | |
| | | | | M9R | 1883 | |
| | | | | F4R | 1818 | |
| | | | | G9U | 1940 | |
| | | | | 1200 | F9Q | 1846 |
| | | | | | M9R | 1893 |
| | | | | | F4R | 1829 |
| | | | | | G9U | 1942 |
| | Long | Standard | 1200 | F9Q | 1906 | |
| | | | | M9R | 1954 | |
| | | | | F4R | 1890 | |
| | | | | G9U | 2003 | |

1) Sales designation: see page 163.

2) Without driver, base model including all fluids (tank 90% full).

3) Kerb weight and Gross Vehicle Weight (GVW) increase on models fitted with bad road equipment package - refer to VIN plate.

166 Technical data

Vehicle weights (approx. kg)

| Model | Wheelbase | Roof | Payload Class | Engine ¹⁾ | Kerb weight ²⁾³⁾ |
|--------------|-----------|----------|---------------------------|----------------------|-----------------------------|
| Crew cab | Short | Standard | 1000 | F9Q | 1660 |
| | | | | M9R | 1678 |
| | | | | G9U | 1736 |
| Platform cab | Long | Standard | 1200 | F9Q | 1467 ⁴⁾ |
| | | | | M9R | 1515 ⁴⁾ |
| | | | | F4R | 1449 ⁴⁾ |
| | | | | G9U | 1563 ⁴⁾ |
| Tour | Short | Standard | 900 | M9R | 1944 |
| | | | | F4R | 1879 |
| | | | | G9U | 2018 |
| Dropside | Long | Standard | 1035 / 1065 ⁵⁾ | F9Q | - |

1) Sales designation: see page 163.

2) Without driver, base model including all fluids (tank 90% full).

3) Kerb weight increases on models fitted with bad road equipment package - refer to VIN plate.

4) Vehicle without body conversion.

5) Standard / Low floor variants.

Tyre inflation pressures in bar/psi

The tyre pressures given are valid for cold tyres. The increased tyre pressure resulting from extensive driving must not be reduced.

The pressures given apply to both summer and winter tyres.

See page 117.

Tyre chains

- see page 121.

Restrictions

Tyre chains may be used on the front drive wheels only.

Tyre chains for 215/65 R16 tyres, we recommend you consult your Vauxhall Authorised Repairer.

Wheels

Tightening torque: 140 Nm.

| Type ¹⁾ | Inflation pressure with full load (bar/psi) ^{2) 3)} | |
|----------------------------|--|--------|
| | Front | Rear |
| 195/65 R16 C | 3.4/50 | 3.7/54 |
| 195/75 R16 C ⁴⁾ | 3.8/55 | 4.2/61 |
| 205/65 R16 C | 3.8/55 | 4.2/61 |
| 215/65 R16 C | 3.1/45 | 3.4/50 |

¹⁾ If tyres of a different size to the factory fitted type are used (this includes winter tyres), the electronic speedometer may need to be reprogrammed - see page 117.

²⁾ To convert to kPa multiply bar by 100 (1 bar = 100 kPa).

³⁾ The spare wheel should be set to the highest applicable pressure shown on the table.

⁴⁾ For models with bad road equipment package.

Electrical system**Vivaro**

| | | |
|----------------------------|-----------|---------|
| Battery | Voltage | 12 V |
| | Amp hours | 85 Ah |
| Battery for remote control | | CR 1220 |

Capacities

(approx. in litres)

| Engine¹⁾ | M9R | F9Q | F4R | G9U |
|--|------------|------------|------------|------------|
| Cooling system | 6.4 | 6.4 | 5.4 | 8.0 |
| Fuel tank | 90 | 90 | 90 | 90 |
| Engine oil with filter change | 6.6 | 4.8 | 5.5 | 7.5 |
| Engine oil between MIN and MAX on dipstick | 1.5 - 2.0 | 1.5 - 2.0 | 1.5 - 2.0 | 1.5 - 2.0 |

¹⁾ Sales designation: see page 163

Dimensions (approx. mm)

| Type | Van | | Crew cab | | Combi/Tour ¹⁾ | | Dropside | Platform cab |
|--------------------------------|-------|------|----------|------|--------------------------|------|---------------------------|-------------------------|
| | Short | Long | Short | Long | Short | Long | Long | Long |
| Wheelbase | Short | Long | Short | Long | Short | Long | Long | Long |
| Length | 4782 | 5182 | 4782 | 5182 | 4782 | 5182 | 5350 / 5438 ²⁾ | 5130 |
| Width | 1904 | 1904 | 1904 | 1904 | 1904 | 1904 | 1980 | 1904 |
| with exterior mirrors | 2232 | 2232 | 2232 | 2232 | 2232 | 2232 | 2206 | 2232/2434 ³⁾ |
| Height ⁴⁾ - unladen | | | | | | | | |
| Standard roof | 1968 | 1968 | 1959 | 1959 | 1968 | 1968 | 2000 | 1981 |
| High roof | 2492 | 2492 | - | - | - | - | - | - |
| Wheelbase | 3098 | 3498 | 3098 | 3498 | 3098 | 3498 | 3498 | 3498 |
| Track width: | | | | | | | | |
| Front | 1615 | 1615 | 1615 | 1615 | 1615 | 1615 | 1615 | 1615 |
| Rear | 1630 | 1630 | 1630 | 1630 | 1630 | 1630 | 1630 | 1630 |

¹⁾ Tour available as short wheel base only.

²⁾ Standard / Low floor variants.

³⁾ With wide arm rear view mirrors.

⁴⁾ Vehicle height without body conversion (except Dropside).

170 Technical data

Loadspace dimensions - (approx. mm)

| Wheelbase | Van | | Crew Cab | | | |
|-------------------------------------|---------------|-----------|---------------|-----------|---------------|---------------|
| | Short | Long | Short | Long | Short | Long |
| Roof height | Standard Roof | High Roof | Standard Roof | High Roof | Standard Roof | Standard Roof |
| Maximum rear door aperture height | 1335 | 1818 | 1335 | 1818 | 1320 | 1320 |
| Rear door aperture width (at floor) | 1390 | 1390 | 1390 | 1390 | 1390 | 1390 |
| Maximum load area height | 1387 | 1913 | 1387 | 1913 | 1387 | 1387 |
| Maximum load area width | 1690 | 1690 | 1690 | 1690 | 1690 | 1690 |
| Width between wheel arches | 1268 | 1268 | 1268 | 1268 | 1268 | 1268 |
| Max load floor length | 2400 | 2400 | 2800 | 2800 | 1906 | 2306 |
| Loading height unladen | 543 | 547 | 542 | 548 | 549 | 542 |
| Sliding side door aperture width | 1000 | 1000 | 1000 | 1000 | 1000 | 1000 |
| Sliding side door aperture height | 1285 | 1285 | 1285 | 1285 | 1285 | 1285 |

Mounting dimensions of caravan/trailer towing equipment

| Dimension | mm |
|-----------|-------|
| A | 933 |
| B | 392 |
| C | 289.1 |
| D | 59 |
| E | 57 |
| F | 1032 |
| G | 337 |
| H | 55 |

Warning

We recommend having caravan/trailer towing equipment retrofitted by a Vauxhall Authorised Repairer.

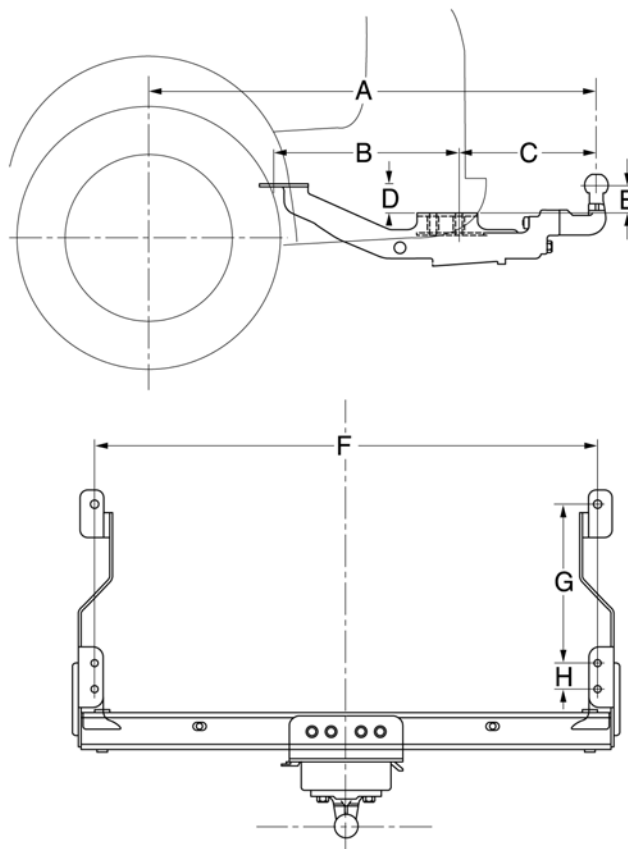

Official authorisation label for the radio frequency remote control

Europe:

CE0523 ⓘ

Index

A

| | |
|--|-----|
| ABS | 115 |
| Accessories | 19 |
| Accessory socket | 54 |
| Aerial | 158 |
| Air conditioning | 85 |
| rear | 86 |
| Airbag | 56 |
| Airbag systems | |
| Front | 61 |
| Head airbags | 63 |
| Side | 62 |
| Anti-corrosion service | 144 |
| Anti-freeze | 150 |
| Anti-freeze protection | 154 |
| Anti-knock quality of fuel | 99 |
| Anti-theft locking system | 43 |
| Ashtrays | 55 |
| Automatic dipped beam activation | 76 |

B

| | |
|------------------------------------|----------|
| Back door wiper system | 15 |
| Back doors | 45 |
| Battery | |
| Access | 127, 155 |
| Interruption of power supply | 30 |
| Maintenance | 155 |
| Bonnet | 46 |
| Brake fluid | 151 |
| Brakes | 113 |
| Bulb replacement | 138 |
| Fog lights | 141 |
| Fog tail light | 140 |
| Front turn signal indicator | 139 |
| Headlights | 138 |
| Instrument illumination | 141 |
| Interior lamps | 141 |
| Interior lights | 141 |
| Number plate light | 140 |
| Parking light | 138 |
| Reverse lights | 140 |
| Side repeater light | 139 |
| Tail and brake lights | 139 |
| Third brake light | 141 |

C

| | |
|------------------------------|--------------------|
| Capacities | 168 |
| Caravan/trailer loads | 122 |
| Catalytic converter | 102, 103, 105, 126 |
| Central locking | 2, 41 |
| Child restraint system | 68 |
| Child safety locks | 37 |
| Cigarette lighter | 54 |
| Cleaning | 157 |
| Clock | 26, 29 |
| Code numbers | 2 |
| Colour info display | 31 |
| Control indicators | 20 |
| Coolant | 24, 150, 162 |
| Coupling socket load | 123 |

D

| | |
|------------------------------------|--------------|
| Date display | 29 |
| Demisting | 17, 84 |
| Diesel fuel filter | 149 |
| Diesel fuel system, bleeding | 125 |
| Diesel particle filter | 104 |
| Dipped and main beam | 12 |
| Door locks | 2, 160 |
| Door-to-door illumination | 77 |
| Drink holders | 55 |
| Drive Control Systems | 106 |
| Driving abroad | 78, 142, 143 |
| Dropside body | 109 |

E

| | |
|--|----------|
| Economical driving | 97 |
| Electric windows | 80 |
| Electrical mirrors | 6 |
| Electronic immobilizer | 38 |
| Engine control indicator | 104 |
| Engine data | 163 |
| Engine oil | 145, 162 |
| Engine oil life monitor | 105 |
| Engine wash | 160 |
| ESP (Electronic Stability Program) | 106 |
| Exhaust | |
| Emissions | 103 |
| Gases | 16, 105 |

F

| | |
|-------------------------------|---------|
| First-aid kit | 130 |
| Flat tyre | 133 |
| Fog lights | 77 |
| Fog tail light | 12 |
| Foot brake | 114 |
| Front doors | 37 |
| Fuel | 99, 100 |
| Consumption | 97, 99 |
| Fuel for diesel engines | 100 |
| Fuel for petrol engines | 99 |
| Gauge | 24 |
| Fuse box | 136 |

G

| | |
|--------------------------------|-----|
| Genuine Vauxhall | |
| Parts and Accessories | 142 |
| Glove compartment cooler | 86 |

H

| | |
|----------------------------------|---------|
| Hand brake | 18, 114 |
| Hazard warning flashers | 13 |
| Head restraints | 4, 47 |
| Headlamps | |
| Aiming | 138 |
| Flash | 12 |
| Range adjustment | 76 |
| Headlight range adjustment | 138 |
| Headlights | 12, 75 |
| Heated front seats | 88 |
| Heated rear windows | 17, 87 |
| Heating | 81, 84 |
| Horn | 13 |

I

| | |
|------------------------------------|--------|
| Ignition | 16, 17 |
| Indicators | 13 |
| Instruments | 20 |
| Illumination | 78 |
| Interior lights | 77, 78 |
| Interruption of power supply | 28 |

J

| | |
|------------------------------|-----|
| Jack and vehicle tools | 130 |
|------------------------------|-----|

K

Key 2

L

Laden programme 92

Lashing points 52

Leather trim 159

Light switch 12, 75

Lighting 75

Load anchorage rails 52

Load compartment net 51

Loadspace dimensions 170

Locks 160

M

Maintenance 19

Manual transmission 15

Mirrors 6, 74

Mobile telephones

and radio equipment (CB) 36

Multifunction display 25

O

Octane numbers 99

Oil level display 25

P

Paintwork damage 159

Park pilot 107

Parking 18

Parking distance sensor 107

Petrol 99

Pinking 99

Power steering fluid 154

Protection of electronic components ... 155

Puncture repair system 133

R

Radio 35

Rain sensor 153

Rear axle load during towing 123

Refuelling 100

Remote control

 Battery changing 40

Removable rear seats 50

Replacement keys 37

Reverse lamps 77

Roof rack 98

S

Safety 145

Safety accessories 70, 71, 72, 73, 74

Saving energy 97

Saving fuel 97

Seat belts 5, 56, 57, 159

Seats 2, 47

 Back adjustment 3

 Folding 49

 Height adjustment 4

 Removable 50

Self-diagnosis 60

Service 19

Service Booklet 19

Service interval display 29

Slam door locks 47

Sliding side door 44

Sliding side windows 80

Spare keys 37

Speed

 Fuel consumption 97

 Speedometer 23

Starter switch 7

Starting on inclines 124

Starting the engine 16, 17

 Jump leads 126

 Pushing or towing 126

Steering column lock 7

Steering wheel

 Adjustment 5

 Mounted remote control 35

Sun visors 74

T

| | |
|----------------------------------|---------------|
| Tachometer | 23 |
| Tailgate | 45 |
| Tailgate wiper system | 15 |
| Tecshift | 15, 89 |
| Towing | 124, 129 |
| Equipment | 122, 171 |
| Service | 129 |
| Transmission display | 25, 89 |
| Trip computer | 26 |
| Resetting | 28 |
| Trip odometer | 26 |
| Triple | 29 |
| Triple information display | 29 |
| Turn signal lights | 13 |
| Tyre repair kit | 133 |
| Tyres | |
| Chains | 121 |
| Condition | 118 |
| Inflation pressures | 117, 123, 167 |

U

| | |
|---------------------|----|
| Unleaded fuel | 99 |
|---------------------|----|

V

| | |
|------------------------------|------------|
| Vauxhall Genuine Parts | 19 |
| Vauxhall Service | 19 |
| Vehicle care | 157 |
| Vehicle loading | 53 |
| Vehicle weights | 164, 165 |
| Ventilation | 81, 82, 83 |

W

| | |
|--|-----|
| Washing the vehicle | 157 |
| Wheels | 117 |
| Changing | 131 |
| Windows | 79 |
| Electric | 80 |
| Windscreen wash system | 14 |
| Anti-freeze protection | 154 |
| Winter operation | |
| Locks | 160 |
| Windscreen wash system, anti-freeze protection | 154 |
| Winter programme | 91 |
| Winter tyres | 120 |



©Copyright by Vauxhall Motors Ltd., England.

Reproduction or translation, in whole or in parts, is not permitted without prior written consent from Vauxhall Motors Ltd.

All rights as understood under the copyright laws are explicitly reserved by Vauxhall Motors Ltd.

All information, illustrations and specifications contained in this manual are based on the latest production information available at the time of publication.

The right is reserved to make changes at any time without notice.

Edition: January 2007.

TS 1545-B-07

