

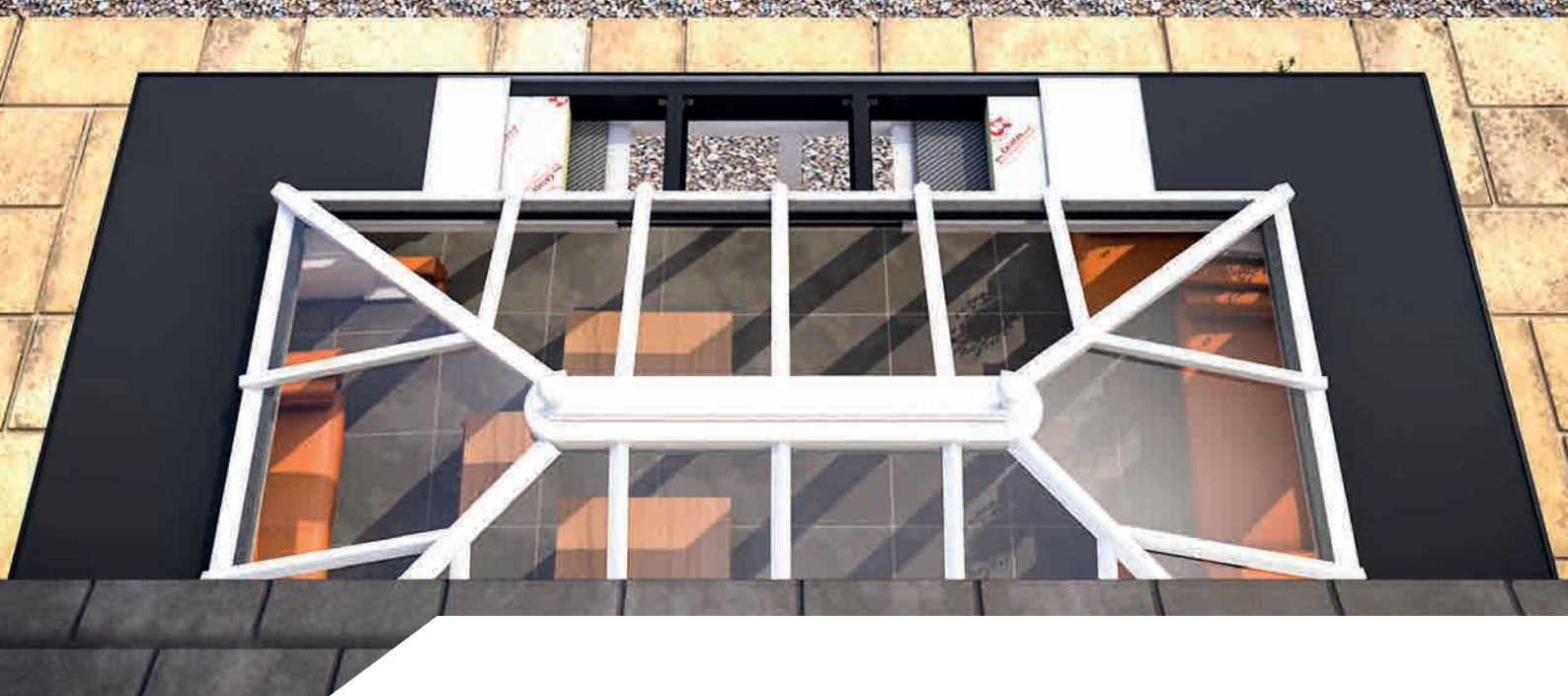

Iceni Installer Guides
LEKA ORANGERY ROOF





The Leka Orangery Roof Installation Guide

The Leka orangery flat roof platform has been introduced into the market place to satisfy a number of different needs for both the homeowner and installation company.

The purpose of the kit will be to sustain its own weight as well as additional snow/wind loads, along with housing a conservatory roof lantern centrally.

The Leka System is designed to be of similar weight, or lighter than a traditional orangery roof of equal size. It follows that the existing glazed walls, if correctly specified for the original glazed roof, should be capable of supporting the replacement Leka Systems Orangery Roof.

It is the sole responsibility of the installer to establish the structural suitability of the existing conservatory wall system, to establish the location of any structural or reinforcing elements, and to ensure that the Leka Roof system is fixed to the existing structural elements so that gravity and wind loads are transferred safely through the existing walls to the conservatory foundations



NOTE: for ECO and ECO+ installations

ECO

Leka ECO

The Leka Eco option requires the installer to supply use standard 12.5mm foil backed plasterboard instead of the existing Leka Internal board.

Prior to installing your plasterboard it is recommend to cut your 15mm x 10mm pvc block batten with snips and adhere these centrally to your insulation sheet using sealant. This needs to set and bond before beginning your plasterboard fixing.

This is used as a packer and also an additional fixing location for the centre of your plasterboards.

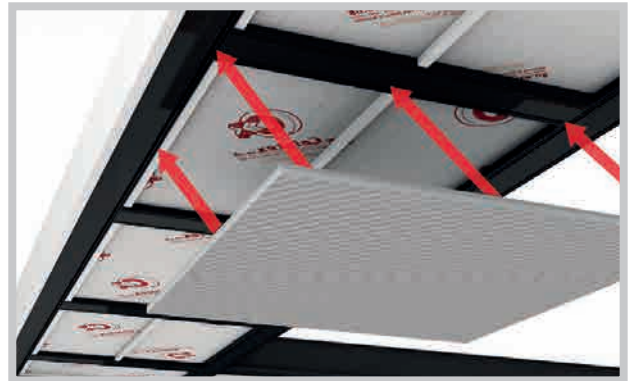

ECO+

Leka ECO+

The Leka Eco+ option also requires the installer to supply use standard 12.5mm foil backed plasterboard instead of the existing Leka Internal board AND the Leka roof will also be supplied with 135mm GREY EPS.

You should insert the EPS into your roof following much of the same process as if your were installing a sheet of Celotex. So sealant is still required on the arms/wings of the rafter profiles before inserting your EPS.

The only difference in installation process is foaming your joints rather than using insulation tape. Foam should be supplied around all joints.

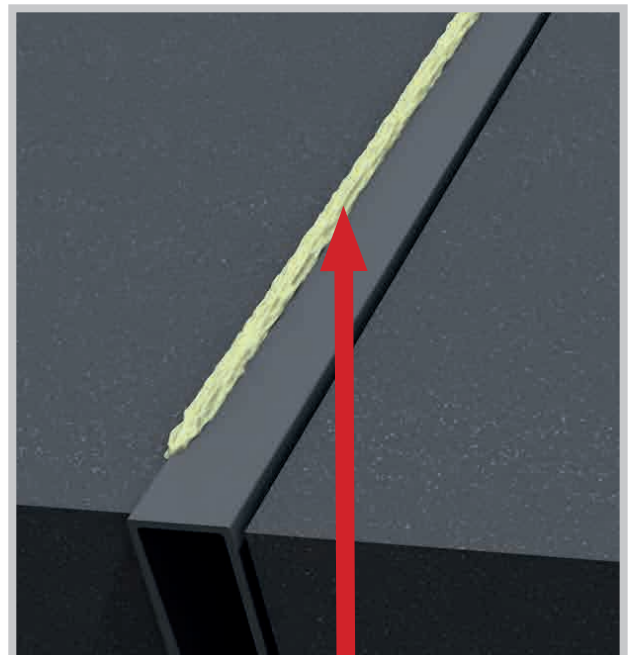

Foam sealant being applied before being smoothed down

1). Ladder Pieces

1a

Depending on the size on your roof, you would normally have 4 ladder sections. Your GRP ladder pieces should be laid directly onto your window frame and block work unless you are inserting your own steel or concrete lintels etc. Your heavy duty brackets and other brackets are pre-fitted for you by the manufacturer. Ensure You apply high grade sealant between the ladder and window frames/wall prior to laying your ladder onto these surfaces. Your heavy duty brackets (pre-fitted to the ladders) must be fixed to the house wall appropriately.

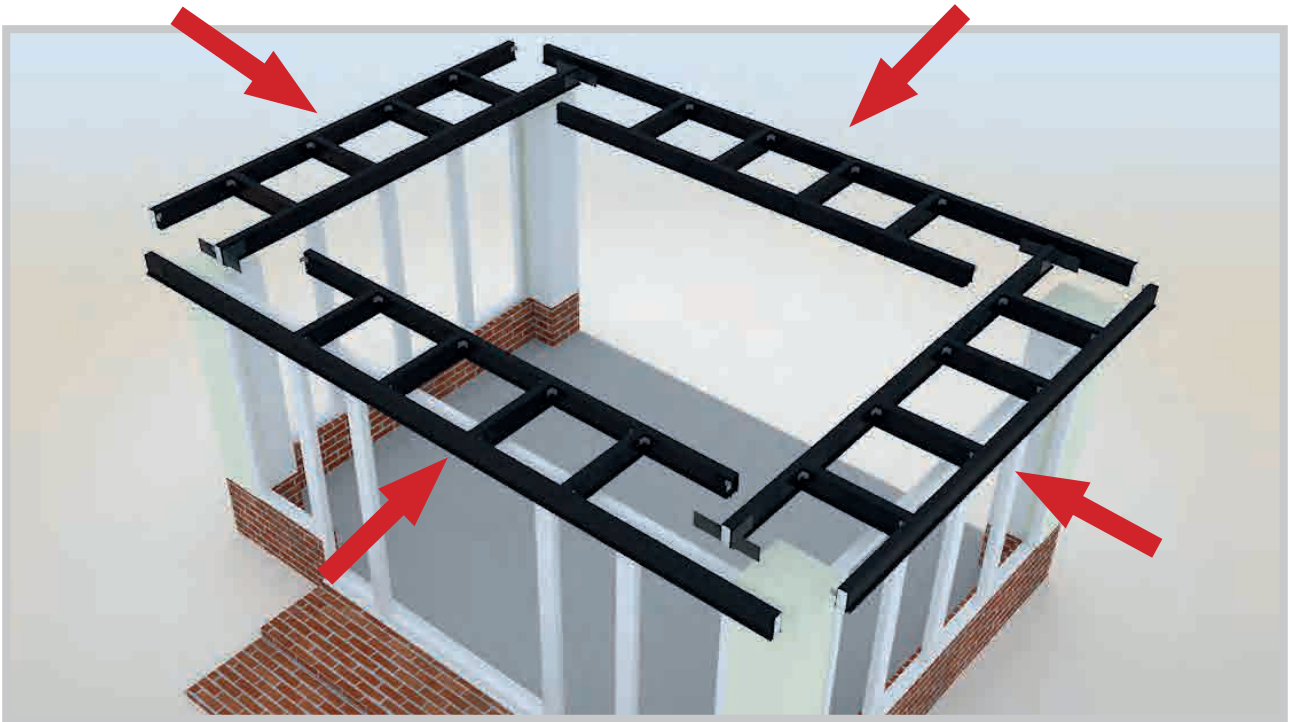

! Notice: Brackets and fixings are illustrated as a light chrome in colour throughout this guide. This is for clarity and illustrative purposes. Your fixings will most likely be black in order to match the colour of your GRP.



1b

Once the ladders have been dropped into place they should then be fixed by your M8 bolts to secure your ladders in place.

8 M8 bolts should be used for (4 per face face) on each of the large fitted brackets.

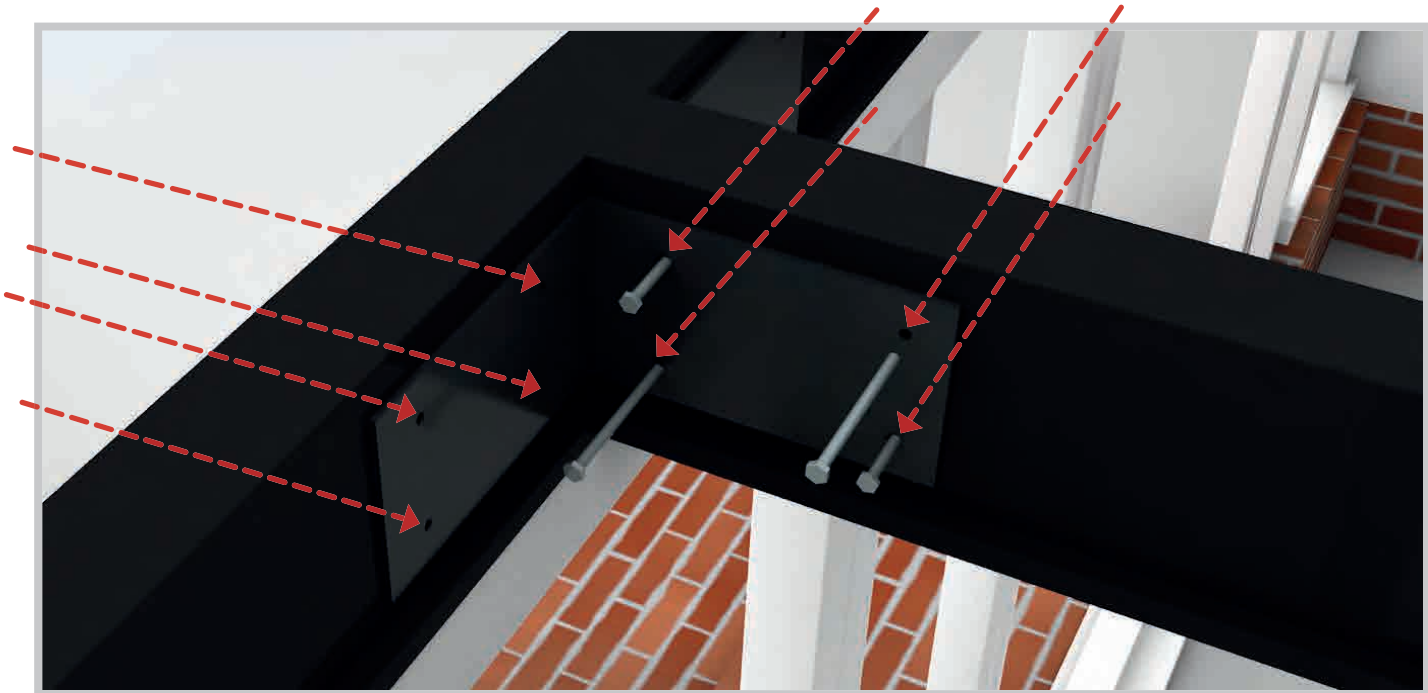

1c

The L-shaped brackets (already attached) are used to fix the ladders together with 42mm coated screws. As standard 12 screws should be used per bracket (6 for each bracket face).

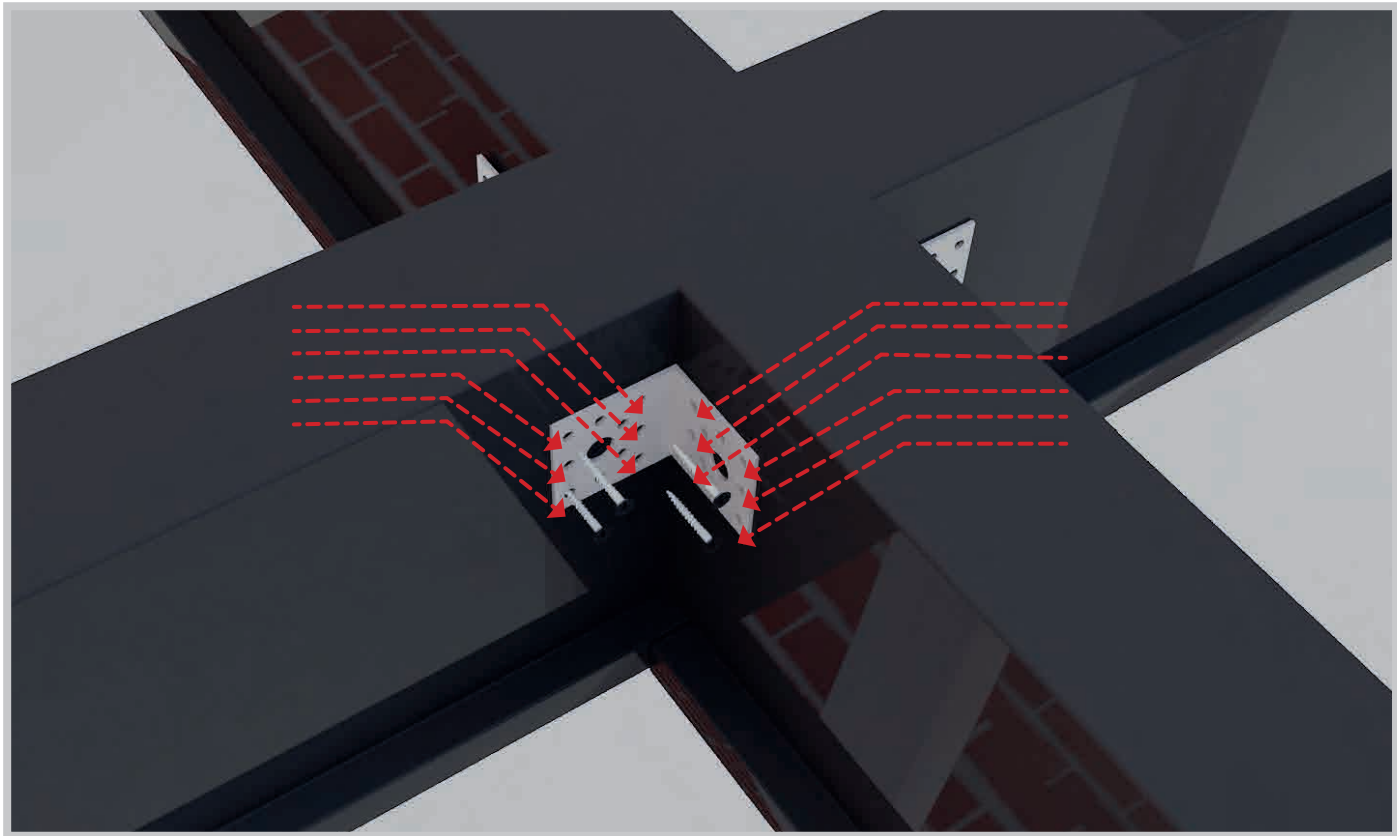

1d

Loose L shaped brackets are supplied for you to manually connect to the ladders as shown and for connecting the profile structure to your window frames below in the location you choose. For connecting to brick work you should source appropriate wall straps.



L shape brackets should be fitted as the below example with 6 screws per face (if possible) Screw fixings from these brackets should go downward into your window frames

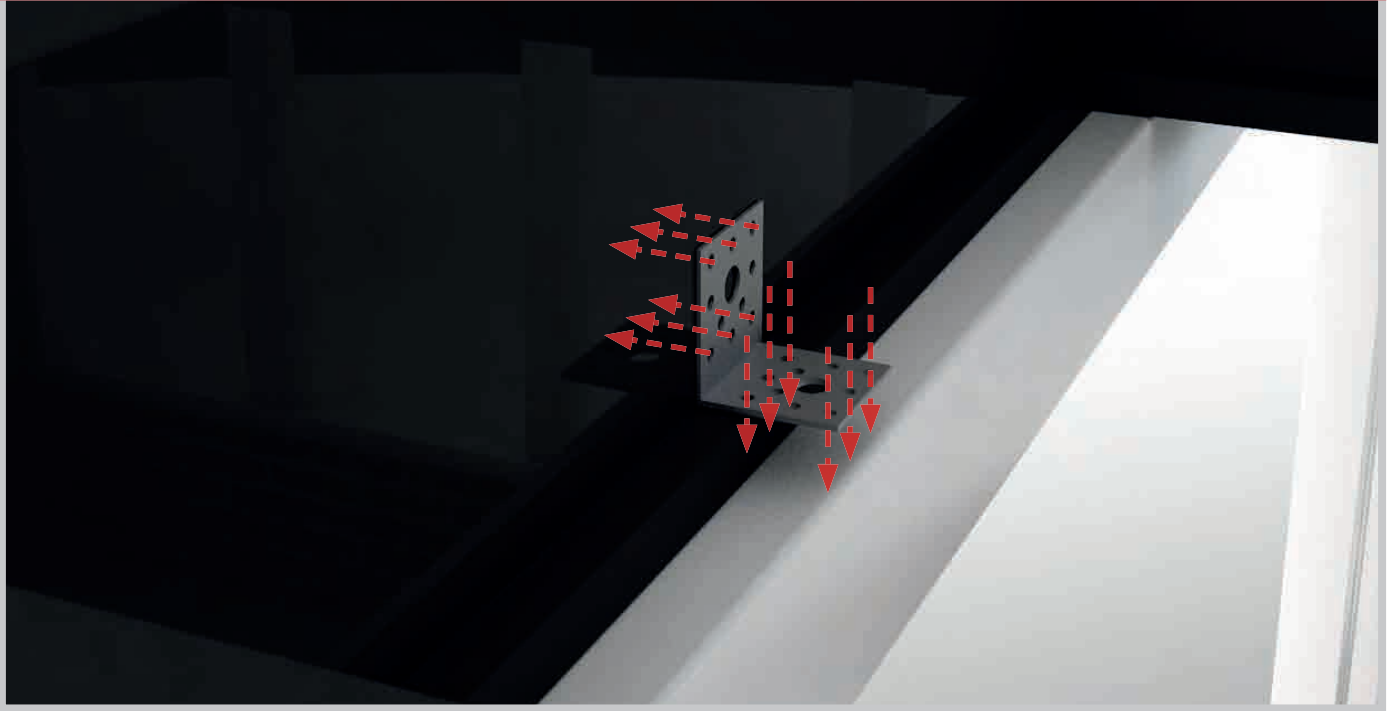

On fixing the ladders to the house, you as the installer should rely on your judgement over which bolts to use and will depend on the circumstance faced (eg. stone wall etc.).





The upstand profile steps on this page are taken next if a 'fall' has been chosen for the orangery outer boards. If no 'fall' has been chosen, then these steps should be taken after the outer boards are attached in 3c.

1e

The upstand profile is connected directly to the inner rectangle profile G3R as shown below. The upstands are mitred at a 45 degree angle where they join to make a tight fit.

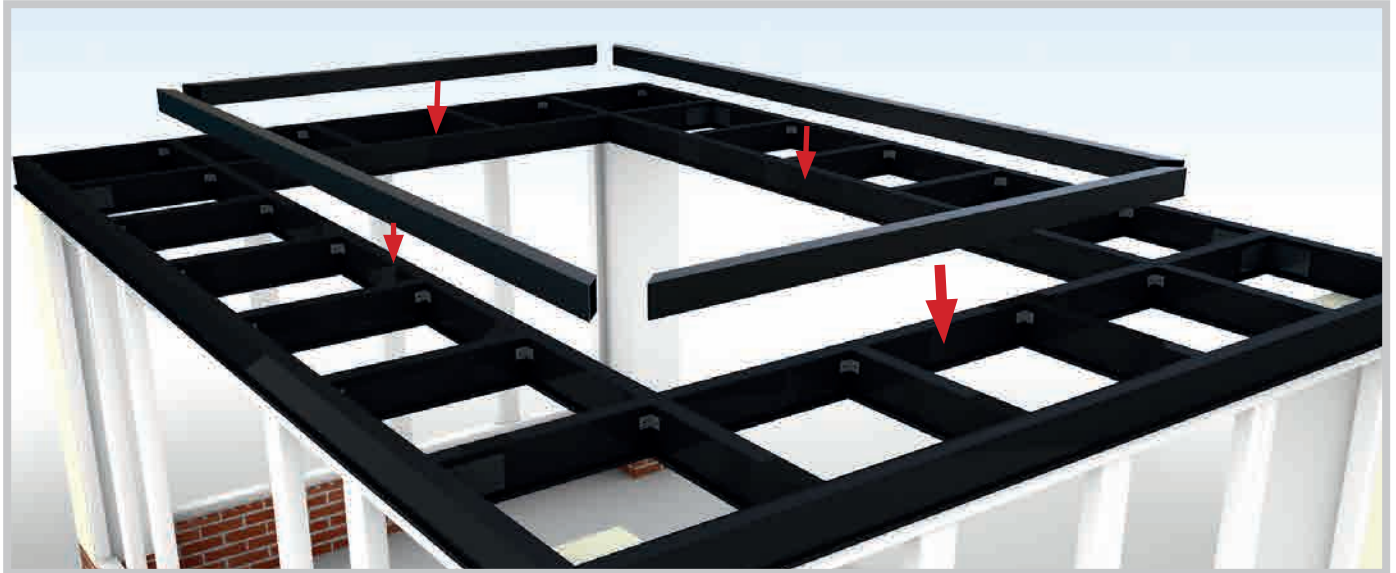

1g

The upstand profile is fixed to the ladder GRP with the supplied bracket using 8 42mm coated screws as shown.

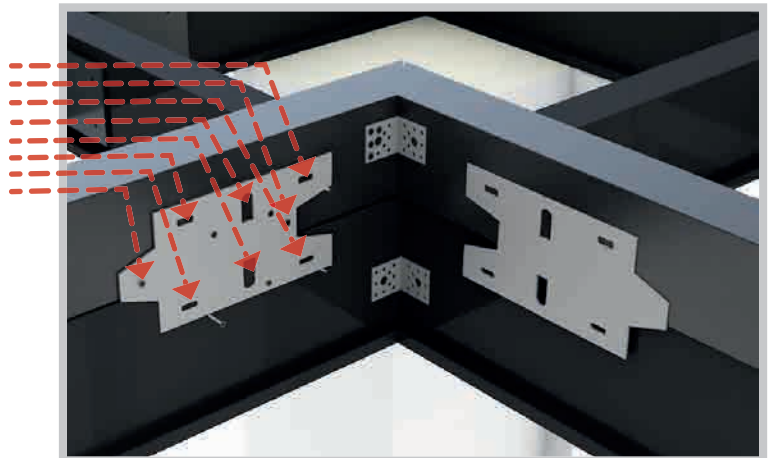

1h

The supplied brackets are spaced every 300mm along the upstand profile where it attaches to the ladder GRP as shown in the illustration below.

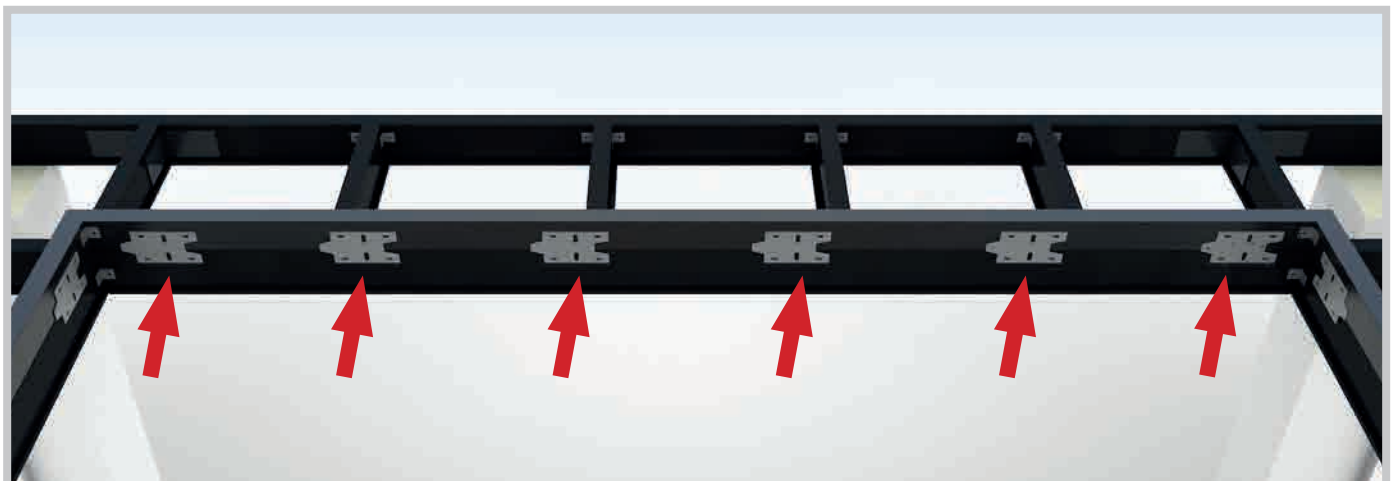

2). Insulation

2a

Prior to inserting each sheet of celotex, you will need to run a line or hi-grade silicone/sealant along the arms of your GRP rafters as shown.

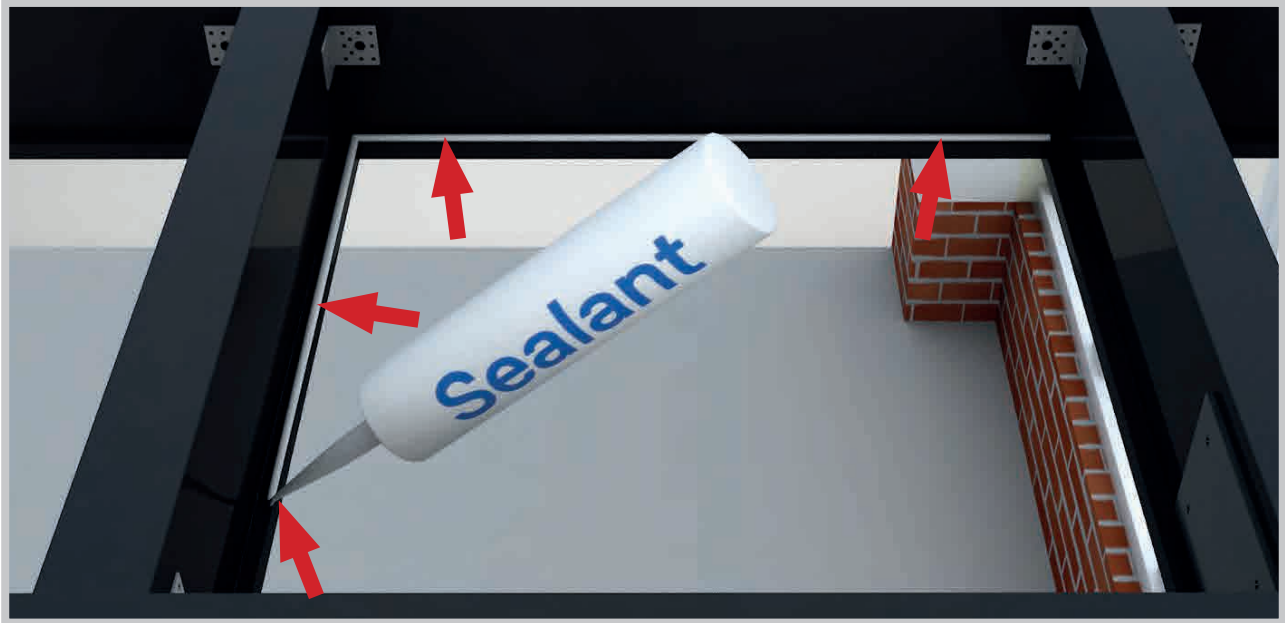

2b

Following your main rafter assembly, your pre-cut Celotex insulation is dropped into your roof structure from above and sits on your rafters arms. Any gaps where the Celotex meets the GRP should be filled using expanding foam.



2c

NOTE: It is vital that once you have inserted your celotex insulation that you seal all and every joint from the celotex to your GRP ladder to create a solid vapour seal. This should be applied to the external side of your celotex and internal side. You should seal these joints with your provided 50m roll of sealant tape

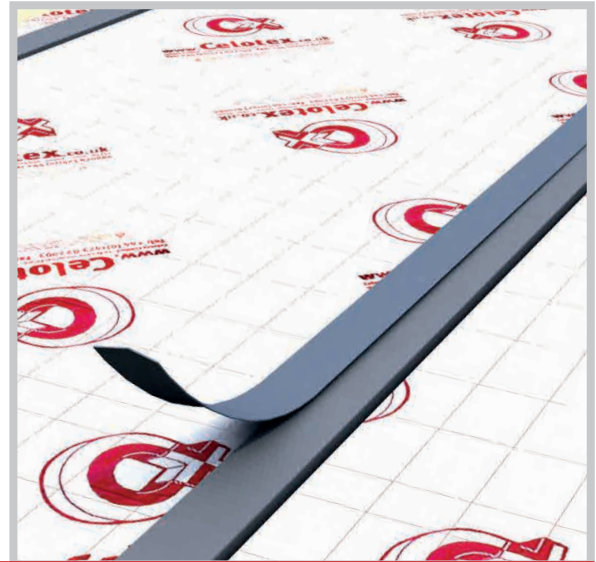

If the gaps are more than 3mm between the Celotex and GRP, please foam it first and then tape it straight away

3). Leka Outer Boards

3a

Your leka outer boards will be pre cut to size on arrival and should be laid out across your main rafter structure in accordance with the labelled boards. 42mm coated screws should be used to fix through your leka boards, ensuring that they meet your rafters and are fixed into them. The 42mm coated screws must be inserted at every 6-8 inches at your sheet joints (running up your rafters) and along the ladder GRP **1 inch** from the end.

3b

If a fall has been chosen for the Orangery roof, a polystyrene wedge will be provided which - when the outer boards are laid across it - will angle the outer boards for runoff. You will need to use your 80mm coated screws on your outer boards to ensure they pass through your board and insulation to obtain a good fixing.

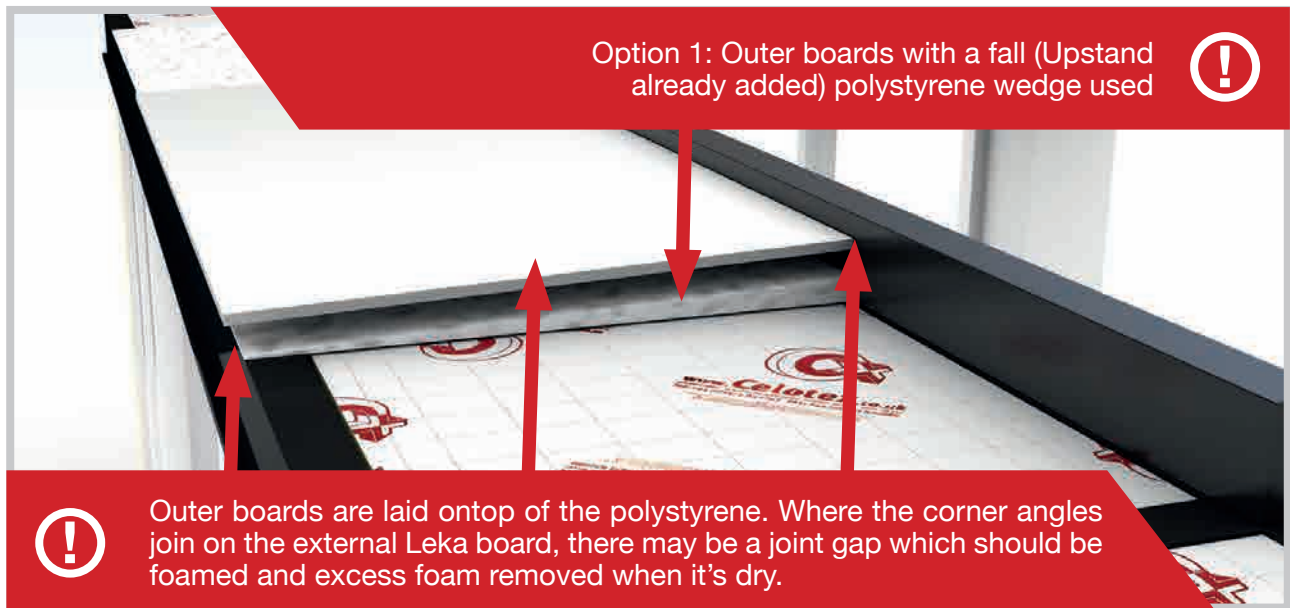

3c

if no fall has been chosen for the Orangery roof, then the outer boards will need to be overlapped onto the inner ladder GRP. This will allow the upstand profiles to sit ontop of the outer boards sandwiching them between the ladder GRP and the upstand profile.



3d

If you have a dual lantern, you will need two polystyrene wedges inverted against one another to form a rectangle and a flat surface for the outer board as shown.

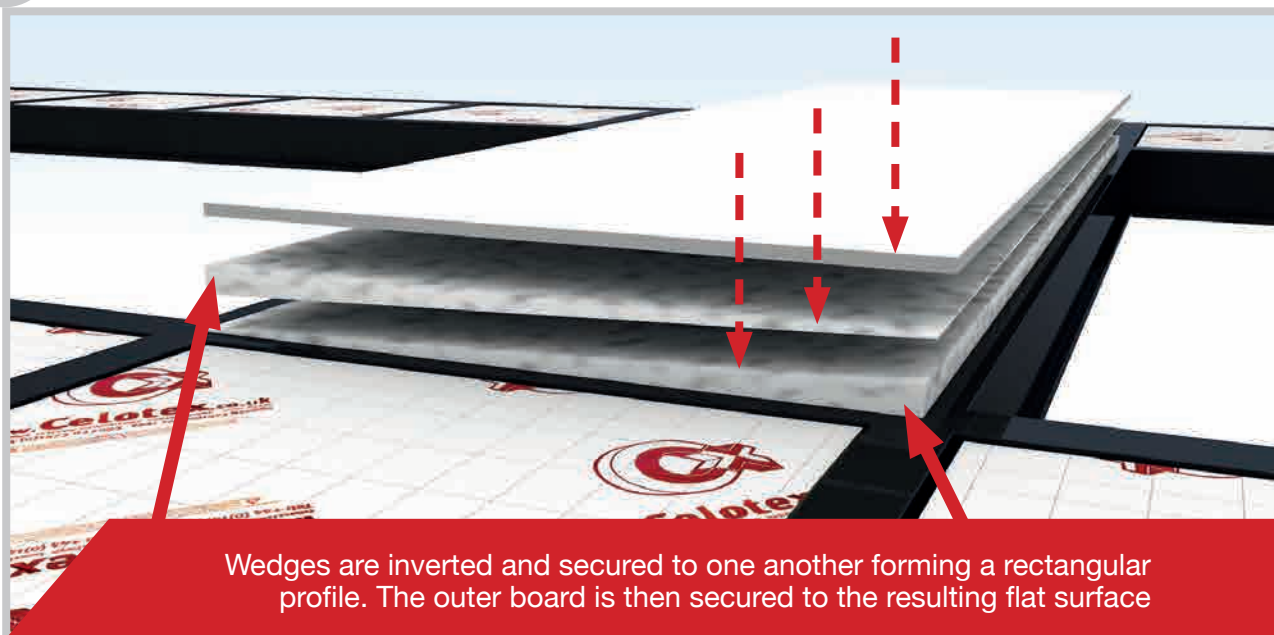

3e

Once your leka boards have been securely fastened, your outer boards must be free of dust and water before applying your jointing tape. All joints to your external leka boards need securing using your supplied aluminium tape.

High grade aluminium tape is used to form a secure weather tight barrier at your outer board joints. This tape should be applied to all joints and in one strip if possible to minimise any potential gaps. Tape should be firmly applied and flattened.

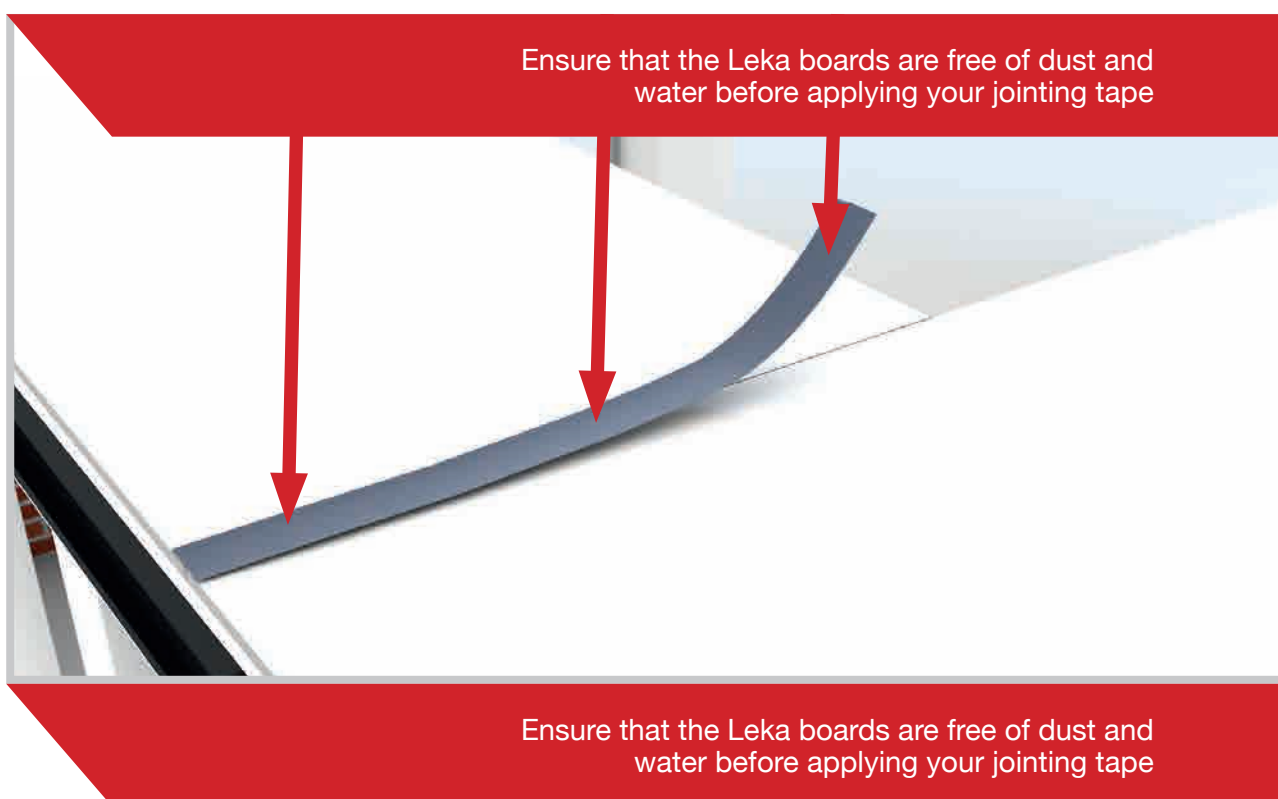

4). External Guttering And Facia Finish

4a

Insert your block batten to the underside of the external leka boards in all cases to act as a packer for your fascia capping or flat board (depending what you are sitting your ladder on). Then Connect fascia capping or flat board to outer ladder GRP face using provided screws and adhesive. Mitre each external/ internal corner with hacksaw. Please note, depending on what your leka orangery is sitting on will determine if you are sent pvc flat board or capping board.



4b

Before applying your fascia board or flat board, insert your provided 45mm architrave bead from the window frame side to the ladder. Fix using glue or/and silicone. Then, attach your fascia board with the top of that board sitting underneath the external Leka board bottom edge as shown to the right.

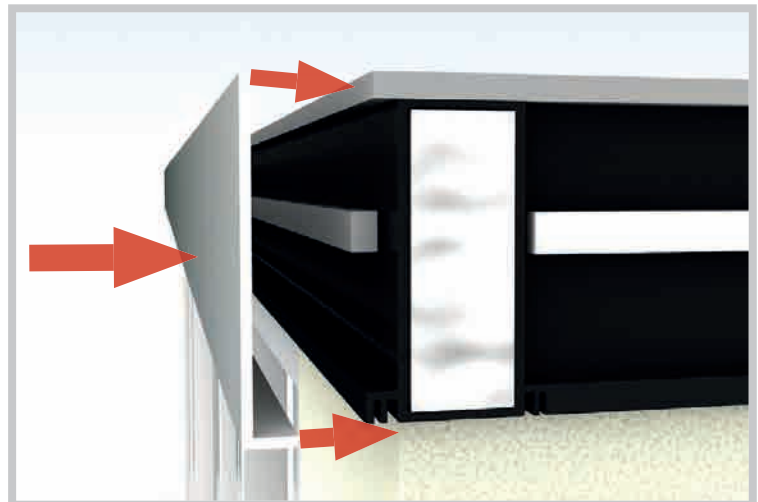

4c

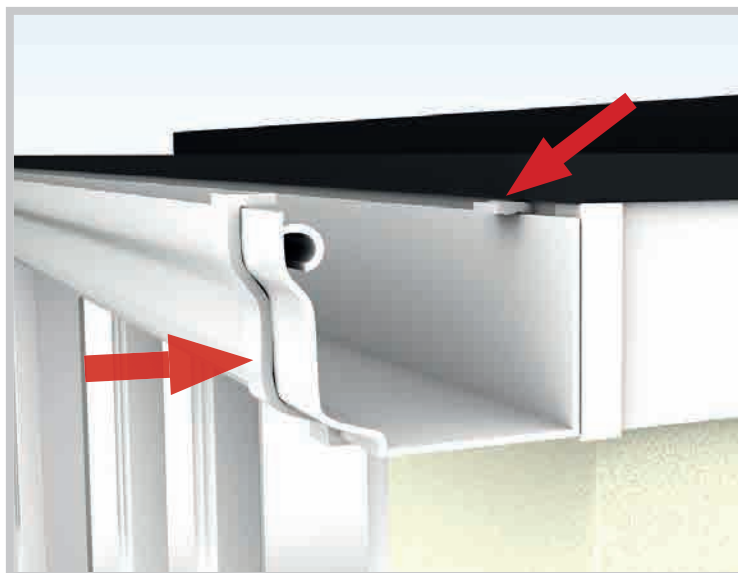

Should the customer have chosen guttering, then all guttering will be supplied and should be fixed into place. Please refer to the manufacturers instructions on the best methods to fixing the guttering.

5). Outer Weatherproofing

5a

Prior to fitting an EPDM or equivalent finish a trim bracket will need to be fixed to the outside of the structure on each side. The bracket will enable a trim to be fitted to further weather-proof and fix the EPDM finish.

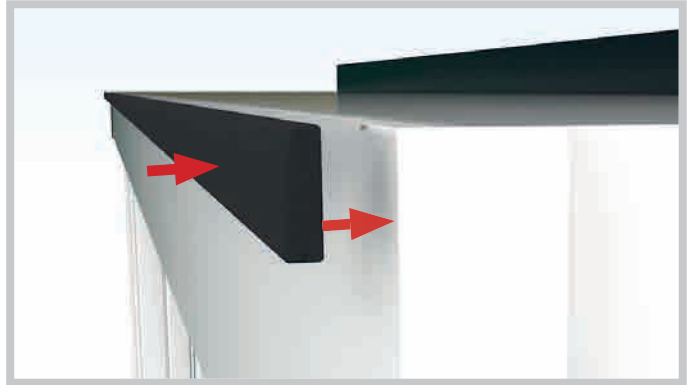

5b

An EPDM or equivalent finish will need to be added to fully weatherproof the orangery. Please refer to your installer's guide for whichever solution is being provided here.



5c

If using EPDM to cover the leka outer board you may wish to apply the following method to help a seamless finish without showing the screw dip within the roof structure when the screws are fixed in place.

Provide a drill hole that needs to be 9mm in diameter, piercing both the top sheet and centre core foam but stopping before the lower course of PVC is pierced.

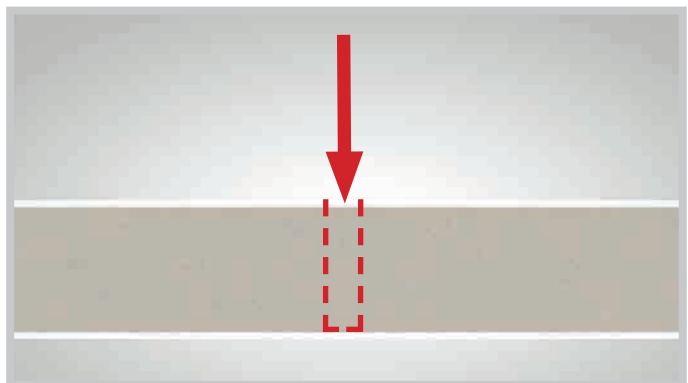

Insert your 42mm coated screw into hole and secure tightly to lower skin PVC.

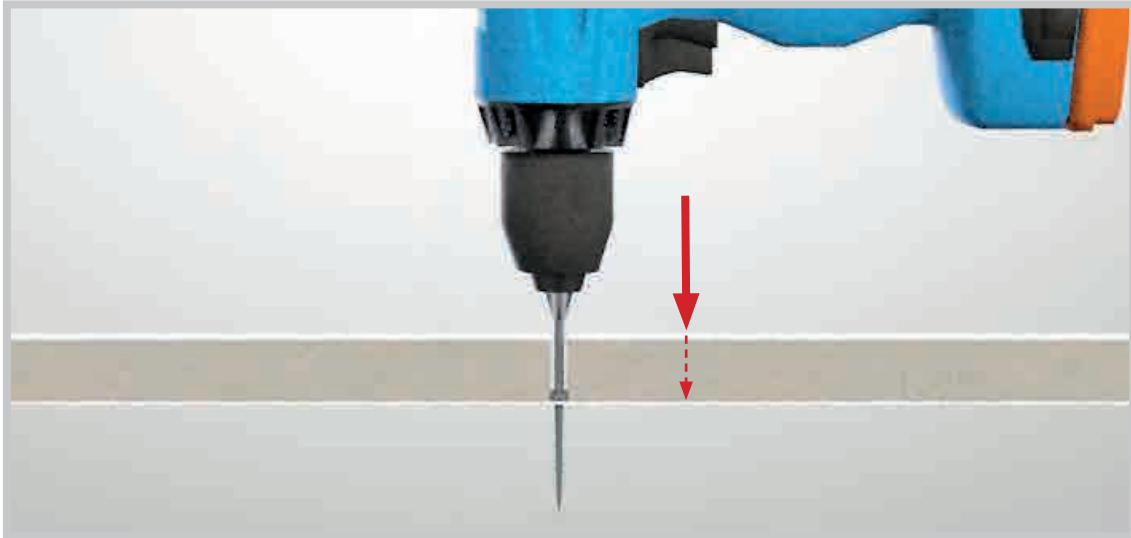

You will be provided with a foam coil which you should cut down to the appropriate length and then insert into the hole that you have drilled. Push down tightly and then your EPDM (once applied) will secure fully in place.

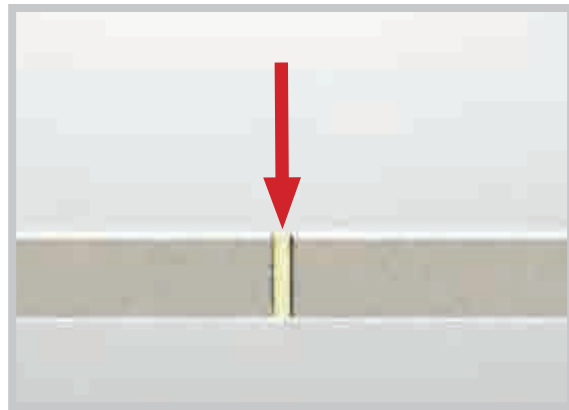

5d

Once the EPDM finish has been applied, a trim is then fixed covering the overlap of the EPDM onto the bracket fixed in step 5a. The trim will help to further weatherproof the finish and provide extra stability to the edges of the EPDM

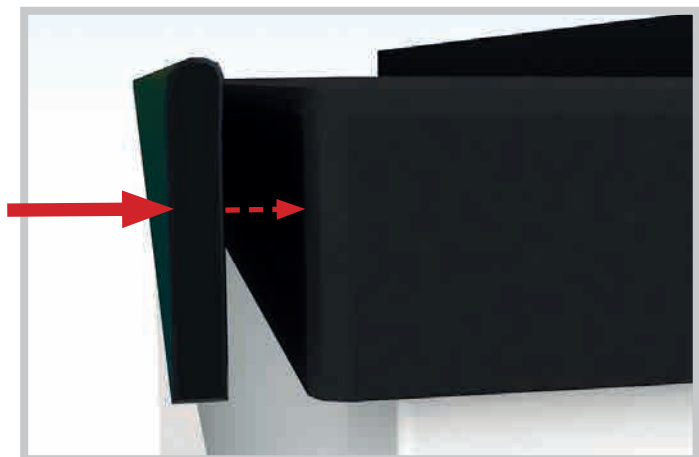

6). Glass Lantern

6a

The chosen glass lantern is now lowered onto the the upstand profiles and fixed into place.

Please refer to your glass lantern manufacturers guide on how to best fix the lantern into place.



7). Internal Leka Board Installation

7a

Appropriate battens are supplied loose for you to trim down as necessary and insert along your window frame sides or wall sides in between your rafter centres. These should be screwed into the profile ladder or fixed appropriately and used as packers for your internal boards to fix to, as shown below.



7b

Additionally, prior to installing your internal leka boards, you will need to fix the supplied block battens onto the internal ladder GRP faces. Your internal boards will then fix onto the block battens as well as the GRP arms to ensure a strong fixing.

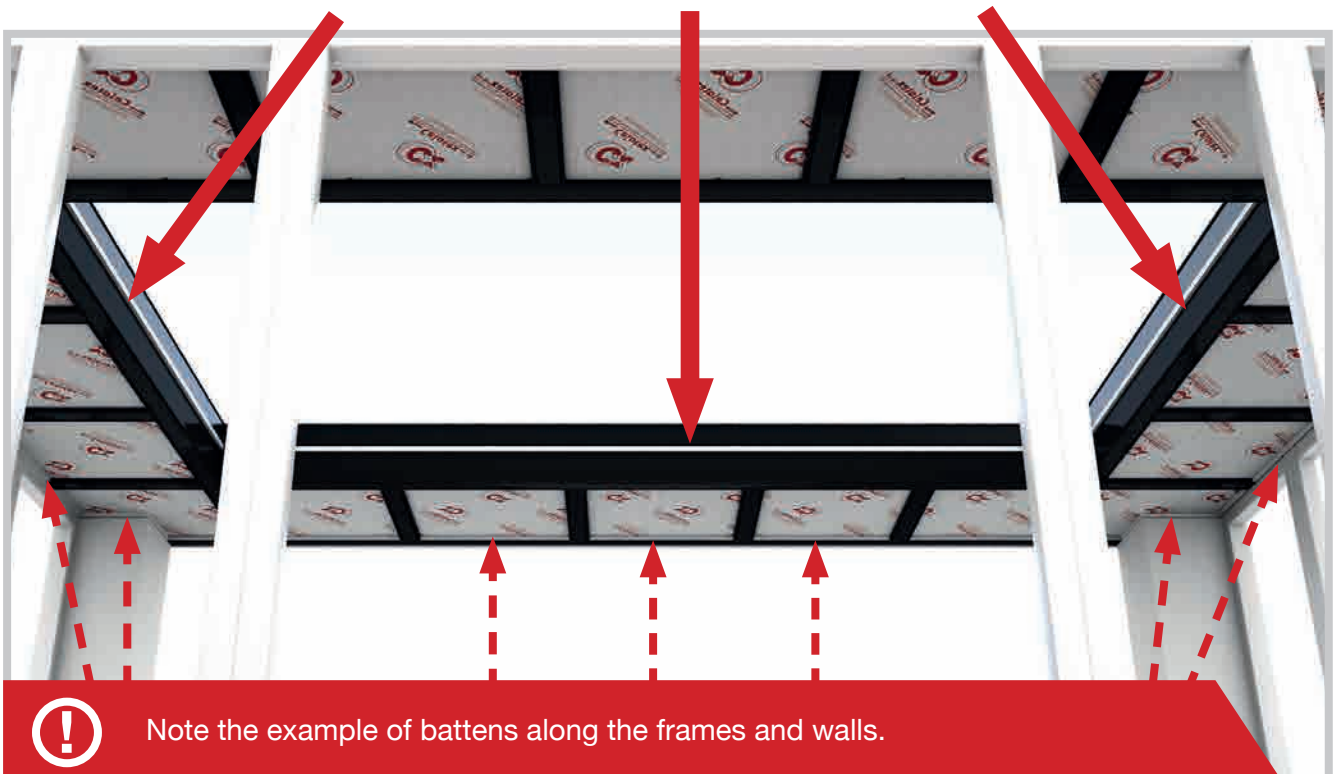

Note the example of battens along the frames and walls.

7c

Internal Leka boards need to be cut to size onsite. You will need to measure your Leka sheets to your installed roof structure and cut to size (preferably with a handsaw for ease or a skill saw).

When you have cut your internal boards, prior to fixing your boards to your GRP, you **MUST** apply sealant to the edges of your internal Leka boards prior to fixing them.

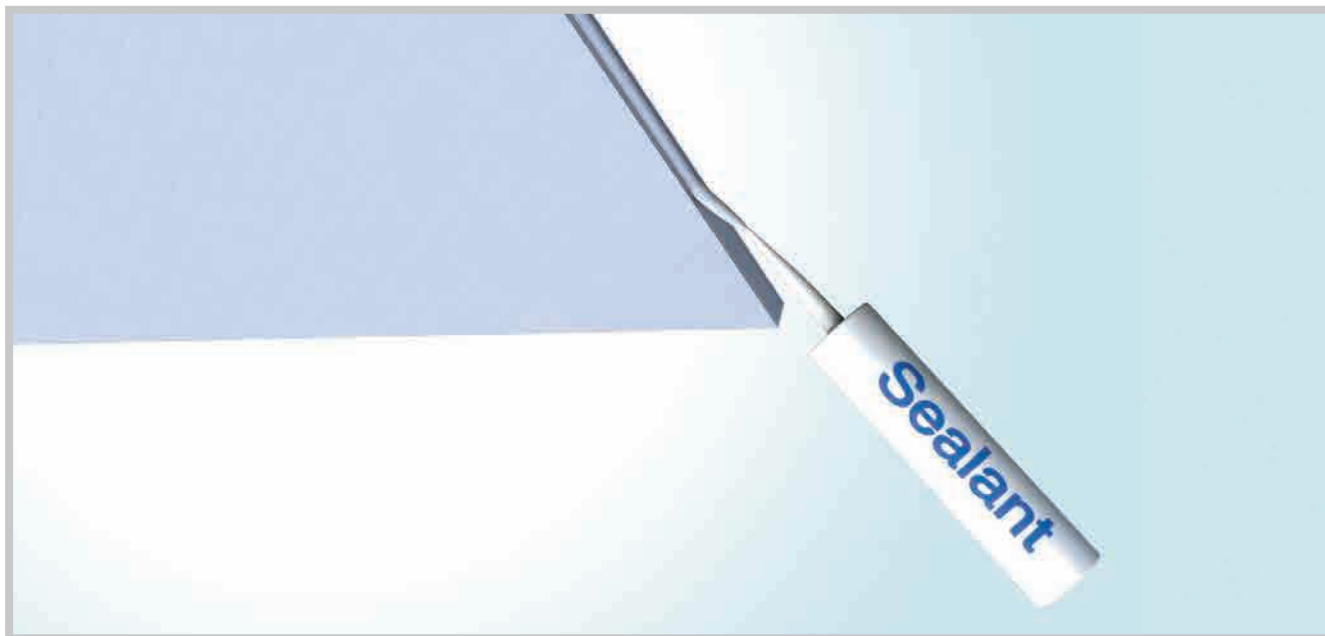

7d

Your internal boards are fixed with screws onto your GRP structure **at a maximum spacing of every 300mm apart.**

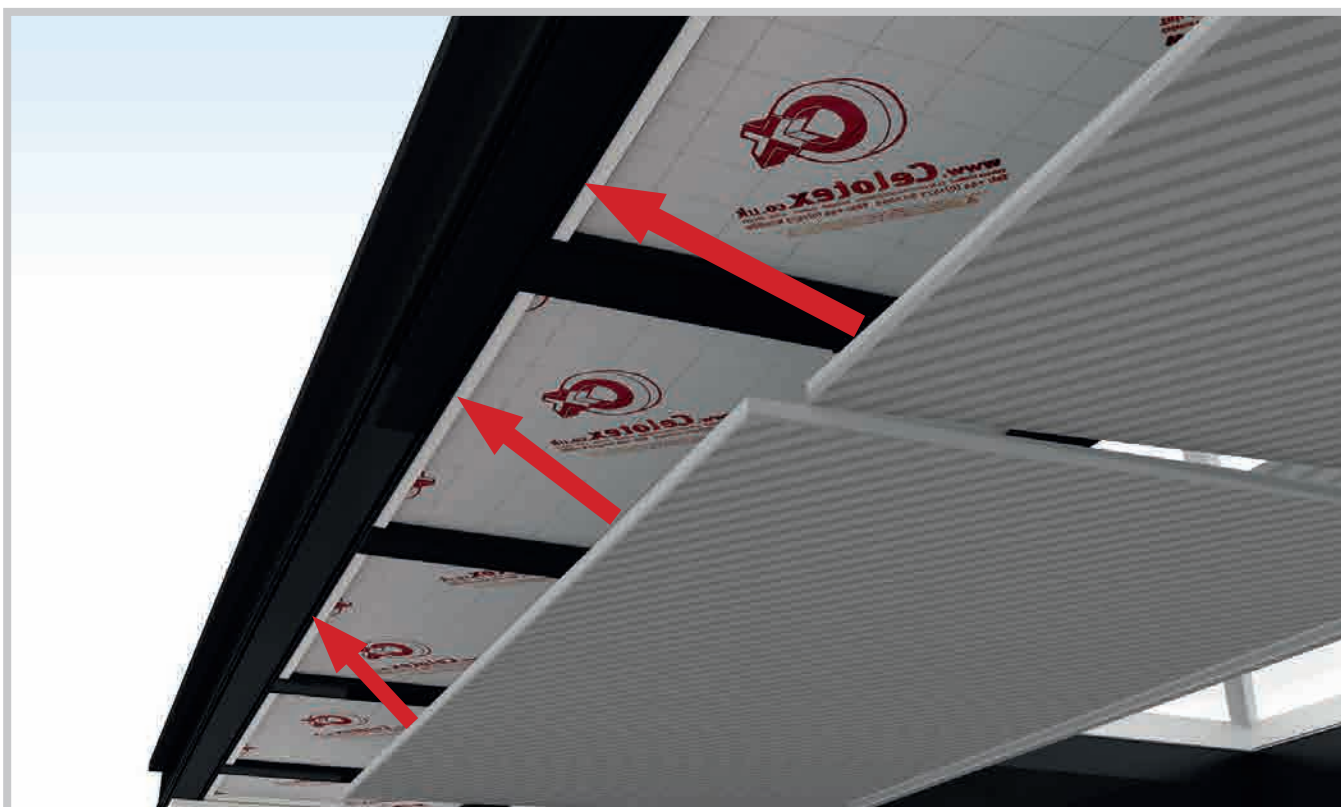

7e

Your Leka sheets should be fixed using 42mm coated screws through provided Leka metal washers. The screws must be fixed directly into your GRP rafter structure to ensure that your boards are firm and ready for plaster skim finishing. It is essential that fixings are **every 300mm (maximum)** and washers are used for every fixing. It is also essential that all joints are taped and the boards are primed with PVA glue or associated bonding prior to plastering/skimming.

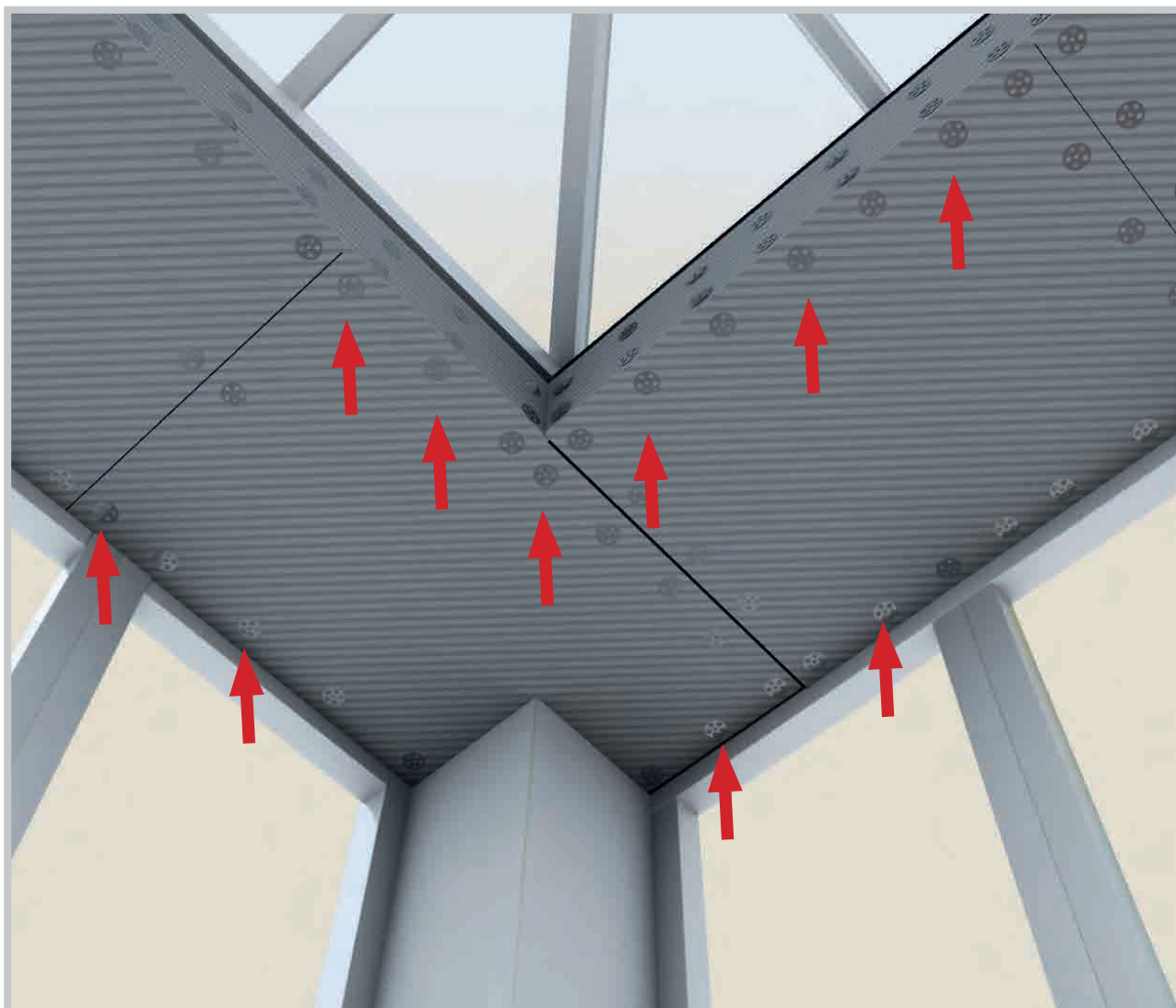

It is advisable to provide expanding foam behind your internal leka boards to hip joints, so as to fill any void where internal leka boards meet at your roof hips. If any large gaps between internal boards are apparent after fitting your internal leka boards, expanding foam should also be used here to strengthen your board connection.

When you have applied all your internal leka boards and fixed in place, ensure you seal the joints between your window frames and internal leka boards with your internal board sealant. Double check prior to plastering that all joints are sealed.

8). Lighting

8a

If providing down lighters directly into roof space and structure, an appropriate electrician should be sort.

Leka Systems only recommend **LOW VOLTAGE** LED, fire rated down lighters with appropriate covering hoods to the internal roof space and adequate/recommended spacing around lighting and hoods.

Cables should be run appropriately via electrician and preferably through 15mm air gap joint.

Once Led hoods are installed, ensure any gaps surrounding your led light hoods are sealed using your internal sealant.



Please make sure that you do NOT pierce the top of the Celotex

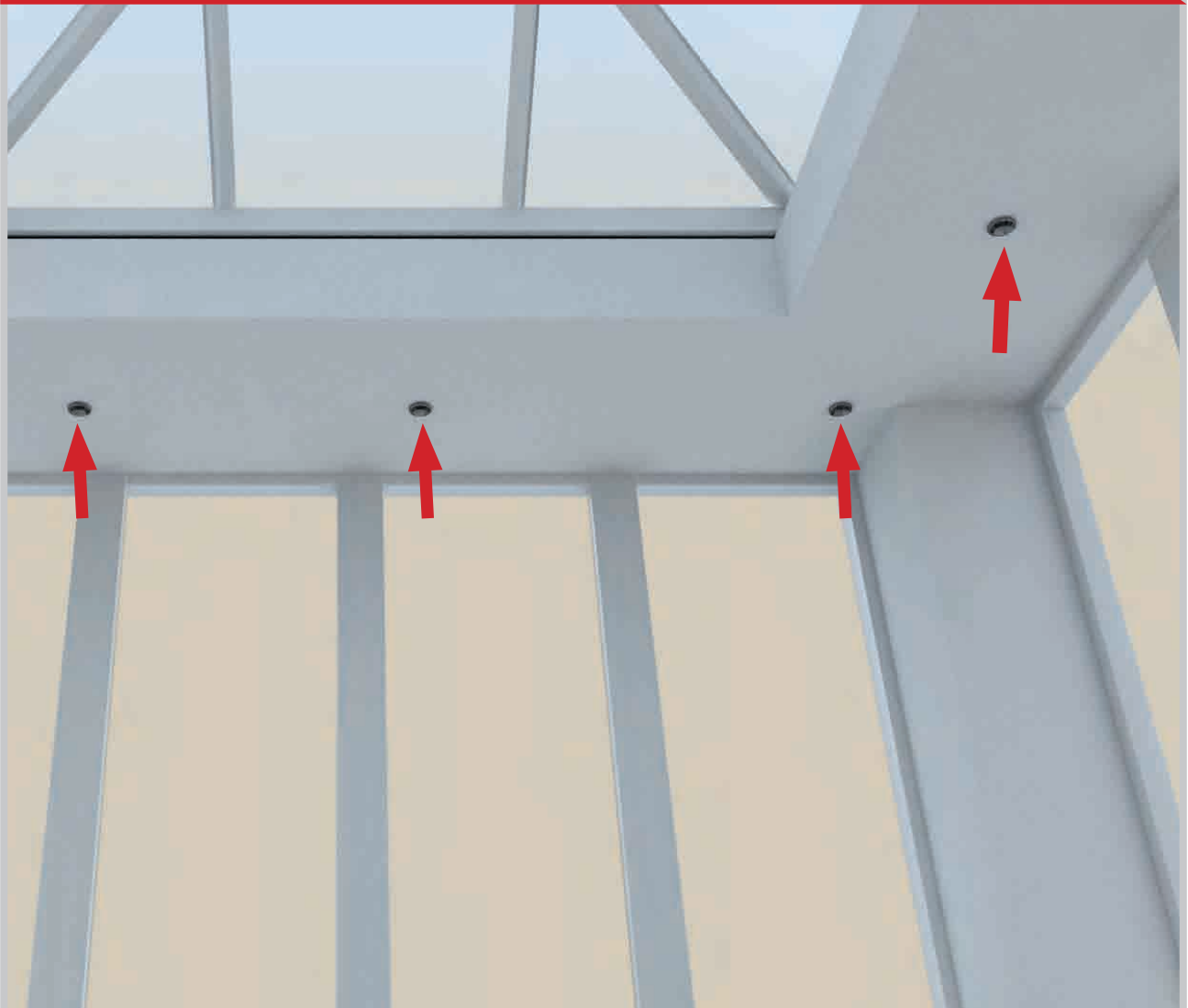

NOTE: for ECO and ECO+ installations

ECO

Leka ECO

The Leka Eco option requires the installer to supply use standard 12.5mm foil backed plasterboard instead of the existing Leka Internal board.

Prior to installing your plasterboard it is recommend to cut your 15mm x 10mm pvc block batten with snips and adhere these centrally to your insulation sheet using sealant. This needs to set and bond before beginning your plasterboard fixing.

This is used as a packer and also an additional fixing location for the centre of your plasterboards.

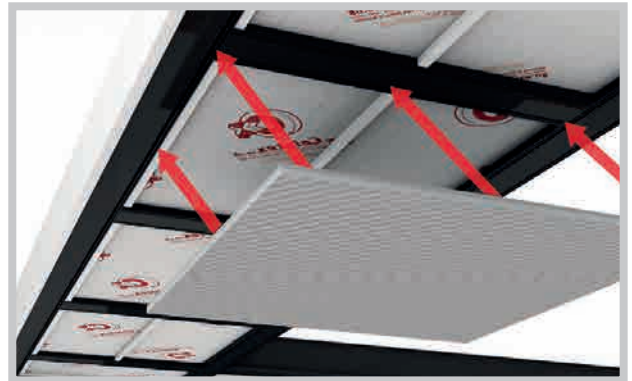

ECO+

Leka ECO+

The Leka Eco+ option also requires the installer to supply use standard 12.5mm foil backed plasterboard instead of the existing Leka Internal board AND the Leka roof will also be supplied with 135mm GREY EPS.

You should insert the EPS into your roof following much of the same process as if your were installing a sheet of Celotex. So sealant is still required on the arms/wings of the rafter profiles before inserting your EPS.

The only difference in installation process is foaming your joints rather than using insulation tape. Foam should be supplied around all joints.

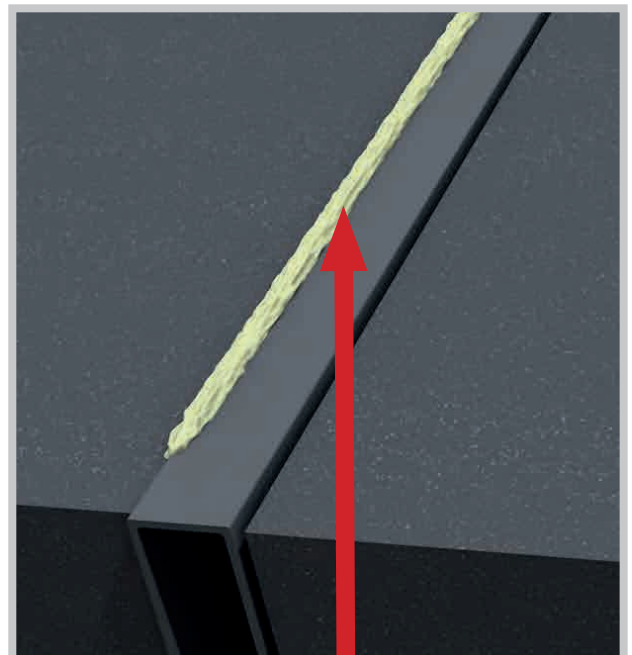

Foam sealant being applied before being smoothed down



Iceni Windows Ltd.
46 Stepfield, Witham, Essex, CM8 3TH
01376 519279 sales@iceniwindows.co.uk

www.iceniwindows.co.uk

