

FORT KNOX

VAULTS

SECURITY MADE PERFECT



**PRODUCT
CATALOG**
2017

Build Your Own
Custom Vault at
FtKnox.com

FORT KNOX VAULTS



*All Fort Knox Vaults are- and always
have been- made in the USA.*

OUR VALUES & COMMITMENT

You work hard for what you have. Now it's time to protect it. The threats of theft, fire, and natural disasters are very real.

You own items that are irreplaceable; things that hold great sentimental or monetary value. You don't want to store them in a safe that just looks secure.

Because Fort Knox manufactures in the USA, we monitor and tightly control the craftsmanship and quality of every product that carries our name.

Fort Knox offers many standard sizes of vaults to ensure reliable and consistent manufacturing. Because our products are made in the USA by our team of dedicated employees and never mass-produced, Fort Knox has the ability to customize the layout, fire protection, level of security and many other features to your specifications.

Fort Knox - it is our commitment to offer detailed and complete information that shows what makes our Vaults more secure and highlights the quality and craftsmanship that goes into our products.

Fort Knox is proud to offer a superior product in terms of quality, craftsmanship, and protection. We are so confident of this fact, that we are the only manufacturer to offer a true **comprehensive lifetime warranty**. This includes the lock, interior, paint, handle/bolt work, mechanism, clutch and body of the vault. Our warranty comes first; without waiting for an insurance company's lengthy claim process - because your valuables can not afford to wait.

WHY IS FORT KNOX THE INDUSTRY LEADER?

- **Safe-In-A-Safe** options allows you to economically add up to 4 additional layers of hardened protection. Choose from Stainless Steel, Ballistic Steel or Standard Carbon Steel.
- **Largest Bolts in the Industry** — 1 1/2" in diameter compared to 1" or less with other manufacturers.
- **Thickest steel bodies** with the ability to increase safe wall thickness to meet your specific needs.
- **Oversized Corner Bolts** that adds increased protection against pry attacks.
- **Lifetime Warranty** — Fort Knox safes are protected by our commitment to be the best. No fine print in our warranty.
- **Highest Fire Protection** ratings in the industry
- **Steel Plating covers 100% of the door.** Many other manufacturers will cover a smaller percentage of the door making it easier to compromise the door's integrity.
- **Customize your vault to fit your needs.** It's not just picking a color but tailoring a vault to fit your security and fire protection needs. Add more steel, increase fire protection, match home decor. If you're going to have a vault for a lifetime, might as well do it right!

FIRE & THEFT PROTECTION

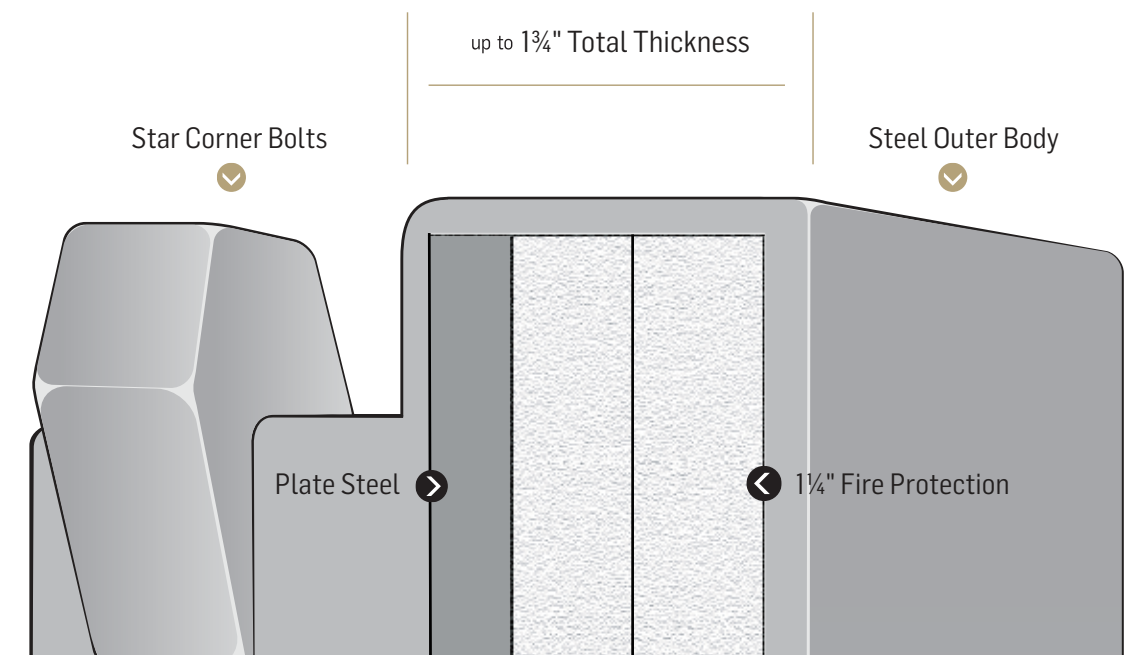

Learn more about our standard features at www.ftknox.com

STANDARD & OPTIONAL FEATURES



UNIBODY CONSTRUCTION

Fort Knox has found that a Unibody Construction retains the natural strength of the steel.

We have strategically folded the edge around the door making it the most secure body available and gives the door a deep recessed seat to make it virtually impossible to pry. The technical innovation offered by Fort Knox will give more security than raw weight.



EASY GLIDE BALL BEARING HINGES

Completely adjustable and tamper proof, without affecting our certified fire protection, our hinges add maximum security. The door opens 100 degrees for complete access with the internal hinge or a full 180 degrees with the outside hinge. Smooth access to your safe or vault shows the thought and care taken into every Fort Knox vault.



HEAVY DUTY STAR CORNER BOLTS

Securing the corners of the door to prevent attacks by prying has been a longtime feature of Fort Knox Guardian, Titan, and Legend vaults. A wide bolt for maximum surface area with long extensions of the bolts gives Fort Knox vaults the complete security lead in the industry. Optional feature on Defender and Protector Vaults.



POWER SUPPLY INSIDE

Watch winders, dehumidifiers or any number of other items require power inside of your vault. All Fort Knox Defender Vaults and above come standard with an internal power supply for your convenience.



BOLT DETENT

Our vaults are an investment in themselves. Inadvertently extending the locking bolts and attempting to close the vault can damage that investment by chipping the paint. With the exception of our Maverick series safe, A Fort Knox Vault protects itself with a detent system to keep your bolts from extending when the door is open.

DRILL STOP HARD PLATE

Technical innovation occurs from the inside out on Fort Knox Vaults. Hard plate will only slow down a drill. Bearings recessed into critical areas of the hard plate will cause drill bits to slip and break, and bring a drilling attempt to a halt.

5 TO 1 GEAR DRIVE SYSTEM

Our patented rack and pinion bank style locking mechanism is the most technically sophisticated and reliable locking system available. Precision, strength and maintenance free are just a few reasons for the system. Fort Knox Vaults have an added clutch to prevent damage to the mechanism from undue or excessive force on the handle.

DRILL BOLTGUARD

A technical advantage with Fort Knox is our Drill Boltguard. By adding a tempered, hard plate to this vulnerable area of the vault body Fort Knox keeps your vault virtually impenetrable, drill and punch resistant. Ensure your security with a Drill Boltguard.

SAFE WITHIN A SAFE EXPONENTIAL THEFT PROTECTION

CREATE YOUR OWN FORTRESS ADD UP TO 4 LAYERS OF STEEL

CHOOSE FROM:

- 10-gauge carbon steel
- $\frac{3}{16}$ " Armaknox ballistic steel (AR500)
 - *120x stronger than carbon steel*
- 10-gauge Stainless Steel
 - *Cutting torch resistant*

INNER STEEL LINER

FIRE PROTECTION

STEEL BODY

*Diagram of safe wall cutout

MORE FIRE PROTECTION

"THE HOUSE WAS TOTALLY DESTROYED AND WE LOST EVERYTHING EXCEPT..."

a couple of years before the fire I purchased one of your [Fort Knox] gun safes... I was shocked when the safe was opened their was no damage to the guns or valuables."

The "B" Family!

WATCH FIRE TESTING AND OTHER VIDEOS ON OUR WEBSITE

www.ftknox.com/fort-knox-videos/

ONLY FORT KNOX— DUAL ACTIVATED THERMAL DOOR SEAL

Locked, sealed and ready to block the worst that flames have to offer.

Seal 1 Heat activated Palusol swells to seal the vault door during a fire.

Seal 2 A smoke seal is critical to protect your possessions until the expansion of the Palusol occurs.



"EVEN THE PLASTIC AND PAPER SURVIVED THE FIRE THANKS TO FORT KNOX'S FIRE PROTECTION"



1680° Protection

FORT KNOX VAULTS

Each Vault is lined with a proprietary blend of hydrogen bond fireboard that gives every Fort Knox Vault the industry's leading fire protection.

FORT KNOX INFERNO SHIELD LEVEL 90 — fire simulation results

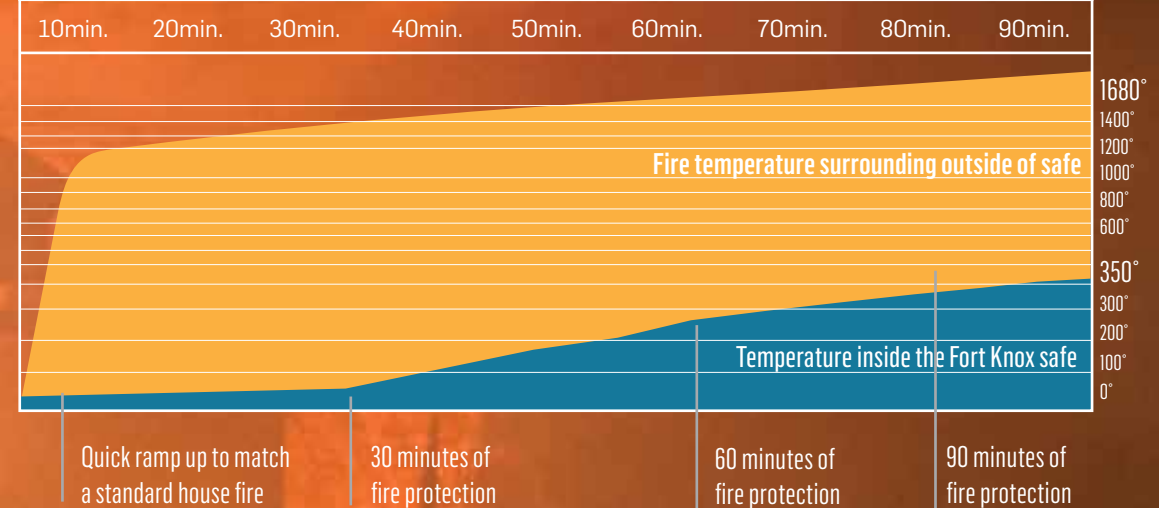

YOU NEED THE BEST.

Fort Knox's Inferno Shield 90 is tested to keep the inside of the vault under 350 degrees. C-rated fireboard insulation is used on all six sides and behind the hinges to eliminate hot spots. Heat sensitive expanding fire seal expands to seal around the entire door on all Fort Knox vaults & safes. In addition to the high-grade UL listed fireboard and deep bend box, a dead air space is manufactured into the vault which acts as a thermal barrier, much like a thermal pane window, to give added protection. This design provides fire protection at 1680 degrees in 90 minutes.

SUPERIOR FIRE PROTECTION GETS UPGRADED!

This additional fire protection will cause a decrease in the interior capacity of the vault interior, but it is well worth it! Protect your most prized possessions by adding the most valuable vault option, the Reinforced Fire Liner, and have your vault rated at 1680 degrees in 120 minutes.

Fort Knox also offers an optional Reinforced Fire Liner upgrade. You will trade some internal space, but your fire rating will increase to 1680° in 120 minutes.

FORT KNOX INFERNO SHIELD LEVEL 120 (With FIRE DOOR) — fire simulation results

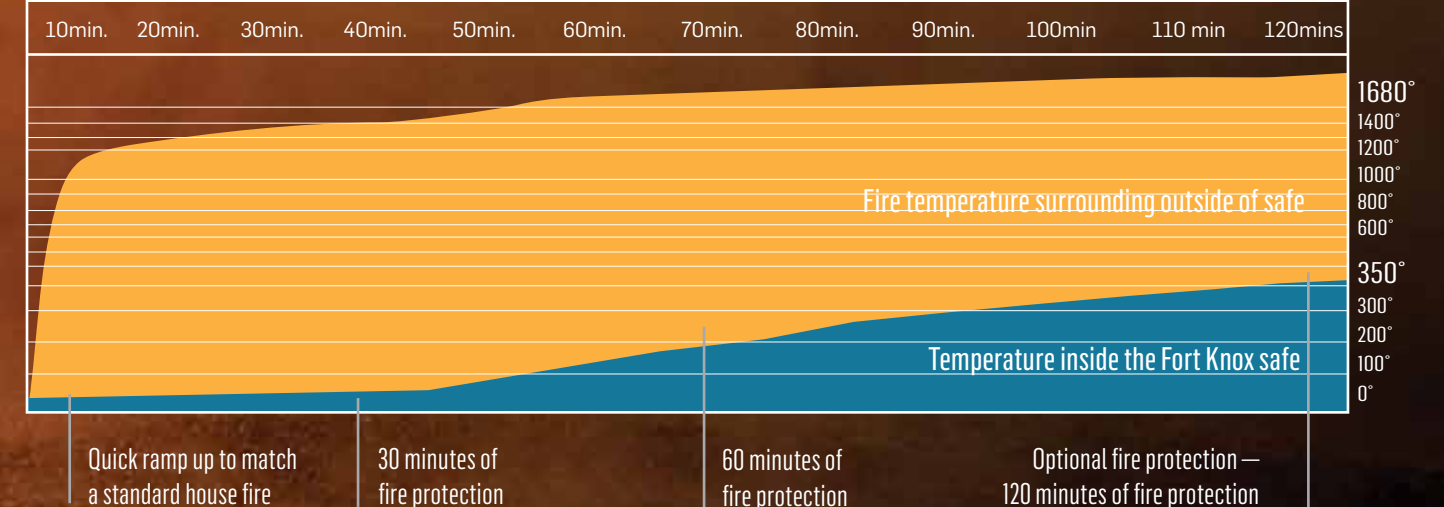

A SIDE-BY-SIDE COMPARISON



MAVERICK SAFE



DEFENDER VAULT



PROTECTOR VAULT



EXECUTIVE VAULT



GUARDIAN VAULT



TITAN VAULT



LEGEND VAULT



COMMERCIAL SAFE



VAULT DOOR

FIRE PROTECTION	75 mins, 1200°F	90 mins, 1680°F	90 mins, 1680°F	90 mins, 1680°F	90 mins, 1680°F	90 mins, 1680°F	120 mins	N/A
OVERALL BODY STEEL THICKNESS	11ga	10ga	3/16"	1/4"	5/16"	3/8"	1/2"	10GA
DOOR EDGE STEEL THICKNESS	3/8" (.3886)	1/2" (.51)	1/2" (.51)	5/8" (.64)	5/8" (.64)	3/4" (.71)	1" (.96)	N/A
CORNER BOLTS	N/A	OPTIONAL	OPTIONAL	OPTIONAL	4 BOLTS STD	4 BOLTS STD	4 BOLTS STD	N/A
LOCKING BOLTS	11	13	13	13	20	20	28	10
STAINLESS STEEL	N/A	OPTIONAL	OPTIONAL	OPTIONAL	OPTIONAL	OPTIONAL	STANDARD	N/A
ARMAKNOX AR500	N/A	OPTIONAL	OPTIONAL	OPTIONAL	OPTIONAL	3/16"	3/16"	N/A
INSIDE STEEL LINER	N/A	OPTIONAL	OPTIONAL	OPTIONAL	10GA	OPTIONAL	OPTIONAL	N/A
DOOR ORGANIZER	N/A	OPTIONAL	STANDARD	STANDARD	STANDARD	STANDARD	N/A	N/A
LIGHTS	OPTIONAL	OPTIONAL	OPTIONAL	OPTIONAL	STANDARD	STANDARD	STANDARD	N/A
DEHUMIDIFIER	OPTIONAL	OPTIONAL	OPTIONAL	OPTIONAL	OPTIONAL	STANDARD	STANDARD	N/A
								STANDARD ON EXECUTIVE
								24
								OPTIONAL
								OPTIONAL
								OPTIONAL
								N/A
								N/A
								N/A



FORT KNOX STRENGTH

If you're going to have a vault for a lifetime, might as well do it right!



DEFENDER VAULTS

- FIRE PROTECTION 90 mins, 1680°F
- OVERALL BODY STEEL THICKNESS 10ga
- DOOR EDGE STEEL THICKNESS ½" (.51)
- LOCKING BOLTS 13

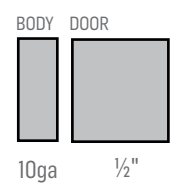

MODEL	HEIGHT	WIDTH	VOLUME	DEPTH/OVERALL	WEIGHT	1½" LOCKING BOLTS
DEFENDER 7261	72.5"	61"	69 CU.FT.	27"/30"	1,645 LBS	13
DEFENDER 7251	72.5"	51"	57 CU.FT.	27"/30"	1,505 LBS	13
DEFENDER 7241	72.5"	41"	45 CU.FT.	27"/30"	1,365 LBS	13
DEFENDER 6637	66.5"	37"	36 CU.FT.	27"/30"	1,125 LBS	11
DEFENDER 6031	60.5"	31"	28 CU.FT.	27"/30"	895 LBS	11
DEFENDER 6026	60.5"	26"	16 CU.FT.	20"/23"	705 LBS	11
DEFENDER 4026	40.0"	26"	10 CU.FT.	20"/23"	510 LBS	11



MAVERICK SERIES

- FIRE PROTECTION 75 mins, 1200°F
- OVERALL BODY STEEL THICKNESS 11ga
- DOOR EDGE STEEL THICKNESS ⅜" (.39)
- LOCKING BOLTS 11

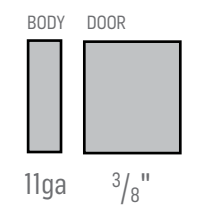

MODEL	HEIGHT	WIDTH	VOLUME	DEPTH/OVERALL	WEIGHT	1½" LOCKING BOLTS
MAVERICK 7241	72.5"	41"	45 CU.FT.	27"/30"	1085 LBS	11
MAVERICK 6637	66.5"	37"	36 CU.FT.	27"/30"	960 LBS	9
MAVERICK 6041	60.5"	41"	32 CU.FT.	27"/30"	955 LBS	9
MAVERICK 6031	60.5"	31"	28 CU.FT.	27"/30"	770 LBS	9
MAVERICK 6026	60.5"	26"	16 CU.FT.	20"/23"	595 LBS	9
MAVERICK 602418	60.5"	24"	14 CU.FT.	18"/21"	555 LBS	9
MAVERICK 402418	40.5"	24"	8 CU.FT.	18"/21"	415 LBS	9



PROTECTOR VAULTS

- FIRE PROTECTION 90 mins, 1680°F
- OVERALL BODY STEEL THICKNESS ⅜"
- DOOR EDGE STEEL THICKNESS ½" (.51)
- LOCKING BOLTS 13

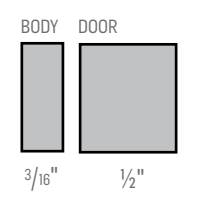

MODEL	HEIGHT	WIDTH	VOLUME	DEPTH/OVERALL	WEIGHT	1½" LOCKING BOLTS
PROTECTOR 7261	72.5"	61"	69 CU.FT.	27"/30"	1,805 LBS	13
PROTECTOR 7251	72.5"	51"	57 CU.FT.	27"/30"	1,645 LBS	13
PROTECTOR 7241	72.5"	41"	45 CU.FT.	27"/30"	1,495 LBS	13
PROTECTOR 6637	66.5"	37"	36 CU.FT.	27"/30"	1,240 LBS	11
PROTECTOR 6031	60.5"	31"	28 CU.FT.	27"/30"	980 LBS	11
PROTECTOR 6026	60.5"	26"	16 CU.FT.	20"/23"	785 LBS	11
PROTECTOR 4026	40.0"	26"	10 CU.FT.	20"/23"	570 LBS	11



EXECUTIVE VAULTS

- FIRE PROTECTION 90 mins, 1680°F
- OVERALL BODY STEEL THICKNESS ¼"
- DOOR EDGE STEEL THICKNESS ⅝" (.64)
- LOCKING BOLTS 13

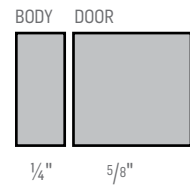

TITAN VAULTS

- FIRE PROTECTION 90 mins, 1680°F
- OVERALL BODY STEEL THICKNESS ⅜"
- DOOR EDGE STEEL THICKNESS ¾" (.71)
- CORNER BOLTS 4 BOLTS STD
- LOCKING BOLTS 20
- ARMAKNOX AR500 ⅜"
- LIGHTS STANDARD
- DEHUMIDIFIER STANDARD

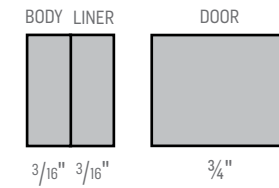

MODEL	HEIGHT	WIDTH	VOLUME	DEPTH/OVERALL	WEIGHT	1½" LOCKING BOLTS
EXEC. 7261	72"	61"	69 CU.FT.	27"/30"	2,005 LBS	13
EXEC. 7251	72"	51"	57 CU.FT.	27"/30"	1,845 LBS	13
EXEC. 7241	72"	45"	45 CU.FT.	27"/30"	1,660 LBS	13
EXEC. 6637	66"	36"	36 CU.FT.	27"/30"	1,360 LBS	11
EXEC. 6031	60.5"	31"	28 CU.FT.	27"/30"	1,111 LBS	11

MODEL	HEIGHT	WIDTH	VOLUME	DEPTH/OVERALL	WEIGHT	1½" LOCKING BOLTS
TITAN 7261	72.5"	61"	69 CU.FT.	27"/30"	2,705 LBS	20
TITAN 7251	72.5"	51"	57 CU.FT.	27"/30"	2,530 LBS	20
TITAN 7241	72.5"	41"	45 CU.FT.	27"/30"	2,160 LBS	20
TITAN 6637	66.5"	37"	36 CU.FT.	27"/30"	1,810 LBS	20
TITAN 6031	60.5"	31"	28 CU.FT.	27"/30"	1,455 LBS	18



GUARDIAN VAULTS

- FIRE PROTECTION 90 mins, 1680°F
- OVERALL BODY STEEL THICKNESS ⅝"
- DOOR EDGE STEEL THICKNESS ⅝" (.64)
- CORNER BOLTS STD
- LOCKING BOLTS 20
- INSIDE STEEL LINER 10GA
- LIGHTS STD

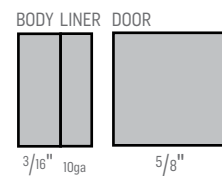

THE LEGEND VAULTS

- FIRE PROTECTION 90 mins, 1680°F
- OVERALL BODY STEEL THICKNESS ½"
- DOOR EDGE STEEL THICKNESS 1" (.96)
- CORNER BOLTS 4 BOLTS STD
- LOCKING BOLTS 28
- STAINLESS STEEL 10GA
- ARMAKNOX AR500 ⅜"
- INSIDE STEEL LINER OPTIONAL
- LIGHTS STANDARD
- DEHUMIDIFIER STANDARD

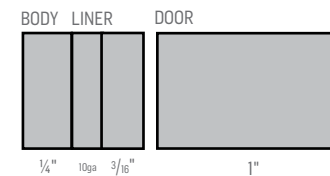

MODEL	HEIGHT	WIDTH	VOLUME	DEPTH/OVERALL	WEIGHT	1½" LOCKING BOLTS
GUARDIAN 7261	72.5"	61"	69 CU.FT.	27"/30"	2,250 LBS	20
GUARDIAN 7251	72.5"	51"	57 CU.FT.	27"/30"	2,100 LBS	20
GUARDIAN 7241	72.5"	41"	45 CU.FT.	27"/30"	1,880 LBS	20
GUARDIAN 6637	66.5"	37"	36 CU.FT.	27"/30"	1,575 LBS	20
GUARDIAN 6031	60.5"	31"	28 CU.FT.	27"/30"	1,245 LBS	18

MODEL	HEIGHT	WIDTH	VOLUME	DEPTH/OVERALL	WEIGHT	1½" LOCKING BOLTS
LEGEND 7261	72.5"	61"	69 CU.FT.	27"/30"	3,200 LBS	28
LEGEND 7251	72.5"	51"	57 CU.FT.	27"/30"	2,940 LBS	28
LEGEND 7241	72.5"	41"	45 CU.FT.	27"/30"	2,673 LBS	28
LEGEND 6637	66.5"	37"	36 CU.FT.	27"/30"	2,254 LBS	26

COMMERCIAL SAFE LINE



L Series 7240

L Series 2517

L Series 6532

L SERIES

• FIRE PROTECTION

120 mins

MODEL	WEIGHT	EXTERIOR DIMENSIONS	INTERIOR DIMENSIONS	VOLUME
2517	1540 LBS	33H / 25W / 25D	25H / 17W / 13.75D	3.4 CU.FT.
5520	3420 LBS	63H / 28W / 32D	55H / 20W / 20.75D	13.21 CU.FT.
6532	4850 LBS	73H / 40W / 30.5D	65H / 32W / 19.75D	23.18 CU.FT.
7036	5600 LBS	78H / 44W / 32D	70H / 36W / 20.75D	30.26 CU.FT.

PERSONAL SECURITY BOXES

These personal security boxes are solid and secure. Secure all of your possessions large or small in one of our personal security solutions. Personal security boxes are not rated for fire protection.



PISTOL BOX

Protect your valuables in your car or in your home. Choose from one of these two sizes for maximum storage. These new high security Pistol Boxes are constructed with a heavy 10-gauge body and a 3/16" plate door. The 6" deep version is great for an automobile while the 12" can be used in many applications.

AUTO PISTOL BOX: 9"x 5" x 6" 13 lbs PERSONAL PISTOL BOX: 9"x 5" x 12" 20 lbs

CONTROLLED ACCESS BOX

Add a secondary locking box inside your vault for those other items you don't want anyone to see. They come in three sizes for your convenience.

CAB 20	20"w	9"h	16"d	43 lbs
CAB 24	24"w	9"h	18"d	55 lbs
CAB 28	28"w	9"h	18"d	63 lbs



THE ORIGINAL PISTOL BOX



THE ORIGINAL PISTOL BOX

Quick access pistol box, the heaviest on the market. Constructed of a rugged 10-gauge body and a massive 3/16" wrap around door. Exceeds the California Firearms Safety Device Requirements.

4 1/4" x 12 1/2" x 10 3/8", 22 lbs

8240 Out-Swing

8240 In-Swing



VAULT ROOM DOORS

• LOCKING BOLTS	24
• CORNER BOLTS	STANDARD ON EXECUTIVE
• STAINLESS STEEL	OPTIONAL
• ARMAKNOX AR500	OPTIONAL
• INSIDE STEEL LINER	OPTIONAL

MODEL	HEIGHT	WIDTH	WEIGHT	1½" LOCKING BOLTS	DOOR SIZE
VD EXECUTIVE 8240	85.0"	45"	1,330 LBS	24	76 X 30
VD EXECUTIVE 8248	85.0"	53"	1,610 LBS	24	76 X 38
VD IN-SWING 8240	85.0"	45"	1,310 LBS	19	76 X 30
VD IN-SWING 8248	85.0"	53"	1,580 LBS	19	78 X 36

VD IN-SWING 8240 & 8248

- 1 ½" Reinforced Fire Door (¾" steel plate, 1 layer of fireboard & 10-gauge reinforcement)
- Quadrafold™ recessed door
- 19-1½" diameter active locking bolts on sides and top
- Foil™ mechanical back-up relocking devices
- Patented multi-gear drive, 5 to 1 reduction rack & pinion locking mechanism
- EasyGlide™ concealed ball-bearing hinges
- Drill stop hard plate with recessed multi-bearings
- S&G Electronic Lock
- Gold, chrome or black chrome plated 5 spoke Clutch Drive Handle
- High Luster, 4 stage, baked on acrylic urethane metallic finish
- Remote Relocker
- Inside Release Mechanism
- Limited Lifetime Warranty

VD EXECUTIVE 8240 & 8248

- 1 ¾" Reinforced Fire Door (¾" steel plate, 2 layers of fireboard & 10-gauge reinforcement)
- Quadrafold™ door frame
- 24-1½" diameter active locking bolts on sides and top
- Patented Star Corner Bolts
- Foil™ mechanical back-up relocking devices
- Patented multi-gear drive, 5 to 1 reduction rack & pinion locking mechanism
- EasyGlide™ concealed ball-bearing hinges
- Drill stop hard plate with recessed multi-bearings
- S&G Electronic Lock
- Gold, chrome or black chrome plated 5 spoke Clutch Drive Handle
- High Luster, 4 stage, baked on acrylic urethane metallic finish
- Remote Relocker
- Inside Release Mechanism
- Limited Lifetime Warranty
- Bolt Detent

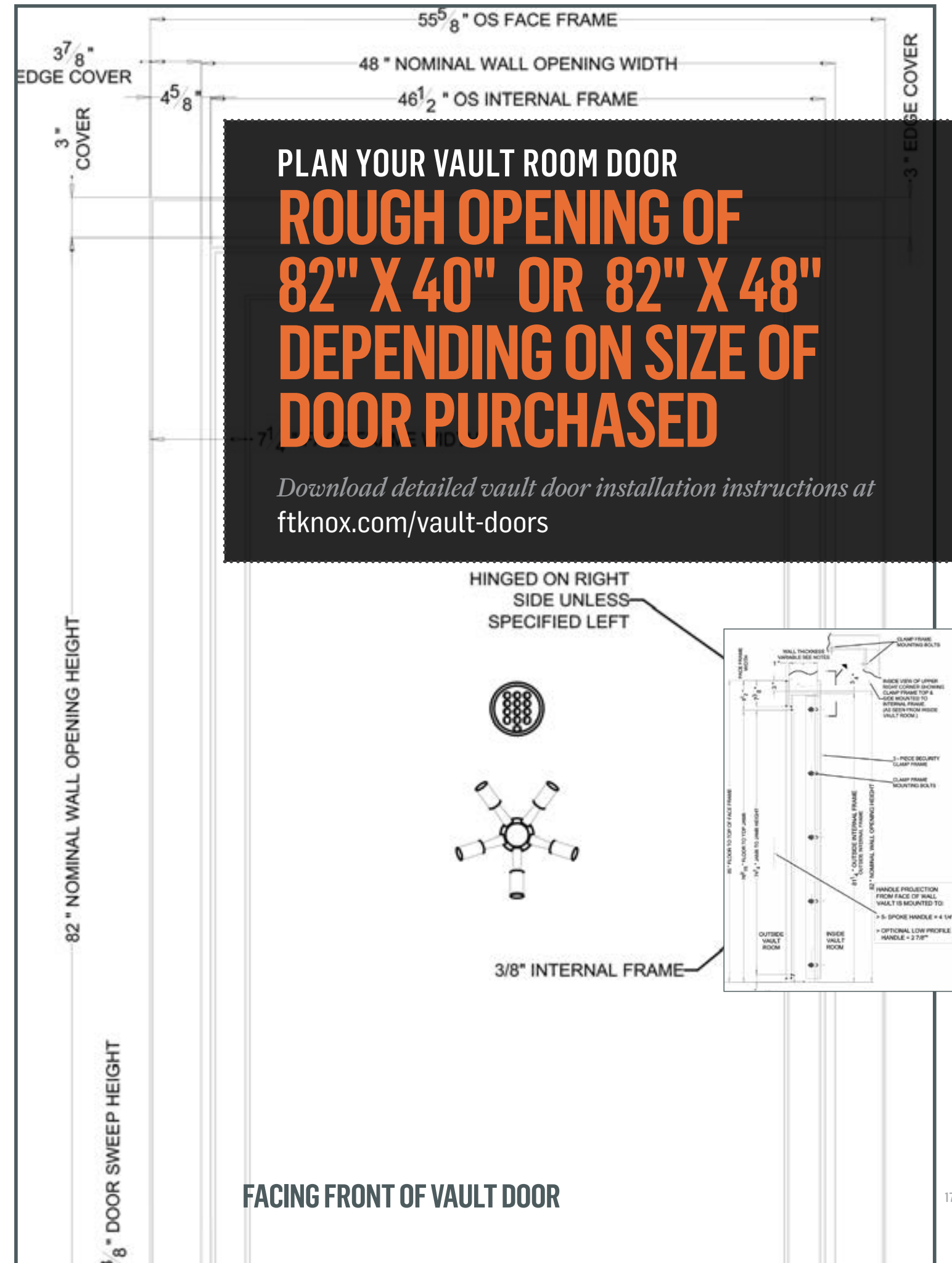

FACING FRONT OF VAULT DOOR

CUSTOMIZE YOUR VAULT

STEP-BY-STEP GUIDE

ftknox.com/vault-builder

FIRST PICK A SIZE & EXTERIOR >

VAULT SIZE — *Perfect for any space*



- 40" x 24"
- 40" x 26"
- 60" x 26"
- 60" x 31"
- 66" x 37"
- 72" x 41"
- 72" x 51"
- 72" x 61"

HINGE



- EXTERNAL HINGE
- INTERNAL HINGE
- CRANE HINGE (upgrade)

GRAPHIC OPTIONS — *Unique styles to fit your space*



- ELITE
- PERFORMANCE
- CLASSIC
- DOUBLE DIAMOND* (upgrade)

FINISHES

- GLOSS
 - TWO-TONED
 - FADED
- TEXTURED
- DISTRESSED (FLAT BLACK WITH 24 RIVETS IN THE CORNERS)

SAFE-IN-A-SAFE

BUILD YOUR SAFE WITHIN A SAFE
 PICK WHICH STEEL YOU WANT FOR EACH LINER (UP TO 4 LINERS).

				CS: CARBON STEEL SS: STAINLESS STEEL AR: ARMANOX
LINER 1 CHOICE:	LINER 2 CHOICE:	LINER 3 CHOICE:	LINER 4 CHOICE:	
<input type="checkbox"/>	<input type="checkbox"/>	<input type="checkbox"/>	<input type="checkbox"/>	

LOCK OPTIONS

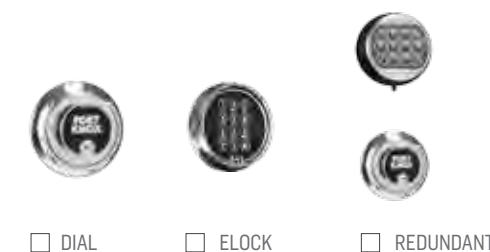

- DIAL
- ELOCK
- REDUNDANT

TRIM COLOR

- BLACK CHROME
- SILVER
- GOLD

EXTERIOR FINISHES

HIGH-GLOSS FINISH



Mercedes Silver



Forest Green



Midnight Blue



Platinum



Burgundy Wine



Sage Green



Root Beer Brown



Black Cherry



Champagne



Ivory



Jet Black



Copper

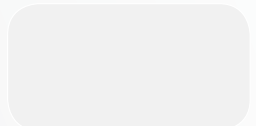

Brilliant White

TEXTURED FINISH



Rimrock



Light Granite



Dark Granite

INTERIOR FABRIC OPTIONS

CARPET



Silver

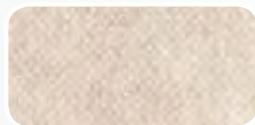

Beige

CRUSHED VELVET/VELOUR



Granite



Chocolate



Black

PICK YOUR INTERIOR

INTERIOR LAYOUT OPTIONS

Interiors shown based on the width of the vault

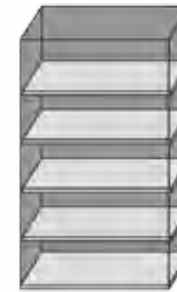

UNIVERSAL CONFIGURATION

26" 4 Shelves
31" 4 Shelves
37" 5 Shelves
41" 5 Shelves
51" 5 Shelves
61" 5 Shelves

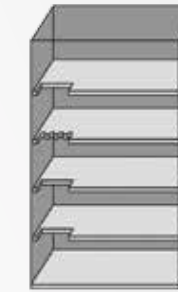

UNIVERSAL WITH GUNS

26" 3 Guns
31" 4 Guns
37" 4 Guns
41" 4 Guns
51" 4 Guns
61" 4 Guns



1/4 GUN RACK CONFIGURATION

26" Not Available
31" 8 Guns
37" 8 Guns
41" 12 Guns
51" 12 Guns
61" 12 Guns



1/2 EZ GUN RACK CONFIGURATION

26" Not Available
31" 13 Guns
37" 14 Guns
41" 15 Guns
51" 18 Guns
61" 21 Guns

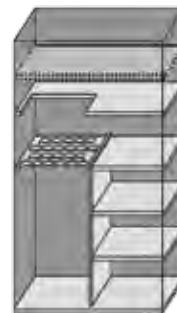

1/2 GUN RACK CONFIGURATION

26" 8 Guns
31" 18 Guns
37" 22 Guns
41" 26 Guns
51" 34 Guns
61" 42 Guns

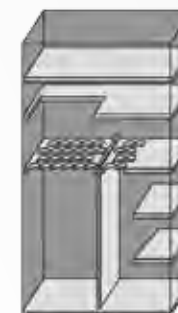

3/4 GUNS CONFIGURATION

26" Not Available
31" 26 Guns
37" 30 Guns
41" 38 Guns
51" 46 Guns
61" 54 Guns

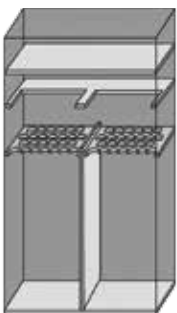

ALL GUN RACK CONFIGURATION

26" 16 Guns
31" 36 Guns
37" 44 Guns
41" 52 Guns
51" 68 Guns
61" 84 Guns



COLLECTOR CONFIGURATION

26" 18 Guns
31" 40 Guns
37" 48 Guns
41" 57 Guns
51" 73 Guns
61" 100 Guns

PICK YOUR OPTIONS & ACCESSORIES

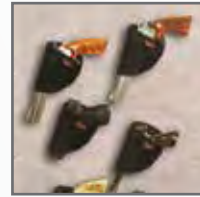

DOOR HOLSTERS

(pack of 5 or pack of 10)

Organize your handguns with ease. Hook and loop material allows easy positioning and repositioning instantly. Strong enough to securely hold the largest hand guns. One size fits most.



DOOR RACK

Keep your handguns and other valuables accessible, and your vault organized with our door mounted rack and covered hook system.



JEWELRY BAGS

A hook-and-loop jewelry bag is a must for all of the jewelry, coins or other items that you don't want to scratch. The plush lining with the drawstring top is a great storage option for those items that you want to be discrete about while protecting their beauty.



STORAGE BAG

Here is a hook-and-loop friendly way to store items on the safe door and not take up precious shelf room. Use one, two or three to store as many items as you need. It has a zipper top along with a hook-and-loop flap to keep things secure along with a plush lining inside to protect the contents.



WATER RESISTANT POCKET

This hook-and-loop compatible storage pocket is a great way to store gun oil, cleaning fluid or other items that might leak in your safe. With a clear front, you can store and see what is inside very easily.



POCKET

This plush lined long zipper pocketed storage bag is hook-and-loop friendly and comes with a convenient handle. Store your magazines, cash, knives or other items in this pocket and make more room on the shelf for other items. Add as many pockets as you want to fit on the door!



COMPLETE DOOR ORGANIZER

The Door Organizer gives you a variety of options for added storage. Cargo net pockets, zippered pockets and pistol holsters are all included for additional convenience and organization. Take advantage of all the usable space in your vault and add the Tactical Door Organizer to your options list.



SHOWN
CLOSED -
CONCEALED

SHOWN
OPEN -
DISPLAY

CONCEALMENT SHELVING

This high quality decorative shelf makes an excellent addition in any home and serves as an excellent showcase for your prized possessions. Vaults are the best security for your firearms but quick access can be elegant. Both elegance and quick access come in with Fort Knox Concealment Shelving. Access is controlled through a special magnetic key.



EVADRY 500

Dry unit contains Water Glass Technology crystals. Water Glass is a very thirsty substance that has an absorption rate much higher than traditional, soluble humidity adsorbing products.

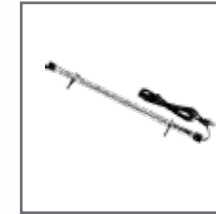

DEHUMIDIFIER

Keep more than burglars away! Moisture can ruin your valuables quickly and silently. Our humidity control rod maintains a moisture-free environment inside your vault.



CARPETED VAULT PEDESTAL

Raise your vault with a sturdy Carpeted Vault Pedestal. Increase the access height of your vault by five inches.



LIGHT PACKAGE

Light up the interior of your vault with fluorescent lights that surround the door frame. When the door is opened, these lights will make your valuables shine.

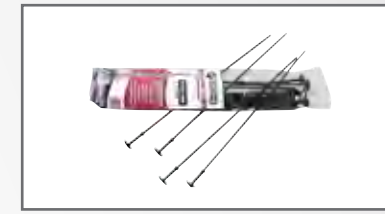

with interior lights /
without interior lights

RIFLE RODS

Rifle Rods are a great way to position your long guns in your vault without the need for a gun rack. Place the Rifle Rod down the barrel of your long gun, position the gun and then extend the Rifle Rod up to connect it to the upper shelf. The Rifle Rods are connected to the shelf with strong adhering Velcro.



TURRET SYSTEM

The turret system that can be installed into your vault will help maximize the amount of space you can use inside your vault. Attaching to the door, the turret hold 8-12 guns securely upright and swings with the door, allowing for easy gun access while open, and maximum space efficiency when closed.

Visit FtKnox.com and explore other great products that only Fort Knox can deliver.

SHOWN EMPTY



TURRET FEATURES

- Available on most Fort Knox vaults
- Holds 8-12 guns
- Works with most gun lengths
- Maximizes storage
- Easier gun access
- Requires external hinges



SECURITY MADE PERFECT

Fort Knox is the impenetrable standard in vault craftsmanship,
providing high-caliber protection since 1983.

CHECK INSIDE FOR TRUE DETAIL.

ftknox.com
1-800-821-5216

Copyright 2015 Fort Knox Inc. All Rights Reserved