

The electronics and technology of Frog Plus

CUTTING-EDGE ELECTRONICS: ZM3EP.

Frog Plus is fitted with the new generation ZM3EP control panel, specifically engineered to ensure the system's top management performance, even for very large gates. In fact, besides the normal command and safety functions, the new ZM3EP electronics state-of-the-art functionalities and special details which provide total control of the operator and optimal service levels.

- **Self-diagnosing safety devices.**
- **Function programming and viewing display.**
- **Gate-run control and encoder-based obstacle detection.**
- **Stores** radio commands with different codes (up to 250 users).
- **Safety is ensured even when the gate is still.** Each command is cancelled if any obstacles are detected by the safety devices.

MADE IN ITALY, MADE IN CAME.

The 100% original Made in Italy Trademark is testimony that Frog Plus stems from a quality manufacturing process, which is designed to make technologically reliable and efficient products. Came products undergo wear and tear testing equivalent to 10/15 years of intense operation, as well as resistance and extreme temperature testing, including specific electro-magnetic (inductive and conductive) interference tests. That is why, if properly installed, Frog Plus is longer lasting. No problem. It means prestige and confidence for those installing it, and safety and peace-of-mind to those using it.

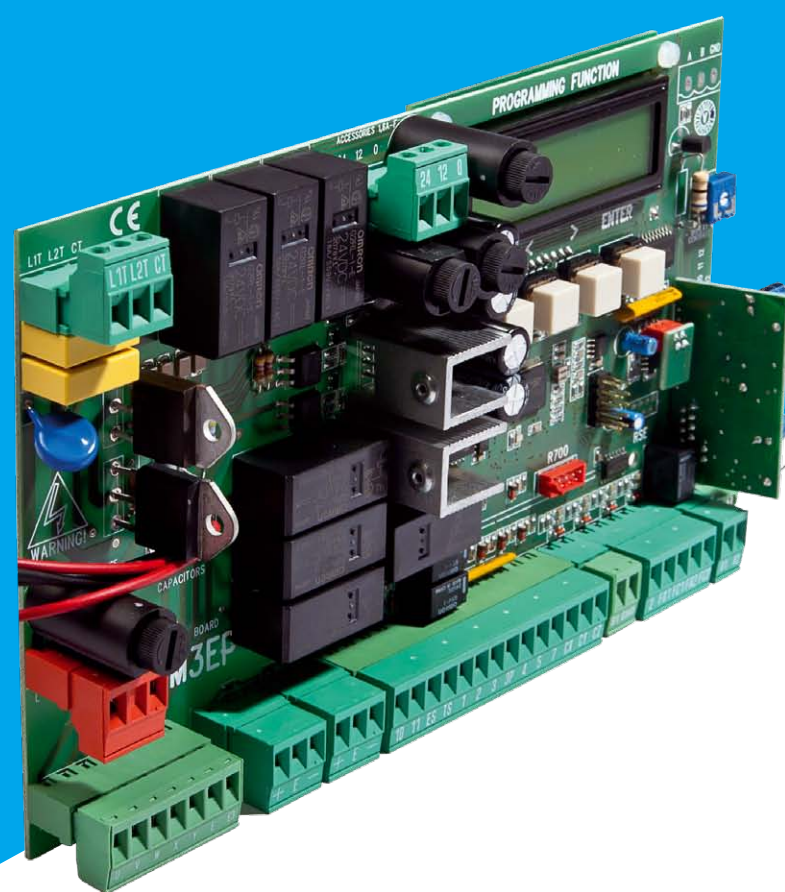

our range Frog Plus

Below-ground 230 V AC operators		
001FROG-PM4	Self-locking operator with encoder for gate-leaves of up to 5.5 m.	
001FROG-PM6	Self-locking operator with encoder for gate-leaves of up to 7 m.	
Control panels for 230 V operators		
002ZM3EP	Multifunction control panel for two leaf swing gates with signalling display, self-diagnosis of safety devices, and built-in radio decoding.	
Accessories		
001FROG-PC	Cataphoresis rust-proof treated steel foundation box, complete with transmission lever with adjustable opening gate- leaf stop.	
001A4801	Endstop.	
001A4364	Lever-key release.	
001A4365	Triangular key release.	
001A4366	Customised key release and EURO-DIN cylinder.	
001LOCK81	Electric lock with single cylinder.	
001LOCK82	Electric lock with double cylinder.	

Dimensions (mm)

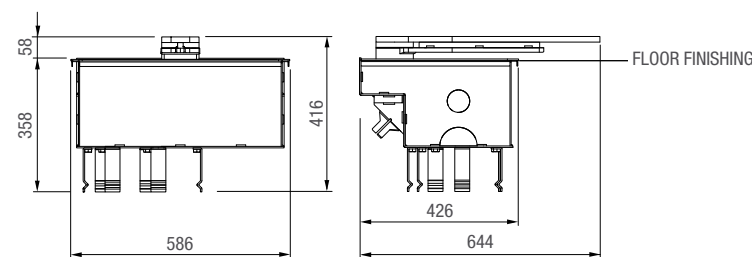

Limits to use

MODEL	FROG-PM4		
Max gate-leaf width (m)	5.5*	4.5*	3.5*
Max gate-leaf weight (Kg)	700	900	1100
MODEL	FROG-PM6		
Max gate-leaf width (m)	7*	5*	4*
Max gate-leaf weight (Kg)	550	650	1000

● 230 V AC

Technical features

Type	FROG-PM4	FROG-PM6
IP protection rating	IP67	IP67
Power supply (50 V - 60/60 Hz)	230 AC	230 AC
Motor power supply (50 V - 60/60 Hz)	230 AC	230 AC
Current draw (A)	5.1	2.6
Power (W)	1200	600
Opening time at 90° (s)	30	45
Duty cycle (%)	50	50
Thrust (N)	800	800
Operating temperature (°C)	-20 ÷ +55	-20 ÷ +55
Motor thermo protection (°C)	150	150

● 230 V AC

Application (mm)

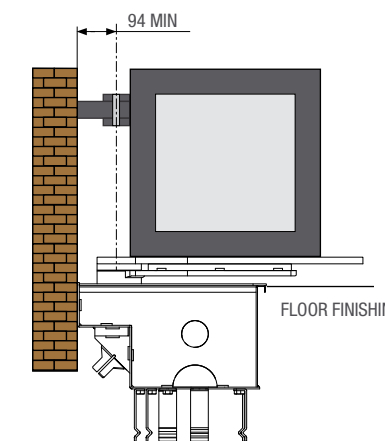

NOTES:
*The electric lock is obligatory for lengths over 3.5 metres.



BELOW-GROUND OPERATOR FOR SWING GATES UP TO 7 METRES



Frog Plus

FIND OUT ABOUT CAME'S LATEST from your licensed dealer or on came.com

© Came - KDEP/CE/NA/PE/11



CAME cancelli automatici s.p.a.
via Martiri della Libertà, 15
31030 Dosson di Casier
Treviso - Italy
Tel. (+39) 0422 4940
Fax (+39) 0422 4941
info@came.it
www.came.com



Frog Plus

Unrivalled power

Came's Frog Plus is the new "out-of-sight" solution; ideal for powering swing gates of truly large dimensions. It is unmatched in terms of power and can even move large swing doors like hangar doors or special doors fitted in industrial facilities, army bases, prisons and large collective structures.

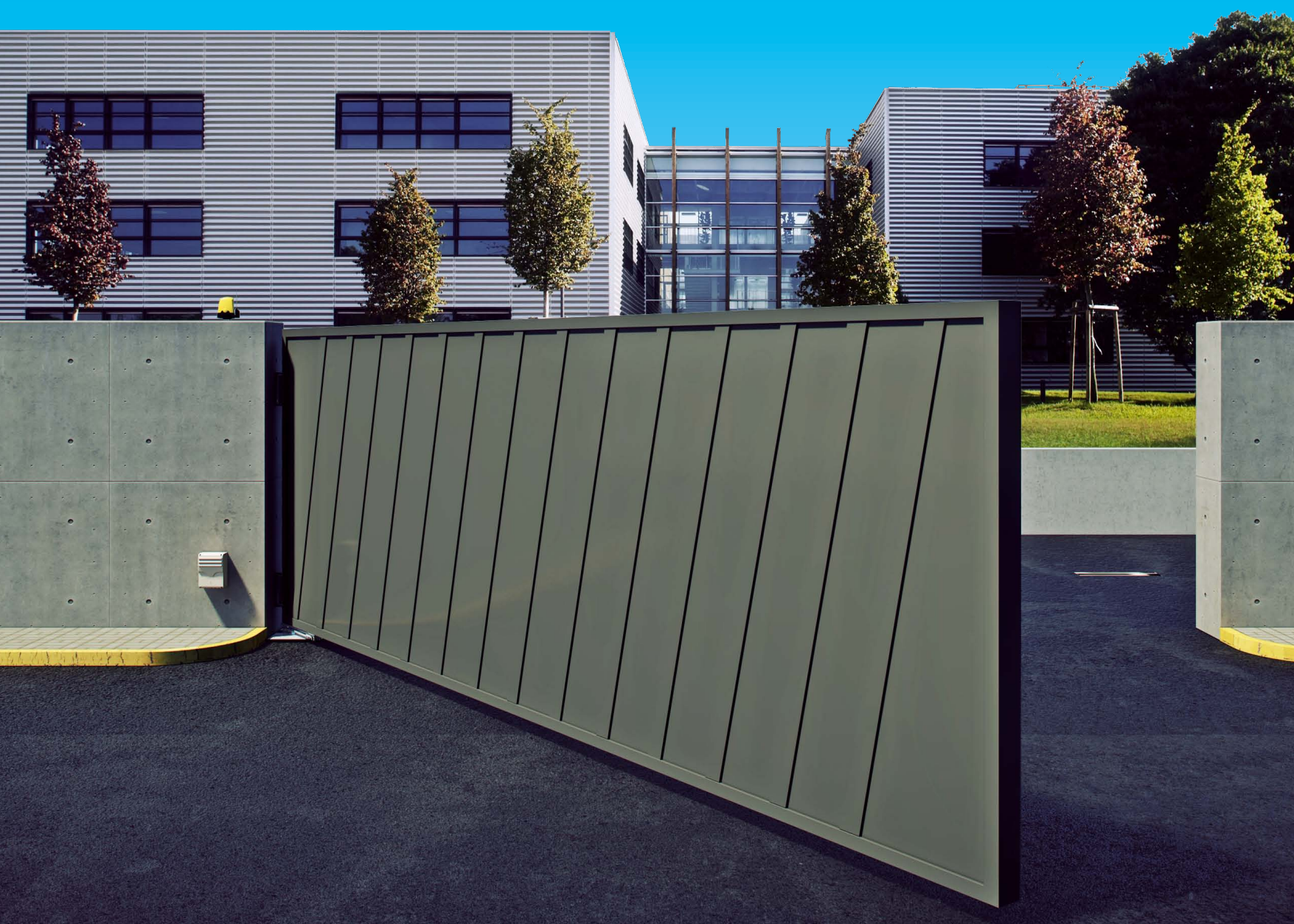

The reasons for choosing Frog Plus

UNSEEN, RESISTANT, RELIABLE.

Available in the 4 and 6-pole motor, Frog Plus can power swing gate-leaves up to 7 metres long or 11 quintals and lets you choose the most suitable solution depending on what is required.

NEW SOLUTIONS, NEW PERFORMANCE LEVELS.

• Withstands anything!

The materials used and the high IP67 protection-rating from weather agents, make Frog Plus extremely resistant over time while cutting back on periodic maintenance.

• Foundation box.

Built of very-thick steel and treated with cathoporesis rust-proofing.

• Cutting-edge electronics.

Guarantees all evolved functionalities for automation control and user safety.

• A green light for frequent passages.

Frog Plus is ideal for contexts with high traffic flow-rates.

THE NEW ENDSTOP SYSTEM... EVEN ELECTRO-MECHANICAL

The foundation box and operator are fitted with a series of opening and closing-adjustable endstops. Also available, as an additional accessory, is the electro-mechanical endstop to manage the endpoints of the leaves, thus preventing any overextensions at the end of the gate run.

Moreover, the foundation box is fitted with a special replaceable supporting pin for easier preventive maintenance actions and to ensure durable resistance to the system.



THE NEW ENDSTOP SYSTEM

- 1 OPENING endstop
- 2 CLOSING endstop
- 3 Electro-mechanical endstop

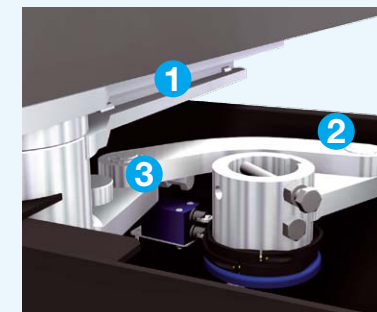

INTERCHANGEABLE SUPPORTING PIN

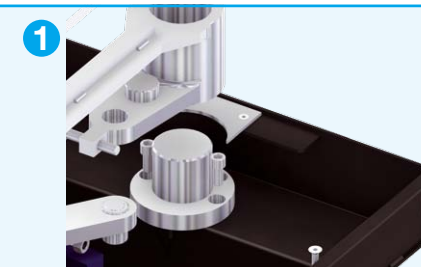

The supporting pin is fitted with bolts on the foundation box.

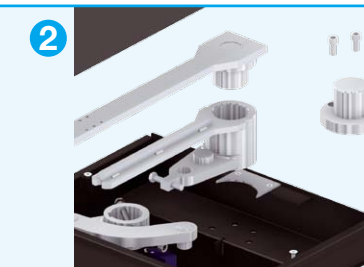

Can be replaced if required.



This simplifies system maintenance.