



Terminal Technologies (I) Pvt. Ltd



Making the right connections

CATALOGUE

PRODUCT FINDER

Connectors

Sr. No.	Part No.	Page No.	Sr. No.	Part No.	Page No.
1	TTP-010FN	25	70	TTP-22FH	30
2	TTP-010MN	25	71	TTP-22FN	30
3	TTP-012FN	25	72	TTP-22FNA	42
4	TTP-012MN	25	73	TTP-22MN	30
5	TTP-018FN	25	74	TTP-22MNA	42
6	TTP-018MN	25	75	TTP-22MNB	42
7	TTP-01SL	41	76	TTP-22MNC	42
8	TTP-020FN	26	77	TTP-22MND	42
9	TTP-020MN	26	78	TTP-22MNE	42
10	TTP-02FN	24	79	TTP-22MNF	42
11	TTP-02FN(WS)	26	80	TTP-22MNG	42
12	TTP-02MFB	38	81	TTP-22MNR	42
13	TTP-02MN	24	82	TTP-22RFN	32
14	TTP-02MN(WS)	26	83	TTP-22RMN	32
15	TTP-02SL	41	84	TTP-23CP	38
16	TTP-03SL	41	85	TTP-23FB	37
17	TTP-04FN(WS)	26	86	TTP-23FC	38
18	TTP-04MN(WS)	26	87	TTP-23FN	30
19	TTP-04SL	41	88	TTP-23FNH	32
20	TTP-05SL	41	89	TTP-23MN	30
21	TTP-06FB-MB	36	90	TTP-24FN	30
22	TTP-06FN	24	91	TTP-24MN	30
23	TTP-06FN(WS)	26	92	TTP-24MNA	43
24	TTP-06MFB	38	93	TTP-24MNB	43
25	TTP-06MN	24	94	TTP-24MNC	43
26	TTP-06MN(WS)	26	95	TTP-24MND	43
27	TTP-073MN	24	96	TTP-24MNF	43
28	TTP-078FN	24	97	TTP-24MNG	43
29	TTP-078MN	24	98	TTP-2625	40
30	TTP-07HFN	54	99	TTP-2676	40
31	TTP-07HMN	54	100	TTP-26FN	31
32	TTP-08FN	25	101	TTP-26MN	31
33	TTP-08MFB	38	102	TTP-26MNA	43
34	TTP-08MFC	38	103	TTP-2827	40
35	TTP-08MN	25	104	TTP-2860	56
36	TTP-08TL	40	105	TTP-2861	56
37	TTP-12FN	27	106	TTP-2868	37
38	TTP-12MN	27	107	TTP-28FN	31
39	TTP-12MN-RIB	27	108	TTP-28MN	31
40	TTP-12MNS	27	109	TTP-28MNA	43
41	TTP-13FN	27	110	TTP-28MNB	43
42	TTP-13MN	27	111	TTP-2904	31
43	TTP-13MN-RIB	27	112	TTP-2910	56
44	TTP-14FB	36	113	TTP-2931	56
45	TTP-14FC	36	114	TTP-2959	56
46	TTP-14FN	27	115	TTP-2SSC	54
47	TTP-14MN	27	116	TTP-31FN	32
48	TTP-14MN-RIB	28	117	TTP-31FN(CL)	33
49	TTP-1638A	37	118	TTP-31MN	32
50	TTP-1638B	37	119	TTP-31MN(CL)	33
51	TTP-1638C	37	120	TTP-32FN	33
52	TTP-1657	31	121	TTP-32FN(RIB)	33
53	TTP-16FN	28	122	TTP-32MAX	37
54	TTP-16MN	28	123	TTP-32MN	33
55	TTP-16MN-RIB	28	124	TTP-32MN(RIB)	33
56	TTP-1818	37	125	TTP-38FN	31
57	TTP-1820	56	126	TTP-38FN-L	31
58	TTP-1832	56	127	TTP-3904	32
59	TTP-1855A	50	128	TTP-4638	37
60	TTP-1868P	36	129	TTP-4868	37
61	TTP-1903	36	130	TTP-4868H	37
62	TTP-1903A	36	131	TTP-4902	40
63	TTP-1904	31	132	TTP-6FB	36
64	TTP-1960	32	133	TTP-6FC	36
65	TTP-19FN	28	134	TTP-8902	40
66	TTP-19MN	28	135	TTP-9902	41
67	TTP-19MN-RIB	28	136	TTP-BASE	54
68	TTP-21FN	30	137	TTP-C07	58
69	TTP-21MN	30	138	TTP-C08	59

PRODUCT FINDER

Connectors

Sr. No.	Part No.	Page No.	Sr. No.	Part No.	Page No.
139	TTP-C09	59	172	TTP-RB2	46
140	TTP-C10	58	173	TTP-RB21	47
141	TTP-C13	58	174	TTP-RB3	46
142	TTP-C15	58	175	TTP-RB4(s)	46
143	TTP-C19	58	176	TTP-RB5	46
144	TTP-C22	58	177	TTP-RB6	46
145	TTP-C28	59	178	TTP-RB7	46
146	TTP-CC 3/8 RBC	59	179	TTP-RB8	46
147	TTP-CH2P	54	180	TTP-RBH	48
148	TTP-CHG2P	55	181	TTP-RBH3	48
149	TTP-CLO6FB	36	182	TTP-SL2W	38
150	TTP-DC	55	183	TTP-SL3W	38
151	TTP-FRA16	48	184	TTP-SP1	55
152	TTP-FRA6	48	185	TTP-SP2	55
153	TTP-FRA6C	48	186	TTP-SP3	55
154	TTP-FRA6K	48	187	TTP-SP4	55
155	TTP-HL2	50	188	TTP-SP5	55
156	TTP-HL2L	50	189	TTP-SP6	55
157	TTP-HL2R	50	190	TTP-SP7	38
158	TTP-HL3	50	191	TTP-SP8	56
159	TTP-INCAP	50	192	TTP-SP9	56
160	TTP-INCLINED CLIP	55	193	TTP-SS2FN	52
161	TTP-L2FN	32	194	TTP-SS2MN	52
162	TTP-RB1	46	195	TTP-SS3FN	52
163	TTP-RB10	46	196	TTP-SS3MN	52
164	TTP-RB11	47	197	TTP-SS4FN	52
165	TTP-RB12	47	198	TTP-SS4MN	52
166	TTP-RB14	47	199	TTP-SS5FN	52
167	TTP-RB15	47	200	TTP-SS5MN	52
168	TTP-RB16	47	201	TTP-SS6FN	52
169	TTP-RB17	47	202	TTP-SS6MN	52
170	TTP-RB18	47	203	TTP-STRIP	54
171	TTP-RB19	47	204	TTP-TMCP	54

Terminals

Sr. No.	Part No.	Page No.	Sr. No.	Part No.	Page No.
1	TT-1U	105	28	TT-1365	112
2	TT-1004	86	29	TT-1378	62
3	TT-1009	86	30	TT-1389	66
4	TT-1011	70	31	TT-1391	62
5	TT-1012	70	32	TT-1406	80
6	TT-1013	70	33	TT-1410	89
7	TT-1128	64	34	TT-1416	89
8	TT-1211	75	35	TT-1423	87
9	TT-1242	84	36	TT-1425	73
10	TT-1260	68	37	TT-1427	82
11	TT-1263	71	38	TT-1428	64
12	TT-1283	67	39	TT-1429	64
13	TT-1311	75	40	TT-1429S	64
14	TT-1312	76	41	TT-1435	98
15	TT-1313	70	42	TT-1442	85
16	TT-1317	110	43	TT-1446	91
17	TT-1321	98	44	TT-1447	91
18	TT-1322	110	45	TT-1448	99
19	TT-1326	84	46	TT-1460	68
20	TT-1337	98	47	TT-1476	99
21	TT-1342	85	48	TT-1478	62
22	TT-1345	67	49	TT-1488	65
23	TT-1348	67	50	TT-1491	64
24	TT-1355	80	51	TT-1493	92
25	TT-1360	67	52	TT-1501	108
26	TT-1362	95	53	TT-1503	89
27	TT-1363	72	54	TT-1505	80

PRODUCT FINDER

Terminals

Sr. No.	Part No.	Page No.	Sr. No.	Part No.	Page No.
55	TT-1506	80	124	TT-1721	94
56	TT-1508	86	125	TT-1725	91
57	TT-1509	80	126	TT-1727	82
58	TT-1510	89	127	TT-1738	95
59	TT-1511	62	128	TT-1745	111
60	TT-1516	88	129	TT-1746	87
61	TT-1518	99	130	TT-1755	80
62	TT-1519	99	131	TT-1770	73
63	TT-1520	98	132	TT-1771	72
64	TT-1521	98	133	TT-1774	75
65	TT-1522	99	134	TT-1775	90
66	TT-1523	88	135	TT-1779	81
67	TT-1524	62	136	TT-1782	90
68	TT-1525	62	137	TT-1783	66
69	TT-1526	62	138	TT-1791	76
70	TT-1533	88	139	TT-1793	92
71	TT-1533L	88	140	TT-1805	86
72	TT-1554	90	141	TT-1806	92
73	TT-1555	80	142	TT-1807	73
74	TT-1556	94	143	TT-1807K	73
75	TT-1556U	94	144	TT-1808	91
76	TT-1557	71	145	TT-1809	92
77	TT-1562	95	146	TT-1810K	73
78	TT-1563	71	147	TT-1811	74
79	TT-1564	68	148	TT-1811(U)	74
80	TT-1566	90	149	TT-1812	74
81	TT-1567	91	150	TT-1812(U)	74
82	TT-1570	71	151	TT-1813	74
83	TT-1573	95	152	TT-1816	114
84	TT-1578	71	153	TT-1818	78
85	TT-1579	71	154	TT-1822	85
86	TT-1591	66	155	TT-1823	74
87	TT-1592	82	156	TT-1824	74
88	TT-1593	92	157	TT-1825	91
89	TT-1594	67	158	TT-1828	64
90	TT-1598	66	159	TT-1829	64
91	TT-1601	66	160	TT-1833	99
92	TT-1602	71	161	TT-1834	99
93	TT-1603	94	162	TT-1835	98
94	TT-1603U	94	163	TT-1840	73
95	TT-1604	72	164	TT-1841	84
96	TT-1605	72	165	TT-1846	87
97	TT-1606	72	166	TT-1847	85
98	TT-1609	88	167	TT-1849	88
99	TT-1610	95	168	TT-1850	65
100	TT-1611	78	169	TT-1851	87
101	TT-1613	62	170	TT-1852	108
102	TT-1616	114	171	TT-1853	94
103	TT-1617	78	172	TT-1854	90
104	TT-1620	82	173	TT-1855	80
105	TT-1621	82	174	TT-1856	65
106	TT-1622	110	175	TT-1860	68
107	TT-1628	64	176	TT-1863	81
108	TT-1629	64	177	TT-1864	68
109	TT-1632	65	178	TT-1865	73
110	TT-1636	65	179	TT-1866	73
111	TT-1638	95	180	TT-1867	84
112	TT-1646	66	181	TT-1868S	94
113	TT-1648	68	182	TT-1870	84
114	TT-1657	72	183	TT-1871	85
115	TT-1670	72	184	TT-1872	86
116	TT-1681	72	185	TT-1873	87
117	TT-1682	90	186	TT-1874	81
118	TT-1695	65	187	TT-1876	99
119	TT-1696	65	188	TT-1879	81
120	TT-1698	65	189	TT-1881	75
121	TT-1704	72	190	TT-1882	90
122	TT-1708	91	191	TT-1883	67
123	TT-1716	81	192	TT-1884	81

PRODUCT FINDER

Terminals

Sr. No.	Part No.	Page No.	Sr. No.	Part No.	Page No.
193	TT-1885	91	262	TT-2827	108
194	TT-1891	62	263	TT-2839	108
195	TT-1892	62	264	TT-2840	77
196	TT-1893	92	265	TT-2843	111
197	TT-1898	88	266	TT-2852	108
198	TT-1900	98	267	TT-2855	80
199	TT-1901	111	268	TT-2860	111
200	TT-1902	110	269	TT-2863	82
201	TT-1903	94	270	TT-2866	74
202	TT-1903U	94	271	TT-2872	86
203	TT-1906	87	272	TT-2874	81
204	TT-1907	89	273	TT-2888	114
205	TT-1909	75	274	TT-2889	114
206	TT-1911	75	275	TT-2890	114
207	TT-1912	68	276	TT-2892	114
208	TT-1916	81	277	TT-2898	89
209	TT-1917	92	278	TT-2906	87
210	TT-1918	71	279	TT-2907	89
211	TT-1923	98	280	TT-2910	111
212	TT-1925	73	281	TT-2916	81
213	TT-1927	82	282	TT-2932	111
214	TT-1938	98	283	TT-2935	77
215	TT-1939	110	284	TT-2936	114
216	TT-1941	84	285	TT-2941	114
217	TT-1945	87	286	TT-2958	95
218	TT-1946	84	287	TT-2959	111
219	TT-1947	85	288	TT-2960	70
220	TT-1948	68	289	TT-2961	70
221	TT-1949	86	290	TT-2967	77
222	TT-1955	67	291	TT-2970	77
223	TT-1958	95	292	TT-2971	77
224	TT-1960	70	293	TT-2972	77
225	TT-1961	70	294	TT-3U	105
226	TT-1963	75	295	TT-5003U	102
227	TT-1965	67	296	TT-5004U	102
228	TT-1967	75	297	TT-5005U	102
229	TT-1968	68	298	TT-5007U	103
230	TT-1969	75	299	TT-5009U	102
231	TT-1970	76	300	TT-5010U	102
232	TT-1972	76	301	TT-5011U	103
233	TT-1977	62	302	TT-5017U	103
234	TT-1980	76	303	TT-5018U	103
235	TT-1982	76	304	TT-5029	104
236	TT-1983	67	305	TT-5050U	103
237	TT-1986	65	306	TT-5104U	102
238	TT-1989	66	307	TT-5108U	102
239	TT-1992	92	308	TT-5109U	102
240	TT-1993	92	309	TT-5113U	103
241	TT-1994	85	310	TT-5120U	103
242	TT-1996	66	311	TT-5125	104
243	TT-2011	70	312	TT-5152U	105
244	TT-2012	76	313	TT-5155U	103
245	TT-2313	71	314	TT-5251U	105
246	TT-2324	112	315	TT-5549U	104
247	TT-2352	108	316	TT-5913	104
248	TT-2538	76	317	TT-5914	104
249	TT-2549	77	318	TT-5915	104
250	TT-2560	112	319	TT-9U	105
251	TT-2614	110			
252	TT-2625	108			
253	TT-2675	90			
254	TT-2681	112			
255	TT-2689	112			
256	TT-2732	110			
257	TT-2737	112			
258	TT-2808	91			
259	TT-2810K	74			
260	TT-2823	77			
261	TT-2826	108			

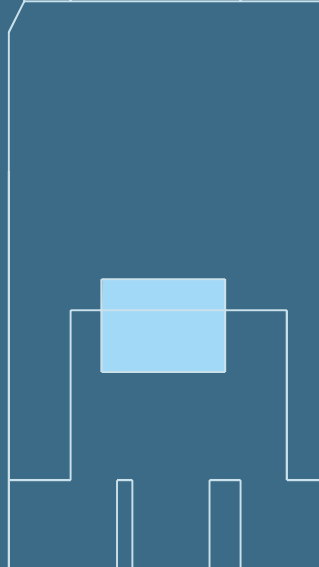
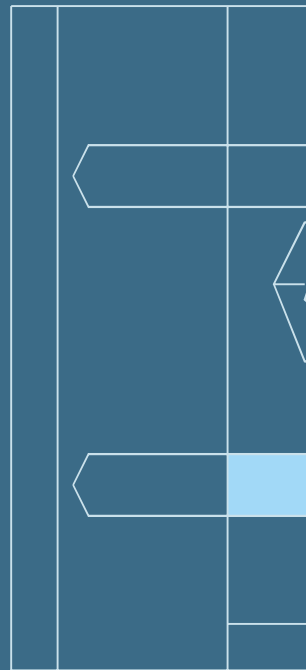
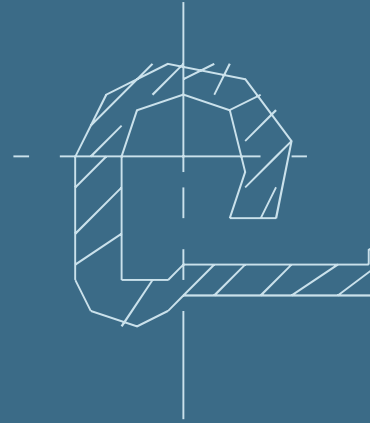
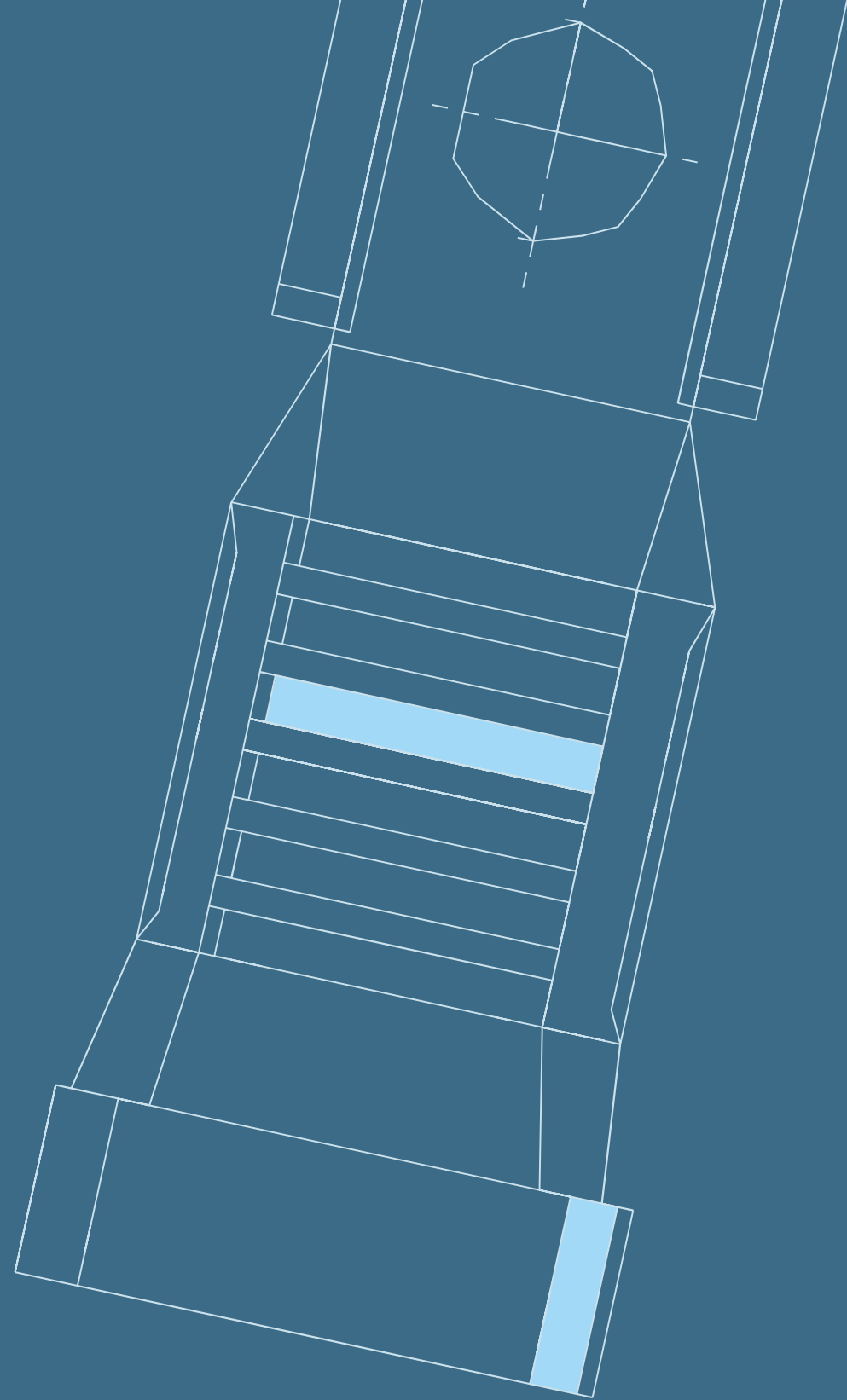

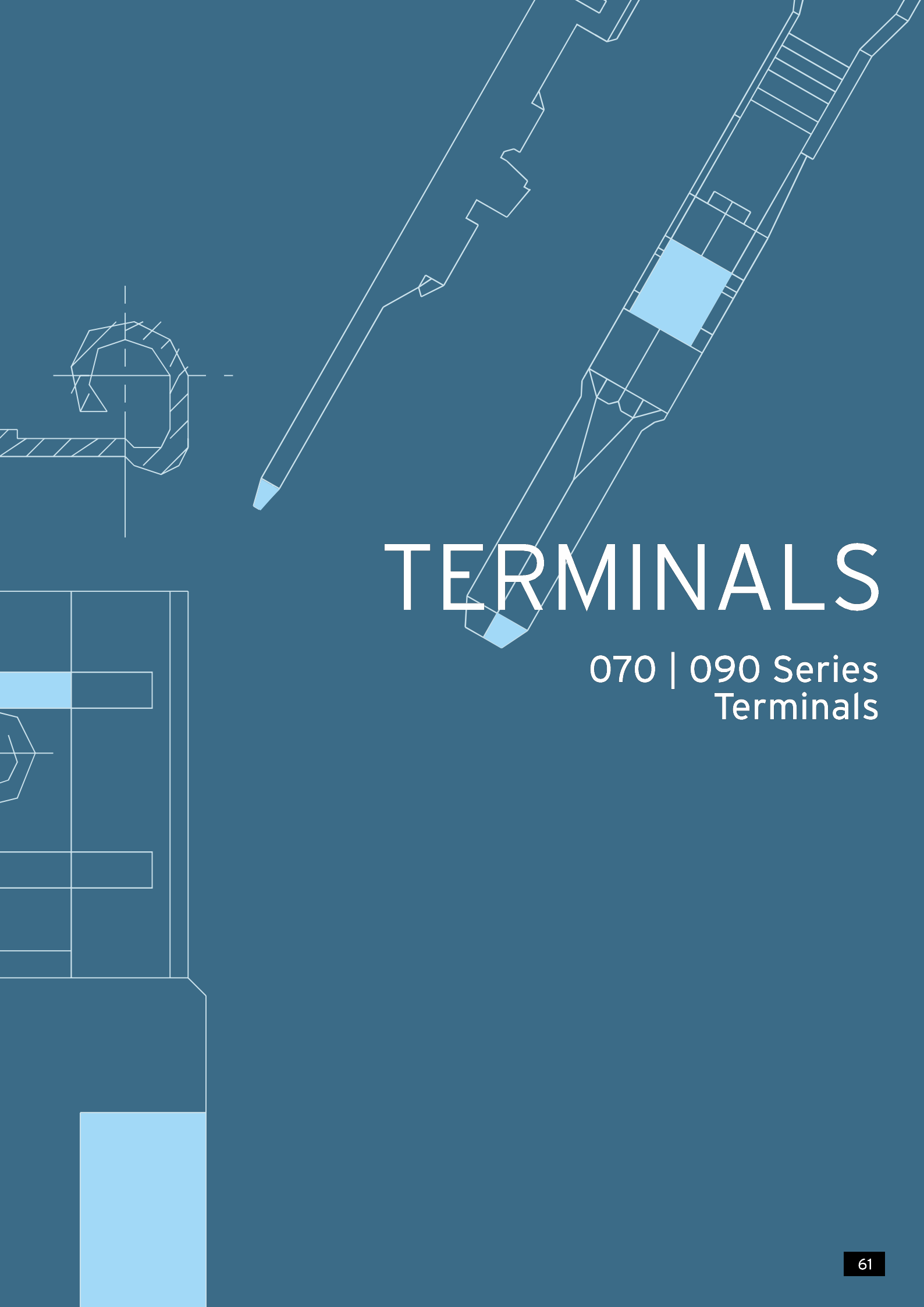

TERMINALS

070 | 090 Series
Terminals

070 Series Terminals

CATEGORY NO.	TAB SIZE	CABLE SIZE MM ²	DESCRIPTION	APPLICABLE MATING TERMINAL	MATERIAL	STANDARD PACKING QTY. [NOS.]
TT-1613	1.70 X 0.60	0.75 - 1.25	Male For Coupler Locking	NA	CuZn	3000

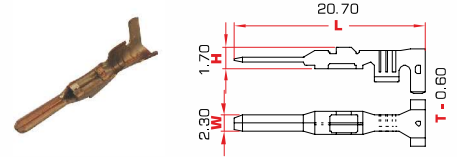

090 Series Terminals

TT-1478 REMARK Sealed	2.30 X 0.60	0.50 - 1.50	Male For Coupler Locking	TT-1891	CuZn	3000
TT-1378 REMARK Sealed	2.30 X 0.60	0.35	Male For Coupler Locking	TT-1891	CuZn	3000
TT-1891 REMARK Sealed	2.30 X 0.60	0.50-1.50	Female For Coupler Locking	TT-1478	CuZn	3500
TT-1391 REMARK Sealed	2.30 X 0.60	0.35-0.50	Female For Coupler Locking	TT-1478	CuZn	3500
TT-1526	2.30 X 0.60	0.20-0.50	Male For Coupler Locking	TT-1525	CuZn	3000
TT-1525	2.30 X 0.60	0.20-0.50	Female For Coupler Locking	TT-1526	CuZn	4000
TT-1511	2.30 X 0.60	0.75-1.50	Male For Coupler Locking	TT-1524	CuZn	3000
TT-1524	2.30 X 0.60	0.75-1.50	Female For Coupler Locking	TT-1511	CuZn	4000
TT-1892 REMARK Sealed	2.30 X 0.60	0.50-1.25	Female With Lancing	NA	CuZn	3500
TT-1977	2.30 X 0.50	0.50-1.00	Female With Embossing	NA	CuZn	20000

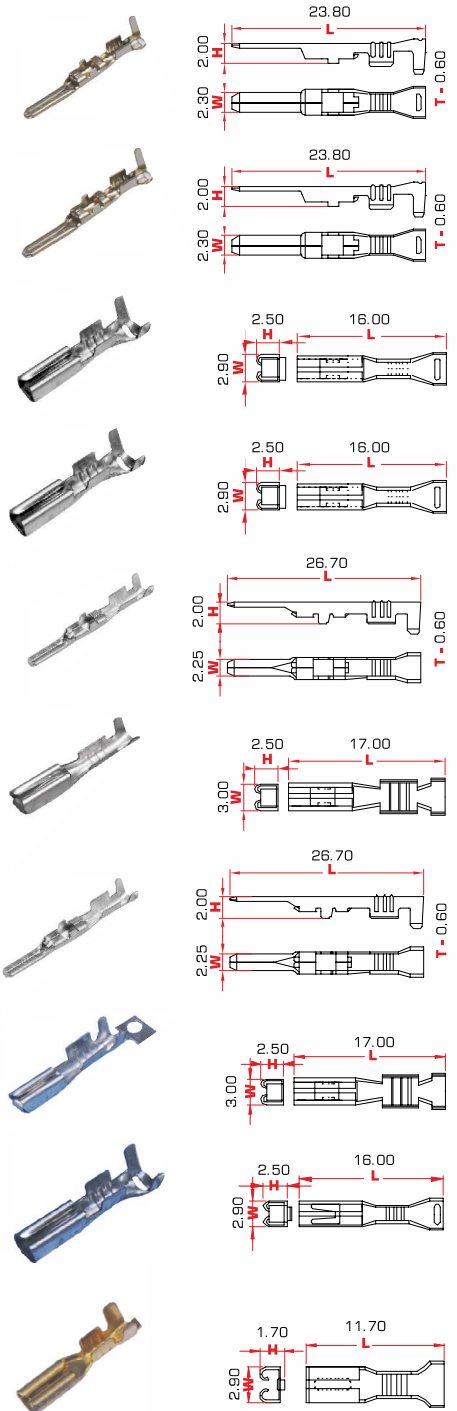

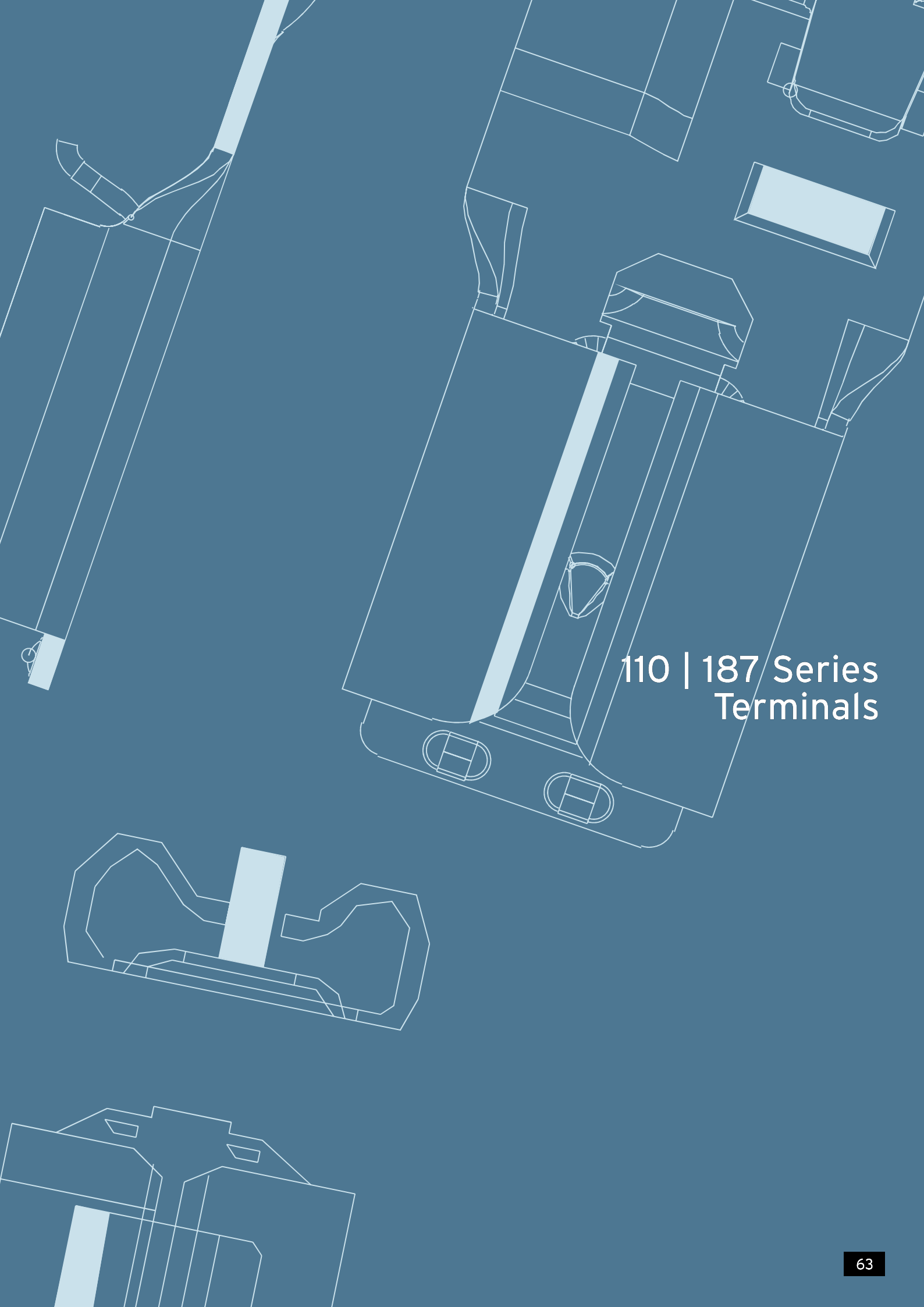

110 | 187 Series
Terminals

110 Series Terminals

CATEGORY NO.	TAB SIZE	CABLE SIZE MM ²	DESCRIPTION	APPLICABLE MATING TERMINAL	MATERIAL	STANDARD PACKING QTY. [NOS.]	
TT-1428	2.80 X 0.50	0.50-1.25	Double Fold Female With Lancing	TT-1429	CuZn	4000	
TT-1128	2.80 X 0.50	0.30-0.85	Double Fold Female With Lancing	TT-1429	CuZn	4000	
TT-1429	2.80 X 0.50	0.30-0.85	Male With Lancing	TT-1628	CuZn	10000	
TT-1491 REMARK Side feed	2.80 X 0.50	0.30-0.85	Male With Lancing	TT-1628	CuZn	10000	
TT-1429S	2.80 X 0.50	0.30-0.85	Male With Lancing	TT-1628	CuZn	10000	
TT-1629 REMARK Side feed	2.80 X 0.50	0.30-0.85	Male With Lancing	TT-1628	CuZn	4000	
TT-1628	2.80 X 0.50	0.30-0.85	Double Fold Female With Lancing	TT-1429	CuZn	4000	
TT-1829	2.80 X 0.50	0.72-1.50	Male With Lancing	TT-1828	CuZn	10000	
TT-1828	2.80 X 0.50	0.72-1.50	Double Fold Female With Lancing	TT-1829	CuZn	4000	

CATEGORY NO.	TAB SIZE	CABLE SIZE MM ²	DESCRIPTION	APPLICABLE MATING TERMINAL	MATERIAL	STANDARD PACKING QTY. [NOS.]	
TT-1695	2.80 X 0.50	1.00	Female With Dimple & Emboss	TT-1636	CuZn	10000	
TT-1696	2.80 X 0.50	1.00	Female With Dimple & Emboss	TT-1829	CuZn	10000	
TT-1488	2.80 X 0.50	0.50-1.00	Female With Dimple	TT-1829	CuZn	10000	
TT-1850	2.80 X 0.50	0.50-1.00	Female With Lancing	TT-1829	CuZn	10000	
TT-1632	2.80 X 0.50	NA	Male For Pcb Mounting	TT-1696	CuZn	5000	
REMARK Loose							
TT-1636	2.80 X 0.50	NA	Male For Pcb Mounting	TT-1696	CuZn	5000	
REMARK Loose							
TT-1856	2.80 X 0.50	NA	Male For Pcb Mounting	TT-1696	CuZn	1000	
REMARK Loose							
TT-1986	2.80 X 0.50	NA	Male For Pcb Mounting	TT-1696	CuZn	1000	
TT-1698	2.80 X 0.80	1.00	Female With Dimple & Emboss	NA	CuZn	10000	

110 Series Terminals

CATEGORY NO.	TAB SIZE	CABLE SIZE MM ²	DESCRIPTION	APPLICABLE MATING TERMINAL	MATERIAL	STANDARD PACKING QTY. [NOS.]	
TT-1389	2.80 X 0.80	0.50-1.00	Female With Lancing	NA	CuZn	10000	
TT-1996	2.80 X 0.80	0.50-1.00	Female With Dimple Single Barrel	NA	CuZn	10000	
TT-1601	2.80 X 0.80	NA	Male Tab For Relay Base	TT-1698	CuZn	5000	
REMARK Loose							
TT-1646	2.80 X 0.80	0.50-1.00	Female With Dimple & Emboss Single Barrel	NA	CuZn	10000	
TT-1989	2.80 X 0.80	0.50-1.00	Female With Lancing	NA	CuZn	10000	

187 Series Terminals

TT-1591	4.80 x 0.50	0.50-1.50	Female With Dimple	TT-1883	CuZn	8000	
TT-1598	4.80 x 0.50	0.50-1.50	Female With Dimple & Window Side Flag	TT-1883	CuZn	4000	
TT-1783	4.80 x 0.50	0.50-1.50	Positive Lock	TT-1883	CuZn	8000	

187 Series Terminals

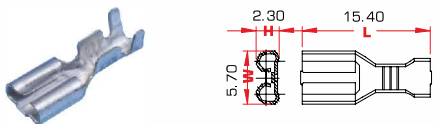
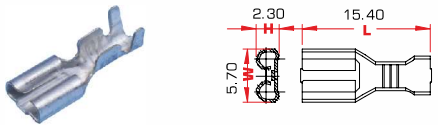
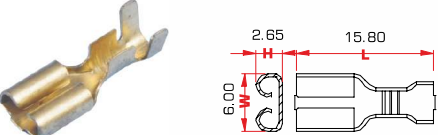
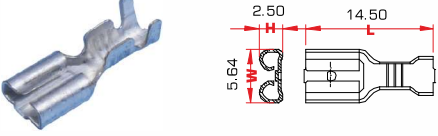
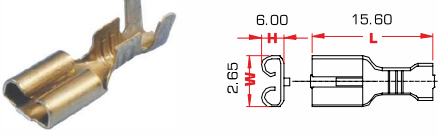
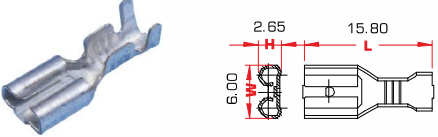
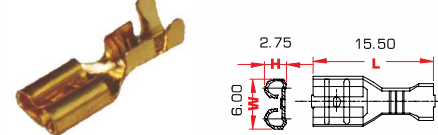
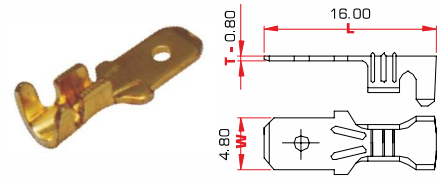
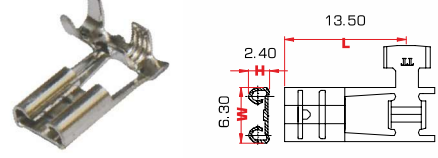

CATEGORY NO.	TAB SIZE	CABLE SIZE MM ²	DESCRIPTION	APPLICABLE MATING TERMINAL	MATERIAL		
TT-1283	4.80 x 0.80	0.30-0.50	Positive Lock	TT-1912	CuZn	8000	
TT-1983	4.80 x 0.80	0.50-1.50	Positive Lock Female	TT-1912	CuZn	10000	
TT-1348 REMARK Side Feed	4.80 x 0.80	0.50-1.25	Positive Lock	TT-1912	CuZn	1500	
TT-1345 REMARK Side Feed	4.80 x 0.50	0.50-1.25	Positive Lock	TT-1883	CuZn	1500	
TT-1955	4.80 x 0.50	0.50-1.00	Female With Dimple & Window	TT-1883	CuZn	8000	
TT-1965	4.80 x 0.50	0.75-1.50	Female With Dimple & Window	TT-1883	CuZn	8000	
TT-1883	4.80 x 0.50	1.00-2.00	Male Tab	TT-1965	CuZn	8000	
TT-1594	4.80 x 0.80	0.50-1.00	Female With Dimple & Window Side Flag	TT-1912	CuZn	4000	
TT-1360	4.80 x 0.35	0.50-1.00	Snap On Female	-	CuZn	10000	

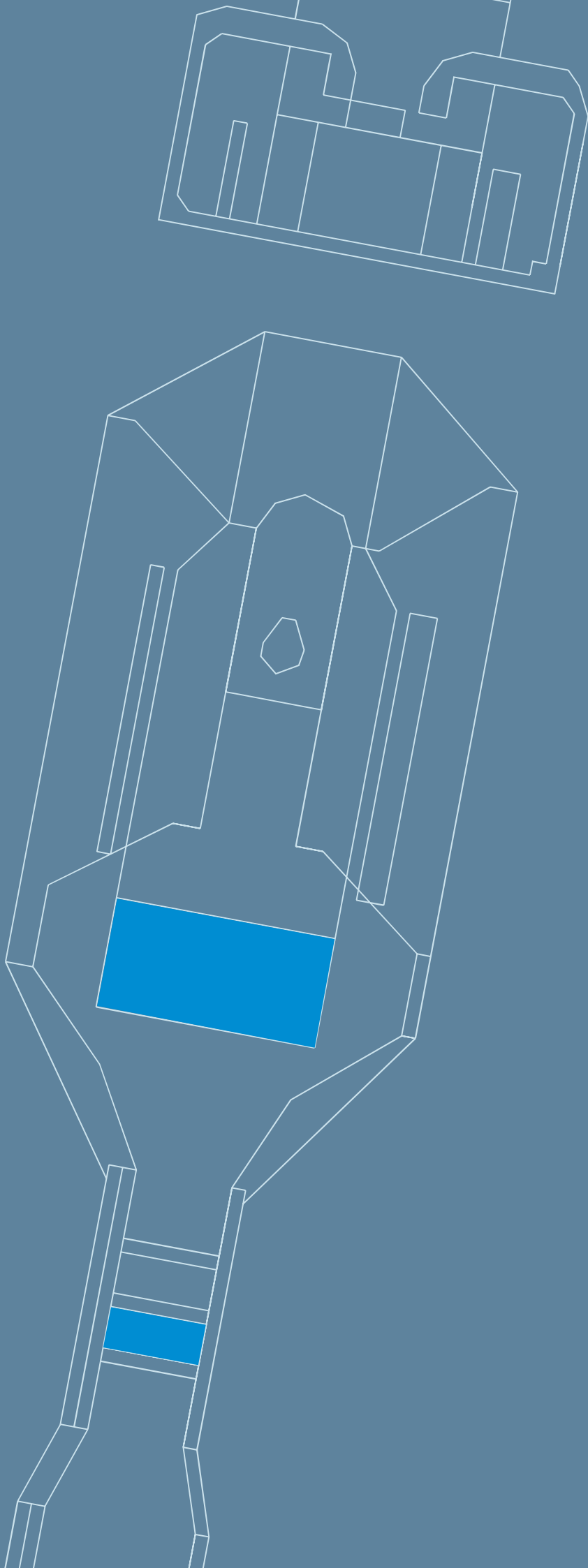
CATEGORY NO.	TAB SIZE	CABLE SIZE MM ²	DESCRIPTION	APPLICABLE MATING TERMINAL	MATERIAL	STANDARD PACKING QTY. [NOS.]	
TT-1460	4.80 x 0.35	0.20-0.50	Snap On Female	-	CuZn	10000	
TT-1260	4.80 x 0.38	0.20-0.50	Snap On Female	-	CuZn	10000	
TT-1648	4.80 x 0.80	1.50-2.00	Female Plain	TT-1912	CuZn	8000	
TT-1860	4.80 x 0.80	0.50-1.50	Female With Dimple	TT-1912	CuZn	10000	
TT-1864	4.80 x 0.80	0.50-1.25	Female With Lancing	TT-1912	CuZn	7000	
TT-1948	4.80 x 0.80	0.50-1.50	Female With Dimple	TT-1912	CuZn	8000	
TT-1968	4.80 x 0.80	0.50-1.50	Female With Dimple & Window	TT-1912	CuZn	8000	
TT-1912	4.80 x 0.80	1.00-2.00	Male Tab	TT-1968	CuZn	8000	
TT-1564	5.20 X 0.80	0.75-1.50	Female With Dimple & Window Side Flag	-	CuZn	4000	

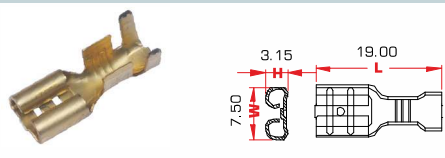
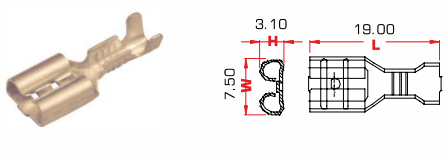
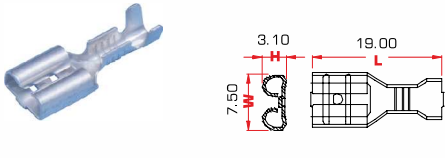
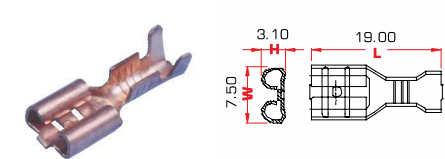
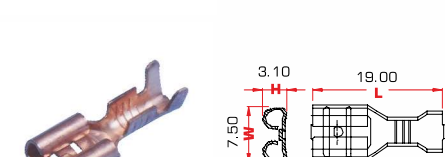
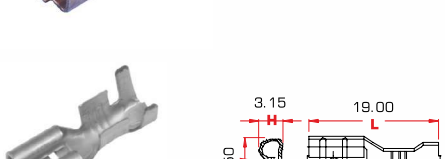
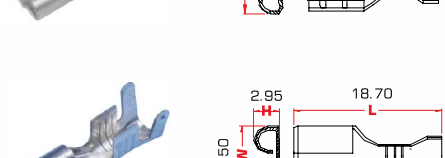

250 Series Terminals

250 Series Terminals

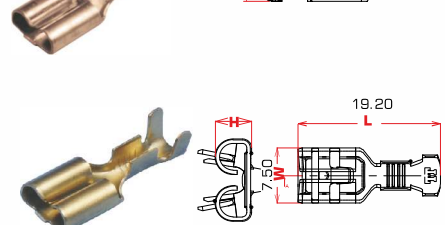
CATEGORY NO.	TAB SIZE	CABLE SIZE MM ²	DESCRIPTION	APPLICABLE MATING TERMINAL	MATERIAL	STANDARD PACKING QTY. [NOS.]	
TT-1011	6.30 x 0.80	2.00-4.00	Female With Dimple & Window	TT-1969	CuZn	4000	
TT-1960	6.30 X 0.80	0.75-2.00	Female With Dimple & Window	TT-1969	CuZn	5000	
TT-1961	6.30 X 0.80	0.50-1.50	Female With Dimple & Window	TT-1969	CuZn	6000	
TT-2960	6.30 X 0.80	0.75-2.00	Female With Dimple & Window	TT-2969	CuSn	5000	
TT-2961	6.30 X 0.80	0.75-1.50	Female With Dimple & Window	TT-2969	CuSn	6000	
TT-2011	6.30 X 0.80	2.00-4.00	Female With Dimple & Window	TT-2969	CuSn	4000	
TT-1012	6.30 x 0.80	2.00-5.00	Female Plain	TT-1810K TT-1925 TT-1425	CuZn	5000	
TT-1013	6.30 x 0.80	2.00-3.00	Female With Lancing	TT-1807K	CuZn	4000	
TT-1313	6.00 x 0.80	1.0-2.50	Female plane with lancing	TT-1912	CuZn	5000	

CATEGORY NO.	TAB SIZE	CABLE SIZE MM ²	DESCRIPTION	APPLICABLE MATING TERMINAL	MATERIAL	STANDARD PACKING QTY. [NOS.]	
TT-2313	6.00 x 0.80	1.0-2.50	Female Plane With Lancing	TT-1912	CuSn	5000	
TT-1918	6.30 x 0.80	1.00-2.50	Female With Dimple And V Slot	TT-1807	CuZn	5000	
TT-1557	6.30 x 0.80	2.00-5.00	Female Plain	TT-1810K TT-1925 TT-1425	CuZn	5000	
TT-1563	6.30 x 0.80	0.50-1.25	Female With Dimple	TT-1969	CuZn	6000	
TT-1263 REMARK 0.32 Thickness	6.30 x 0.80	0.50-1.25	Female With Dimple	TT-1969	CuZn	6000	
TT-1570	6.30 x 0.80	0.50-1.50	Female With Lancing	TT-1807K	CuZn	5000	
TT-1578	6.00 x 0.80	1.00-2.50	Male Tab	TT-1579	CuZn	5000	
TT-1579	6.30 x 0.80	0.50	Female Plain	TT-1425	CuZn	6000	
TT-1602 REMARK Loose	6.30 x 0.80	NA	Male Tab For Relay Base	TT-1960	CuZn	5000	

250 Series Terminals

CATEGORY NO.	TAB SIZE	CABLE SIZE MM ²	DESCRIPTION	APPLICABLE MATING TERMINAL	MATERIAL	STANDARD PACKING QTY. [NOS.]	
TT-1604 REMARK Loose	6.30 x 0.80	NA	Male Tab For Relay Base	TT-1960	CuZn	5000	
TT-1605 REMARK Loose	6.30 x 0.80	NA	Male Tab For Relay Base	TT-1960	CuZn	5000	
TT-1606 REMARK Loose	6.30 x 0.80	NA	Male Tab For Relay Base	TT-1960	CuZn	5000	
TT-1363 REMARK Side feed	6.30 x 0.80	0.35-3.00	Low Insertion Positive Lock	TT-1969	CuZn	1000	
TT-1657	6.30 x 0.80	0.50-2.00	Low Insertion Positive Lock	TT-1969	CuZn	4000	
TT-1670	6.30 x 0.80	0.50-1.00	Female Plane With Lancing	TT-1807K	CuZn	6000	
TT-1681	6.30 x 0.80	0.75-2.00	Female With Dimple & Window Side Flag	TT-1969	CuZn	3000	
TT-1704 REMARK Side feed	6.30 x 0.80	0.50-1.00	Positive Lock Female	TT-1969	CuZn	1250	
TT-1771 REMARK Side feed	6.30 x 0.80	1.50-4.00	Positive Lock Female	TT-1969	CuZn	1000	

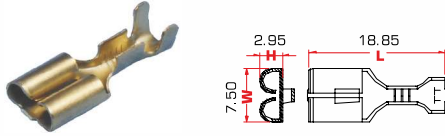
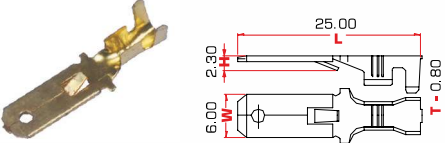
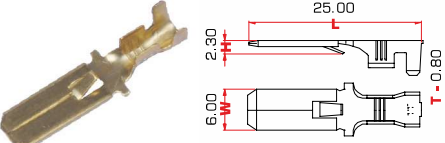
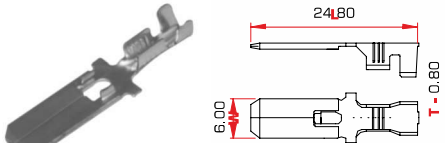
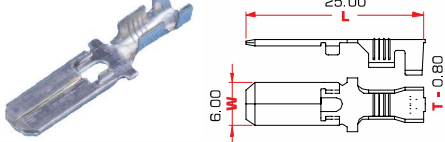
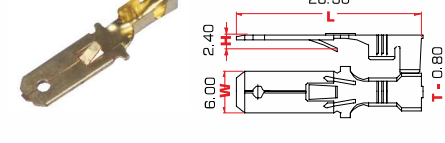
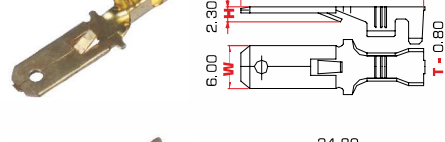
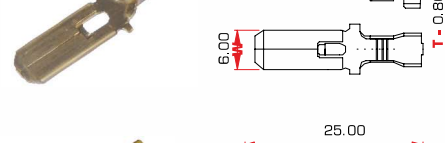
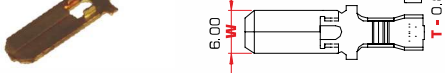
CATEGORY NO.	TAB SIZE	CABLE SIZE MM ²	DESCRIPTION	APPLICABLE MATING TERMINAL	MATERIAL	STANDARD PACKING QTY. [NOS.]	
TT-1770	6.30 x 0.80	0.50-1.00	Female With Lancing	TT-1807	CuZn	6000	
TT-1807	6.00 x 0.80	1.50-2.50	Folded Male With Lancing and Hole	TT-1970	CuZn	5000	
TT-1807K	6.00 x 0.80	1.50-2.50	Folded Male With Lancing	TT-1970	CuZn	5000	
TT-1425	6.00 x 0.80	0.30-0.50	Folded Male Tab	TT-1579	CuZn	5000	
TT-1810K	6.00 x 0.80	0.75-2.00	Folded Male Tab	TT-1967	CuZn	5000	
TT-1840	6.00 X 0.80	1.00-2.00	Folded Male With Lancing (long Length)	TT-1970	CuZn	4000	
TT-1865	6.00 X 0.80	2.00-3.00	Folded Male With Lancing	TT-1970	CuZn	4000	
TT-1866	6.00 X 0.80	2.00-4.00	Folded Male Tab	TT-1012	CuZn	4000	
TT-1925	6.00 X 0.80	0.50-1.00	Folded Male Tab	TT-1909	CuZn	6000	

250 Series Terminals

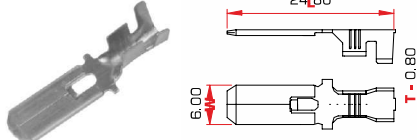
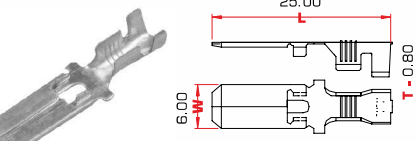
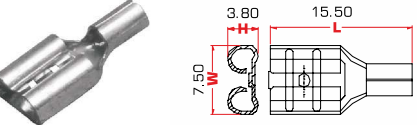
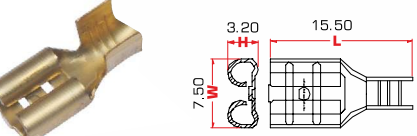
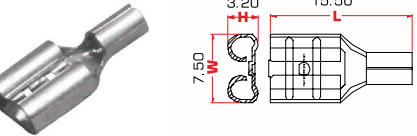
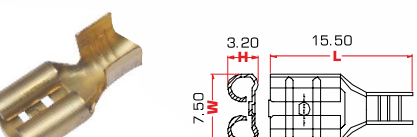
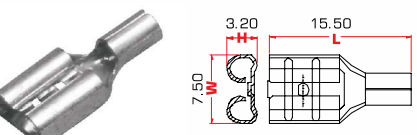
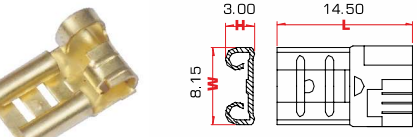
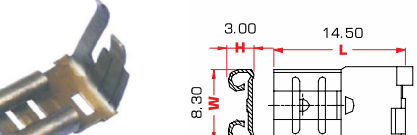
CATEGORY NO.	TAB SIZE	CABLE SIZE MM ²	DESCRIPTION	APPLICABLE MATING TERMINAL	MATERIAL	STANDARD PACKING QTY. [NOS.]	
TT-2866	6.30 X 0.80	2.00-4.00	Folded Male Tab	TT-2967	CuSn	4000	
TT-2810K	6.00 x 0.80	0.75-2.00	Folded Male Tab	TT-2967	CuSn	6000	
TT-1811	6.30 X 2.00	1.00-2.00	Female With Dimple & Window Close Barrel	TT-1969	CuZn	1250	
TT-1811 (U)	6.30 X 0.80	0.50-1.00	Female With Dimple & Window Open Barrel	TT-1969	CuZn	5000	
TT-1812	6.30 X 0.80	0.50-1.00	Female With Dimple & Window Close Barrel	TT-1969	CuZn	1250	
TT-1812 (U)	6.30 X 0.80	0.50-1.00	Female With Dimple & Window Open Barrel	TT-1969	CuZn	5000	
TT-1813	6.30 X 0.80	2.50-4.00	Female With Dimple & Window Close Barrel	TT-1969	CuZn	6000	
TT-1823	6.30 X 0.80	1.00-2.50	Female With Dimple & Window Side Flag	TT-1969 TT-1774	CuZn	4000	
REMARK Side Feed							
TT-1824	6.30 X 0.80	1.00-2.50	Female With Dimple & Window Side Flag	TT-1969 TT-1774	CuZn	5000	
REMARK Side Feed							

CATEGORY NO.	TAB SIZE	CABLE SIZE MM ²	DESCRIPTION	APPLICABLE MATING TERMINAL	MATERIAL	STANDARD PACKING QTY. [NOS.]	
TT-1881	6.30 X 0.80	0.75-2.00	Female With Dimple & Window Side Flag	TT-1969	CuZn	3000	
TT-1909	6.30 X 0.80	0.50-1.00	Female Plain	TT-1925	CuZn	6000	
TT-1911	6.30 X 0.80	0.75-2.00	Female With Dimple Side Flag	TT-1969	CuZn	3000	
TT-1211	6.30 X 0.80	0.50-2.00	Female With Dimple Side Flag	TT-1969	CuZn	3000	
TT-1311	6.30 X 0.60	0.50-1.25	Snap On Female	-	CuZn	5000	
TT-1963	6.30 X 0.80	0.50-1.25	Female With Dimple	TT-1969	CuZn	6000	
TT-1967	6.30 X 0.80	0.50-1.50	Female Plain	TT-1810K	CuZn	6000	
TT-1969	6.30 X 0.80	1.00-1.50	Plain Male Tab	TT-1960	CuZn	5000	
REMARK 0.8 Thickness							
TT-1774	6.30 X 0.80	0.50-1.00	Folded Male Terminal (short)	TT-1960	CuZn	5000	

250 Series Terminals

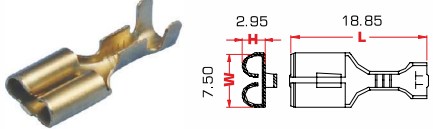
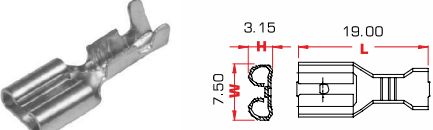
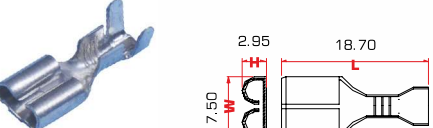
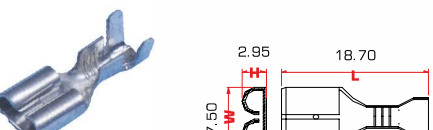
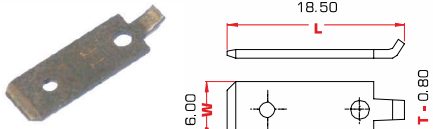
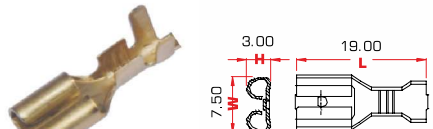
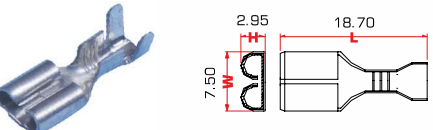
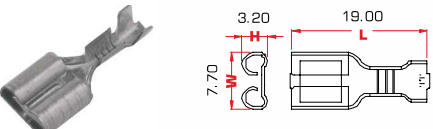
CATEGORY NO.	TAB SIZE	CABLE SIZE MM ²	DESCRIPTION	APPLICABLE MATING TERMINAL	MATERIAL	STANDARD PACKING QTY. [NOS.]	
TT-1970	6.30 X 0.80	0.50-1.50	Female With Lacing	TT-1807K	CuZn	5000	
TT-1972	6.30 X 0.80	0.75-2.00	Female With Dimple	TT-1969	CuZn	5000	
TT-1980	6.30 X 0.80	0.50-2.00	Female Plain	TT-1810K	CuZn	6000	
TT-1791	6.30 X 0.80	0.50-2.00	Female With Dimple	TT-1969	CuZn	6000	
TT-1982 REMARK Loose	6.30 X 0.80	NA	Male Plain	TT-1960	CuZn	10000	
TT-1312	6.30 X 0.80	2.00-4.00	Female With Dimple	TT-1969	CuZn	4000	
TT-2012	6.30 X 0.80	2.00-4.00	Female Plain	TT-2969	CuSn	5000	
TT-2538	6.30 X 0.80	0.50-1.50	Female With Emboss	TT-2810K	CuSn	5000	

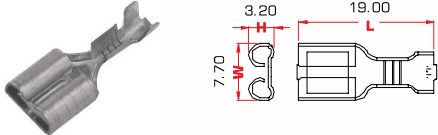
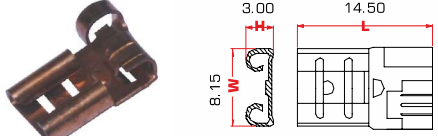
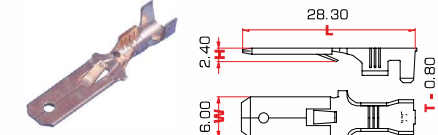
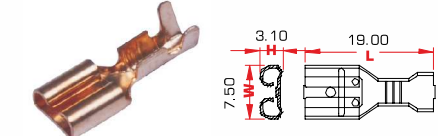
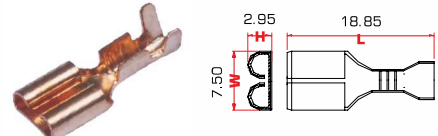
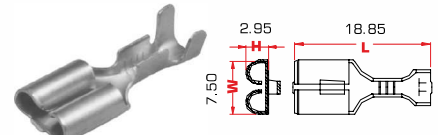
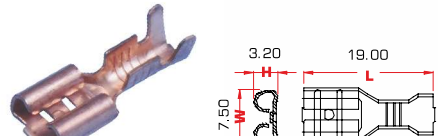
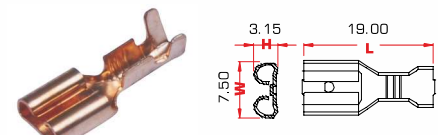
CATEGORY NO.	TAB SIZE	CABLE SIZE MM ²	DESCRIPTION	APPLICABLE MATING TERMINAL	MATERIAL	STANDARD PACKING QTY. [NOS.]	
TT-2549	6.30 X 0.80	0.50-1.00	Female With Emboss	-	CuSn	5000	
TT-2823	6.30 x 0.80	1.00-2.50	Female With Dimple & Window Side Flag	TT-2969	CuSn	3000	
REMARK Side Feed							
TT-2840	6.00 X 0.80	1.00-2.00	Folded Male With Lancing	TT-2970	CuSn	4000	
TT-2935	6.30 X 0.80	0.75-2.00	Female With Single Window & 3 Dimple	TT-2969	CuSn	5000	
TT-2967	6.30 x 0.80	0.50-1.50	Female Plain	TT-2810K	CuSn	6000	
TT-2970	6.30 x 0.80	0.50-1.50	Female With Lacing	TT-2807K	CuSn	5000	
TT-2971	6.30 x 0.80	0.75-2.00	Female With Dimple & Window	TT-2969	CuSn	5000	
TT-2972	6.30 X 0.80	0.75-2.00	Female With Dimple & Emboss	TT-2969	CuSn	5000	

250 Series Terminals

CATEGORY NO.	TAB SIZE	CABLE SIZE MM ²	DESCRIPTION	APPLICABLE MATING TERMINAL	MATERIAL	STANDARD PACKING QTY. [NOS.]	
TT-1818	6.30 X 0.60	0.50-1.50	Female With Lancing	Blade fuse	CuZn	5000	
TT-1617 REMARK Loose	6.30 X 0.80	NA	Hour Meter Terminal	TT-1960	CuZn	1250	
TT-1611	6.30 X 2.00	0.50-1.25	Female With Dimple & Window	-	CuZn	6000	

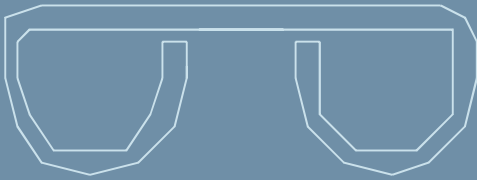
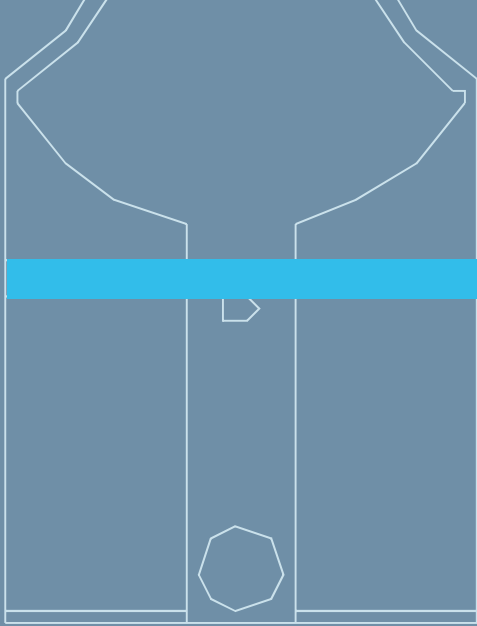

312 | 375 Series Terminals

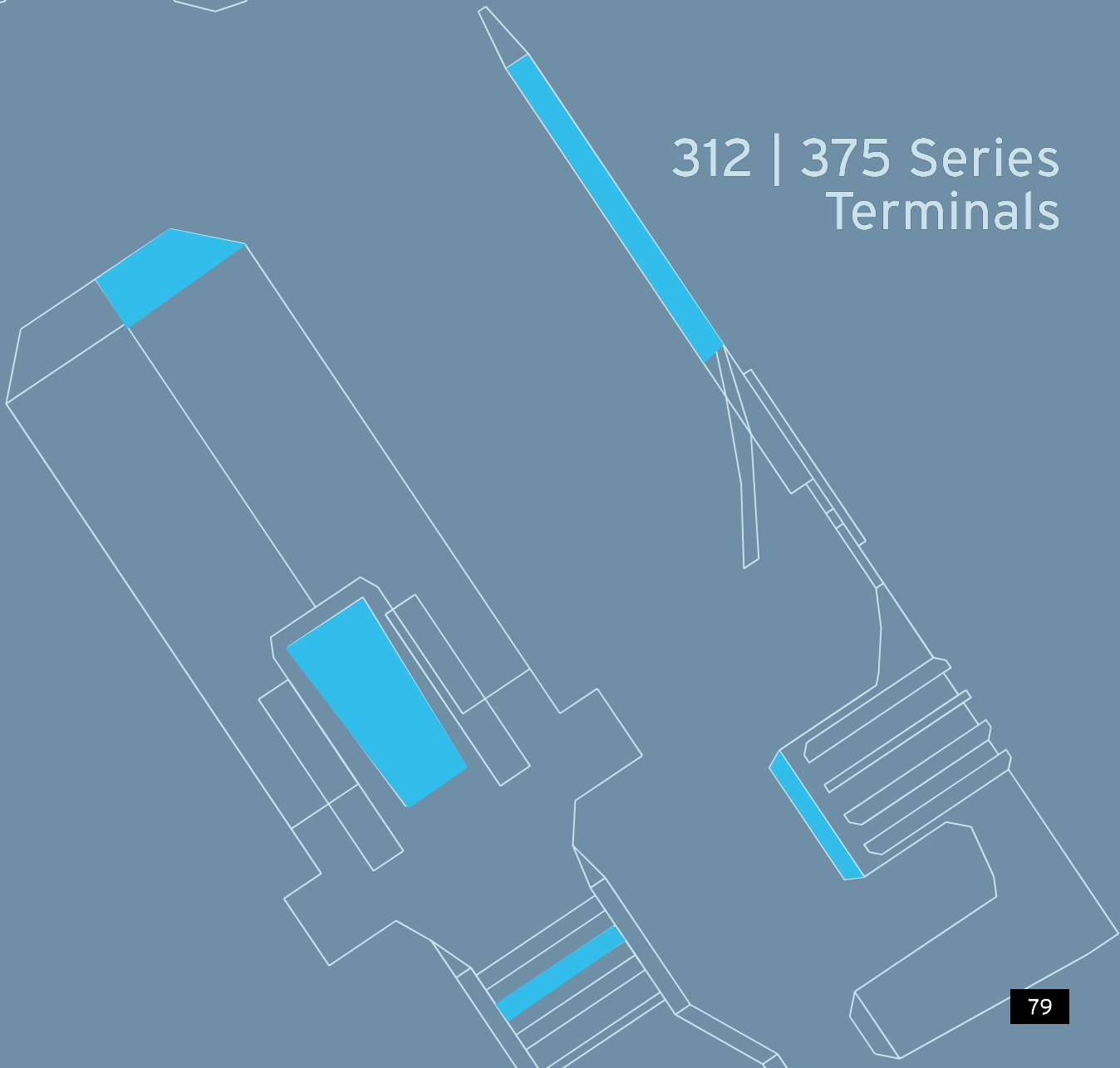

312 Series Terminals

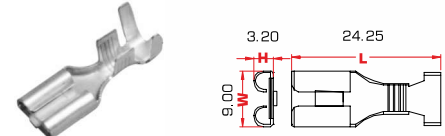
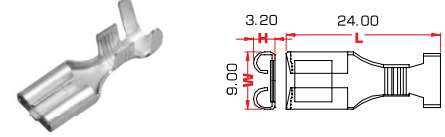
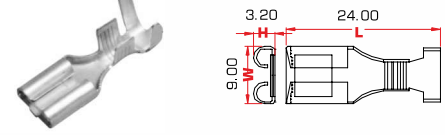
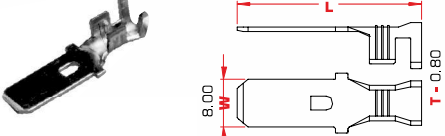
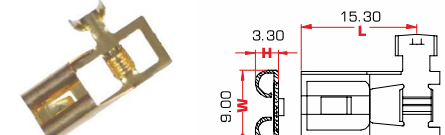
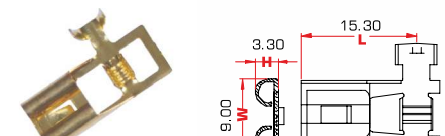
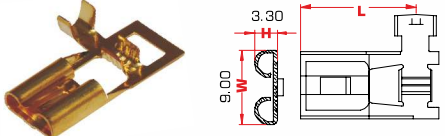
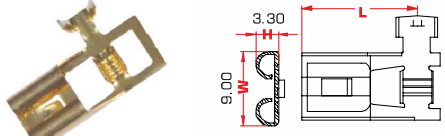
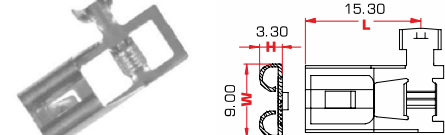
CATEGORY NO.	TAB SIZE	CABLE SIZE MM ²	DESCRIPTION	APPLICABLE MATING TERMINAL	MATERIAL	STANDARD PACKING QTY. [NOS.]	
TT-1505	8.00 X 0.80	3.00-5.00	Female With Lancing	TT-1509	CuZn	2000	
TT-1506	8.00 X 0.80	3.00-5.00	Female Plain	TT-1509	CuZn	2000	
TT-1406	8.00 X 0.80	6.00-8.00	Female With Emboss	TT-1509	CuZn	2000	
TT-1509	8.00 X 0.80	2.00-4.00	Male Tab	TT-1506	CuZn	1000	
REMARK Side Feed 0.8 Thickness							
TT-1355	7.60 X 0.80	0.75-2.50	Female With Lancing Side Flag	Head lamp	CuZn	2000	
TT-1555	7.60 X 0.80	0.75-2.50	Female With Lancing Side Flag	Head lamp	CuZn	2000	
REMARK Reverse winding							
TT-1755	7.60 X 0.80	0.50-0.75	Female With Lancing Side Flag	Head lamp	CuZn	2500	
TT-1855	7.60 X 0.80	0.75-2.50	Female With Lancing Side Flag	Head lamp	CuZn	2000	
TT-2855	7.60 x 0.80	0.75-2.50	Female With Lancing Side Flag	Head lamp	CuSn	2000	

CATEGORY NO.	TAB SIZE	CABLE SIZE MM ²	DESCRIPTION	APPLICABLE MATING TERMINAL	MATERIAL	STANDARD PACKING QTY. [NOS.]	
TT-1716	7.60 X 0.80	1.00-2.00	Folded Male Tab	TT-1727	CuZn	2000	
TT-1874	7.60 X 0.80	2.00-4.00	Folded Male Tab With Lancing	TT-1863	CuZn	2000	
TT-2874	7.60 X 0.80	2.00-4.00	Folded Male Tab With Lancing	TT-2863	CuSn	2000	
TT-1916	7.60 x 0.80	2.50-4.00	Folded Male Tab	TT-1927	CuZn	2000	
TT-2916	7.60 X 0.80	1.50-2.50	Folded Male Tab	TT-2727	CuSn	2000	
TT-1779	7.60 X 0.80	0.50-0.85	Female With Dimple	Head lamp	CuZn	2000	
TT-1863	7.60 X 0.80	2.00-4.00	Female With Lancing	TT-1874	CuZn	2000	
TT-1879	7.60 X 0.80	1.00-2.00	Female With Dimple	-	CuZn	3000	
TT-1884	7.60 x 0.80	1.00-2.50	Female With Lancing	TT-1874	CuZn	2000	

312 Series Terminals

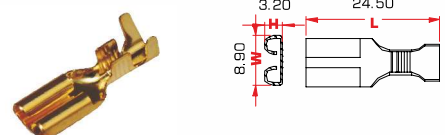
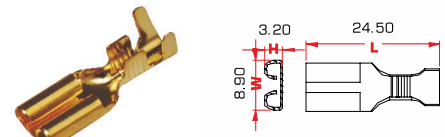
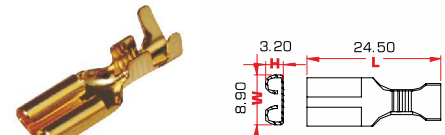
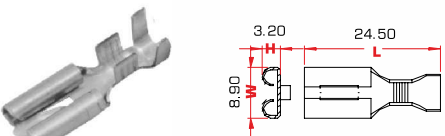
CATEGORY NO.	TAB SIZE	CABLE SIZE MM ²	DESCRIPTION	APPLICABLE MATING TERMINAL	MATERIAL		
TT-1427	7.60 X 0.80	3.00-4.00	Female Plain	TT-1716	CuZn	2000	
TT-1727	7.60 X 0.80	1.00-2.50	Female Plain	TT-1716	CuZn	2000	
TT-1927	7.60 x 0.80	3.00-4.00	Female Plain	TT-1916	CuZn	2000	
TT-2863	7.60 x 0.80	2.00-4.00	Female With Lancing	TT-2874	CuSn	2000	

375 Series Terminals

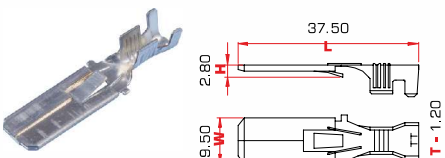
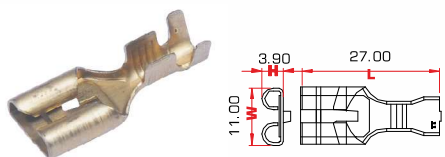
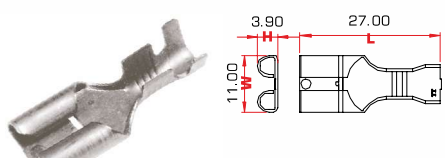
TT-1592	9.50 x 1.20	2.00-4.00	Folded Male Tab	TT-1620	CuZn	1000	
TT-1620	9.50 x 1.20	3.00-6.00	Female With Lancing	TT-1592	CuZn	2000	
TT-1621	9.50 x 1.20	3.00-6.00	Female With Dimple	-	CuZn	2000	

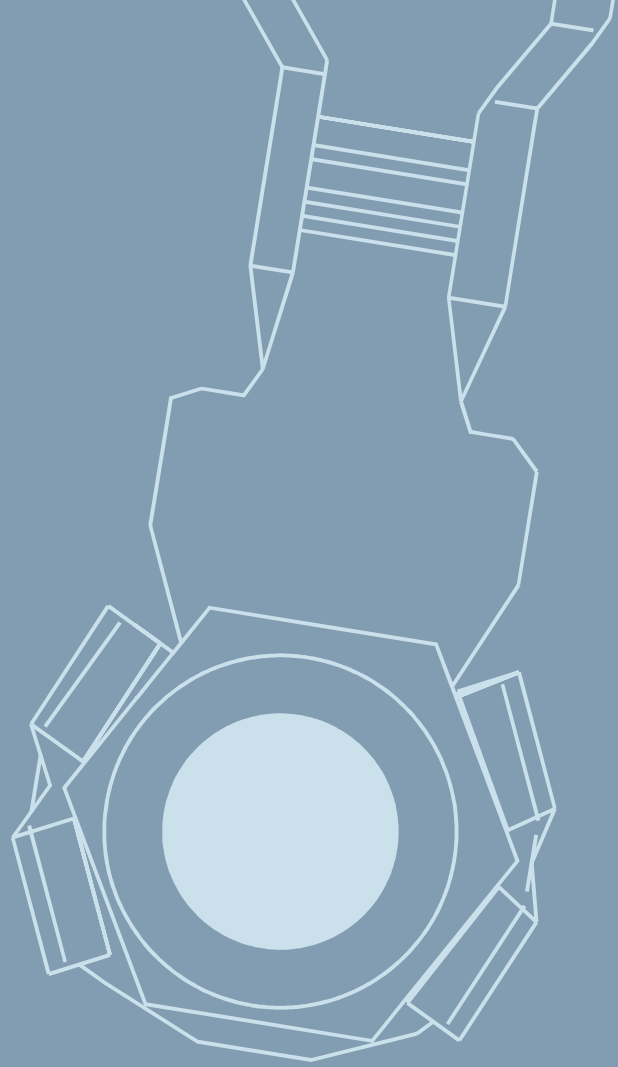
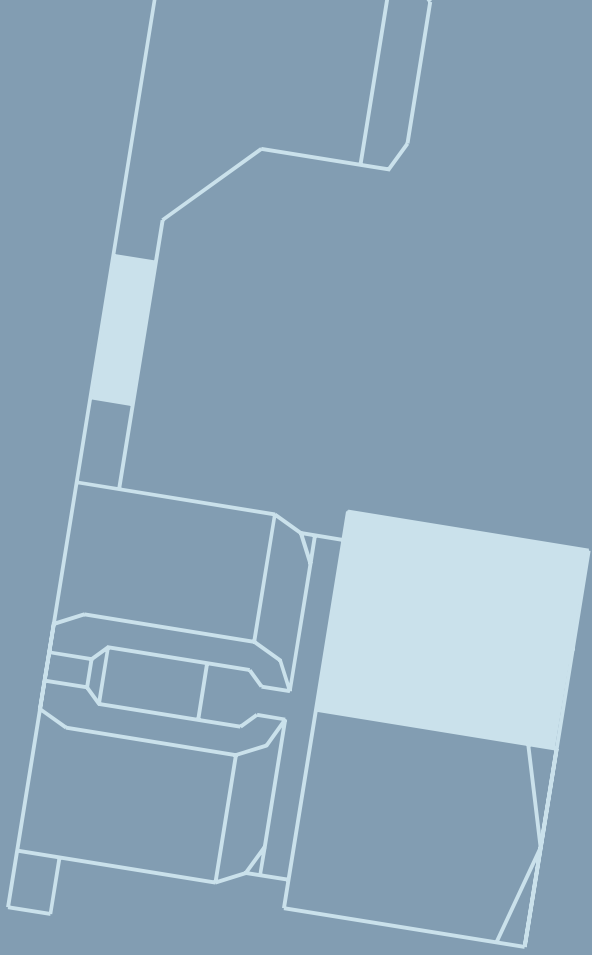

Ring | Fork | Bullet
Terminals

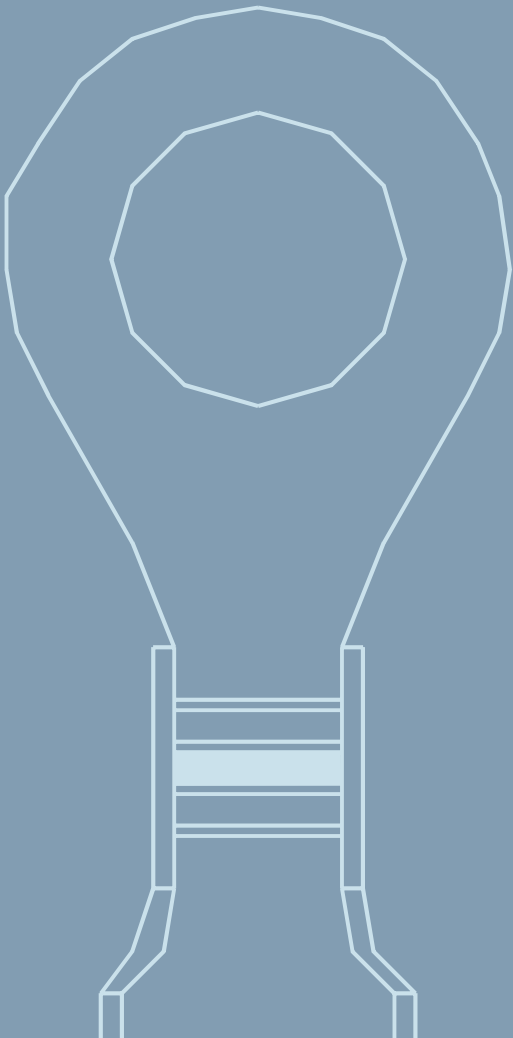

Ring Terminals

CATEGORY NO.	ID	CABLE SIZE MM ²	DESCRIPTION	APPLICABLE MATING TERMINAL	MATERIAL	STANDARD PACKING QTY. [NOS.]	
TT-1867 LA SERIES 103	3.20	0.50-1.50	Ring Terminal	NA	CuZn	8000	
TT-1946 LA SERIES 103	3.20	0.50-1.50	Ring Terminal	NA	CuZn	6000	
TT-1242 LA SERIES 103	3.50	0.20-0.50	Ring Terminal	NA	CuZn	10000	
TT-1326	4.20	0.50-1.00	Ring Terminal	NA	CuZn	10000	
TT-1841 LA SERIES 104	4.20	0.50-1.50	Ring Terminal	NA	CuZn	6000	
TT-1870 LA SERIES 104	4.20	1.50-2.50	Ring Terminal	NA	CuZn	5000	
TT-1941 LA SERIES 104	4.20	0.50-1.50	Ring Terminal	NA	CuZn	6000	

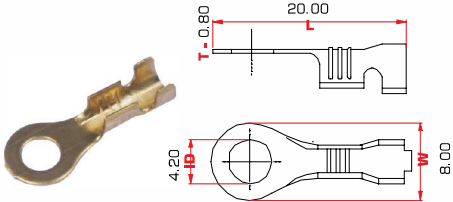
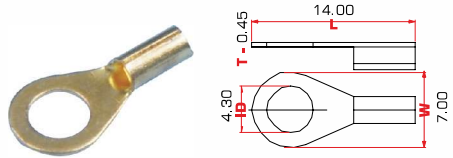
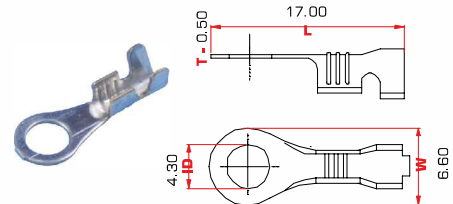
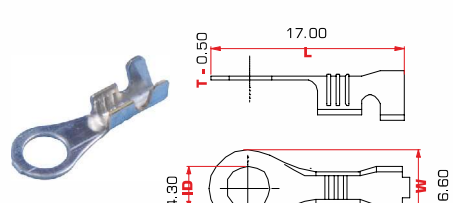
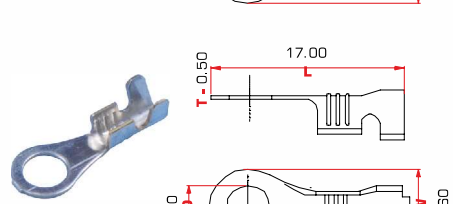
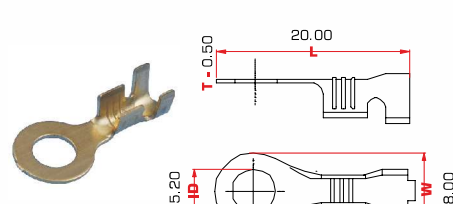
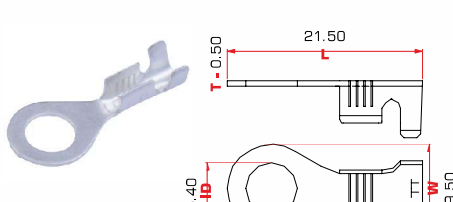
CATEGORY NO.	ID	CABLE SIZE MM ²	DESCRIPTION	APPLICABLE MATING TERMINAL	MATERIAL	STANDARD PACKING QTY. [NOS.]	
TT-1947 LA SERIES 204	4.20	1.50-2.50	Ring Terminal	NA	CuZn	4000	
TT-1994 REMARK Loose	4.30	0.50	Ring Terminal Closed Barrel	NA	CuZn	10000	
TT-1342 LA SERIES 104	4.30	0.50-1.00	Ring Terminal	NA	CuZn	8000	
TT-1442 LA SERIES 104	4.30	0.20-0.50	Ring Terminal	NA	CuZn	10000	
TT-1847 LA SERIES 104	4.30	0.50-1.50	Ring Terminal	NA	CuZn	8000	
TT-1871	5.20	0.75-2.00	Ring Terminal	NA	CuZn	6000	
TT-1822 LA SERIES 105	5.40	0.75-1.50	Ring Terminal	NA	CuZn	6000	

Ring Terminals

CATEGORY NO.	ID	CABLE SIZE MM ²	DESCRIPTION	APPLICABLE MATING TERMINAL	MATERIAL	STANDARD PACKING QTY. [NOS.]	
TT-1872 LA SERIES 105	5.40	1.50-2.50	Ring Terminal	NA	CuZn	7000	
TT-2872 LA SERIES 104	5.40	1.50-2.50	Ring Terminal	NA	CuSn	7000	
TT-1949	5.20	0.75-2.00	Ring Terminal	NA	CuZn	6000	
TT-1004	4.20	1.50	Ring Terminal	NA	CuZn	5000	
TT-1009	4.20	2.50	Ring Terminal	NA	CuZn	4000	
TT-1805 LA SERIES 205	5.40	0.50-2.00	Ring Terminal	NA	CuZn	4000	
TT-1508 LA SERIES 305	5.40	3.00-5.00	Ring Terminal	NA	CuZn	2000	

CATEGORY NO.	ID	CABLE SIZE MM ²	DESCRIPTION	APPLICABLE MATING TERMINAL	MATERIAL	STANDARD PACKING QTY. [NOS.]	
TT-1423 LA SERIES 405	5.40	8.00-15.00	Ring Terminal	NA	CuZn	1000	
TT-1746 LA SERIES 106	6.40	0.50-1.00	Ring Terminal	NA	CuZn	4000	
TT-1846 LA SERIES 106	6.40	0.75-2.00	Ring Terminal	NA	CuZn	4000	
TT-1851 LA SERIES 106	6.40	2.00-4.00	Ring Terminal	NA	CuZn	2000	
TT-1873 LA SERIES 106	6.40	1.00-2.50	Ring Terminal	NA	CuZn	4000	
TT-1945 LA SERIES 206	6.40	2.00-4.00	Ring Terminal	NA	CuZn	2000	
TT-1906 LA SERIES 306	6.40	3.00-5.00	Ring Terminal	NA	CuZn	2000	
TT-2906 LA SERIES 306	6.40	3.00-5.00	Ring Terminal	NA	CuSn	2000	

Ring Terminals

CATEGORY NO.	ID	CABLE SIZE MM ²	DESCRIPTION	APPLICABLE MATING TERMINAL	MATERIAL	STANDARD PACKING QTY. [NOS.]	
TT-1533 LA SERIES 306	6.50	5.00-8.00	Ring Terminal	NA	CuZn	1500	
TT-1533 L LA SERIES 306 REMARK Side Feed	6.50	5.00-8.00	90° Bend Ring Terminal	NA	CuZn	1500	
TT-1609	6.50	5.00-8.00	Ring Terminal	NA	CuZn	1250	
TT-1523 LA SERIES 406	6.40	5.00-8.00	Ring Terminal	NA	CuZn	1000	
TT-1849	8.20	0.75-2.00	Ring Terminal	NA	CuZn	4000	
TT-1516 LA SERIES 308	8.40	4.50-8.50	Ring Terminal	NA	CuZn	1000	
TT-1898	8.50	1.50-2.50	Ring Terminal	NA	CuZn	1500	

CATEGORY NO.	ID	CABLE SIZE MM ²	DESCRIPTION	APPLICABLE MATING TERMINAL	MATERIAL	STANDARD PACKING QTY. [NOS.]	
TT-2898	8.50	1.50-2.50	Ring Terminal	NA	CuSn	1500	
TT-1503 LA SERIES 208	8.50	2.00-4.00	Ring Terminal	NA	CuZn	1000	
TT-1907 LA SERIES 308	8.50	8.00	Ring Terminal	NA	CuZn	1000	
TT-2907 LA SERIES 308	8.50	8.00	Ring Terminal	NA	CuSn	1000	
TT-1510 LA SERIES 408	8.50	8.00-15.00	Ring Terminal	NA	CuZn	750	
TT-1410 LA SERIES 409	9.40	8.00-15.00	Ring Terminal	NA	CuZn	750	
TT-1416 LA SERIES 310	10.20	4.50-8.50	Ring Terminal	NA	CuZn	1000	

Ring Terminals

CATEGORY NO.	ID	CABLE SIZE MM ²	DESCRIPTION	APPLICABLE MATING TERMINAL	MATERIAL	STANDARD PACKING QTY. [NOS.]
TT-1566 LA SERIES 210	10.50	1.50-2.50	Ring Terminal	NA	CuZn	1500
TT-2675 REMARK Side Feed	4.20	1.00-2.50	Ring Terminal With Nut Assembly	NA	CuSn	1000
TT-1775	4.20	1.00-2.50	Terminal For Induction Cooker	NA	CuZn	4000

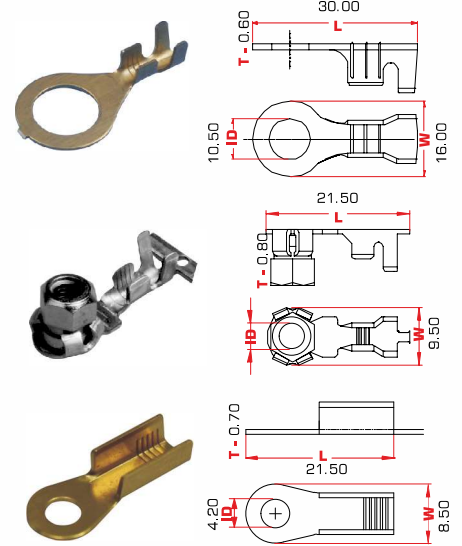

Fork Terminals

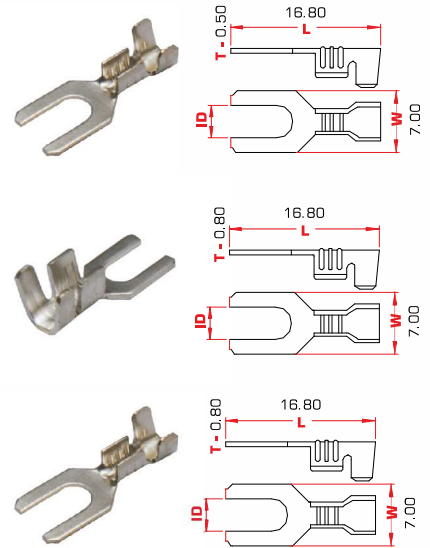

TT-1882	3.70	0.75-1.50	Fork Terminal	-	CuZn	6000
TT-1682	3.70	3.00-4.00	Fork Terminal	-	CuZn	4000
TT-1782	4.00	0.75-1.50	Fork Terminal	-	CuZn	4000

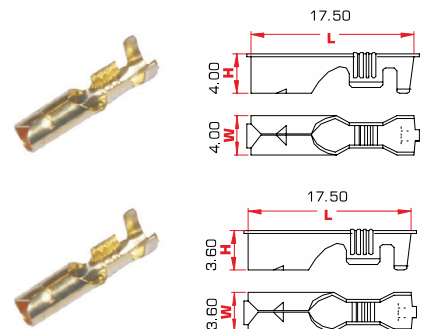

Bullet Terminals

TT-1554	3.50	0.50-1.00	Bullet Female	TT-1885	CuZn	8000
TT-1854	3.50	0.75-2.00	Bullet Female	TT-1885	CuZn	8000

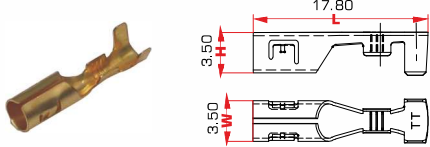
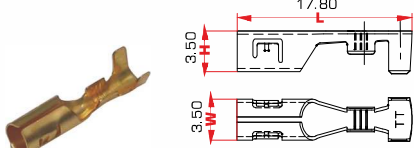
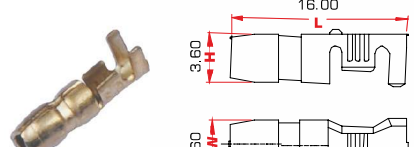
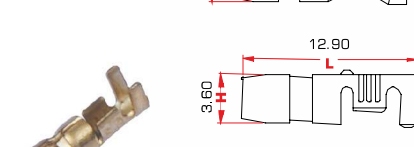
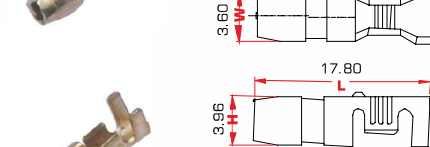

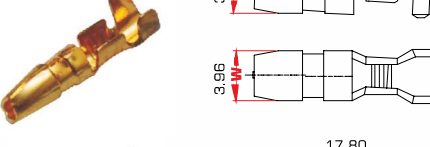
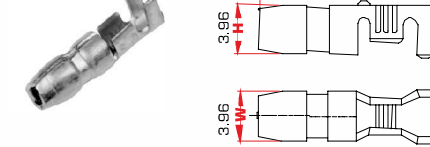
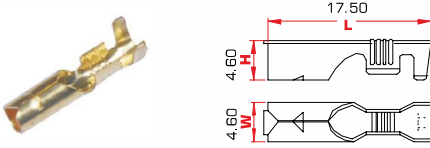
CATEGORY NO.	TAB SIZE Ø	CABLE SIZE MM ²	DESCRIPTION	APPLICABLE MATING TERMINAL	MATERIAL	STANDARD PACKING QTY. [NOS.]	
TT-1446	3.50	0.30- 0.50	Bullet Female	TT-1885	CuZn	8000	
TT-1447	3.50	0.50- 2.00	Bullet Female	TT-1885	CuZn	8000	
TT-1885	3.50	0.75- 2.50	Bullet Male	TT-1854 TT-1446 TT-1447	CuZn	8000	
TT-1567	3.50	0.50- 0.85	Bullet Male	TT-1854	CuZn	8000	
TT-1708	3.96	0.50- 1.00	Bullet Male	TT-1725	CuZn	7000	
TT-1808	3.96	0.75- 1.50	Bullet Male	TT-1825	CuZn	7000	
TT-2808	3.96	0.75- 1.50	Bullet Male	TT-1825	CuSn	7000	
TT-1725	3.96	0.50- 1.00	Bullet Female	TT-1708	CuZn	7000	
TT-1825	3.96	0.75- 2.00	Bullet Female	TT-1808	CuZn	7000	

Bullet Terminals

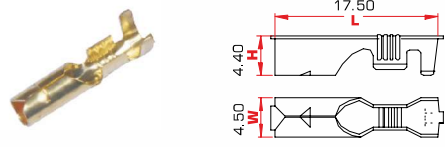
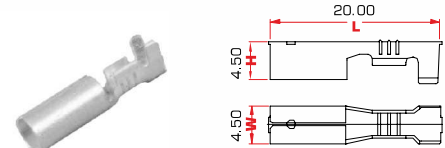
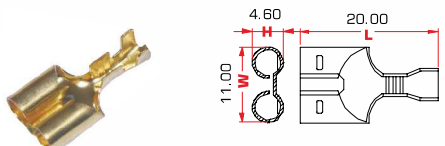
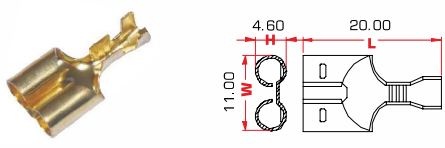
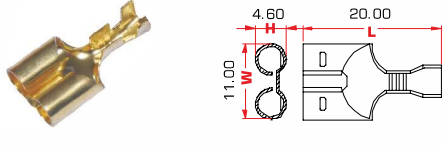
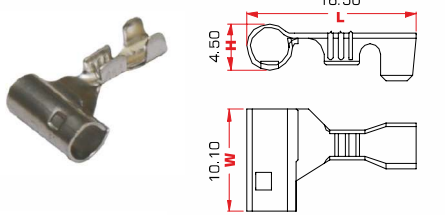
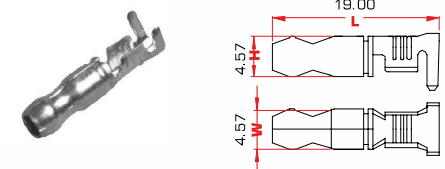
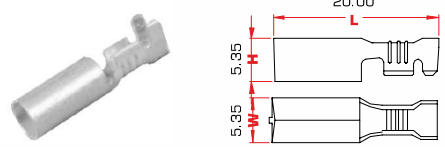
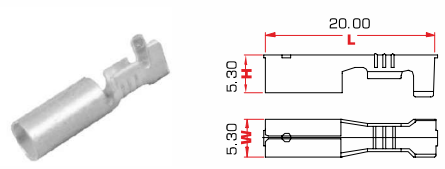
CATEGORY NO.	TAB SIZE Ø	CABLE SIZE MM ²	DESCRIPTION	APPLICABLE MATING TERMINAL	MATERIAL	STANDARD PACKING QTY. [NOS.]	
TT-1806	3.96	0.75- 2.00	Bullet Female	TT-1808	CuZn	7000	
TT-1809	3.96	1.00- 2.00	Bullet Female	TT-1808	CuZn	7000	
TT-1793	3.96	0.50- 1.00	Double Bullet Female	TT-1808	CuZn	4000	
TT-1893	3.96	0.75- 1.75	Double Bullet Female	TT-1808	CuZn	4000	
TT-1593	3.96	0.50- 0.85	Double Bullet Female	TT-1808	CuZn	4000	
TT-1917	3.96	0.50- 1.00	Bullet Female Side Flag	TT-1808	CuZn	2000	
			REMARK Side Feed				
TT-1992	4.57	1.00- 2.50	Bullet Male	TT-1993	CuZn	5000	
TT-1993	4.57	1.00- 2.50	Bullet Female	TT-1992	CuZn	5000	
TT-1493	4.57	1.00- 2.50	Bullet Female With Dimple	TT-1992	CuZn	5000	

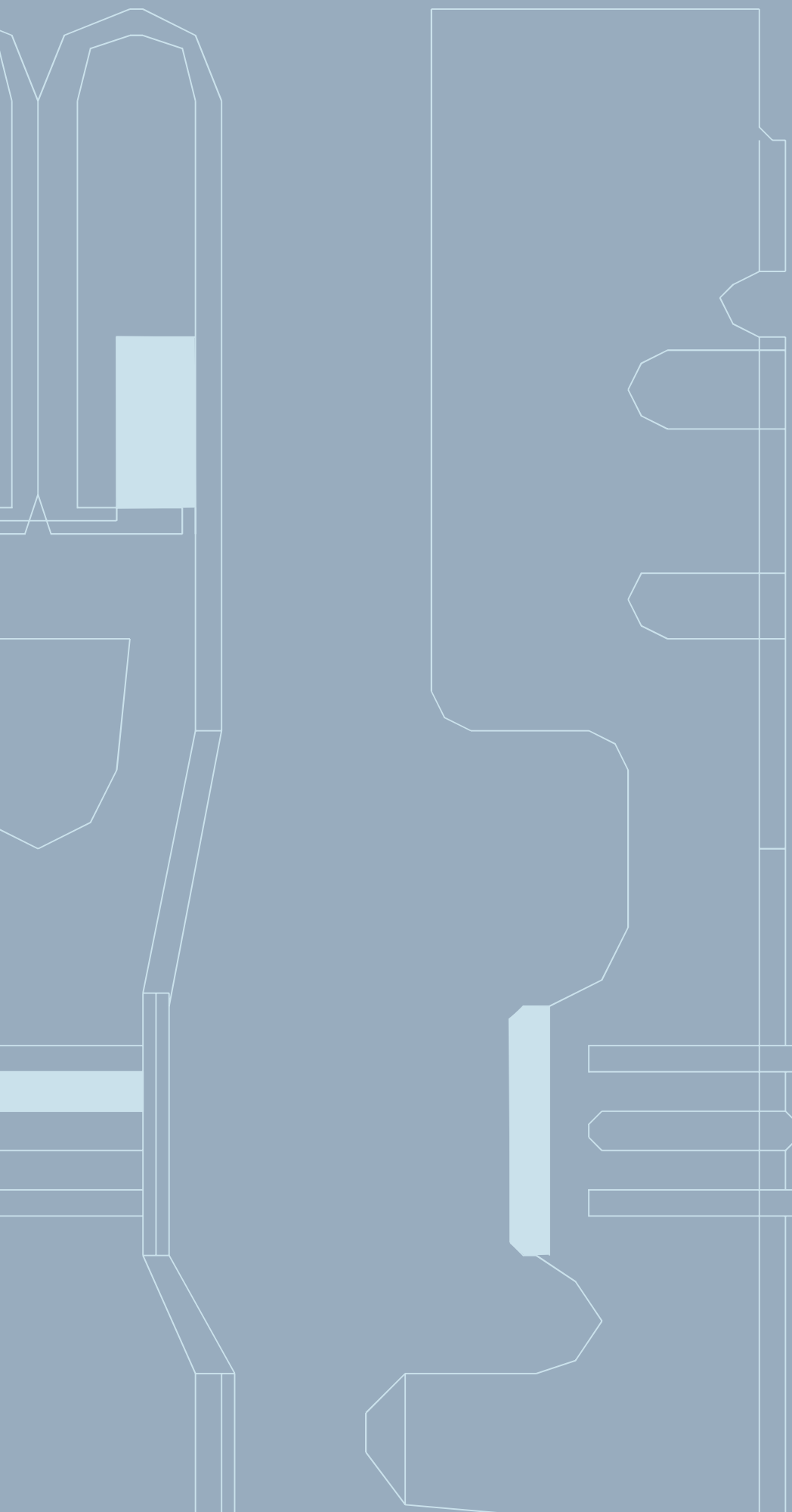

Fuse Terminals

Fuse Terminals

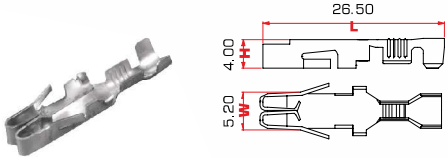
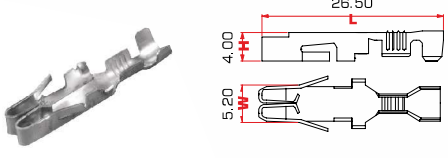
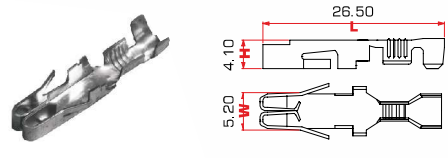
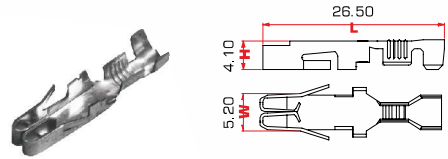
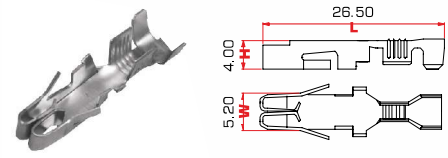
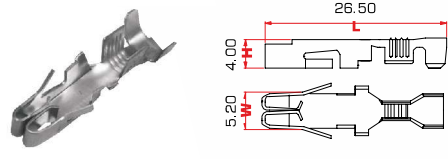
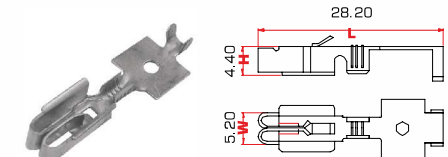
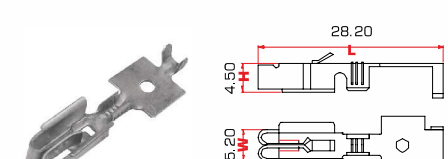
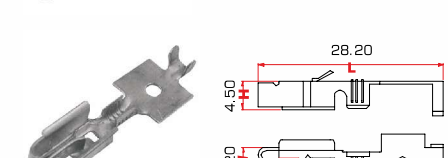
CATEGORY NO.	TAB SIZE	CABLE SIZE MM ²	DESCRIPTION	APPLICABLE MATING TERMINAL	MATERIAL	STANDARD PACKING QTY. [NOS.]	
TT-1903	NA	0.50-1.00	Fuse Terminal	Blade fuse	CuZn	2500	
TT-1903U	NA	0.50-1.00	Fuse Terminal	Blade fuse	CuZn	2500	
TT-1556	NA	1.00-2.00	Fuse Terminal	Blade fuse	CuZn	2000	
TT-1556U	NA	1.00-2.00	Fuse Terminal	Blade fuse	CuZn	2000	
TT-1603	NA	2.00-4.00	Fuse Terminal	Blade fuse	CuZn	2000	
TT-1603U	NA	2.00-4.00	Fuse Terminal	Blade fuse	CuZn	2000	
TT-1721	NA	0.50-0.85	Fuse Terminal	Blade fuse	CuZn	2000	
TT-1868S	NA	0.75-1.50	Fuse Terminal	Blade fuse	CuZn	2000	
TT-1853	NA	2.00-4.00	Fuse Terminal	Blade fuse	CuZn	2000	

REMARK
All Terminals are in Side Feed

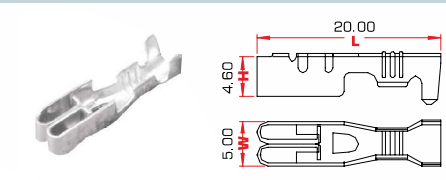
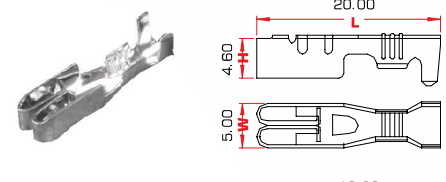
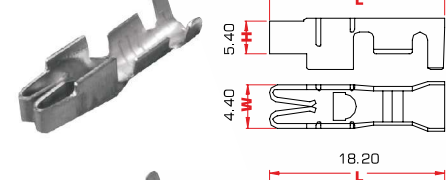
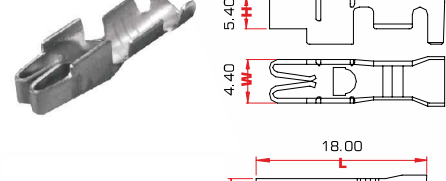
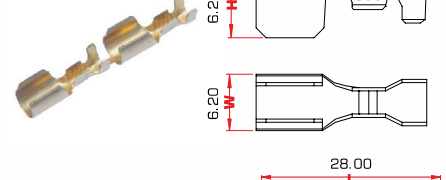
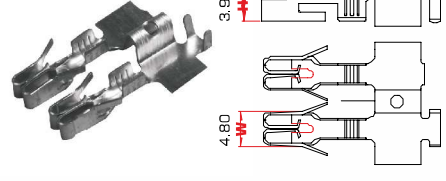
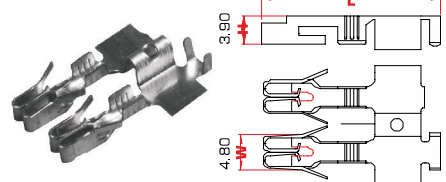
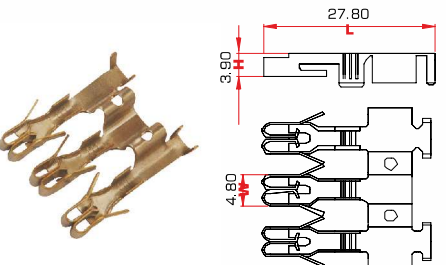
CATEGORY NO.	TAB SIZE	CABLE SIZE MM ²	DESCRIPTION	APPLICABLE MATING TERMINAL	MATERIAL	STANDARD PACKING QTY. [NOS.]	
TT-1958	NA	1.00-2.50	Mini Fuse Terminal	Mini blade fuse	CuZn	2000	
TT-2958	NA	1.00-2.50	Mini Fuse Terminal	Mini blade fuse	CuSn	2000	
TT-1638	NA	1.00-2.00	Mini Fuse Terminal	Mini blade fuse	CuZn	1500	
TT-1738	NA	2.00-5.00	Mini Fuse Terminal	Mini blade fuse	CuZn	1500	
TT-1610 REMARK End Feed	6.50	0.75-2.00	Inline Fuse Terminal	Glass fuse	CuZn	5000	
TT-1562	NA	1.00-2.50	Double Fuse Terminal	Blade fuse	CuZn	1250	
TT-1362	NA	4.00	Double Fuse Terminal	Blade fuse	CuZn	1250	
TT-1573	NA	1.00-2.50	Tripple Fuse Terminal	Blade fuse	CuZn	750	

REMARK
All Terminals are in Side Feed

CUSTOM BUILT
CONNECTOR
AND ASSEMBLIES



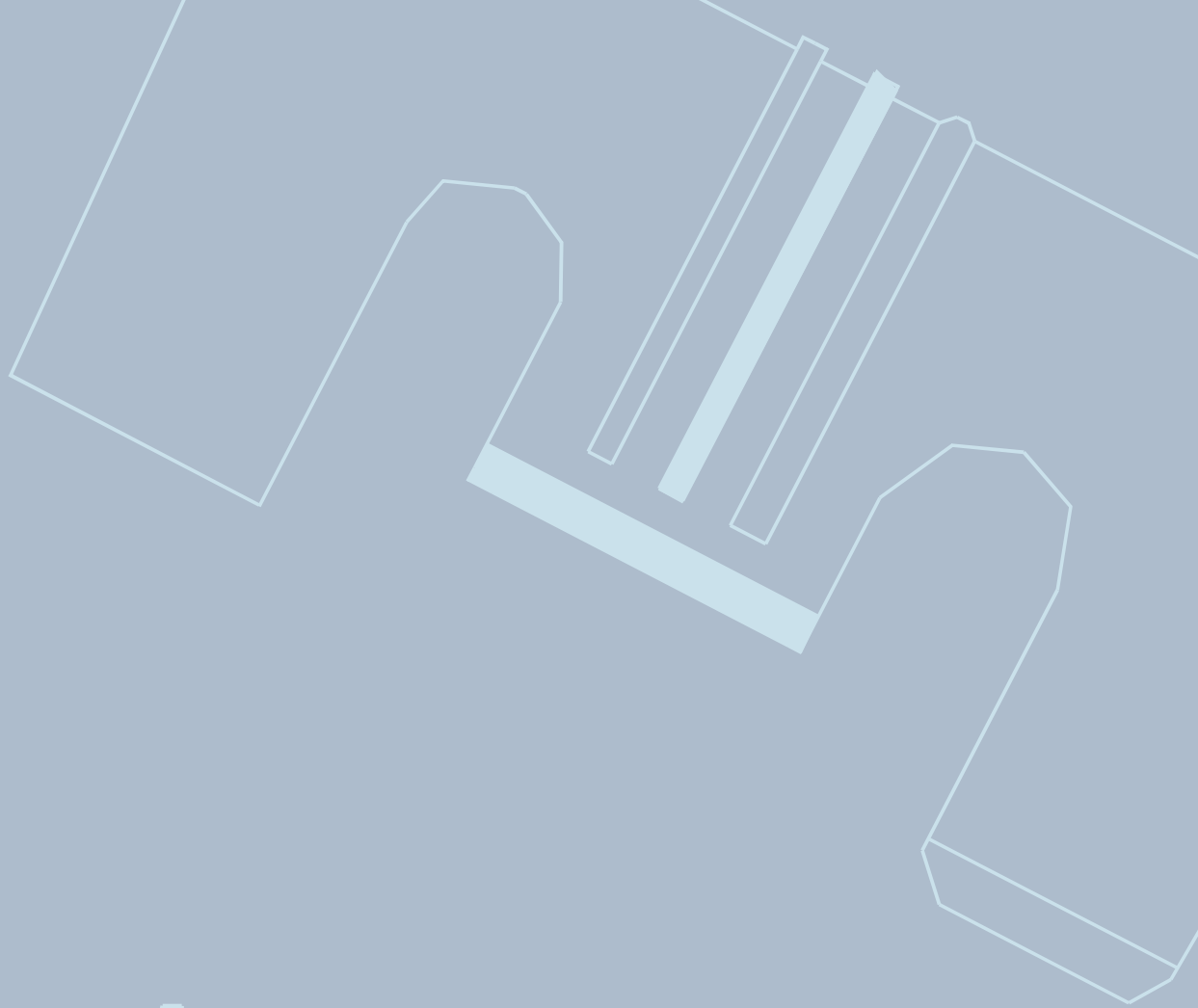

Splice & Mid Joint Terminals

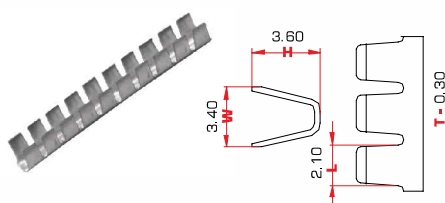
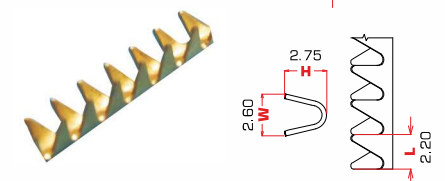
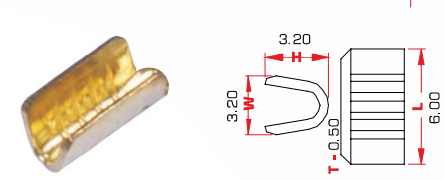
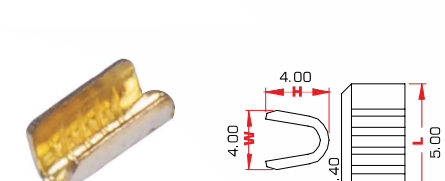
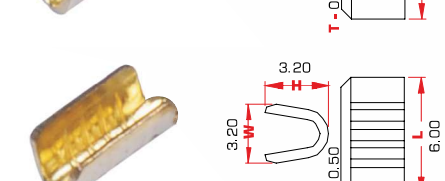
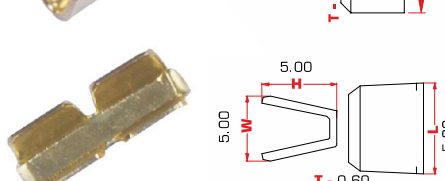
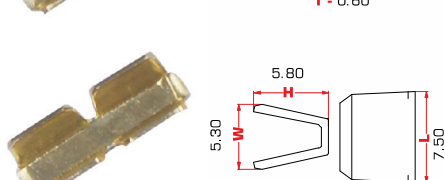
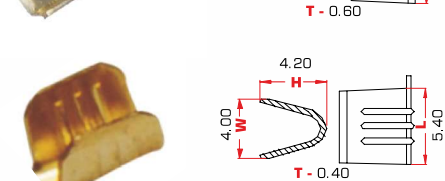
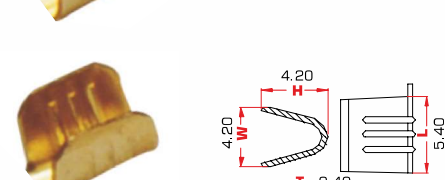

Splice & Mid Joint Terminals

CATEGORY NO.	TAB SIZE	CABLE SIZE MM ²	DESCRIPTION	APPLICABLE MATING TERMINAL	MATERIAL	STANDARD PACKING QTY. [NOS.]	
TT-1938	NA	0.50-0.75	End/splice Terminal	NA	CuZn	25000	
TT-1337	NA	0.35-1.00	Crocodile End Terminal	NA	CuZn	50000	
TT-1521 REMARK Side feed	NA	0.50-1.50	Mid Joint Terminal	NA	CuZn	10000	
TT-1520 REMARK Side feed	NA	1.50-3.10	Mid Joint Terminal	NA	CuZn	10000	
TT-1321 REMARK Side feed	NA	0.50-1.50	Mid Joint Terminal	NA	CuZn	15000	
TT-1923	NA	0.50-2.00	Mid Joint Terminal	NA	CuZn	8000	
TT-1900	NA	1.50-2.50	Mid Joint Terminal	NA	CuZn	8000	
TT-1435 REMARK Side feed	NA	1.00-3.00	Mid Joint Terminal	NA	CuZn	10000	
TT-1835 REMARK Side feed	NA	1.00-3.00	Mid Joint Terminal	NA	CuZn	10000	

Splice & Mid Joint Terminals

CATEGORY NO.	TAB SIZE	CABLE SIZE MM ²	DESCRIPTION	APPLICABLE MATING TERMINAL	MATERIAL	STANDARD PACKING QTY. [NOS.]	
TT-1476	NA	2.50-5.00	Mid Joint Terminal	NA	CuZn	5000	
REMARK Side feed							
TT-1876	NA	2.50-5.50	Mid Joint Terminal	NA	CuZn	5000	
REMARK Side feed							
TT-1522	NA	3.10-5.80	Mid Joint Terminal	NA	CuZn	5000	
REMARK Side feed							
TT-1518	NA	5.90-16.00	Mid Joint Terminal	NA	CuZn	2000	
REMARK Side feed							
TT-1519	NA	16.00-25.00	Mid Joint Terminal	NA	CuZn	1000	
REMARK Side feed							
TT-1833	NA	1.00-2.00	Mid Joint Terminal	NA	CuZn	5000	
REMARK Side feed							
TT-1834	NA	1.00-3.00	Mid Joint Terminal	NA	CuZn	3000	
REMARK Side feed							
TT-1448	NA	0.75-2.00	Mid Joint Terminal	NA	CuZn	3000	
REMARK Side feed							

PIERCING SPLICE TERMINALS

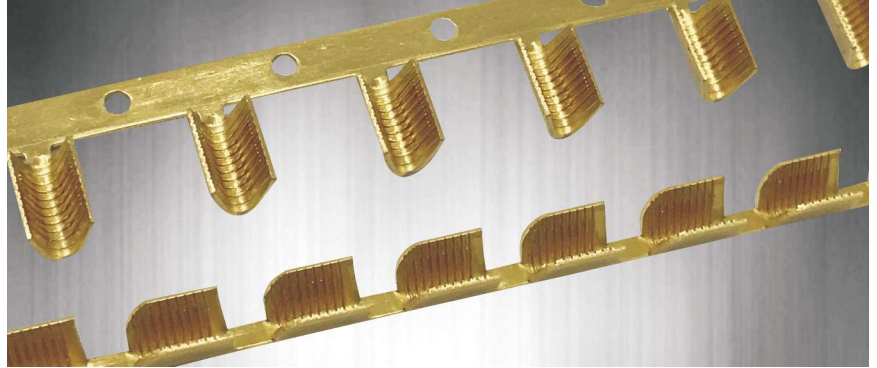

Splice terminals are specifically designed to terminate the magnet wire to itself or in combination with standard solid or stranded lead wire.

Splices have sharp edged serrations inside the crimp barrel. these serrations made by a special process, pierce the insulating layer of magnet wires in a manner that provides a large contact area.

In addition, copper or aluminum magnet wire, or a combination of both, can be terminated. When required, copper or aluminum magnet wire can be combined with standard, pre-stripped solid or stranded lead wires.

This is available in 5, 7 & 9 serration versions for termination in the 600 ~ 3000 CMA.



APPLICATIONS

- Motor windings & terminations
- Coil connections
- Transformer windings & terminations
- Solid wire connections

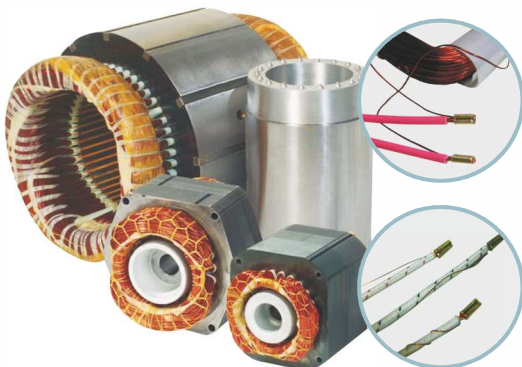
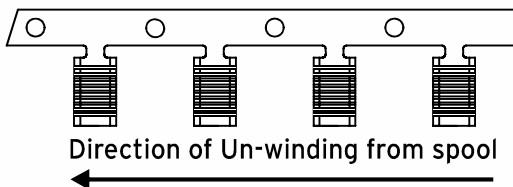

PRODUCT FEATURES

- In a single crimping operation, enameled winding wire's insulation layer is pierced due to the sharp serrations of the terminal and hence achieving electrical & mechanical contact with the lead wire.
- Terminating up to 2 magnet wires together with a stranded lead in one barrel.
- No need to remove/scratch the enameled insulation from the magnet wire for this termination.
- High termination rates, low wire consumption and the elimination of rejects caused by the solder flux or heat damage results in the lowest applied costs
- Strip formed splices terminated in automatic crimping machines for high production rates with higher consistency
- Excellent tensile strength - Vibration resistant
- Available in side feed and back feed chain form

PART NO.	NO. OF SERRATIONS	FINISH	RAW MATERIAL	CHAIN FORM
TT-1734	5	Natural	Cu Zn 37	Side Feed
TT-1221	7	Natural	Cu Zn 30	Side Feed
TT-1421	7	Natural	Cu Zn 37	Side Feed
TT-1728	9	Natural	Cu Zn 37	Side Feed
TT-1728 (MTC)	9	Mat Tin	Cu Zn 37	Side Feed
TT-1768	9	Natural	Cu Zn 37	Back Feed
TT-1768 (MTC)	9	Mat Tin	Cu Zn 37	Back Feed



Copper Ring, Fork & Pin Terminals

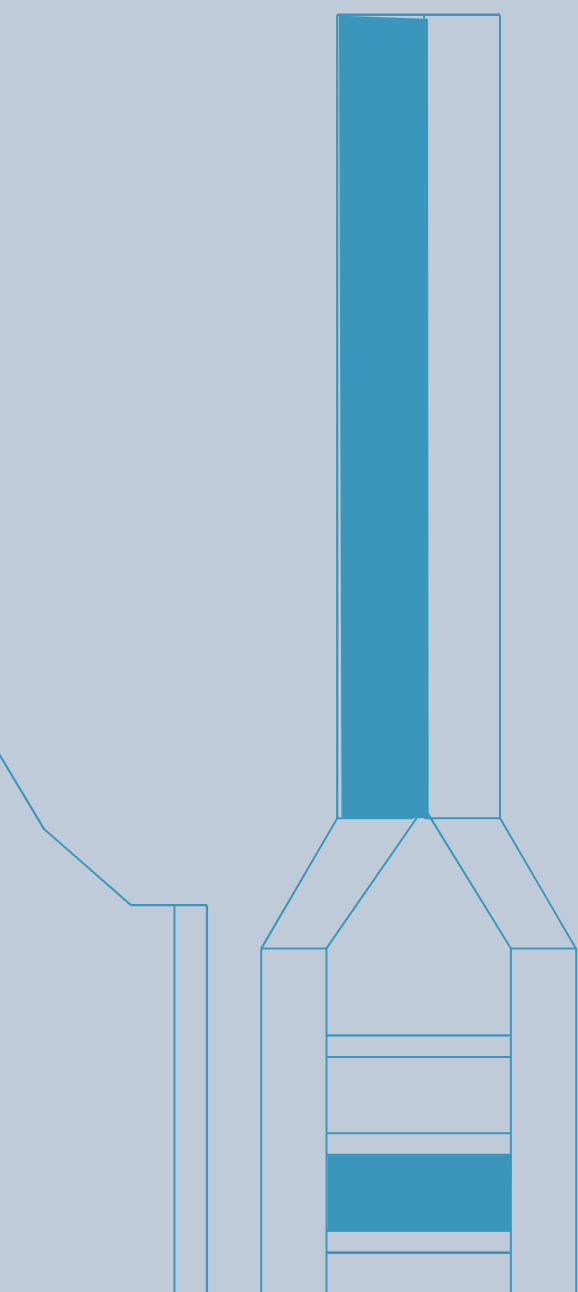

Copper Ring Terminals

CATEGORY NO.	ID	CABLE SIZE MM ²	DESCRIPTION	APPLICABLE MATING TERMINAL	MATERIAL	STANDARD PACKING QTY. [NOS.]	
TT-5104U	3.2	1.5	Copper Ring Terminal Open Barrel	NA	Copper	5000	
TT-5003U	4.2	1.5	Copper Ring Terminal Open Barrel	NA	Copper	5000	
TT-5004U	4.2	1.5	Copper Ring Terminal Open Barrel	NA	Copper	5000	
TT-5005U	5.2	1.5	Copper Ring Terminal Open Barrel	NA	Copper	5000	
TT-5108U	3.7	2.5	Copper Ring Terminal Open Barrel	NA	Copper	5000	
TT-5009U	4.2	2.5	Copper Ring Terminal Open Barrel	NA	Copper	5000	
TT-5010U	5.2	2.5	Copper Ring Terminal Open Barrel	NA	Copper	5000	
TT-5109U	5.2	2.5	Copper Ring Terminal Open Barrel	NA	Copper	4000	

Copper Ring | Fork | Pin Terminals

CATEGORY NO.	ID	CABLE SIZE MM ²	DESCRIPTION	APPLICABLE MATING TERMINAL	MATERIAL	STANDARD PACKING QTY. [NOS.]	
TT-5007U	6.4	1.5	Copper Ring Terminal Open Barrel	NA	Copper	4000	
TT-5011U	6.4	2.5	Copper Ring Terminal Open Barrel	NA	Copper	4000	
TT-5113U	5.2	4-6	Copper Ring Terminal Open Barrel	NA	Copper	2000	
TT-5017U	6.4	4-6	Copper Ring Terminal Open Barrel	NA	Copper	2000	
TT-5018U	8.2	4-6	Copper Ring Terminal Open Barrel	NA	Copper	2000	
TT-5155U	4.2	4-6	Copper Ring Terminal Open Barrel	NA	Copper	4000	
TT-5050U	5.2	4-6	Copper Ring Terminal Open Barrel	NA	Copper	4000	
TT-5120U	6.4	10	Copper Ring Terminal Open Barrel	NA	Copper	2000	

Copper Ring Terminals

CATEGORY NO.	ID	CABLE SIZE MM ²	DESCRIPTION	APPLICABLE MATING TERMINAL	MATERIAL	STANDARD PACKING QTY. [NOS.]	
TT-5125	5.2	16	Copper Ring Terminal Close Barrel	NA	Copper	250	
TT-5029	6.4	16	Copper Ring Terminal Close Barrel	NA	Copper	250	
TT-5915	6.4	25	Copper Ring Terminal Close Barrel	NA	Copper	500	
TT-5913	8.4	25	Copper Ring Terminal Close Barrel	NA	Copper	200	
TT-5914	10.5	25	Copper Ring Terminal Close Barrel	NA	Copper	200	

Copper Fork Terminals

TT-5549U	3.5	1.5	Copper Fork Terminal Open Barrel	NA	Copper	5000	
----------	-----	-----	----------------------------------	----	--------	------	--

Copper Fork Terminals

CATEGORY NO.	ID	CABLE SIZE MM ²	DESCRIPTION	APPLICABLE MATING TERMINAL	MATERIAL	STANDARD PACKING QTY. [NOS.]
TT-5251U	3.5	2.5	Copper Fork Terminal Open Barrel	NA	Copper	5000
TT-5152U	5.2	1.5	Copper Fork Terminal Open Barrel	NA	Copper	5000

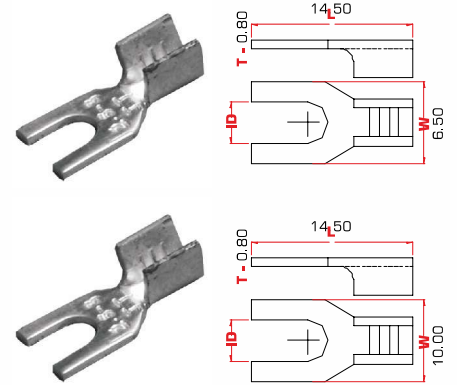

Copper Pin Terminals

TT-9U	1.9	1.5	Copper Pin Terminal Open Barrel	NA	Copper	4000
TT-1U	1.9	2.5	Copper Pin Terminal Open Barrel	NA	Copper	2000
TT-3U	2.7	4	Copper Pin Terminal Open Barrel	NA	Copper	1500

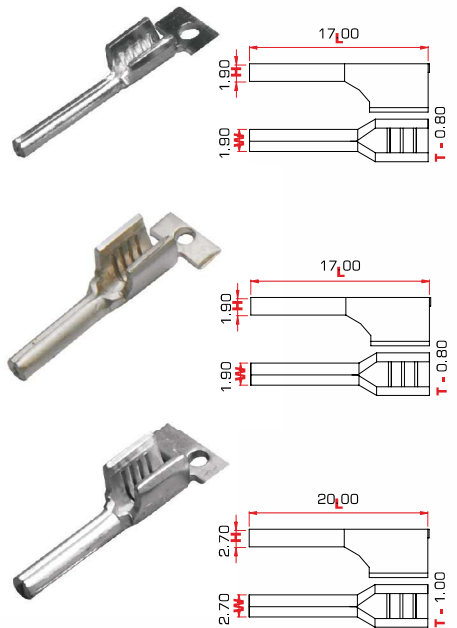

MODULAR FUSE AND RELAY ASSEMBLIES

Looking at the additional requirements of automobile electrical circuits, TT has been designing completely new assembly solutions to accommodate the additional need for relays, fuses and diode assemblies. A variety of combinations are designed for customers to choose from, which can meet their needs arising out of the additional circuit requirements to improve automobile electronics. The modular are designed with secondary locks for highest reliability and stackable for infinite possibilities.

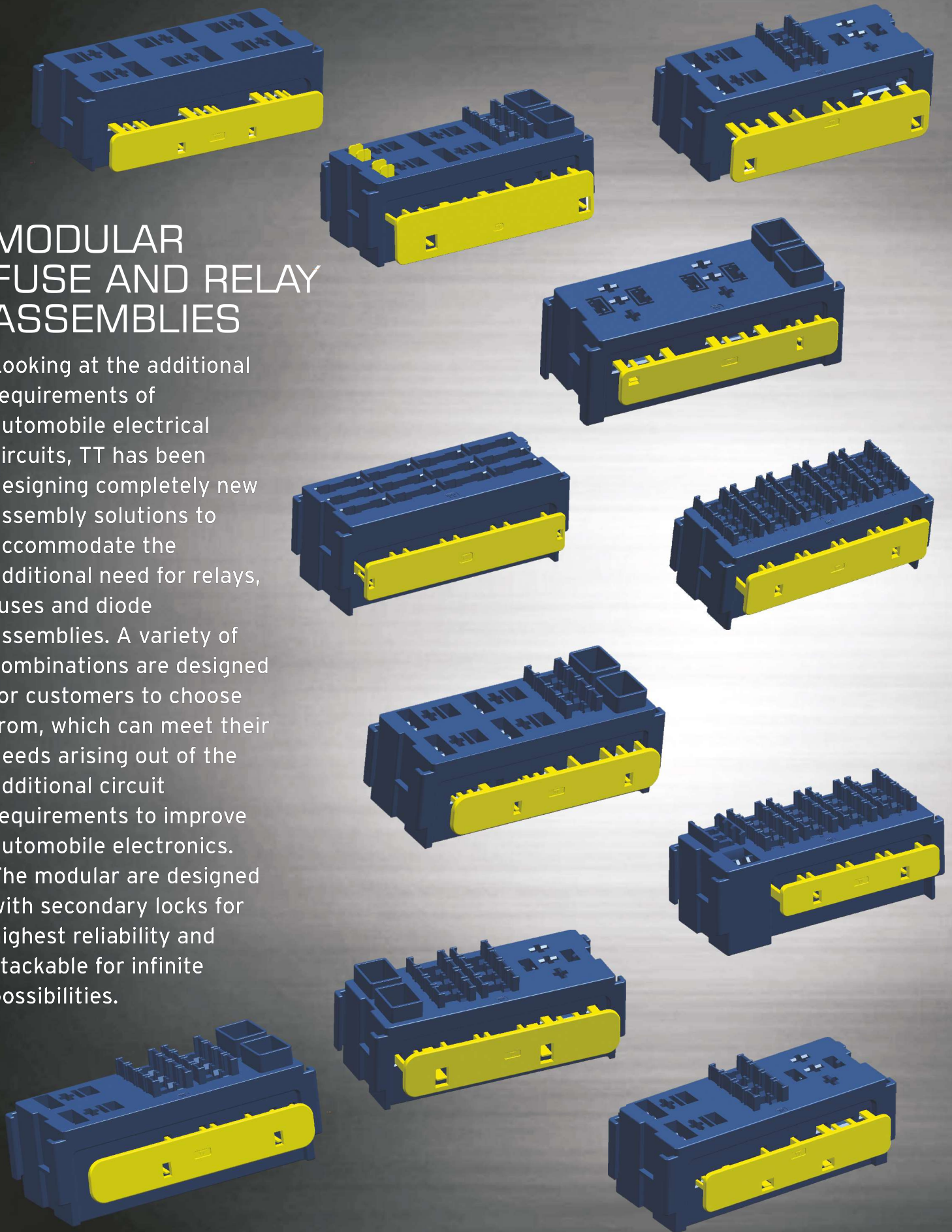

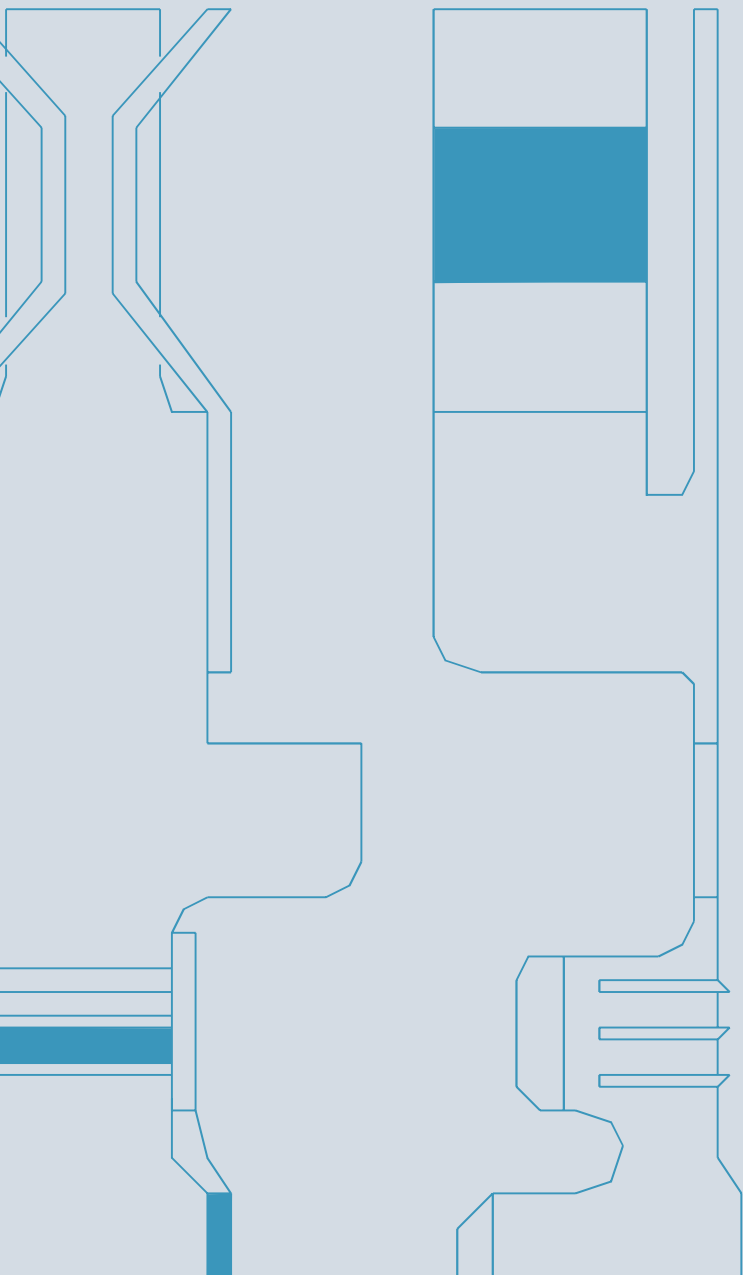
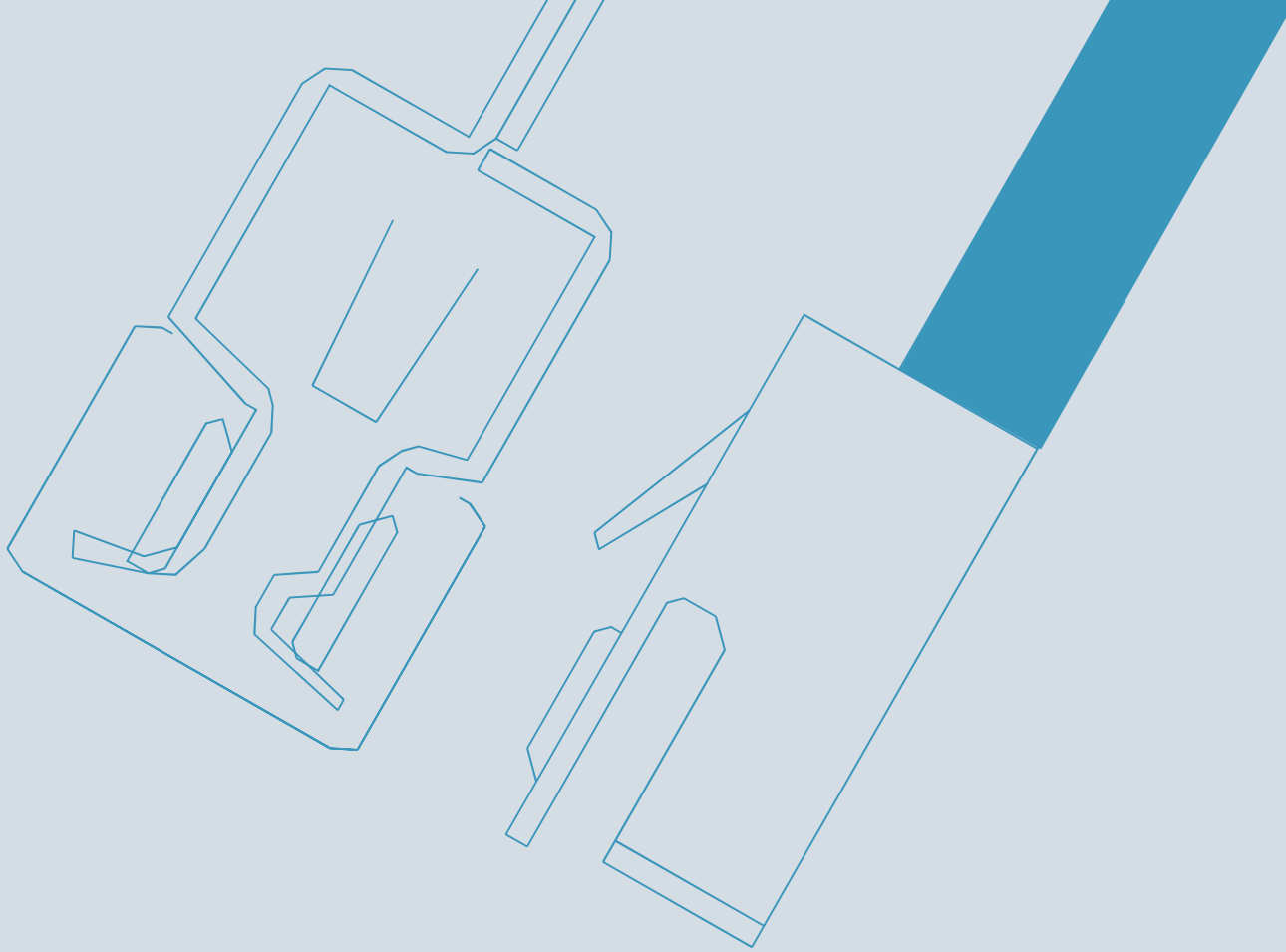

Bulb Holder Terminals

Bulb Holder Terminals

CATEGORY NO.	TAB SIZE	CABLE SIZE MM ²	DESCRIPTION	APPLICABLE MATING TERMINAL	MATERIAL	STANDARD PACKING QTY. [NOS.]	
TT-1501	NA	1.00	Bulb Holder Terminal	NA	CuZn	10000	
TT-2352 REMARK Side Feed	NA	0.50-1.00	Bulb Holder Terminal	NA	CuSn	3000	
TT-1852 REMARK Side Feed	NA	NA	Bulb Holder Terminal	NA	CuZn	3500	
TT-2625 REMARK Loose	NA	NA	Bulb Holder Terminal	NA	CuSn	5000	
TT-2826 REMARK Loose	NA	NA	Bulb Holder Terminal	NA	CuSn	1250	
TT-2827 REMARK Loose	NA	NA	Bulb Holder Terminal	NA	CuSn	1250	
TT-2839 REMARK Side Feed	NA	0.50-1.50	Bulb Holder Terminal	NA	CuSn	3000	
TT-2852 REMARK Side Feed	NA	0.50-1.00	Bulb Holder Terminal	NA	CuSn	3500	

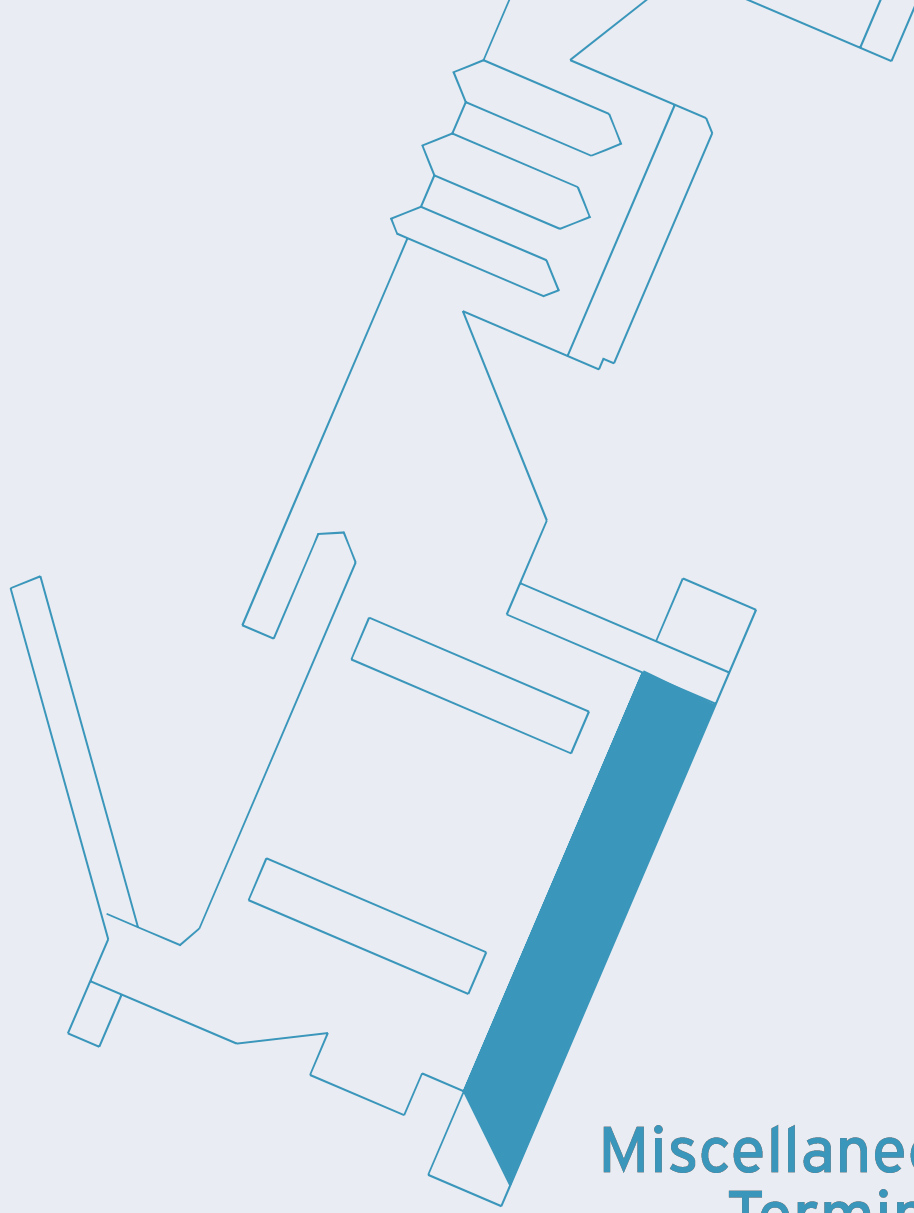

Miscellaneous Terminals

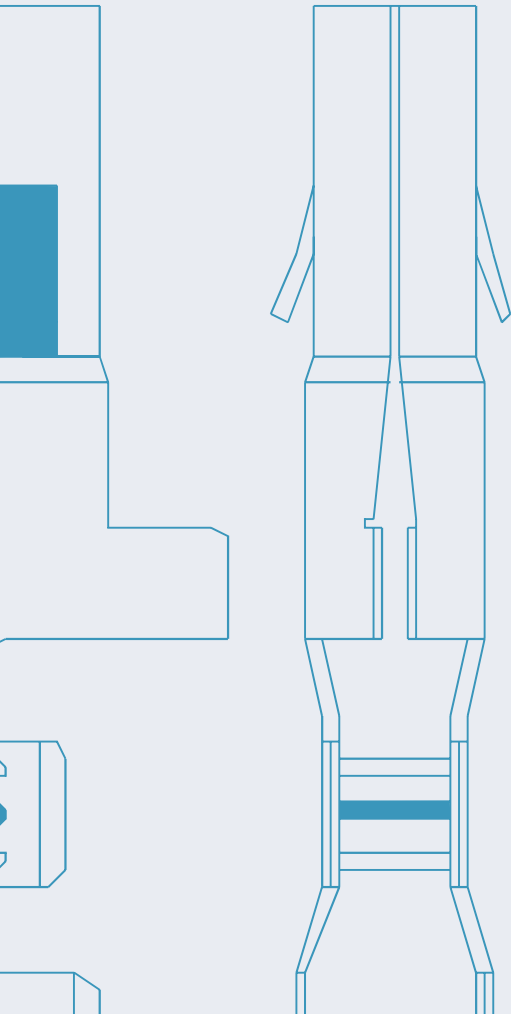

Miscellaneous Terminals

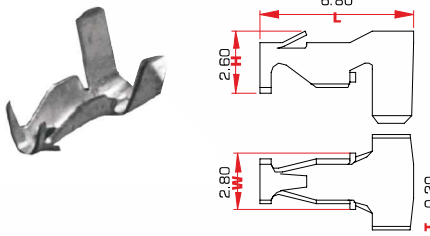
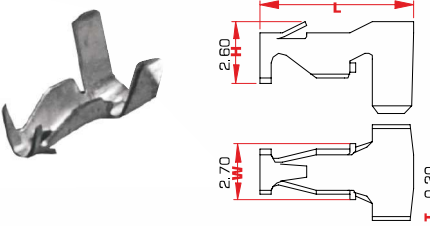
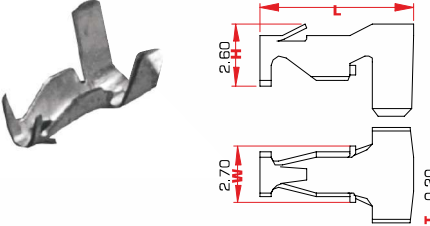
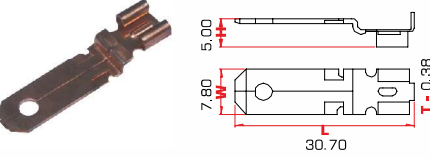
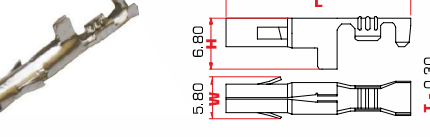
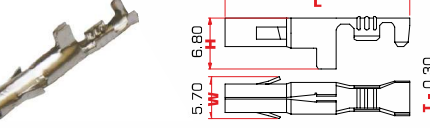
CATEGORY NO.	TAB SIZE	CABLE SIZE MM ²	DESCRIPTION	APPLICABLE MATING TERMINAL	MATERIAL	STANDARD PACKING QTY. [NOS.]	
TT-1322	NA	0.30-0.80	Pc Board Crimp Terminal	NA	CuZn	4000	
TT-1317	NA	0.30-0.80	Pc Board Crimp Terminal	NA	CuZn	5000	
TT-1622	NA	0.30-0.80	Pc Board Crimp Terminal	NA	CuZn	4000	
TT-2614	7.80 x 0.80	NA	Contact Adaptor H7	NA	CuSn	5000	
REMARK Loose							
TT-1902	3.00	0.5	Pin Connector Female	NA	CuZn	1250	
TT-1939	3.00	0.75-1.50	Pin Connector Male	NA	CuZn	1250	

Compressor Terminals

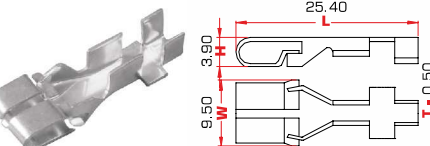
TT-2732	3.00	0.50-0.75	Compressor Terminal	-	CuSn	1250	
REMARK All Terminals are in Side Feed							

Compressor Terminals

CATEGORY NO.	TAB SIZE	CABLE SIZE MM ²	DESCRIPTION	APPLICABLE MATING TERMINAL	MATERIAL	STANDARD PACKING QTY. [NOS.]	
TT-2932	3.00	2.00-3.00	Compressor Terminal	-	CuSn	1250	
TT-2843	2.70	1.00-2.00	Compressor Terminal	-	CuSn	5000	
TT-2910	3.00	105/4 DG-DD MMDD	Body Terminal	-	CuSn	8000	
TT-2959	2.20	0.50-0.75	Compressor Terminal	-	CuSn	8000	
TT-2860	2.20	0.50-0.75	Compressor Terminal	-	CuSn	8000	

Computer Cord Terminals

TT-1901	NA	0.50-1.00	Cord Terminal	NA	CuZn	3000	
TT-1745	NA	0.50-1.00	Cord Terminal	NA	CuSn	3000	

REMARK
All Terminals are in Side Feed

Sensor & Super Seal Terminals

CATEGORY NO.	TAB SIZE	CABLE SIZE MM ²	DESCRIPTION	APPLICABLE MATING TERMINAL	MATERIAL	STANDARD PACKING QTY. [NOS.]	
TT-2560 REMARK Sealed	-	0.50-1.00	Sensor/Relay Terminal	NA	CuSn+Fe	2500	
TT-2689	-	0.50-1.00	Sensor/Relay Terminal (short)	NA	CuSn+Fe	2500	
TT-2324	-	0.50-1.00	Sensor/Relay Terminal	NA	CuSn+Fe	1500	
TT-2681	1.50 X 0.80	0.75-1.50	Superseal Female Terminal	TT-2737	CuSn	4000	
TT-2737	1.50 X 0.80	0.75-1.50	Superseal Male Terminal	TT-2681	CuSn	4000	
TT-1365	1.50 X 0.80	1.50-2.50	Superseal Male Terminal	TT-2681	CuSn	4000	

REMARK
All Terminals are in Side Feed

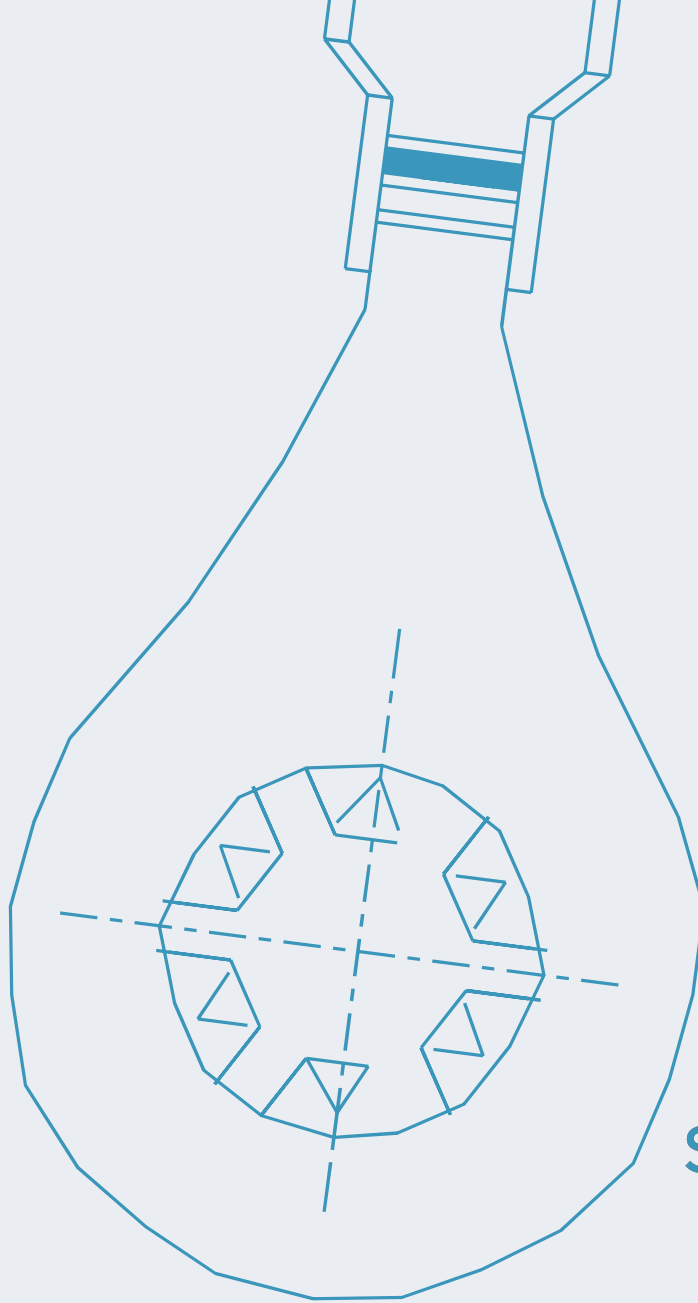
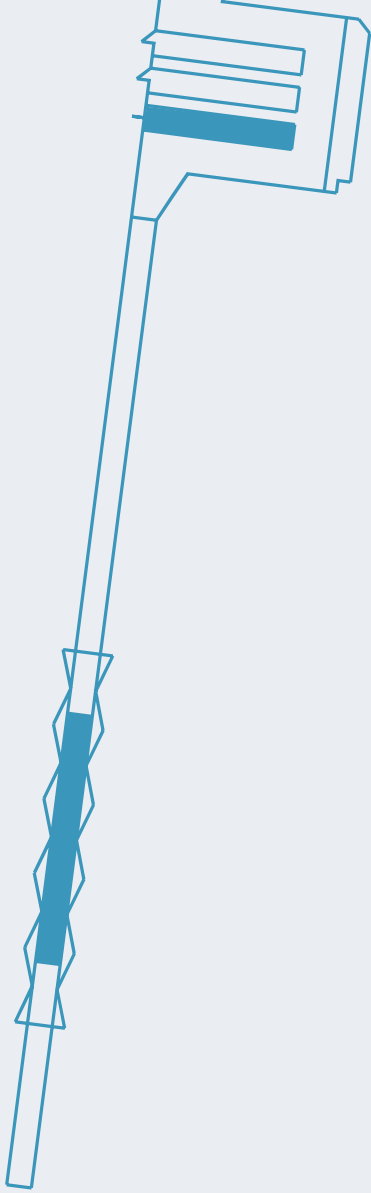

Special Ring Terminals

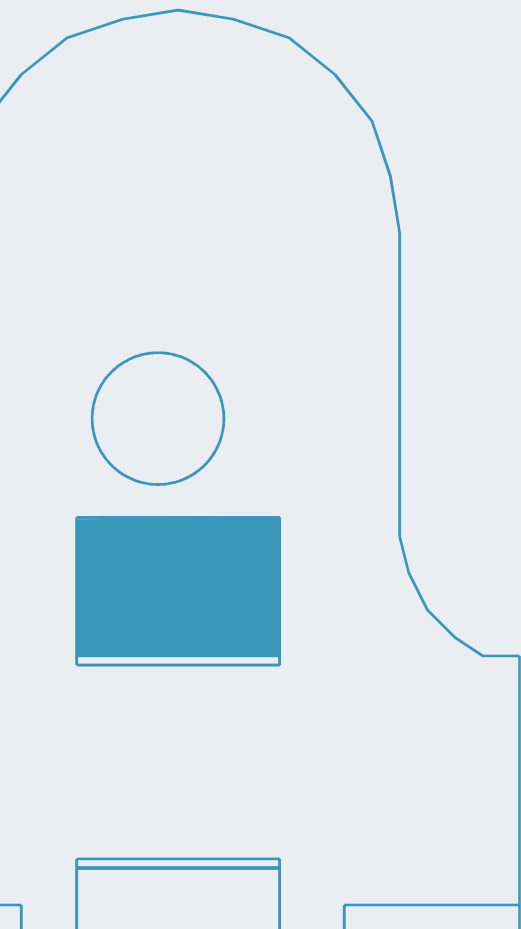

Special Ring Terminals

CATEGORY NO.	ID	CABLE SIZE MM ²	DESCRIPTION	APPLICABLE MATING TERMINAL	MATERIAL	STANDARD PACKING QTY. [NOS.]	
TT-1616	4.30	0.75-1.50	Antirotational Ring Terminal	NA	CuZn	5000	
TT-1816	5.40	0.50-1.50	Antirotational Ring Terminal	NA	CuZn	5000	
TT-2888	6.50	0.75-1.50	Antirotational Ring Terminal	NA	CuSn	1500	
TT-2889	6.50	1.50-2.50	Antirotational Ring Terminal	NA	CuSn	1000	
TT-2890	6.50	2.00-5.00	Antirotational Ring Terminal	NA	CuSn	750	
TT-2892 REMARK Loose	8.50	2.00-4.00	Antirotational Ring Terminal	NA	CuSn	750	
TT-2936 REMARK Loose	8.50	25.00-35.00	Body Terminal	NA	CuSn	100	
TT-2941 REMARK Loose	6.50	25.00-35.00	Body Terminal	NA	CuSn	100	