



Turbomachinery Mastered

Conceptual design and analysis of turbomachinery



design. analyze. optimize.

www.softinway.com

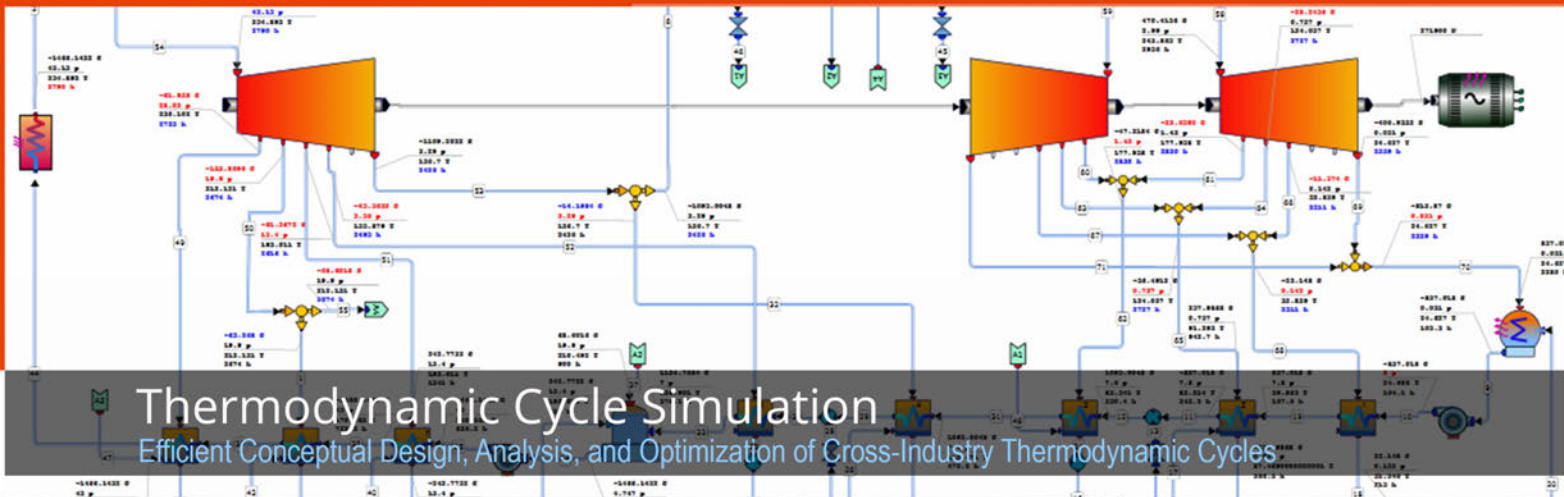

Thermodynamic Cycle Simulation

Efficient Conceptual Design, Analysis, and Optimization of Cross-Industry Thermodynamic Cycles

Designed for the thermodynamic simulation and heat balance calculations of heat production, refrigeration, propulsion and electric energy cycles, the AxCYCLE™ software platform allows users to design, analyze and optimize thermodynamic systems quickly and efficiently for design and off-design conditions.



As a conceptual tool, AxCYCLE™ uses only the basic thermodynamic parameters of the components such as pressure, enthalpy, temperature, fluid quality and basic performance parameters such as efficiency and turbine constant. No mechanical or geometric data is required!

AxCYCLE™ is the perfect software tool to use in either the conceptual design phase of a cycle or for the analysis of existing cycles. Its integration with the AxSTREAM® software platform makes design, analysis, and optimization more streamlined for the reduction of iteration time, human error, and the elimination of software incompatibilities.

The platform features an outstanding and intuitive interface, drag and drop simplicity with an embedded components library for turbomachines, heat exchangers, separation & mixing elements, generators, combustors, engines, as well as auxiliary elements. An infinite number of cycles are possible.

Easily create and optimize thermodynamic systems in a single software platform

AxCYCLE™ Features and Cycles

Features

- Simulate numerous types of cycles
- Create cycle diagrams through our predefined components library. Each component has predefined connection points and ports for fluid flow and mechanical power
- Flexible cycle creation using embedded components
- Run heat balance modeling simulations with only a small subset of component parameters
- Flexible problem formulation for the calculation of missing values based on specified boundary conditions.
- Calculate cycle maps to study the effects of variations of operating conditions and component parameters on the cycle performance.
- Calculate and compare P-H and T-S diagrams of cycle processes.
- Estimate power plant equipment cost and conduct investment analysis of plant construction.
- Simplify your process with an understandable Excel interface.

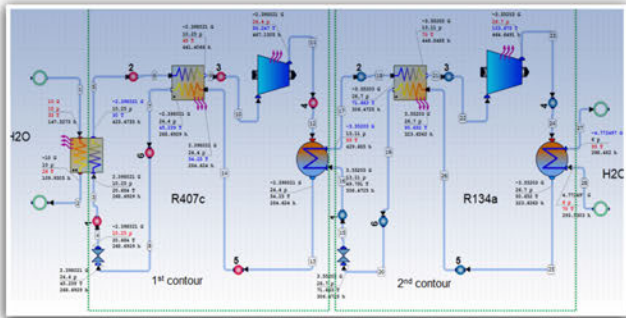

Simulate numerous types of cycles

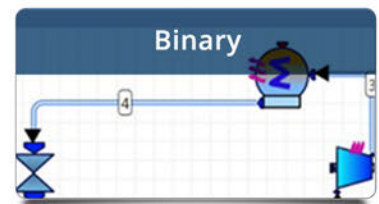
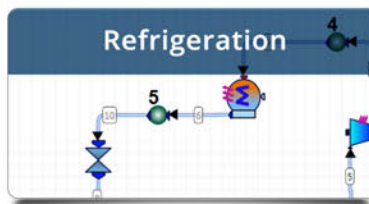
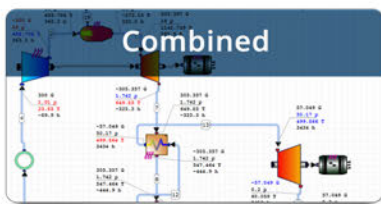
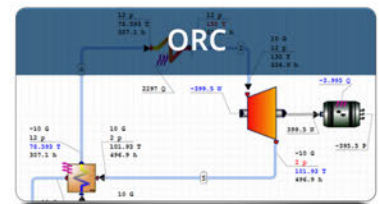
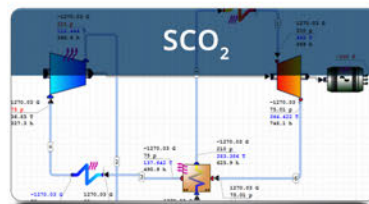
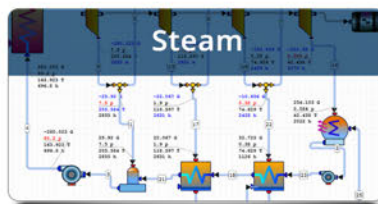
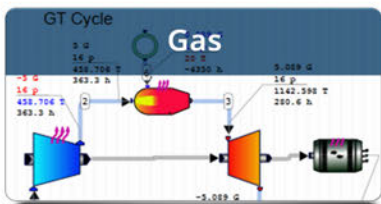



AxCYCLE™ Applications

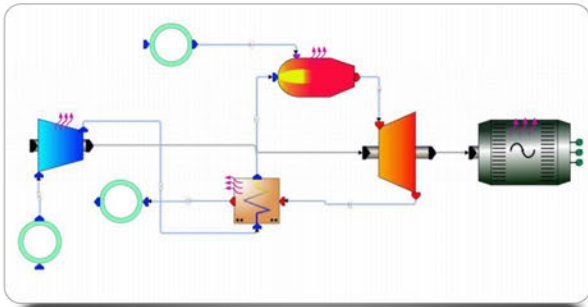

Gas Turbines Cycles

AxCYCLE™ allows users to analyze thermodynamic processes of the gas turbine plant. AxCYCLE™ provides a library of 400+ existing gas engines with OEM performance data. It can be used "off-the-shelf" to simulate and combine different combined cycles. Library users can also create any gas turbine they desire with a customized compressor, combustion chamber, and turbine.

Steam Cycles

AxCYCLE™ lets you simulate steam cycles of arbitrary configurations. Thermal power plants have advantages that distinguish them from power plants that use a gaseous working medium. The steam cycle is a practical one; it is the basis of virtually all steam power plants and hence, electricity generation. AxCYCLE™ provides steam cycle simulations for fossil and nuclear power plants.

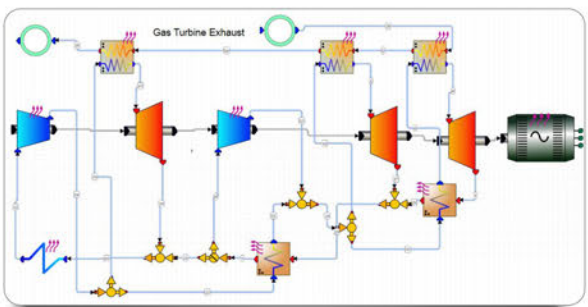
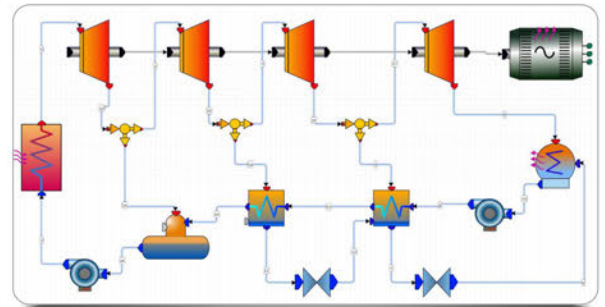

Supercritical CO₂

Supercritical fluid is fluid over its critical temperature and pressure that exhibits good solvent power. These cycles are becoming increasingly popular for power plants. AxCYCLE™ lets you model every phase of the design for turbines and compressors for Supercritical CO₂ cycles.

Organic Rankine Cycles

Organic Rankine Cycles (ORC) apply the principles of steam Rankine cycles, but use organic working fluids with low boiling points to recover heat from lower temperature heat sources. AxCYCLE™ allows you to simulate ORC cycles for any configuration and provides NIST refrigerants and fluids.

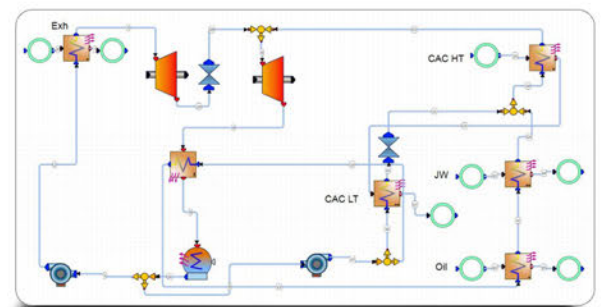



AxCYCLE™ Applications

Combined

AxCYCLE™ enables you to model phases of electrical and thermal power generation with different types of combined cycles. These include gas and steam turbine combined cycles, which are successfully utilized in hundreds of power plants worldwide, and also new cycles, such as gas and SCO_2 combined cycles, gas and ORC combined cycles, and steam and ORC cycles.

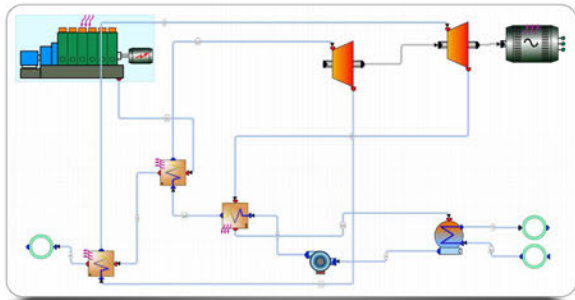
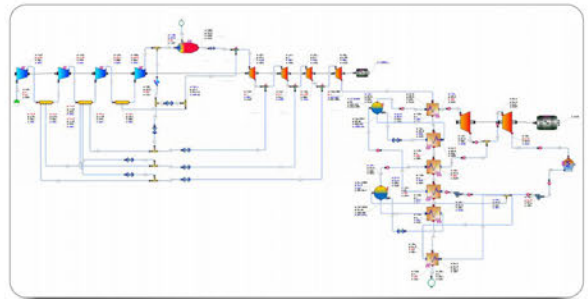

Waste Heat Recovery Cycles

AxCYCLE™ is not limited in terms of number of cycle loops or fluids that can be used within a single project. This, along with the unnecessary of mechanical/geometric input data as the multitude of media to work with make AxCYCLE™ the perfect tool for innovation like waste heat recovery in different industries.

Refrigeration Cycles

AxCYCLE™ is not just for power generation or propulsion, but also for other types of cycles including refrigeration/heat pumps. A wide selection of appropriate fluids are available with thermodynamic properties taken directly from the NIST RefProp database.

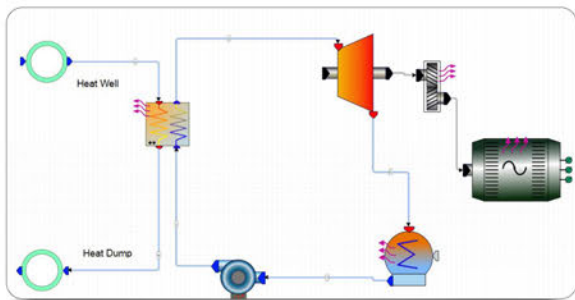
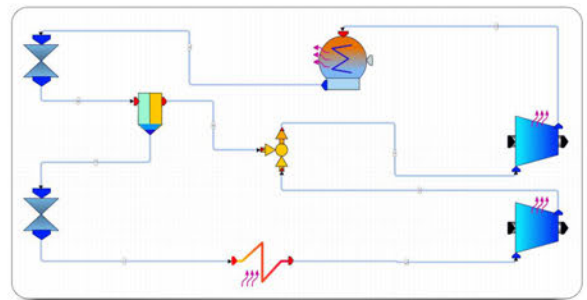

Binary

Binary Cycles are one type of geothermal power source that allow the use of a cooler geothermal supply. This provides a huge benefit since lower temperature resources are much more common in nature. Enhance the advantages of your binary power cycle using AxCYCLE™.

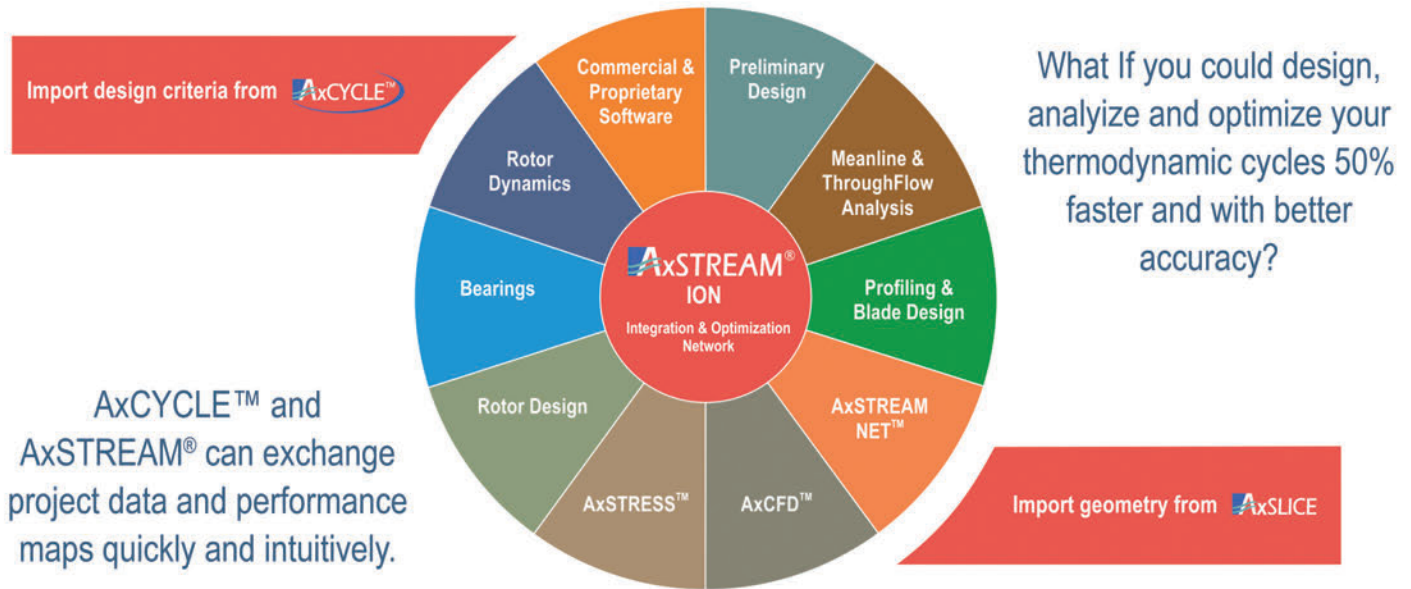

When AxSTREAM® opens an AxCYCLE™ file, it automatically builds a project for preliminary design.

AxCYCLE™ Economics

The AxCYCLE™ Economics Module provides power plant equipment cost estimation as well as investment analysis of plant construction. It includes means for TCI (Total Capital Investment), NPV (Net Present Value), LCOE (Levelized Cost of Electricity), Cash Flow, Payback Period and for other parameters definition. The module features opportunities for user-defined data use, the incorporation of the user's models for equipment cost estimation, and comparisons of cash flow charts with alternative projects.

CASE

CASE is used to calculate series of user-defined cases based on an unlimited number of variables and objectives. It is the perfect tool to calculate different load points when not only operational parameters are changed but some cycle branches may be closed and opened again. Additionally, it is spreadsheet-friendly for improved import & export user experience.

PLAN

PLAN is a multivariable engine powered by a DoE (Design of Experiment) engine. The DoE engine itself selects points (a set of values for up to 20 simultaneous variables and an unlimited number of functions), in an optimized way, to minimize the number of solver runs. The obtained results are used to build "response surfaces" that are used as abstract models for optimization.

Fluids

AxCYCLE™ features several fluid libraries including steam, air, and natural gas, as well as NIST REFPROP models for CO₂, refrigerants, ethanol, mixtures, and more. Additionally, custom fluids can be created easily within AxCYCLE™ and combustion products can be user-defined or calculated automatically based on fuel composition and air excess factor.

Quest

QUEST enables AxCYCLE™ users to study quasi-random combinations of parameter values within user-defined ranges. Optimization is performed based on a created design space to filter, compare, and select the optimum combination for the given application.

Map

Multi-run tool used to run a series of calculations for up to 2 variables. MAP is a very effective tool to study the influence of operational parameters on cycle performance. It is also the ultimate tool to calculate cycle performance curves.

AxCYCLE™ Solver

AxCYCLE™ provides the design and off-design steady state heat balance calculation for thermodynamic cycles.

About SoftInWay

The Leaders in Turbomachinery Design and Optimization

AxSTREAM® Training Workshops:



SoftInWay delivers software tools and industry training that enable you and your organization to be more effective. With our extensive curriculum from AxSTREAM® and AxCYCLE™ hands on workshops to Waste Heat Recovery and Advanced 3D Blade design courses, we cover the diverse training needs of our global turbomachinery customers through -

- Traditional classroom training
- Online courses
- Corporate learning programs

AxSTREAM® 3.8 Software Platform
New Modules:
AxSTREAM RotorDesign™
AxSTREAM.AI™

Engineering Services

Education
Classroom Workshops
Online Courses
Self-Paced Video Courses

SoftInWay, Inc. is a global R&D engineering company specializing in the development of efficient turbomachinery components and systems through its integrated and automated software platform, AxSTREAM® for all steps of the turbomachinery development process (including complete 3D design, thermodynamic cycles, rotor dynamics, and secondary flow and cooling system simulation). SoftInWay also offers a number of engineering services and educational courses, available both online and in a classroom-style setting.

Being an ISO 9001:2015 and AS9100:2016 certified company, SoftInWay is committed to providing its customers with products and services that meet international quality standards.

With offices in the US, Switzerland, Ukraine, and India, SoftInWay supports more than 400 companies worldwide, and works closely with universities, research laboratories, and government organizations.

Industries Served:

Power Generation



Oil & Gas



Aerospace



Clean Technology



Government & Defense



Appliances & Medical Devices



HVAC & Refrigeration



Automotive





SoftInWay Offices

SoftInWay Inc.

1500 District Avenue, Burlington, MA 01803, USA
Phone: +1- 781-328-4310 FAX: +1-781-685-4601
info@softinway.com

SoftInWay Inc. Sales & Marketing

147 West 35th St. Suite 1504
New York City, NY, 10001
Phone: +1-347-580-1459
sales@softinway.com

SoftInWay Switzerland GmbH

Baarerstrasse 2 – 6300 Zug, Switzerland
Phone: +41 44 586-1998
switzerland@softinway.com

Independent Distributors

SoftInWay Turbomachinery Solutions Pvt. Ltd

Flat No. 301, 3rd Floor, Royal Manor,
70/10, Cunningham Road,
Bangalore-560052
Phone: +91 80 40908191
india@softinway.com

Actual Mechanics

Moskovskiy Avenue 199B, Kharkov, Ukraine
Phone: +38 057 758-1227
ukraine@softinway.com

www.softinway.com