

BURCHETT™ BQT

Burchett Quality Tool Ltd.

If You Do
Not See It...
We Can Make It!



Manufacturer
Direct Pricing

Take exit 34A to I-94 east from N or S 131. Then Sprinkle rd. exit 80 (go left) to Wynn Rd., turn right. From east I-94 take exit 81, turn right on River St. then left on Wynn Rd.

BURCHETT QUALITY TOOL Ltd
5271 Wynn Rd. Kalamazoo, MI 49048
PHONE: (269) 344-3041 FAX: (269) 344-6368
www.bqtool.com sales@bqtool.com

BURCHETT™ BQT

Burchett Quality Tool Ltd. 2017

PRECISION QUALITY:

- CUSTOM & SPECIAL END MILLS & DRILLS
- STANDARD & METRIC END MILLS & DRILLS

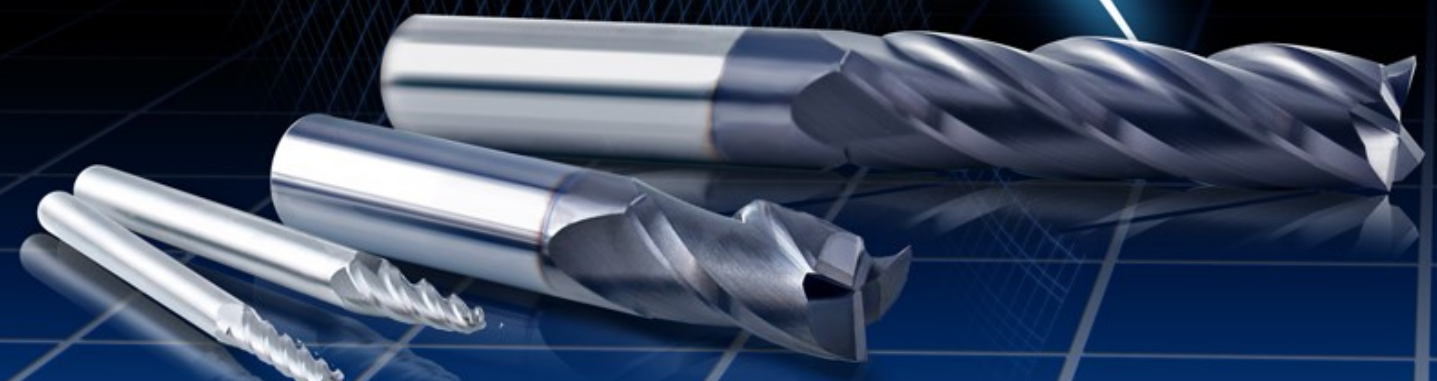

VIEW COMPLETE PRODUCT INFO AT:
WWW.BQTOOL.COM

Burchett Quality Tool

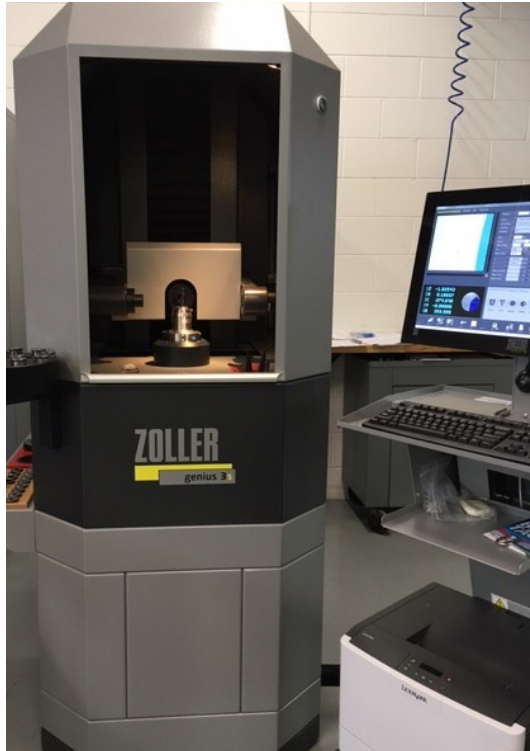

With Over 28 years experience in Cutting Tool Design and Manufacturing, our Superior Quality Standard & Custom Cutting Tools, combined with our Rapid Response Time makes Burchett Quality Tool a supplier you can **TRUST!** We utilize top of the line manufacturing and inspection equipment to make sure your tooling is exactly what you want.

Satisfaction is Guaranteed!

Utilizing state of the art inspection equipment and leading edge equipment, we can ensure complete satisfaction with each tool we provide you. Use our Custom Tool Order forms located in the back of the catalog to begin your custom tool development or contact us by phone and speak with one of our qualified tool engineers, or fax your print (269) 344-6368.

CAN'T FIND YOUR END MILL? We Will Make It For YOU!

We are renowned and trusted for our innovative, custom tooling with a long history of building and testing virtually all types of custom cutting tools. BQT's experienced design staff, and seasoned CNC machinists, ensure your custom tool order delivered within a few days, not weeks.

**We can manufacture your
Carbide & Brazed Tipped Form Tools!
Send us your drawings today!**



Parts & Pricing

We have several thousand parts on hand for immediate sale. All parts are sold at direct manufacturer pricing! Each part that leaves our shop is guaranteed to be of the highest quality. Call today for details and see how we can increase your production runs while decreasing your tooling costs!



Company _____
Name _____
Phone _____ Email _____ Fax _____

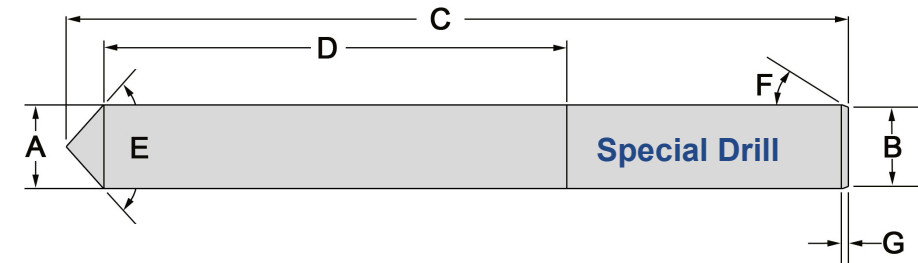

Diameter (A) _____ (B) _____ Overall Length (C) _____ Flute Length (D) _____
Included Angle (E) _____ (F) _____ (G) _____
Material: H.S.S. _____ Carbide _____ Cobalt _____ Quantity _____ Due Date _____

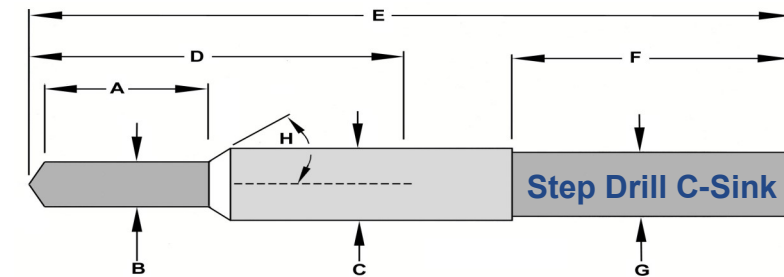

Step Length (A) _____ Minor Dia. (B) _____ Major Dia. (C) _____ Flute Length (D) _____ Overall Length (E) _____
Shank Length (F) _____ Shank Dia. (G) _____ Angler Per Side (H) _____
MATERIAL H.S.S. _____ Carbide _____ Cobalt _____ Quantity _____ Due Date _____

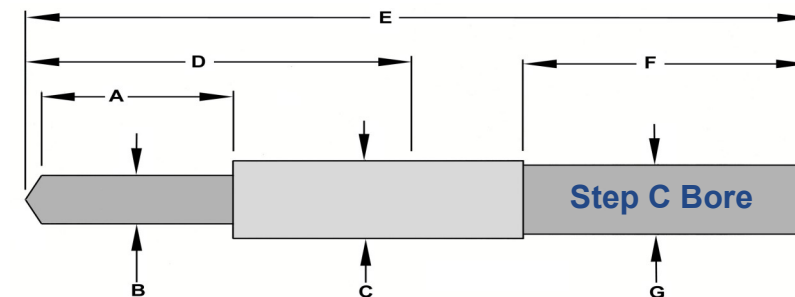

Step Length (A) _____ Minor Dia. (B) _____ Major Dia. (C) _____ Flute Length (D) _____ Overall Length (E) _____
Shank Length (F) _____ Shank Dia. (G) _____ MATERIAL H.S.S. _____ Carbide _____ Cobalt _____
Quantity _____ Due Date _____

Company _____
 Name _____
 Phone _____ Email _____ Fax _____

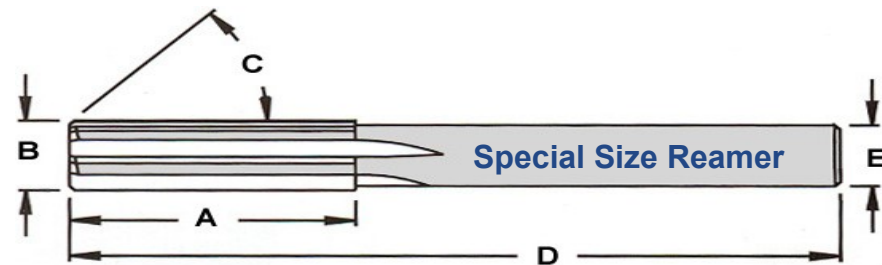

Flute Length (A) _____ Diameter (B) _____ Angle Per Side (C) _____ Overall Length (D) _____
 Shank Diameter (E) _____ MATERIAL H.S.S. _____ Carbide _____ Cobalt _____
 Quantity _____ Due Date _____

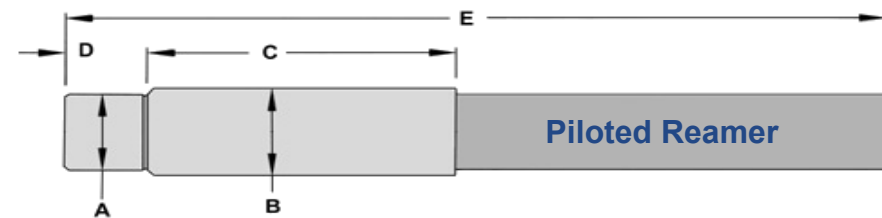

Pilot Step Dia. (A) _____ Reamer Dia. (B) _____ Flute Length (C) _____ Pilot Step Length (D) _____
 Overall Length (E) _____ MATERIAL H.S.S. _____ Carbide _____ Cobalt _____
 Quantity _____ Due Date _____

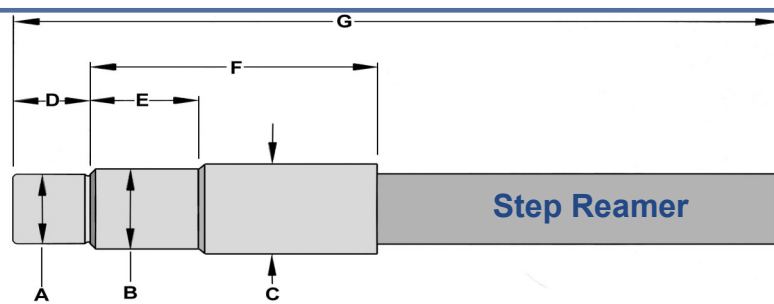

Pilot Step Dia. (A) _____ Step 1 Dia. (B) _____ Step 2 Dia. (C) _____ Pilot Step Length (D) _____
 Step 1 Length (E) _____ Length Of Cut (F) _____ Overall Length (G) _____
 MATERIAL H.S.S. _____ Carbide _____ Cobalt _____ Quantity _____ Due Date _____

Fax To (269) 344-6368

Catalog Index

SQUARE END MILLS

Stub Length Square End Mills & Standard Square End Mills	3
Extra Length Square End Mills & Metric Square End Mills	4

BALL NOSE END MILLS

Stub Length Ball Nose End Mills & Standard Ball Nose End Mills	5
Extra Length Ball Nose End Mills & Metric Ball Nose End Mills	6

TAPERED END MILLS

Tapered Square and Ball Nose End Mills & Custom Tapered End Mill Form	7
---	---

CORNER RADIUS END MILLS

Corner Radius Coated and Un-Coated End Mills & Custom Corner Radius Form	8
--	---

HIGH HELIX / PERFORMANCE END MILLS & DRILLS

45 Degree Helix W/ Sharp Corners (2 Flute & 3 Flute)	9
High Helix Eccentric Relief Finish End Mills, Independent Helix End Mills, Rougher / Finisher	10
High Helix Square and Ball Nose End Mills	11
High Performance Drilling 30° Coolant Thru Drills & Custom Drill Form	12

RIB CUTTERS

Corner Radius Rib Cutters	13
Ball Nose Rib Cutters	14

EXTENDED REACH END MILLS

Extended Reach Micro Mills	15
Extended Reach Ball Nose Clearance Cutters	16

LOLLYPOP & DIAMOND COATED CVD END MILLS

LollyPop End Mills & Diamond Coated CVD End Mills	17
---	----

RECONDITIONING (see website for all reconditioning & sharpening rates - www.bqtool.com)

Carbide & HSS End Mill Reconditioning	18
Carbide & HSS Drill Reconditioning	19

SPECIAL TOOL ORDER FORMS

Special Tool Order Form - (Key Cutter & Corner Rounder)	20
Special Tool Order Form - (Reamer, Piloted Reamer & Step Reamer)	21
Special Tool Order Form - (Special Drill, Step Drill C Sink & Step C Bore)	22

Micrograin Carbide
Stub Length Square End Mills

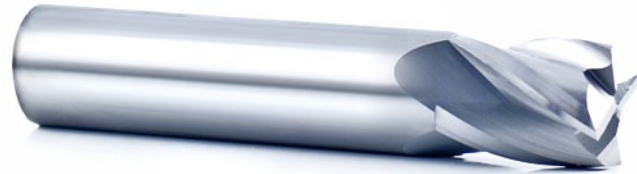

UN-COATED

DIA	Flute Length	Overall Length	2 Flute (EDP #)	3 Flute (EDP #)	4 Flute (EDP #)	Price
1/32	1/16	1 1/2	2FS031	3FS031	4FS031	\$7.92
3/64	3/32	1 1/2	2FS046	3FS046	4FS046	\$7.92
1/16	1/8	1 1/2	2FS062	3FS062	4FS062	\$7.92
5/64	3/16	1 1/2	2FS078	3FS078	4FS078	\$7.92
3/32	3/16	1 1/2	2FS093	3FS093	4FS093	\$6.60
1/8	1/4	1 1/2	2FS125	3FS125	4FS125	\$6.60
5/32	5/16	2	2FS156	3FS156	4FS156	\$9.24
3/16	3/8	2	2FS188	3FS188	4FS188	\$8.58
7/32	7/16	2	2FS218	3FS218	4FS218	\$11.22
1/4	1/2	2	2FS250	3FS250	4FS250	\$11.22
5/16	1/2	2	2FS312	3FS312	4FS312	\$15.18
3/8	5/8	2	2FS375	3FS375	4FS375	\$18.48
7/16	5/8	2 1/2	2FS437	3FS437	4FS437	\$22.44
1/2	5/8	2 1/2	2FS500	3FS500	4FS500	\$30.36
5/8	3/4	3	2FS625	3FS625	4FS625	\$58.08
3/4	1	3	2FS750	3FS750	4FS750	\$83.16

COATED

DIA	Flute Length	Overall Length	2 Flute (EDP #)	3 Flute (EDP #)	4 Flute (EDP #)	Price
1/32	1/16	1 1/2	2FS031C	3FS031C	4FS031C	\$10.56
3/64	3/32	1 1/2	2FS046C	3FS046C	4FS046C	\$10.56
1/16	1/8	1 1/2	2FS062C	3FS062C	4FS062C	\$9.24
5/64	3/16	1 1/2	2FS078C	3FS078C	4FS078C	\$9.24
3/32	3/16	1 1/2	2FS093C	3FS093C	4FS093C	\$8.58
1/8	1/4	1 1/2	2FS125C	3FS125C	4FS125C	\$8.58
5/32	5/16	2	2FS156C	3FS156C	4FS156C	\$11.22
3/16	3/8	2	2FS188C	3FS188C	4FS188C	\$14.52
7/32	7/16	2	2FS218C	3FS218C	4FS218C	\$14.52
1/4	1/2	2	2FS250C	3FS250C	4FS250C	\$14.52
5/16	1/2	2	2FS312C	3FS312C	4FS312C	\$19.80
3/8	5/8	2	2FS375C	3FS375C	4FS375C	\$26.40
7/16	5/8	2 1/2	2FS437C	3FS437C	4FS437C	\$30.36
1/2	5/8	2 1/2	2FS500C	3FS500C	4FS500C	\$36.96
5/8	3/4	3	2FS625C	3FS625C	4FS625C	\$66.00
3/4	1	3	2FS750C	3FS750C	4FS750C	\$93.72

Micrograin Carbide
Standard Square End Mills

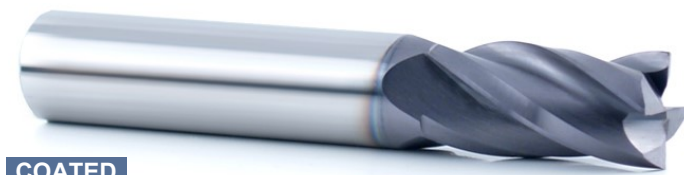

UN-COATED

DIA	Flute Length	Overall Length	2 Flute (EDP #)	3 Flute (EDP #)	4 Flute (EDP #)	Price
1/32	3/32	1 1/2	2F031	3F031	4F031	\$8.58
3/64	1/8	1 1/2	2F046	3F046	4F046	\$8.58
1/16	1/4	1 1/2	2F062	3F062	4F062	\$7.92
5/64	1/4	1 1/2	2F078	3F078	4F078	\$7.92
3/32	3/8	1 1/2	2F093	3F093	4F093	\$7.92
7/64	3/8	1 1/2	2F109	3F109	4F109	\$7.92
1/8	1/2	1 1/2	2F125	3F125	4F125	\$6.60
9/64	9/16	2	2F140	3F140	4F140	\$11.00
5/32	9/16	1 1/2	2F156	3F156	4F156	\$11.00
11/64	9/16	2	2F171	3F171	4F171	\$11.00
3/16	5/8	2	2F188	3F188	4F188	\$9.90
13/64	5/8	2	2F203	3F203	4F203	\$13.20
7/32	5/8	2 1/2	2F218	3F218	4F218	\$13.20
1/4	3/4	2 1/2	2F250	3F250	4F250	\$11.88
9/32	3/4	2 1/2	2F281	3F281	4F281	\$21.12
5/16	7/8	2 1/2	2F312	3F312	4F312	\$16.50
11/32	7/8	2 1/2	2F343	3F343	4F343	\$20.46
3/8	7/8	2 1/2	2F375	3F375	4F375	\$20.46
25/64	7/8	2 1/2	2F390	3F390	4F390	\$25.08
13/32	7/8	2 1/2	2F406	3F406	4F406	\$25.08
7/16	1	3	2F437	3F437	4F437	\$25.08
1/2	1	3	2F500	3F500	4F500	\$33.00
9/16	1 1/4	3 1/2	2F562	3F562	4F562	\$56.76
5/8	1 1/4	3 1/2	2F625	3F625	4F625	\$62.04
3/4	1 1/2	4	2F750	3F750	4F750	\$93.72
7/8	1 1/2	4	2F875	3F875	4F875	\$133.32
1	1 1/2	4	2F1000	3F1000	4F1000	\$138.60

COATED

DIA	Flute Length	Overall Length	2 Flute (EDP #)	3 Flute (EDP #)	4 Flute (EDP #)	Price
1/32	3/32	1 1/2	2F031C	3F031C	4F031C	\$10.56
3/64	1/8	1 1/2	2F046C	3F046C	4F046C	\$10.56
1/16	1/4	1 1/2	2F062C	3F062C	4F062C	\$10.56
5/64	1/4	1 1/2	2F078C	3F078C	4F078C	\$10.56
3/32	3/8	1 1/2	2F093C	3F093C	4F093C	\$9.58
7/64	3/8	1 1/2	2F109C	3F109C	4F109C	\$9.58
1/8	1/2	1 1/2	2F125C	3F125C	4F125C	\$9.24
9/64	9/16	2	2F140C	3F140C	4F140C	\$14.07
5/32	9/16	1 1/2	2F156C	3F156C	4F156C	\$12.21
11/64	9/16	2	2F171C	3F171C	4F171C	\$14.07
3/16	5/8	2	2F188C	3F188C	4F188C	\$11.88
13/64	5/8	2	2F203C	3F203C	4F203C	\$17.56
7/32	5/8	2 1/2	2F218C	3F218C	4F218C	\$17.60
1/4	3/4	2 1/2	2F250C	3F250C	4F250C	\$17.16
9/32	3/4	2 1/2	2F281C	3F281C	4F281C	\$27.06
5/16	7/8	2 1/2	2F312C	3F312C	4F312C	\$22.44
11/32	7/8	2 1/2	2F343C	3F343C	4F343C	\$27.06
3/8	7/8	2 1/2	2F375C	3F375C	4F375C	\$27.06
25/64	7/8	2 1/2	2F390C	3F390C	4F390C	\$32.34
13/32	7/8	2 1/2	2F406C	3F406C	4F406C	\$32.34
7/16	1	3	2F437C	3F437C	4F437C	\$32.34
1/2	1	3	2F500C	3F500C	4F500C	\$39.60
9/16	1 1/4	3 1/2	2F562C	3F562C	4F562C	\$66.66
5/8	1 1/4	3 1/2	2F625C	3F625C	4F625C	\$73.92
3/4	1 1/2	4	2F750C	3F750C	4F750C	\$105.60
7/8	1 1/2	4	2F875C	3F875C	4F875C	\$155.76
1	1 1/2	4	2F1000C	3F1000C	4F1000C	\$157.08

Company _____

Name _____

Phone _____ Email _____ Fax _____

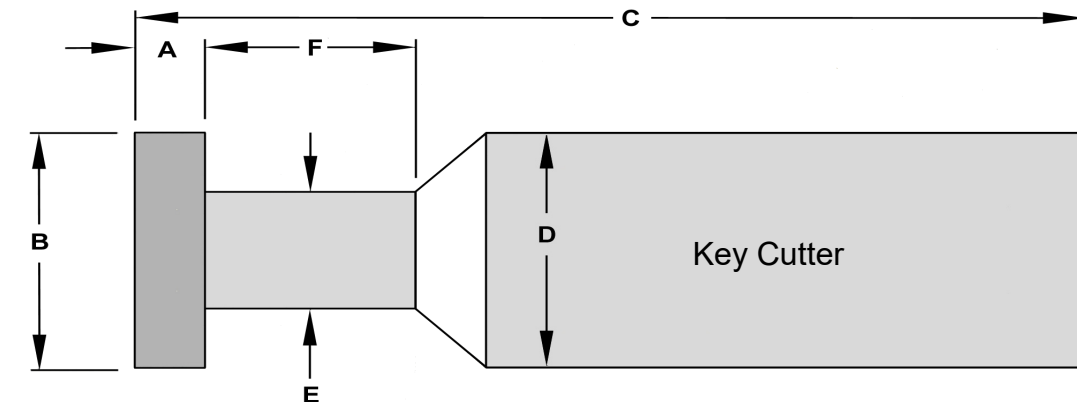

Seat Length (A) _____ Key Dia. (B) _____ Overall Length (C) _____

Shank Dia. (D) _____ Neck Dia. (E) _____ Neck Length (F) _____

MATERIAL H.S.S. ___ Carbide ___ Cobalt ___

Quantity _____ Due Date _____

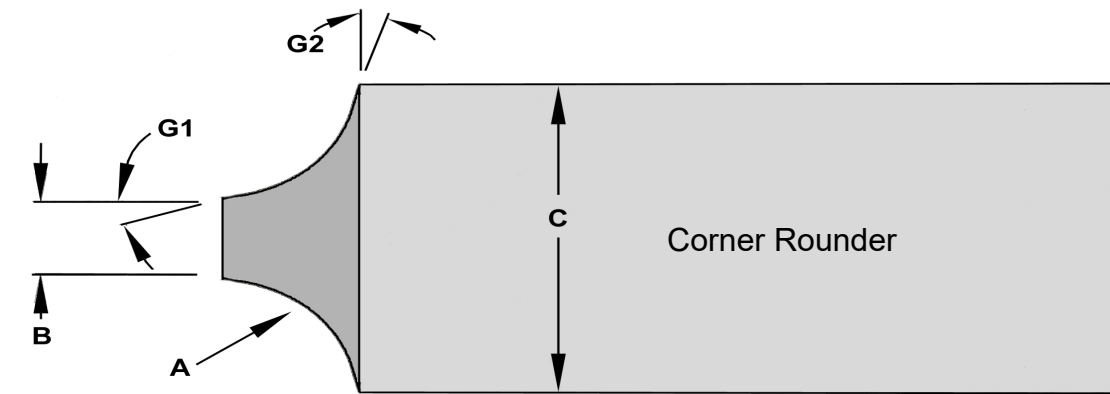

Radius (A) _____ Tip Diameter (B) _____ Major Diameter (C) _____

Overall Length (D) _____ Lead In Angle (G1) _____

Lead Out Angle (G2) _____ MATERIAL H.S.S. ___ Carbide ___ Cobalt ___

Quantity _____ Due Date _____

Don't see what you need? Have a question? Call (269) 344-3041

High Performance Drill Reconditioning

SOLID CARBIDE OR CARBIDE TIPPED				
DIAMETER	EDP #	RECONDITION	EDP #	RECONDITION & RECOAT
		Min. LOC 2" Unless Specified C/O If Needed Is No Charge		Based On Standard Length
up to .374	RCT375	\$20.79	RCT375C	\$30.61
.375 to .624	RCT624	\$23.10	RCT624C	\$33.50
.625 to .749	RCT749	\$26.57	RCT749C	\$39.27
.750 to .874	RCT874	\$30.03	RCT874C	\$43.89
.875 to 1.0	RCT1000	\$34.65	RCT1000C	\$50.82

HSS DRILL SHARPENING 118° PT ONLY				
Diameter	EDP #	Price	EDP #	Sharpen & Coated
Up to .249	RHSD249	\$2.17	RHSD249C	\$13.86
Up to .499	RHSD499	\$4.22	RHSD499C	\$16.17
.500 to .749	RHSD749	\$7.68	RHSD749C	\$19.64
.750 to .999	RHSD999	\$9.99	RHSD999C	\$24.26
1.000 to 1.249	RHSD1249	\$12.29	RHSD1249C	\$31.19
1.250 to 1.499	RHSD1499	\$17.33	RHSD1499C	\$68.15
1.500 to 1.999	RHSD1999	\$28.88	RHSD1999C	\$85.47
2.000 to 2.900	RHSD2900	\$40.43	RHSD2900C	\$108.57

HSS SPOTTING DRILLS SHARPENING				
Diameter	EDP #	Price	EDP #	Sharpen & Coated
Up to .374	RHSSD374	\$3.47	RHSSD374C	\$15.60
.375 to .499	RHSSD499	\$4.62	RHSSD499C	\$16.75
.500 to .624	RHSSD624	\$5.78	RHSSD624C	\$18.48
.625 to .749	RHSSD749	\$8.09	RHSSD749C	\$20.79
.750 to 1"	RHSSD1	\$11.55	RHSSD1C	\$31.19

HSS COUNTER SINKS, BORES & REAMERS SHARPENING				
Diameter	EDP #	Price	EDP #	Sharpen & Coated
Up to .499	RSBR499	\$5.78	RSBR499C	\$18.48
.500 to .749	RSBR749	\$8.09	RSBR749C	\$20.79
.750 to .999	RSBR999	\$10.40	RSBR999C	\$30.03
1.0 to 1.249	RSBR1249	\$12.71	RSBR1249C	\$41.58
1.250 to 1.499	RSBR1499	\$15.02	RSBR1499C	\$78.54
1.500 to 1.749	RSBR1749	\$17.33	RSBR1749C	\$80.85
1.750 to 1.999	RSBR1999	\$19.64	RSBR1999C	\$84.32
2.0 to 3.0	RSBR30	\$23.10	RSBR30C	\$93.56

Solid Carbide Drill Sharpening								
Diameter	118° Pt. EDP #	Price	Coated EDP #	Price	135° Pt. EDP #	Price	Coated EDP #	Price
Up to .374	RC18374	\$6.93	RC18374C	\$19.64	RC35374	\$9.24	RC35374C	\$21.95
.375 to .499	RC18499	\$11.55	RC18499C	\$24.26	RC35499	\$13.86	RC35499C	\$26.57
.500 to 1.0	RC1810	\$20.79	RC1810C	\$40.43	RC3510	\$23.10	RC3510C	\$42.74

We are not responsible for problems incurred when reconditioning other manufacturers parts

Micrograin Carbide Extra Length Square End Mills



UN-COATED

DIA	Flute Length	Overall Length	2 Flute (EDP #)	3 Flute (EDP #)	4 Flute (EDP #)	Price
1/8	5/8	2	2FL125	3FL125	4FL125	\$10.56
1/8	1	3	2FXL125	3FXL125	4FXL125	\$15.84
3/16	1	3	2FL188	3FL188	4FL188	\$18.48
3/16	1 1/8	3	2FXL188	3FXL188	4FXL188	\$18.48
1/4	1	3	2FL250	3FL250	4FL250	\$21.12
1/4	1 1/2	4	2FXL250	3FXL250	4FXL250	\$21.12
5/16	1	3	2FL312	3FL312	4FL312	\$25.08
5/16	1 5/8	4	2FXL312	3FXL312	4FXL312	\$27.72
3/8	2	4	2FL375	3FL375	4FL375	\$31.68
3/8	3	6	2FXL375	3FXL375	4FXL375	\$44.88
7/16	2	4	2FL437	3FL437	4FL437	\$42.24
7/16	3	6	2FXL437	3FXL437	4FXL437	\$56.76
1/2	2	4	2FL500	3FL500	4FL500	\$44.88
1/2	3	6	2FXL500	3FXL500	4FXL500	\$66.00
5/8	2	5	2FL625	3FL625	4FL625	\$92.40
5/8	3	6	2FXL625	3FXL625	4FXL625	\$92.40
3/4	2 1/4	5	2FL750	3FL750	4FL750	\$147.84
3/4	3	6	2FXL750	3FXL750	4FXL750	\$147.84
3/4	4	6	2FXL750	3FXL750	4FXL750	\$165.00
1	2 1/4	5	2FL1000	3FL1000	4FL1000	\$174.24
1	3	6	2FXL1000	3FXL1000	4FXL1000	\$207.24
1	4	6	2FXL1000	3FXL1000	4FXL1000	\$231.00



COATED

DIA	Flute Length	Overall Length	2 Flute (EDP #)	3 Flute (EDP #)	4 Flute (EDP #)	Price
1/8	5/8	2	2FL125C	3FL125C	4FL125C	\$11.88
1/8	1	3	2FXL125C	3FXL125C	4FXL125C	\$18.48
3/16	1	3	2FL188C	3FL188C	4FL188C	\$21.12
3/16	1 1/8	3	2FXL188C	3FXL188C	4FXL188C	\$23.10
1/4	1	3	2FL250C	3FL250C	4FL250C	\$25.08
1/4	1 1/2	4	2FXL250C	3FXL250C	4FXL250C	\$26.40
5/16	1	3	2FL312C	3FL312C	4FL312C	\$31.68
5/16	1 5/8	4	2FXL312C	3FXL312C	4FXL312C	\$35.64
3/8	2	4	2FL375C	3FL375C	4FL375C	\$39.60
3/8	3	6	2FXL375C	3FXL375C	4FXL375C	\$55.44
7/16	2	4	2FL437C	3FL437C	4FL437C	\$51.48
7/16	3	6	2FXL437C	3FXL437C	4FXL437C	\$69.96
1/2	2	4	2FL500C	3FL500C	4FL500C	\$54.12
1/2	3	6	2FXL500C	3FXL500C	4FXL500C	\$77.88
5/8	2	5	2FL625C	3FL625C	4FL625C	\$105.60
5/8	3	6	2FXL625C	3FXL625C	4FXL625C	\$108.24
3/4	2 1/4	5	2FL750C	3FL750C	4FL750C	\$165.00
3/4	3	6	2FXL750C	3FXL750C	4FXL750C	\$165.00
3/4	4	6	2FXL750C	3FXL750C	4FXL750C	\$195.36
1	2 1/4	5	2FL1000C	3FL1000C	4FL1000C	\$198.00
1	3	6	2FXL1000C	3FXL1000C	4FXL1000C	\$231.00
1	4	6	2FXL1000C	3FXL1000C	4FXL1000C	\$264.00

Don't see what you need? Have a question? Call (269) 344-3041

Micrograin Carbide Metric Square End Mills



UN-COATED

DIA	Flute Length	Overall Length	2 Flute (EDP #)	3 Flute (EDP #)	4 Flute (EDP #)	Price
1mm	4mm	38mm	2M1	3M1	4M1	\$8.05
1.5mm	6mm	38mm	2M1.5	3M1.5	4M1.5	\$7.92
2mm	8mm	38mm	2M2	3M2	4M2	\$7.26
2.5mm	12mm	38mm	2M2.5	3M2.5	4M2.5	\$7.13
3mm	12mm	38mm	2M3	3M3	4M3	\$6.86
3.5mm	12mm	50mm	2M3.5	3M3.5	4M3.5	\$9.77
4mm	14mm	50mm	2M4	3M4	4M4	\$9.77
4.5mm	14mm	50mm	2M4.5	3M4.5	4M4.5	\$9.90
5mm	16mm	63mm	2M5	3M5	4M5	\$11.22
6mm	19mm	63mm	2M6	3M6	4M6	\$11.55
7mm	22mm	63mm	2M7	3M7	4M7	\$15.84
8mm	22mm	63mm	2M8	3M8	4M8	\$17.16
9mm	22mm	63mm	2M9	3M9	4M9	\$19.80
10mm	25mm	63mm	2M10	3M10	4M10	\$22.44
11mm	25mm	76mm	2M11	3M11	4M11	\$23.76
12mm	25mm	76mm	2M12	3M12	4M12	\$31.02
14mm	32mm	88mm	2M14	3M14	4M14	\$58.08
16mm	38mm	88mm	2M16	3M16	4M16	\$64.02
18mm	38mm	100mm	2M18	3M18	4M18	\$86.86
20mm	38mm	100mm	2M20	3M20	4M20	\$129.36
22mm	38mm	100mm	2M22	3M22	4M22	\$134.64
25mm	38mm	100mm	2M25	3M25	4M25	\$142.56

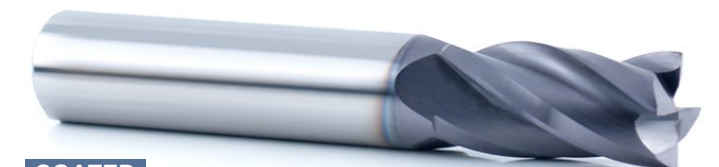

COATED

DIA	Flute Length	Overall Length	2 Flute (EDP #)	3 Flute (EDP #)	4 Flute (EDP #)	Price
1mm	4mm	38mm	2M1C	3M1C	4M1C	\$9.57
1.5mm	6mm	38mm	2M1.5C	3M1.5C	4M1.5C	\$9.44
2mm	8mm	38mm	2M2C	3M2C	4M2C	\$8.78
2.5mm	12mm	38mm	2M2.5C	3M2.5C	4M2.5C	\$8.65
3mm	12mm	38mm	2M3C	3M3C	4M3C	\$8.38
3.5mm	12mm	50mm	2M3.5C	3M3.5C	4M3.5C	\$12.41
4mm	14mm	50mm	2M4C	3M4C	4M4C	\$12.41
4.5mm	14mm	50mm	2M4.5C	3M4.5C	4M4.5C	\$12.54
5mm	16mm	63mm	2M5C	3M5C	4M5C	\$13.86
6mm	19mm	63mm	2M6C	3M6C	4M6C	\$14.19
7mm	22mm	63mm	2M7C	3M7C	4M7C	\$21.12
8mm	22mm	63mm	2M8C	3M8C	4M8C	\$22.44
9mm	22mm	63mm	2M9C	3M9C	4M9C	\$26.40
10mm	25mm	63mm	2M10C	3M10C	4M10C	\$29.04
11mm	25mm	76mm	2M11C	3M11C	4M11C	\$30.36
12mm	25mm	76mm	2M12C	3M12C	4M12C	\$37.62
14mm	32mm	88mm	2M14C	3M14C	4M14C	\$68.64
16mm	38mm	88mm	2M16C	3M16C	4M16C	\$74.58
18mm	38mm	100mm	2M18C	3M18C	4M18C	\$99.00
20mm	38mm	100mm	2M20C	3M20C	4M20C	\$145.20
22mm	38mm	100mm	2M22C	3M22C	4M22C	\$151.80
25mm	38mm	100mm	2M25C	3M25C	4M25C	\$162.36

Micrograin Carbide
Stub Length Ball Nose End Mills

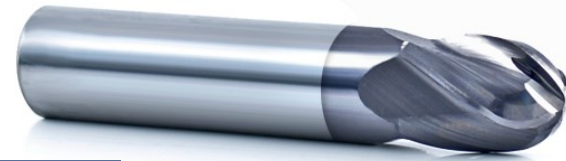
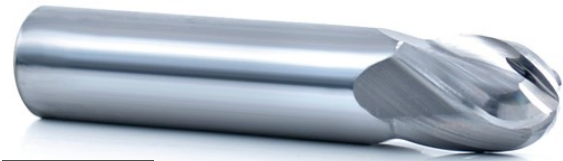

UN-COATED

DIA	Flute Length	Overall Length	2 Flute (EDP #)	3 Flute (EDP #)	4 Flute (EDP #)	Price
1/32	1/16	1 1/2	2FBS031	3FBS031	4FBS031	\$11.22
3/64	3/32	1 1/2	2FBS046	3FBS046	4FBS046	\$11.22
1/16	1/8	1 1/2	2FBS062	3FBS062	4FBS062	\$7.92
5/64	3/16	1 1/2	2FBS078	3FBS078	4FBS078	\$9.24
3/32	3/16	1 1/2	2FBS093	3FBS093	4FBS093	\$7.92
1/8	1/4	1 1/2	2FBS125	3FBS125	4FBS125	\$7.92
5/32	5/16	2	2FBS156	3FBS156	4FBS156	\$10.56
3/16	3/8	2	2FBS188	3FBS188	4FBS188	\$10.56
7/32	7/16	2	2FBS218	3FBS218	4FBS218	\$13.20
1/4	1/2	2	2FBS250	3FBS250	4FBS250	\$13.20
5/16	1/2	2	2FBS312	3FBS312	4FBS312	\$18.48
3/8	5/8	2	2FBS375	3FBS375	4FBS375	\$22.44
7/16	5/8	2 1/2	2FBS437	3FBS437	4FBS437	\$26.40
1/2	5/8	2 1/2	2FBS500	3FBS500	4FBS500	\$35.64
5/8	3/4	3	2FBS625	3FBS625	4FBS625	\$68.64
3/4	1	3	2FBS750	3FBS750	4FBS750	\$99.00

COATED

DIA	Flute Length	Overall Length	2 Flute (EDP #)	3 Flute (EDP #)	4 Flute (EDP #)	Price
1/32	1/16	1 1/2	2FBS031C	3FBS031C	4FBS031C	\$13.20
3/64	3/32	1 1/2	2FBS046C	3FBS046C	4FBS046C	\$13.20
1/16	1/8	1 1/2	2FBS062C	3FBS062C	4FBS062C	\$10.56
5/64	3/16	1 1/2	2FBS078C	3FBS078C	4FBS078C	\$10.56
3/32	3/16	1 1/2	2FBS093C	3FBS093C	4FBS093C	\$10.56
1/8	1/4	1 1/2	2FBS125C	3FBS125C	4FBS125C	\$9.90
5/32	5/16	2	2FBS156C	3FBS156C	4FBS156C	\$13.20
3/16	3/8	2	2FBS188C	3FBS188C	4FBS188C	\$11.88
7/32	7/16	2	2FBS218C	3FBS218C	4FBS218C	\$16.50
1/4	1/2	2	2FBS250C	3FBS250C	4FBS250C	\$17.16
5/16	1/2	2	2FBS312C	3FBS312C	4FBS312C	\$22.44
3/8	5/8	2	2FBS375C	3FBS375C	4FBS375C	\$27.72
7/16	5/8	2 1/2	2FBS437C	3FBS437C	4FBS437C	\$34.32
1/2	5/8	2 1/2	2FBS500C	3FBS500C	4FBS500C	\$43.56
5/8	3/4	3	2FBS625C	3FBS625C	4FBS625C	\$76.56
3/4	1	3	2FBS750C	3FBS750C	4FBS750C	\$108.24

Don't see what you need? Have a question? Call (269) 344-3041

Micrograin Carbide
Standard Ball Nose End Mills

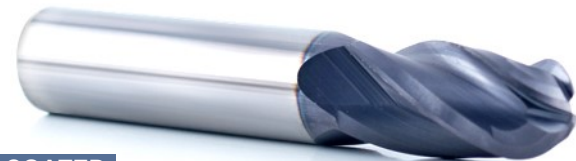

UN-COATED

DIA	Flute Length	Overall Length	2 Flute (EDP #)	3 Flute (EDP #)	4 Flute (EDP #)	Price
1/32	3/32	1 1/2	2FB031	3FB031	4FB031	\$11.04
3/64	1/8	1 1/2	2FB046	3FB046	4FB046	\$11.04
1/16	1/4	1 1/2	2FB062	3FB062	4FB062	\$11.04
5/64	1/4	1 1/2	2FB078	3FB078	4FB078	\$11.04
3/32	3/8	1 1/2	2FB093	3FB093	4FB093	\$11.04
1/8	1/2	1 1/2	2FB125	3FB125	4FB125	\$9.17
5/32	9/16	2	2FB156	3FB156	4FB156	\$14.96
3/16	5/8	2	2FB188	3FB188	4FB188	\$11.88
7/32	5/8	2 1/2	2FB218	3FB218	4FB218	\$16.71
1/4	3/4	2 1/2	2FB250	3FB250	4FB250	\$12.54
9/32	3/4	2 1/2	2FB281	3FB281	4FB281	\$22.44
5/16	7/8	2 1/2	2FB312	3FB312	4FB312	\$18.81
3/8	7/8	2 1/2	2FB375	3FB375	4FB375	\$22.77
7/16	1	3	2FB437	3FB437	4FB437	\$28.38
1/2	1	3	2FB500	3FB500	4FB500	\$38.72
9/16	11/4	3 1/2	2FB562	3FB562	4FB562	\$62.04
5/8	11/4	3 1/2	2FB625	3FB625	4FB625	\$71.28
3/4	11/2	4	2FB750	3FB750	4FB750	\$104.28
7/8	11/2	4	2FB875	3FB875	4FB875	\$165.00
1	11/2	4	2FB1000	3FB1000	4FB1000	\$179.52

COATED

DIA	Flute Length	Overall Length	2 Flute (EDP #)	3 Flute (EDP #)	4 Flute (EDP #)	Price
1/32	3/32	1 1/2	2FB031C	3FB031C	4FB031C	\$14.58
3/64	1/8	1 1/2	2FB046C	3FB046C	4FB046C	\$14.58
1/16	1/4	1 1/2	2FB062C	3FB062C	4FB062C	\$14.58
5/64	1/4	1 1/2	2FB078C	3FB078C	4FB078C	\$14.58
3/32	3/8	1 1/2	2FB093C	3FB093C	4FB093C	\$14.58
1/8	1/2	1 1/2	2FB125C	3FB125C	4FB125C	\$10.89
5/32	9/16	2	2FB156C	3FB156C	4FB156C	\$18.48
3/16	5/8	2	2FB188C	3FB188C	4FB188C	\$14.85
7/32	5/8	2 1/2	2FB218C	3FB218C	4FB218C	\$19.80
1/4	3/4	2 1/2	2FB250C	3FB250C	4FB250C	\$19.14
9/32	3/4	2 1/2	2FB281C	3FB281C	4FB281C	\$29.04
5/16	7/8	2 1/2	2FB312C	3FB312C	4FB312C	\$25.74
3/8	7/8	2 1/2	2FB375C	3FB375C	4FB375C	\$29.70
7/16	1	3	2FB437C	3FB437C	4FB437C	\$36.30
1/2	1	3	2FB500C	3FB500C	4FB500C	\$45.32
9/16	11/4	3 1/2	2FB562C	3FB562C	4FB562C	\$73.92
5/8	11/4	3 1/2	2FB625C	3FB625C	4FB625C	\$81.18
3/4	11/2	4	2FB750C	3FB750C	4FB750C	\$116.16
7/8	11/2	4	2FB875C	3FB875C	4FB875C	\$184.80
1	11/2	4	2FB1000C	3FB1000C	4FB1000C	\$198.00

Carbide & HSS End Mill Reconditioning

STD LENGTH ROUGHERS AND FINISHERS RECONDITIONING

Carbide Square End Mills

Size	OD & Ends	Price	OD & End Coated	Price	Ends Only	Price	Ends Only Coated	Price	Double End	Price	Double end coated	Price
1/8	RCSOE125	\$4.62	RCSOE125C	\$6.36	RCSE125	\$3.47	RCSE125C	\$5.78	RCSD125	\$8.09	RCSD125C	\$10.40
3/16	RCSOE188	\$5.72	RCSOE188C	\$8.09	RCSE188	\$4.51	RCSE188C	\$6.93	RCSD188	\$9.24	RCSD188C	\$11.55
1/4	RCSOE250	\$5.78	RCSOE250C	\$9.24	RCSE250	\$4.62	RCSE250C	\$8.09	RCSD250	\$10.40	RCSD250C	\$13.86
5/16	RCSOE312	\$7.22	RCSOE312C	\$9.82	RCSE312	\$5.78	RCSE312C	\$9.24	RCSD312	\$12.71	RCSD312C	\$16.17
3/8	RCSOE375	\$8.95	RCSOE375C	\$11.26	RCSE375	\$6.93	RCSE375C	\$10.98	RCSD375	\$15.02	RCSD375C	\$19.35
7/16	RCSOE437	\$10.91	RCSOE437C	\$14.96	RCSE437	\$9.24	RCSE437C	\$13.86	RCSD437	\$19.64	RCSD437C	\$24.26
1/2	RCSOE500	\$14.32	RCSOE500C	\$19.58	RCSE500	\$12.71	RCSE500C	\$18.48	RCSD500	\$25.41	RCSD500C	\$31.19
9/16	RCSOE562	\$18.48	RCSOE562C	\$26.57	RCSE562	\$16.17	RCSE562C	\$25.41	RCSD562	\$34.65	RCSD562C	\$41.58
5/8	RCSOE625	\$20.79	RCSOE625C	\$28.88	RCSE625	\$18.48	RCSE625C	\$27.72	RCSD625	\$39.27	RCSD625C	\$48.51
3/4	RCSOE750	\$25.41	RCSOE750C	\$34.65	RCSE750	\$20.79	RCSE750C	\$33.50	RCSD750	\$46.20	RCSD750C	\$58.91
7/8	RCSOE875	\$35.23	RCSOE875C	\$46.20	RCSE875	\$27.72	RCSE875C	\$42.74	RCSD875	\$63.53	RCSD875C	\$78.54
1	RCSOE1000	\$44.76	RCSOE1000C	\$57.46	RCSE1000	\$34.65	RCSE1000C	\$51.98	RCSD1000	\$80.85	RCSD1000C	\$98.18

Carbide Ballnose End Mills

Size	OD & Ends	Price	OD & End Coated	Price	Ends Only	Price	Ends Only Coated	Price	Double End	Price	Double end coated	Price
1/8	RCBOE125	\$4.91	RCBOE125C	\$6.93	RCBE125	\$3.75	RCBE125C	\$6.93	RCBD125	\$8.09	RCBD125C	\$11.26
3/16	RCBOE188	\$6.06	RCBOE188C	\$8.49	RCBE188	\$4.91	RCBE188C	\$8.09	RCBD188	\$9.24	RCBD188C	\$12.42
1/4	RCBOE250	\$6.93	RCBOE250C	\$10.40	RCBE250	\$5.78	RCBE250C	\$9.24	RCBD250	\$12.71	RCBD250C	\$13.86
5/16	RCBOE312	\$8.09	RCBOE312C	\$10.68	RCBE312	\$7.51	RCBE312C	\$10.40	RCBD312	\$15.02	RCBD312C	\$15.60
3/8	RCBOE375	\$9.24	RCBOE375C	\$11.55	RCBE375	\$8.09	RCBE375C	\$11.26	RCBD375	\$16.17	RCBD375C	\$17.91
7/16	RCBOE437	\$12.60	RCBOE437C	\$16.63	RCBE437	\$10.40	RCBE437C	\$17.33	RCBD437	\$20.79	RCBD437C	\$26.57
1/2	RCBOE500	\$15.02	RCBOE500C	\$20.22	RCBE500	\$13.86	RCBE500C	\$19.64	RCBD500	\$21.95	RCBD500C	\$31.19
9/16	RCBOE562	\$24.66	RCBOE562C	\$32.75	RCBE562	\$19.17	RCBE562C	\$33.50	RCBD562	\$45.05	RCBD562C	\$49.67
5/8	RCBOE625	\$26.97	RCBOE625C	\$34.94	RCBE625	\$21.89	RCBE625C	\$34.65	RCBD625	\$45.05	RCBD625C	\$51.98
3/4	RCBOE750	\$32.34	RCBOE750C	\$41.58	RCBE750	\$28.88	RCBE750C	\$43.89	RCBD750	\$57.75	RCBD750C	\$61.22
7/8	RCBOE875	\$42.74	RCBOE875C	\$53.71	RCBE875	\$37.54	RCBE875C	\$54.87	RCBD875	\$75.08	RCBD875C	\$80.85
1	RCBOE1000	\$53.02	RCBOE1000C	\$65.73	RCBE1000	\$46.20	RCBE1000C	\$65.73	RCBD1000	\$92.40	RCBD1000C	\$100.49

Standard HSS and Cobalt Finishing End Mills

Size	Single End	Price	Single coated	Price
3/8	RHSF375	\$4.62	RHSF375C	\$6.93
7/16	RHSF437	\$5.20	RHSF437C	\$8.09
1/2	RHSF500	\$9.24	RHSF500C	\$15.02
9/16	RHSF562	\$11.55	RHSF562C	\$17.33
5/8	RHSF625	\$13.86	RHSF625C	\$19.64
3/4	RHSF750	\$17.33	RHSF750C	\$25.41
7/8	RHSF875	\$20.79	RHSF875C	\$32.34
1	RHSF1000	\$23.10	RHSF1000C	\$34.65
1 1/8	RHSF1125	\$32.34	RHSF1125C	\$38.12
1 1/4	RHSF1250	\$35.81	RHSF1250C	\$53.13
1 3/8	RHSF1375	\$39.27	RHSF1375C	\$62.37
1 1/2	RHSF1500	\$42.74	RHSF1500C	\$65.84
1 3/4	RHSF1750	\$46.20	RHSF1750C	\$80.85
2	RHSF2000	\$51.98	RHSF2000C	\$84.32

HSS and Cobalt Roughing End Mills

Size	Single End	Price	Single end coated	Price
3/8	RCR375	\$8.09	RCR375C	\$13.86
7/16	RCR437	\$9.53	RCR437C	\$15.30
1/2	RCR500	\$9.53	RCR500C	\$15.30
9/16	RCR562	\$11.55	RCR562C	\$18.48
5/8	RCR625	\$11.55	RCR625C	\$19.64
3/4	RCR750	\$14.44	RCR750C	\$22.53
7/8	RCR875	\$20.22	RCR875C	\$29.46
1	RCR1000	\$20.22	RCR1000C	\$31.77
1 1/8	RCR1125	\$20.22	RCR1000C	\$37.54
1 1/4	RCR1250	\$28.30	RCR1250C	\$45.63
1 3/8	RCR1375	\$36.39	RCR1500C	\$62.95
1 1/2	RCR1500	\$44.47	RCR1750C	\$80.28
1 3/4	RCR1750	\$44.47	RCR1750C	\$80.28
2	RCR2000	\$52.56	RCR2000C	\$90.67

HSS Ball Nose End Mills

Size	Single End	Price	Single Coated	Price
1/4	RHSBN250	\$5.78	RHSBN250C	\$9.82
5/16	RHSBN312	\$5.78	RHSBN312C	\$10.98
3/8	RHSBN375	\$6.93	RHSBN375C	\$12.13
7/16	RHSBN437	\$8.09	RHSBN437C	\$13.86
1/2	RHSBN500	\$9.24	RHSBN500C	\$16.75
5/8	RHSBN625	\$11.55	RHSBN625C	\$19.06
3/4				

Micrograin Carbide
LollyPop Cutters

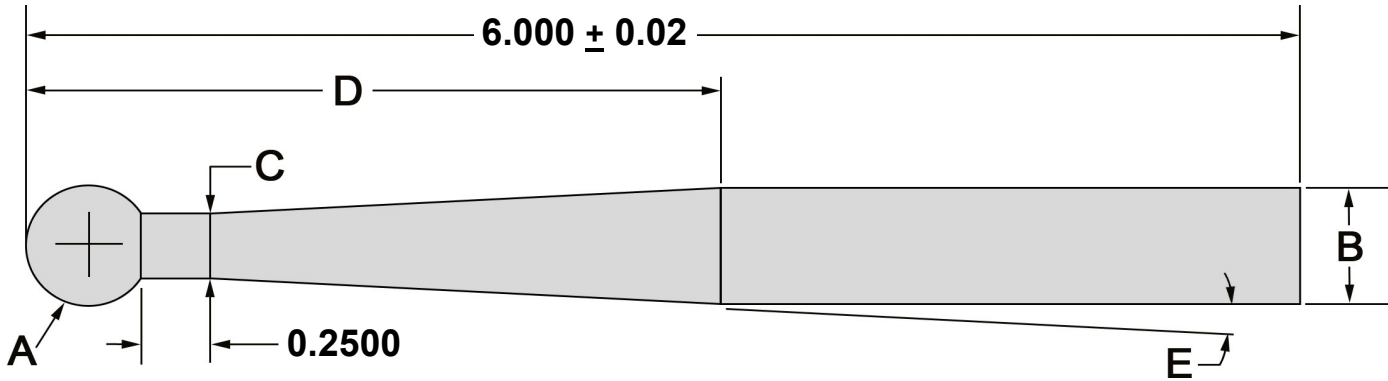

A	B	C	D	E	EDP #	Price
3/16	3/8	.200	3.0	2.0	LP375	\$231.00
1/4	1/2	.300	3.0	2.2	LP500	\$264.00
5/16	5/8	.350	3.0	4.0	LP625	\$330.00
3/8	3/4	.400	3.0	3.1	LP750	\$382.80

Can't find what you need? We can Build it!
Special Cutting Tools Available!

Micrograin Carbide
Extra Length Ball Nose End Mills



UN-COATED

DIA	Flute Length	Overall Length	2 Flute (EDP #)	3 Flute (EDP #)	4 Flute (EDP #)	Price
1/8	5/8	2	2FBL125	3FBL125	4FBL125	\$11.88
1/8	1	3	2FBXL125	3FBXL125	4FBXL125	\$17.16
3/16	1	3	2FBL188	3FBL188	4FBL188	\$19.80
3/16	1 1/8	3	2FBXL188	3FBXL188	4FBXL188	\$20.46
1/4	1	3	2FBL250	3FBL250	4FBL250	\$23.76
1/4	1 1/2	4	2FBXL250	3FBXL250	4FBXL250	\$25.08
5/16	1	3	2FBL312	3FBL312	4FBL312	\$29.04
5/16	1 5/8	4	2FBXL312	3FBXL312	4FBXL312	\$33.00
3/8	2	4	2FBL375	3FBL375	4FBL375	\$35.64
3/8	3	6	2FBXL375	3FBXL375	4FBXL375	\$48.84
7/16	2	4	2FBL437	3FBL437	4FBL437	\$49.50
7/16	3	6	2FBXL437	3FBXL437	4FBXL437	\$63.36
1/2	2	4	2FBL500	3FBL500	4FBL500	\$51.48
1/2	3	6	2FBXL500	3FBXL500	4FBXL500	\$72.60
9/16	2	5	2FBL563	3FBL563	4FBL563	\$100.32
9/16	3	6	2FBXL563	3FBXL563	4FBXL563	\$105.60
5/8	2	5	2FBL625	3FBL625	4FBL625	\$101.64
5/8	3	6	2FBXL625	3FBXL625	4FBXL625	\$105.60
3/4	2 1/4	5	2FBL750	3FBL750	4FBL750	\$168.96
3/4	3	6	2FBXL750	3FBXL750	4FBXL750	\$171.60
1	2 1/4	5	2FBL1000	3FBL1000	4FBL1000	\$198.00
1	3	6	2FBXL1000	3FBXL1000	4FBXL1000	\$231.00

COATED

DIA	Flute Length	Overall Length	2 Flute (EDP #)	3 Flute (EDP #)	4 Flute (EDP #)	Price
1/8	5/8	2	2FBL125C	3FBL125C	4FBL125C	\$14.52
1/8	1	3	2FBXL125C	3FBXL125C	4FBXL125C	\$21.12
3/16	1	3	2FBL188C	3FBL188C	4FBL188C	\$22.44
3/16	1 1/8	3	2FBXL188C	3FBXL188C	4FBXL188C	\$23.76
1/4	1	3	2FBL250C	3FBL250C	4FBL250C	\$27.72
1/4	1 1/2	4	2FBXL250C	3FBXL250C	4FBXL250C	\$30.36
5/16	1	3	2FBL312C	3FBL312C	4FBL312C	\$35.64
5/16	1 5/8	4	2FBXL312C	3FBXL312C	4FBXL312C	\$39.60
3/8	2	4	2FBL375C	3FBL375C	4FBL375C	\$44.88
3/8	3	6	2FBXL375C	3FBXL375C	4FBXL375C	\$59.40
7/16	2	4	2FBL437C	3FBL437C	4FBL437C	\$59.40
7/16	3	6	2FBXL437C	3FBXL437C	4FBXL437C	\$77.88
1/2	2	4	2FBL500C	3FBL500C	4FBL500C	\$60.72
1/2	3	6	2FBXL500C	3FBXL500C	4FBXL500C	\$79.20
9/16	2	5	2FBL563C	3FBL563C	4FBL563C	\$105.60
9/16	3	6	2FBXL563C	3FBXL563C	4FBXL563C	\$112.20
5/8	2	5	2FBL625C	3FBL625C	4FBL625C	\$113.52
5/8	3	6	2FBXL625C	3FBXL625C	4FBXL625C	\$118.80
3/4	2 1/4	5	2FBL750C	3FBL750C	4FBL750C	\$190.08
3/4	3	6	2FBXL750C	3FBXL750C	4FBXL750C	\$191.40
1	2 1/4	5	2FBL1000C	3FBL1000C	4FBL1000C	\$221.76
1	3	6	2FBXL1000C	3FBXL1000C	4FBXL1000C	\$254.76

Micrograin Carbide
Metric Ball Nose End Mills

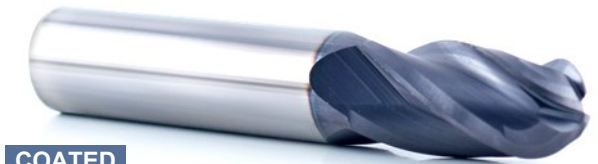
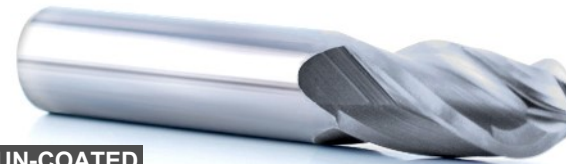

UN-COATED

DIA	Flute Length	Overall Length	2 Flute (EDP #)	3 Flute (EDP #)	4 Flute (EDP #)	Price
1mm	4mm	38mm	2MB1	3MB1	4MB1	\$10.56
1.5mm	6mm	38mm	2MB1.5	3MB1.5	4MB1.5	\$10.03
2mm	8mm	38mm	2MB2	3MB2	4MB2	\$9.57
2.5mm	12mm	38mm	2MB2.5	3MB2.5	4MB2.5	\$9.57
3mm	12mm	38mm	2MB3	3MB3	4MB3	\$9.24
3.5mm	12mm	50mm	2MB3.5	3MB3.5	4MB3.5	\$11.88
4mm	14mm	50mm	2MB4	3MB4	4MB4	\$11.88
4.5mm	14mm	50mm	2MB4.5	3MB4.5	4MB4.5	\$12.54
5mm	16mm	63mm	2MB5	3MB5	4MB5	\$13.86
6mm	19mm	63mm	2MB6	3MB6	4MB6	\$13.99
7mm	22mm	63mm	2MB7	3MB7	4MB7	\$18.48
8mm	22mm	63mm	2MB8	3MB8	4MB8	\$19.80
9mm	22mm	63mm	2MB9	3MB9	4MB9	\$21.98
10mm	25mm	63mm	2MB10	3MB10	4MB10	\$27.06
11mm	25mm	76mm	2MB11	3MB11	4MB11	\$28.38
12mm	25mm	76mm	2MB12	3MB12	4MB12	\$40.92
14mm	32mm	88mm	2MB14	3MB14	4MB14	\$67.32
16mm	38mm	88mm	2MB16	3MB16	4MB16	\$71.28
18mm	38mm	100mm	2MB18	3MB18	4MB18	\$101.64
20mm	38mm	100mm	2MB20	3MB20	4MB20	\$147.84
22mm	38mm	100mm	2MB22	3MB22	4MB22	\$154.44
25mm	38mm	100mm	2MB25	3MB25	4MB25	\$168.96

COATED

DIA	Flute Length	Overall Length	2 Flute (EDP #)	3 Flute (EDP #)	4 Flute (EDP #)	Price
1mm	4mm	38mm	2MB1C	3MB1C	4MB1C	\$13.20
1.5mm	6mm	38mm	2MB1.5C	3MB1.5C	4MB1.5C	\$13.20
2mm	8mm	38mm	2MB2C	3MB2C	4MB2C	\$13.20
2.5mm	12mm	38mm	2MB2.5C	3MB2.5C	4MB2.5C	\$12.54
3mm	12mm	38mm	2MB3C	3MB3C	4MB3C	\$11.88
3.5mm	12mm	50mm	2MB3.5C	3MB3.5C	4MB3.5C	\$15.84
4mm	14mm	50mm	2MB4C	3MB4C	4MB4C	\$14.52
4.5mm	14mm	50mm	2MB4.5C	3MB4.5C	4MB4.5C	\$18.48
5mm	16mm	63mm	2MB5C	3MB5C	4MB5C	\$19.14
6mm	19mm	63mm	2MB6C	3MB6C	4MB6C	\$19.80
7mm	22mm	63mm	2MB7C	3MB7C	4MB7C	\$26.40
8mm	22mm	63mm	2MB8C	3MB8C	4MB8C	\$27.72
9mm	22mm	63mm	2MB9C	3MB9C	4MB9C	\$31.68
10mm	25mm	63mm	2MB10C	3MB10C	4MB10C	\$36.96
11mm	25mm	76mm	2MB11C	3MB11C	4MB11C	\$38.28
12mm	25mm	76mm	2MB12C	3MB12C	4MB12C	\$54.12
14mm	32mm	88mm	2MB14C	3MB14C	4MB14C	\$77.88
16mm	38mm	88mm	2MB16C	3MB16C	4MB16C	\$84.48
18mm	38mm	100mm	2MB18C	3MB18C	4MB18C	\$121.44
20mm	38mm	100mm	2MB20C	3MB20C	4MB20C	\$165.00
22mm	38mm	100mm	2MB22C	3MB22C	4MB22C	\$182.16
25mm	38mm	100mm	2MB25C	3MB25C	4MB25C	\$188.76

Micrograin Carbide
Diamond Coated CVD End Mills



DIA.	SHANK	O.A.L.	L.O.C.	REACH	STYLE	EDP #	Price
1/8"	1/8"	3"	1/8"	5/8"	.020 Corner Radius	4FD125.02R	\$85.80
1/8"	1/8"	3"	1/8"	5/8"	Ball Nose	4FD125.BN	\$85.80
1/8"	1/8"	3"	1/8"	5/8"	Square	4FD125.SQ	\$79.20
1/4"	1/4"	4"	1/4"	1 1/4"	.020 Corner Radius	4FD250.02R	\$129.36
1/4"	1/4"	4"	1/4"	1 1/4"	.030 Corner Radius	4FD250.03R	\$129.36
1/4"	1/4"	4"	1/4"	1 1/4"	Ball Nose	4FD250.BN	\$129.36
1/4"	1/4"	4"	1/4"	1 1/4"	Square	4FD250.SQ	\$121.44
3/8"	3/8"	4"	3/8"	1 3/8"	.030 Corner Radius	4FD375.03R	\$178.20
3/8"	3/8"	4"	3/8"	1 3/8"	.060 Corner Radius	4FD375.06R	\$178.20
3/8"	3/8"	4"	3/8"	1 3/8"	Ball Nose	4FD375.BN	\$178.20
3/8"	3/8"	4"	3/8"	1 3/8"	Square	4FD375.SQ	\$165.00
1/2"	1/2"	4"	1/2"	1 1/2"	.030 Corner Radius	4FD500.03R	\$231.00
1/2"	1/2"	4"	1/2"	1 1/2"	.060 Corner Radius	4FD500.06R	\$231.00
1/2"	1/2"	4"	1/2"	1 1/2"	Ball Nose	4FD500.BN	\$231.00
1/2"	1/2"	4"	1/2"	1 1/2"	Square	4FD500.SQ	\$217.80

Micrograin Carbide
Tapered Square End Mills



UN-COATED						
SHANK DIA.	TYPE	TIP DIA.	LOC.	OAL	3 Flute (EDP #)	Price
1/4	1 deg	1/8	1 1/2	3	3T2501	\$29.04
1/4	1.5 deg	1/8	1 1/2	3	3T25015	\$29.04
1/4	2 deg	1/8	1	3	3T2502	\$29.04
1/4	3 deg	1/8	1	3	3T2503	\$29.04
1/4	5 deg	1/8	3/4	3	3T2505	\$29.04
5/16	3 deg	5/32	1 1/4	3	3T3123	\$39.60
3/8	1 deg	3/16	1 3/4	3 1/2	3T3751	\$39.60
3/8	1.5 deg	3/16	1 3/4	3 1/2	3T37515	\$39.60
3/8	2 deg	3/16	1 3/4	3 1/2	3T3752	\$39.60
1/2	3 deg	1/4	2	4	3T5003	\$52.80
1/2	5 deg	1/4	1 1/4	4	3T5005	\$52.80
1/2	7 deg	3/16	1 1/4	4	3T5007	\$52.80

COATED						
SHANK DIA.	TYPE	TIP DIA.	LOC.	OAL	3 Flute (EDP #)	Price
1/4	1 deg	1/8	1 1/2	3	3T2501C	\$34.32
1/4	1.5 deg	1/8	1 1/2	3	3T25015C	\$34.32
1/4	2 deg	1/8	1	3	3T2502C	\$34.32
1/4	3 deg	1/8	1	3	3T2503C	\$34.32
1/4	5 deg	1/8	3/4	3	3T2505C	\$34.32
5/16	3 deg	5/32	1 1/4	3	3T3123C	\$46.20
3/8	1 deg	3/16	1 3/4	3 1/2	3T3751C	\$47.52
3/8	1.5 deg	3/16	1 3/4	3 1/2	3T37515C	\$47.52
3/8	2 deg	3/16	1 3/4	3 1/2	3T3752C	\$62.04
1/2	3 deg	1/4	2	4	3T5003C	\$62.04
1/2	5 deg	1/4	1 1/4	4	3T5005C	\$62.04
1/2	7 deg	3/16	1 1/4	4	3T5007C	\$62.04

Micrograin Carbide
Tapered Ball Nose End Mills



UN-COATED						
SHANK DIA.	TYPE	TIP DIA.	LOC.	OAL	3 Flute (EDP #)	Price
1/4	1 deg	1/8	1 1/2	3	3TB2501	\$33.00
1/4	1.5 deg	1/8	1 1/2	3	3TB25015	\$33.00
1/4	2 deg	1/8	1	3	3TB2502	\$33.00
1/4	3 deg	1/8	1	3	3TB2503	\$33.00
1/4	5 deg	1/8	3/4	3	3TB2505	\$33.00
1/4	7 deg	1/8	1/2	3	3TB2507	\$33.00
3/8	1 deg	3/16	1 3/4	3 1/2	3TB3751	\$44.88
3/8	1.5 deg	3/16	1 3/4	3 1/2	3TB37515	\$44.88
3/8	2 deg	3/16	1 3/4	3 1/2	3TB3752	\$44.88
3/8	3 deg	3/16	1 3/4	3 1/2	3TB3753	\$44.88
3/8	5 deg	1/8	1 1/2	3 1/2	3TB3755	\$44.88
3/8	7 deg	5/32	3/4	3 1/2	3TB3757	\$44.88
1/2	3 deg	1/4	2	4	3TB5003	\$59.40
1/2	5 deg	1/4	1 1/4	4	3TB5005	\$59.40
1/2	7 deg	3/16	1 1/4	4	3TB5007	\$59.40

COATED						
SHANK DIA.	TYPE	TIP DIA.	LOC.	OAL	3 Flute (EDP #)	Price
1/4	1 deg	1/8	1 1/2	3	3TB2501C	\$38.28
1/4	1.5 deg	1/8	1 1/2	3	3TB25015C	\$38.28
1/4	2 deg	1/8	1	3	3TB2502C	\$38.28
1/4	3 deg	1/8	1	3	3TB2503C	\$38.28
1/4	5 deg	1/8	3/4	3	3TB2505C	\$38.28
1/4	7 deg	1/8	1/2	3	3TB2507C	\$38.28
3/8	1 deg	3/16	1 3/4	3 1/2	3TB3751C	\$52.80
3/8	1.5 deg	3/16	1 3/4	3 1/2	3TB37515C	\$52.80
3/8	2 deg	3/16	1 3/4	3 1/2	3TB3752C	\$52.80
3/8	3 deg	3/16	1 3/4	3 1/2	3TB3753C	\$52.80
3/8	5 deg	1/8	1 1/2	3 1/2	3TB3755C	\$52.80
3/8	7 deg	5/32	3/4	3 1/2	3TB3757C	\$52.80
1/2	3 deg	1/4	2	4	3TB5003C	\$68.64
1/2	5 deg	1/4	1 1/4	4	3TB5005C	\$68.64
1/2	7 deg	3/16	1 1/4	4	3TB5007C	\$68.64

Don't See What You Need? Fax the form below and we will make it for you!

Angle (A) _____ Length Of Taper (B) _____ OAL (C) _____ Dia. (D) _____

Flat Location (E) _____ (F) _____ (G) _____ Tip Dia. (H) _____

Type: Square Ballnose Corner Radius

Material H.S.S. Carbide Cobalt

Quantity _____ Due Date _____ (Fax to: (269) 344-6368)

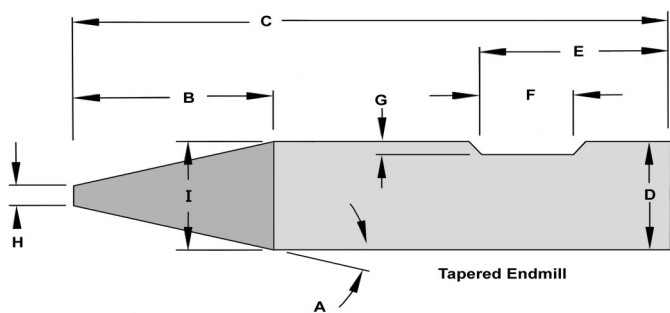

Tapered Endmill

Micrograin Carbide
Extended Reach Ball Nose Clearance Cutters



PART #	A	B	C	D	E	F	G	Price
2BCL04043.0.375	0.100	0.040	0.100	3.0	0.375	4.0	BN	\$72.27
2BCL04045.0.375	0.100	0.040	0.100	5.0	0.375	4.0	BN	\$72.27
2BCL06043.0.375	0.100	0.060	0.100	3.0	0.375	4.0	BN	\$68.31
2BCL06045.0.375	0.100	0.060	0.100	5.0	0.375	4.0	BN	\$68.31
2BCL06063.0.375	0.100	0.060	0.100	3.0	0.375	6.0	BN	\$80.19
2BCL06065.0.375	0.100	0.060	0.100	5.0	0.375	6.0	BN	\$80.19
2BCL08043.0.375	0.100	0.080	0.100	3.0	0.375	4.0	BN	\$64.35
2BCL08045.0.375	0.100	0.080	0.100	5.0	0.375	4.0	BN	\$64.35
2BCL08063.0.375	0.100	0.080	0.100	3.0	0.375	6.0	BN	\$75.90
2BCL08065.0.375	0.100	0.080	0.100	5.0	0.375	6.0	BN	\$75.90
2BCL12543.0.375	0.125	0.125	0.100	3.0	0.375	4.0	BN	\$64.35
2BCL12545.0.375	0.125	0.125	0.100	5.0	0.375	4.0	BN	\$64.35
2BCL12563.0.375	0.125	0.125	0.100	3.0	0.375	6.0	BN	\$76.23
2BCL12565.0.375	0.125	0.125	0.100	5.0	0.375	6.0	BN	\$76.23
2BCL18743.0.375	0.187	0.187	0.250	3.0	0.375	4.0	BN	\$64.35
2BCL18745.0.375	0.187	0.187	0.250	5.0	0.375	4.0	BN	\$64.35
2BCL18763.0.375	0.187	0.187	0.250	3.0	0.375	6.0	BN	\$76.23
2BCL18765.0.375	0.187	0.187	0.250	5.0	0.375	6.0	BN	\$76.23
2BCL25043.0.375	0.250	0.250	0.250	3.0	0.375	4.0	BN	\$65.34
2BCL25045.0.375	0.250	0.250	0.250	5.0	0.375	4.0	BN	\$65.34
2BCL25063.0.375	0.250	0.250	0.250	3.0	0.375	6.0	BN	\$77.22
2BCL25065.0.375	0.250	0.250	0.250	5.0	0.375	6.0	BN	\$77.22

ALL TOOLS 2 FLUTE BALLNOSE AND SPECIALLY DESIGNED FOR MOLD AND DIE INDUSTRY

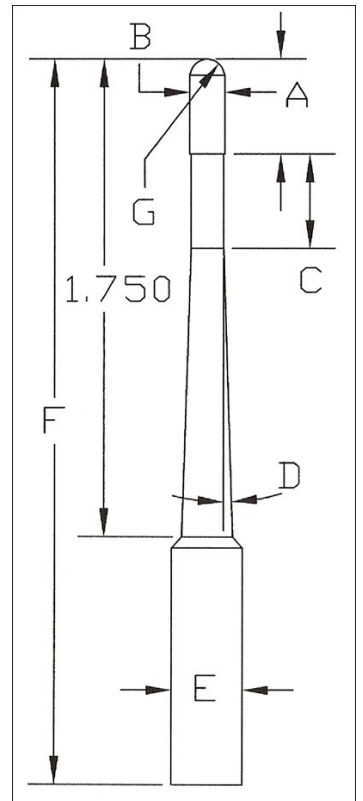

Micrograin Carbide
Clearance Cutters

PART #	A	B	C	D	E	F	Price
2BCL03045.0	0.030	0.030	5.0	0.125	3.0	BN	\$37.62
2BCL03148.0	0.031	0.031	8.0	0.250	4.0	BN	\$37.62
2BCL06045.0	0.060	0.060	5.0	0.125	3.0	BN	\$36.96
2BCL06248.0	0.062	0.062	8.0	0.250	4.0	BN	\$36.96
2BCL08045.0	0.080	0.080	5.0	0.125	3.0	BN	\$36.30
2BCL09348.0	0.093	0.093	8.0	0.250	4.0	BN	\$36.30
2FCL09348.0	0.093	0.093	8.0	0.250	4.0	0.01	\$36.30
2BCL12545.0	0.125	0.125	5.0	0.250	4.0	BN	\$35.64
2FCL12545.0	0.125	0.125	5.0	0.250	4.0	0.02	\$35.64
2BCL18745.0	0.187	0.500	5.0	0.250	4.0	BN	\$34.98
2FCL18745.0	0.187	0.500	5.0	0.250	4.0	0.031	\$34.98
2BCL25040.0	0.250	0.500	0.0	0.250	4.0	BN	\$33.66
2FCL25040.0	0.250	0.500	0.0	0.250	4.0	0.031	\$33.66
2FCL31240.0	0.312	0.625	0.0	0.312	4.0	0.031	\$37.62
2BCL31240.0	0.312	0.625	0.0	0.312	4.0	BN	\$37.62
2BCL37540.0	0.375	0.750	0.0	0.375	4.0	BN	\$41.58
2FCL37540.0	0.375	0.750	0.0	0.375	4.0	0.031	\$41.58

ALL TOOLS 2 FLUTE AND SPECIALLY DESIGNED FOR MOLD AND DIE INDUSTRY

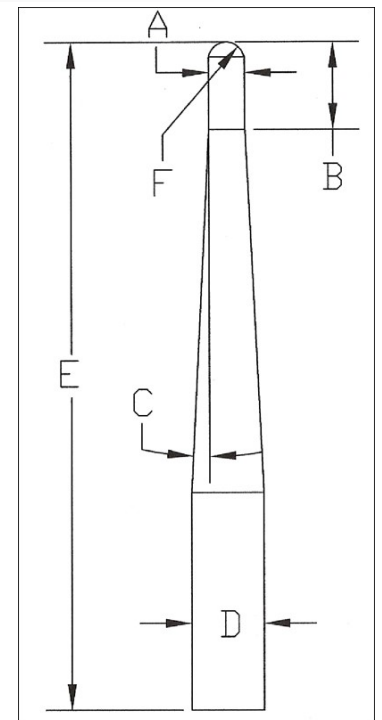

Don't see what you need? Have a question? Call (269) 344-3041

Micrograin Carbide
Extended Reach Micro End Mills

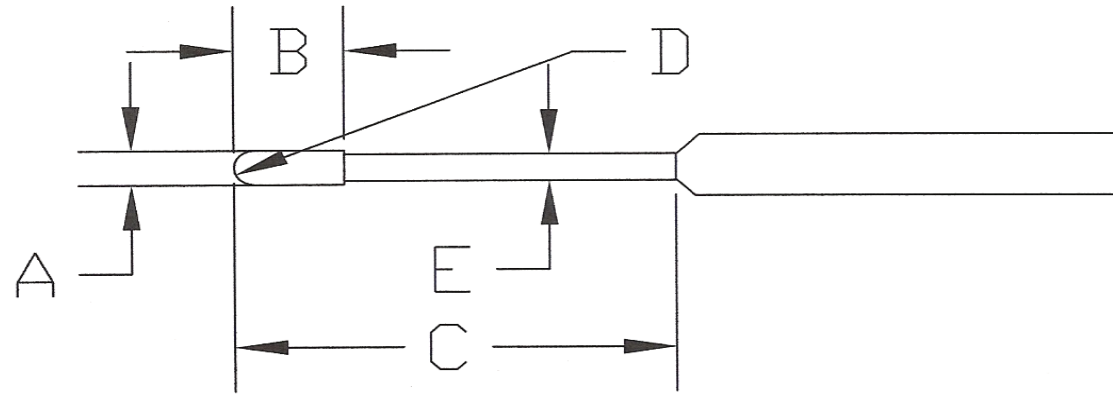

PART #	A	B	C	D	E	F	Price
4FER031BN.437	.031 DIA	0.062	0.437	BALL	0.026	1/8" x 3"	\$29.04
4FER031BN.750	.031 DIA	0.062	0.750	BALL	0.026	1/8" x 3"	\$33.00
4FER047BN.625	.047 DIA	0.093	0.625	BALL	0.040	1/8" x 3"	\$29.04
4FER047BN.1.0	.047 DIA	0.093	1.000	BALL	0.040	1/8" x 3"	\$33.00
4FER062BN.750	.062 DIA	0.125	0.750	BALL	0.055	1/8" x 3"	\$29.04
4FER062BN.1.25	.062 DIA	0.125	1.250	BALL	0.055	1/8" x 3"	\$34.32
4FER078BN.750	.078 DIA	0.187	0.750	BALL	0.070	1/8" x 3"	\$29.70
4FER078BN.1.25	.078 DIA	0.187	1.250	BALL	0.070	1/8" x 3"	\$33.66
4FER093BN.1.00	.093 DIA	0.187	1.000	BALL	0.085	1/8" x 3"	\$29.70
4FER093BN.1.50	.093 DIA	0.187	1.500	BALL	0.085	1/8" x 3"	\$33.66
4FER125BN.1.00	.125 DIA	0.250	1.000	BALL	0.115	1/8" x 3"	\$29.70
4FER125BN.2.00	.125 DIA	0.250	2.000	BALL	0.115	1/8" x 3"	\$33.66
4FER031SQ.437	.031 DIA	0.062	0.437	SQUARE	0.026	1/8" x 3"	\$27.06
4FER031SQ.750	.031 DIA	0.062	0.750	SQUARE	0.026	1/8" x 3"	\$31.02
4FER047SQ.625	.047 DIA	0.093	0.625	SQUARE	0.040	1/8" x 3"	\$27.06
4FER047SQ.1.0	.047 DIA	0.093	1.000	SQUARE	0.040	1/8" x 3"	\$31.02
4FER062SQ.750	.062 DIA	0.125	0.750	SQUARE	0.055	1/8" x 3"	\$27.06
4FER062SQ.1.25	.062 DIA	0.125	1.250	SQUARE	0.055	1/8" x 3"	\$32.34
4FER078SQ.750	.078 DIA	0.187	0.750	SQUARE	0.070	1/8" x 3"	\$31.68
4FER078SQ.1.25	.078 DIA	0.187	1.250	SQUARE	0.070	1/8" x 3"	\$35.64
4FER093SQ.1.00	.093 DIA	0.187	1.000	SQUARE	0.085	1/8" x 3"	\$31.68
4FER093SQ.1.50	.093 DIA	0.187	1.500	SQUARE	0.085	1/8" x 3"	\$35.64
4FER125SQ.1.00	.125 DIA	0.250	1.000	SQUARE	0.115	1/8" x 3"	\$31.68
4FER125SQ.2.00	.125 DIA	0.250	2.000	SQUARE	0.115	1/8" x 3"	\$35.64
4FER031.005R.437	.031 DIA	0.062	0.437	.005 RAD	0.026	1/8" x 3"	\$29.04
4FER031.005R.750	.031 DIA	0.062	0.750	.005 RAD	0.026	1/8" x 3"	\$33.00
4FER047.005R.625	.047 DIA	0.093	0.625	.005 RAD	0.040	1/8" x 3"	\$29.04
4FER047.005R.1.0	.047 DIA	0.093	1.000	.005 RAD	0.040	1/8" x 3"	\$33.00
4FER062.010R.750	.062 DIA	0.125	0.750	.010 RAD	0.055	1/8" x 3"	\$29.04
4FER062.010R.1.25	.062 DIA	0.125	1.250	.010 RAD	0.055	1/8" x 3"	\$34.32
4FER078.010R.750	.078 DIA	0.187	0.750	.010 RAD	0.070	1/8" x 3"	\$24.20
4FER078.010R.1.25	.078 DIA	0.187	1.250	.010 RAD	0.070	1/8" x 3"	\$27.50
4FER093.010R.1.00	.093 DIA	0.187	1.000	.010 RAD	0.085	1/8" x 3"	\$24.20
4FER093.010R.1.50	.093 DIA	0.187	1.500	.010 RAD	0.085	1/8" x 3"	\$27.50
4FER125.010R.1.00	.125 DIA	0.250	1.000	.010 RAD	0.115	1/8" x 3"	\$24.20
4FER125.010R.2.00	.125 DIA	0.250	2.000	.010 RAD	0.115	1/8" x 3"	\$28.60

Micrograin Carbide
Corner Radius End Mills 4 Flute

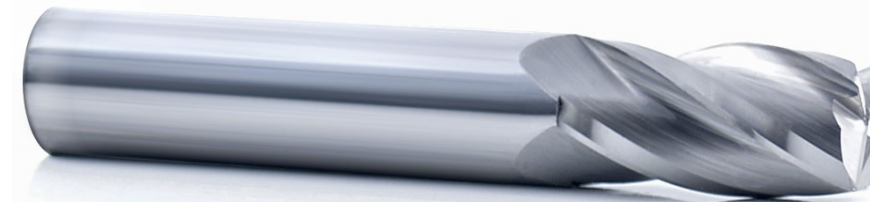

Also available in 2 or 3 flute upon request

Flute Dia.	Corner Radius	Flute Length	Shank Dia.	Overall Length	EDP# Un-Coated	Un-Coated Price	EDP# Coated	Coated Price
1/8	0.015	1/2	1/8	1 1/2	4FCR125015	\$9.17	4FCR125015C	\$10.89
1/8	0.02	1/2	1/8	1 1/2	4FCR125020	\$9.17	4FCR125020C	\$10.89
3/16	0.015	5/8	3/16	2	4FCR188015	\$11.88	4FCR188015C	\$14.85
3/16	0.02	5/8	3/16	2	4FCR188020	\$11.88	4FCR188020C	\$14.85
3/16	0.03	5/8	3/16	2	4FCR188030	\$11.88	4FCR188030C	\$14.85
1/4	0.015	3/4	1/4	2 1/2	4FCR250015	\$12.54	4FCR250015C	\$19.14
1/4	0.02	3/4	1/4	2 1/2	4FCR250020	\$12.54	4FCR250020C	\$19.14
1/4	0.03	3/4	1/4	2 1/2	4FCR250030	\$12.54	4FCR250030C	\$19.14
5/16	0.015	7/8	5/16	2 1/2	4FCR312015	\$18.81	4FCR312015C	\$25.74
5/16	0.02	7/8	5/16	2 1/2	4FCR312020	\$18.81	4FCR312020C	\$25.74
5/16	0.03	7/8	5/16	2 1/2	4FCR312030	\$18.81	4FCR312030C	\$25.74
5/16	0.045	7/8	5/16	2 1/2	4FCR312045	\$18.81	4FCR312045C	\$25.74
3/8	0.015	7/8	3/8	2 1/2	4FCR375015	\$22.77	4FCR375015C	\$29.70
3/8	0.02	7/8	3/8	2 1/2	4FCR375020	\$22.77	4FCR375020C	\$29.70
3/8	0.03	7/8	3/8	2 1/2	4FCR375030	\$22.77	4FCR375030C	\$29.70
3/8	0.045	7/8	3/8	2 1/2	4FCR375045	\$22.77	4FCR375045C	\$29.70
1/2	0.015	1	1/2	3	4FCR500015	\$38.72	4FCR500015C	\$45.32
1/2	0.02	1	1/2	3	4FCR500020	\$38.72	4FCR500020C	\$45.32
1/2	0.03	1	1/2	3	4FCR500030	\$38.72	4FCR500030C	\$45.32
1/2	0.045	1	1/2	3	4FCS500045	\$38.72	4FCS500045C	\$45.32
1/2	0.06	1	1/2	3	4FCR500060	\$38.72	4FCR500060C	\$45.32
5/8	0.015	1 1/4	5/8	3 1/2	4FCR625015	\$71.28	4FCR625015C	\$81.18
5/8	0.02	1 1/4	5/8	3 1/2	4FCR625020	\$71.28	4FCR625020C	\$81.18
5/8	0.03	1 1/4	5/8	3 1/2	4FCR625030	\$71.28	4FCR625030C	\$81.18
5/8	0.045	1 1/4	5/8	3 1/2	4FCR625045	\$71.28	4FCR625045C	\$81.18
5/8	0.06	1 1/4	5/8	3 1/2	4FCR625060	\$71.28	4FCR625060C	\$81.18
5/8	0.09	1 1/4	5/8	3 1/2	4FCR625090	\$71.28	4FCR625090C	\$81.18
3/4	0.015	1 1/2	3/4	4	4FCR750015	\$109.28	4FCR750015C	\$116.16
3/4	0.02	1 1/2	3/4	4	4FCR750020	\$109.28	4FCR750120C	\$116.16
3/4	0.03	1 1/2	3/4	4	4FCR750030	\$109.28	4FCR750030C	\$116.16
3/4	0.045	1 1/2	3/4	4	4FCR750045	\$109.28	4FCR750045C	\$116.16
3/4	0.06	1 1/2	3/4	4	4FCR750060	\$109.28	4FCR750060C	\$116.16
3/4	0.09	1 1/2	3/4	4	4FCR750090	\$109.28	4FCR750090C	\$116.16
3/4	0.125	1 1/2	3/4	4	4FCR750125	\$109.28	4FCR750125C	\$116.16
1	0.015	1 1/2	1	4	4FCR1000015	\$179.52	4FCR1000015C	\$198.00
1	0.02	1 1/2	1	4	4FCR1000020	\$179.52	4FCR1000020C	\$198.00
1	0.03	1 1/2	1	4	4FCR1000030	\$179.52	4FCR1000030C	\$198.00
1	0.045	1 1/2	1	4	4FCR1000045	\$179.52	4FCR1000045C	\$198.00
1	0.06	1 1/2	1	4	4FCR1000060	\$179.52	4FCR1000060C	\$198.00
1	0.09	1 1/2	1	4	4FCR1000090	\$179.52	4FCR1000090C	\$198.00
1	0.125	1 1/2	1	4	4FCR1000125	\$179.52	4FCR1000125C	\$198.00

Don't See What You Need?

Fax us the form below and we Will make it for you....Fast!

Company _____
 Name _____
 Phone _____
 Email _____
 Fax _____
 Diameter (A) _____ Flute Length (B) _____
 OAL (C) _____ Radius (D) _____
 Flat Location (E) _____ (F) _____ (G) _____
 Material: H.S.S. ___ Carbide ___ Cobalt ___
 Quantity _____ Due Date _____

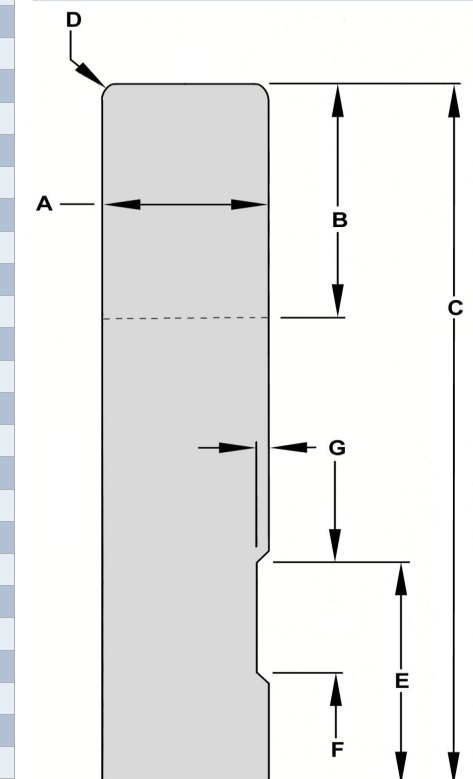

HIGH PERFORMANCE END MILLS

Micrograin Carbide 2 Flute 45 Deg Helix w/ Sharp Corners End Mills

Polished OD Margins Reduces Chatter

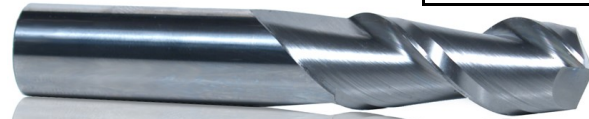

UN-COATED

DIA	LOC	Overall Length	EDP #	Price
1/8"	1/2"	1-1/2"	2FHL125	\$9.90
3/16"	5/8"	2"	2FHL188	\$11.88
1/4"	1/2"	2"	2FHL250S	\$13.20
1/4"	3/4"	2-1/2"	2FHL250	\$14.72
1/4"	1 1/4"	3"	2FHL250L	\$17.36
3/8"	1/2"	2"	2FHL375S	\$21.12
3/8"	1"	2-1/2"	2FHL375	\$26.07
3/8"	1 1/2"	3-1/2"	2FHL375L	\$37.62
1/2"	5/8"	2-1/2"	2FHL500S	\$33.79
1/2"	1"	3"	2FHL500	\$36.43
1/2"	2"	4"	2FHL500L	\$51.48
5/8"	3/4"	3"	2FHL625S	\$62.04
5/8"	1 1/4"	3-1/2"	2FHL625	\$73.92
5/8"	2 1/2"	6"	2FHL625L	\$105.60
3/4"	1"	3"	2FHL750S	\$96.36
3/4"	1 1/2"	4"	2FHL750	\$106.92
3/4"	3"	6"	2FHL750L	\$161.04
1.0"	1"	3"	2FHL1000S	\$170.28
1.0"	1 1/2"	4"	2FHL1000	\$186.12
1.0"	3"	6"	2FHL1000L	\$303.60



COATED

DIA	LOC	Overall Length	EDP #	Price
1/8"	1/2"	1-1/2"	2FHL125C	\$10.56
3/16"	5/8"	2"	2FHL188C	\$12.94
1/4"	1/2"	2"	2FHL250SC	\$14.92
1/4"	3/4"	2-1/2"	2FHL250C	\$17.16
1/4"	1 1/4"	3"	2FHL250LC	\$19.80
3/8"	1/2"	2"	2FHL375SC	\$23.76
3/8"	1"	2-1/2"	2FHL375C	\$29.70
3/8"	1 1/2"	3-1/2"	2FHL375LC	\$42.24
1/2"	5/8"	2-1/2"	2FHL500SC	\$38.28
1/2"	1"	3"	2FHL500C	\$40.92
1/2"	2"	4"	2FHL500LC	\$56.76
5/8"	3/4"	3"	2FHL625SC	\$66.00
5/8"	1 1/4"	3-1/2"	2FHL625C	\$79.20
5/8"	2 1/2"	6"	2FHL625LC	\$116.16
3/4"	1"	3"	2FHL750SC	\$102.96
3/4"	1 1/2"	4"	2FHL750C	\$112.20
3/4"	3"	6"	2FHL750LC	\$171.60
1.0"	1"	3"	2FHL1000SC	\$178.20
1.0"	1 1/2"	4"	2FHL1000C	\$191.40
1.0"	3"	6"	2FHL1000LC	\$316.80

Corner Radius Available At Extra Cost

Micrograin Carbide 3 Flute 45 Deg Helix w/Sharp Corners End Mills

Polished OD Margins Reduces Chatter

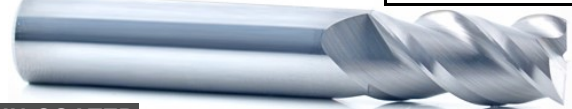

UN-COATED

DIA	LOC	Overall Length	EDP #	Price
1/8"	1/2"	1-1/2"	3FHL125	\$9.90
3/16"	5/8"	2"	3FHL188	\$11.88
1/4"	1/2"	2"	3FHL250S	\$13.20
1/4"	3/4"	2-1/2"	3FHL250	\$14.72
1/4"	1 1/4"	3"	3FHL250L	\$17.36
3/8"	1/2"	2"	3FHL375S	\$21.12
3/8"	1"	2-1/2"	3FHL375	\$26.07
3/8"	1 1/2"	3-1/2"	3FHL375L	\$37.62
1/2"	5/8"	2-1/2"	3FHL500S	\$33.79
1/2"	1"	3"	3FHL500	\$36.43
1/2"	2"	4"	3FHL500L	\$51.48
5/8"	3/4"	3"	3FHL625S	\$62.04
5/8"	1 1/4"	3-1/2"	3FHL625	\$73.92
5/8"	2 1/2"	6"	3FHL625L	\$105.60
3/4"	1"	3"	3FHL750S	\$96.36
3/4"	1 1/2"	4"	3FHL750	\$106.92
3/4"	3"	6"	3FHL750L	\$161.04
1.0"	1"	3"	3FHL1000S	\$170.28
1.0"	1 1/2"	4"	3FHL1000	\$186.12
1.0"	3"	6"	3FHL1000L	\$303.60

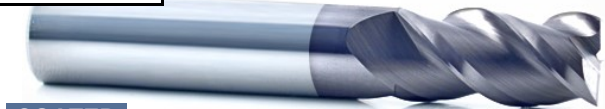

COATED

DIA	LOC	Overall Length	EDP #	Price
1/8"	1/2"	1-1/2"	3FHL125C	\$10.56
3/16"	5/8"	2"	3FHL188C	\$12.94
1/4"	1/2"	2"	3FHL250SC	\$14.92
1/4"	3/4"	2-1/2"	3FHL250C	\$17.16
1/4"	1 1/4"	3"	3FHL250LC	\$19.80
3/8"	1/2"	2"	3FHL375SC	\$23.76
3/8"	1"	2-1/2"	3FHL375C	\$29.70
3/8"	1 1/2"	3-1/2"	3FHL375LC	\$42.24
1/2"	5/8"	2-1/2"	3FHL500SC	\$38.28
1/2"	1"	3"	3FHL500C	\$40.92
1/2"	2"	4"	3FHL500LC	\$56.76
5/8"	3/4"	3"	3FHL625SC	\$66.00
5/8"	1 1/4"	3-1/2"	3FHL625C	\$79.20
5/8"	2 1/2"	6"	3FHL625LC	\$116.16
3/4"	1"	3"	3FHL750SC	\$102.96
3/4"	1 1/2"	4"	3FHL750C	\$112.20
3/4"	3"	6"	3FHL750LC	\$171.60
1.0"	1"	3"	3FHL1000SC	\$178.20
1.0"	1 1/2"	4"	3FHL1000C	\$191.40
1.0"	3"	6"	3FHL1000LC	\$316.80

Corner Radius Available At Extra Cost

Micrograin Carbide Ball Nose Rib Cutters

ALL TOOLS ARE 4 FLUTE 3/16 SHANK 3" OAL



0 DEGREE RIB CUTTERS BALLNOSE		
EDP #	Description	Price
4FBRB030S0.0	.030 DIA .210 LOC 3" OAL BN	\$49.63
4FBRB030L0.0	.030 DIA .420 LOC 3" OAL BN	\$51.15
4FBRB040S0.0	.040 DIA .280 LOC 3" OAL BN	\$49.63
4FBRB040L0.0	.040 DIA .560 LOC 3" OAL BN	\$51.15
4FBRB050S0.0	.050 DIA .350 LOC 3" OAL BN	\$49.63
4FBRB050L0.0	.050 DIA .700 LOC 3" OAL BN	\$51.15
4FBRB060S0.0	.060 DIA .420 LOC 3" OAL BN	\$49.63
4FBRB060L0.0	.060 DIA .840 LOC 3" OAL BN	\$51.15
4FBRB070S0.0	.070 DIA .490 LOC 3" OAL BN	\$49.63
4FBRB070L0.0	.070 DIA .980 LOC 3" OAL BN	\$51.15
4FBRB080S0.0	.080 DIA .560 LOC 3" OAL BN	\$49.63
4FBRB080L0.0	.080 DIA .1.120 LOC 3" OAL BN	\$51.15
4FBRB090S0.0	.090 DIA .630 LOC 3" OAL BN	\$49.63
4FBRB090L0.0	.090 DIA 1.260 LOC 3" OAL BN	\$51.15
4FBRB100S0.0	.100 DIA .700 LOC 3" OAL BN	\$49.63
4FBRB100L0.0	.100 DIA 1.400 LOC 3" OAL BN	\$51.15

1.5 DEGREE RIB CUTTERS BALLNOSE		
EDP #	Description	Price
4FBRB030S1.5	.030 DIA .210 LOC 3" OAL BN	\$49.63
4FBRB030L1.5	.030 DIA .420 LOC 3" OAL BN	\$51.15
4FBRB040S1.5	.040 DIA .280 LOC 3" OAL BN	\$49.63
4FBRB040L1.5	.040 DIA .560 LOC 3" OAL BN	\$51.15
4FBRB050S1.5	.050 DIA .350 LOC 3" OAL BN	\$49.63
4FBRB050L1.5	.050 DIA .700 LOC 3" OAL BN	\$51.15
4FBRB060S1.5	.060 DIA .420 LOC 3" OAL BN	\$49.63
4FBRB060L1.5	.060 DIA .840 LOC 3" OAL BN	\$51.15
4FBRB070S1.5	.070 DIA .490 LOC 3" OAL BN	\$49.63
4FBRB070L1.5	.070 DIA .980 LOC 3" OAL BN	\$51.15
4FBRB080S1.5	.080 DIA .560 LOC 3" OAL BN	\$49.63
4FBRB080L1.5	.080 DIA .1.120 LOC 3" OAL BN	\$51.15
4FBRB090S1.5	.090 DIA .630 LOC 3" OAL BN	\$49.63
4FBRB090L1.5	.090 DIA 1.260 LOC 3" OAL BN	\$51.15
4FBRB100S1.5	.100 DIA .700 LOC 3" OAL BN	\$49.63
4FBRB100L1.5	.100 DIA 1.400 LOC 3" OAL BN	\$51.15

1/2 DEGREE RIB CUTTERS BALLNOSE		
EDP #	Description	Price
4FBRB030S0.5	.030 DIA .210 LOC 3" OAL BN	\$49.63
4FBRB030L0.5	.030 DIA .420 LOC 3" OAL BN	\$51.15
4FBRB040S0.5	.040 DIA .280 LOC 3" OAL BN	\$49.63
4FBRB040L0.5	.040 DIA .560 LOC 3" OAL BN	\$51.15
4FBRB050S0.5	.050 DIA .350 LOC 3" OAL BN	\$49.63
4FBRB050L0.5	.050 DIA .700 LOC 3" OAL BN	\$51.15
4FBRB060S0.5	.060 DIA .420 LOC 3" OAL BN	\$49.63
4FBRB060L0.5	.060 DIA .840 LOC 3" OAL BN	\$51.15
4FBRB070S0.5	.070 DIA .490 LOC 3" OAL BN	\$49.63
4FBRB070L0.5	.070 DIA .980 LOC 3" OAL BN	\$51.15
4FBRB080S0.5	.080 DIA .560 LOC 3" OAL BN	\$49.63
4FBRB080L0.5	.080 DIA .1.120 LOC 3" OAL BN	\$51.15
4FBRB090S0.5	.090 DIA .630 LOC 3" OAL BN	\$49.63
4FBRB090L0.5	.090 DIA 1.260 LOC 3" OAL BN	\$51.15
4FBRB100S0.5	.100 DIA .700 LOC 3" OAL BN	\$49.63
4FBRB100L0.5	.100 DIA 1.400 LOC 3" OAL BN	\$51.15

2 DEGREE RIB CUTTERS BALLNOSE		
EDP #	Description	Price
4FBRB030S2.0	.030 DIA .210 LOC 3" OAL BN	\$49.63
4FBRB030L2.0	.030 DIA .420 LOC 3" OAL BN	\$51.15
4FBRB040S2.0	.040 DIA .280 LOC 3" OAL BN	\$49.63
4FBRB040L2.0	.040 DIA .560 LOC 3" OAL BN	\$51.15
4FBRB050S2.0	.050 DIA .350 LOC 3" OAL BN	\$49.63
4FBRB050L2.0	.050 DIA .700 LOC 3" OAL BN	\$51.15
4FBRB060S2.0	.060 DIA .420 LOC 3" OAL BN	\$49.63
4FBRB060L2.0	.060 DIA .840 LOC 3" OAL BN	\$51.15
4FBRB070S2.0	.070 DIA .490 LOC 3" OAL BN	\$49.63
4FBRB070L2.0	.070 DIA .980 LOC 3" OAL BN	\$51.15
4FBRB080S2.0	.080 DIA .560 LOC 3" OAL BN	\$49.63
4FBRB080L2.0	.080 DIA .1.120 LOC 3" OAL BN	\$51.15
4FBRB090S2.0	.090 DIA .630 LOC 3" OAL BN	\$49.63
4FBRB090L2.0	.090 DIA 1.260 LOC 3" OAL BN	\$51.15
4FBRB100S2.0	.100 DIA .700 LOC 3" OAL BN	\$49.63

1 DEGREE RIB CUTTERS BALLNOSE		
EDP #	Description	Price
4FBRB030S1.0	.030 DIA .210 LOC 3" OAL BN	\$45.12
4FBRB030L1.0	.030 DIA .420 LOC 3" OAL BN	\$46.50
4FBRB040S1.0	.040 DIA .280 LOC 3" OAL BN	\$45.12
4FBRB040L1.0	.040 DIA .560 LOC 3" OAL BN	\$46.50
4FBRB050S1.0	.050 DIA .350 LOC 3" OAL BN	\$45.12
4FBRB050L1.0	.050 DIA .700 LOC 3" OAL BN	\$46.50
4FBRB060S1.0	.060 DIA .420 LOC 3" OAL BN	\$45.12
4FBRB060L1.0	.060 DIA .840 LOC 3" OAL BN	\$46.50
4FBRB070S1.0	.070 DIA .490 LOC 3" OAL BN	\$45.12
4FBRB070L1.0	.070 DIA .980 LOC 3" OAL BN	\$46.50
4FBRB080S1.0	.080 DIA .560 LOC 3" OAL BN	\$45.12
4FBRB080L1.0	.080 DIA .1.120 LOC 3" OAL BN	\$46.50
4FBRB090S1.0	.090 DIA .630 LOC 3" OAL BN	\$45.12
4FBRB090L1.0	.090 DIA 1.260 LOC 3" OAL BN	\$46.50
4FBRB100S1.0	.100 DIA .700 LOC 3" OAL BN	\$45.12
4FBRB100L1.0	.100 DIA 1.400 LOC 3" OAL BN	\$46.50

3 DEGREE RIB CUTTERS BALLNOSE		
EDP #	Description	Price
4FBRB030S3.0	.030 DIA .210 LOC 3" OAL BN	\$49.63
4FBRB030L3.0	.030 DIA .420 LOC 3" OAL BN	\$51.15
4FBRB040S3.0	.040 DIA .280 LOC 3" OAL BN	\$49.63
4FBRB040L3.0	.040 DIA .560 LOC 3" OAL BN	\$51.15
4FBRB050S3.0	.050 DIA .350 LOC 3" OAL BN	\$49.63
4FBRB050L3.0	.050 DIA .700 LOC 3" OAL BN	\$51.15
4FBRB060S3.0	.060 DIA .420 LOC 3" OAL BN	\$49.63
4FBRB060L3.0	.060 DIA .840 LOC 3" OAL BN	\$51.15
4FBRB070S3.0	.070 DIA .490 LOC 3" OAL BN	\$49.63
4FBRB070L3.0	.070 DIA .980 LOC 3" OAL BN	\$51.15
4FBRB080S3.0	.080 DIA .560 LOC 3" OAL BN	\$49.63
4FBRB080L3.0	.080 DIA .1.120 LOC 3" OAL BN	\$51.15
4FBRB090S3.0	.090 DIA .630 LOC 3" OAL BN	\$49.63
4FBRB100S3.0	.100 DIA .700 LOC 3" OAL BN	\$49.63

Micrograin Carbide

Corner Radius Rib Cutters

ALL TOOLS ARE 4 FLUTE 3/16 SHANK 3" OAL



0 DEGREE RIB CUTTERS .010 RADIUS		
EDP #	Description	Price
4FRB030S0.0	.030 DIA .210 LOC 3" OAL .010 CRAD	\$49.63
4FRB030L0.0	.030 DIA .420 LOC 3" OAL .010 CRAD	\$51.15
4FRB040S0.0	.040 DIA .280 LOC 3" OAL .010 CRAD	\$49.63
4FRB040L0.0	.040 DIA .560 LOC 3" OAL .010 CRAD	\$51.15
4FRB050S0.0	.050 DIA .350 LOC 3" OAL .010 CRAD	\$49.63
4FRB050L0.0	.050 DIA .700 LOC 3" OAL .010 CRAD	\$51.15
4FRB060S0.0	.060 DIA .420 LOC 3" OAL .010 CRAD	\$49.63
4FRB060L0.0	.060 DIA .840 LOC 3" OAL .010 CRAD	\$51.15
4FRB070S0.0	.070 DIA .490 LOC 3" OAL .010 CRAD	\$49.63
4FRB070L0.0	.070 DIA .980 LOC 3" OAL .010 CRAD	\$51.15
4FRB080S0.0	.080 DIA .560 LOC 3" OAL .010 CRAD	\$49.63
4FRB080L0.0	.080 DIA .1.120 LOC 3" OAL .010 CRAD	\$51.15
4FRB090S0.0	.090 DIA .630 LOC 3" OAL .010 CRAD	\$49.63
4FRB090L0.0	.090 DIA 1.260 LOC 3" OAL .010 CRAD	\$51.15
4FRB100S0.0	.100 DIA .700 LOC 3" OAL .010 CRAD	\$49.63
4FRB100L0.0	.100 DIA 1.400 LOC 3" OAL .010 CRAD	\$51.15

1.5 DEGREE RIB CUTTERS .010 RADIUS		
EDP #	Description	Price
4FRB030S1.5	.030 DIA .210 LOC 3" OAL .010 CRAD	\$49.63
4FRB030L1.5	.030 DIA .420 LOC 3" OAL .010 CRAD	\$51.15
4FRB040S1.5	.040 DIA .280 LOC 3" OAL .010 CRAD	\$49.63
4FRB040L1.5	.040 DIA .560 LOC 3" OAL .010 CRAD	\$51.15
4FRB050S1.5	.050 DIA .350 LOC 3" OAL .010 CRAD	\$49.63
4FRB050L1.5	.050 DIA .700 LOC 3" OAL .010 CRAD	\$51.15
4FRB060S1.5	.060 DIA .420 LOC 3" OAL .010 CRAD	\$49.63
4FRB060L1.5	.060 DIA .840 LOC 3" OAL .010 CRAD	\$51.15
4FRB070S1.5	.070 DIA .490 LOC 3" OAL .010 CRAD	\$49.63
4FRB070L1.5	.070 DIA .980 LOC 3" OAL .010 CRAD	\$51.15
4FRB080S1.5	.080 DIA .560 LOC 3" OAL .010 CRAD	\$49.63
4FRB080L1.5	.080 DIA .1.120 LOC 3" OAL .010 CRAD	\$51.15
4FRB090S1.5	.090 DIA .630 LOC 3" OAL .010 CRAD	\$49.63
4FRB090L1.5	.090 DIA 1.260 LOC 3" OAL .010 CRAD	\$51.15
4FRB100S1.5	.100 DIA .700 LOC 3" OAL .010 CRAD	\$49.63
4FRB100L1.5	.100 DIA 1.400 LOC 3" OAL .010 CRAD	\$51.15

1/2 DEGREE RIB CUTTERS .010 RADIUS		
EDP #	Description	Price
4FRB030S0.5	.030 DIA .210 LOC 3" OAL .010 CRAD	\$49.63
4FRB030L0.5	.030 DIA .420 LOC 3" OAL .010 CRAD	\$51.15
4FRB040S0.5	.040 DIA .280 LOC 3" OAL .010 CRAD	\$49.63
4FRB040L0.5	.040 DIA .560 LOC 3" OAL .010 CRAD	\$51.15
4FRB050S0.5	.050 DIA .350 LOC 3" OAL .010 CRAD	\$49.63
4FRB050L0.5	.050 DIA .700 LOC 3" OAL .010 CRAD	\$51.15
4FRB060S0.5	.060 DIA .420 LOC 3" OAL .010 CRAD	\$49.63
4FRB060L0.5	.060 DIA .840 LOC 3" OAL .010 CRAD	\$51.15
4FRB070S0.5	.070 DIA .490 LOC 3" OAL .010 CRAD	\$49.63
4FRB070L0.5	.070 DIA .980 LOC 3" OAL .010 CRAD	\$51.15
4FRB080S0.5	.080 DIA .560 LOC 3" OAL .010 CRAD	\$49.63
4FRB080L0.5	.080 DIA .1.120 LOC 3" OAL .010 CRAD	\$51.15
4FRB090S0.5	.090 DIA .630 LOC 3" OAL .010 CRAD	\$49.63
4FRB090L0.5	.090 DIA 1.260 LOC 3" OAL .010 CRAD	\$51.15
4FRB100S0.5	.100 DIA .700 LOC 3" OAL .010 CRAD	\$49.63
4FRB100L0.5	.100 DIA 1.400 LOC 3" OAL .010 CRAD	\$51.15

2 DEGREE RIB CUTTERS .010 RADIUS		
EDP #	Description	Price
4FRB030S2.0	.030 DIA .210 LOC 3" OAL .010 CRAD	\$49.63
4FRB030L2.0	.030 DIA .420 LOC 3" OAL .010 CRAD	\$51.15
4FRB040S2.0	.040 DIA .280 LOC 3" OAL .010 CRAD	\$49.63
4FRB040L2.0	.040 DIA .560 LOC 3" OAL .010 CRAD	\$51.15
4FRB050S2.0	.050 DIA .350 LOC 3" OAL .010 CRAD	\$49.63
4FRB050L2.0	.050 DIA .700 LOC 3" OAL .010 CRAD	\$51.15
4FRB060S2.0	.060 DIA .420 LOC 3" OAL .010 CRAD	\$49.63
4FRB060L2.0	.060 DIA .840 LOC 3" OAL .010 CRAD	\$51.15
4FRB070S2.0	.070 DIA .490 LOC 3" OAL .010 CRAD	\$49.63
4FRB070L2.0	.070 DIA .980 LOC 3" OAL .010 CRAD	\$51.15
4FRB080S2.0	.080 DIA .560 LOC 3" OAL .010 CRAD	\$49.63
4FRB080L2.0	.080 DIA .1.120 LOC 3" OAL .010 CRAD	\$51.15
4FRB090S2.0	.090 DIA .630 LOC 3" OAL .010 CRAD	\$49.63
4FRB090L2.0	.090 DIA 1.260 LOC 3" OAL .010 CRAD	\$51.15
4FRB100S2.0	.100 DIA .700 LOC 3" OAL .010 CRAD	\$49.63

1 DEGREE RIB CUTTERS .010 RADIUS		
EDP #	Description	Price
4FRB030S1.0	.030 DIA .210 LOC 3" OAL .010 CRAD	\$49.63
4FRB030L1.0	.030 DIA .420 LOC 3" OAL .010 CRAD	\$51.15
4FRB040S1.0	.040 DIA .280 LOC 3" OAL .010 CRAD	\$49.63
4FRB040L1.0	.040 DIA .560 LOC 3" OAL .010 CRAD	\$51.15
4FRB050S1.0	.050 DIA .350 LOC 3" OAL .010 CRAD	\$49.63
4FRB050L1.0	.050 DIA .700 LOC 3" OAL .010 CRAD	\$51.15
4FRB060S1.0	.060 DIA .420 LOC 3" OAL .010 CRAD	\$49.63
4FRB060L1.0	.060 DIA .840 LOC 3" OAL .010 CRAD	\$51.15
4FRB070S1.0	.070 DIA .490 LOC 3" OAL .010 CRAD	\$49.63
4FRB070L1.0	.070 DIA .980 LOC 3" OAL .010 CRAD	\$51.15
4FRB080S1.0	.080 DIA .560 LOC 3" OAL .010 CRAD	\$49.63
4FRB080L1.0	.080 DIA .1.120 LOC 3" OAL .010 CRAD	\$51.15
4FRB090S1.0	.090 DIA .630 LOC 3" OAL .010 CRAD	\$49.63
4FRB090L1.0	.090 DIA 1.260 LOC 3" OAL .010 CRAD	\$51.15
4FRB100S1.0	.100 DIA .700 LOC 3" OAL .010 CRAD	\$49.63
4FRB100L1.0	.100 DIA 1.400 LOC 3" OAL .010 CRAD	\$51.15

3 DEGREE RIB CUTTERS .010 RADIUS		
EDP #	Description	Price
4FRB030S3.0	.030 DIA .210 LOC 3" OAL .010 CRAD	\$49.63
4FRB030L3.0	.030 DIA .420 LOC 3" OAL .010 CRAD	\$51.15
4FRB040S3.0	.040 DIA .280 LOC 3" OAL .010 CRAD	\$49.63
4FRB040L3.0	.040 DIA .560 LOC 3" OAL .010 CRAD	\$51.15
4FRB050S3.0	.050 DIA .350 LOC 3" OAL .010 CRAD	\$49.63
4FRB050L3.0	.050 DIA .700 LOC 3" OAL .010 CRAD	\$51.15
4FRB060S3.0	.060 DIA .420 LOC 3" OAL .010 CRAD	\$49.63
4FRB060L3.0	.060 DIA .840 LOC 3" OAL .010 CRAD	\$51.15
4FRB070S3.0	.070 DIA .490 LOC 3" OAL .010 CRAD	\$49.63
4FRB070L3.0	.070 DIA .980 LOC 3" OAL .010 CRAD	\$51.15
4FRB080S3.0	.080 DIA .560 LOC 3" OAL .010 CRAD	\$49.63
4FRB080L3.0	.080 DIA .1.120 LOC 3" OAL .010 CRAD	\$51.15
4FRB090S3.0	.090 DIA .630 LOC 3" OAL .010 CRAD	\$49.63
4FRB090L3.0	.090 DIA 1.260 LOC 3" OAL .010 CRAD	\$51.15
4FRB100S3.0	.100 DIA .700 LOC 3" OAL .010 CRAD	\$49.63

HIGH PERFORMANCE END MILLS

Micrograin Carbide

High Helix Eccentric Relief Finish End Mills



The Toughest Cutting Edge Available!

DIA	Flute Length	Overall Length	4 Flute Uncoated	Uncoated Price	4 Flute Coated	Coated Price
3/16	5/8	2	4FHHE188	\$19.20	4FHHE188C	\$23.76
1/4	3/4	2 1/2	4FHHE250	\$24.60	4FHHE250C	\$31.02
5/16	13/16	2 1/2	4FHHE312	\$28.20	4FHHE312C	\$36.30
3/8	7/8	2 1/2	4FHHE375	\$32.40	4FHHE375C	\$40.92
7/16	1	3	4FHHE437	\$42.90	4FHHE437C	\$53.79
1/2	1	3	4FHHE500	\$47.70	4FHHE500C	\$59.07
9/16	1 1/4	3 1/2	4FHHE562	\$72.60	4FHHE562C	\$89.10
5/8	1 1/4	3 1/2	4FHHE625	\$81.60	4FHHE625C	\$99.00
3/4	1 1/2	4	4FHHE750	\$109.20	4FHHE750C	\$130.68
1	1 1/2	4	4FHHE1000	\$211.20	4FHHE1000C	\$252.12

Micrograin Carbide

Independent Helix End Mills

Rapid Feed Rates! Works Great on Mid-Size & Small Mills or Lathes with Live Tooling!

Flute Dia.	Corner Radius	Flute Length	Shank Dia.	Overall Length	EDP# Coated	Coated Price
1/8	.01	1/2	1/8	1.5	4FVH125.01	\$12.87
3/16	.01	5/8	3/16	2	4FVH188.01	\$18.06
1/4	.02	3/4	1/4	2.5	4FVH250.02	\$20.59
3/8	.02	7/8	3/8	2.5	4FVH375.02	\$33.26
1/2	.02	1	1/2	3	4FVH500.02	\$57.02
1/2	.03	1	1/2	3	4FVH500.03	\$57.02
5/8	.03	1 1/2	5/8	4	4FVH625.03	\$89.00
3/4	.03	1 1/2	3/4	4	4FVH750.03	\$128.0

Micrograin Carbide

Rougher-Finisher / Full Pitch End Mills

Roughing Speeds & Feeds, Decent Finishes, Reduced Spindle Load

Flute Dia.	Corner Radius	Flute Length	Shank Dia.	Overall Length	EDP# Coated	Coated Price
1/4	.02	3/4	1/4	2.5	4FRF250	\$35.00
5/16	.02	7/8	5/16	2.5	4FRF312	\$45.00
3/8	.03	1.0	3/8	2.5	4FRF375	\$55.00
1/2	.03	1.0	1/2	3.0	4FRF500	\$65.00
5/8	.045	1.5	5/8	4.0	4FRF625	\$95.00
3/4	.045	1.5	3/4	4.0	4FRF750	\$135.00

Don't see what you need? Have a question? Call (269) 344-3041



Micrograin Carbide
High Helix Ball Nose End Mills

DIA	Shank	LOC	OAL	Flutes	Coated EDP #	Price
3/64	1/8	3/32	1 1/2	2	2FHHB046S	\$17.16
1/16	1/8	1/8	1 1/2	2	2FHHB062S	\$17.16
1/8	1/8	1/2	1 1/2	2	2FHHB125	\$17.16
9/64	3/16	3/8	2	2	2FHHB141S	\$18.22
3/16	3/16	5/8	2	2	2FHHB188S	\$19.54
13/64	1/4	1/2	2	2	2FHHB203S	\$24.82
7/32	1/4	1/2	2	2	2FHHB218S	\$24.82
1/4	1/4	1/2	2	2	2FHHB250S	\$21.52
1/4	1/4	3/4	2 1/2	2	2FHHB250	\$25.08
9/32	5/16	1/2	2	2	2FHHB281S	\$27.72
5/16	5/16	13/16	2 1/2	2	2FHHB312	\$30.36
11/32	3/8	5/8	2	2	2FHHB343S	\$33.00
11/32	3/8	7/8	2 1/2	2	2FHHB343	\$36.96
3/8	3/8	5/8	2	2	2FHHB375S	\$31.68
3/8	3/8	7/8	2 1/2	2	2FHHB375	\$36.30
1/2	1/2	5/8	2 1/2	2	2FHHB500S	\$47.52
1/2	1/2	1	3	2	2FHHB500	\$51.48
5/8	5/8	1 1/4	3 1/2	2	2FHHB625	\$89.76
3/4	3/4	1 1/2	4	2	2FHHB750	\$125.40

Micrograin Carbide 4 Flute and 2 Flute
High Helix Square End Mills

DIA	Shank	LOC	OAL	Flutes	Coated EDP #	Price
1/16	1/8	1/8	1 1/2	4	4FHH062S	\$10.56
3/32	1/8	5/16	1 1/2	4	4FHH093	\$10.56
1/8	1/8	1/4	1 1/2	4	4FHH125S	\$9.24
1/8	1/8	1/2	1 1/2	4	4FHH125	\$10.56
1/8	1/8	5/8	2	4	4FHH125L	\$13.20
1/8	1/8	1	3	4	4FHH125XL	\$17.16
5/32	3/16	5/16	2	4	4FHH156S	\$12.94
5/32	3/16	9/16	2	4	4FHH156	\$12.94
11/64	3/16	3/8	2	4	4FHH171S	\$12.94
11/64	3/16	9/16	2	4	4FHH171	\$12.94
3/16	3/16	3/8	2	4	4FHH188S	\$12.94
3/16	3/16	5/8	2	4	4FHH188	\$12.94
3/16	3/16	1	3	4	4FHH188L	\$16.90
3/16	3/16	1 1/8	3	4	4FHH188XL	\$18.22
13/64	1/4	5/8	2	4	4FHH203	\$14.92
13/64	1/4	1 1/4	3	4	4FHH203XL	\$19.80
7/32	1/4	7/16	2	4	4FHH218S	\$18.22
7/32	1/4	5/8	2 1/2	4	4FHH218	\$18.22
7/32	1/4	1 1/4	3	4	4FHH218XL	\$23.76
15/64	1/4	1	3	4	4FHH235L	\$19.80
1/4	1/4	1/2	2	4	4FHH250S	\$14.92
1/4	1/4	3/4	2 1/2	4	4FHH250	\$17.16
1/4	1/4	1	3	4	4FHH250L	\$23.76
5/16	5/16	1/2	2	4	4FHH312S	\$21.12
5/16	5/16	13/16	2 1/2	4	4FHH312	\$23.76
5/16	5/16	1 1/4	3	4	4FHH312L	\$33.00
5/16	5/16	1 1/2	4	4	4FHH312XL	\$35.64
11/32	3/8	5/8	2	4	4FHH344S	\$26.40
11/32	3/8	7/8	2 1/2	4	4FHH344	\$31.02
11/32	3/8	1 1/2	4	4	4FHH344XL	\$42.24
3/8	3/8	5/8	2	4	4FHH375S	\$25.08
3/8	3/8	7/8	2 1/2	4	4FHH375	\$29.70
3/8	3/8	1 1/4	3	4	4FHH375L	\$42.24
3/8	3/8	1 1/2	4	4	4FHH375XL	\$43.56
13/32	7/16	5/8	2 1/2	4	4FHH406S	\$33.00
13/32	7/16	1	3	4	4FHH406	\$35.64
7/16	7/16	5/8	2 1/2	4	4FHH437S	\$33.00
7/16	7/16	1	3	4	4FHH437	\$35.64
7/16	7/16	1 1/4	3	4	4FHH437L	\$42.24
1/2	1/2	5/8	2 1/2	4	4FHH500S	\$38.28
1/2	1/2	1	3	4	4FHH500	\$40.92
1/2	1/2	1 1/4	3	4	4FHH500L	\$40.92
1/2	1/2	1 1/2	4	4	4FHH500XL	\$50.16
17/32	9/16	1 1/4	3 1/2	4	4FHH531	\$64.68
9/16	9/16	1 1/4	3 1/2	4	4FHH562	\$64.68
5/8	5/8	1 1/4	3 1/2	4	4FHH625	\$79.20
3/4	3/4	1 1/2	4	4	4FHH750	\$112.20
1	1	2	4	4	4FHH1000L	\$178.20

DIA	Shank	LOC	OAL	Flutes	Coated EDP #	Price
1/16	1/8	1/8	1 1/2	2	2FHH062S	\$10.56
3/32	1/8	5/16	1 1/2	2	2FHH093	\$10.56
1/8	1/8	1/4	1 1/2	2	2FHH125S	\$9.24
1/8	1/8	1/2	1 1/2	2	2FHH125	\$10.56
1/8	1/8	5/8	2	2	2FHH125L	\$13.20
1/8	1/8	1	3	2	2FHH125XL	\$17.16
5/32	3/16	5/16	2	2	2FHH156S	\$12.94
5/32	3/16	9/16	2	2	2FHH156	\$12.94
11/64	3/16	3/8	2	2	2FHH171S	\$12.94
11/64	3/16	9/16	2	2	2FHH171	\$12.94
3/16	3/16	3/8	2	2	2FHH188S	\$12.94
3/16	3/16	5/8	2	2	2FHH188	\$12.94
3/16	3/16	1	3	2	2FHH188L	\$16.90
3/16	3/16	1 1/8	3	2	2FHH188XL	\$18.22
13/64	1/4	5/8	2	2	2FHH203	\$14.92
13/64	1/4	1 1/4	3	2	2FHH203XL	\$19.80
7/32	1/4	7/16	2	2	2FHH218S	\$18.22
7/32	1/4	5/8	2 1/2	2	2FHH218	\$18.22
7/32	1/4	1 1/4	3	2	2FHH218XL	\$23.76
15/64	1/4	1	3	2	2FHH235L	\$19.80
1/4	1/4	1/2	2	2	2FHH250S	\$14.92
1/4	1/4	3/4	2 1/2	2	2FHH250	\$17.16
1/4	1/4	1	3	2	2FHH250L	\$23.76
5/16	5/16	1/2	2	2	2FHH312S	\$21.12
5/16	5/16	13/16	2 1/2	2	2FHH312	\$23.76
5/16	5/16	1 1/4	3	2	2FHH312L	\$33.00
5/16	5/16	1 1/2	4	2	2FHH312XL	\$35.64
11/32	3/8	5/8	2	2	2FHH344S	\$26.40
11/32	3/8	7/8	2 1/2	2	2FHH344	\$31.02
11/32	3/8	1 1/2	4	2	2FHH344XL	\$42.24
3/8	3/8	5/8	2	2	2FHH375S	\$25.08
3/8	3/8	7/8	2 1/2	2	2FHH375	\$29.70
3/8	3/8	1 1/4	3	2	2FHH375L	\$42.24
3/8	3/8	1 1/2	4	2	2FHH375XL	\$43.56
13/32	7/16	5/8	2 1/2	2	2FHH406S	\$33.00
13/32	7/16	1	3	2	2FHH406	\$35.64
7/16	7/16	5/8	2 1/2	2	2FHH437S	\$33.00
7/16	7/16	1	3	2	2FHH437L	\$42.24
1/2	1/2	5/8	2 1/2	2	2FHH500S	\$38.28
1/2	1/2	1	3	2	2FHH500	\$40.92
1/2	1/2	1 1/4	3	2	2FHH500L	\$40.92
1/2	1/2	1 1/2	4	2	2FHH500XL	\$50.16
17/32	9/16	1 1/4	3 1/2	2	2FHH531	\$64.68
9/16	9/16	1 1/4	3 1/2	2	2FHH562	\$64.68
5/8	5/8	1 1/4	3 1/2	2	2FHH625	\$79.20
3/4	3/4	1 1/2	4	2	2FHH750	\$112.20
1	1	2	4	2	2FHH1000L	\$178.20

Micrograin Carbide Helica Coated
High Performance Drilling 30° Coolant Thru Drills

Dia. (A)	Shank Dia. (B)	Overall Length (C)	Flute Length (D)	Included Angle (E)	Clearance Angle (F)	Clearance (G)	EDP#	Price
0.2055	0.2055	3.25	1.40	140°	45°	0.030	BUR205DR	\$82.50
0.2625	0.2625	3.25	1.70	140°	45°	0.030	BUR262DR	\$82.50
0.3125	0.3125	4.10	2.10	140°	45°	0.030	BUR312DR	\$82.50
0.3150	0.3150	4.10	2.10	140°	45°	0.030	BUR315DR	\$82.50
0.3750	0.3750	4.10	2.40	140°	45°	0.040	BUR375DR	\$107.80
0.4060	0.4060	6.00	2.85	140°	45°	0.040	BUR406DR	\$112.20
0.4375	0.4375	6.00	3.10	140°	45°	0.040	BUR437DR	\$126.50
0.4531	0.4531	6.00	3.10	140°	45°	0.040	BUR453DR	\$135.30
0.5000	0.5000	6.00	3.10	140°	45°	0.040	BUR500DR	\$165.00
0.5312	0.5312	6.00	3.25	140°	45°	0.040	BUR531DR	\$198.00
0.5625	0.5625	6.25	3.54	140°	45°	0.040	BUR562DR	\$231.00
0.5781	0.5781	6.25	3.60	140°	45°	0.040	BUR578DR	\$231.00
0.6250	0.6250	6.25	3.85	140°	45°	0.045	BUR625DR	\$280.50
0.6875	0.6875	6.25	4.00	140°	45°	0.045	BUR687DR	\$302.50
0.7188	0.7188	6.25	4.00	140°	45°	0.045	BUR718DR	\$374.00
0.7500	0.7500	6.25	4.00	140°	45°	0.045	BUR750DR	\$412.50
-0.0000	-0.0001	+03	+03	+1.0°	+1.0°	+0.005	Tolerance	
-0.0005	-0.0003	-0.03	-0.00	-1.0°	-1.0°	-0.005	Tolerance	

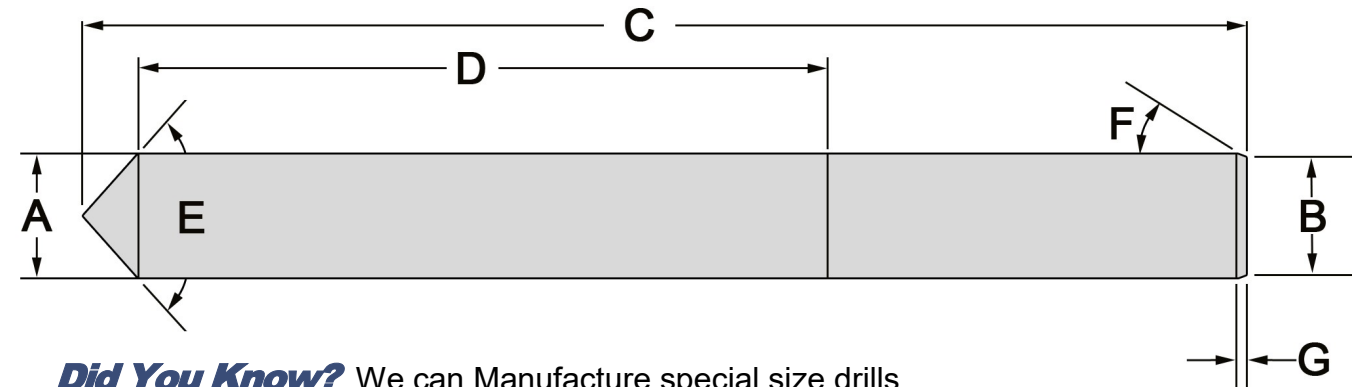

Did You Know? We can Manufacture special size drills, Coolant Thru or Solid Carbide quicker and for much less than other manufacturers

Don't See What You Need? Fax us the form below and we Will make it for you. Coolant Thru Available In Most Sizes. Fax to: (269) 344-6368

Special Size Drill Order Form

Diameter (A) _____ (B) _____ Overall Length (C) _____ Flute Length (D) _____

Included Angle (E) _____ (F) _____ (G) _____

Material: H.S.S. _____ Carbide _____ Cobalt _____ Quantity _____ Due Date _____

Need special Drills or Reamers FAST see page 21 & 22