



RAPALA[®]

2016
CATALOG



SHADOW RAP®
MOST DANGEROUS MOVES EVER.

THE QUEST FOR PERFECTION

Rapala is the original innovator in fishing tackle with an exceptional ability to continuously renew and apply Lauri Rapala's groundbreaking innovation that changed lure fishing forever: the Rapala wobble that imitates a wounded baitfish.

THIS CAN BE SEEN IN THE SUPERIOR know-how in lure design and traditional craftsmanship values that are combined with cutting edge technology and uncompromising quality control. Today's technology allows very advanced and precise production methods, yet throughout the production process the lure parts are repeatedly checked for quality. And at the end of the production, every Rapala lure that has a swimming lip is still hand tuned and tank tested to guarantee perfect action straight out of the box.

THE SAME ATTENTION TO DETAIL and tradition of high standard products is extended to all fishing tackle sold under the

Rapala brand, be it the use of environmentally friendly production methods used to manufacture the Eco Wear wading gear or the innovative, technically advanced Touch Screen Scales.

WE HAVE TWO TRUE TESTAMENTS to the performance of our lures. The fact that the Original Floater is still the world's best selling hard bait, and the number of I.G.F.A. world records caught on Rapala – the world record of world records.

TABLE OF CONTENTS:

SHADOW RAP SERIES

NEW Shadow Rap®	08
NEW Shadow Rap® Deep	11

SCATTER RAP SERIES

Scatter Rap® CountDown	14
Scatter Rap® Shap	15
Scatter Rap® Crank	17
Scatter Rap® Crank Deep	17

BX SERIES

NEW SIZE BX® Minnow	20
BX® Waking Minnow	21
BX® Jointed Minnow	22
BX® Jointed Shad	25

CLACKIN' SERIES

Clackin' Minnow®	28
------------------	----

MAXRAP SERIES

MaxRap®	32
MaxRap® Fat Shad	33
MaxRap® Fat Minnow	35

XXX-RAP® SERIES

XXX-Rap®	38
XXX-Rap® Cast	39

X-RAP® SERIES

X-Rap®	42 - 43
X-Rap® CountDown®	44 - 45
X-Rap® Deep	46
X-Rap® Pop	48
X-Rap® Prop	49
X-Rap® Saltwater	50
X-Rap® Shad	51
X-Rap® Magnum®	52
X-Rap® Magnum® UV	53

CLASSIC SERIES

CountDown®	56
CountDown® Magnum®	57
Deep Tail Dancer®	58
Mini Fat Rap®	59
Shad Rap®	60
Shad Rap® Magnum®	61
Super Shad Rap®	62
Shallow Shad Rap®	63
Skitter Pop®	64
Team Esko®	65

PLASTIC LURES

Rippin' Rap®	68
Ultra Light Rippin' Rap®	70
Ultra Light Crank	71
Ultra Light Minnow	72
Ultra Light Shad	73
NEW Ultra Light Pop	74

Rattlin' Rapala	75
Husky Jerk®	77
Glass Shad Rap®	78
Jointed Shad Rap®	79
Jiggling Rap®	80

ASIA EDITION

NEW Husky	84
NEW Mini Fat Rap	85
NEW Rattlin' Rapala	86
NEW Risto Rap	87
NEW Skitter Pop	88
NEW Deep Tail Dancer	89

RAPALA LUGGAGE & BAGS

Sling Bag	91
Magnum Sling Bag	91
Hybrid Hip Pack	92
Freestyle Hip Pack	92
Sportsman's Series	93

VISION GEAR® SUNGLASSES

Doubles Collection	96
Sportsman's Magnum	97
Sportsman's	98
Rapala Sight Gear	98
Sportsman's Mirror	99
Sportsman's Floater	99

KNIVES & ACCESSORIES

Single Hand Net	100
Black Medallion™ Fillet Knife	100
Fishing/Camping Folding Knife	101
Saltwater Fillet	101
4" Bait Knife	101
Ceramic Sharpeners	101

APPAREL & GEAR

Rapala Jersey	102 - 103
Rapala T-Shirt	104 - 105
Storm Apparel	106 - 107
VMC Hoodie	108
North Craft T-Shirt	108
Storm Armsock	108
Storm Tactical Casting Gloves	108

PRO HEADWEAR

Rapala Camo Cap	109
Rapala Denim Cap	109
Storm Denim Cap	109
Dri-Fit Cap	109
Mesh Cap	109

ACCESSORIES

Rapala 3 Panel Wallet	110
Rapala Fish Flop Sandals	110
Rapala Rod Wrap	111
Rapala Auto / Boat Emblem	111

STORM LURES

NEW Arashi® Rattling Top Walker	114
Arashi® Silent Square	115
Arashi® Rattling Flat	115
NEW COLOUR Arashi® Rattling Minnow	116
NEW Arashi® Rattling Minnow Deep	116
NEW SIZE NEW COLOUR Arashi® Rattling Deep	117
NEW COLOUR Gomoku Popper	118
NEW COLOUR Gomoku Popper	119
NEW COLOUR Gomoku Minnow	120
NEW COLOUR Gomoku Vibe	121
NEW Gomoku Crank	122
NEW Gomoku Sutte	123
NEW COLOUR Gomoku Spin	124
NEW COLOUR Gomoku Bottom	125
NEW Sx-Soft Vib	127
NEW COLOUR So-Run Heavy Minnow	128
NEW COLOUR So-Run Minnow	130
NEW COLOUR So-Run Sinking Pencil	131
NEW So-Run Hypno Grub	132
NEW So-Run Maken Minnow	133
Z-Stick	136
Twitch Stick	137
NEW COLOUR Smash Shad	138
NEW COLOUR Deep Thunder®	140
Rattlin' Chuğ Buğ®	141
Rattlin' Saltwater Chuğ Buğ®	141
WildEye® Swim Shad	142
WildEye® Rippin' Swim Shad	143
WildEye® Live Shrimp	143
FlutterStick MadFlash	144
Serpentino	145

STORM JIGS

NEW COLOUR Koika	151
Gomame	152 - 153
Micro Jig	154
Super Gomoku	155
Thunder Jig	157

NORTH CRAFT LURES

Air Ogre	160
BLV 25G	161
Adration 90F/125F	162 - 163
BMC 100F/120F	164
BT-VIB 78S	165
Gunduce Ultra	166
SURF DMSF 25/30	167

SUFIX

832 Advanced Superline®	170
832 Metered Multi Colour	171
Nanobraid®	172
Matrix Pro	173
Castable Invisiline™	174
Invisiline™	174
Superior	175
Zippy Shock Leader	175

VMC HOOKS

7545	178
7554	178
7556	178
9626	179
8527	179
7310	180
7317	181
7317LD	181
9255	182
9260	182
NEW AH7264DA	183
NEW AH7110DA	183
NEW AH7117DA	183
7264	184
9746	184
7237	185
7266	185
8117S	186
NEW 7117	186
8299S	187
9754	187
Chinu	188
3537	188
3541	189
3561	189
3562	189

RODS

CASTING

NEW Rapala Risto	192 - 193
NEW Rapala Snow	194 - 195
Rapala RFS Finesse Series	196 - 197
NEW Rapala Koivu	198 - 199
NEW Rapala Vellamo	200 - 201
NEW Storm Monstar	202 - 203
Storm Shore X	204 - 205
Storm Trickster	206 - 207
NEW Storm Adventure	208 - 209
Storm Discovery	210 - 211

JIGGING

NEW Storm Adajo	212 - 213
Storm Gomoku Erito Bespoke	214 - 215
Storm Gomoku Kaiten	216 - 217
Storm Gomoku Erito	216 - 217
Storm Gomoku Keiryō	216 - 217
Storm Micro Jigger	218 - 219
Williamson Sopranos	220 - 221

TRIGGER-X

Flappin' Craw	223
Flappini Bug	224
Minnow	224
NEW COLOUR Slop Hopper	226 - 227
NEW COLOUR Swimming Grub	227

RAPALA MATERIALS AND FINISHES

Carefully selected materials and finishes guarantee optimal performance and appearance.



BALSA WOOD

Balsa wood has always been the material of choice for Rapala's iconic lures; such as the Original Floater and CountDown – the lures that started it all. Even today, precisely shaped and precision weighted balsa body gives the lure the most responsive and life-like action that can't be achieved with any other material.

BALSA WOOD is quite unique; it is a very sustainable product thanks to its rapid growth rate, and despite being so light it is still very strong and is classified as the softest commercial hardwood – the perfect initial ingredient in creating the famous Rapala “wounded minnow” action.

ABACHI WOOD

Abachi wood is the perfect choice for Rapala when a tougher wooden lure is required. Abachi is used in the manufacture of Rapala lures such as the CountDown Magnum – lures that are designed to target big fish.

ABACHI OFFERS a similar life-like, natural swimming action to balsa. The major difference between abachi and balsa is the strength and also the buoyancy; balsa has higher buoyancy and will rise faster in the water than abachi.

PLASTIC

Plastic is a great artificial material for manufacturing fishing lures, it lends itself to a variety of options for finishes and translucency. Plastic is ideal for lures that have to be very strong and durable or neutrally buoyant (suspending).

PLASTIC LURES can be built to be as noisy as a swarm of bees or as silent as a mouse. Translucent plastic can have texture on either side, allowing very realistic life-like finishes with 3D scales, lateral lines, gills and fins when combined with internal metallic or holographic finishes and external paint and print patterns.



ORIGINAL RAPALA FOIL

Rapala's original foil is the perfect all-rounder when it comes to selecting a general purpose finish to mimic natural baitfish. The original foil produces a moderate amount of flash and showcases a fantastically detailed, natural scale pattern.



HOLOGRAPHIC FOIL

The holographic foil is a signature ingredient within the X-Rap concept; it is what gives that strike-inducing flash that fish just can't resist. Holographic foils are used both internally and externally to achieve intense flash that still blends into the natural underwater environment.



PAINTED/PRINTED

Painted and printed finishes are generally found on wooden bodied lures, such as the Countdown and Original Floater. These color combinations give off a low amount of flash, and can be produced to provide either natural or high contrast attractor patterns.



METALLIC PLATING

Metallic finishes are used to imitate really shiny baitfish species and to create a lot of flash to catch the fish's attention. Combined with paint and print patterns, chrome finishes can be used to create highly detailed baitfish imitations as well as bright and flashy attractor patterns.



CUSTOM HD LIVE

Created in perfect detail, the advanced Custom HD finishes are the most life-like replicas of nature ever. The artisanal finishes are a mix of modern printing technology combined with classic Rapala foil finishes and deep knowledge on how to combine the best of both to create stunningly beautiful baitfish imitations.

UV BRIGHT

UV Bright finish reflects more light energy, strengthening the lures visibility.

GLOW

Glow colors reserve light energy into the coating and release it in the dark – be it because of night or deep water – to create an irresistible target for the predators.



SHADOW RAP[®] SERIES

The Dying Minnow Action of the Shadow Rap[®] Series compliments Rapala's already extensive offering of hard baits that have the legendary, original Wounded Minnow Action and the Escaping Minnow Action featured in the Shadow Rap[®] series. These are the three stages when a baitfish is at its most vulnerable – and most interesting target for a predator.

The Dying Minnow Action is simple: on a twitch the lure makes a final dart off to the side, turns back to look at its adversary and with a dying quiver settles to a head down dive to death.

Unlike other jerkbaits, the Shadow Rap[®] kicks almost 180 degrees when twitched and given slack line so it can be fished nearly in place with very little forward travel. This keeps the flickering fade of the Shadow Rap[®] right in the strike zone for a long time.



SHADOW RAP®

NEW
for
2016



Dying Minnow Action



Life-Like Finish



Tungsten & Steel Weights



Premium VMC® Black Nickel Hooks



Hand-Tuned & Tank-Tested For Perfection



Designed to perfectly mimic the last struggle of a dying minnow, the Shadow Rap® makes tight turns when twitched, turns to look back and then settles to a head down position with a quiver before starting a slow fade-away dive on the pause. Can be fished almost in place with short twitches, extending the time the lure spends on the strike zone.

- Responsive, Tight-Turning Jerkbait Action
- Head-Down Flickering Fade-Away on the Stop
- Mimics Dying Baitfish
- Internal Metallic Plating and Natural Scale Pattern
- Translucent Sides with Holographic Inserts and Bone Pattern
- Tungsten and Steel Weights for Perfect Balance
- Black Nickel VMC® Hooks

SHADOW RAP® SPECIFICATIONS

Model No.	Running Depth	Body Length	Weight	Hooks
SDR11 NEW	0.6-1.2	11 cm	13 g	Three No. 6
AS - Albino Shiner; BBH - Blue Back Herring; BGH - Blue Ghost; BN - Bone; BUD - Bud; CBN - Carbon; CLN - Clown; GH - Ghost; GHSH - Ghost Shiner; MBS - Moss Back Shiner; OG - Olive Green; YP - Yellow Perch				





RAPALA
Original Finnish Lures Since 1936

SHADOW RAP® DEEP



Dying Minnow Action

Life-Like Finish

Tungsten & Steel Weights

Premium VMC® Black Nickel Hooks

Hand-Tuned & Tank-Tested For Perfection



Ideal for a slow moving, yet action-packed dying minnow presentation in a little bit deeper water than the Shadow Rap®. Can be fished with little forward movement, yet a lot of side to side action. With a fast twitch followed by slack line, the Shadow Rap turns to look back almost 180 degrees before settling with a flicker to a fade away dying dive.

- Responsive, Tight-Turning Jerkbait Action
- Head-Down Flickering Fade-Away on the Stop
- Mimics Dying Baitfish
- Internal Metallic Plating and Natural Scale Pattern
- Translucent Sides with Holographic Inserts and Bone Pattern
- Tungsten and Steel Weights for Perfect Balance
- Black Nickel VMC® Hooks

SHADOW RAP® DEEP SPECIFICATIONS

Model No.	Running Depth	Body Length	Weight	Hooks
SDRD11 NEW	1.2-2.4	11 cm	13 g	Three No. 6
AS - Albino Shiner; BBH - Blue Back Herring; BGH - Blue Ghost;				
BN - Bone; BUD - Bud; CBN - Carbon; CLN - Clown; GH - Ghost;				
GHSH - Ghost Shiner; MBS - Moss Back Shiner; OG - Olive Green;				
YP - Yellow Perch				



SCATTER RAP® SERIES

The erratic Scatter Rap® action perfectly mimics a spooked baitfish trying to escape a predator's attack – and the evasive action of a baitfish trying to get out of a harm's way will draw reaction strikes from all predatory species. It's the movement no predator can resist.

The Scatter Lip creates the most evasive, erratic, aggressive sweeping action with directional and cadence changes that the fishing pros have always used to get the big and wary fish to bite. It's just that with the Scatter Rap® you don't have to be a seasoned pro with a wide arsenal of tackle and techniques. All that's needed is steady retrieve with minor changes in the retrieve speed, and the Scatter Rap® will do the catching.

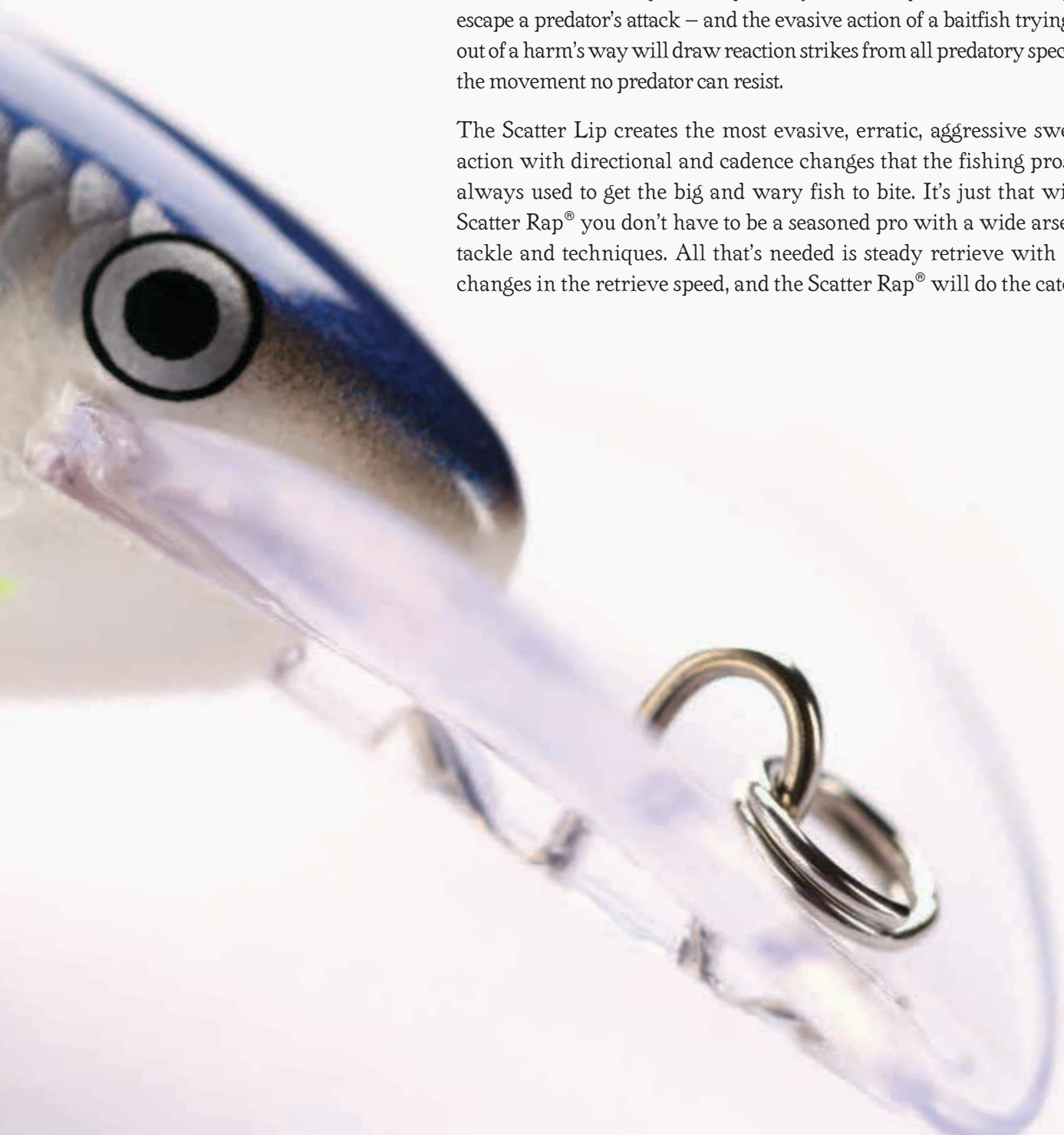

SCATTER RAP® COUNTDOWN®



Premium Balsa Wood Construction



Classic Rapala Foil, Painted or Metallic Finishes



Premium VMC® Black Nickel Hooks



Hand-Tuned & Tank-Tested For Perfection



Built with Scatter Lip®



ALB



AYU



FMN



FT



GALB



GFR



HS



P

Ideal for casting and finding fish consistently through the water column, the Scatter Rap® Countdown® combines the countdown method and the evasive action. A slower retrieve keeps the action subtle, but speed up the retrieve and let the underwater shenanigans begin. This is a chase the big predator does not want to lose.

- Balsa Body with Scatter Lip
- Wire Through Construction
- Evasive, Erratic, Silent
- Sinking, Countdown® Technique
- Cast or Trolled Variable Depths
- Multi-Species Gamefish
- VMC® Black Nickel Round Bend Hooks
- Hand-Tuned & Tank-Tested

SCATTER RAP® COUNTDOWN® SPECIFICATIONS

Model No.	Running Depth	Body Length	Weight	Hooks
SCRCD07	1.8 - 2.7	7 cm	7g	Two No. 6

ALB - Bleak; AYU - Ayu; FMN - Fire Minnow; FT - Firetiger;

GALB - Golden Alburnus; GFR - Gold Fluorescent Red;

HS - Hot Steel; P - Perch

SCATTER RAP® SHAD



Premium
Balsa Wood
Construction



Classic Rapala
Foil, Painted or
Metallic Finishes



Premium
VMC® Black
Nickel Hooks



Hand-Tuned
& Tank-Tested
For Perfection



Built with
Scatter Lip®



ALB



BG



CRSD

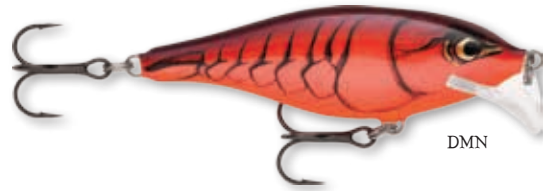

DMN



FT



GALB



P



SD

The legendary Shad Rap® body profile perfectly mimics common high-sided forage species. The erratic evasive action created by the Scatter Lip™ responds to retrieve speed. Slower retrieve speed creates a subtle sweep to the sides while a faster retrieve emphasizes the evasive action with aggressive direction changes and a tighter kicking action.

- Balsa Body with Scatter Lip
- Wire Through Construction
- Evasive, Erratic, Silent
- Floating
- Cast or Trolled Dives 1.5 - 2.4 m
- Multi-Species Gamefish
- VMC® Black Nickel Round Bend Hooks
- Hand-Tuned & Tank-Tested

SCATTER RAP® SHAD SPECIFICATIONS

Model No.	Running Depth	Body Length	Weight	Hooks
SCRS07	1.5 - 2.4 m	7 cm	7 g	Two No. 5
ALB - Bleak; BG - Blue Gill; CRSD - Caribbean Shad; DMN - Demon; FT - Firetiger; GALB - Golden Alburnus; P - Perch; SD - Shad				



SCATTER RAP® CRANK & SCATTER RAP® CRANK DEEP



Premium Balsa Wood Construction



Painted and Printed Finishes



Premium VMC® Black Nickel Hooks



Hand-Tuned & Tank-Tested For Perfection

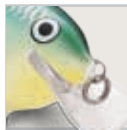

Built with Scatter Lip®



BB



BG



CRSD



DMN



FT



GFD



HM



RTA

A round-bodied crank bait that does everything a skilled angler can make a crank bait do with rod and reel tricks – but the Scatter Rap® Crank does it all on a steady retrieve. Irregular evasive action with side to side direction changes imitate the natural baitfish escape maneuvers.

- Balsa Body with Scatter Lip
- Wire Through Construction
- Evasive, Erratic, Silent
- Floating Dives 1.8 - 2.4 m
- Multi-Species Gamefish
- VMC® Black Nickel Round Bend Hooks
- Hand-Tuned & Tank-Tested

SCATTER RAP® CRANK SPECIFICATIONS

Model No.	Running Depth	Body Length	Weight	Hooks
SCRC05	1.8 – 2.4	5 cm	9 g	Two No. 5

BB - Baby Bass; BG - Blue Gill; CRSD - Caribbean Shad; DMN - Demon; FT - Firetiger; GFD - Girlfriend; HM - Hot Mustard; RTA - Rasta

Perfectly mimicking the spooked baitfish fleeing for its life, the Scatter Rap® lures have changed the way anglers fish. Now Rapala brings the Scatter Rap evasive action to the deep side of the water column. Swimming with the celebrated Scatter Rap action, the new Scatter Rap® Crank Deep is built to dive quickly and work in the 3-meter range.

- Balsa Body with Scatter Lip
- Evasive, Erratic Escaping Minnow Action
- Round Crank Bait Body
- Floating, Deep Diving Design
- VMC® Black Nickel Round Bend hooks

SCATTER RAP® CRANK DEEP SPECIFICATIONS

Model No.	Running Depth	Body Length	Weight	Hooks
DSCRC05	3.0 – 3.6	5 cm	9 g	Two No. 5

BB - Baby Bass; BG - Blue Gill; CRSD - Caribbean Shad; DMN - Demon; FT - Firetiger; GFD - Girlfriend; HM - Hot Mustard; RTA - Rasta



BX[®] SERIES

Combining the unmatched responsiveness of balsa with rugged durability of plastic, the Balsa Xtreme series opened a new era in fishing lures.

The patent pending BX[®] construction uses a tough, transparent plastic shell to encapsulate a balsa wood inner body. The perfectly balanced balsa core with precision placed weights gives the lure a lively, super responsive action that can be achieved only with balsa.

The tough copolymer outer shell allows ultimate toughness and life-like finishes with 3D scales, lateral line and gill plates with a combination of metallic, translucent and painted finishes unlike anything seen on balsa lures before.

Truly the ultimate combination.

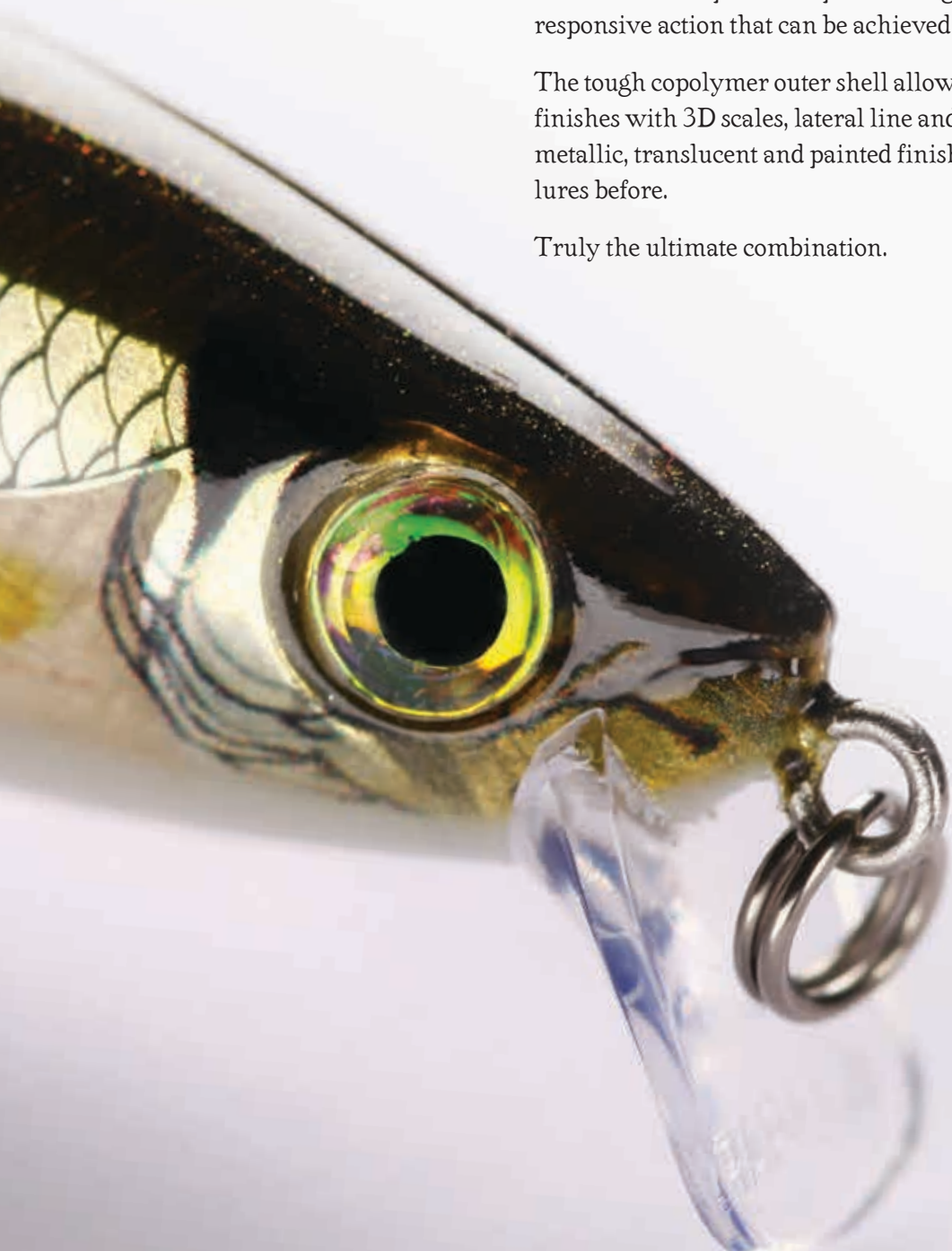

BX[®] MINNOW



Balsa Body Inside



Durable Copolymer Shell



Molded 3D Head, Gills and Scales

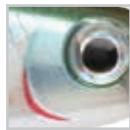

3D Holographic Eyes



Black Nickel VMC[®] Hooks



Hand-Tuned & Tank-Tested For Perfection



AYU



BBH



FT



GSH



HH



P



S



SMT

With the patent pending construction combining a balsa core with a durable copolymer outer body, the BX[®] Minnow features a super responsive action that comes alive with the slowest of retrieves and the most delicate twitches. Yet it can handle fast, aggressive retrieves and take a beating from toothy, strong predators. Precision weighted for perfect balance and long casting.

- Balsa Body Inside
- Durable Copolymer Shell
- Molded 3D Head, Gills and Scales
- Internal X-Foil
- Flat-Sided with Strong Flash on Roll
- VMC[®] Black Nickel Round Bend Hooks
- Floating
- Incredible Life-like Finishes
- 3D Holographic Eyes
- Hand-Tuned & Tank Tested

BX[®] MINNOW SPECIFICATIONS

Model No.	Running Depth	Body Length	Weight	Hooks
BXM07 <small>NEW</small>	0.6-1.2 m	7 cm	7 g	Two No. 6
BXM10	0.9-1.5 m	10 cm	12 g	Two No. 4

AYU - Ayu; BBH - Blue Back Herring; FT - Firetiger; GSH - Gold Shiner; HH - Hot Head; P - Perch; S - Silver; SMT - Smelt

BX[®] WAKING MINNOW



Balsa Body
Inside



Durable
Copolymer
Shell



Molded
3D Head, Gills
and Scales



3D Holographic
Eyes



Black Nickel
VMC[®]
Hooks



Hand-Tuned
& Tank-Tested
For Perfection



BBH



FT



GSH



SDW



SMT



YP

A surface waking bait that swims with such incredible performance that it has to be built this tough to endure. Featuring a wide rolling action, when fished with the rod tip held high the BX[®] Waking Minnow rides right on the surface and leaves a noticeable wake and bubble trail behind. Built with a responsive and buoyant balsa core that's encapsulated by a hard protective plastic shell for durability and life-like detail.

- Surface Waking Action
- Responsive Balsa Core
- Durable Copolymer Shell
- Incredible Life-Like Finishes
- Designed For Slow Presentation
- Floating
- VMC[®] Black Nickel Round Bend Hooks

BX[®] WAKING MINNOW SPECIFICATIONS

Model No.	Running Depth	Body Length	Weight	Hooks
BXWM13	Topwater	13 cm	22 g	Two No. 5

BBH - Blue Back Herring; FT - Firetiger; GSH - Gold Shiner;
SDW - Shadow; SMT - Smelt; YP - Yellow Perch

BX[®] JOINTED MINNOW



Premium Balsa Wood Construction



Tough Copolymer Exterior



Articulated Broken Back Design



Internal Holographic Flash Foil



Molded Head, Gills, Scales and Holographic Eye



Premium VMC[®] Black Nickel Hooks



Hand-Tuned & Tank-Tested For Perfection



AYU



BBH



BG



GF



RFP



SMT

Following in the footsteps of the legendary Rapala Jointed[®], the BX[®] Jointed Minnow has a strong kicking action with the added noise and vibration from the articulated body. Tough copolymer outer shell adds durability and life-like details. Very responsive to slow retrieves. Slow-rising on the pause.

- Balsa Core Copolymer Shell
- Kicking Action
- Floating
- Cast or Trolled Dives 1.8 - 2.4
- Multi-Species Gamefish
- VMC Black Nickel Round Bend Hooks
- Hand-Tuned & Tank-Tested

BX[®] JOINTED MINNOW

Model No.	Running Depth	Body Length	Weight	Hooks
BXJM09	1.8 - 2.4 m	9 cm	8 g	Two No. 6
AYU - Ayu; BBH - Blue Back Herring; BG - Bluegill; GF - Gold Fish; RFP - Redfin Perch; SMT - Smelt				





BX[®] JOINTED SHAD



Premium Balsa Wood Construction



Tough Copolymer Exterior



Articulated Broken Back Design

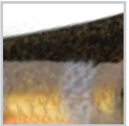

Internal Holographic Flash Foil



Molded Head, Gills, Scales and Holographic Eye



Premium VMC[®] Black Nickel Hooks



Hand-Tuned & Tank-Tested For Perfection



AYU



BBH



BG



GF



RFP



SMT

Built with a balsa core and a durable outer shell, the BX[®] Jointed Shad is very responsive to even the slowest retrieves, yet features a very strong, body kicking action and tracks straight at high speeds. Near-neutral buoyancy with super slow rise on the pause allows for slow, yet aggressive presentations.

- Balsa Core Copolymer Shell
- Kicking Action
- Floating
- Cast or Trolled Dives 1.2-1.8 m
- Multi-Species Gamefish
- VMC Black Nickel Round Bend Hooks
- Hand-Tuned & Tank-Tested

BX[®] JOINTED SHAD

Model No.	Running Depth	Body Length	Weight	Hooks
BXJSD06	1.2 - 1.8 m	6 cm	7g	Two No. 8
AYU - Ayu; BBH - Blue Back Herring; BG - Bluegill; Herring; GF - Gold Fish; RFP - Redfin Perch; SMT - Smelt				



CLACKIN' SERIES

More than just a noisy lure, the Clackin' Series builds on the proven success of the uniquely designed sound chamber first introduced with the Clackin' Rap[®].

The single steel ball and trademark exposed rattle chamber transmit a distinctive clackin' sound and maximum vibration.

In union with the translucent bodies, the seductive flash of internal holographic foil and the legendary Rapala swimming action, they create a full sensory stimulation fish cannot resist.

Rapala



CLACKIN' MINNOW®



Signature Clackin' Cadence Rattle



Rapala Swimming Action



Tough X-Style Finish & Holographic Eye



Premium VMC Black Nickel Hook



Hand-Tuned & Tank-Tested For Perfection



CLN



FT



GGH



OG



S



TOSD

The Clackin' Minnow® features a long-casting, slow-sinking minnow body profile. Awarded the "Best of the Best" for new lures by Field & Stream magazine in 2011. Rapala "wounded-minnow" action.

- Signature Clackin' Cadence Rattle
- Shallow Running Lip Design
- Slow-Sinking
- Flash Feather Teaser Tail
- VMC Black Nickel Round Bend Hooks
- X-Style Finish
- Hand-Tuned & Tank-Tested

CLACKIN' MINNOW SPECIFICATIONS

Model No.	Running Depth	Body Length	Weight	Hooks
CNM07	0.6 - 1.2 m	7 cm	7 g	Two No. 8
CNM09	0.9 - 1.2 m	9 cm	13 g	No. 5 & No. 6

CLN - Clown; FT - Firetiger; GGH - Glass Ghost; OG - Olive Green; S - Silver; TOSD - Tennessee Olive Shad





MAXRAP[®] SERIES

Maximum Performance and Premium Components. Striving for the utmost in lure design, the MaxRap[®] concept focuses on a single, primary function and complements the design with every imaginable maximum feature like laser-engraved scales, Needle Sharp VMC[®] hooks and like superior quality components.

A lifetime in the fishing business teaches you that discriminating anglers demand the best. Modern anglers demand the MaxRap[®].



MAXRAP®



MaxCast
Internal Casting
Mechanism

Unique
MaxRap®
Action

Incredible Flake
Hand Painted
Finish

Premium VMC®
Spark Point
Hooks

Hand-Tuned
& Tank-Tested
For Perfection



FAYU



FG



FGFR



FHB



FHC



FPGH



FRH



PCD

Tip to tail, everything about the MaxRap® is premium. Designed for maximum casting distances via internal MaxCast mechanism. Rip for darting, wild searching action or straight retrieve for hard-flashing “wounded-minnow” Rapala wobble.

- Internal MaxCast Mechanism
- Balanced with Tungsten Balls for Accuracy
- Aerodynamic Body Shape
- Premium VMC® Spark Point® Hooks
- Suspending on Pause
- Oval Line Tie Ring
- Internal Laser Etched Scales
- Deep 3D Holographic Eyes
- Hand-Tuned & Tank-Tested

MAXRAP® SPECIFICATIONS

Model No.	Running Depth	Body Length	Weight	Hooks
MXR11	0.3 - 0.9 m	11 cm	13 g	Two No. 6
MXR13	0.3 - 0.9 m	13 cm	15 g	Three No. 6

FAYU - Fluke Ayu; FG - Fluke Green; FGFR - Fluke Gold Fluorescent Red; FHB - Fluke Hot Blue; FHC - Fluke Hot Chartreuse; FPGH - Fluke Purple Ghost; FRH - Fluke Red Head; PCD - Pink Candy

MAXRAP® FAT SHAD



MaxCast Internal Casting Mechanism



Quick Diving Action



Premium Finishes



Premium VMC® Spark Point Hooks



Hand-Tuned & Tank-Tested For Perfection

UV BRIGHT UV BRIGHT FINISH REFLECTS MORE LIGHT ENERGY, STRENGTHENING THE LURE'S VISIBILITY.



FAYU



FG



FGFR



FHC



FSS



FT



PRTU
UV
BRIGHT



YGRU
UV
BRIGHT

Round-bodied and high-sided, the MaxRap® Fat Shad features a strong tail-kicking action with a slight body roll. Very responsive to slow presentations. Slight irregularities and hesitation in the swimming action create a very natural and life-like movement. Slow rising on the pause, but dives quickly to the target depth and stays there. Internal MaxCast mechanism for long and accurate casts.

- Internal MaxCast Mechanism
- Balanced with Tungsten Balls for Accuracy
- Medium Slow Rising on Pause
- Internal Laser Etched Scales
- Premium VMC® Spark Point Hooks
- Deep 3D Holographic Eyes
- Hand-Tuned & Tank-Tested

MAXRAP® FAT SHAD SPECIFICATIONS

Model No.	Running Depth	Body Length	Weight	Hooks
MXRFS05	2.4 - 3.6	5 cm	8 g	Two No. 8
FAYU - Flake Ayu; FG - Flake Green; FGFR - Flake Gold Fluorescent Red; FHC - Flake Hot Chartreuse; FSS - Flake Silver Steel; FT - Firetiger; PRTU - Parrot UV; YGRU - Yellow Green Red UV				



MAXRAP® FAT MINNOW



MaxCast Internal Casting Mechanism



Quick Diving Action



Premium Finishes



Premium VMC® Spark Point Hooks



Hand-Tuned & Tank-Tested For Perfection



UV BRIGHT FINISH REFLECTS MORE LIGHT ENERGY STRENGTHENING THE LURE'S VISIBILITY.



FAYU



FG



FGFR



FHC



FSS



FT



PRTU
UV BRIGHT



YGRU
UV BRIGHT

Designed with a custom lip for diving quickly into the target depth and equipped with a patented Max Cast mechanism for long and accurate cast, the MaxRap® Fat Minnow brings maximum performance to your arsenal. The round-bodied minnow body has a tight, tail-kicking action and tracks straight even at high speeds, but is also very responsive to slow presentations. Slow rising on the pause.

- Internal MaxCast Mechanism
- Balanced with Tungsten Balls for Accuracy
- Aerodynamic Body Shape
- Slow Rising on Pause
- Internal Laser Etched Scales
- Premium VMC® Spark Point Hooks
- Deep 3D Holographic Eyes
- Hand-Tuned & Tank-Tested

MAXRAP® FAT MINNOW SPECIFICATIONS

Model No.	Running Depth	Body Length	Weight	Hooks
MXRFM09	2.4 - 3 m	9 cm	13 g	Two No. 6
FAYU - Flake Ayu; FG - Flake Green; FGFR - Flake Gold Fluorescent Red; FHC - Flake Hot Chartreuse; FSS - Flake Silver Steel; FT - Firetiger; PRTU - Parrot UV; YGRU - Yellow Green Red UV				



XXX-RAP[®] SERIES

Built with a single guideline in mind; absolute durability, the XXX-Rap[®] Series lures are designed to perform in the harshest conditions and withstand brutal punishment. They are quipped with strong VMC[®] hooks and constructed with heady-duty components to make sure you'll have the best possible chance to land the priced trophy you are after.

Yet, while they are heavy-duty in all other aspects, the XXX-Rap[®] series lures are very responsive, have strong action and are responsive to twitching and jerking. This allows a multitude of natural, life-like and aggressive presentations that appeal to all game fish species.

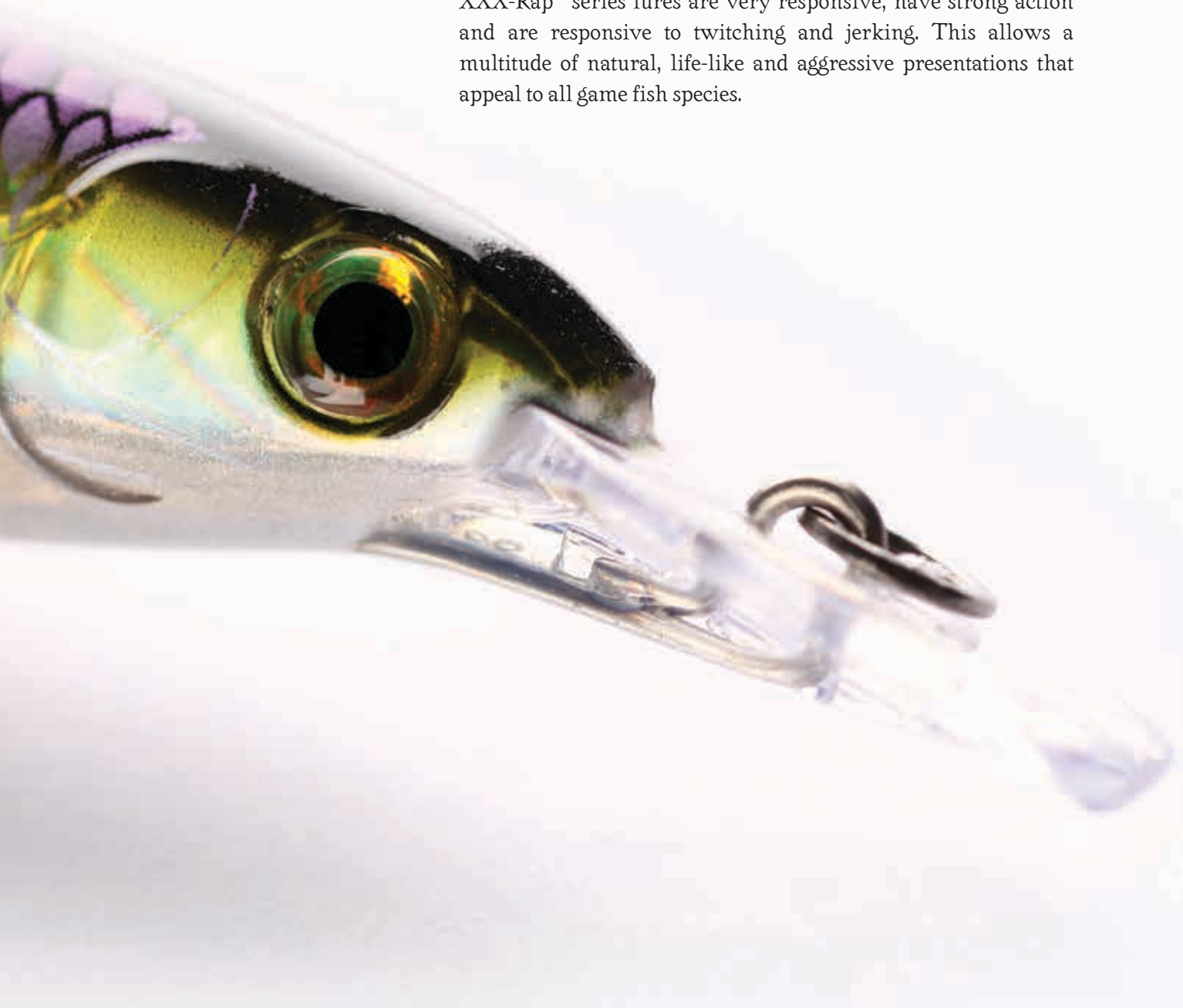

XXX-RAP®



Premium VMC®
Perma Steel®
Hooks



Life-like
finish

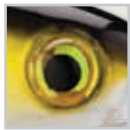

3D
Eyes



Heavy Duty



Hand-Tuned
& Tank-Tested
For Perfection



UV BRIGHT FINISH
REFLECTS MORE
LIGHT ENERGY,
STRENGTHENING
THE LURE'S VISIBILITY.



AS



BNY



GHU
UV
BRIGHT



HH



HPU
UV
BRIGHT



OC



PBH



YEM

Designed to target brutal predators, the XXX-Rap® is built super tough and equipped with heavy-duty VMC® Perma Steel hooks for ultimate durability and performance. The XXX-Rap® features an extreme rolling and wobbling action, yet has minimal resistance on the retrieve, making it ideal for high speed presentations. Responds well to twitching. Detailed natural and attractor patterns.

- XXX Heavy-duty construction
- Life-Like and Attractor Patterns
- X-Rap® Finish with Internal Holographic Foil
- Extreme Swimming Action
- Responds Well to Twitching and Jerking
- Heavy-Duty VMC® Perma Steel Hooks
- Hand Tuned & Tank Tested

XXX-RAP® SPECIFICATIONS

Model No.	Running Depth	Body Length	Weight	Hooks
XXXR10	1.5 m	10 cm	14 g	Two No. 4

AS - Albino Shiner; BNY-Bony; GHU - Ghost UV; HH - Hot Head; HPU - Hot Pink UV; OC - Olive Cherabin; PBH - Purple Back Herring; YEM - Yellow Eyed Mullet

XXX-RAP® CAST



In-Line Single Hook

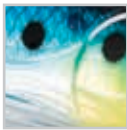

Life-like finish



3D Eyes



Heavy Duty



Hand-Tuned & Tank-Tested For Perfection



BSRD



CG



FUS



GH



GSRD



HCHU **UV BRIGHT**



HGP



RH



S



WHU **UV BRIGHT**

Built with extreme casting distances in mind, the super durable and heavily weighted XXX-Rap® Cast will not let you down when the fish are busting bait far off. In addition to the ultimate castability, the XXX-Rap® Cast features a heavy-duty construction and in-line VMC® single hooks to stand up for big predators. With its extreme rolling and wobbling action, the XXX-Rap® Cast is designed for high speed presentations and responds well to twitching. Flutters down on the drop.

- Designed for XXX Casting Distances
- Heavy-Duty Construction
- Extreme Rolling and Wobbling Action
- Minimal Resistance, Designed for High Speed Presentations
- Responds Well to Twitching and Jerking
- Baitfish and Attractor Patterns with Metallic Inserts
- Heavy-Duty VMC® In-Line Single Hooks
- Sinking, Flutters Down On The Drop

XXX-RAP® CAST SPECIFICATIONS

Model No.	Running Depth	Body Length	Weight	Hooks
XXXRC14	1.5	14 cm	54 g	Two No. 5/0
BSRD - Blue Sardine; CG- Pearl Orange; FUS - Fusilier; GH - Ghost; GSRD - Green Sardine; HCHU - Hot Chartreuse UV; HGP - Hot Gold Pink; RH - Red Head; S - Silver; WHU - Wahoo UV				



X-RAP[®]

SERIES

You never forget the first time you threw an X-Rap[®]. The slow-rolling flash on a steady retrieve. The way a hard snap or twitch sends it into action. An action so unique it spawned a whole new category – the Slashbait[®]. Let's face it. The X-Rap[®] finish can't be beat. Just the right color patterns, all with internal holographic foils, 3D holographic eyes, internal textured scales and gills.

Each verifies the extreme in lure design. Grown to include 13 lure families for both freshwater and saltwater applications, there is an X-Rap[®] for any fishing excursion.



X-RAP®₆



Internal Long Cast System



Original Slashbait Action



UV Colors

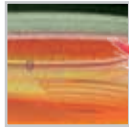

Internal Textured Scales, Gills & Lateral Line



Flash Feather Tail Hook



Hand-Tuned & Tank-Tested For Perfection



AYU



GGH



MD



OG



P



S

Small versions of the X-Rap® are ideal for targeting smaller species – or as small, snack-sized offerings for big predators that are finicky and won't bite bigger lures. Perfectly balanced for long and accurate casts and packed with the same features as the bigger brothers.

- Slashbait® Action
- Suspending on Pause
- Textured Translucent Body
- Internal Holographic Foil
- Internal Long-Cast System (XR04 excluded)
- 3D Holographic Eye
- VMC® Black Nickel Round Bend Hooks
- Flash Feather Teaser Tail
- Hand-Tuned & Tank-Tested

X-RAP SPECIFICATIONS

Model No.	Running Depth	Body Length	Weight	Hooks
XR06	0.9 - 1.5 m	6 cm	4g	Two No. 10

AYU - Ayu; GGH - Glass Ghost; MD - Muddler; OG - Olive Green; P - Perch; S - Silver

X-RAP® 8, 10

CLN



GGH



HH



HS



OG



P



RVP



S



SB



SLK

The X-Rap® is “all about the action.” It’s the perfect size, shape and 3D illusion of a minnow. Prominent scales and lateral line on the fuselage capture and flash light like a beacon. It can be fished both in an aggressive “Slashbait™” technique or with a classic Rapala wobble. The angler defines the cadence for maximum effectiveness.

- Slashbait® Action
- Suspending on Pause
- Textured Translucent Body
- Internal Holographic Foil
- Internal Long-Cast System
- 3D Holographic Eye
- VMC® Black Nickel Round Bend Hooks
- Flash Feather Teaser Tail
- Hand-Tuned & Tank-Tested

X-RAP SPECIFICATIONS

Model No.	Running Depth	Body Length	Weight	Hooks
XR08	0.9 - 1.5 m	8 cm	7 g	No. 6 & 7
XR10	1.2 - 1.8 m	10 cm	13 g	No. 4 & 5

CLN - Clown; GGH - Glass Ghost; HH - Hot Head; HS - Hot Steel;
OG - Olive Green; P - Perch; RVP - River Perch; S - Silver;
SB - Silver Blue; SLK - Slick



Consistent Depth Control



Strong Rolling Action



X-Style Finish



Black Nickel VMC® Hooks



Hand-Tuned & Tank-Tested For Perfection



X-RAP® COUNTDOWN®



ALB



AYU



BSRD



GALB



GGH



HH



OG



RH



S

Fish the Xtreme Attitude consistently at any depth. Based on the CountDown® method introduced by Rapala in the 1960s, the X-Rap® CountDown® brings modern X-Style finishes and details to the game. It swims with a strong rolling action and flutters down on the pause. The X-Rap® CountDown® sinks 30% faster than the classic CD. Due to its weight and body design, the X-Rap® CountDown® is also very long casting.

- Consistent Depth Control
- Strong Rolling Action
- Flutter Action On Drop
- Sinking
- X-Rap Finish
- 3D Holographic Eye
- VMC® Black Nickel Round Bend Hooks
- Hand-Tuned & Tank-Tested

X-RAP® COUNTDOWN® SPECIFICATIONS

Model No.	Running Depth	Body Length	Weight	Hooks
XRCD05	0.6-1.2 meters	5 cm	4 g	Two No. 10
XRCD07	0.9-1.5 meters	7 cm	10 g	Two No. 6

ALB - Bleak; AYU - Ayu; BSRD - Blue Sardine; GALB - Gold Alburnus; GGH - Glass Ghost; HH - Hot Head; OG - Olive Green; RH - Red Head; S - Silver

X-RAP® DEEP



Internal Long Cast System



Deep Diving Slashbait Action



Internal Textured Scales, Gills & Lateral Line



Flash Feather Tail Hook



Hand-Tuned & Tank-Tested For Perfection



CLN



GGH



HH



OG

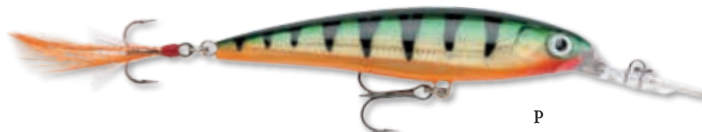

P



S



SB

The X-Rap® Deep rockets towards the bottom with all the positive characteristics that has made the X-Rap® legendary. Fish with a stop and go for enticing suspending action or slow-wind for classic Rapala “wounded-minnow” action.

- Slashbait® Action
- Deep Diving Lip
- Suspending on Pause
- Textured Translucent Body
- Internal Holographic Foil
- Internal Long-Cast System
- 3D Holographic Eye
- Flash Feather Teaser Tail
- VMC® Black Nickel Round Bend Hooks
- Hand-Tuned & Tank-Tested

X-RAP® DEEP SPECIFICATIONS

Model No.	Running Depth	Body Length	Weight	Hooks
XRD10	1.8 - 4.5 m	10 cm	13g	No. 4 & 5

CLN - Clown; GGH - Glass Ghost; HH - Hot Head; OG - Olive Green; P - Perch; S - Silver; SB - Silver



BOSS
MADE IN U.S.A.

X-RAP® POP



UV BRIGHT FINISH
REFLECTS MORE
LIGHT ENERGY,
STRENGTHENING
THE LURE'S VISIBILITY.



Internal Long Cast System



Deep Cupped Lip Design



Internal Textured Scales, Gills and Fins



Premium VMC® Black Nickel Hooks



Flash Feather Tail Hook



CGH



CLN



FTU
UV
BRIGHT



GHU
UV
BRIGHT



HT



RH

Big poppin'. Big splashin'. Big smashin'. The X-Rap® Pop brings X-Rap® Attitude to topwater. Arched body shape sets lure up for a large kerplunk-pop and splash with every snap. Even the slightest tug and the X-Pop comes to life.

- Deep Cupped Lip
- Loud Pop and Splash
- Internal Long Cast System
- 3D Holographic Eye
- VMC® Black Nickel Round Bend Hooks
- Flash Feather Teaser Tail
- X-Rap® Finish

X-RAP® POP SPECIFICATIONS

Model No.	Running Depth	Body Length	Weight	Hooks
XRP07	Topwater	7 cm	11 g	Two No. 5

CGH - Chartreuse Ghost; CLN - Clown; FTU - Firetiger UV;
GHU - Ghost UV; HT - Hot Tiger; RH - Red Head

X-RAP® PROP



Stainless Steel
Nose & Tail
Propellers



Internal Textured
Scales, Gills
and Fins



Premium VMC®
Black Nickel
Hooks



Flash Feather
Tail Hook



CGH



GO



HT



PGS



RH



S

Topwater prop bait with an X-Rap® attitude. Stainless Steel props create X-size noise and splash, while counter-rotating design stabilizes and keeps you on a straight track back.

- Stainless Steel Propellers
- Counter-Rotating Design Tracks Straight
- 3D Holographic Eye
- VMC® Black Nickel Round Bend Hooks
- Flash Feather Teaser Tail
- X-Rap Finish

X-RAP® PROP SPECIFICATIONS

Model No.	Running Depth	Body Length	Weight	Hooks
XRPR11	Topwater	11 cm	11 g	Three No. 6
CGH - Chartreuse Ghost; GO - Gold Olive; HT - Hot Tiger; PGS - Pearl Grey Shiner; RH - Red Head; S - Silver				

X-RAP® SALTWATER



Internal Long Cast System



Xtreme Slashbait Action

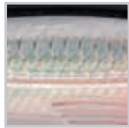

Internal Textured Scales, Gills & Lateral Line



Premium VMC® Perma Steel® Hooks



Hand-Tuned & Tank-Tested For Perfection



UV BRIGHT FINISH REFLECTS MORE LIGHT ENERGY STRENGTHENING THE LURE'S VISIBILITY.



AYU



BSRD



NEW

HCHU
UV BRIGHT



HPU
UV BRIGHT



RHU
UV BRIGHT



SBM



SPM



NEW

WHU
UV BRIGHT

The X-Rap® Saltwater lures are designed for trolling or casting. Trolls with classic Rapala “wounded-minnow” wobble. Rip it for extreme, erratic Slashbait® attraction.

- X-Rap® Slashbait® Action
- Textured Translucent Body
- Internal Long-Cast Mechanism
- X-Rap® Finish
- 3D Holographic Eye
- Suspending on Pause
- VMC® Perma Steel® Hooks
- Perfect Match Saltwater Patterns
- Hand-Tuned & Tank-Tested

X-RAP® SALTWATER SPECIFICATIONS

Model No.	Running Depth	Body Length	Weight	Hooks
SXR10	1.2 - 1.8 m	10 cm	13 g	Two No. 3
SXR12	1.2 - 2.4 m	12 cm	22 g	Two No. 2
SXR14	1.2 - 2.4 m	14 cm	43 g	Two No. 2/0

AYU - Ayu; BSRD - Blue Sardine; HCHU - Hot Chartreuse UV; HPU - Hot Pink UV; RHU - Red Head UV; SBM - Silver Blue Mackerel; SPM - Spotted Minnow; WHU - Wahoo UV

X-RAP® SHAD



Internal Long Cast System

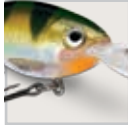

Shad Profile with X-Rap Action



Internal Textured Scales, Gills & Lateral Line



Flash Feather Tail Hook



Hand-Tuned & Tank-Tested For Perfection



FT



GGH



P



PSYP



S



SB

The legendary Shad body shape from Rapala with X-Rap® Attitude. Integrated long-casting system partners with an irresistible rattle to offer classic Rapala swimming action or X-Rap® Xtreme attitude action. Fish it hard and fast, or slow and easy – either way hang on.

- X-Rap® Xtreme Attitude Action
- Suspending on Pause
- Internal Textured Finishes
- Internal Rattle System
- Internal Long-Cast Mechanism
- 3D Holographic Eye
- VMC® Black Nickel Round Bend Hooks
- Flash Feather Teaser Tail
- Hand-Tuned & Tank-Tested

X-RAP® SHAD SPECIFICATIONS

Model No.	Running Depth	Body Length	Weight	Hooks
XRS06	1.8 - 3.3 m	6 cm	9 g	No. 5 & 6
XRS08	2.1 - 4.5 m	8 cm	14 g	Two No. 4

FT - Firetiger; GGH - Glass Ghost; P - Perch; PSYP - Psycho Pink; S - Silver; SB - Silver Blue

X-RAP® MAGNUM®



Rugged Deep Diving Lip
 Big Water Patterns with X-Rap® Finish
 4X Strong VMC® Perma Steel® Hooks



BSRD



BTO



CG



FT



GGM



HH



RH



S



SB



SBM

The precision diving-lip takes the X-Rap® Magnums deep unassisted. Nothing to hinder the action. Each dives to its preset depth – the XRMag10 to 10 feet, the XRMag15 to 15 feet, etc. Run up to 13 knots for big game fish worldwide.

- Depth Specific Diving Lip
- Models with Colored Lip for Extra Attraction
- Textured Translucent Body
- Internal Holographic Foil
- X-Rap® Finish
- 3D Holographic Eye
- VMC® 4X Strong Perma Steel® Hooks
- 3X Split Rings
- Big Water Patterns

X-RAP® MAGNUM® SPECIFICATIONS

Model No.	Running Depth	Body Length	Weight	Hooks
XRMAG15	15/4.5 m	12 cm	32 g	Two No. 1/0
XRMAG20	20/6 m	14 cm	46 g	Two No. 2/0
XRMAG30	30/9 m	16 cm	72 g	Two No. 4/0

BSRD - Blue Sardine; BTO - Bonito; CG - Pearl Orange; FT - Firetiger; GGM - Gold Green Mackerel; HH - Hot Head; RH - Redhead; S - Silver; SB - Silver Blue; SBM - Silver Blue Mackerel

X-RAP® MAGNUM® UV

UV BRIGHT FINISH
REFLECTS MORE LIGHT ENERGY,
STRENGTHENING THE LURE'S VISIBILITY.



Rugged Deep Diving Lip
Big Water Patterns with X-Rap® Finish
4X Strong VMC® Perma Steel® Hooks



GGHU
UV
BRIGHT



HCHU
UV
BRIGHT



HPU
UV
BRIGHT



RHU
UV
BRIGHT



SFU
UV
BRIGHT



WHU
UV
BRIGHT



YFU
UV
BRIGHT

The precision diving-lip takes the X-Rap® Magnums deep unassisted. Nothing to hinder the action. Each dives to its preset depth – the XRMag10 to 10 feet, the XRMag15 to 15 feet, etc. Run up to 13 knots for big game fish worldwide.

- Depth Specific Diving Lip
- Models with Colored Lip for Extra Attraction
- Textured Translucent Body
- Internal Holographic Foil
- X-Rap® Finish
- 3D Holographic Eye
- VMC® 4X Strong Perma Steel® Hooks
- 3X Split Rings
- Big Water Patterns

X-RAP® MAGNUM® UV SPECIFICATIONS

Model No.	Running Depth	Body Length	Weight	Hooks
XRMAG15	15/4.5 m	12 cm	32 g	Two No. 1/0
XRMAG20	20/6 m	14 cm	46 g	Two No. 2/0
XRMAG30	30/9 m	16 cm	72 g	Two No. 4/0

GGHU - Glass Ghost UV; HCHU - Hot Chartreuse UV; HPU - Hot Pink UV; RHU - Red Head UV; SFU - Sailfish UV; WHU - Wahoo UV; YFU - Yellow Fusilier UV



CLASSIC SERIES

Carrying on a tradition that started in 1936, the original wounded-minnow action is what has made Rapala® “The world’s most trusted lure.” Premium balsa gives them their responsive, life-like action, while the craftsmanship and dedication to excellence makes sure that each and every lure swims like the first. Before leaving the factory, each is inspected, hand-tuned and tank-tested for the superior quality these lures are known for.

That’s why no matter where you go in the world, big fish eat little fish that swim just like a Rapala®.



COUNTDOWN®



Premium Balsa Wood Construction



Controlled Depth Sinking Rate



Premium VMC® Black Nickel Treble Hooks



Hand-Tuned & Tank-Tested For Perfection



UV BRIGHT FINISH REFLECTS MORE LIGHT ENERGY, STRENGTHENING THE LURE'S VISIBILITY.



COUNTDOWN® 01 & 03 COLOR PATTERNS



COUNTDOWN® 05 & 07 COLOR PATTERNS



COUNTDOWN® 05 & 07 CUSTOM HD LIVE SERIES COLOR PATTERNS



Consistently reach suspended fish at any depth with the Countdown®. Whether the fish are suspending at certain depths, at the weed tops or on bottom structure, the Countdown® can get you to them consistently. Weighted lure creates slow-rolling Rapala® action.

- Balsa Construction
- Custom Swimming Action
- Controlled Depth Technique
- Large Size Range
- VMC® Black Nickel Hooks
- Hand-Tuned & Tank-Tested

COUNTDOWN® SPECIFICATIONS

Model No.	Running Depth	Body Length	Weight	Hooks
CD01	0.3 - 0.9 m	2.5 cm	2.7 g	One No. 12
CD03	0.6 - 0.9 m	3 cm	4 g	Two No. 12
CD05	0.9 - 1.8 m	5 cm	5 g	Two No. 10
CD07	1.5 - 2.4 m	7 cm	8 g	Two No. 7

ALB - Bleak; BJRT - Balsa Juvenile Rainbow Trout; FRHF - Red Hologram Flake; FT - Firetiger; GALB - Gold Alburnus; GFR - Gold Fluorescent Red; GJTR - Gold Juvenile Trout; MD - Muddler; OCV - Orange Tiger; OTU - Orange Tiger UV; P - Perch; PEL - Live Perch; PRLU - Pearl UV

COUNTDOWN[®] MAGNUM[®]

UV BRIGHT
 UV BRIGHT FINISH
 REFLECTS MORE
 LIGHT ENERGY,
 STRENGTHENING
 THE LURE'S VISIBILITY.



Super Tough
 African
 Abachi Wood



Controlled
 Sinking Rate &
 Deep Diving Lip



VMC[®] Hooks
 & Stainless
 Hardware



Hand-Tuned
 & Tank-Tested
 For Perfection



The world's number one saltwater hardbodied lure and No. 1 choice for open water trolling. Controlled sinking rate is perfect for fishing suspended fish or submerged growth and structure. Deep diving lip with Rapala[®] "wobble" action.

- Super Tough Abachi Wood Construction
- Controlled Sinking Model
- Deep Diving Metal Lip
- Anti-Broach Design
- Rugged Stainless Hardware
- Natural and Stimulator Patterns
- Sinking
- VMC[®] Perma Steel[®] Hooks
- Hand-Tuned & Tank-Tested

COUNTDOWN[®] MAGNUM[®] SPECIFICATIONS

Model No.	Running Depth	Body Length	Weight	Hooks
CDMAG07	2.7 - 3.3 m	7 cm	12 g	Two No. 3
CDMAG09	3.6 - 4.2 m	9 cm	17 g	Two No. 2
CDMAG11	3.9 - 4.5 m	11 cm	24 g	Two No. 1
CDMAG14	4.5 - 5.4 m	14 cm	36 g	Two No. 2/0
CDMAG18	5.4 - 6.3 m	18 cm	70 g	Two No. 4/0
CDMAG22	5.4 - 7.5 m	22 cm	100 g	Two No. 7/0*

BSRD - Blue Sardine; BTO - Bonito; CG - Pearl Orange; CH - Chrome; FT - Firetiger; GFR - Gold Fluorescent Red; GM - Green Mackerel; HPU - Hot Pink UV; RH - Redhead; RHU - Red Head UV; S - Silver; SB - Silver Blue; SM - Silver Mackerel; SRD - Sardine; WHU - Wahoo UV; YFU - Yellow Fusilier UV
 (CDMAG22 only available in RH & SM) (CDMAG07 & CDMAG09 not available in BTO, GFR, HPU, RHU, SRD, WHU & YFU)

DEEP TAIL DANCER®



Premium Balsa Wood Construction



Large Lip Enhances Swimming Action



Tapered Tail for Wide Swinging Tail Action

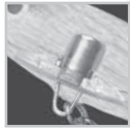

Rapala® Internal Rattle Mechanism



Premium VMC® Black Nickel Treble Hooks



Hand-Tuned & Tank-Tested For Perfection



UV BRIGHT FINISH REFLECTS MORE LIGHT ENERGY, STRENGTHENING THE LURE'S VISIBILITY.



UV SERIES COLORS



Banana-style body swims with wide tail action. The Deep Tail Dancer® features an enlarged, extreme diving lip that plummets the lures as deep as 9 meters unassisted.

- Deep Diving Lip
- Wide Tail Swimming Action
- Balsa Wood Construction
- Internal Rattle Mechanism
- Floating
- VMC® Black Nickel Hooks
- Hand-Tuned & Tank-Tested

DEEPTAIL DANCER SPECIFICATIONS

Model No.	Running Depth	Body Length	Weight	Hooks
TDD07	4.5 m	7 cm	9 g	Two No. 5
TDD09	6 m	9 cm	13 g	Two No. 3

BLT - Bleeding Tiger; CARP - Carp; CLF - Clown Flash; FLP - Flash Perch; GF - Goldfish; GGS - Glow Grey Shiner; GTU - Green Tiger UV; HS - Hot Steel; HT - Hot Tiger; OCW - Orange Tiger; OTU - Orange Tiger UV; PRT - Parrot; RDT - Red Tiger; SD - Shad

MINI FAT RAP®



Premium Balsa Wood Construction



Shallow Diving Lip Design

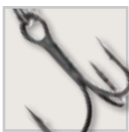

Premium VMC® Black Nickel Treble Hooks



Hand-Tuned & Tank-Tested For Perfection



FRHF



FT



GFR



OCW



P



S

For convincing finicky fish to bite, the tight swimming action is just right. The sinking Mini Fat Rap® works with unmatched action for attracting trout and other smaller predators.

- Compact Body Design
- Balsa Wood Construction
- Tight Swimming Action
- Shallow Running
- Slow-Sinking
- Hand-Tuned & Tank-Tested

MINI FAT RAP SPECIFICATIONS

Model No.	Running Depth	Body Length	Weight	Hooks
MFR03	0.9 - 1.8 m	3 cm	4 g	Two No. 12

FRHF - Red Hologram Flake; FT - Firetiger; GFR - Gold Fluorescent Red; OCW - Orange Tiger; P - Perch; S - Silver

SHAD RAP®



Premium Balsa Wood Construction



VMC® Black Nickel Hooks



Classic Rapala Foil or Painted Finishes



Hand-Tuned & Tank-Tested For Perfection



ALB



CARP



DMN



FP



FT



GF



HT



JP



P



S



SB



SD



SFC

The Shad Rap® is equally effective whether cast or trolled and is designed to be fished from ultra-slow speeds to super-fast with superior results.

- Classic Rapala Action
- Balsa Wood Construction
- Diving Lip Design
- Floating
- Natural Baitfish Profile
- VMC® Black Nickel Hooks
- Hand-Tuned & Tank-Tested

SHAD RAP® SPECIFICATIONS

Model No.	Running Depth	Body Length	Weight	Hooks
SR05	1.2 - 2.7 m	5 cm	6 g	Two No. 6
SR07	1.5 - 3.3 m	7 cm	8 g	Two No. 5
SR09	2.4 - 4.5 m	9 cm	15 g	Two No. 3

ALB - Bleak; CRSD - Caribbean Shad; DMN - Demon; FP - Fire Perch; FT - Firetiger; GF - Goldfish; HT - Hot Tiger; JP - Jungle Perch; LBL - Live Largemouth Bass; P - Perch; PEL - Live Perch; PSL - Live Pumpkinseed; ROL - Live Roach; RSL - Live River Shad; S - Silver; SB - Silver Blue; SD - Shad; SFC - Silver Flo. Chartreuse

SHAD RAP® MAGNUM®



Super Tough African Abachi Wood



Metal Swimming Lip



Heavy-Duty Construction



VMC® Perma Steel Hooks



Hand-Tuned & Tank-Tested For Perfection



CG



CGFR



CH



FT



GFC



RH



SB



SM

Combining the classic Shad Rap® body shape with durable abachi wood and heavy-duty Magnum® construction, the Shad Rap® Magnum® is built to battle big predators. The metallic swimming lip creates less resistance on the retrieve and reflects sunlight, creating lots of additional flash to draw fishes' attention. Wobbling, tail-kicking action with a wide speed range for a variety of presentations.

- Classic Shad Rap® Body Shape
- Heavy-Duty Magnum® Construction
- Metallic Swimming Lip for Extreme Durability and Flash
- Rolling & Wobbling Action
- Wide Speed Range
- Heavy-Duty VMC® Perma Steel Hooks
- Slow Sinking

SHAD RAP® MAGNUM® SPECIFICATIONS

Model No.	Running Depth	Body Length	Weight	Hooks
SRMAG12	2.4 - 3.6 m	12 cm	40g	Two No. 1/0

CG - Pearl Orange; CGFR - Chrome Gold Fluorescent Red; CH - Chrome; FT - Fire Tiger; GFC - Green Fluorescent Chartreuse; RH - Red Head; SB - Silver Blue; SM - Silver Mackerel

SUPER SHAD RAP®



Premium Balsa Wood Construction



Over Built For Extra Toughness



Realistic Baitfish Patterns & Profile



3X VMC® Black Nickel Hooks



Hand-Tuned & Tank-Tested For Perfection



BG



CH



FP



GF



HTP



JP



P



PB



RFSH



RH

From the clear lakes of Scandinavia to the murky waters of the Amazon, the Super Shad Rap® patterns offer perfect imitations of the prey of predator fish and attractor colors. Natural swimming action at any speed.

- Balsa Wood Construction
- Natural Baitfish Profile
- Life-Like Patterns
- Floating
- VMC® Black Nickel Round Bend Hooks
- Stainless Through Wire Construction
- Hand-Tuned & Tank-Tested

SUPER SHAD RAP® SPECIFICATIONS

Model No.	Running Depth	Body Length	Weight	Hooks
SSR14	1.5 - 2.7 m	14 cm	45 g	Two No. 3/0
BG - Bluegill; CH - Chrome; FP - Fire Perch; GF - Goldfish; HTP - Hot Tiger Perch; JP - Jungle Perch; P - Perch; PB - Peacock Bass; RFSH - Redfin Shiner, RH - Redhead				

SHALLOW SHAD RAP®



Premium Balsa Wood Construction



VMC® Black Nickel Hooks

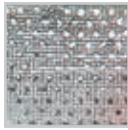

Classic Rapala Foil or Painted Finishes



Hand-Tuned & Tank-Tested For Perfection



ALB



CARP



DMN



FP



FT



GF



HT



JP



P



S



SB



SD



SFC

The Shallow Shad Rap® is ideal for fishing skinny water. Cast it out, let it sit until the ripples fade away, then begin a slow, enticing retrieve. It is equally effective when twitching, casting or slow trolling.

- Balsa Wood Construction
- Shallow Running Lip Design
- Classic Rapala Action
- Natural Baitfish Profile
- Floating
- VMC® Black Nickel Hooks
- Hand-Tuned & Tank-Tested

SHALLOW SHAD RAP® SPECIFICATIONS

Model No.	Running Depth	Body Length	Weight	Hooks
SSR05	0.9 - 1.8 m	5 cm	5 g	Two No. 6
SSR07	1.2 - 1.8 m	7 cm	7 g	Two No. 5
SSR09	1.8 - 2.4 m	9 cm	12 g	Two No. 3

ALB - Bleak; CRSD - Caribbean Shad; DMN - Demon; FP - Fire Perch; FT - Firetiger; GF - Goldfish; HT - Hot Tiger; JP - Jungle Perch; LBL - Live Largemouth Bass; P - Perch; PEL - Live Perch; PSL - Live Pumpkinseed; ROL - Live Roach; RSL - Live River Shad; S - Silver; SB - Silver Blue; SD - Shad; SFC - Silver Flo. Chartreuse

SKITTER POP®



Premium VMC®
Dressed Tail
Treble Hook



Cupped Lip
Creates Loud Pop
& Splash



Premium
Balsa Wood
Construction



Corrosion
Resistant
Hardware



UV BRIGHT FINISH
REFLECTS MORE
LIGHT ENERGY,
STRENGTHENING
THE LURE'S VISIBILITY.



FRESHWATER COLOR PATTERNS

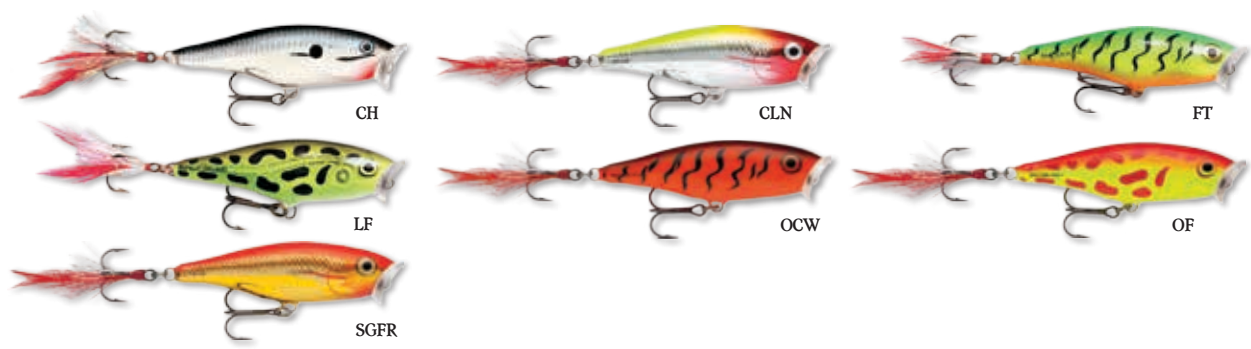

UV SERIES COLORS



SALTWATER COLOR PATTERNS



With its unique loud popping, cupped plastic lip and its balsa wood body, the Skitter Pop® can be fished in a variety of methods when fish are surface feeding. Saltwater model built heavy duty with saltwater rigging.

- Cupped Lip
- Painted, Chrome UV Finishes
- VMC® Black Nickel Hooks
- Feather/Tinsel Dressed Rear Treble Hook

SALTWATER MODEL

- Internal Rattle
- Premium VMC® Perma Steel® Hook
- VMC® Perma Steel® Mylar Tail Hook

SKITTER POP SPECIFICATIONS

Model No.	Running Depth	Body Length	Weight	Hooks
SP05	Topwater	5 cm	7 g	Two No. 6
SP07	Topwater	7 cm	7 g	Two No. 5
SP09	Topwater	9 cm	14 g	Two No. 3

CH - Chrome; CLN - Clown; FT - Firetiger; GHU - Ghost UV; LF - Lime Frog; OCF - Orange Tiger; OF - Orange Frog; OTU - Orange Tiger UV; SGFR - Steel Gold Fluorescent Red

SKITTER POP SALTWATER SPECIFICATIONS

Model No.	Running Depth	Body Length	Weight	Hooks
SSP12	Topwater	12 cm	40 g	Two No. 1/0

BC - Blue Chartreuse; BSRD - Blue Sardine; FC - Fire Chartreuse; GM - Green Mackerel; HP - Hot Pink; MU - Mullet; OBN - Orange Bone; RH - Redhead

TEAM ESKO®



Premium Balsa Wood Construction



Custom Lip Design for Unique Action



Premium VMC® Black Nickel Treble Hooks



Hand-Tuned & Tank-Tested For Perfection



CGFR



CH



CHF



DMN



FRHF



OPRT



PHF



CUSTOM HD LIVE SERIES COLOR PATTERNS



AYUL



SML



VAL

A floating lure with the body silhouette of the CountDown® for long-casting. Extreme swimming action, the Team Esko® maintains the classic Rapala® “wounded-minnow” action even in strong currents and rough water due to its additional bulk and lip design.

- Balsa Wood Construction
- Aerodynamic Shape
- Long-Casting
- Custom Lip Design
- Unique Wobble Action
- Premium VMC® Black Nickel Hooks
- Hand-Tuned & Tank-Tested

TEAM ESKO® SPECIFICATIONS

Model No.	Running Depth	Body Length	Weight	Hooks
TE07	1.2 - 1.8 m	7 cm	6 g	Two No. 6
AYUL - Live Ayu; CGFR - Chrome Gold Fluorescent Red; CH - Chrome; CHF - Chartreuse Hologram Flake; DMN - Demon; FRHF - Red Hologram Flake; OPRT - Orange Parrot; PHF - Pearl White Hologram Flash; SML - Live Smelt; VAL - Live Vairon				



PLASTIC LURES

Rapala® started life as a balsa bait company. Back in 1936 there was no way Lauri Rapala could have even conceived of modern materials used in present-day lure manufacturing. Today, the engineers at Rapala® also embrace the design opportunities plastic built lures afford them.

Unique and intricate shapes, durability, varied rattle sounds, translucency and sinking, rising and neutral buoyancy are all a part of features that must be considered when developing lures and creating never tried before fishing techniques.



RIPPIN' RAP®



Extra Large Deep Set 3D Holographic Eyes



Versatile Lipless Design



Textured Scale, Gill and Fin Detail



Premium VMC® Black Nickel Hooks



CH



CHB



CMBS



CSD



FT



GCH



PGS



RCW

The Ripplin' Rap® features a lipless, tall body profile designed to crank, swim and rip. Hard vibrating action accented with loud, distinctive BB rattle system. Long-casting with variable running depth.

- Tall, Skinny Body Shape
- Distinctive Loud BB Rattle System
- Lipless Design
- Hard Vibrating Action
- Sinking
- Long-Casting
- VMC® Black Nickel Round Bend Hooks
- Textured Scale Body

RIPPIN' RAP SPECIFICATIONS

Model No.	Running Depth	Body Length	Weight	Hooks
RPR05	Variable	5 cm	9 g	No. 8 & No. 10
RPR06	Variable	6 cm	14 g	No. 6 & No. 8

CH - Chrome; CHB - Chrome Blue; CMBS - Chrome Moss Back Shiner; CSD - Chartreuse Shad; FT - Firetiger; GCH - Gold Chrome; PGS - Pearl Grey Shiner; RCW - Red Crawdad



ULTRA LIGHT RIPPIN' RAP®



CH



CHB



FT



GCH



GTU



OTU

The Ultra Light Rippin' Rap® features a lipless, deep belly profile designed to dive and rip. With its flat, skinny sides this bait flutters on the drop with a hard-vibrating action accented with a loud, distinctive BB rattle system. Ideal for both casting and vertical jigging presentations. The body features textured scales and gills with deep set 3D holographic eyes.

- Ultra-Light Lipless Design
- Hard Vibrating Action
- Distinctive Loud BB Rattle
- Textured Scale Body
- Ideal Also For Vertical Jigging
- VMC® Black Nickel Round Bend Hooks

NEW ULTRA LIGHT RIPPIN' RAP SPECIFICATIONS

Model No.	Running Depth	Body Length	Weight	Hooks
ULRPR04	Variable	4 cm	5 g	No. 10 & No. 12

CH - Chrome; CHB - Chrome Blue; FT - Firetiger; GCH - Gold Chrome; GTU - Green Tiger UV; OTU - Orange Tiger UV

ULTRA LIGHT CRANK

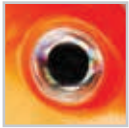

Large Deep Set 3D Holographic Eyes



Crank Bait Lip



Textured Scale, Gill and Fin Detail



Premium VMC® Black Nickel Hooks



Hand-Tuned & Tank-Tested For Perfection



AYU



CH



CLN



FT



GDAU



GFR



GPTU



ORS D



RSH



SHP



SP

Designed to offer big action in a small package, this ultra light finesse crank bait dives to over 2 meters and delivers a strong kicking action even on a slow retrieve. Floating, buoyant body easily backs out of cover when paused. Though small in size, the Ultra Light Crank is weighted and designed to cast like a lure twice its size. Eternal scale pattern and holographic 3D eye for a life-like appearance.

- Strong Kicking Action
- Rattling Sound
- External Scales
- 3D Holographic Eyes
- Diving Lip Design
- Long Casting
- Floating
- VMC® Black Nickel Round Bend Hooks
- Hand Tuned & Tank Tested

ULTRA LIGHT CRANK SPECIFICATIONS

Model No.	Running Depth	Body Length	Weight	Hooks
ULC03	1.2-2.4 meters	3 cm	4g	Two No. 10

AYU - Ayu; CH - Chrome; CLN - Clown; FT - Firetiger; GFR - Gold Fluorescent Red; ORSD - Orange Shad; RSH - Red Shiner; SHP - Silver Hot Pink; SP - Silver Purple

ULTRA LIGHT MINNOW



Weighted Body
Casts Farther &
Slow-Sinking



Premium VMC®
Black Nickel
Treble Hooks



Hand-Tuned
& Tank-Tested
For Perfection



AYU



CH



CLN



FT



GDAU



GFR



GPTU



ORSD



RSH



SHP



SP

Big action in a small bait, the Ultra Light Minnow has a weighted body that casts incredibly far for such a small bait. Slow-sinking, its unique lip design creates a hard kicking action.

- Weighted Body
- Unique Lip Design
- Hard Kicking Action
- Slow Sinking
- External Scales
- 3D Holographic Eyes
- VMC® Black Nickel Round Bend Hooks
- Hand-Tuned & Tank-Tested

ULTRA LIGHT MINNOW SPECIFICATIONS

Model No.	Running Depth	Body Length	Weight	Hooks
ULM04	0.6-0.9 m	4 cm	3 g	Two No. 10
ULM06	0.6-0.9 m	6 cm	4 g	Two No. 8

AYU - Ayu; CH - Chrome; CLN - Clown; FT - Firetiger; GDAU - Glass Dot Ayu UV; GFR - Gold Fluorescent Red; GPTU - Glass Pearl Tiger UV; ORSD - Orange Shad; RSH - Red Shiner; SHP - Silver Hot Pink; SP - Silver Purple

ULTRA LIGHT SHAD



Weighted Body
Casts Farther &
Slow-Sinking



Premium VMC®
Black Nickel
Treble Hooks



Hand-Tuned
& Tank-Tested
For Perfection



AYU



CH



CLN



FT



NEW

GDAU

UV
BRIGHT



GFR



NEW

GPTU

UV
BRIGHT



ORS D



RSH



SHP



SP

Small only in size, not fishability. Weighted for super casting distance the Ultra Light Shad runs true even at high retrieve speeds and fast water. Tight wobbling swimming action with slow-sinking on pause.

- Weighted Body
- Diving Lip Design
- Tight Wobbling Action
- Slow Sinking
- External Scales
- 3D Holographic Eyes
- VMC® Black Nickel Round Bend Hooks
- Hand-Tuned & Tank-Tested

ULTRA LIGHT SHAD SPECIFICATIONS

Model No.	Running Depth	Body Length	Weight	Hooks
ULS04	1.2 - 1.5 m	4 cm	3 g	Two No. 10

AYU - Ayu; CH - Chrome; CLN - Clown; FT - Firetiger; GDAU - Glass Dot Ayu UV; GFR - Gold Fluorescent Red; GPTU - Glass Pearl Tiger UV; ORSD - Orange Shad; RSH - Red Shiner; SHP - Silver Hot Pink; SP - Silver Purple

ULTRA LIGHT POP

NEW
for
2016

UV
BRIGHT

UV BRIGHT FINISH
REFLECTS MORE
LIGHT ENERGY,
STRENGTHENING
THE LURE'S VISIBILITY.



Loud Popping
Action



Internal
Rattle



External Scale
Pattern



Premium VMC®
Black Nickel
Treble Hooks



CH



FT



GCH



GDAU **UV**
BRIGHT



GPTU **UV**
BRIGHT



LF

A small topwater lure that packs a mean pop. Custom-designed cup face to move a lot of water and create a big bubble on each twitch. Featuring a loud internal rattle for added attraction, this little popper won't go unnoticed.

- Loud Topwater Popping Action
- Custom Design for Giant Bubbles and Big Commotion
- Loud Internal Rattle
- Perfectly Balanced Body Design
- 3D Holographic Eye
- External Scale Pattern
- VMC® Black Nickel Hooks

ULTRA LIGHT POP SPECIFICATIONS

Model No.	Running Depth	Body Length	Weight	Hooks
ULP04 NEW	Topwater	4cm	3g	Two No. 10

CH - Chrome; FT - Firetiger; GCH - Gold Chrome; GDAU - Glass Dot Ayu UV;
GPTU - Glass Pearl Tiger UV; LF - Lime Frog

RATTLIN' RAPALA®



Easy-To-Fish
Lipless Design



Premium VMC®
Black Nickel
Treble Hooks



Hand-Tuned
& Tank-Tested
For Perfection



Sound frequencies that are harmonic, uniform and “in tune” with nature combined with the legendary Rapala “wobble” is what make this lure so effective. Rip it fast or run it slow.

- Classic Lipless Design
- Unique Rattle Chamber
- Long-Casting
- Balanced Design
- Sinking
- VMC® Black Nickel Hooks
- Hand-Tuned & Tank-Tested

RATTLIN' RAPALA SPECIFICATIONS

Model No.	Running Depth	Body Length	Weight	Hooks
RNR05	Variable	5 cm	11 g	Two No. 6
RNR07	Variable	7 cm	16 g	Two No. 4

BB-Baby Bass; BG-Bluegill; BSD-Blue Shad; FT-Firetiger; GF-Gold Fish; JP-Jungle Perch; S-Silver; SG-Silver Gold



HUSKY JERK®



Classic Rapala
Swimming
Action



Glass, Metallic or
Natural Patterns



Premium VMC®
Black Nickel
Treble Hooks



Hand-Tuned
& Tank-Tested
For Perfection



BSRD



CLN



FT



GF



GMN



GP



HT



RH



SB



TSD

Perfectly balanced, the Husky Jerk® can be cast or trolled at any speed and still run true. The rattle chamber transmits sound waves that amplify through the water. Metallic, painted or glass patterns.

- Suspending/Neutral Buoyancy
- Long-Casting
- Loud Rattles
- Runs Straight and True
- Cast or Troll
- VMC® Black Nickel Round Bend Hooks
- Three Superior Finish Styles
- Hand-Tuned & Tank-Tested

HUSKY JERK® SPECIFICATIONS

Model No.	Running Depth	Body Length	Weight	Hooks
HJ08	1.2 - 1.8 m	8 cm	6 g	Two No. 6
HJ10	1.2 - 2.4 m	10 cm	10 g	Two No. 5
HJ12	1.2 - 2.4 m	12 cm	13 g	Three No. 5

BSRD - Black Sardine; CLN - Clown; FT - Firetiger; GF - Gold Fish;
GMN - Glass Minnow; GP - Glass Perch; HT - Hot Tiger; RH - Red Head;
SB - Silver Blue; TSD - Tennessee Shad.

GLASS SHAD RAP®



GBK



GBSD



GCS



GP



GPSF



GSD

Plastic version of the original Shad Rap® is a little heavier for easy casting and balanced to suspend on the stop like a natural baitfish. Slightly different “wobble” with a cadence type rattle. Transparent body with a holographic insert creates a chameleon like effect with the lure picking up the surrounding colors and bouncing them back – just like a real fish trying to hide from predators.

- Transparent Plastic Body with Holographic Insert
- Reflects Surrounding Colors
- Rattling
- Long-Casting
- VMC® Black Nickel Round Bend Hooks
- Suspending
- Hand Tuned & Tank Tested

GLASS SHAD RAP®

Model No.	Running Depth	Body Length	Weight	Hooks
GSR05	2.1 - 3.3 m	5 cm	9 g	Two No. 6
GSR07	2.1 - 4.5 m	7 cm	12 g	Two No. 4

GBK - Glass Black; GBSD - Glass Blue Shad; GCS - Glass; GB - Glass Perch; GPSF - Glass Purple Sunfire; GSD - Glass Shad

JOINTED SHAD RAP®

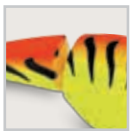

Jointed Body for Wide Swimming Action

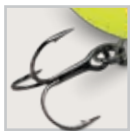

VMC® Black Nickel Hooks



Hand-Tuned & Tank-Tested For Perfection



CH



CLN



FT



HT



OSD



P



PRT



SD

A plastic, jointed version of the legendary Shad Rap® that sends out a “distressed-minnow” signal loud and clear. Slightly exaggerated action converts otherwise disinterested fish.

- Wide Strong Kickin’ Swimming Action
- Suspending
- Rhythmic Rattle
- VMC® Black Nickel Round Bend Hooks
- Hand-Tuned & Tank-Tested

JOINTED SHAD RAP® SPECIFICATIONS

Model No.	Running Depth	Body Length	Weight	Hooks
JSR05	1.8 - 3.9 m	5 cm	8 g	No. 6 & 7
JSR07	2.1 - 4.5 m	7 cm	13 g	Two No. 4

CH - Chrome; CLN - Clown; FT - Firetiger; HT - Hot Tiger; OSD - Orange Shad; P - Perch; PRT - Parrot; SD - Shad

JIGGING RAP®



UV BRIGHT FINISH
REFLECTS MORE
LIGHT ENERGY,
STRENGTHENING
THE LURE'S VISIBILITY.



UV, Standard and
Glow-in-the-Dark
Finishes



Center Treble &
Eyelet and Single
Reversed Hooks



Swimming
Action
Tail Fin



CLN



GFR



GT



HT



S



P



PRT



RFSH



OTU

A minnow profile bait, the Jigging Rap swims in tantalizing circles when raised and lowered. Quick snap rod tip darts in sporadic motion.

- Minnow Profile
- Balanced Design
- Environmental Zinc Weighted
- UV, Glow & Standard Colors
- Single Reversed Hooks
- Center Treble & Eyelet

JIGGING RAP® SPECIFICATIONS

Model No.	Running Depth	Body Length	Weight
W5	Variable	5 cm	9 g
W7	Variable	7 cm	18 g

CLN - Clown; GFR - Gold Fluorescent Red; GT - Glow Tiger; HT - Hot Tiger; S - Silver; P - Perch; PRT - Parrot; RFSH - Redfin Shiner; OTU - Orange Tiger UV





ASIA EDITION

All-time favourite Rapala® lures in special colours produced especially for South East Asia. Whether balsa or plastic, the superb craftsmanship and dedication to excellence make these lures look as good as their classic counterparts. Before leaving the factory, each lure is inspected, hand-tuned and tank-tested for the superior quality that Rapala® lures are known for.

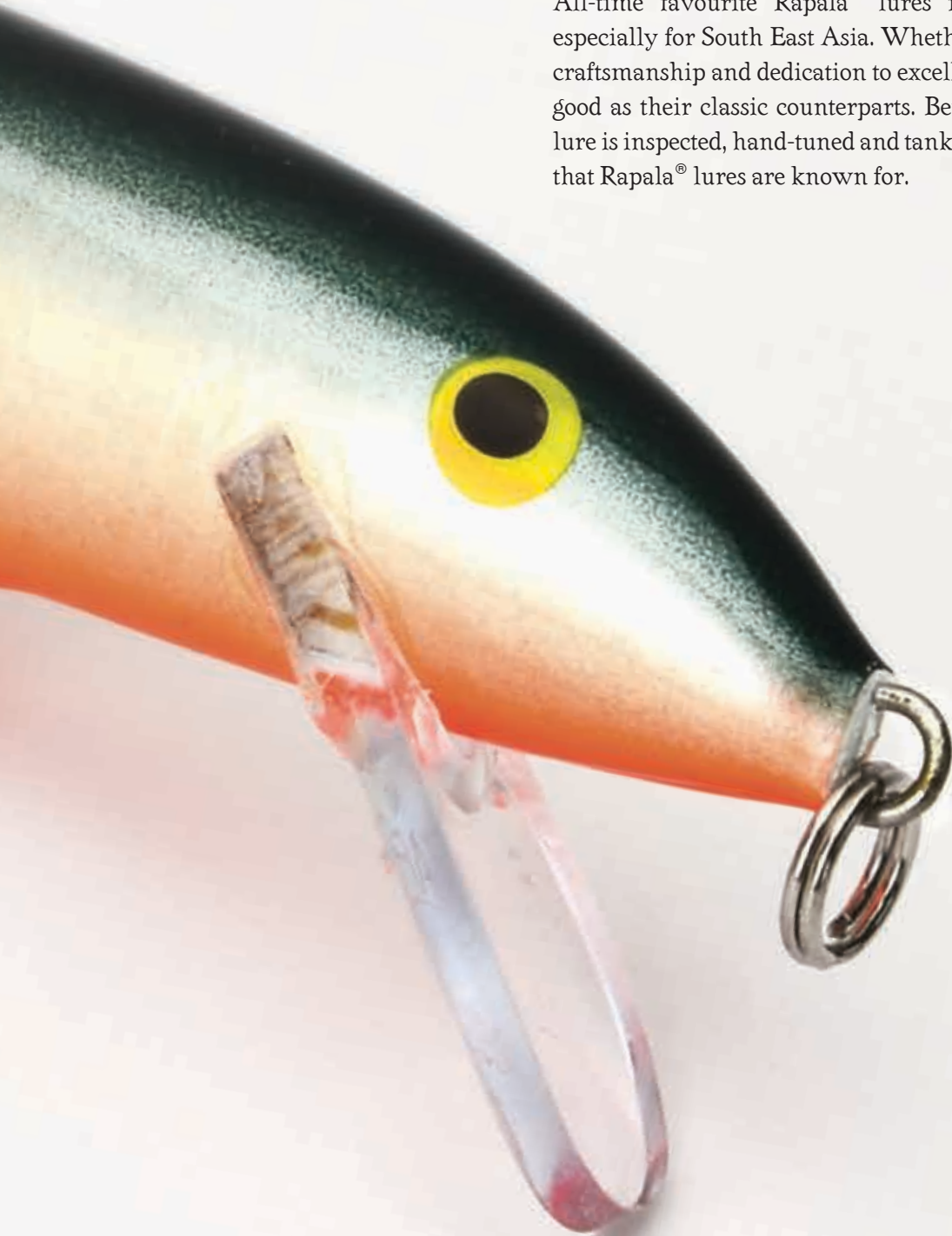

HUSKY

NEW
for
2016



ASIA
EDITION

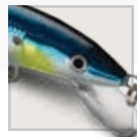

Classic Rapala
Swimming
Action



Premium
Balsa Wood
Construction

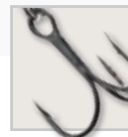

Premium VMC®
Black Nickel
Treble Hooks



Hand-Tuned
& Tank-Tested
For Perfection



BCF



BOF



BP



CW



FT



P



RH



SD

The classic Husky 13 features strong casting characteristics that do not impair the Rapala 'wounded-minnow' action on retrieve. Strong casting characteristics allow casting with heavier line and into the wind.

- Balsa Wood Construction
- Classic Rapala Swimming Action
- Excellent Casting Lure
- Limited Time Availability

HUSKY SPECIFICATIONS

Model No.	Running Depth	Body Length	Weight	Hooks
H13	1.2-2.4 m	13 cm	11 g	Three No. 3

BCF - Bleeding Copper Flash; BOF - Bleeding Olive Flash; BP - Bleeding Pearl; CW - Crawdad; FT - Firetiger; P - Perch; RH - Red Head; SD - Shad

NEW
for
2016

MINI FAT RAP®



**ASIA
EDITION**

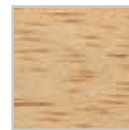

Premium
Balsa Wood
Construction



Shallow Diving
Lip Design

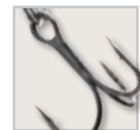

Premium VMC®
Black Nickel
Treble Hooks



Hand-Tuned
& Tank-Tested
For Perfection



CMBK



CMBL



CMBO



CMBY



CMCH



CMGY



CMOR



CMP

For convincing finicky fish to bite, the tight swimming action is just right. The sinking Mini Fat Rap® works with unmatched action for attracting trout and other smaller predators.

- Compact Body Design
- Balsa Wood Construction
- Tight Swimming Action
- Shallow Running
- Slow-Sinking
- Hand-Tuned & Tank-Tested

MINI FAT RAP SPECIFICATIONS

Model No.	Running Depth	Body Length	Weight	Hooks
MFR03	0.9 - 1.8 m	3 cm	4 g	Two No. 12

CMBK - Camo Black; CMBL - Camo Blue; CMBO - Camo Black Orange; CMBY - Camo Black Yellow; CMCH - Camo Chartreuse; CMGY - Camo Green Yellow; CMOR - Camo Orange; CMP - Camo Pink

RATTLIN' RAPALA®

NEW
for
2016



ASIA
EDITION



Easy-To-Fish
Lipless Design



Premium VMC®
Black Nickel
Treble Hooks



Hand-Tuned
& Tank-Tested
For Perfection



CLN

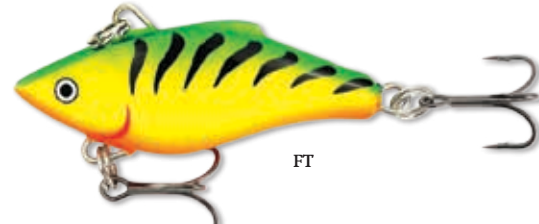

FT



GF



JP



OCW



PRT



SHP



TSD

Sound frequencies that are harmonic, uniform and “in tune” with nature combined with the legendary Rapala “wobble” is what make this lure so effective. Rip it fast or run it slow.

- Classic Lipless Design
- Unique Rattle Chamber
- Long-Casting
- Balanced Design
- Sinking
- VMC® Black Nickel Hooks
- Hand-Tuned & Tank-Tested

RATTLIN' RAPALA SPECIFICATIONS

Model No.	Running Depth	Body Length	Weight	Hooks
RNR04	Variable	4 cm	6 g	Two No. 7

CLN - Clown; FT - Firetiger; GF - Gold Fish; JP - Jungle Perch; OCW - Orange Crawdad; PRT - Parrot; SHP - Silver Hot Pink; TSD - Tennessee Shad

NEW
for
2016

RISTO RAP®



ASIA
EDITION

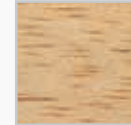

Premium
Balsa Wood
Construction

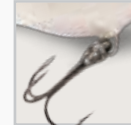

VMC®
Black Nickel
Hooks



Hand-Tuned
& Tank-Tested
For Perfection



ALB



CLF



FT



GALB



GF



PRT



RH

The Risto Rap is the ultimate balsa crankbait. Want a lure to make longer casts and crank deep? The Risto Rap checks both boxes. The best part? It's a proven fish catcher, from Giant Snakehead (Toman) to Jungle Perch (Sebarau) throughout South East Asia.

- Balsa Wood Construction
- Natural Baitfish Profile
- Classic Rapala Action
- Long-Casting
- Deep-Diving
- Floating
- VMC® Black Nickel Hooks
- Hand-Tuned & Tank-Tested

RISTO RAP SPECIFICATIONS

Model No.	Running Depth	Body Length	Weight	Hooks
RR04	1.5-2.4m	4 cm	5 g	Two No. 8
RR05	2.1-3.3 m	5 cm	10 g	Two No. 5
RR07	2.4-3.6 m	7 cm	15 g	Two No. 3

ALB - Bleak; CLF - Clown Flash; FT - Firetiger; GALB - Gold Alburnus; GF - Gold Fish; PRT - Parrot; RH - Red Head

SKITTER POP®

NEW
for
2016



ASIA
EDITION



Premium VMC®
Dressed Tail
Treble Hook



Cupped Lip
Creates Loud Pop
& Splash



Premium
Balsa Wood
Construction



With its unique loud popping, cupped plastic lip and its balsa wood body, the Skitter Pop® can be fished in a variety of methods when fish are surface feeding.

- Cupped Lip
- Painted, Chrome UV Finishes
- VMC® Black Nickel Hooks
- Feather/Tinsel Dressed Rear Treble Hook

SKITTER POP SPECIFICATIONS

Model No.	Running Depth	Body Length	Weight	Hooks
SP09	Topwater	9 cm	14 g	Two No. 3
BB - Baby Bass; BGS - Baby Giant Snakehead; CG - Pearl Orange; CM - Char. Mackerel; FP - Fire Perch; GALB - Golden Alburnus; JP - Jungle Perch; PB - Peacock Bass; PRT - Parrot; SH - Silver Shiner				

NEW
for
2016

DEEP TAIL DANCER®



ASIA
EDITION

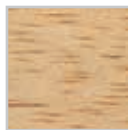

Premium
Balsa Wood
Construction



Large Lip
Enhances
Swimming Action



Tapered Tail for
Wide Swinging
Tail Action



Rapala®
Internal Rattle
Mechanism



Premium VMC®
Black Nickel
Treble Hooks



Hand-Tuned
& Tank-Tested
For Perfection



ALB



CMCH



CMOR



CMP



GALB

Banana-style body swims with wide tail action. The Deep Tail Dancer® features an enlarged, extreme diving lip that plummets the lures as deep as 9 meters unassisted.

- Deep Diving Lip
- Wide Tail Swimming Action
- Balsa Wood Construction
- Internal Rattle Mechanism
- Floating
- VMC® Black Nickel Hooks
- Hand-Tuned & Tank-Tested

DEEP TAIL DANCER SPECIFICATIONS

Model No.	Running Depth	Body Length	Weight	Hooks
TDD07	4.5 m	7 cm	9 g	Two No. 5
ALB - Bleak; CMCH - Camo Chart; CMOR - Camo Orange Red; CMP - Camo Pink; GALB - Camo Chart				

LIMITED EDITION SERIES





SLING BAG

Revolutionary bag for the mobile fisherman. The bag swings to the front and the main compartments open up as a work tray together with the 3600 tackle boxes that fit inside. 2 main compartments with double pullers. Includes two 3600 tackle boxes. On the padded shoulder strap: Spiral retractor, D-ring, a zippered pocket on the back and front side and a plier pocket.

Model No.	Dimensions (WxHxD)	Color
46006-1	31 cm/23 cm/11 cm	Green/Black



MAGNUM SLING BAG

Also available in King Size model. Same features as the original Sling Bag, with the larger 3700 sized tackle boxes for additional tackle.

ON THE PADDED SHOULDER STRAP

- Spiral Retractor
- D-ring
- Zippered pocket on the back and front side

MAIN BODY

- Two main compartments with double pullers
- Waterproof 600D fabric
- Two 3700 size tackle boxes included

Model No.	Dimensions (WxHxD)	Color
46006-LK	42 cm/28 cm/11 cm	Green/Black

NEW
for
2015

HYBRID HIP PACK



- Hip pack with an integrated, water repellent backpack
- Super comfortable and ergonomic hip belt doubles as back support
- Internal organizer slots
- Zippered side pockets
- One 3600 sized tackle box included

Model No.	Dimensions (WxHxD)	Color
NEW 46039-1	31 cm/22 cm/13 cm	Green/Black

FREESTYLE HIP PACK



Model No.	Color
HIP PACK-BLK	Black

- Light splash-resistant material
- Zippered side pockets
- Plier holster & bottle holder (bottle not included)
- Zippered side pockets
- **PLANO 3500** Stow Away box included (only for Malaysia & Singapore)

SPORTSMAN'S SERIES



SPORTSMAN'S 13 SACHEL

Roomy and practical fishing bag, the Sportsman's 13 features a removable PVC liner in the main compartment, two pockets in front for accessories. Two side release buckles act as a secure closure for main pocket. Waterproof fabric. Adjustable shoulder strap.

Model No.	Dimensions (WxHxD)	Color
46010-2	36 cm/30 cm/11 cm	Grey/Black



SPORTSMAN'S 31 TACKLE BAG

Big main compartment with roomy front pocket. Built for the water of tough waterproof fabric. Adjustable shoulder strap. Removable PVC liner in the main compartment.

Model No.	Dimensions (WxHxD)	Color
46012-2	40 cm/30 cm/21 cm	Grey/Black



SPORTSMAN'S 25 BACKPACK

Waterproof fabric construction protects your tackle and gear on any excursion. Adjustable D-Ringed shoulder straps. Cushioned support back adds comfort even on the longest hauls. Compression straps with side release buckles secure load.

Model No.	Dimensions (WxHxD)	Color
46014-2	35 cm/45 cm/19 cm	Grey/Black

SPORTSMAN'S 10 TACKLE BELT

This tackle belt is the epitome of portable. Small in size yet packed with features for a well outfitted tackle set. Zippered main compartment is complimented by two smaller pockets. Rod attachment straps for hands free travel. Waterproof fabric construction. Additional attachment points for tools and accessories.



Model No.	Dimensions (WxHxD)	Color
46007-2	74 cm/14 cm/11 cm	Grey/Black



All Sportsman's Series bags come PACKED IN AN UPGRADED BOX.

VISION GEAR®

With an unwavering commitment to functionality and a true sense of design, Rapala VisionGear's apparent value is seen clearly.

RXable lenses to the Shadow and ProGuide prove Rapala's commitment to better vision. The addition of Photochromatic lens to the line fulfills retailers needs for this growing market.

As always, function is first. With input from pro anglers and optical designers alike, Rapala VisionGear is designed to deliver true optical performance without distortion at the edges. Polarized lenses, 100% UV protection that provides up to 99% polarization, with the perfect amount of light transmittance to provide a view into the underwater world regular sunglasses can't provide. Bifocal magnification level of 2.50 adds just the right enlargement to meet a wide cross section of users. Non-slip nose pads add comfort and security.

Non-slip inserts on tail of bows keep Rapala VisionGear from slipping off, even during netting or release of fish.

The classic to modern designs reinforce our commitment to style and functional design. Whether the preference is plastic or metal frames, there is a model to fill that need.

The Rapala mission has always been to make fishing a little easier and a lot more fun. Rapala VisionGear is committed to making every trip an overwhelming success.

Rapala





bifocal



water repellent



scratch proof



DEcenter



UVB blocker



anti-reflective



coverage



internal coating



photochromatic

TR90
POLYCARBONATE

Rx
Lenses

TR 90
FRAME

MIRROR
GLASS LENS

VISIONGEAR® DOUBLES COLLECTION



Adjustable 2-in-1 lanyard and headband • Flexible sides in TR-90 material for comfort
 Polarized side window for panoramic vision • Ventilation Slot • Designed to be worn over prescription eyeglasses

SLIM FIT

Medium front size covers smaller or female optical frames



RVG-097A



RVG-097C



RVG-097P

SLIM FIT

Model No.	Frame Color	Lens Color
RVG-097A	Matte Black	G15 Grey
RVG-097C	Matte Metallic Grey	Grey

SPORT FIT

Medium front size covers most contemporary optical frames styles



RVG-098A



RVG-098B



RVG-098C

SPORT FIT

Model No.	Frame Color	Lens Color
RVG-098B	Shiny Tortoise	Brown
RVG-098C	Matte Metallic Grey	Grey

All include a safety strap and protective pouch to keep glasses in optimum condition.
 Passes European Standard EN1836

VISIONGEAR® SPORTSMAN'S COLLECTION



SPORTSMAN'S MAGNUM

Lightweight TAC polarized lenses · Oversize head width · Anti-slip rubber nose pads and co-molded rubber tips · Extended side coverage



RVG-006A



RVG-006B



RVG-006C



RVG-032A



RVG-032B



RVG-032C



RVG-236A



RVG-236B

MAGNUM

Model No.	Frame Color	Lens Color
RVG-006A	Matte Metallic Gun	G15 Grey
RVG-006B	Shiny Tortoise	Brown
RVG-006C	Shiny Metallic Black	Grey
RVG-032A	Matte Grey	G15 Grey
RVG-032B	Matte Black	Brown
RVG-032C	Matte Black	Grey
NEW RVG-236A	Translucent/Black	Blue Mirror
NEW RVG-236B	Translucent/Red	Mirror Brown

All include a safety strap and protective pouch to keep glasses in optimum condition.
Passes European Standard EN1836

VISIONGEAR® SPORTSMAN'S COLLECTION

Premium quality with classic to rugged modern styles.



SPORTSMAN'S

Lightweight and Impact Resistant · Custom Designed Bows · Internal Spring Hinge · Multiple Lens Colors · Rubber Nose Pads · Rubber End Tips



SPORTSMAN'S

Model No.	Frame Color	Lens Color
RVG-001AS	Black Matte	G15 Gray
RVG-001BS	Demi-Tortoise	Brown
RVG-001C	Black Matte	Yellow
RVG-002A	Gray Metallic Matte	G15 Gray
RVG-002B	Black Metallic Matte	Brown
RVG-002P	Black	Photo Yellow
RVG-004A	Pearl Gray Matte	G15 Gray
RVG-004B	Demi Amber Matte	Amber

Model No.	Frame Color	Lens Color
RVG-004C	Blue Matte Rubberized	Yellow
RVG-035A	Shiny Black	G15 Gray
RVG-037A	Matte Black	G15 Gray
RVG-037C	Matte Gun Metal	Gray
RVG-214A	Black	Grey Smoke
RVG-214M	Black	Mirror Blue
NEW RVG-234A	White	Grey
NEW RVG-234B	Red/Black	Grey

RAPALA SIGHT GEAR

Rapala Sight Gear lenses provide 99% polarization and protection against harmful glare and UV. Asian fit design.



RSG-SC01PG



RSG-SC01PY

PHOTOCHROMIC

Model No.	Frame Color	Lens Color
RSG-SC01PG	Black	Grey
RSG-SC01PY	Black	Yellow

All include safety strap and protective pouch to keep glasses in optimum condition.

Passes European Standard EN1836

VISIONGEAR® SPORTSMAN'S COLLECTION

Contemporary styling with sport detailing offer anglers leading edge optics with a true fashion sense.



SPORTSMAN'S MIRROR

- Revo-mirror coating on TAC lens for extra filtering of strong light
- Removable side-shields with ventilation to block side rays
- Removable center piece to block overhead light and outdoor elements
- Anti-slip nose pads and temple tips
- Adjustable temple tip for customized fit
- Snap-on lanyard compatible



RVG-022E



RVG-022F



RVG-203A



RVG-206A



RVG-026D



RVG-026F



RVG-232A



RVG-232C



RVG-031A



RVG-031C

SPORTSMAN'S MIRROR

Model No.	Frame Color	Lens Color
RVG-022E	Gun Metal	Blue Mirror Gray
RVG-022F	Tortoise	Green Mirror Amber
RVG-026D	Gun Metal	Blue Mirror Gray
RVG-026F	Tortoise	Green Mirror Amber
RVG-031A	Matte Black	Silver Mirror Gray
RVG-031C	Matte Blue	Blue Mirror Gray
RVG-203A	Matte Black	Blue Revo Gray
RVG-206A	Matte Black	Blue Revo Gray
RVG-232A	Graphite Matte	Silver Mirror
RVG-232C	Gray Matte	Silver Mirror Gray

Premium quality with classic to rugged modern styles.

SPORTSMAN'S FLOATER

Built-In Buoyancy • Featherlight Weight • TR90 Memory Plastic Frame • Two Polarized Lens Selections Rubber Nose Pads • Rubber End Tips



RVG-008A



RVG-008C



RVG-036A



RVG-036C

SPORTSMAN'S FLOATER

Model No.	Frame Color	Lens Color
RVG-008A	Shiny Metallic Grey	Gray
RVG-008C	Shiny Black	Gray

Model No.	Frame Color	Lens Color
RVG-036A	Shiny Black	Gray
RVG-036C	Shiny Metallic	Gray

All include safety strap and protective pouch to keep glasses in optimum condition.

Passes European Standard EN1836

SINGLE HAND NET

- Black anodized aluminum construction
- Rubberized mesh for durability
- Soft Grip handle
- Elastic lanyard



Model No.	Handle Length	Net Depth	Hoop Size
RNSHN-S	20 cm	50 cm	35 cm

RAPALA KNIVES

With a Finnish tradition that parallels the Rapala story, anglers the world over have grown to trust the Rapala knives. The Rapala Fish 'n Fillet is the knife that taught the world to fillet. It is found on more charter boats and in more fish camps than any other.

Today, the comprehensive collection of knives offers anglers and outdoorsmen just the right tool to match the job, big or small.

Rapala



BLACK MEDALLION™ FILLET KNIFE

Slim, flexible stainless steel blade for remarkable strength and long-lasting cutting edge. Seamless, hygienic bolster handle construction yields precision balance. Includes sheath.

Model No.	Handle Length	Blade Length
BMFK5	12 cm	13 cm
BMFK7	12 cm	18 cm

Handle: Die Cast Handle.
Sheath: Cordura.

Blade: Handground Stainless Steel. Actual blade length may vary slightly due to hand craftsmanship.



FISHING/CAMPING FOLDING KNIFE

Molded “Comfort Grip” handle, surgical stainless steel blade folds safely into handle for convenience and safety. Sturdy lock-back design.

Model No.	Handle Length	Blade Length
BP405F	15 cm	12.5 cm

Handle: Molded Soft-Grip.
Blade: Stainless Steel.



SALTWATER FILLET

White “Comfort Grip” handle resists heat and fatigue. Super sharp stainless steel blade for years of service. Flexible tip for delicate work. Easy-clean sheath.

Model No.	Handle Length	Blade Length
RSF7	12.5 cm	18 cm

Handle: White Comfort Grip.
Sheath: Easy Clean Open Sheath.
Blade: Stainless Steel.



4” BAIT KNIFE

4”/10 cm blade with serrated upper and razor sharp blade is the preferred size for preparing bait and other boatside tasks. Ventilated sheath.

Model No.	Handle Length	Blade Length
RSB4	10 cm	10 cm

Handle: White Comfort Grip.
Sheath: Easy Clean Open Sheath.
Blade: Stainless Steel.



CERAMIC SHARPENERS

Keep all your knives in “razor-sharp” condition with the handy Ceramic Sharpeners from Rapala. Single-Stage with fine honing sticks or Two-Stage sharpener also has coarse ceramic honing sticks.

Model No.	Item Description
SH2	Two-Stage Sharpener (coarse & fine)

RAPALA APPAREL



**RAPALA
CAMO DRI-FIT T-SHIRT**

Model No.	Size
CAMOR-T/BR	S, M, L, XL, XXL



**RAPALA
DRI-FIT SHORT SLEEVE JERSEY**

Model No.	Size
JRSY-T/RAP01#	S, M, L, XL, XXL

RAPALA APPAREL



NEW! RAPALA DRI-FIT LONG SLEEVE JERSEY

Model No.	Size
JRSYL-T/RAP01	L, XL, XXL, XXXL



NEW! RAPALA FREESTYLE DRY-FIT SHORT SLEEVE T-SHIRT

Model No.	Size
DRIFIT-SS/RED#L	S, M, L, XL, XXL
DRIFIT-SS/BLK#L	S, M, L, XL, XXL

NEW! RAPALA FREESTYLE DRY-FIT LONG SLEEVE T-SHIRT

Model No.	Size
DRIFIT-LS/RED#L	S, M, L, XL, XXL
DRIFIT-LS/BLK#L	S, M, L, XL, XXL

RAPALA APPAREL



**VINTAGE SERIES
GREEN**

Model No.	Size
RAP-T/VG	S, M, L, XL, XXL

**VINTAGE SERIES
RED**

Model No.	Size
RAP-T/VR	S, M, L, XL, XXL

**VINTAGE SERIES
BLUE**

Model No.	Size
RAP-T/VB	S, M, L, XL, XXL

RAPALA APPAREL



RAPALA BX JOINTED SHAD

Model No. Size
RAP-T/BX S, M, L, XL, XXL, XXXL

RAPALA X-RAP

Model No. Size
RAP-T/XR S, M, L, XL, XXL, XXXL

RAPALA SHADOW RAP

Model No. Size
RAP-T/SR S, M, L, XL, XXL, XXXL

STORM APPAREL



**STORM GOMOKU
SLOW PITCH (BLUE)**

Model No.	Size
GSP-T/B	S, M, L, XL, XXL, XXXL

**STORM GOMOKU
SLOW PITCH (GREEN)**

Model No.	Size
GSP-T/G	S, M, L, XL, XXL, XXXL

**STORM GOMOKU
SLOW PITCH (YELLOW)**

Model No.	Size
GSP-T/Y	S, M, L, XL, XXL, XXXL

STORM APPAREL



Blue



Green



Dark Brown



Ash Grey

STORM GOMOKU T-SHIRT

Model No.	Color	Size
GOJ-T/BB	Blue	S, M, L, XL, XXL, XXXL
GOJ-T/RG	Green	S, M, L, XL, XXL, XXXL
GOJ-T/DB	Dark Brown	S, M, L, XL, XXL, XXXL
GOJ-T/GR	Ash Grey	S, M, L, XL, XXL, XXXL



STORM DRI-FIT JERSEY

Model No.	Size
JRSY-T/STM01#	S, M, L, XL, XXL

APPAREL & GEAR



NEW! VMC HOODIE

Model No.	Size
VMC-T/HDR	S, M, L, XL, XXL



NORTH CRAFT T-SHIRT

Model No.	Size
NCT-T/BLK#	S, M, L, XL, XXL, XXXL

STORM ARMSOCK

Quick-drying material with UV protection.

Model No.	Size
ARMSOCK-STM01	M, L, XL, XXL



STORM TACTICAL CASTING GLOVES

Comfortable, lightweight and durable SPF20 Lycra material • Exposed fingertip design for easy knot-tying • Strategically-positioned synthetic leather for maximum dexterity and protection • Velcro strap

Model No.	Size
GLOVE-STMBL	S/M, M/L, L/XL



PRO HEADWEAR



CAP-CAMO01

RAPALA CAMO CAP



CAP-CAMO02

RAPALA & STORM DENIM CAP



CAP-DNM/RAP01



CAP-DNM/STM01

RAPALA & STORM DRI-FIT CAP



CAP-DRI/BLK01



CAP-DRI/R01



CAP-DRI/STMY01



CAP-DRI/STMBLK01

RAPALA & STORM MESH CAP



CAP-TRU/SAND



CAP-TRU/GOM01



CAP-TRU/GOM02

RAPALA ACCESSORIES



NEW! RAPALA 3 PANEL WALLET

Model No.

RWLLT



NEW! RAPALA FISH FLOP SANDALS

Model No.

Size

RRFF

M, L, XL

RAPALA ACCESSORIES



NEW! RAPALA ROD WRAP (LARGE)

Model No.	Size
RWL1-BK	380mm x 50mm



NEW! RAPALA ROD WRAP (SMALL)

Model No.	Size
RWS1-BK	260mm x 30mm



NEW! RAPALA AUTO/BOAT EMBLEM

- Featuring 3M Adhesive
- 3M Adhesive is waterproof and resistant to high and low temperatures
- Fast and easy application, no tools needed

Model No.	RBE1
-----------	------

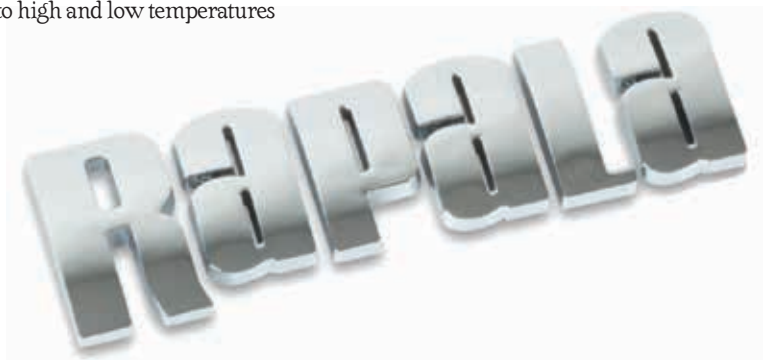

STORM ARASHI

The new era of crankbaits. Created with one thing in mind: everything anyone could ever want from a crank bait in one package. The result: ultra-modern crankbaits for hardcore fishermen. Built with Storm's proprietary, patent pending Self-Tuning Line Tie and a circuit board lip for ultimate out-of-the-box action that never goes out of tune. Custom finishes that are straight from fishermen's wet day dreams. The concept now boasts lures from top to bottom with the addition of the NEW Rattling Top Walker down to the Rattling Deep 25 depth extension.

STORM SO-RUN

Lures so effective that our Japanese lure designers decided to name them after a traditional Japanese commercial fishermen's song "So-Run". These lures are setting a new standard on how hard baits are made. As a true testament to our designer's heritage and knowledge of the most advanced lure technology, these lures are perfectly balanced for ultimate casting performance and action. All models feature a combination of most advanced finishing techniques.

STORM GOMOKU

Gomoku Concept offers special lures to cover all ultra-light fishing techniques to catch all species. Modern, technique specific micro baits are ideal for catching pressured and wary fish. Though small in size, these baits are not only for finesse fishing; the Gomoku Popper spits like a hippo and the Gomoku Spin is flashier than Elton John's sunglasses.

NEW STORM SX-SOFT

Hard bodied actions in a soft plastic lure - that's what SX-Soft is all about. We challenge ourselves to test the limits of plastic engineering at Storm by designing products to work in ways that you would never expect them to. The SX-Soft Serpentino walks side-to-side effortlessly across the surface with a constant retrieve.

TACTICAL HARD BAITS

Tactical series covers the basic elements every fisherman should have in his tackle box to cover all fishing situations from top water popping to open water deep trolling. These are the baits and actions even tournament anglers fall back to when in doubt - and the trusted partners that less experienced fishermen can count on.

HYBRIDS & SOFT BAITS

Big predator soft baits with advanced designs incorporating Storm's famous internal buoyancy/rattle chamber.



AT STORM, WE'RE SERIOUS ABOUT FISHING

Non-fishermen might even see us as obsessive. We believe in getting into the head of a fish to really understand what's going on... like what makes a fish bite. We build our lures based on those findings because we know that you're serious about fishing too. So get out there and do what you need to do to find them & catch them.

THINK LIKE A FISH.™



GLOW GIVES YOUR LURE MORE VISIBILITY IN LOW LIGHT CONDITIONS.

Whether it's dawn, dusk, or throughout the night; glowing paints draw predators closer to your Storm lure. Fishing deep with a GLOW lure where there is little light will also give you a better chance of attracting a bite.



UV BRIGHT FINISH REFLECTS MORE LIGHT ENERGY, STRENGTHENING THE LURE'S VISIBILITY.

Our UV finishes are a unique combination of fluorescent paints, reflective surfaces and optical brighteners that make the lures more brilliant in any visible light. They have proven to be very effective for all species in situations where fish are feeding by sight.



NEW ARASHI[®] RATTLING TOP WALKER



679 - Pearl Ayu



680 - Bluegill



685 - Blue Back Herring



686 - Wakasagi



688 - Ghost Hitch



689 - Ghost Pearl Shad



874 - Black Silver Shad



875 - Green Gold Shad

NEW ARASHI[®] RATTLING TOP WALKER

- Internal long cast mechanism increases your casting distance
- Stable, walking action thanks to low-roll design
- Multi ball rattle for added attraction
- Rotated hook hangers improve hook presentation
- Oversized VMC treble hooks

Model No.	Running Depth	Body Length	Weight
ATW11	Topwater	11 cm	22 g

LOW ROLL ACTION

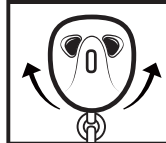

LOW ROLL ACTION
Keep the hooks below the bait at all times as it walks to increase positive hook-up percentage.

HAND TUNED TANK TESTED

ROTATED HOOK HANGERS
nests the hooks close to the body for improved action, preventing hang-ups, and allowing larger hooks.



ARASHI® SILENT SQUARE

ARASHI® RATTLING FLAT

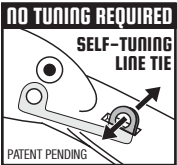

**HAND
TUNED
TANK
TESTED**



612 - Hot Blue Shad



680 - Bluegill



682 - Baby Bass



686 - Wakasagi



868 - Rusty Craw



871 - Hot Charteuse Shad



872 - Parrot



874 - Black Silver Shad



612 - Hot Blue Shad



680 - Bluegill



682 - Baby Bass



686 - Wakasagi



868 - Rusty Craw



871 - Hot Charteuse Shad



872 - Parrot



874 - Black Silver Shad

ARASHI® SILENT SQUARE

- Circuit board lip for responsive action and fast dive
- Self-tuning line tie keeps the lure tracking straight
- Lively rolling action
- Square lip deflects off objects upon impact
- High buoyancy floater to back out of trouble when stopped
- Ideal for fishing in contact with structure
- Premium VMC Black Nickel hooks
- Tank tested

Model No.	Running Depth	Body Length	Weight
ASQS03	1 m	5.5 cm	14 g
ASQR05	1.5 m	6 cm	18 g

ARASHI® RATTLING FLAT

- Circuit board lip for responsive action and fast dive
- Self-tuning line tie keeps the lure tracking straight
- Tight wiggling action for maximum flash and vibration
- Multi-ball rattle for loud, variable pitch
- Long cast design for increased distance and accuracy
- Premium VMC Black Nickel hooks
- Tank tested

Model No.	Running Depth	Body Length	Weight
AFT07	2.3 m	5.5 cm	12.5 g



ARASHI® RATTLING MINNOW

NEW ARASHI® RATTLING MINNOW DEEP



NEW 686 - Wakasagi



NEW 871 - Hot Chartreuse Shad



950 - Bloody Whitebait



951 - Ayu



952 - Ghost Shad



953 - Pearl Bone



954 - Magma Brown



955 - Metallic Holo Blue



956 - Pearl Red & Gold



957 - Lime Chart

NEW COLORS & SWIMMING DEPTH

ARASHI® RATTLING MINNOW & MINNOW DEEP

- Stable rolling & wobbling action
- Internal long cast mechanism increases casting distance
- Multi ball rattle for loud variable pitch
- Self-Tuning line tie keeps the lure tracking straight
- Circuit board lip for responsive action and fast dive
- Premium VMC Black Nickel hooks
- Tank tested

Model No.	Running Depth	Body Length	Weight
ARM11	0.6 m	11 cm	17 g
NEW ARMD11	3.0 m	11 cm	19.5 g

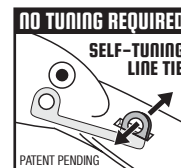



ARASHI® RATTLING DEEP



612 - Hot Blue Shad



680 - Bluegill



682 - Baby Bass



686 - Wakasagi



868 - Rusty Craw



871 - Hot Chartrouse Shad



872 - Parrot



874 - Black Silver Shad



NEW 875 - Green Gold Shad

ROTATED HOOK HANGERS

nest the hooks close to the body for improved action, preventing hang-ups, and allowing larger hooks.

NEW COLORS & SIZES

ARASHI® RATTLING DEEP

- Circuit board lip for responsive action and fast dive
- Self-tuning line tie keeps the lure tracking straight
- Moderate rolling action with loads of tail kick
- Perfect amount of search at higher speeds
- Multi-ball rattle for loud, variable pitch
- Long cast design for increased distance and accuracy
- Premium VMC Black Nickel hooks
- Tank tested

Model No.	Running Depth	Body Length	Weight
ADP10	3.3 m	6 cm	16 g
NEW ADP18	5.5 m	7 cm	22 g
NEW ADP25	7.6 m	9 cm	32 g



GOMOKU POPPER



NEW CLGLO - Clear GLOW Orange Belly



CLPHC2 - Clear Pink Head Chartreuse



HC - Hologram Chartreuse



HGG - Hologram Green Gold



HO - Hologram Orange



HP2 - Hologram Pink



HR - Hologram Red



OH - Orange Head



NEW P - Perch



SB2 - Silver Blue



TBP - Transparent Brown Prawn



WH - Wakasagi Head



NEW TR - Trout



NEW UVHG - UV Clear Holographic Glitter

NEW COLORS
GOMOKU POPPER



- Ultra light popper with lots of attitude
- Pops loud and spits a big bubble
- Strong flash off the sides
- Turns side to side when twitched
- Premium VMC nickel plated hooks

Model No.	Running Depth	Body Length	Weight
GPO40F	Topwater	4 cm	3 g



GOMOKU PENCIL



CLPHC2 - Clear Pink Head Chartreuse



NEW GLCD - GLOW Candy



HC - Hologram Chartreuse



HGG - Hologram Green Gold



HO - Hologram Orange



HP2 - Hologram Pink



HR - Hologram Red



OH - Orange Head



NEW P - Perch



SB2 - Silver Blue



TBP - Transparent Brown Prawn



WH - Wakasagi Head

**NEW COLORS
GOMOKU PENCIL**



• Walk-the-dog action in a tiny lure • One of few true walking lures of its size • Super long casting for its small size • Holographic & translucent patterns • Premium VMC nickel plated hooks

Model No.	Running Depth	Body Length	Weight
GP45F	Topwater	4.5 cm	2.7 g



GOMOKU MINNOW



BG - Blue Gill



BTP - Brown Tiger Prawn



NEW CLGLO - Clear GLOW Orange Belly



MBP - Metallic Blue Prawn



MC - Metallic Clown



MG - Metallic Green



MO - Metallic Orange



MP - Metallic Pink



MPR - Metallic Pearl



OG - Orange Geno



NEW P - Perch



NEW TR - Trout

NEW COLORS
GOMOKU MINNOW



- Strong, aggressive kicking action with moderate roll
- Light resistance on retrieve
- Suspending, rests head slightly up in the water
- Turns sideways when the retrieve is stopped, then rights itself back
- Premium VMC nickel plated hooks

Model No.	Running Depth	Body Length	Weight
GM35SP	0.35 m	3.5 cm	2 g



NEW UVHG - Clear Holographic Glitter UV



WH - Wakasagi Head



GOMOKU VIBE



BG - Blue Gill



BTP - Brown Tiger Prawn



MBP - Metallic Blue Prawn



MC - Metallic Clown



MG - Metallic Green



MO - Metallic Orange



MP - Metallic Pink



MPR - Metallic Pearl



NEW P - Perch



OG - Orange Geno



NEW TR - Trout



WH - Wakasagi Head

NEW COLORS
GOMOKU VIBE

- Medium to fast sinking gets you down fast
- Even the slightest movement gets the Vibe working
- Tight vibrating action on lift and/or retrieve
- Super long casting for its small size
- Silent, no rattle for stealthy approach
- VMC nickel plated hooks

Model No.	Running Depth	Body Length	Weight
GV40S	Variable	4 cm	3.5 g



NEW GOMOKU CRANK



CLP - Clear Pink



CLPHC - Clear Pink Head Chartreuse



FT - Fire Tiger



MBP - Metallic Blue Prawn



P - Perch



TR - Trout

NEW GOMOKU CRANK

- Fast diving to 5ft, allows you longer time in the zone
- Integrated aerodynamically molded bib helps the Crank bounce over structure
- High buoyancy & reverse floating on pause
- Super long casting for its small size
- High pitch tail kicking action
- Multi-ball rattle system for added attraction
- VMC nickel plated hooks

Model No.	Running Depth	Body Length	Weight
GC38F	1.5 m	3.8 cm	5 g



NEW GOMOKU SUTTE



GL - Glow



IKR - Coin



PHCH - Pink Chartreuse



PK - Pink



RH - Red Head

NEW GOMOKU SUTTE

New Japanese-style squid jig specially designed for boat squid jigging.

- Bottom-weighted to reach deeper waters
- Curved body for sliding fall action

Model No.	Running Depth	Body Length	Weight
GST08	Variable	6.5 cm	32 g



GOMOKU SPIN



BIW - Sardine



BLPK - Blue Back Pink



HCD - Hologram Candy



HGG - Hologram Green Gold



HGR - Hologram Red



HPHC - Hologram Pink Head Chartreuse



INC - Inakko



MLW - Live Sardine



NEW P - Perch

NEW COLORS
GOMOKU SPIN

- Tight body vibration on steady retrieve
- Custom tail blade for flash and vibration
- Tail blade flashes in the drop
- Can be fished up and down
- Great depth control
- Shallow running at high speeds, retrieve slow for deep presentation
- Premium VMC nickel plated hook

Model No.	Running Depth	Body Length	Weight
GSP06	0.5 m	4.5 cm	6 g
GSP10	1 m	5 cm	10 g



PW - Pink Sardine



SCG - Silver Constant Guigo



GOMOKU BOTTOM



CLP - Clear Pink



CLRF - Clear Red Flakes



GFR - Orekin



GLCD - **GLOW** Candy



GLD - **GLOW** Orange Belly



GRGB - Red and Gold Shrimp



NEW MBP - Metallic Blue Prawn



NEW MC - Metallic Clown



NEW P - Perch



NEW TR - Trout

NEW COLORS & SIZE
GOMOKU BOTTOM



- Designed to be bounced on the bottom or fished through the water column
- Perfect resting position with the tail up
- Tight vibrating swimming action
- Darting and flashing action when twitched
- Flutters on the drop
- Premium VMC nickel plated hook at the tail

Model No.	Running Depth	Body Length	Weight
GBT30S	Variable	3 cm	2.5 g
NEW GBT45S	Variable	4.5 cm	6.5 g





SX-SOFT VIB



BCG - Black Orange Lightning



BONE - Bone



GFR - Gold Fluorescent Red



HCD - Hologram Candy



HGG - Hologram Green



HP - Hologram Pink



INC - Inakko



PPHC - Pearl Pink Head Chartreuse



SGL - Solid **GLOW** in The Dark



UVGLO - **UV GLOW** Orange Belly

NEW SX-SOFT VIB

- Tight vibrating action draws fish in from a wide area
- Completely silent makes this lure extremely stealthy
- Up to 135 lb wire through construction
- Non-memory wire allows a bent lure to return to shape easily
- Hard PVC body is super resistant to big fish
- VMC nickel hooks

Model No.	Running Depth	Body Length	Weight
STV70S	Variable	7 cm	18 g

So-Run



SO-RUN HEAVY MINNOW



AJI - Aji



ANC - Anchovy



BIW - Sardine
(Available only in SRHM90S)



BLPK - Blue Back Pink
(Available only in SRHM90S)



BSRD - Blue Sardine



GSRD - Green Sardine



HCD - Hologram Candy
(Available only in SRHM90S)



KB - Kembung



NF - Naked Flash



PIW - Pink Sardine
(Available only in SRHM90S)



SPM - Spotted Mackerel

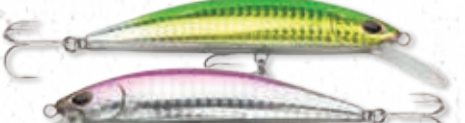

DGP - Double Face Green Pink

NEW COLORS

SO-RUN HEAVY MINNOW

- Heavily weighted for long casts and to sink to variable depths • Aggressive, stable action at medium to high speed
- Wire through construction for super strength • VMC nickel plated hooks

Model No.	Running Depth	Body Length	Weight
SRHM75SE	Variable	7.5 cm	15.5 g
SRHM90SE	Variable	9 cm	27 g
SRHM110SE	Variable	11 cm	42 g



So-Run



SO-RUN MINNOW



BIW - Sardine



CLCD - Clear Candy



CLPHC - Clear Pink Head Chartreuse



NEW HGR - Holo Gold Red



HRH - Holo Red Head



INC - Inakko



NEW PHCD - Pink Holo Candy



SFCD - Pearl Chartreuse



UVGLO - UV GLOW Orange Belly



NEW VICD - Violet Candy

NEW COLORS SO-RUN MINNOW



- Tight kicking action • Strong body roll • Very responsive to twitching • Floating, high rising
- Transparent, painted and glitter finishes • Premium VMC nickel plated hooks • Long casting

Model No.	Running Depth	Body Length	Weight
SRM95F	0.6 m	9.5 cm	11 g

So-Run



SO-RUN SINKING PENCIL



BIW - Sardine



CLCD - Clear Candy



CLPHC - Clear Pink Head Chartreuse



NEW HGR - Holo Gold Red



HRR - Holo Red Head



INC - Inakko



NEW PHCD - Pink Holo Candy



SFCD - Pearl Chartreuse



UVGLO - **UV GLOW** Orange Belly



NEW VICD - Violet Candy

NEW COLORS

SO-RUN SINKING PENCIL



- Dart & glide action
- Very responsive to twitching
- Long casting even in the harshest conditions
- Sinks fast, but can be fished shallow
- Lot of flashing off the sides
- Transparent, painted and glitter finishes
- Premium VMC nickel plated hooks

Model No.	Running Depth	Body Length	Weight
SRSP80S	Variable	8 cm	18 g

So-Run

**SCENT
INFUSED**



NEW SO-RUN HYPNO GRUB



GS - Golden Shiner



LC - Lime Char



LS - Lewd Shrimp



PSD - Pearl Shad



SO - Sunset Orange

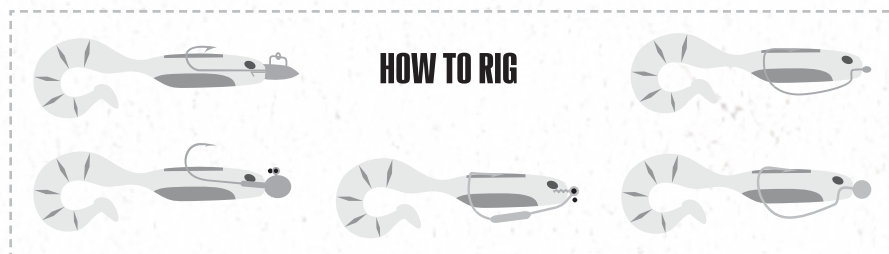

NEW SO-RUN HYPNO GRUB

• Improved Grub shape • Bulb tail enhances curl tail action at super slow speeds • Ribbed tail imparts additional vibration • Rolling action combines with curl tail action • Back & belly slit ensures body folds away when a fish strikes to maximise hook set • Ideal for slow to med speed retrieves

Model No.	Running Depth	Body Length	Weight	Pack
SSRHG03	Variable	3" / 7.5 cm	3.5 g	7
SSRHG04	Variable	4" / 10 cm	7.5 g	6

**SCENT
INFUSED**



NEW SO-RUN MAKAN MINNOW



GS - Golden Shiner



LC - Lime Char



LS - Lewd Shrimp



PSD - Pearl Shad



SO - Sunset Orange

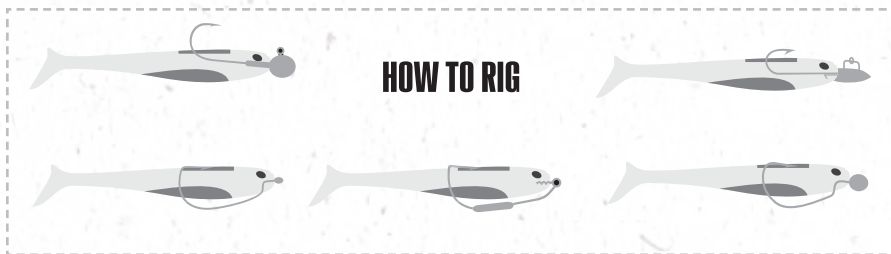

NEW SO-RUN MAKAN MINNOW

- Paddle tail minnow shape • Strong rolling action with wide tail kick • Action gets stronger and more pronounced at higher speeds • Ribbed, textured body for added vibration • Ideal for fast & slow speed retrieves

Model No.	Running Depth	Body Length	Weight	Pack
SSRMM03	variable	3" / 7.5 cm	3.5 g	7
SSRMM04	variable	4" / 10 cm	4.7 g	6



TACTICAL SERIES **STORM**





Z-STICK



375 - Red Head



599 - Chrome Clown



958 - Chart Bone



959 - Gold Chrome



960 - Chrome Blue Back



961 - Silver



962 - Chrome Black Back



963 - Beige

Z-STICK

- Quick-turning walk-the-dog surface lure
- Glides long off to the sides
- Internal rattle for added attraction
- Strong keel to keep hooks down and improve the hook-up rate
- Holographic, metallic and painted finishes
- Premium VMC Perma Steel hooks

Model No.	Running Depth	Body Length	Weight
ZS95	Topwater	9.5 cm	14 g
ZS115	Topwater	11.5 cm	24 g



TWITCH STICK



BCO - Black Chrome Orange



BSR - Blue Shrimp



599 - Chrome Clown



601 - Chrome Yellow Perch



60H - Gold Chartreuse



6FT - Green Fire Tiger **UV**



620 - Ghost Wakasagi



621 - Ghost Hot Blue



HCD - Holo Candy



PTP - Passion Tilapia



PRT - Parrot



SMT - Rainbow Smelt

TWITCH STICK

- Rattling easy-to-use twitch bait
- Super responsive for a variety of presentations
- Strong rolling & wobbling action
- Stop & go or twitch to create flickering, flashing and darting action
- Suspending

Model No.	Running Depth	Body Length	Weight
TWS08	0.6-1.2 m	8 cm	9 g
TWS10	0.9-1.5 m	10 cm	18 g



TACTICAL SERIES



SMASH SHAD



255 - Cheap Sunglasses



256 - Wonder Bread



281 - Hot Perch



592 - Black Chrome Orange



594 - Blue Chrome Orange



599 - Chrome Clown



613 - Rainbow Smelt



651 - Green Fire **UV**



PTP - Passion Tilapia



NEW 674 - Ghost Pink Lemonade **UV**

NEW COLORS SMASH SHAD



- Storm version for the ever popular multi purpose shad shape category
- High frequency multi-ball rattle
- Tight and controlled aggressive kickin' action at all speeds
- Slow retrieve with twitches to mimic baitfish feeding on the bottom
- Floating

Model No.	Running Depth	Body Length	Weight
SMS06	1.5-3.3 m	6 cm	8 g
SMS07	2.1-4.5 m	7 cm	11 g





TACTICAL SERIES



DEEPTHUNDER®



375 - Red Head



396 - Gold Fluorescent Red



429 - Red Tiger



454 - Red Gold Chartreuse



455 - Chartreuse Silver Chartreuse



456 - Blue Silver Chartreuse



457 - Black Silver



NEW 497 - Psycho



519 - Red Hot Perch



NEW 650 - Metallic Blue Tiger



660 - Hot Green Tiger



994 - Pink Sardine

NEW COLORS DEEPTHUNDER®

• Cast or troll in deep water • High impact plastic • Rattle in DTH11 • Premium VMC® Black Nickel hooks on DTH11 • Premium VMC® Perma Steel hooks on DTH15

Model No.	Running Depth	Body Length	Weight
DTH11	3.0-5.6 m	11 cm	28 g
DTH15	6.0-9.0 m	15 cm	60 g



RATTLIN' CHUG BUG®

RATTLIN' SALTWATER CHUG BUG®



009 - Bone

037 - Metallic Silver Chart. Back



009 - Bone

037 - Metallic Silver Chart. Back



140 - Metallic Silver Black Back

144 - Metallic Silver Blue Back



1264 - Metallic Blue Mullet

1265 - Green Mullet



204 - Bull Frog

205 - Hot Frog



1266 - Metallic Gold Mullet

1268 - Metallic Silver Mullet



1351 - Tennessee Shad

1360 - Naturistic Perch



1269 - Mullet

1375 - Red Head

RATTLIN' CHUG BUG®

- The do-everything topwater lure
- Spits, darts and chugs like fleeing baitfish
- Weighted tail for long casts
- Loud rattle
- Teaser tail hook

Model No.	Running Depth	Body Length	Weight
CB06	Topwater	6 cm	7 g
CB08	Topwater	8 cm	10 g

SALTWATER RATTLIN' CHUG BUG®

- The do-everything topwater lure
- Spits, darts and chugs like fleeing baitfish
- Weighted tail for long casts
- Loud rattle
- Teaser tail hook
- Perma Steel hooks

Model No.	Running Depth	Body Length	Weight
CBS08	Topwater	8 cm	10 g
CBS11	Topwater	11 cm	26 g

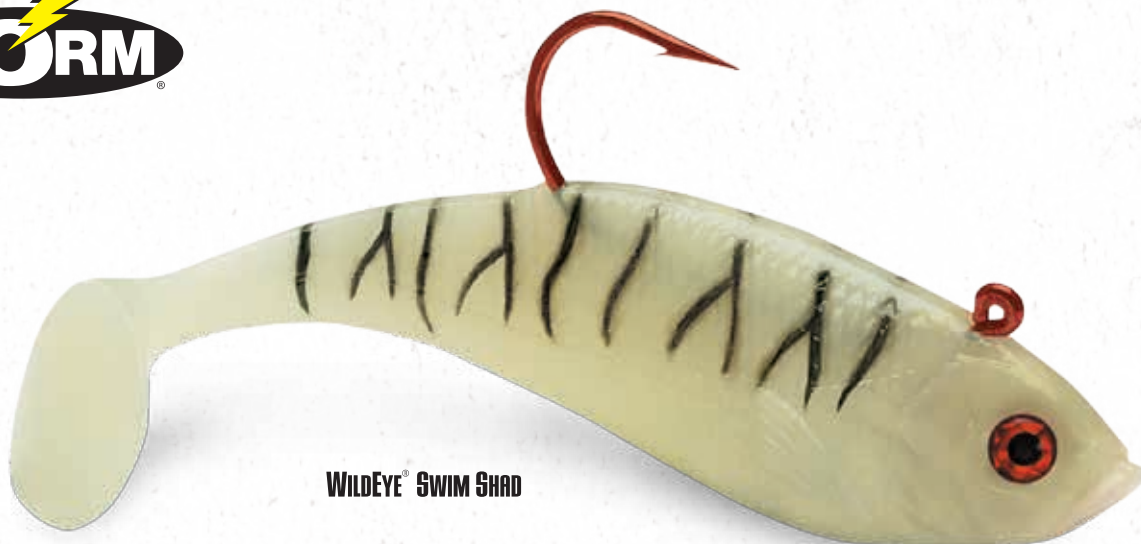

WILDEYE® SWIM SHAD



AY - Ayu



BSTD - Blue Steel Shad



FT - Fire Tiger



GT - GLOW Tiger



P - Perch



HP - Hologram Pink



PD - Pearl Demon



PRL - Pearl

WILDEYE® SWIM SHAD

- Premium VMC® needle point hook • Tough, yet soft body • Weighted internally for ideal swimming action • Life-like swimming action • Holographic swimmin' flash foil • Holographic WildEye®



Model No.	Body Length	Weight	Pkg
WSS03	8 cm	10 g	3
WSS04	11 cm	25 g	3



WILDEYE® RIPPIN' SWIM SHAD



WILDEYE® LIVE SHRIMP



AY - Ayu



FT - Fire Tiger



GHP - Ghost Perch



HP - Hologram Pink



P - Perch



PD - Pearl Demon



PPHT - Pearl Phantom



RO - Roach



NGWH - Nightwish



NTFO - Natural Fluorescent Orange



WTM - Water Melon

WILDEYE® RIPPIN' SWIM SHAD

- Rigged with VMC® needle point back hook and treble belly hook
- Tough, yet soft outer body
- Weighted internally for ideal swimming action
- Rattle chamber • Life-like swimming action
- Holographic swimmin' flash foil • Holographic WildEye®

Model No.	Body Length	Weight	Pak
WRSS03	8 cm	14 g	3
WRSS04	10 cm	20 g	3

WILDEYE® LIVE SHRIMP

- Natural color patterns & shapes
- Secure I-Bolt system holographic 3-D WildEye®
- Rigged with a superior VMC® needle point hooks
- Life-like swimming action • Holographic swimmin' flash foil
- Tough, yet soft outer body
- Weighted internally for ideal swimming action

Model No.	Body Length	Weight	Pak
WLSP03	8 cm	7 g	3



FLUTTERSTICK MADFLASH



465 - Holo. Chrome Blue Green



470 - Holo. Black Spotted Minnow



563 - Black Silver Flash



565 - Pearl Ghost Flash



581 - Olive Chartreuse **GLOW**



582 - Molten Steel **GLOW**



607 - Hot Perch



608 - Metallic Perch



651 - Green Fire **UV**



653 - Pink Fire **UV**

FLUTTERSTICK MADFLASH

- Darting sub-surface action
- Slow sinking on the pause with an enticing flutter
- High flash holographic body treatments
- UV Bright finish reflects more light energy, strengthening the lure's visibility

Model No.	Running Depth	Body Length	Weight
FSM04	Variable	4 cm	5 g
FSM07	Variable	7 cm	7 g
FSM10	Variable	10 cm	20 g



SERPENTINO



BJ - Brinjal



BOS - Banded Orange Snake



CG - Chartreuse Glow



GV - Green Viper



MS - Mangrove Snake



PB - Peacock Bass



TM - Toman

SERPENTINO

Model No.	Body Length	Weight
SPT09	9 cm	15 g

- Soft-body, hollow topwater bait rigged with premium, heavy-duty VMC double hooks
- Dog-walk action on heavy cover
- Long-casting • Weedless

SLOW STYLE JIGGING

KOIKA
コイカ

STORM®

超最強

GoMoKu
ゲーム



Introducing the newest member of the Storm Gomoku family - KOIKA. Koika (コイカ) is the Japanese word for cuttlefish, a common prey of many predatory fish. Specially designed for slow-pitch style jigging, Koika's centre-balanced, broad profile allows the jig to flutter enticingly on the fall. Additionally, Koika's dense and compact body enables it to easily travel through the depths, allowing you to quickly reach deeper water to where the fishes are holding. Give it some slack line on the drop and Koika will flutter, glide and dart as it falls.

SLOW STYLE JIGGING



STORM

GoMoKu
SUPER 五目ジグ CONCEPT

KOIKA
コイカ







KOIKA

GoMoKu
SUPER 五目ジグ CONCEPT



GS - GREEN SARDINE



NEW NF - NAKED FLASH



NEW UVG - UV GREEN
UV BRIGHT



UVSB - UV BRIGHT SILVER BLUE
UV BRIGHT



NEW UVSI - UV SILVER
UV BRIGHT

DOUBLE FACE DESIGNS



UVGGZ - UV CHARTREUSE ZEBRA



DF1 - DOUBLE FACE 1



DF3 - DOUBLE FACE 3



SPZ - SILVER PINK ZEBRA



BZ - BLACK ZEBRA/RED



OZ - ORANGE ZEBRA/PEARL

KOIKA

- Center-weighted body design, perfect for slow fall jiggling.
- Fluttering action on the drop triggers reaction bite.
- Highly-reflective body finish / double-faced design

Model No.	Jig Weight
KOIKA15	15g
KOIKA20	20g
KOIKA30	30g
KOIKA40	40g
KOIKA60	60g
KOIKA80	80g
KOIKA100	100g
KOIKA150	150g
KOIKA200	200g



GoMoKu
SUPER 五目ジグ CONCEPT



GOMAME

GOMAME

- Sleek, anchovy profile that's great for casting and speed jigging
- Highly-reflective body finish
- Futuristic 3D eyes

Model No.	Jig Weight
GOM15	15g
GOM28	28g
GOM40	40g
GOM60	60g
GOM80	80g
GOM100	100g



BSRD - BLUE SARDINE



GL - GLOW



GS - GREEN SARDINE

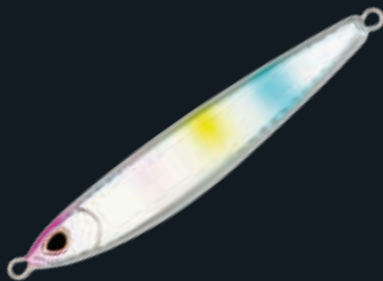

HGD - HOT CANDY



NF - NAKED FLASH



SPP - STRESSED PINK

DOUBLE FACE DESIGNS



**DF3 - DOUBLE FACE 3
(NAKED FLASH / ZEBRA)**



**DF4 - DOUBLE FACE 4
(GREEN SARDINE / SPOTTED MACKEREL)**



**DF5 - DOUBLE FACE 5
(GREEN BACK GOLD BELLY / STRESSED ANCHOVY)**

GoMoKu

SUPER 五目ジグ CONCEPT



MICRO JIG



GS - GREEN SARDINE

HCD - HOT CANDY

P - PINK

UVSB - UV BRIGHT SILVER BLUE

UVSP - UV BRIGHT SILVER PINK

UVSI - UV BRIGHT SILVER

DOUBLE FACE DESIGNS



**DF1 - DOUBLE FACE 1
(LIGHT BLUE SARDINE / UV GREEN)**

**DF2 - DOUBLE FACE 2
(GLOWN / PINK CANDY)**

**DF3 - DOUBLE FACE 3
(ZEBRA LUMO / SILVER)**

**BZ
(BLACK ZEBRA / RED)**

MICRO JIG

- Compact, micro-size
- Fluttering action on the drop
- Fast, darting action with speed jigging
- Realistic 3D eyes and highly-reflective body finish

Model No.	Jig Weight
MCJ08	8g
MCJ12	12g
MCJ20	20g
MCJ30	30g
MCJ40	40g



SUPER GOMOKU

GoMoKu
SUPER 五目ジグ CONCEPT



GSRD - GREEN SARDINE

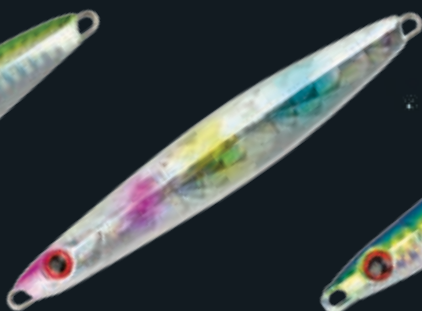

HCD - HOT CANDY

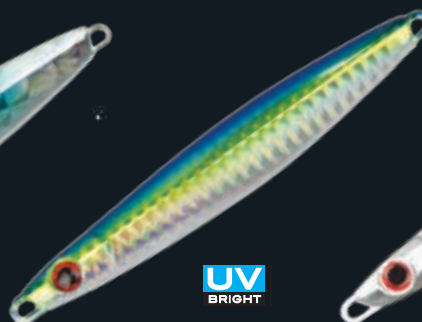

UVSB - UV BRIGHT SILVER BLUE

UV
BRIGHT

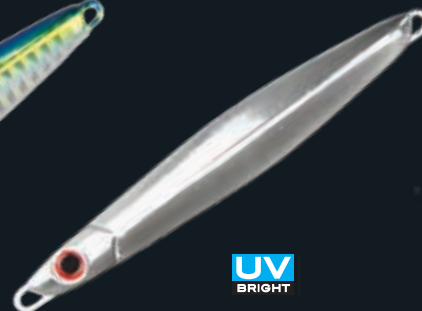

UVSI - UV BRIGHT SILVER

UV
BRIGHT

DOUBLE FACE DESIGNS



**DF2 - DOUBLE FACE 2
(CLOWN / PINK CANDY)**



**DF5 - DOUBLE FACE 5
(GREEN BACK GOLD BELLY / STRESSED ANCHOVY)**

SUPER GOMOKU

- Slim profile with tight, fluttering & rolling action
- Highly-reflective body finish

Model No.	Jig Weight
SGS15	15g
SGS20	20g
SGS30	30g
SGS40	40g
SGS50	50g
SGS60	60g
SGS80	80g
SGS100	100g





THUNDER JIG

GoMoKu
SUPER 五目ジグ CONCEPT



BSRD -
BLUE SARDINE



CBOB -
CHARTREUSE BACK
ORANGE BELLY



GBGB -
GREEN BACK
GOLD BELLY



GSRD -
GREEN SARDINE



P - PINK



W - WHITE



UV
BRIGHT

UVSB - UV BRIGHT SILVER BLUE

DOUBLE FACE DESIGNS



DF1 - DOUBLE FACE 1
(LIGHT BLUE SARDINE / UV GREEN)



DF2 - DOUBLE FACE 2
(CLOWN / PINK CANDY)

THUNDER JIG

- Attractive fluttering action
- Highly-reflective body finish
- Realistic 3D eyes

Model No.	Jig Weight
THJ15	15g
THJ28	28g
THJ40	40g
THJ60	60g
THJ80	80g
THJ100	100g

Only selected fish are allowed
to grow to maturity.

The severity of nature's ordeals ensures
only the survival of the fittest.
Since time immemorial mankind
has had the instinct of survival
and with it the instinct to hunt big game.
It is as if a mission since birth,
for humans to fight against adversity.

Those who experience the joy
of mastery are the chosen.



NORTH CRAFT

wakes you to the wild





AIROGRE



MODEL NO.	BODY LENGTH	WEIGHT	TYPE
AOG58S	58mm	9g	Sinking
AOG58SLM	58mm	14g	Slalom
AOG70F	70mm	12g	Floating
AOG70SLM	70mm	21g	Slalom
AOG85F	85mm	18g	Floating
AOG85SLM	85mm	28g	Slalom



BLV 25G



MODEL NO.	BODY LENGTH	WEIGHT	TYPE
BLV25G	78mm	25g	Sinking



ADRATION 90F/125F

MODEL NO.	BODY LENGTH	WEIGHT	TYPE
ART90F	90mm	12g	Floating
ART125F	125mm	20g	Floating



BIW



GCHO

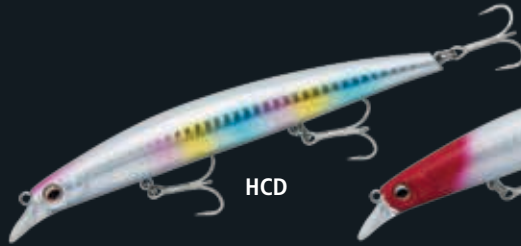

HCD



HRH



INC



PIW



SPCH





BMC 100F/120F



BIW



OAYU



PIW



SPCD



SPCH



SPM



SYRI

MODEL NO.	BODY LENGTH	WEIGHT	TYPE
BMC100F	100mm	15g	Floating
BMC120F	120mm	20g	Floating



BT-VIB 78S



BIW



GCHO



MCH



PIW



SPCH



SPM

MODEL NO.	BODY LENGTH	WEIGHT	TYPE
BTV78S	78mm	18g	Sinking

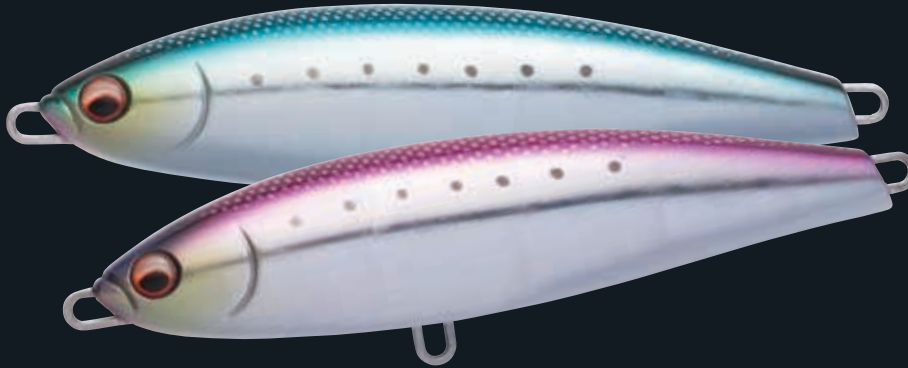

GUNDUCE Ultra



KNHRM



KNMGR

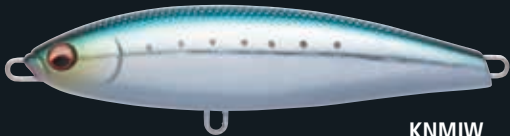

KNMIW



KNPIW



KNSNM



KNTBW

MODEL NO.	BODY LENGTH	WEIGHT	TYPE
GUN130F/K	130mm	40g	Floating



四海 SURF DMSF25/30

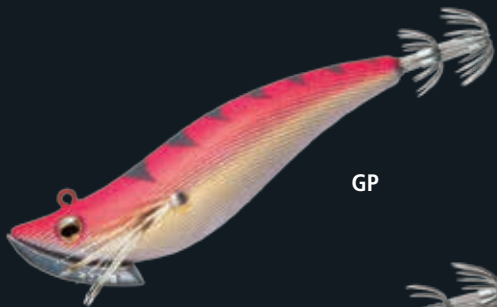

GP



KS



MOR



OLAJ



RP

MODEL NO.	SIZE	WEIGHT	TYPE
DMSF25	#2.5	17g	Sinking
DMSF30	#3.0	23g	Sinking



THE WORLD'S MOST HARDCORE FISHING LINE.

Sufix® invests strongly in research and development, which has made Sufix® one of the leading fishing line brands in the world with first class raw materials, modern production facilities, proprietary spooling and coating processes and non-compromising quality control. The Sufix® R&D team relies on scientific testing in addition to testing and feedback from pros in the field.



WITH SUFIX, THERE'S NOTHING YOU CAN'T CATCH.

832 ADVANCED SUPERLINE®



GORE Featuring
GORE® Performance Fibers



LO-VIS GREEN

NEON LIME

GHOST

THE STRONGEST, MOST DURABLE SMALL DIAMETER BRAID.

R8 Precision Braiding and fiber technology provide superior strength, roundness and line consistency. Constructed of 8 fibers (7 Dyneema® plus 1 GORE® Performance Fiber) and 32 weaves (pics) per inch. GORE® Performance Fibers improve abrasion resistance, increase casting length/accuracy & reduce line vibration. Dyneema® fibers provide high strength & sensitivity, hydrophobic water-repellent protection & small diameter.

SPECIFICATIONS		NEON LIME		LO VIS GREEN		GHOST	
Diam.	lb	150yds	300yds	150yds	300yds	150yds	300yds
0.14	6	•	•	•		•	
0.20	10	•	•	•	•	•	•
0.22	15	•	•	•	•	•	•
0.23	20	•	•	•	•	•	•
0.29	30	•	•	•	•	•	•
0.33	40	•	•	•	•	•	•
0.34	50	•	•	•	•	•	•
0.40	65	•	•	•	•	•	•
0.45	80		•	•	•		

THE WORLD'S MOST hardcore FISHING LINE.

832 METERED MULTI COLOUR



SUFIX 832 ADVANCED SUPERLINE®,
NOW AVAILABLE IN METERED MULTI COLOUR.

- Constructed of 8 fibers (7 Dyneema® plus 1 GORE® Performance Fiber) and 32 weaves (pics) per inch.
 - Five 10 meter color segments with 1 meter indicators and a 5 meter mark on each segment for precision depth management.

SPECIFICATIONS		MULTI-COLOR METERED
PE#	Rating	300 m
0.8	18lb	•
1.2	20lb	•
1.5	26lb	•
2.0	39lb	•
3.0	50lb	•

THE WORLD'S MOST HARDCORE FISHING LINE.

NANOBRAID®



AQUA CAMO



Can be snelled directly to a spade hook

STRONG AND THIN NANOFILAMENT BRAID.

Sufix® NanoBraid® is built with a Wide Angle Braiding Technology that creates higher tension on the braiding process, resulting in a tight weave and super strong, silky smooth line. • The densely braided Dyneema® fibers and a high pitch-count – up to twice as high as on most braided lines – gives consistent quality, uniform diameter and increased abrasion resistance, improving the line’s performance. • Sufix® NanoBraid® is up to three times stronger than other lines in the category and also features superior knot and shock strength unmatched by any other ultra thin line. The silky soft line is extremely sensitive and runs quietly through the guides.

SPECIFICATIONS			AQUA CAMO
Diam.	kg	lb	100 m
0.08	3.7	8.0	•
0.10	5.0	11.0	•
0.12	7.3	16.0	•

THE WORLD'S MOST hardcore FISHING LINE.

MATRIX PRO



HI VIS YELLOW

MIDNIGHT GREEN



A unique, high performance braid with all of the qualities that anglers search for: high strength, ease in handling, near zero stretch and easy casting. Our special matrix braiding process creates a rounder line which performs much better than traditional flat braids. A rounder braid makes your casts smoother, therefore enhancing your casting accuracy and distance. Made with 100% Dyneema® fibers to ensure that your line achieves the highest strength to diameter ratio while offering high sensitivity and quick hook-sets. Matrix Pro features a PE WaxShield that offers incredible toughness and abrasion resistance.

SPECIFICATIONS		HI VIS YELLOW		MIDNIGHT GREEN	
Diam.	lb	150 yds	300 yds	150 yds	300 yds
0.12	6	•	•	•	•
0.15	10	•	•	•	•
0.18	15	•	•	•	•
0.20	20	•	•	•	•
0.25	30	•	•	•	•
0.30	40		•		•
0.35	50		•		•
0.40	65		•		•

THE WORLD'S MOST hardcore FISHING LINE.

CASTABLE INVISILINE™ 100% FLUOROCARBON

Casts like mono & it's virtually invisible. 100% Fluorocarbon & virtually invisible. Resistant to ultra violet rays that can damage lines. Incredibly strong, abrasion resistance & sensitivity.

Low-stretch index for optimal hook setting power. Sinks 4 times faster than traditional nylon lines, getting your presentation to the strike zone faster. Exceptional handling for spinning & casting reels. Exclusive G2 Precision Winding™ virtually eliminates line memory.



SPECIFICATIONS		CLEAR
Diam.	lb	100yds
0.14	8	•
0.16	10	•
0.18	12	•
0.20	14	•
0.25	17	•
0.28	20	•

INVISILINE™



A premium quality and high integrity fluorocarbon leader line. Nearly invisible in water and sinks 4 times faster than nylon lines.

SPECIFICATIONS		CLEAR
Diam.	lb	20 m
0.27	8	•
0.30	10	•
0.37	15	•
0.44	20	•
0.47	25	•
0.52	30	•
0.62	40	•
0.71	50	•
0.79	60	•

SUPERIOR



A STATE OF THE ART COPOLYMER NYLON MONOFILAMENT LEADER LINE WITH EXCELLENT STRENGTH TO DIAMETER.

Premium nylon mono leader

SPECIFICATIONS			CLEAR
Diam.	lb		100 m
0.45	20		•
0.50	30		•
0.60	40		•
0.65	50		•
0.70	60		•
0.80	80		•
0.90	100		•

ZIPPY SHOCK LEADER



ZIPPY SHOCK LEADER

Made with a super copolymer, Zippy is a step above traditional nylon mono leaders. Offers superior strength to diameter ratio, yet easy handling.

SPECIFICATIONS			CLEAR
Diam.	kg	lb	100 m
0.40	7.0	15.0	•
0.45	10.0	20.0	•
0.50	15.0	30.0	•
0.55	20.0	40.0	•
0.60	24.0	50.0	•
0.70	27.0	60.0	•

VMC® TECHNOLOGY



VMC® POINTS



NEEDLE SHARP

Ground Needle Point Exceptional Sharpness

VMC® Needle Sharp™ is the very latest in premium point technology from VMC®, the result of a unique point-grinding process, chemically sharpened to perfection.



needle cone

The result of a sharpening technique that gathers the metal fibers and squeezes them toward the center of the point. By compressing rather than cutting, VMC® has created a point equal or superior in sharpness to the best available and incredibly stronger.

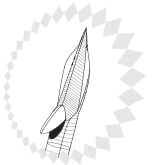

SPARK POINT

Developed exclusively by VMC® for ultimate performance hooks.

A premium point hardened by forming, followed by chemical sharpening ensures permanent hook sharpness. Front and back reinforcement ribs guarantee the point's rigidity. Energy channels increase the speed of penetration and optimise the point's driving force upon striking.



cone cut

The point that combines sharpness, structural stability and quality thanks to a conical tip, a triangular crest and a barb so fine that it assures, without force, a clean and perfect penetration beyond the barb.



fastgrip

The first point with 3 micro-barbs. The upper barb, placed close to the point, guarantees swift hook bite at the slightest solicitation. Two lower micro-barbs prevent the fish slipping off, even when the line is slack. As there is no tearing of the flesh, the removal of a Fastgrip® hook leaves no wound. Fastgrip®'s penetration power is 15% superior to that of an ordinary point.



cut point

The traditional hook point with excellent penetration capacity. This standard hook point is the most widely manufactured in the world. All VMC® hooks beginning with the number "9" have a standard Cut Point, unless otherwise indicated.

VMC® STEELS



VMC® Vanadium® hooks owe their success to their lightness allied with their incredible resistance : up to 25% increased strength. VMC® Vanadium® steel is perfect for any finesse-style hooks that require instant penetration.



Carbon stabilizes iron during temperature changes. The higher the level of carbon, the stronger the steel. VMC® uses premium-quality high carbon steel to allow for a thinner hook with the highest quality point and durability.



Reserved for special professional and premium sport hook series, stainless steel is perfect for deep sea fishing, salmon and big fish. Ultimate corrosion resistance requiring no further coating.

VMC® COATINGS



An optimum level of corrosion resistance exists for each individual fishing application. You can depend on VMC® coatings to preserve the unique sharpness, strength, shape and finish of our hooks for as long as you need them to last. The wide range of VMC® coatings offers an efficient solution adapted to every fishing condition.

Coating PTFE

New smooth PTFE coating increases penetration speed by 50%.

NT - PTFE

EXTREME CONDITIONS

PS - Permasteel®

1000+ hours!

The original anti-corrosion coating by excellence, exclusive to VMC®. The Permasteel® secret formula creates a 100% protective shield for even the most vulnerable areas of the hook, whilst maintaining ultimate point sharpness. VMC® Permasteel® prevents signs of corrosion in saltwater for over 1000 hours.

SALTWATER

- BN - Black Nickel
- OB - Onyx Black
- TI - Tin
- TR - Tin Red

The perfect balance between coating thickness and point sharpness, to ensure optimum hook performance and resistance against corrosion. Tin and Tin Red coatings are highly recommended for all saltwater fishing applications, particularly those involving intense friction such as trolling or when in direct contact with stainless steel.

FRESHWATER

- BK - Black
- BL - Blue
- RD - Red

- BZ - Bronze
- GO - Gold
- NI - Nickel

These coloured hooks receive a thin layer of unique varnish that covers the hook without affecting the sharpness of its point. The varnish creates a shield on Hi-Carbon and Vanadium® steel by covering the entire hook surface.

This corrosion scale is founded on tests carried out in the most aggressive saltwater environment possible. When fishing in freshwater, these VMC® coatings will preserve hook sharpness, strength and appearance to the highest possible level.

75' SERIES Hi-Performance Treble Hooks...

www.vmcpeche.com



1x

7545
1X STRONG
TREBLE

Page 12

2x

7554
2X INLINE
TREBLE

Page 12

3x

7556
3X STRONG
TREBLE

Page 13

STRENGTH



VMC



www.facebook.com/vmchooks



[instagram@vmchooks](https://www.instagram.com/vmchooks)

your expert in hooks

TREBLE HOOKS

7545 



1X Strong



Short Shank

SPARK POINT® X STRONG TREBLE

- Reinforced model, perfect for arming lures
- Modern shape designed to increase catch-rate
- Spark Point® for better penetration



COATING	PACKAGING	Blibox 8pcs
TI - Tin		



Cutting Edge Point Technology!

These « new generation » hooks benefit from an exceptional manufacturing procedure, developed exclusively by VMC® for ultimate performance hooks.

Point hardened by a VMC® exclusive die-forging process followed by chemical sharpening to **guarantee permanent hook sharpness**

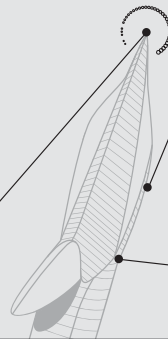

Front and back reinforcement ribs **ensure the point's rigidity**

Energy channels **increase the speed of penetration and the point's driving force upon striking**

www.vmcpeche.com

7554 



Inline Ring



Forged



2X Strong

2X INLINE TREBLE

- 2X Strong treble hook now available in four new sizes
- Built with VMC®'s latest extra-sharp ground Needle Point
- Inline Treble hook for perfect balance



COATING	PACKAGING	Size 12	Size 10	Size 8	Size 6	Size 4	Size 2
TI - Tin		8pcs	8pcs	8pcs	6pcs	6pcs	6pcs

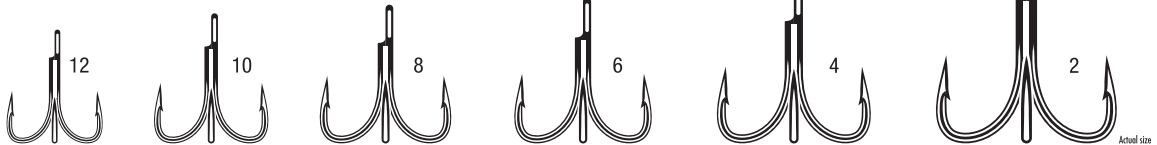

7556 



Inline Ring



Forged



3X Strong



Short Shank

SPARK POINT® 3X STRONG TREBLE

- Very resistant premium Spark Point® treble hook
- For large predator fishing
- Ideal for catfish and light tropical species

COATING	PACKAGING	Size 6	Size 4	Size 2	Size 1	Size 1/0
TI - Tin		8pcs	8pcs	6pcs	6pcs	6pcs

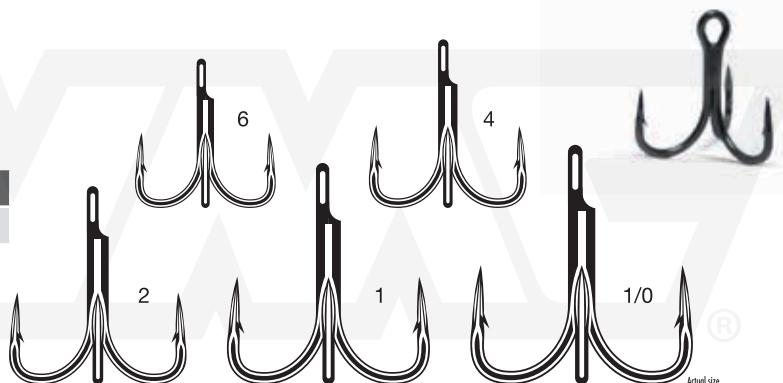

TREBLE HOOKS

your expert in hooks

9626



O'SHAUGNESSY TREBLE

- A classic hook for tough species
- The bigger sizes are popular for saltwater fishing
- Short shank to avoid hook tangling

▼ COATING	PACKAGING ▶	Blibox 100
PS - Permasteel®		•

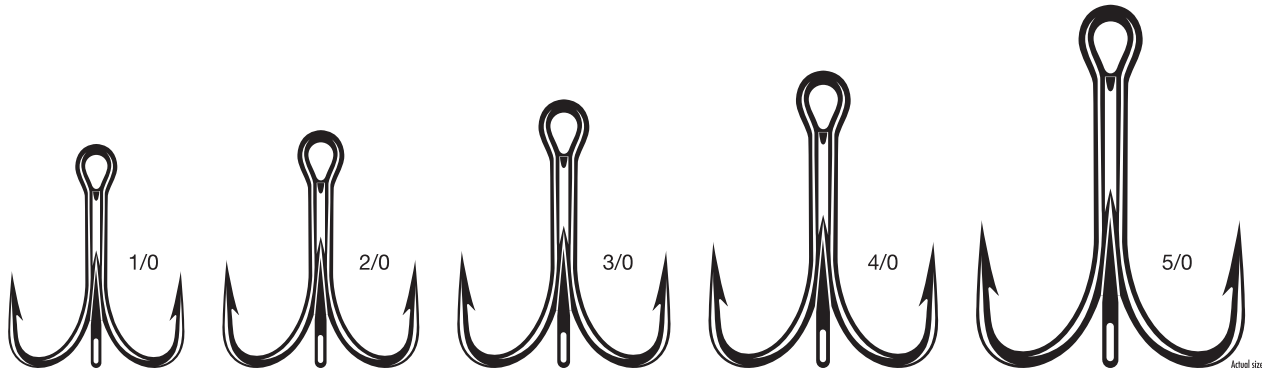
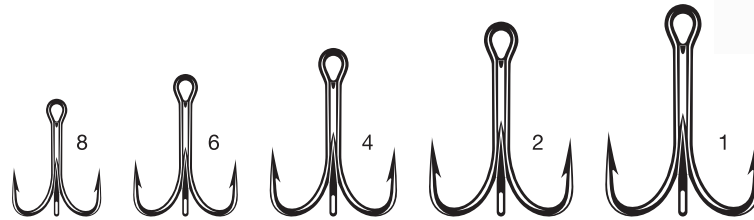

8527

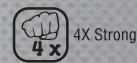

FISHFIGHTER® TREBLE

- Very high resistance to opening
- A complete range to arm all large-sized lures
- A popular choice for tropical fishing

▼ COATING	PACKAGING ▶	Blibox 100
PS - Permasteel®		•

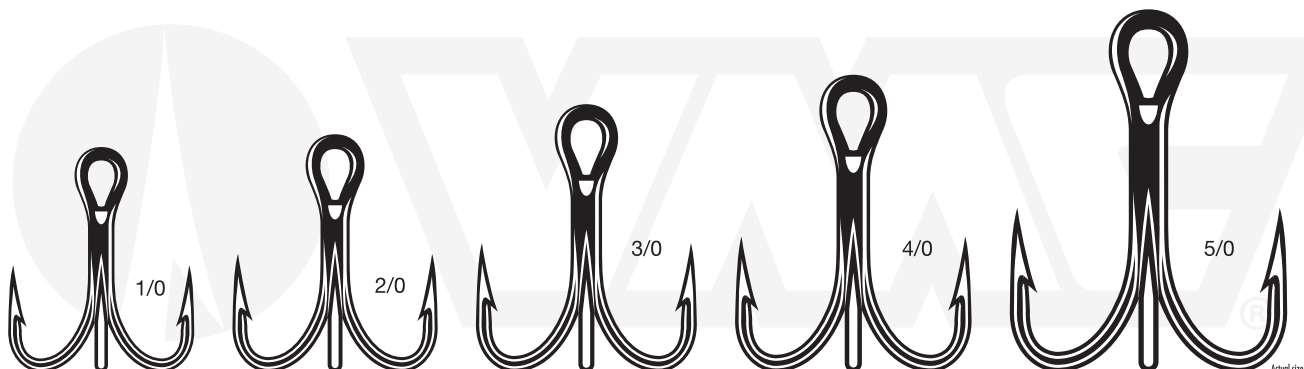
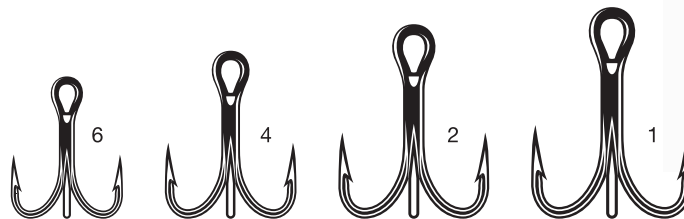

FRESHWATER SINGLE HOOKS

7310



SUPER LIGHT WORM HOOK

- One of the lightest worm hooks on the market
- Extra wide gap to make rigging soft plastic lures easier
- Premium Vanadium® steel and ultra-sharp Spark Point®

COATING	PACKAGING	Size	Propack (pcs)
BN - Black Nickel	[Icon]	1/0	5
		2/0	5
		3/0	5

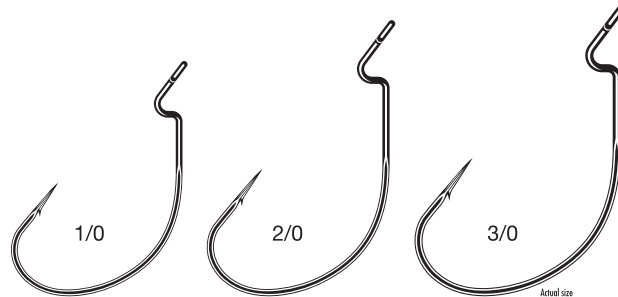

SUPER LIGHT WORM HOOK

Rigging suggestion:

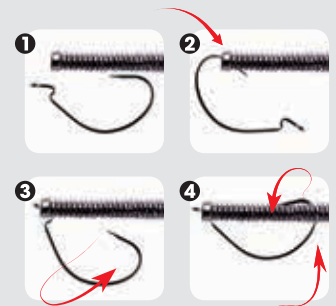
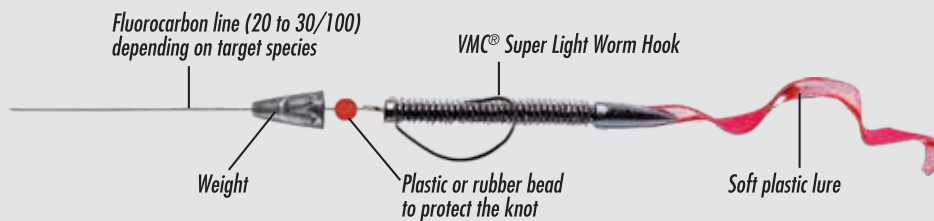

www.vmcpeche.com



FRESHWATER SINGLE HOOKS

your expert in hooks

7317

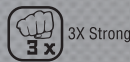

3X STRONG WIDE GAP WORM HOOK

- Worm hook with 3X reinforced wire
- To entice predators from heavily-covered areas
- Extremely sharp and resistant point



COATING	PACKAGING	Size	Propack (pcs)
BN - Black Nickel		3/0	5
		4/0	4
		5/0	4

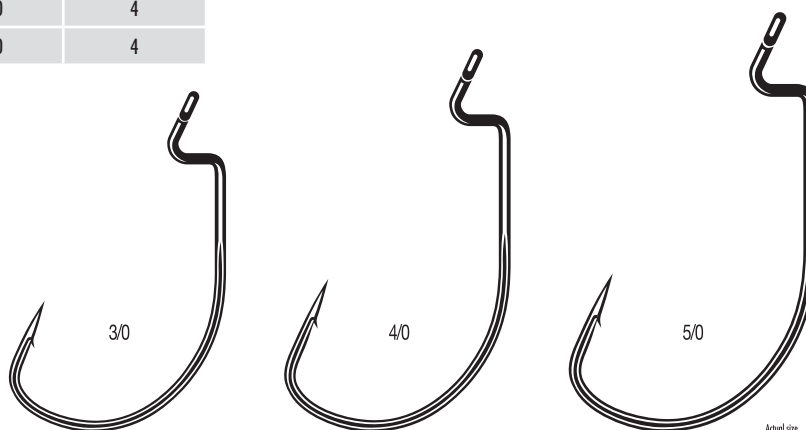

7317LD



LEADED TEXAN

- **7317** worm hook with leaded shank
- Extremely sharp Needle Cone point

COATING	PACKAGING	Size	Propack (pcs)
BN - Black Nickel		3/0	5
		4/0	4
		5/0	4

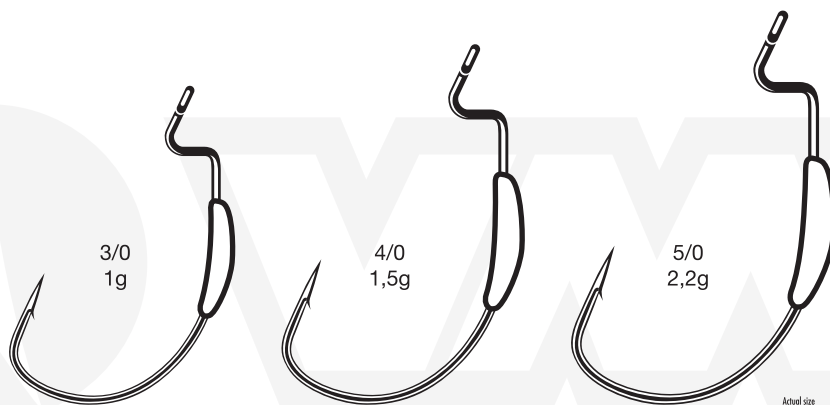

SALTWATER ALLROUND HOOKS

9255



O'SHAUGNESSY

- Designed for use on large spoons
- Highly popular on the US West Coast

▼ COATING	PACKAGING ▶	Blibox 100
PS - Permasteel®		•

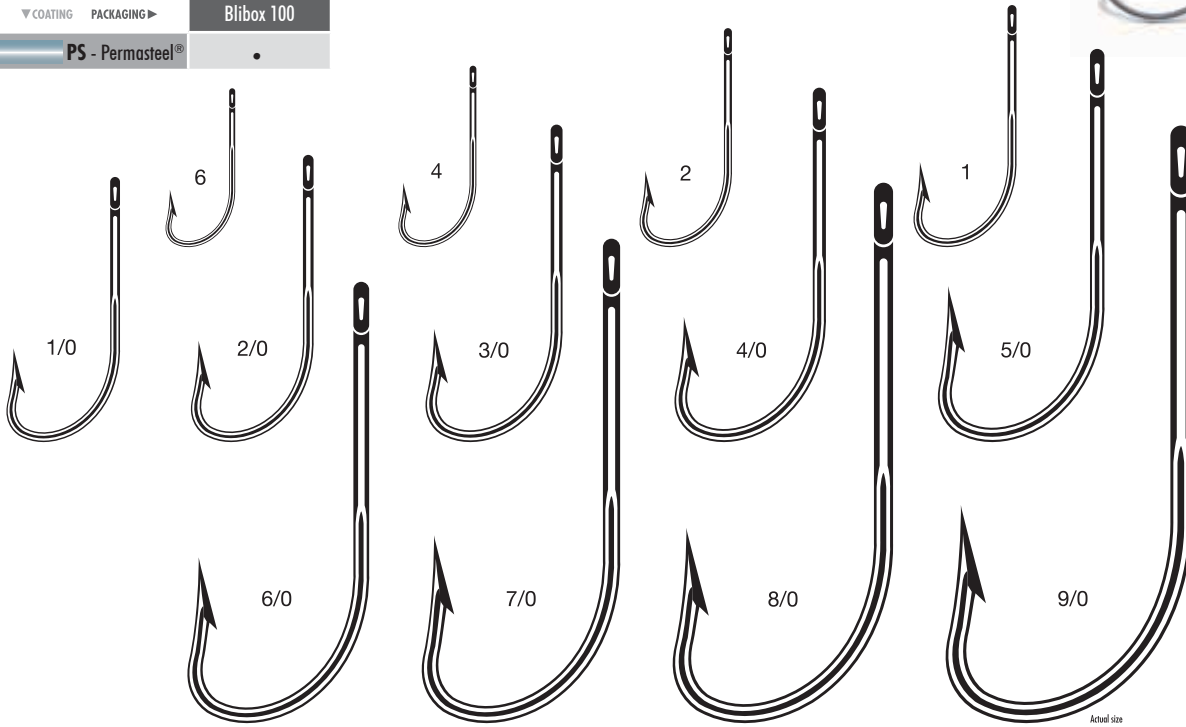

Actual size

9260

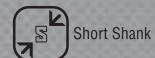

FAULTLESS O'SHAUGNESSY

- Very strong short shank hook
- A popular model for live bait fishing
- Ideal when wrecking for cod and pollack

▼ COATING	PACKAGING ▶	Blibox 100
PS - Permasteel®		•

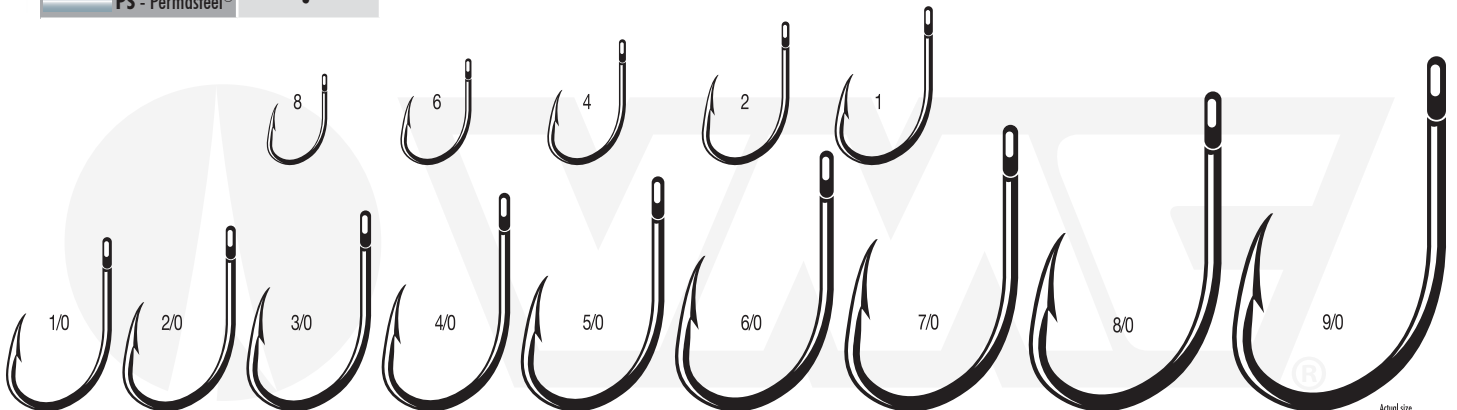

Actual size

SALTWATER JIGGING HOOKS

your expert in hooks

AH7264DA



JIGGING ASSIST HOOK

- Ready-to-use 2-hook assist rig to fit all vertical metal jigs
- Chemically sharpened extra-long and sharp ground needle point
- Micro-barb to allow better penetration and easy release

NEW



COATING	PACKAGING	Size	Propack (pcs)
TI - Tin		3/0	3
		5/0	2
		7/0	2

AH7110DA



LIGHT JIGGING ASSIST HOOK

- Ready-to-use 2-hook assist rig to fit all vertical metal jigs
- Chemically sharpened extra-long and sharp ground needle point
- Micro-barb to allow better penetration and easy release

NEW



COATING	PACKAGING	Size	Propack (pcs)
GO - Gold		4	3
		2	3
		1	3
		1/0	3
		2/0	3

AH7117DA



SLOW JIGGING ASSIST HOOK

- Ready to use 2-hook assist rig for modern light jigging / slow pitch
- Ideal when combined with metal/lead jigs
- Barbarian® shape & heavy forging for maximum strength

NEW



COATING	PACKAGING	Size	Propack (pcs)
NT - PTFE		2/0	3
		3/0	3
		4/0	2
		5/0	2

SALTWATER JIGGING HOOKS

7264



JIGGING ASSIST HOOK

- 8° offset ring for easier rigging and better presentation
- Extra wide gap to fit all vertical metal jigs
- Chemically sharpened extra long and sharp needle point
- Micro-barb to allow better penetration and easy release



COATING	PACKAGING	Size	Propack (pcs)
TI - Tin	▶	3/0	7
		5/0	5
		7/0	5
		9/0	3
		11/0	3

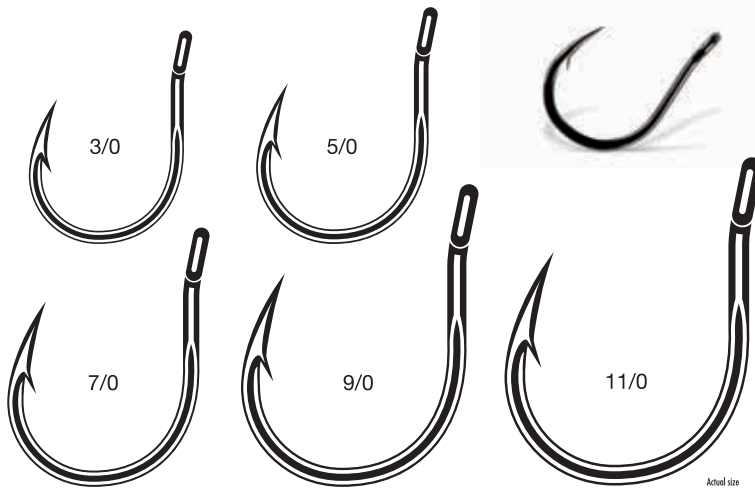

SALTWATER COMMERCIAL

9746



SEA ROUND

- A great all-purpose sea hook
- A classic for bait fishing
- Sharp, straight point

COATING	PACKAGING	Box 100
PS - Permasteel®	▶	•

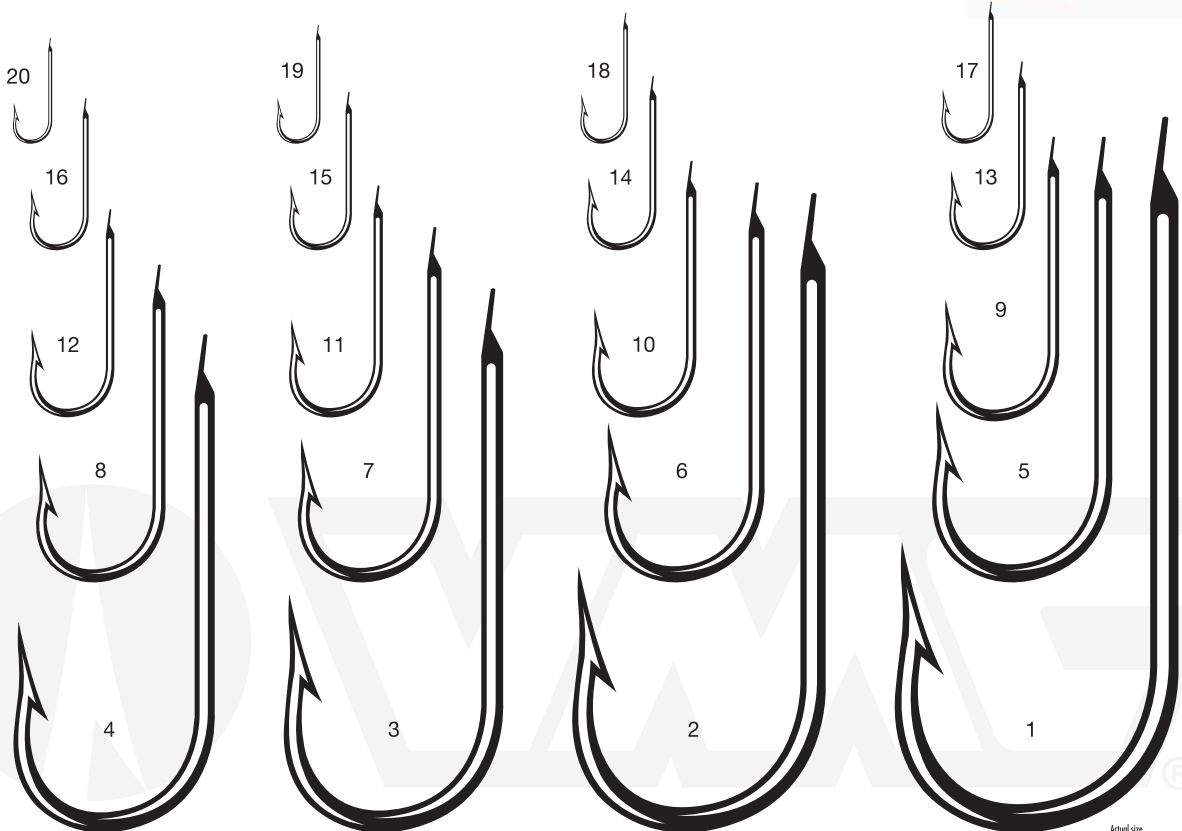

INLINE HOOKS

your expert in hooks

7237



LIGHT INLINE SINGLE

- Versatile inline single hook to use in place of a treble hook on lures
- Extra wide gap to improve catch rate
- Built with new VMC® Needle Sharp™ technology



▼ COATING PACKAGING ►

	Size	Propack (pcs)
 BN - Black Nickel	6	8
	4	8
	2	6
	1	6
	1/0	4

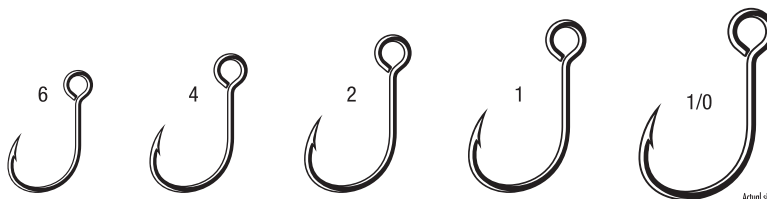

7266



INLINE SINGLE HOOK

- Single hook to use in place of a treble hook on lures
- Increasingly popular trend for saltwater specimen fishing
- Extra wide gap - improves catch rate



▼ COATING PACKAGING ►

	Size	Propack (pcs)
 TI - Tin	1/0	4
	2/0	4
	3/0	4
	5/0	3

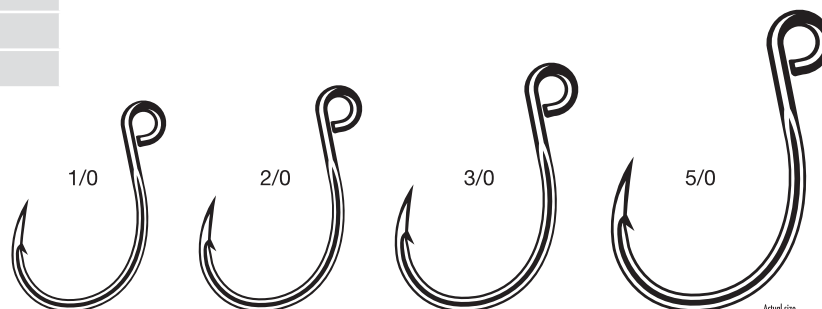

INTRODUCING VMC® INLINE SINGLE HOOKS

Two new inline single hooks designed to use in place of treble hooks on lures (hardbaits, spoons or casting jigs) when the use of trebles is restricted or forbidden. This practice is now widely used to reduce snagging on obstacles and for catch-and-release techniques because the hooks are easier to remove. With an extra-wide gap to improve catch rate and a large eye for easy assembly / freedom of movement using split rings.



SALTWATER STAINLESS STEEL HOOKS

8117S

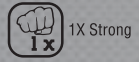

LIVE BAIT

- Strong ringed hook for live bait fishing
- Ideal crab bait hook
- Inward extra-sharp Cone Cut® point



▼ COATING PACKAGING ►

Box 100

SS - Stainless Steel®

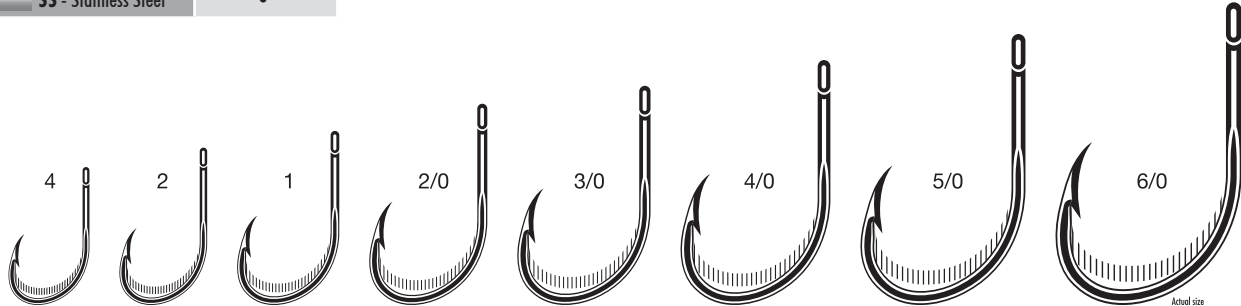

VMC® stainless steel hooks do not rust and eliminate the need to change hooks regularly.

Each batch of VMC® stainless steel hooks is rigorously lab-tested in a salt spray chamber, under strict conditions in accordance with international standards including NF ISO 9227 and ASTM B-117.

Hooks must pass VMC® extreme anti-corrosion tests before they are released for sale.

www.vmcpeche.com

7117



SLOW JIGGING ASSIST HOOK

- Used for slow-style jigging
- Ideal when combined with metal/lead jigs

NEW



▼ COATING PACKAGING ►

Size

Propack (pcs)

NT - PTFE

2/0

10

3/0

9

4/0

8

5/0

7

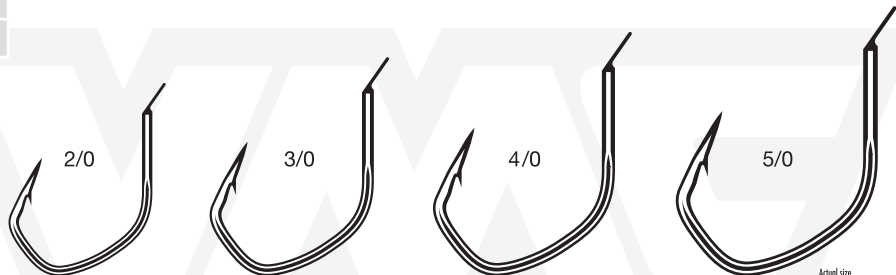

SALTWATER STAINLESS STEEL HOOKS

your expert in hooks

8299S

cone cut

Stainless INOX Steel STAINLESS STEEL

Turned-Up Eye

Reversed

Forged

Curved-in Point

FAULTLESS OCTOPUS

- A highly popular strong stainless steel hook
- Ideal for large fish baits such as squid or cuttlefish

COATING PACKAGING

Box 100

SS - Stainless Steel®

•

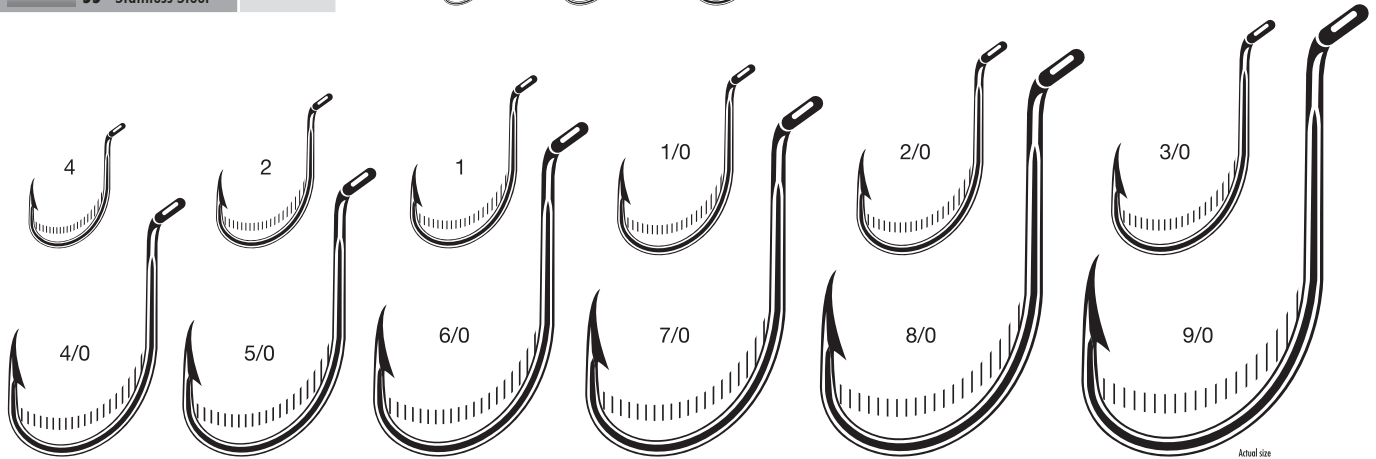
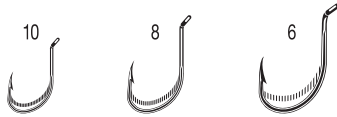

Actual size

9754

cut point

Hi carbon steel

Ringed

SEA ROUND

- Extremely versatile ringed hook
- One of the bestsellers in the range

COATING PACKAGING

Box 100

SS - Stainless Steel®

•

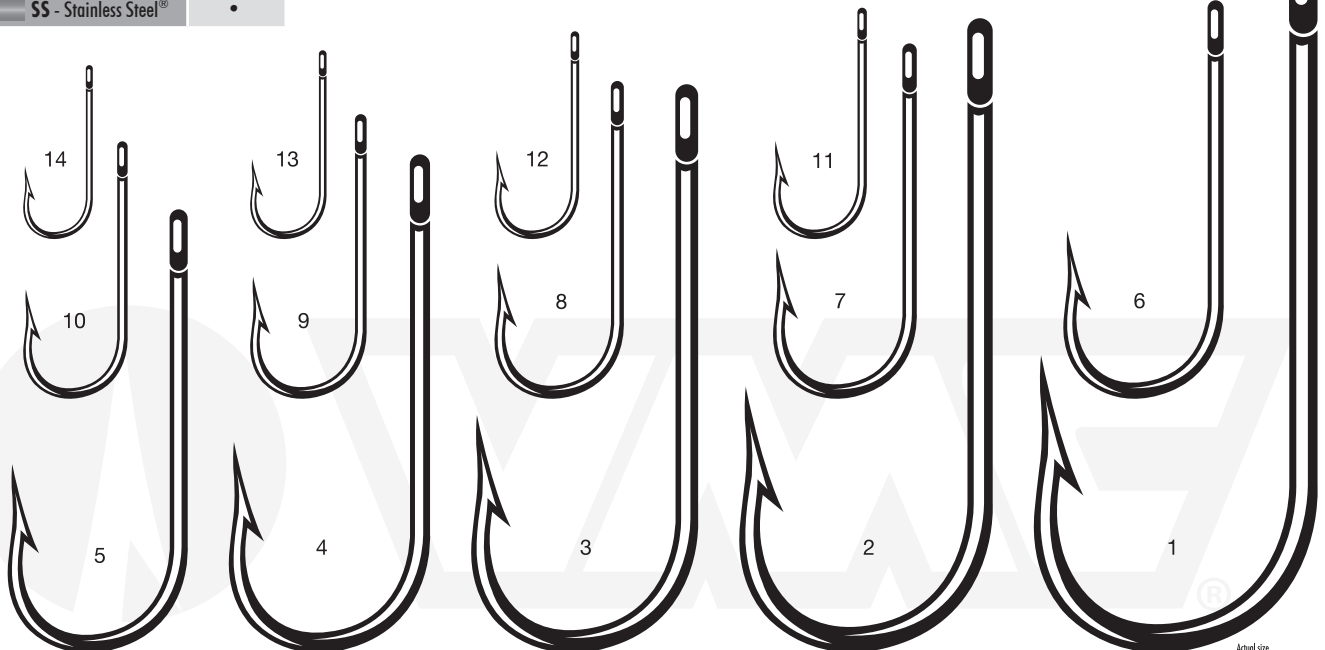

Actual size

ACCESSORIES

CHINU

CHINU WITH EYE

- Japanese Chinu hook with eye
- Extremely sharp
- Ideal for fish with small mouths



Size 1	Size 2	Size 3	Size 4	Size 5	Size 6	Size 7
13 pcs	13 pcs	10 pcs	10 pcs	10 pcs	10 pcs	10 pcs
Size 8	Size 9	Size 10	Size 11	Size 12	Size 13	Size 14
10 pcs	10 pcs	7 pcs	5 pcs	4 pcs	4 pcs	4 pcs



3537

DYNA SNAP

- A popular hook for general bait fishing
- Ideal for baits such as squid or cuttlefish

DYNA STRONG



Size 1	Size 2	Size 3	Size 4
10 pcs	10 pcs	10 pcs	10 pcs
11kg / 24lb	13kg / 28lb	19kg / 42lb	25kg / 55lb



ACCESSORIES

your expert in hooks

3541

DYNA SWIVEL

- Super Free Rolling Swivels

DYNA STRONG

Size 7	Size 4	Size 2	Size 1/0	Size 2/0
10 pcs	10 pcs	7 pcs	4 pcs	4 pcs
19kg / 42lb	34kg / 75lb	42kg / 92lb	76kg / 167lb	85kg / 187lb



3561

SPLIT RING

- Forged Stainless Steel

- High strength to diameter ratio

- Sizes 5-7 (Dyna Strong) feature forged high grade stainless steel with polished finish

X-STRONG DYNA STRONG

Size 1	Size 2	Size 3	Size 4	Size 5	Size 6	Size 7
20 pcs	20 pcs	20 pcs	20 pcs	12 pcs	10 pcs	10 pcs
11kg / 24lb	15kg / 33lb	25kg / 55lb	30kg / 66lb	35kg / 77lb	45kg / 99lb	78kg / 172lb



3562

SOLID RING

NEW

- Forged for extra strength

DYNA STRONG

Size 3	Size 4
20 pcs	20 pcs



RODS

We've incorporated the latest rod-building components into our premium range of technique-specific Rapala and Storm rods. By adopting the latest concept guides we are able to bring out the best performance from our blanks. The results? Greater casting distance, increased accuracy and sensitivity, optimized action and power, improved rod balance and reduced twisting torque, line twist and tangles. Whether its lure-casting or jigging, we've got the perfect rod for you.



Rapala

STORM

WILLIAMSON
LURES





FEATURING FUJI KR
CONCEPT GUIDES



Fuji SiC guides

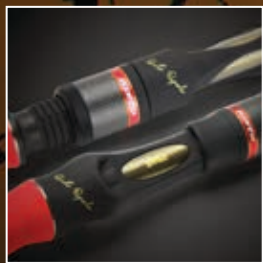

Rubberized
Fuji TVS (spinning) &
Fuji PTS (casting) reel seats



Risto Rapala Emblem



Risto Rapala Signature



40-ton graphite blank



NEW
for
2016

Rapala® RODS

RISTO



Tame big fish with confidence. Whether its large Toman in snaggy terrain or big Black Bass near structure and cover, the new Rapala Risto rod will take them on. Sensitivity is uncompromised with a regular taper on a 40-ton graphite blank. An ideal choice for crank and roll applications, from crankbaits to spinnerbaits.



RAPALA

RISTO 

MODEL	LENGTH	LURE WEIGHT	RATING	PCS	TYPE
RSS662MR	6'6"	1/8 - 3/4oz	6 - 16lb	2pc	Spinning
RSS662MHR	6'6"	1/4 - 1oz	8 - 20lb	2pc	Spinning
RSC661MR	6'6"	1/8 - 3/4oz	6 - 16lb	1pc	Casting
RSC662MR	6'6"	1/8 - 3/4oz	6 - 16lb	2pc	Casting
RSC661MHR	6'6"	1/4 - 1oz	8 - 20lb	1pc	Casting
RSC662MHR	6'6"	1/4 - 1oz	8 - 20lb	2pc	Casting





**FEATURING FUJI KR
CONCEPT GUIDES**

MODEL	LENGTH	LINE RATING	LURE WEIGHT	PCS	ACTION	TYPE
SWC631LRF	6'3"	4 - 10 lb	1/8 - 1/2 oz	1	Regular Fast	Casting
SWC631MLRF	6'3"	6 - 12 lb	3/16 - 5/8 oz	1	Regular Fast	Casting
SWC632LRF	6'3"	4 - 10 lb	1/8 - 1/2 oz	2	Regular Fast	Casting
SWC632MLRF	6'3"	6 - 12 lb	3/16 - 5/8 oz	2	Regular Fast	Casting



Fuji ECS Reel Seat



Regular fast action taper for greater control



Premium grade lightweight cork grip



Fuji KR-Concept Alconite Guides



Custom Rapala Snow emblem



NEW
for
2016

RAPALA® RODS

SNOW

Perfect Elegance. Absolute Control.

The all-new and improved Rapala Snow 2016



The 2016 Rapala Snow is more than a facelift from its predecessor. An all-new, lightweight 40-ton graphite blank with a regular-fast taper offers the angler absolute control, whether casting or fighting fish. Fuji KR Concept guides maximize the rod blank's performance and reduce twisting torque. A truly elegant baitcasting rod for light tackle applications.



RAPALA® RODS



FEATURING FUJI KR
CONCEPT GUIDES

RAPALA *RFS Finesse Series*
The Essence of Finesse Fishing

MODEL		LENGTH	LINE	LURE WEIGHT	PIECE	ACTION	TYPE
MICROLOGY	RFSC632XL	6'3"	2 - 5lb	1/32 - 3/16oz	2pc	Extra Fast	Casting
ZEPHYR	RFSC642UL	6'4"	3 - 10lb	1/16 - 1/4oz	2pc	Extra Fast	Casting
ELEGANCE	RFSS682XL	6'8"	2 - 6lb	1/64 - 1/4oz	2pc	Extra Fast	Spinning



MICROLOGY



ZEPHYR



ELEGANCE

RFS *Finesse Series*

The Essence of Finesse Fishing

Lightweight. Sensitive. Elegant.

Integrating only the finest components such as Fuji's revolutionary KR guides and ECS reel seat into an ultra hi-modulus 40-ton graphite blank, Rapala Finesse Series rods will bring you to an all-new level of finesse fishing.

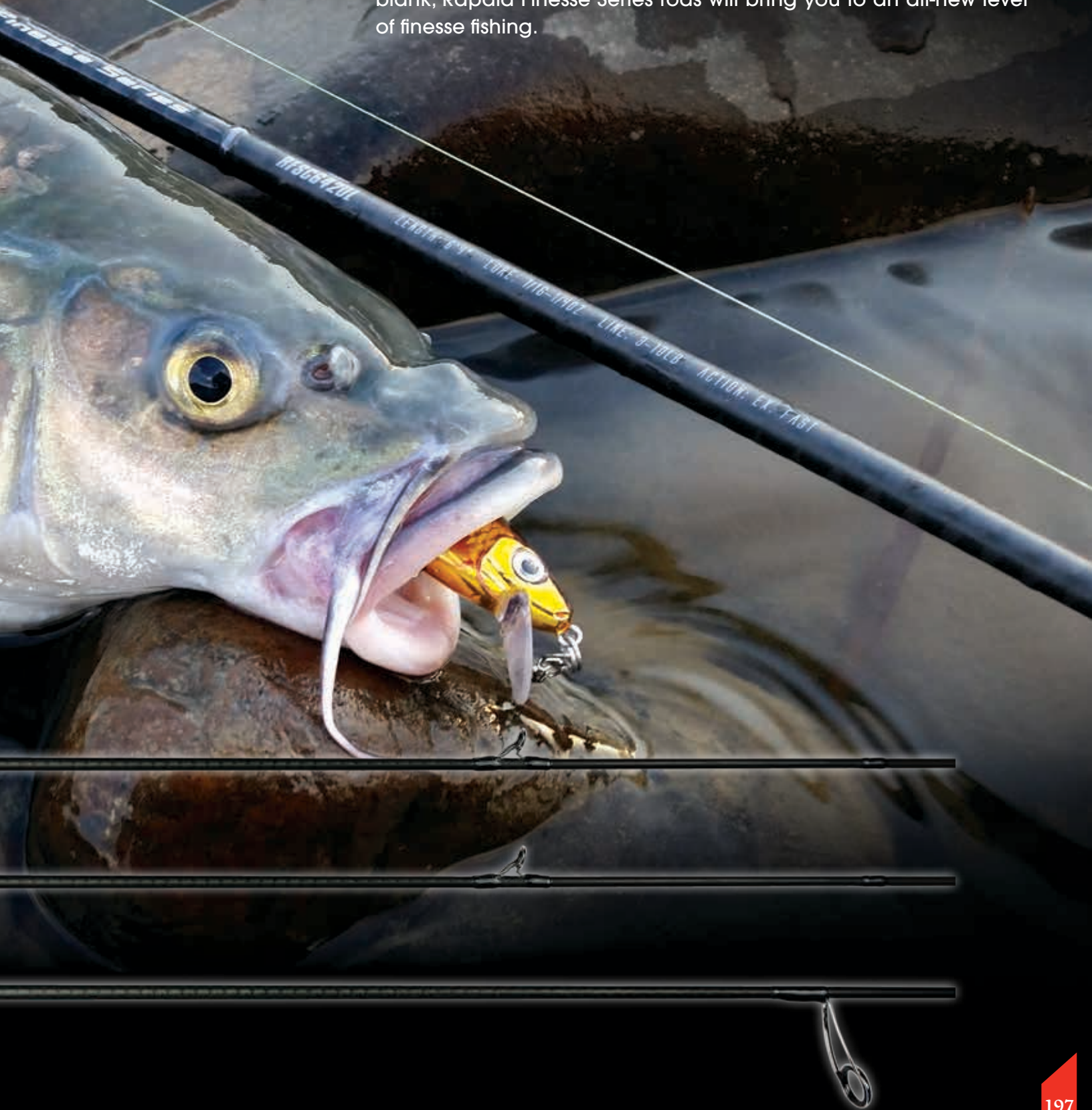

RAPALA® RODS NEW for 2016

KOIVU

INSPIRED BY NATURE

An all-round performer whether in freshwater rivers and lakes to brackish mangroves and open saltwater. The word "Koivu" means 'Birch' in Finnish, which is the inspiration behind the Koivu range. Responsive, strong and easy-casting, the Koivu is an ideal all-purpose rod whether for crankbaits, jerkbaits or even soft plastics.



RAPALA KOIVU

MODEL	LENGTH	PIECE	LURE WEIGHT	LINE RATING	TYPE
KVS-651L	6'5"	1 pc	1/32 - 1/4oz	4 - 10lb	Spinning
KVC-651L	6'5"	1 pc	1/32 - 1/4oz	4 - 10lb	Casting
KVS-652L	6'5"	2 pc	1/32 - 1/4oz	4 - 10lb	Spinning
KVC-652L	6'5"	2 pc	1/32 - 1/4oz	4 - 10lb	Casting
KVS-651ML	6'5"	1 pc	1/8 - 3/8oz	6 - 12lb	Spinning
KVC-651ML	6'5"	1 pc	1/8 - 3/8oz	6 - 12lb	Casting
KVS-652ML	6'5"	2 pc	1/8 - 3/8oz	6 - 12lb	Spinning
KVC-652ML	6'5"	2 pc	1/8 - 3/8oz	6 - 12lb	Casting



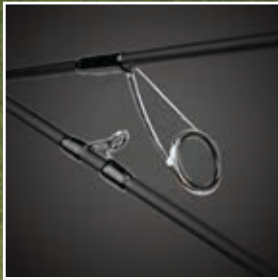

Fuji KR Alconite guides



Fuji ECS / VSS reel seat



Custom Rapala Emblem



FEATURING
FUJI KR
CONCEPT
GUIDES



RAPALA **KAIJU**

MODEL	LENGTH	PIECE	LURE WEIGHT	LINE RATING	TYPE
KVS-651M	6'5"	1 pc	3/16 - 1/2oz	8 - 14lb	Spinning
KVC-651M	6'5"	1 pc	3/16 - 1/2oz	8 - 14lb	Casting
KVS-652M	6'5"	2 pc	3/16 - 1/2oz	8 - 14lb	Spinning
KVC-652M	6'5"	2 pc	3/16 - 1/2oz	8 - 14lb	Casting
KVS-661MH	6'6"	1 pc	1/4 - 1oz	12 - 20lb	Spinning
KVC-661MH	6'6"	1 pc	1/4 - 1oz	12 - 20lb	Casting
KVS-662MH	6'6"	2 pc	1/4 - 1oz	12 - 20lb	Spinning
KVC-662MH	6'6"	2 pc	1/4 - 1oz	12 - 20lb	Casting



RAPALA *vellamo*
motion of water

MODEL	LENGTH	LURE WEIGHT	LINE RATING	TYPE
VMC632M	6'3"	3/16 - 1/2oz	8 - 14lb	Casting
VMS632M	6'3"	3/16 - 1/2oz	8 - 14lb	Spinning
VMC631M	6'3"	3/16 - 1/2oz	8 - 14lb	Casting
VMS631M	6'3"	3/16 - 1/2oz	8 - 14lb	Spinning
VMC662MH	6'6"	1/4 - 1oz	10 - 20lb	Casting
VMS662MH	6'6"	1/4 - 1oz	10 - 20lb	Spinning
VMC661MH	6'6"	1/4 - 1oz	10 - 20lb	Casting
VMS661MH	6'6"	1/4 - 1oz	10 - 20lb	Spinning



NEW
for
2016

RAPALA® RODS

vellamo

motion of water

control of water, lake and sea



Style. Performance. Sensitivity.

These qualities are no longer exclusive only to expensive rods. Whether its the ease of casting, the power to grapple with a big one or the eye-catching looks that will surely turn heads on the water, the new Rapala Vellamo offers everything the lure angler needs to take control of every water, lake and sea.

EQUIPPED WITH GENUINE FUJI GUIDES AND REEL SEAT.

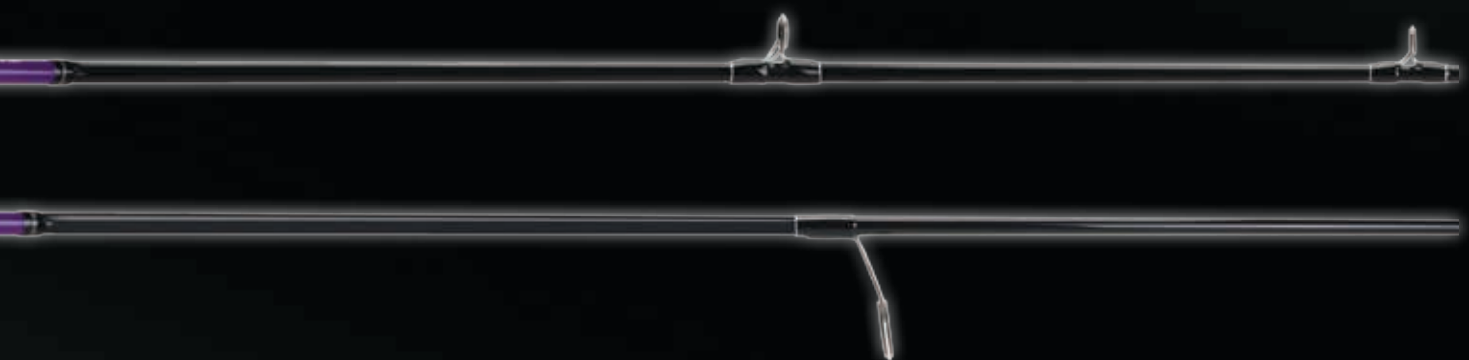

**FROM HEAVY COVER
TO BLUEWATER**



Monstar

HEAVY COVER AND BIG BAIT WEAPON

MODEL	LENGTH	LURE WEIGHT	LINE RATING	PIECE	TYPE
MTC621HR	6'2"	10 - 50g	PE 1 - 3	1 - pc	Casting
MTS610BHR	6'10"	10 - 60g	PE 1 - 3	2 - pc Butt Joint	Spinning
MTC610BHR	6'10"	10 - 60g	PE 1 - 3	2 - pc Butt Joint	Casting
MTS76BHR	7'6"	10 - 60g	PE 1 - 3	2 - pc Butt Joint	Spinning
MTS76BXHR	7'6"	15 - 90g	PE 2 - 4	2 - pc Butt Joint	Spinning



Featuring genuine Fuji Alconite guides and components





Shore - X

Shore Casting Game

The versatile shore casting and jigging instrument for lure and micro jig

Features:

1. Fuji KR Concept guides maximizes blank performance.
2. Lightweight yet powerful 40-ton graphite blank for punching out lures or jigs.
3. Powerful butt-section for battling fish.
4. Fuji VSS reel seat for optimum ergonomic comfort.





FEATURING FUJI KR
CONCEPT GUIDES

STORM

Shore - X
Shore Casting Game

MODEL	LENGTH	PIECE	LINE RATING	LURE WEIGHT	ACTION	TYPE
SXS802ML	8'0"	2 - pc	PE 0.4 - 1.2	3 - 15g	Extra Fast	Spinning
SXS862MH	8'6"	2 - pc	PE 0.8 - 2.0	7 - 30g	Extra Fast	Spinning





trickster

stealth . agility . speed

Featuring **NEW** Hybrid Micro Guide System



MODEL	LENGTH	PIECE	LINE RATING	LURE WEIGHT	ACTION	TYPE
TRS612L	6'1"	2 - pc	4 - 10lb	3/16 - 1/2 oz	Extra Fast	Spinning
TRS612M	6'1"	2 - pc	6 - 14lb	1/4 - 5/8 oz	Extra Fast	Spinning
TRS622MH	6'2"	2 - pc	8 - 20lb	1/4 - 3/4 oz	Extra Fast	Spinning
TRS611L	6'1"	1 - pc	4 - 10lb	3/16 - 1/2 oz	Extra Fast	Spinning
TRS611M	6'1"	1 - pc	6 - 14lb	1/4 - 5/8 oz	Extra Fast	Spinning
TRS621MH	6'2"	1 - pc	8 - 20lb	1/4 - 3/4 oz	Extra Fast	Spinning
TRS672L	6'7"	2 - pc	4 - 12lb	3/16 - 1/2 oz	Extra Fast	Spinning
TRS672M	6'7"	2 - pc	6 - 16lb	1/4 - 5/8 oz	Extra Fast	Spinning
TRS682MH	6'8"	2 - pc	8 - 25lb	1/4 - 3/4 oz	Extra Fast	Spinning
TRS671L	6'7"	1 - pc	4 - 12lb	3/16 - 1/2 oz	Extra Fast	Spinning
TRS671M	6'7"	1 - pc	6 - 16lb	1/4 - 5/8 oz	Extra Fast	Spinning
TRS681MH	6'8"	1 - pc	8 - 25lb	1/4 - 3/4 oz	Extra Fast	Spinning





STORM *trickster*
stealth · agility · speed

MODEL	LENGTH	PIECE	LINE RATING	LURE WEIGHT	ACTION	TYPE
TRC612L	6'1"	2 - pc	4 - 10lb	3/16 - 1/2 oz	Extra Fast	Casting
TRC612M	6'1"	2 - pc	6 - 14lb	1/4 - 5/8 oz	Extra Fast	Casting
TRC622MH	6'2"	2 - pc	8 - 20lb	1/4 - 3/4 oz	Extra Fast	Casting
TRC611L	6'1"	1 - pc	4 - 10lb	3/16 - 1/2 oz	Extra Fast	Casting
TRC611M	6'1"	1 - pc	6 - 14lb	1/4 - 5/8 oz	Extra Fast	Casting
TRC621MH	6'2"	1 - pc	8 - 20lb	1/4 - 3/4 oz	Extra Fast	Casting
TRC672L	6'7"	2 - pc	4 - 12lb	3/16 - 1/2 oz	Extra Fast	Casting
TRC672M	6'7"	2 - pc	6 - 16lb	1/4 - 5/8 oz	Extra Fast	Casting
TRC682MH	6'8"	2 - pc	8 - 25lb	1/4 - 3/4 oz	Extra Fast	Casting
TRC671L	6'7"	1 - pc	4 - 12lb	3/16 - 1/2 oz	Extra Fast	Casting
TRC671M	6'7"	1 - pc	6 - 16lb	1/4 - 5/8 oz	Extra Fast	Casting
TRC681MH	6'8"	1 - pc	8 - 25lb	1/4 - 3/4 oz	Extra Fast	Casting





Built with genuine Fuji guides and reel seat

STORM CASTING

MODEL	LENGTH	LURE WEIGHT	RATING	PCS	ACTION
AVC662ULF	6'6"	1/8 - 1/4oz	2 - 6lb	2pc	Fast
AVC662LX	6'6"	3/16 - 3/8oz	4 - 10lb	2pc	Extra Fast
AVC662MLX	6'6"	3/16 - 1/2oz	6 - 12lb	2pc	Extra Fast
AVC662MF	6'6"	1/4 - 3/4oz	8 - 17lb	2pc	Reg Fast
AVC662MH	6'6"	1/4 - 1oz	10 - 20lb	2pc	Fast



NEW
for
2016

STORM

RODS

A new Discovery. A new Adventure.
Adventure



STORM SPINNING

MODEL	LENGTH	LURE WEIGHT	RATING	PCS	ACTION
AVS662ULF	6'6"	1/8 - 1/4oz	2 - 6lb	2pc	Fast
AVS662LX	6'6"	3/16 - 3/8oz	4 - 10lb	2pc	Extra Fast
AVS662MLX	6'6"	3/16 - 1/2oz	6 - 12lb	2pc	Extra Fast
AVS702MF	7'0"	3/16 - 3/4oz	6 - 16lb	2pc	Fast
AVS702MHF	7'0"	1/4 - 1oz	8 - 20lb	2pc	Fast
AVS662MHF	6'6"	1/4 - 1oz	10 - 20lb	2pc	Fast



STORM *discovery*
Ignition . passion . dedication

MODEL	LENGTH	PIECE	LINE RATING	LURE WEIGHT	ACTION	TYPE
DSS602UL	6'0"	2-pc	2-6lb	3/16 - 3/8 oz	Moderate	Spinning
DSS602L	6'0"	2-pc	4-10lb	3/16 - 3/8 oz	Moderate	Spinning
DSS602ML	6'0"	2-pc	6-12lb	1/4 - 1/2 oz	Moderate	Spinning
DSS662M	6'6"	2-pc	8-17lb	1/4 - 3/4 oz	Fast	Spinning
DSS662MH	6'6"	2-pc	10-20lb	3/8 - 1 oz	Fast	Spinning

discovery
 ignition . passion . dedication

STORM ***discovery***
 ignition . passion . dedication

MODEL	LENGTH	PIECE	LINE RATING	LURE WEIGHT	ACTION	TYPE
DSC602UL	6'0"	2-pc	2-6lb	3/16 - 3/8 oz	Moderate	Casting
DSC602L	6'0"	2-pc	4-10lb	3/16 - 3/8 oz	Moderate	Casting
DSC602ML	6'0"	2-pc	6-12lb	1/4 - 1/2 oz	Moderate	Casting
DSC602M	6'0"	2-pc	8-17lb	1/4 - 3/4 oz	Fast	Casting
DSC662MH	6'6"	2-pc	10-20lb	3/8 - 1 oz	Fast	Casting
DSC601ML	6'0"	1-pc	6-12lb	1/4 - 1/2 oz	Moderate	Casting
DSC601M	6'0"	1-pc	8-17lb	1/4 - 3/4 oz	Fast	Casting
DSC661MH	6'6"	1-pc	10-20lb	3/8 - 1 oz	Fast	Casting

STORM

RODS

NEW
for
2016

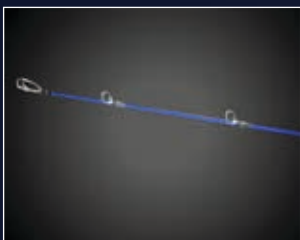

Optimal recoil for slow jigs



30 & 40 ton blend graphite



Fuji T-DPS reel seat



Fuji Alconite Guides



ADAJO

GOMOKU: SLOW-TUNED *Slow Jigging Full Spec*

Work slow-style jigs easily with each pitch or crank. The Gomoku Adajo is built on a 30 and 40-ton blend graphite blank with a slow taper for optimal recoil when working slow jigs up to 200 grams. Jigging strokes are less taxing on the angler and the optimal recoil allows for a greater tension 'free-fall' on the drop to bring out the slow jig's optimal fluttering action.

STORM

ADAJO

MODEL	LENGTH	PE RATING	JIG WEIGHT
AJC631-1 NEW	6'3"	1	Max 100g
AJC631-2	6'3"	2	Max 200g
AJC631-3 NEW	6'3"	3	Max 300g

STORM RODS

GoMoKu
SUPER 五目ジグ CONCEPT



STORM

erito

MODEL	LENGTH	MAX JIG WEIGHT	MAX PE	Type
ERC601MR	6'0"	100g	1.5	Casting
ERS601MR	6'0"	100g	1.5	Spinning





**LIGHTER.
MORE SENSITIVE.
MORE POWERFUL.**

ERITO

BESPOKE LIMITED SERIES

STORM GOMOKU JIGGING RODS

- Fuji Alconite KR Concept Guides
- Fuji VSS and ACS reel seats
- High-modulus, ultra-sensitive graphite blank
- Short & balanced handle for micro jigging (Keiryō only)

STORM **K**aiten

MODEL	LENGTH	PIECE	LINE RATING	LURE WEIGHT	ACTION	TYPE
GOS601M	6'0"	1 - pc	PE 1 - 3	Max 160g	Reg. Fast	Spinning
GOC601M	6'0"	1 - pc	PE 1 - 3	Max 160g	Reg. Fast	Casting

STORM **E**rito

MODEL	LENGTH	PIECE	LINE RATING	LURE WEIGHT	ACTION	TYPE
GOS601L	6'0"	1 - pc	PE 0.8 - 1.5	Max 120g	Reg. Fast	Spinning
GOC601L	6'0"	1 - pc	PE 0.8 - 1.5	Max 120g	Reg. Fast	Casting

STORM **K**eiryō

MODEL	LENGTH	PIECE	LINE RATING	LURE WEIGHT	ACTION	TYPE
GOS601UL	6'0"	1 - pc	PE 0.4 - 1	Max 40g	Reg. Fast	Spinning
GOC601UL	6'0"	1 - pc	PE 0.4 - 1	Max 40g	Reg. Fast	Casting



KAITEN - GOS601M



KAITEN - GOC601M



ERITO - GOS601L



ERITO - GOC601L



KEIRYO - GOS601UL



KEIRYO - GOC601UL

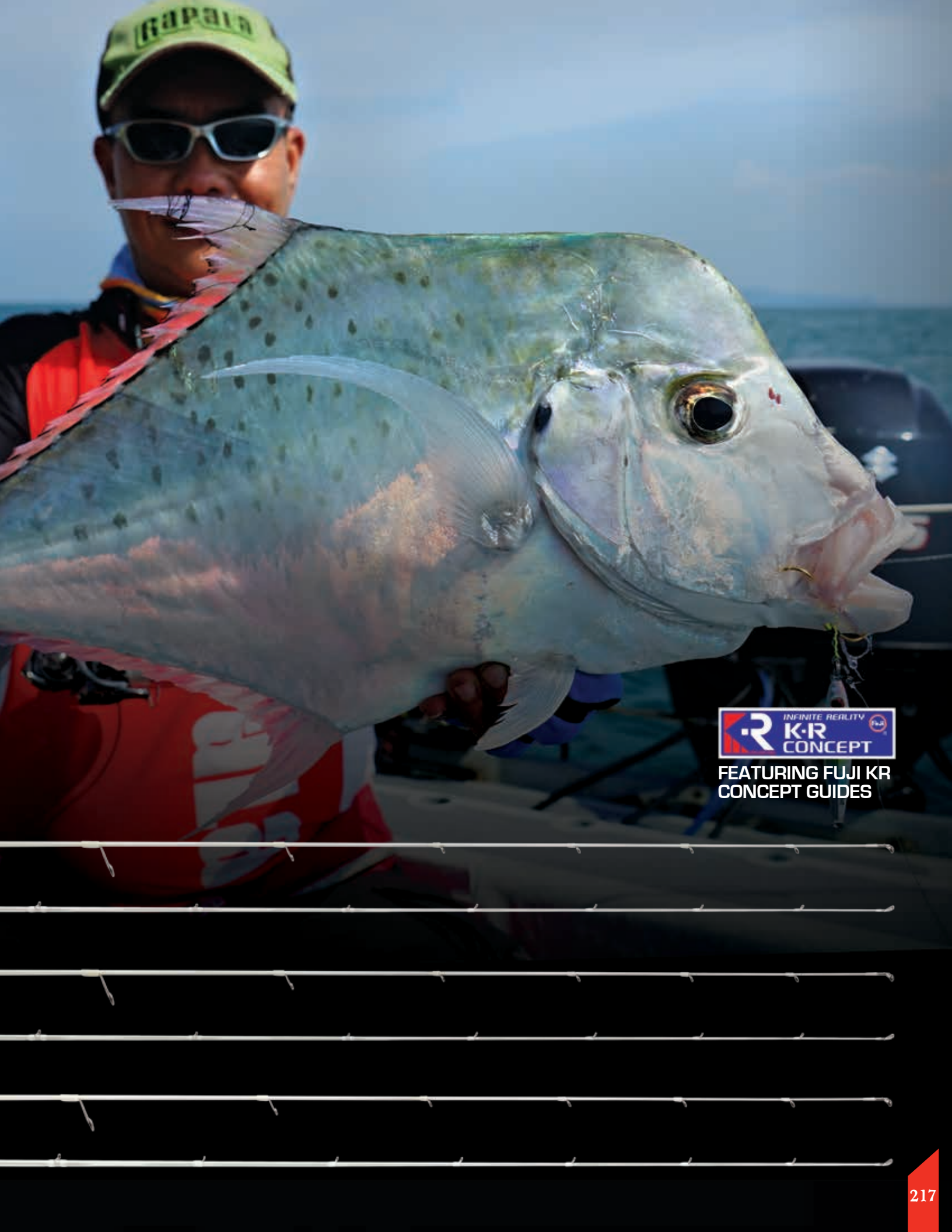

FEATURING FUJI KR
CONCEPT GUIDES



MICRO JIGGER
micro-jigging rod

MICRO JIGGER

m i c r o j i g g i n g g a m e

Features: • Shorter butt design for flicking technique. • Lightweight, sensitive and fast action blank. • Micro guides for optimum blank performance and line control.

STORM MICRO JIGGER

MODEL	LENGTH	PIECE	LINE RATING	MAX JIG	ACTION	TYPE
MJS631L	6'3"	1 - pc	PE 0.4 - 1	30g	Fast	Spinning
MJC631L	6'3"	1 - pc	PE 0.4 - 1	30g	Fast	Casting



WILLIAMSON *Soprano*
HIGH PITCH WEAPON

MODEL	LENGTH	PIECE	PE RATING	WEIGHT	ACTION	TYPE
SRS521H	5'2"	1-pc	PE 1 - 3	235g	Slow	Spinning
SRS511XH	5'1"	1-pc	PE 2 - 4	244g	Slow	Spinning
SRS501XXH	5'0"	1-pc	PE 3 - 5	262g	Slow	Spinning



Soprano

H I G H P I T C H W E A P O N



WILLIAMSON *Soprano*
H I G H P I T C H W E A P O N

MODEL	LENGTH	PIECE	PE RATING	WEIGHT	ACTION	TYPE
SRC521H	5'2"	1-pc	PE 1 - 3	233g	Slow	Casting
SRC511XH	5'1"	1-pc	PE 2 - 4	241g	Slow	Casting
SRC501XXH	5'0"	1-pc	PE 3 - 5	253g	Slow	Casting





TRIGGER X[®]

TRIGGER THE BITE™

AGGRESSION FORMULA SOFT PLASTIC

Trigger all species of gamefish with Trigger X enhanced soft plastics. This soft bait formula allows these easy-to-handle baits to swim with an incredibly natural motion, while releasing a special cocktail of Ultrabite[®] Aggression Pheromones which combines "aggression" and "fear" pheromones that mimic the natural predator vs. prey response.

The body shapes have been meticulously fine-tuned for ultimate performance. Phthalate-free composition eliminates that "plastic" smell found in other soft baits, putting an end to scent contamination.

PHTHALATE-FREE SOFT PLASTIC COMPOSITION

Extremely precise bio-salt infused formulas match bait density to body shape for maximum action.

ULTRABITE[®] AGGRESSION PHEROMONES

A custom blend of "aggression" and "fear" pheromones that mimic the natural predator vs. prey response.

MULTI-SPECIES

Body shape and action are perfect for most gamefish applications.

DESIGNED TO TRIGGER FEEDING INSTINCT

Body designs present the exact required profile. Serious action with pro-picked colors, perfect for every condition.

RIBBED SURFACE AREA

Significant ridge structure creates a softer "life-like" feel while increasing lure surface area and allowing increased pheromone distribution.

EASY-TO-HANDLE PACKS

Resealable Bag allows fast changes and quick re-baiting when the action is hot.

FLAPPIN' CRAW

Incredible life-like action is the trademark of this craw. Fish it as a trailer or rig on a plain jig head. The Flappin' Craw has just enough heft for ease of fishing and matches well to a wide variety of jig sizes. Claws rise in defense at rest, with a mild kicking action on retrieve.

ITEM NO	LENGTH	PIECES
PTXFC25	6 cm	10
PTXFC3	8 cm	8



GBGP
Goobar Grape



GPCH
Green Pumpkin Chartreuse Pepper



GPOB
Green Pumpkin Orange Black



ICEU
Icicle UV



PBJ
Peanut Butter Jelly

AGGRESSION FORMULA

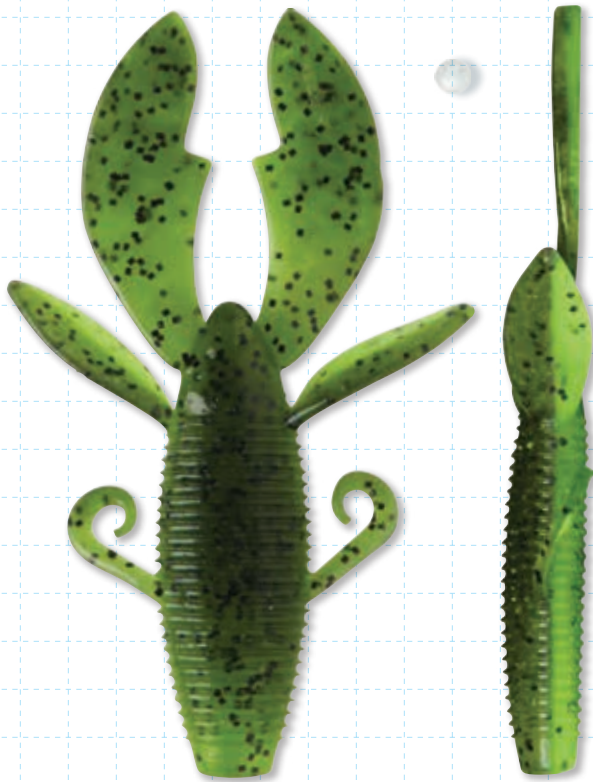

FLAPPIN' BUG

Whether flipped, pitched or cast into the heaviest of cover, the Flappin' Bug delivers. The lively action, combined with fish triggering scent, turns the wariest species into aggressors. Texas rig for a head down presentation. When paused, the claw flaps will slowly rise and straighten out. Top-to-bottom dual or solid colors.

ITEM NO	LENGTH	PIECES
PTXFB35	9 cm	8

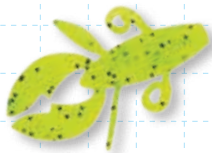

CHPU
Chartreuse Pearl UV



ICEU
Icicle UV

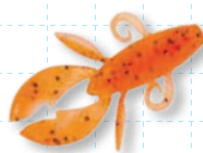

ORPU
Orange Pearl UV

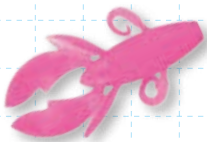

PKPU
Pink Pearl UV

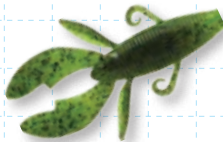

WMCH
Watermelon Chartreuse Pepper



Each bait is specially formulated with Ultrabite[®] Aggression Pheromones for advanced, proven fish triggering.



CHPU
Chartreuse Pearl UV

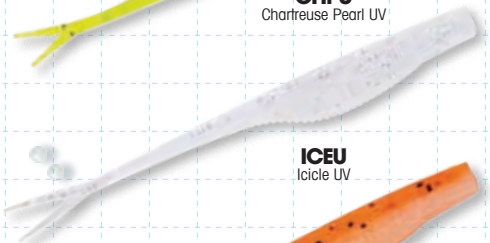

ICEU
Icicle UV



ORPU
Orange Pearl UV



PKPU
Pink Pearl UV



SNR
Shiner

MINNOW

The classic shaped Minnow provides an erratic, gliding action along with subtle tail vibration. Rig it Texas style or on a jig head... fish it fast or slow... the Minnow with Ultrabite[®] Aggression Pheromones "Triggers the Bite"!

ITEM NO	LENGTH	PIECES
PTXMN5	13 cm	10



AGGRESSION FORMULA



CHPU
Chartreuse Pearl UV



NEW
HDI
Houdini



ICEU
Icicle UV



ORPU
Orange Pearl UV



PKPU
Pink Pearl UV



NEW
SMD
Smelt



SLOP HOPPER

Rig this Texas-style on a heavy wire VMC® wide gap hook and hold on. It effortlessly hops through the heaviest slop or can be fished just below the surface like a swimmer in open water. Twisting, rolling and hopping, this one is truly unlike anything you, or the fish, have ever seen before. Top-to-bottom dual or solid colors.

ITEM NO	LENGTH	PIECES
PTXSLH35	9 cm	10
PTXSLH45	11 cm	6
PTXSLH55	14 cm	6



SNR
Shiner



NEW WM
Watermelon

SWIMMING GRUB

The wide cut, quick taper tail design swims with maximum vibration at any speed. Fish it slow when a smooth, rhythmic tempo is needed, or fish it fast with an "aggressive" swimming action for quick-strike circumstances. Solid and dual body-to-tail patterns.

ITEM NO	LENGTH	PIECES
PTXSG4	10 cm	12

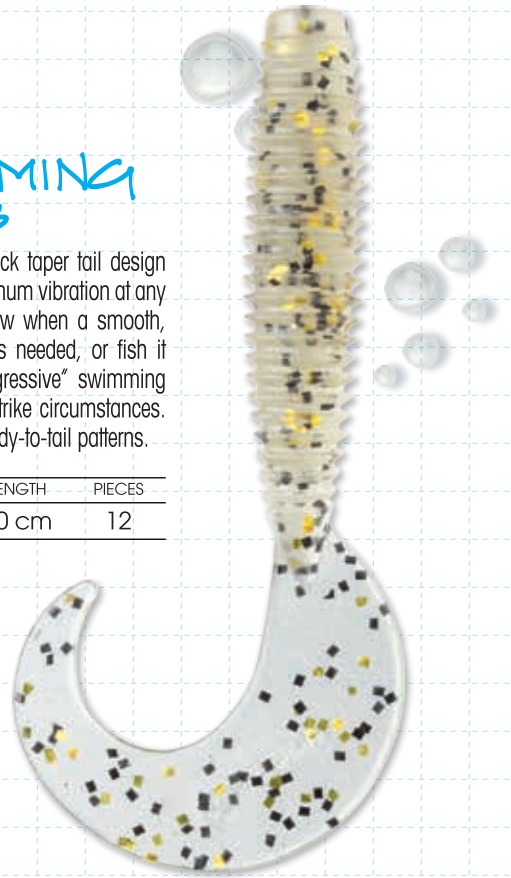

CHPU
Charfreuse Pearl UV



NEW EO
Emerald Oil



GO
Goby

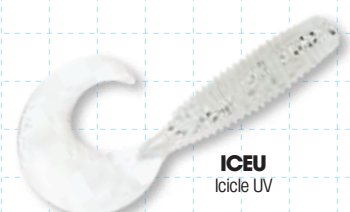

ICEU
Ice UV



NEW JB
June Bug



ORPU
Orange Pearl UV



PKPU
Pink Pearl UV

RESPECTED RAPALA BRANDS

