

Designed to perform
Engineered to last



BOWMAN
SPECIALISTS IN CLAY PIGEON TRAPS

Contents

Automatic traps

Supermatch Sporting Double **NEW**

Supermatch One

Supermatch Six

Supermatch Eight

Super Rabbit/Chondel

Accessories for Automatic traps



Skeet model
with solenoid
release



Modular Base for ABT
(Automatic ball trap discipline)



Base includes radio release for use with the Supermatch Six, Eight and Sporting Double.

Manual traps

SuperTrap 2000

SuperTrap Junior

SuperTrap No 2

SuperTrap No 3

Bolting Rabbit and Fur & Feather

Accessories for Manual traps

Spare Parts for Manual traps

Back page

Super Simulator Game Trailer **NEW**



Why choose Bowman?

When it comes to clay traps, Bowman traps are designed to perform and engineered to last.

As a specialist clay trap manufacturer, we offer you more than clay traps. We design and manufacture them ourselves so we have an intimate understanding of how they work and perform. With our before and after sales service we can use this knowledge to help you get the most from our traps.

Traps to suit all disciplines

Bowman manufactures traps and bases to suit all disciplines:

ABT (Automatic Ball Trap)

DTL (Down the line)

Skeet

Olympic & Universal Trench

Double Trap

With low and high capacity carousels, solenoid release, timer interrupters, turn buckle adjustments, low trap heights to suit all trap houses and cross wind adjustment for true level flight, you can be sure of supreme performance.

By using innovative designs and manufacturing techniques, we offer outstanding reliability and value for money. Simply ring for a quote on 01777 870243.

Bowman traps offer you the ultimate shooting experience with traps designed for supreme performance with:

- **Traps available for all disciplines**
- **Easy and quick changes of a clay's trajectory** *(without the need for a spanner)*
- **Absolute flexibility across the elevation to give maximum trajectory options**
- **Quick and easy changes of trap tension** *(without the need for a spanner)* to increase or reduce a clay's distance
- **Supreme quality casting aluminium bodies to absorb vibrations and reduce clay breakage**
- **Superior safety features including locking mechanisms, positive trigger releases and yellow ring guards**
- **Flexibility across the range with interchangeable parts**
- **The ability to make bespoke machines for customers**



Bowman traps have been established for over 40 years and even today we have original traps being used at grounds and by individuals. Our traps, including the more recent automatic traps, have been designed and built to last with:

- **The use of casting technology which is completed in-house to maintain quality**
- **The best quality materials**
- **Features such as enclosures for bearings to protect them from the elements**

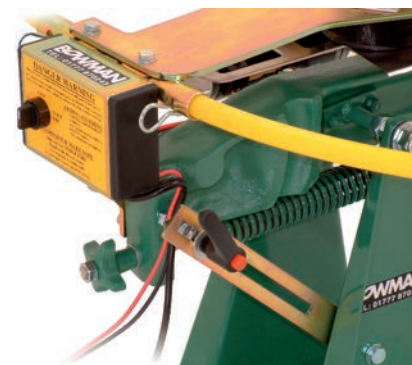

Bowman's stock a full range of spare parts that are available for next day delivery nationwide.

Finally, with our design and build expertise, we are pleased to introduce our latest trap, **the Supermatch Sporting Double**. This trap is unique to Bowman and successfully throws a close pair at all angles up to 75°. Details of our latest trap can be found on the next page.

Have a look through our brochure, then contact us for more information, to set up an account, or place an order.



Automatic Traps

All our automatic traps are manufactured to the following specification:

- Built to last using hi-tensile/heavy duty aluminium castings
- 50 metre cable with button release for convenience and safety
- Hard wired circuitry for safety
- Long life bearings and seals
- Yellow guards for safety
- Knife edge clay feed system for multi stack traps for outstanding performance
- Stainless steel sprung soft fall plate for reduced clay breakage
- Supplied fully assembled and tested with 3 year warranty
- 12V DC

The range of automatic traps offered means that there is sure to be one to suit your needs whether you shoot alone or are buying for a club or a ground.

Supermatch Sporting Double

The Supermatch Sporting Double is an industry first from Bowman Traps. Requests from customers for a Sporting Double have led us to design and manufacture this unique trap.

Using knowledge and expertise built up over many years, we now offer a clay trap that can throw a close or 'V' pair.

Specification

- ▶ Trap weight of 75Kg
- ▶ 10 stack - 400 capacity
- ▶ Cycle time: 2 seconds
recock time



NEW

Highlights

- ▶ Bowman's first Sporting Double/Close Pair trap
- ▶ Great capacity with 400 clays as standard, with an option for 500
- ▶ Standard pair maximum throwing distance of 80 metres, singles distance of 95 metres
- ▶ Elevation to 75° - from horizontal to springing teal
- ▶ Throws from 'close pair' to a wide 'V' (see left)
- ▶ Standard or midi carousel available
- ▶ **Optional radio release:** Can switch from double to single throwing at the flick of a switch for ultimate flexibility and a great sporting experience

WIDE 'V'

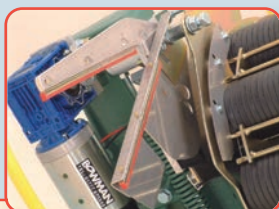

MEDIUM SPREAD

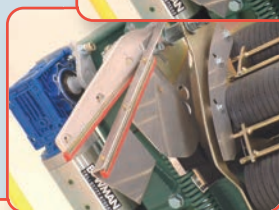

CLOSE PAIR

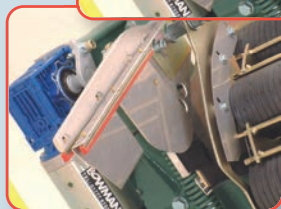

Shown on optional standard barrow

Supermatch One

The Supermatch One is our most portable automatic trap. Weighing only 24Kg, this trap can fit into an estate car or off road vehicle for easy transportation. It's perfect for those wanting to shoot in various locations.

Highlights

- ▶ Portable
- ▶ Fast re-cocking time of 0.9 seconds means up to six clays in the air at once
- ▶ 65 clay capacity which can be extended to a capacity of 100 clays
- ▶ Elevation to 75°, from horizontal to springing teal
- ▶ Spring tension provides great performance with a standard clay throwing distance of 80 metres and midi clay throwing distance of 90 metres

Specification

- ▶ Trap weight of 24Kg
- ▶ Mini barrow weight of 7Kg
- ▶ Includes two hoppers to hold 65 standard or midi clays, extendable to 100 with an extension hopper
- ▶ Twin spring clay support system for extra stability
- ▶ Wet clay separator
- ▶ Hard wired circuitry with a 30 AMP fuse
- ▶ Direct gear drive means no chain
- ▶ No spanners required for elevation or spring tension

Supermatch one shown with optional mini barrow



Extension Hopper

Supermatch Six

The Supermatch Six is our best selling automatic trap offering great flexibility and versatility. It is ideal for all grounds and clubs.

Highlights

- ▶ Exceptional capacity of 300 clays in six stacks
- ▶ Elevation to 75°, from horizontal to springing teal
- ▶ Two different spring strengths to suit your needs
- ▶ Powerful 100 metres standard clay throwing distance

Specification

- ▶ Trap weight of 55Kg
- ▶ Re-cocking time of 1.5 seconds
- ▶ Heavy duty motor and gearbox
- ▶ Slotted base for windage adjustment
- ▶ Accurate and easy adjustment of arm parking
- ▶ Hi-tensile aluminium arm
- ▶ Three point clay lowering ramp
- ▶ Two different spring strengths available:
 - 100 metre throwing distance with white spring for a standard clay
 - 80 metre throwing distance with yellow spring for a standard clay
- ▶ Hard wired circuitry with a 40 AMP fuse
- ▶ Unique multi-adjustable base with no spanners required for elevation or spring tension
- ▶ Tilting option when fitted to a tilting base tilt of 40° to left and right
- ▶ Option of fitting an eight stack, 400 clay capacity carousel

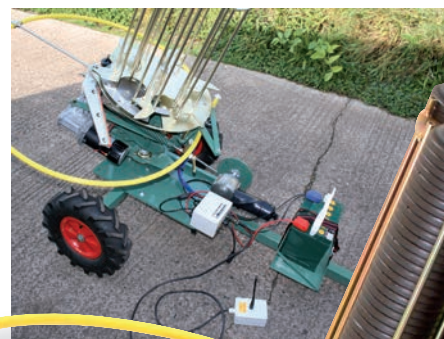

Best Seller

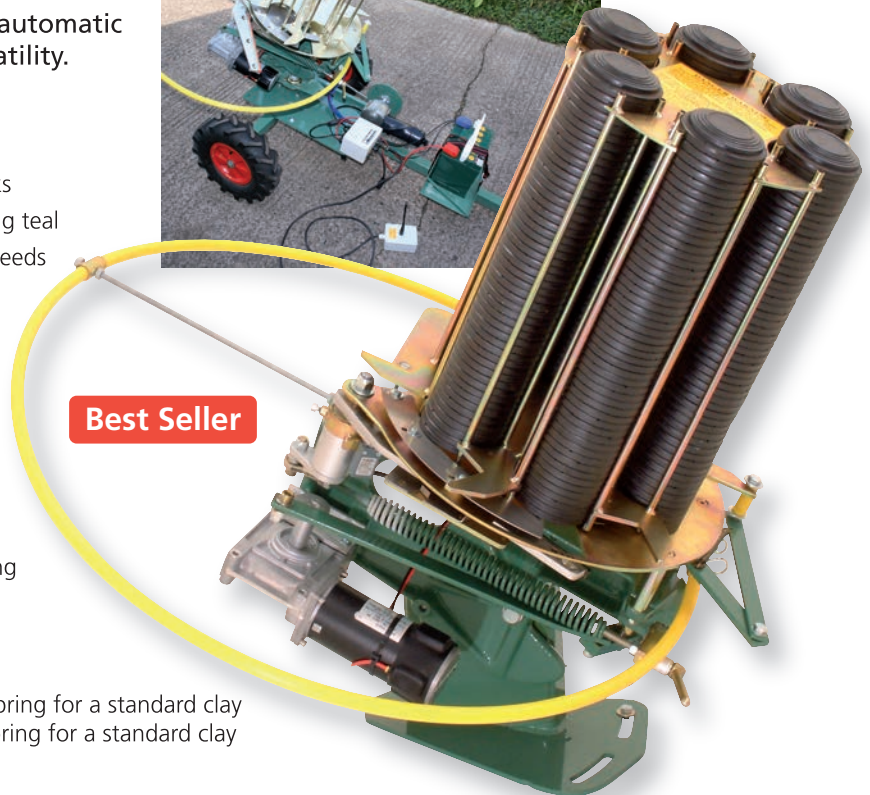

pull!...

Supermatch Eight

The Supermatch Eight offers outstanding capacity and a powerful 150 metre throw. It is perfect for commercial grounds, clubs as well as enthusiasts.

Highlights

- ▶ Great capacity with 400 clays in eight stacks
- ▶ Powerful 150 metres standard clay throwing distance
- ▶ Infinitely variable elevation to 75°, from horizontal to springing teal
- ▶ Spring tension in four different strengths to suit your needs
- ▶ All aluminium construction for minimal clay wastage

Specification

- ▶ Trap weight of 65Kg
- ▶ Re-cocking time of 1.5 seconds
- ▶ Heavy duty motor and gearbox
- ▶ Slotted base for windage adjustment
- ▶ Accurate and easy adjustment of arm parking
- ▶ Thermal overload on/off de-cock and fire button, as well as hard wired circuitry
- ▶ Hi-tensile aluminium arm
- ▶ Long life bearings and seals
- ▶ Three point clay lowering ramp



Supermatch Eight on a Quad barrow

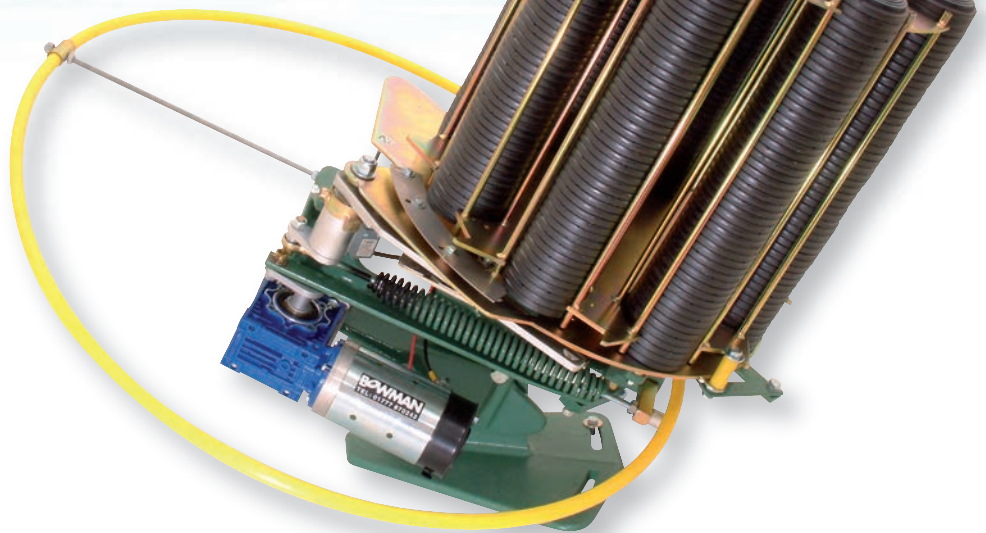

- ▶ Sprung soft fall plate *(standard spring)
- ▶ Four different spring strengths available:
 - 150 metre throwing distance with red spring for a standard clay
 - 135 metre throwing distance with a black spring* for a standard clay
 - 100 metre throwing distance with white spring for a standard clay
 - 80 metre throwing distance with yellow spring for a standard clay
- ▶ Unique multi-adjustable base with no spanners required for elevation or spring tension
- ▶ Tilting option when fitted to a tilting base tilt of 40° to left and right

Supermatch Rabbit/Chondel

The Supermatch Rabbit/Chondel offers the flexibility of a rabbit, chondel or springing teal in one trap. It is ideal for all grounds that want the variety of clay traps and throwing actions and it offers great economy, as you have two traps in one.

Highlights

- ▶ Two traps in one for flexibility
- ▶ Great capacity with 300 clay carousel (400 option)
- ▶ Throws a rabbit or standard clay, with a two minute change over time for different clays
- ▶ Easy to change with infinitely variable clay trajectory using a simple lock lever system allowing elevation anywhere from horizontal to 75° with the standard arm. **Optional extra:** alternate arm allowing elevation from 45° to true vertical ▶
- ▶ Price includes low profile barrow

Specification

- ▶ Trap weight of 100Kg
- ▶ Throws rabbits, standards and midi targets
- ▶ Re-cocking time of 1.5 seconds
- ▶ Laser cut hi-tensile throwing arm
- ▶ Hard wired circuitry and relay with a 40 AMP fuse
- ▶ Spring soft fall plate
- ▶ Three point clay lowering ramp
- ▶ Easily transported, set up and adjusted by using quick lever lock system

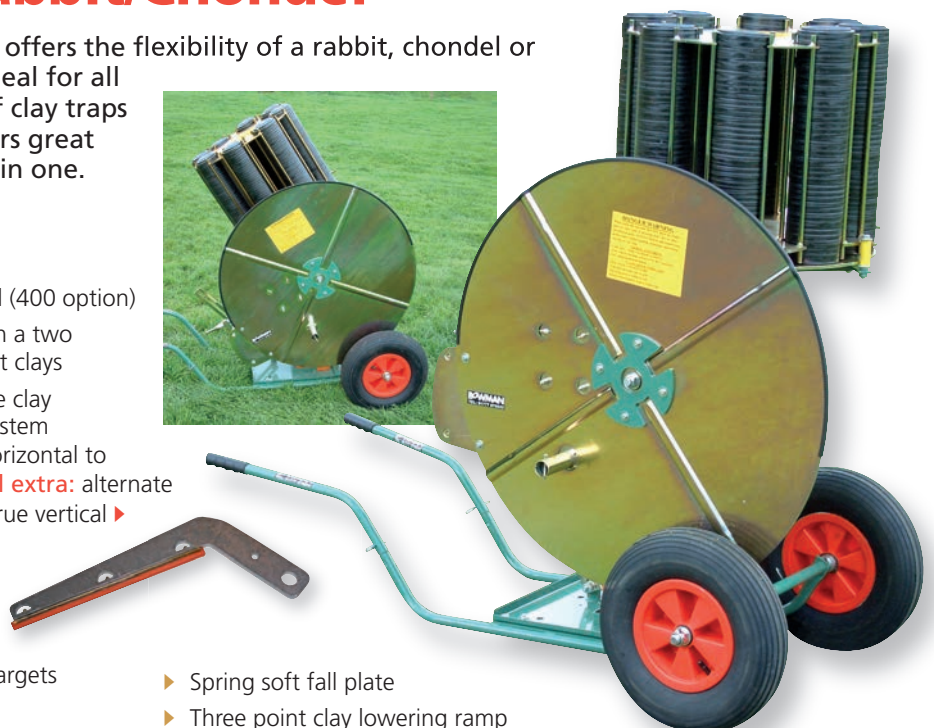

Accessories for automatic traps

The accessories for the automatic traps make it possible to complete all shooting disciplines with Bowman traps. The accessories include:

Battue double rise conversion kit (1) is available for use with all Bowman multi stack traps. Fitted quickly and easily, you then have the option of throwing standard clays or battues from one trap. Also enables you to throw two battues simultaneously off the same arm.

Midi Stack Insert (2) to enable throwing of midis - for use with all multi stack models.

Radio Release System (3) enabling you to operate the trap from up to 200 metres away and is available for use with all automatic traps.

Voice Activated/Acoustic Release System (3) is perfect for individuals that shoot on their own. It can be used with all our automatic traps and is effective up to 200 metres away from the trap.

Tilt base (4) will tilt up to 40° left and right and is suitable for all multi stack automatic traps (excluding Supermatch Rabbit/Chondel).

Tilt and turn base (5) will rotate 360°, side tilts 40° left and right and is ideal for use in towers. This base fits all multi stack automatic traps (excluding Supermatch Rabbit/Chondel).

Low profile barrow (6) is compact. The handles can be removed for easy transportation in an estate car or similar. It weighs only 12Kg and being low to the ground, this barrow is perfect for those that don't want to see the trap.

Standard barrow (7) can be used with all our automatic traps and has been designed so that the battery is positioned underneath the barrow.

Quad barrow (8) has been designed for towing behind any vehicle with a tow ball. With an optional extra ball coupling fitted, up to six traps can be towed in a line and then each trap positioned as required, simplifying set up. Please note that the wheels are only for 20 miles per hour maximum speed.

Mini barrow for the Supermatch One weighs only 7Kg and makes moving the trap to different location easy. (see page 5)

All terrain wheel and tyres (9) for all barrows (excluding the mini barrow) are available and are perfect for moving traps around rough terrain. These tyres are more puncture resistant than the standard tyres.

All barrows (excluding the mini) come with standard 40cm diameter wheel and tyres.

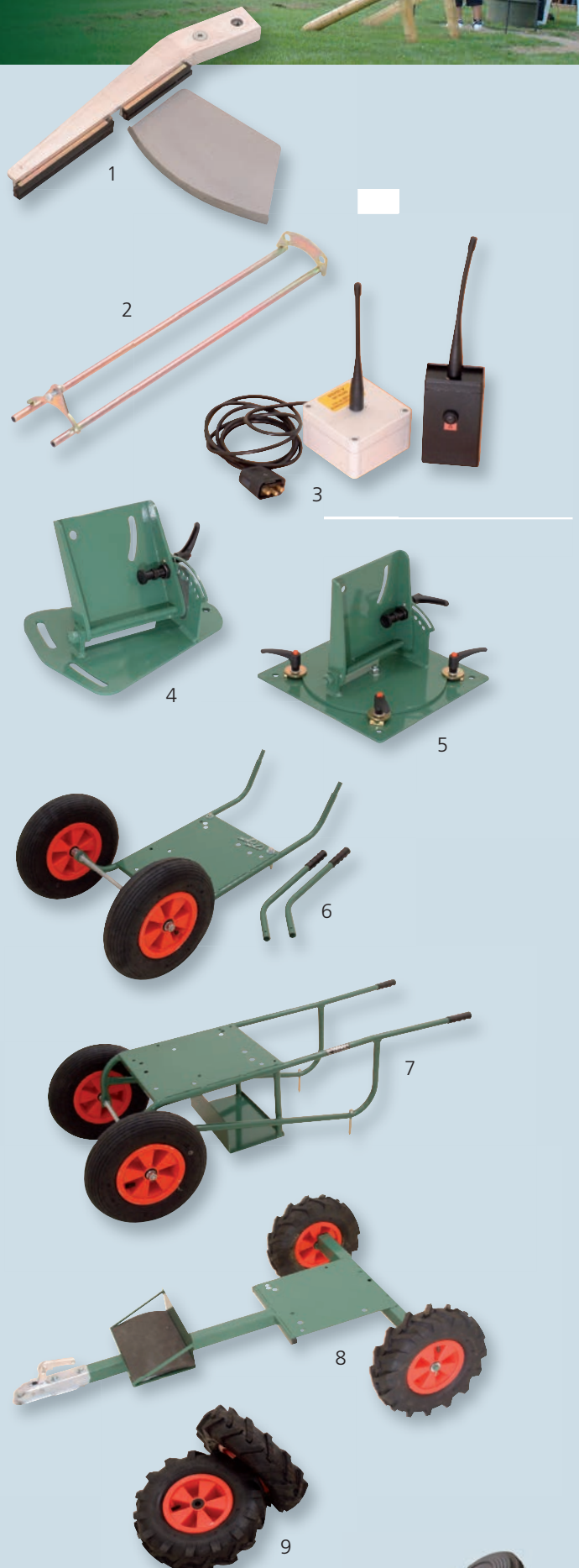

pull!...

7



Manual Traps

All our manual traps have been designed to perform and built to last. Each trap offers you supreme clay throwing, with easy adjustment of elevations without the need for a spanner and minimal clay breakage.

Bearings are protected from the environment and our high quality aluminium castings make for many years of trouble free operation and enjoyment.

Safety features have been incorporated into the design of our traps with safety rings and positive trigger releases as just two examples.

SuperTrap 2000 (complete with Tripod Stand)

Easy and safe to use the SuperTrap 2000 is a powerful trap providing a complete range of challenging targets. A three quarter semi re-cocking action combined with the lever allows you to cock the trap single handed in one stroke.

It is ideal for enthusiasts and commercial grounds as well as being perfect for corporate events.

Highlights

- ▶ Elevation from horizontal to 35° can be adjusted quickly and easily
- ▶ Performs double and single rise throwing
- ▶ Designed for easy operation with lever cocking
- ▶ Extremely portable
- ▶ Safety as standard with a positive trigger release

Specification

- ▶ Trap weight of 13.5Kg or 22Kg with the optional tripod stand
- ▶ Throws standards, midis and mini targets all from the standard arm without adjustments
- ▶ Four different spring strengths are available:
 - 150 metre throwing distance with red spring for a standard clay
 - 135 metre throwing distance with a black spring for a standard clay (standard spring)
 - 100 metre throwing distance with white spring for a standard clay
 - 80 metre throwing distance with yellow spring for a standard clay
 - 75 metres for double rising targets with the black spring
- ▶ Easily transported and set up
- ▶ Bearings protected from the elements with two mechanical seals

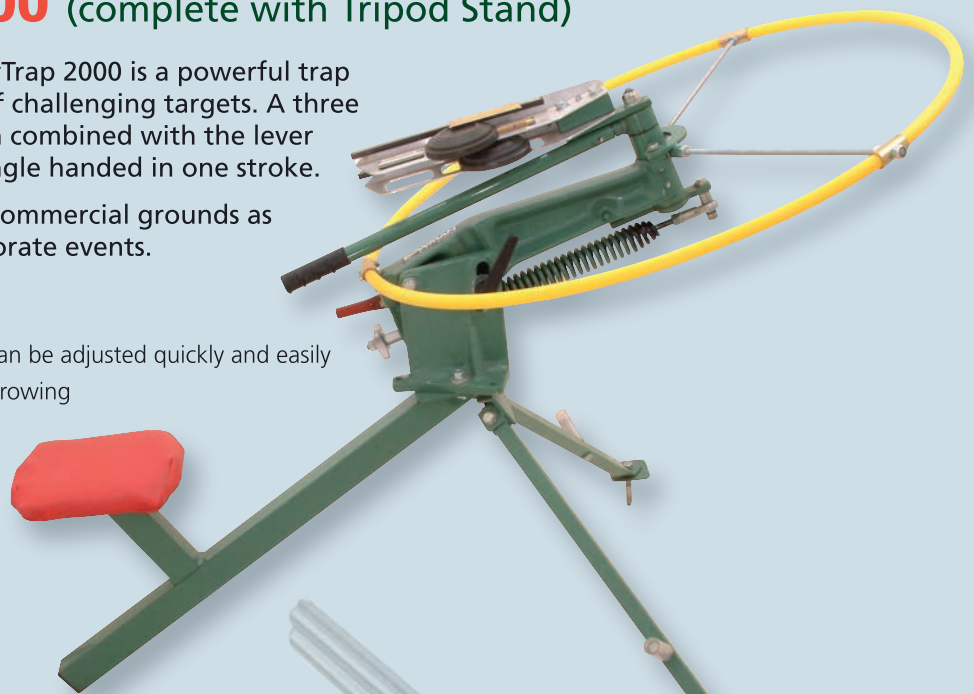

SuperTrap Junior (complete with Sled Stand No 1)

A compact trap offering our usual superb performance, the SuperTrap Junior is ideal for beginners and is a perfect addition to a shooting grounds trap range.

Highlights

- ▶ Easy to operate, can be quickly positioned to give many types of target
- ▶ Truly portable, weighing only 7Kg with its sled stand (Sled Stand No 1)
- ▶ Throws a standard clay 50 metres plus
- ▶ Crossing or quartering targets can be given added zip with the use of 90mm targets
- ▶ Safety as standard with a locking mechanism just off centre



Specification

- ▶ Trap weight of 7Kg with its sled stand
- ▶ Throws standards, midis and mini targets
- ▶ Standard clay distance of 50 metres plus
- ▶ Easily transported and set up
- ▶ Trap fitted with grease nipples for lubrication

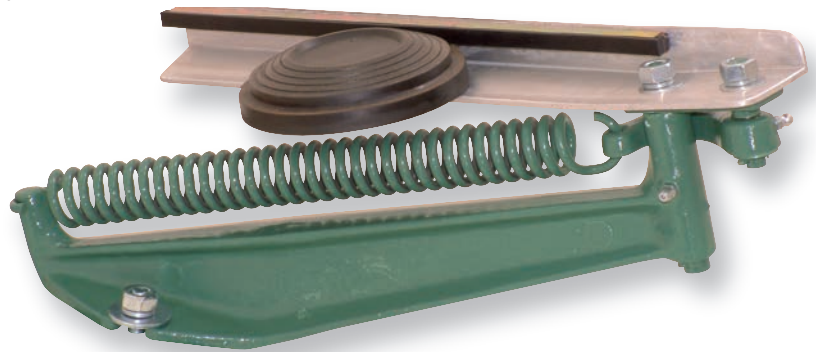

SuperTrap No 2 (complete with Sled Stand No 2)

Similar to the Junior model above but larger & with a double arm like the No.3.

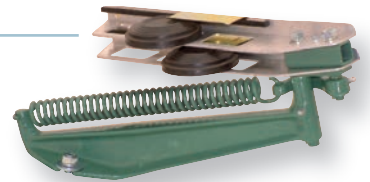

SuperTrap No 3 (complete with Sled Stand No 2)

Everything you could want from a manual trap is provided with the SuperTrap No 3. Our best selling manual trap provides a huge variety of targets including single and double rising targets. It is so flexible you're sure to have lots of fun as well as a potentially challenging shooting experience. This trap is ideal for enthusiasts as well as large and small grounds.

Highlights

- ▶ Rapid adjustment the elevation with our unique lever locking adjustment
- ▶ Elevation to any angle for throws from slow dropping pigeons to bullet fast springing teals (with a wedge plate)
- ▶ Can throw three clay sizes; standards, midis and minis
- ▶ Can use our complete range of hook type springs
- ▶ Safety as standard with positive locking



Best Seller

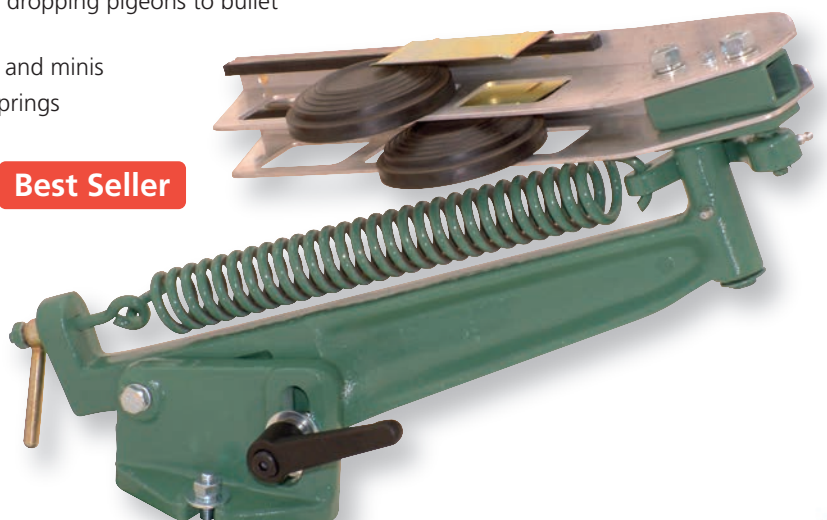

Note: Supertrap models vary in actual size - The main casting of the Junior is approx 14"/35.5cm compared to the No.2 at 18"/45.7cm and the No.3 at 19"/48.3cm.

Bolting Rabbit (with Fur & Feather option)

Designed specifically for bowling a rabbit, this trap has been developed with safety and performance as the key priorities.

This trap is an ideal addition for large and small grounds as it adds variety to the shooting experience. Adding the fur and feather accessory kit means the opportunity of elevated clays from the same trap.

Highlights

- ▶ Seated stand and easy cocking makes it a trap that can be used comfortably all day
- ▶ Bowls a rabbit perfectly
- ▶ Throws a standard clay 50 metres with the Fur and Feather accessory
- ▶ Safety as standard with a trigger release, spring safety guard and a rubber buffer assembly to prevent the arm going past vertical
- ▶ Price includes seated frame

Specification

- ▶ Trap weight of 25Kg with its seat
- ▶ Throws manual or auto rabbit clay
- ▶ Padded seat backrest
- ▶ Ground spikes for stability



Accessories for manual traps

We've designed our traps and accessories so that items can be interchangeable and can be used on various traps.



Sled Stand No 1 - (1) comes as standard with the SuperTrap Junior.

Sled Stand No 2 - (2) comes as standard with SuperTrap No 2 and No 3.

Tripod Stand - (3) comes as standard with the SuperTrap 2000 and can be added to SuperTrap No 2 and No 3. This stand features fold up legs and a removable seat.

Wedge Plate - (4) suitable for the SuperTrap No 2 and No 3 and the SuperTrap 2000. It is fitted between the trap and the stand to give an extra 22° fixed elevation for a springing teal target.

Elevating Base Plate - (5) suitable for the SuperTrap Junior, the plate is fitted between the trap and stand to give up to 45° elevation. A teal clip will be required.

Gun Rack - (6) holds six guns. The all steel construction with rubber inserts to cushion stocks and barrels means this rack is designed to perform and built to last. It can be used on hard or soft surfaces and packs flat for easy transportation and storage.

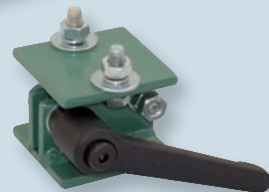
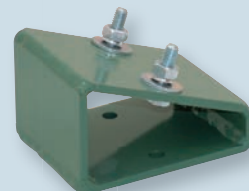
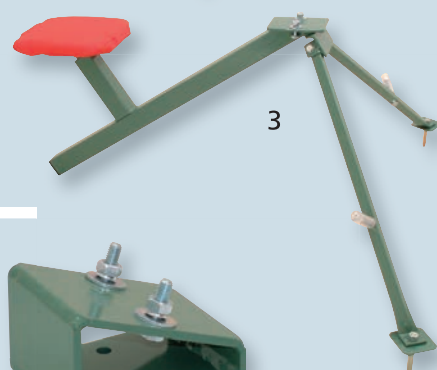
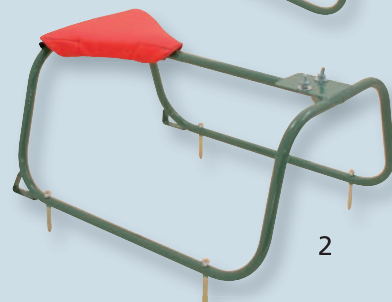

Spare Parts for manual traps

Teal Clip - (7) these are available in three sizes of 7.6cm, 10.8cm and 15cm. All elevating traps are fitted with teal clips as standard.

Rubber and rail - (8)

Types A and B are made from hard wearing black neoprene strips - type A is for single rise traps, type B is for double rise traps.

Type C is for automatic traps and uses orange P.P.E. strips.

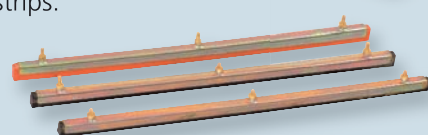
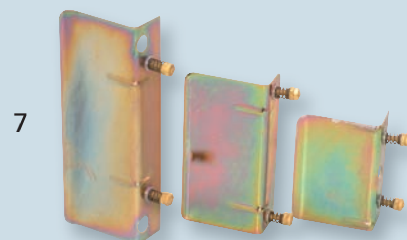

Super Simulator Game Trailer

The ultimate trap experience - choose your choice of any three automatic traps to operate by radio remote control.

Highlights

- ▶ Operate your choice of any three automatic traps by radio remote control
- ▶ Quick-release aerial mast for transportation
- ▶ Traps can be easily unbolted and used elsewhere for use throughout the year
- ▶ Batteries can be charged in situ
- ▶ Road legal trailer
- ▶ 3 year warranty
- ▶ Solid, rugged and reliable
- ▶ Trap covers available (recommended)



NEW



Nothing else comes close!

Above photo shows the Game Trailer fitted with:

1. Supermatch Eight (Midi) on Automatic Tilt Base
2. Supermatch Eight (Midi) on ABT Base
3. Supermatch Sporting Double (Midi) on ABT Base

BOWMAN

SPECIALISTS IN CLAY PIGEON TRAPS

Designed to perform,
engineered to last

W J Bowman (1984) Ltd
High Street, East Markham,
Newark, Nottinghamshire, NG22 0RE

Tel: 01777 870243 Fax: 01777 870924

Email: sales@bowmantraps.co.uk Web: www.bowmantraps.co.uk

