

ABACUS

Bathrooms Answered

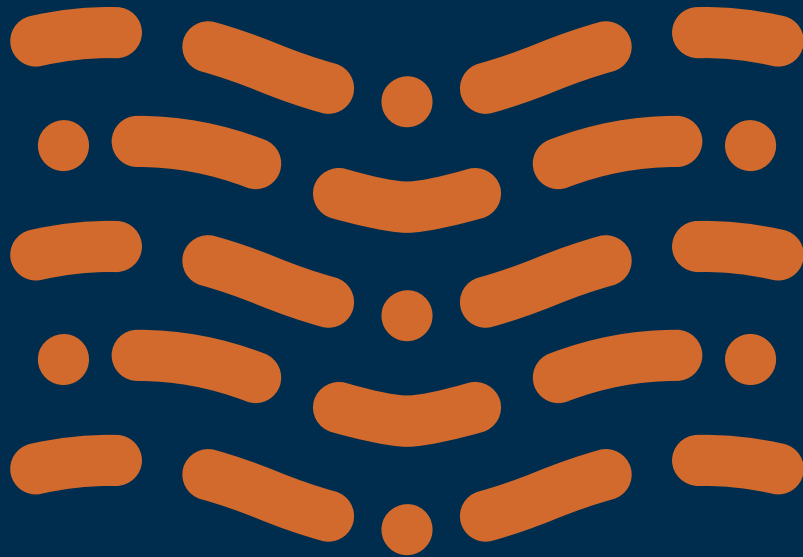

2018







ABACUS

Bathrooms Answered







About us...

Established in 1989, Abacus is one of the UK's leading manufacturers and distributors of bathroom and wetroom products.

OUR PRODUCTS

Developed alongside some of the world's most prestigious bathroom brands, our comprehensive product range offers stunning contemporary designs, twinned with market-leading guarantees, which will suit all bathroom needs.

OUR PHILOSOPHY

Our approach to completing a bathroom through both product and design innovations makes us one of the only manufacturers and specialist distributors to supply every product required in a bathroom from conception to completion.

Abacus
Abacus House
Jubilee Court
Copgrove
Harrogate
HG3 3TB UK

Tel: +44 (0) 345 850 50 40
Fax: +44 (0) 345 850 50 30

Sales:
sales@abacus-bathrooms.co.uk

General enquiries:
enquiries@abacus-bathrooms.co.uk

Because beauty is so
much more than skin deep...

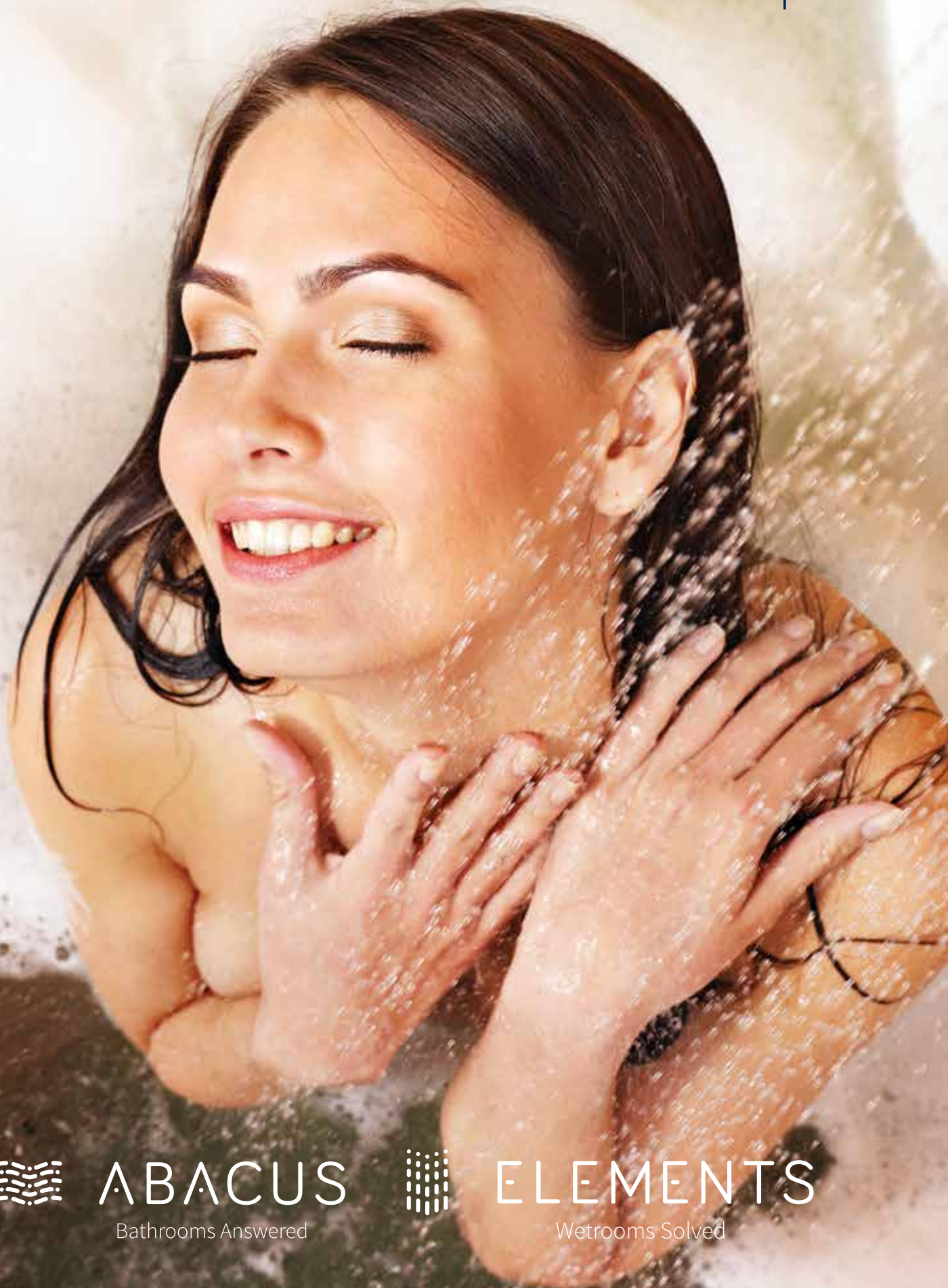

ABACUS

Bathrooms Answered



ELEMENTS

Wetrooms Solved



...the clever bit
is what you don't see...

...as well as the bit you do...

Abacus don't just sell bathrooms, we've developed waterproofing and insulation innovations, backed with outstanding build quality 'behind the tiles' to ensure your investment stands the test of time.



World-class German-manufactured designer sanitaryware

•

The UK's most comprehensive wetroom and bathroom waterproofing specialists

•

Stunning furniture design and accessories

•

Manufacturing innovation throughout the product range

•

Industry-leading brassware and shower technology



All backed with a 15 year guarantee*

*Does not include electrical components and wear & tear items. See terms and conditions.

Go to our YouTube channel for invaluable help and expertise, presented by top 'skill builder', Roger Bisby

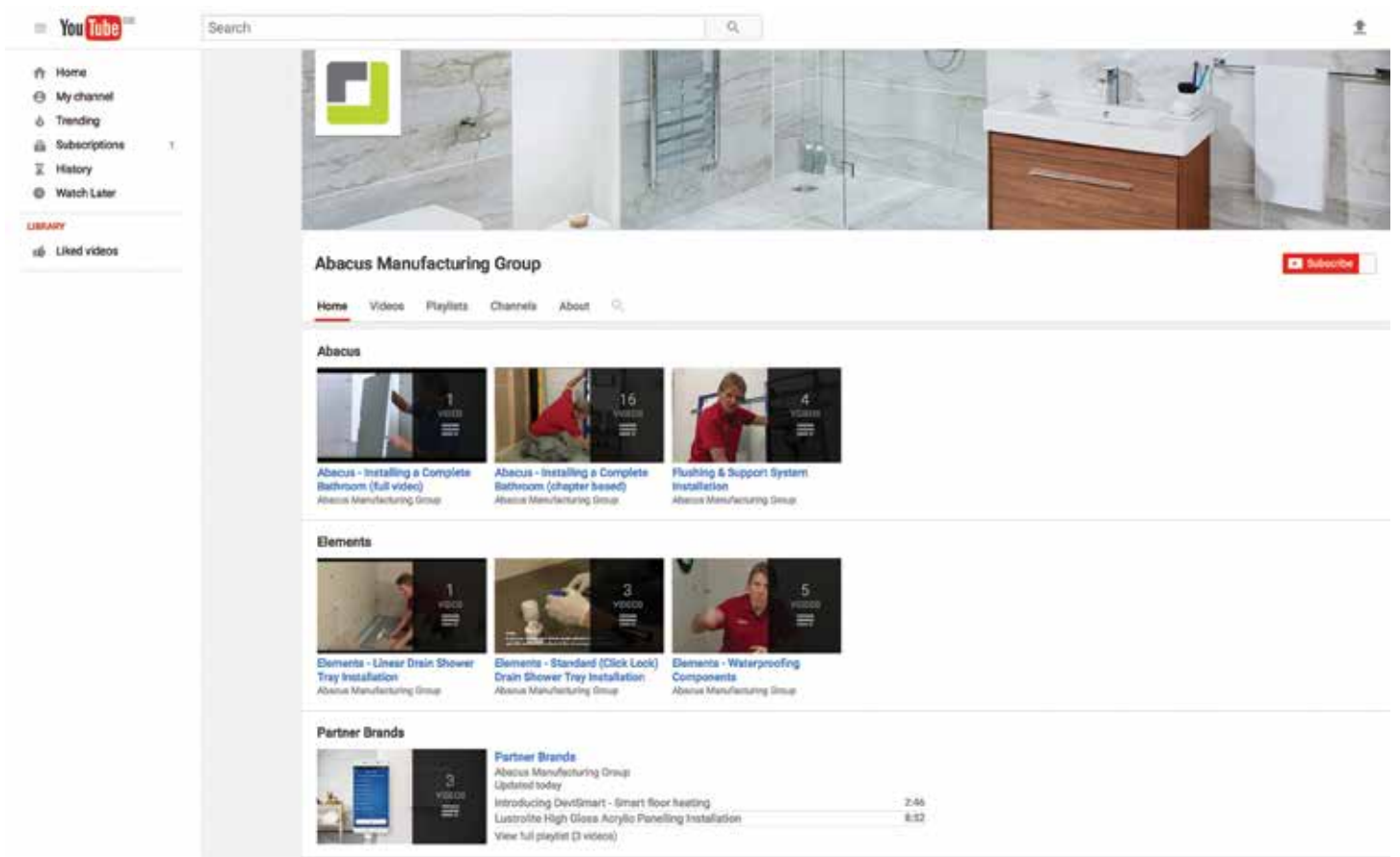

Abacus have teamed up with Roger Bisby to produce a series of best-practice videos enabling our customers to achieve the highest level of build quality in their bathroom installations when using the innovative Abacus product range.

Roger Bisby entered the building industry as an apprentice plumber. He went on to train as a college lecturer and has also run his own building company for nearly 30 years. He specialises in trouble shooting and has a dogged determination to get to the bottom of difficult problems. He put these talents to good use as the regular expert on London Broadcasting Company's (LBC) Fix It Phone in which remained one of their most popular shows throughout its 15 year run.

His television work includes appearances as the resident expert on The Terrace (BBC) Watchdog Home Improvement Series (BBC) Rogue Traders (BBC) and House of Horrors (ITV). He currently works for trade publications including Professional Builder, Professional Electrician, Professional Heating and Plumbing Installer, and Professional Housebuilder and Property Developer.

Examples of our installation videos include:



- how to fit a complete Abacus bathroom with wall-mounted sanitaryware

(video length: 1 hour)



- installing a professional wetroom

(video length: 13 mins)



- installing a wall-mounted WC

(video length: 11 mins)



- waterproofing a bathroom prior to tiling

(video length: 10 mins)

...and many more useful videos.

Subscribe to our YouTube channel to get the latest updates and new videos as soon as they're uploaded.

Search for Abacus Manufacturing Group – and get the best tips, hints and advice for all aspects of your bathroom or wetroom installation.



Contents

Sanitaryware & Furniture	14
Taps & Brassware	62
Showers & Shower Kits	82
Baths & Bath Screens	115
Towel Warmers & Radiators	131
Flushing & Support Systems	176
Elements Wetrooms	194
Designer Bathroom Tiles	280
Mirrors & Cabinets	322
Bathroom Accessories	330
Partner Brands	338

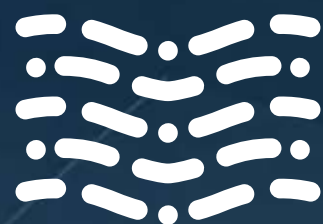



Sanitaryware & Furniture

D-STYLE

SIMPLE

PURE

HANDS & FACES





D-Style Range

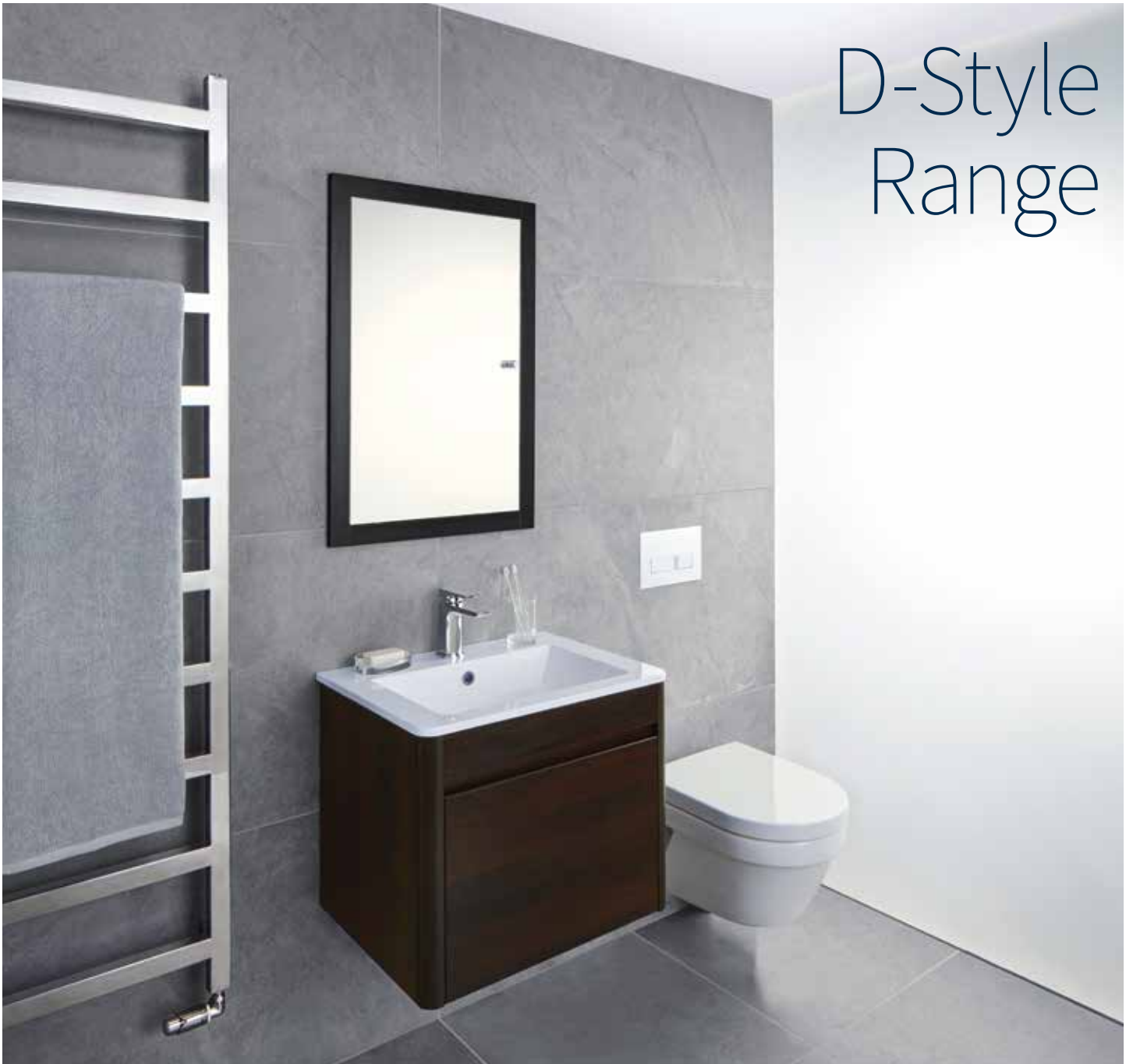

D-STYLE BASIN & VANITY



D-Style solid surface basins – protected by Evermite Protective Coating

Completely safe for users and environmentally friendly.

Evermite is a polymer-based material, which makes cast marble products more durable and resistant than composite products covered with standard gelcoats. A unique formula of components builds a protective barrier, thus minimizing the risk of use-related defects.



D-STYLE 50cm & 60cm BASIN & VANITY UNIT

- Under-basin furniture
- Designed for D-Style 50cm & 60cm basin
- Single drawer
- 50cm unit - 498(w) x 480(h) x 418(d) mm
- 60cm unit - 598(w) x 480(h) x 450(d) mm

Please note:
Does not include tap

Suggested trap for pre-wall installation - pg 388



Optional internal drawer



50cm internal drawer: FNAC-20-9050 £109.00
60cm internal drawer: FNAC-20-9060 £119.00



White

50cm



UNIT: FNUB-20-1050 £399.00

BASIN VBSW-20-0050 £189.00

TOTAL **£578.00**

Beige

50cm



UNIT: FNUB-20-1250 £399.00

BASIN VBSW-20-0050 £189.00

TOTAL **£578.00**

Nilo

50cm



UNIT: FNUB-20-5250 £379.00

BASIN VBSW-20-0050 £189.00

TOTAL **£558.00**

Walnut

50cm



UNIT: FNUB-20-5450 £379.00

BASIN VBSW-20-0050 £189.00

TOTAL **£558.00**

Wenge

50cm



UNIT: FNUB-20-5650 £379.00

BASIN VBSW-20-0050 £189.00

TOTAL **£558.00**

60cm



UNIT: FNUB-20-1060 £459.00

BASIN VBSW-20-0060 £198.00

TOTAL **£647.00**

60cm



UNIT: FNUB-20-1260 £459.00

BASIN VBSW-20-0060 £198.00

TOTAL **£647.00**

60cm



UNIT: FNUB-20-5260 £399.00

BASIN VBSW-20-0060 £198.00

TOTAL **£597.00**

60cm



UNIT: FNUB-20-5460 £399.00

BASIN VBSW-20-0060 £198.00

TOTAL **£597.00**

60cm



UNIT: FNUB-20-5660 £399.00

BASIN VBSW-20-0060 £198.00

TOTAL **£597.00**

- 40% MORE RESISTANT TO ABRASION
- 20% MORE RESISTANT TO SCRATCHING
- 50% MORE RESISTANT TO LUSTRE FADING DUE TO CLEANING



D-STYLE COMPACT HANDWASH BASIN

(VBSW-20-3225)

- Size: 530 x 250mm
- White

£118.00



D-STYLE COMPACT HANDWASH BASIN

(VBSW-20-3242)

- Size: 460 x 355mm
- White

£117.00



NOTE: for semi-pedestal use COMPACT SEMI-PEDESTAL (code VBSW-20-6010)

D-STYLE COMPACT HANDWASH BASIN

(VBSW-20-3250)

- Size: 505 x 400mm
- White

£120.00



NOTE: for semi-pedestal use COMPACT SEMI-PEDESTAL (code VBSW-20-6010)

D-STYLE SEMI-RECESSED BASIN

(VBSW-20-4055)

- Size: 550 x 460mm
- White

£249.00



BASIN ACCESSORIES



FOR BASIN
WALL-MOUNTING
FRAMES
see page 188



BASIN FIXING BOLT SET
ANFX-20-0005
£7.80



ROUND BOTTLE TRAP
VETW-05-0510
£59.50



SQUARE BOTTLE TRAP
VETW-05-0515
£83.00

SUGGESTED TAPS



ISO



XS



KI



EDITION

D-STYLE STANDARD 55cm BASIN

(VBSW-20-3055)

- Size: 550 x 460mm
- White

£119.00

NOTE: for full pedestal use VBSW-20-5505
for semi-pedestal use VBSW-20-6005



D-STYLE STANDARD 60cm BASIN

(VBSW-20-3060)

- Size: 600 x 480mm
- White

£129.00

NOTE: for full pedestal use VBSW-20-5505
for semi-pedestal use VBSW-20-6005



D-STYLE PEDESTAL

(VBSW-20-5505)

- White

£69.00



D-STYLE SEMI-PEDESTAL

(VBSW-20-6005)

- White

£129.00



D-STYLE COMPACT SEMI-PEDESTAL

(VBSW-20-6010)

- White

£129.00



D-STYLE WALL-HUNG WC

(VBSW-20-0505)

- Size: 370 x 530mm
- Wall-hung
- White
- Fixing bolts not included

£199.00

Seat options: VBSW-20-7505, VBSW-20-7515 - see page 23



D-STYLE BACK-TO-WALL WC

(VBSW-20-1005)

- Size: 370 x 560mm
- Floor-standing
- White

£199.00

Seat options: VBSW-20-7505, VBSW-20-7515 - see page 23



D-STYLE LITE CLOSE-COUPLED WC & CISTERN

(VBSW-20-1510)

- Size: 360 x 670mm
- Floor-standing
- White
- Back or side outlet

£129.00

D-STYLE LITE CLOSE-COUPLED CISTERN (VBSW-20-2010)

£129.00

Seat options: VBSW-20-7505 - see page 23



D-STYLE CLOSE-COUPLED WC

(VBSW-20-1505)

- Size: 370 x 690mm
- Floor-standing
- White
- Back or side outlet

£219.00

D-STYLE CLOSE-COUPLED CISTERN (VBSW-20-2005)

£199.00

Seat options: VBSW-20-7505, VBSW-20-7515 - see page 23



D-STYLE WALL-HUNG COMPACT WC

(VBSW-20-0510)

- Size: 355 x 480mm
- Wall-hung
- White
- Fixing bolts not included

£259.00

Seat options: VBSW-20-7515 - see page 23



D-STYLE SOFT CLOSE SEAT

(VBSW-20-7505)

- Soft close, quick release
- White

£79.00



D-STYLE SLIMLINE SEAT

(VBSW-20-7515)

- Soft close, quick release
- White

£99.00



D-STYLE COMPACT SEAT

(VBSW-20-7510)

- White

£199.00



D-STYLE WALL-HUNG BIDET

(VBSW-20-6505)

- Size: 370 x 530mm
- Wall-hung
- One tap hole
- White
- Fixing bolts not included

£199.00



D-STYLE Collection

Furniture



D-STYLE 50cm VANITY UNIT

FNUB-20-1050 White
 FNUB-20-1250 Beige
 FNUB-20-5250 Nilo
 FNUB-20-5450 Walnut
 FNUB-20-5650 Wenge

498(w) x 480(h) x 418(d) mm
 for use with basin VBSW-20-0050



D-STYLE 60cm VANITY UNIT

FNUB-20-1060 White
 FNUB-20-1260 Beige
 FNUB-20-5260 Nilo
 FNUB-20-5460 Walnut
 FNUB-20-5660 Wenge

598(w) x 480(h) x 450(d) mm
 for use with basin VBSW-20-0060

Furniture colour key

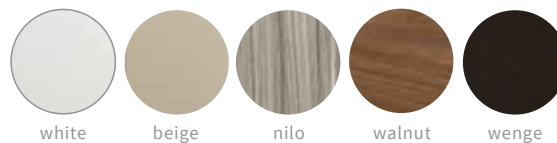

Basin key

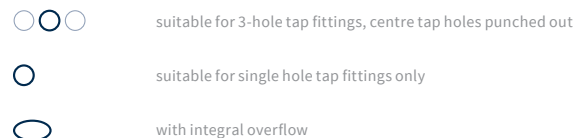

D-STYLE Collection

Basins



D-STYLE COMPACT HANDWASH BASIN

VBSW-20-3225 530 x 250mm



D-STYLE COMPACT HANDWASH BASIN

VBSW-20-3242 460 x 355mm



D-STYLE COMPACT HANDWASH BASIN

VBSW-20-3250 505 x 400mm



D-STYLE SEMI-RECESSED BASIN

VBSW-20-4055 550 x 460mm



D-STYLE STANDARD 55cm BASIN

VBSW-20-3055 550 x 460mm



D-STYLE STANDARD 60cm BASIN

VBSW-20-3060 600 x 480mm



D-STYLE FULL PEDESTAL

VBSW-20-5505



D-STYLE SEMI-PEDESTAL

VBSW-20-6005

D-STYLE Collection

WCs



D-STYLE WALL-HUNG WC

VBSW-20-0505 370 x 530mm



D-STYLE BACK-TO-WALL WC

VBSW-20-1005 370 x 560mm



D-STYLE LITE CLOSE-COUPLED WC

VBSW-20-1510 Pan 360 x 670 mm
 VBSW-20-2010 Cistern 370 x 160mm



D-STYLE CLOSE-COUPLED WC

VBSW-20-1505 Pan 370 x 690mm
 VBSW-20-2005 Cistern 370 x 160mm



D-STYLE WALL-HUNG COMPACT WC

VBSW-20-0510 355 x 480mm



D-STYLE SOFT CLOSE SEAT

VBSW-20-7505



D-STYLE SLIMLINE SEAT

VBSW-35-7515



D-STYLE COMPACT SEAT

VBSW-20-7510



D-STYLE WALL-HUNG BIDET

VBSW-20-6505 370 x 530mm

Simple Range





SIMPLE CLOAKROOM 45cm BASIN VANITY UNIT

- Under-basin furniture
- Designed for Simple cloakroom 45cm basin
- Reversible left hand / right hand door hinge
- Unit dimensions - 360(w) x 440(h) x 300(d) mm
- Overall dimensions with basin - 450(w) x 540(h) x 350(d) mm

Please note:
Does not include tap. For basin details see page 31.

Suggested trap for pre-wall installation - pg 388



Suitable for all Simple Vanity Units



White



UNIT:
FNUB-22-1003 £199.00
BASIN
VBSW-35-3245 £129.00
TOTAL **£328.00**

Anthracite



UNIT:
FNUB-22-1403 £239.00
BASIN
VBSW-35-3245 £129.00
TOTAL **£368.00**

Terra Matt



UNIT:
FNUB-22-1803 £239.00
BASIN
VBSW-35-3245 £129.00
TOTAL **£368.00**

Walnut



UNIT:
FNUB-22-5403 £199.00
BASIN
VBSW-35-3245 £129.00
TOTAL **£328.00**

Wenge



UNIT:
FNUB-22-5603 £199.00
BASIN
VBSW-35-3245 £129.00
TOTAL **£328.00**

Bleached Oak



UNIT:
FNUB-22-5803 £199.00
BASIN
VBSW-35-3245 £129.00
TOTAL **£328.00**



SIMPLE 55cm BASIN VANITY UNIT

- Under-basin furniture
- Designed for Simple 55cm basin
- Single drawer
- Unit dimensions - 460(w) x 450(h) x 370(d) mm
- Overall dimensions with basin - 550(w) x 550(h) x 430(d) mm

Please note:
Does not include tap. For basin details see page 32.

Optional internal drawer



55cm internal drawer:
FNAC-22-9004 £119.00



White



UNIT:
FNUB-22-1004 £399.00
BASIN
VBSW-35-3055 £139.00
TOTAL **£538.00**

Anthracite



UNIT:
FNUB-22-1404 £449.00
BASIN
VBSW-35-3055 £139.00
TOTAL **£588.00**

Terra Matt



UNIT:
FNUB-22-1804 £449.00
BASIN
VBSW-35-3055 £139.00
TOTAL **£588.00**

Walnut



UNIT:
FNUB-22-5404 £399.00
BASIN
VBSW-35-3055 £139.00
TOTAL **£538.00**

Wenge



UNIT:
FNUB-22-5604 £399.00
BASIN
VBSW-35-3055 £139.00
TOTAL **£538.00**

Bleached Oak



UNIT:
FNUB-22-5804 £399.00
BASIN
VBSW-35-3055 £139.00
TOTAL **£538.00**



SIMPLE 60cm BASIN VANITY UNIT

- Under-basin furniture
- Designed for Simple 60cm basin
- Single drawer
- Unit dimensions - 510(w) x 450(h) x 415(d) mm
- Overall dimensions with basin - 600(w) x 550(h) x 470(d) mm

Please note:
Does not include tap. For basin details see page 32.

Optional internal drawer



60cm internal drawer:
FNAC-22-9005 £129.00



White



UNIT:
FNUB-22-1005 £489.00
BASIN
VBSW-35-3060 £179.00
TOTAL **£668.00**

Anthracite



UNIT:
FNUB-22-1405 £569.00
BASIN
VBSW-35-3060 £179.00
TOTAL **£748.00**

Terra Matt



UNIT:
FNUB-22-1805 £569.00
BASIN
VBSW-35-3060 £179.00
TOTAL **£748.00**

Walnut



UNIT:
FNUB-22-5405 £489.00
BASIN
VBSW-35-3060 £179.00
TOTAL **£668.00**

Wenge



UNIT:
FNUB-22-5605 £489.00
BASIN
VBSW-35-3060 £179.00
TOTAL **£668.00**

Bleached Oak



UNIT:
FNUB-22-5805 £489.00
BASIN
VBSW-35-3060 £179.00
TOTAL **£668.00**



SIMPLE 80cm BASIN VANITY UNIT

- Under-basin furniture
- Designed for Simple 80cm basin
- Single drawer
- Unit dimensions - 760(w) x 450(h) x 460(d) mm
- Overall dimensions with basin - 800(w) x 550(h) x 485(d) mm

Please note:
Does not include tap. For basin details see page 32.

Optional internal drawer



80cm internal drawer:
FNAC-22-9007 £139.00



White



UNIT:
FNUB-22-1007 £649.00
BASIN
VBSW-35-3080 £450.00
TOTAL **£1,099.00**

Anthracite



UNIT:
FNUB-22-1407 £699.00
BASIN
VBSW-35-3080 £450.00
TOTAL **£1,149.00**

Terra Matt



UNIT:
FNUB-22-1807 £699.00
BASIN
VBSW-35-3080 £450.00
TOTAL **£1,149.00**

Walnut



UNIT:
FNUB-22-5407 £649.00
BASIN
VBSW-35-3080 £450.00
TOTAL **£1,099.00**

Wenge



UNIT:
FNUB-22-5607 £649.00
BASIN
VBSW-35-3080 £450.00
TOTAL **£1,099.00**

Bleached Oak



UNIT:
FNUB-22-5807 £649.00
BASIN
VBSW-35-3080 £450.00
TOTAL **£1,099.00**



SIMPLE 130cm DOUBLE BASIN VANITY UNIT

- Under-basin furniture
- Designed for Simple 130cm basin
- Double drawer
- Unit dimensions - 1250(w) x 450(h) x 460(d) mm
- Overall dimensions with basin - 1300(w) x 550(h) x 485(d) mm

Please note:
Does not include tap. For basin details see page 33.

Optional internal drawer



130cm internal drawer:
FNAC-22-9012 £139.00
EACH (x 2 REQUIRED)



White



UNIT:
FNUB-22-1012 £899.00
BASIN
VBSW-35-3013 £799.00
TOTAL **£1,698.00**

Anthracite



UNIT:
FNUB-22-1412 £999.00
BASIN
VBSW-35-3013 £799.00
TOTAL **£1,798.00**

Terra Matt



UNIT:
FNUB-22-1812 £999.00
BASIN
VBSW-35-3013 £799.00
TOTAL **£1,798.00**

Walnut



UNIT:
FNUB-22-5412 £899.00
BASIN
VBSW-35-3013 £799.00
TOTAL **£1,698.00**

Wenge



UNIT:
FNUB-22-5612 £899.00
BASIN
VBSW-35-3013 £799.00
TOTAL **£1,698.00**

Bleached Oak



UNIT:
FNUB-22-5812 £899.00
BASIN
VBSW-35-3013 £799.00
TOTAL **£1,698.00**



Simple Basins

SIMPLE 45cm HANDWASH BASIN

(VBSW-35-3245)

- Size: 450 x 350mm
- With overflow
- White

£129.00



SUGGESTED TAPS



LOGIK
MINI MONO



EDITION
MINI MONO



PLAN
MINI MONO

SIMPLE 50cm COMPACT BASIN

(VBSW-35-3250)

- Size: 500 x 390mm
- With overflow

£160.00

NOTE: for semi-pedestal use COMPACT SEMI-PEDESTAL (code VBSW-35-6010)



SIMPLE 55cm BASIN

(VBSW-35-3055)

- Size: 550 x 430mm
- With overflow
- Matching furniture available

£139.00

NOTE: for full pedestal use VBSW-35-5505
for semi-pedestal use VBSW-35-6005



SIMPLE 60cm BASIN

(VBSW-35-3060)

- Size: 600 x 470mm
- With overflow
- Matching furniture available

£179.00

NOTE: for full pedestal use VBSW-35-5505
for semi-pedestal use VBSW-35-6005



SIMPLE 80cm BASIN

(VBSW-35-3080)

- Size: 800 x 485mm
- With overflow
- Matching furniture available

£450.00

NOTE: for full pedestal use VBSW-35-5505
for semi-pedestal use VBSW-35-6005



SIMPLE 130cm DOUBLE BASIN

(VBSW-35-3013)

- Size: 1300 x 485mm
- One tap hole per basin
- With overflows
- White



£799.00

SIMPLE FULL PEDESTAL

(VBSW-35-5505)

- White

£89.00



SIMPLE SEMI-PEDESTALS

- White

COMPACT SEMI-PEDESTAL VBSW-35-6010

£99.00

STANDARD SEMI-PEDESTAL VBSW-35-6005

£99.00



BASIN ACCESSORIES



FOR BASIN
WALL-MOUNTING
FRAMES
see page 188



BASIN FIXING BOLT SET
ANFX-20-0005
£7.80



ROUND BOTTLE TRAP
VETW-05-0510
£59.50



SQUARE BOTTLE TRAP
VETW-05-0515
£83.00

SUGGESTED TAPS



LOGIK



KI



EDITION



ALA-S



PLAN



ISO



XS



SIMPLE WALL-HUNG WC

(VBSW-35-0505)

- Size: 375 x 565mm
- Wall-hung
- White
- Concealed fixings

£279.00

Seat options: VBSW-35-7505, VBSW-35-7515 - see page 37

**SIMPLE BACK-TO-WALL WC**

(VBSW-35-1005)

- Size: 370 x 560mm
- Floor-mounted
- White

£289.00

Seat options: VBSW-35-7505, VBSW-35-7515 - see page 37

**SIMPLE CLOSE-COUPLED WC & CISTERN**

(VBSW-35-9005)

- Size: 370 x 670mm
- Close-coupled design
- White
- Back or side outlet

£498.00

SIMPLE CLOSE-COUPLED PAN (VBSW-35-1505)

SIMPLE CLOSE-COUPLED CISTERN (VBSW-35-2005)

Seat options: VBSW-35-7505, VBSW-35-7515 - see page 37

Price for pan and cistern only,
does not include seat**SIMPLE FLAT-TO-WALL CLOSE-COUPLED WC & CISTERN**

(VBSW-35-9010)

- Size: 370 x 670mm
- Close-coupled design
- Flat-to-wall design
- White

£578.00

SIMPLE CLOSE-COUPLED PAN (VBSW-35-1510)

SIMPLE CLOSE-COUPLED CISTERN (VBSW-35-2005)

Seat options: VBSW-35-7505, VBSW-35-7515 - see page 37

Price for pan and cistern only,
does not include seat

SIMPLE COMPACT WALL-HUNG WC

(VBSW-35-0510)

- Size: 355 x 480mm
- Compact
- Wall-hung
- White

£359.00

Seat options: VBSW-35-7510 - see page 37



SIMPLE WALL-HUNG BIDET

(VBSW-35-6505)

- Size: 375 x 560mm
- Wall-hung
- One tap hole
- White

£359.00



SIMPLE SOFT CLOSE SEAT

(VBSW-35-7505)

- Soft close, quick release
- White

£79.00



SIMPLE SLIMLINE SEAT

(VBSW-35-7515)

- Soft close, quick release
- White

£99.00



SIMPLE COMPACT SEAT

(VBSW-35-7510)

- White

£199.00



Simple Collection

Basins



SIMPLE 45cm HANDWASH BASIN
VBSW-35-3245 450 x 350mm
○○○
Suitable for vanity units
FNUB-22-1003 FNUB-22-5403
FNUB-22-1403 FNUB-22-5603
FNUB-22-1803 FNUB-22-5803



SIMPLE 50cm COMPACT BASIN
VBSW-35-3250 500 x 390mm
○○○
Suitable for vanity units
FNUB-22-1004 FNUB-22-5404
FNUB-22-1404 FNUB-22-5604
FNUB-22-1804 FNUB-22-5804



SIMPLE 55cm BASIN
VBSW-35-3055 550 x 430mm
○○○○○
Suitable for vanity units
FNUB-22-1004 FNUB-22-5404
FNUB-22-1404 FNUB-22-5604
FNUB-22-1804 FNUB-22-5804



SIMPLE 60cm BASIN
VBSW-35-3060 600 x 470mm
○○○○○
Suitable for vanity units
FNUB-22-1005 FNUB-22-5405
FNUB-22-1405 FNUB-22-5605
FNUB-22-1805 FNUB-22-5805



SIMPLE 80cm BASIN
VBSW-35-3080 800 x 485mm
○○○○○
Suitable for vanity units
FNUB-22-1007 FNUB-22-5407
FNUB-22-1407 FNUB-22-5607
FNUB-22-1807 FNUB-22-5807



SIMPLE 130cm DOUBLE BASIN
VBSW-35-3013 1300 x 485mm
○○○○○
Suitable for vanity units
FNUB-22-1012 FNUB-22-5412
FNUB-22-1412 FNUB-22-5612
FNUB-22-1812 FNUB-22-5812



SIMPLE FULL PEDESTAL
VBSW-35-5505



SIMPLE COMPACT SEMI-PEDESTAL
VBSW-35-6010

SIMPLE SEMI-PEDESTAL
VBSW-35-6005

Simple Collection

Furniture



SIMPLE 45cm CLOAKROOM VANITY UNIT
FNUB-22-1003 White
FNUB-22-1403 Anthracite
FNUB-22-1803 Terra Matt
FNUB-22-5403 Walnut
FNUB-22-5603 Wenge
FNUB-22-5803 Bleached Oak
380(w) x 460(h) x 295(d) mm
Suitable for basin VBSW-35-3245



SIMPLE 55cm VANITY UNIT
FNUB-22-1004 White
FNUB-22-1404 Anthracite
FNUB-22-1804 Terra Matt
FNUB-22-5404 Walnut
FNUB-22-5604 Wenge
FNUB-22-5804 Bleached Oak
460(w) x 450(h) x 370(d) mm
Suitable for basin VBSW-35-3055



SIMPLE 60cm VANITY UNIT
FNUB-22-1005 White
FNUB-22-1405 Anthracite
FNUB-22-1805 Terra Matt
FNUB-22-5405 Walnut
FNUB-22-5605 Wenge
FNUB-22-5805 Bleached Oak
510(w) x 450(h) x 415(d) mm
Suitable for basin VBSW-35-3060



SIMPLE 80cm VANITY UNIT
FNUB-22-1007 White
FNUB-22-1407 Anthracite
FNUB-22-1807 Terra Matt
FNUB-22-5407 Walnut
FNUB-22-5607 Wenge
FNUB-22-5807 Bleached Oak
760(w) x 450(h) x 460(d) mm
Suitable for basin VBSW-35-3080



SIMPLE 130cm DOUBLE VANITY UNIT
FNUB-22-1012 White
FNUB-22-1412 Anthracite
FNUB-22-1812 Terra Matt
FNUB-22-5412 Walnut
FNUB-22-5612 Wenge
FNUB-22-5812 Bleached Oak
1250(w) x 450(h) x 460(d) mm
Suitable for basin VBSW-35-3013



SIMPLE VANITY UNIT DRAWER INSERT OPTION
FNAC-22-9004 for 55cm vanity unit
FNAC-22-9005 for 60cm vanity unit
FNAC-22-9007 for 80cm vanity unit
FNAC-22-9012 x2 for 130cm vanity unit

Basin key

- suitable for 3-hole tap fittings, centre tap holes punched out
- suitable for single hole tap fittings only
- with integral overflow

Simple Collection

WCs



CLOSE-COUPLED WC
VBSW-35-1505 370 x 670mm
 floor-mounted close-coupled
 wc pan with horizontal outlet
VBSW-35-2005 close-coupled cistern with
 side and rear inlet and chrome
 Duo button - dual flush
VBSW-35-7505 soft close, quick release seat



CLOSE-COUPLED FLAT BACK-TO-WALL WC
VBSW-35-1510 370 x 670mm
 floor-mounted close-coupled
 wc pan with horizontal outlet
VBSW-35-2005 close-coupled cistern with
 side and rear inlet and
 chrome Duo button - dual flush
VBSW-35-7505 soft close, quick release seat



WALL-HUNG WC
VBSW-35-0505 375 x 565mm
 wall-mounted wc pan with
 horizontal outlet



COMPACT WALL-HUNG WC
VBSW-35-0510 355 x 480mm
 compact wall-mounted wc
 pan with horizontal outlet



FLOORSTANDING BACK-TO-WALL WC
VBSW-35-1005 370 x 560mm
 floor-standing
 BTW wc pan with
 horizontal outlet



WALL-HUNG BIDET
VBSW-35-6505 375 x 560mm
 wall-mounted
 bidet with one
 tap hole



STANDARD SEAT
VBSW-35-7505 WC seat and cover,
 hinges in stainless
 steel, with soft-
 closing and quick
 release functions,
 suitable for all
 Simple WCs except
 compact wall-hung
 pan
 SOFT CLOSE, QUICK RELEASE



SLIMLINE SEAT
VBSW-35-7515 WC seat and cover, hinges in
 stainless steel, with soft-
 closing and quick release
 functions, suitable for all
 Simple WCs except compact
 wall-hung pan
 SOFT CLOSE, QUICK RELEASE



COMPACT SEAT
VBSW-35-7510 WC seat and cover, hinges
 in stainless steel, with
 soft-closing and quick
 release functions for
 VBSW-35-0510 only
 SOFT CLOSE, QUICK RELEASE

Complementary Furniture



UNI WALL CABINET
FNWU-20-1016 White
FNWU-20-1216 Beige
FNWU-20-5216 Nilo
FNWU-20-5416 Walnut
FNWU-20-5616 Wenge
FNWU-20-5816 Bleached Oak
 300(w) x 1500(h) x 240(d) mm



TRIO RECESSED CABINET
FNRC-03-1003 White
FNRC-03-1203 Beige
FNRC-03-1403 Anthracite
FNRC-03-1803 Terra Matt
FNRC-03-5203 Nilo
FNRC-03-5403 Walnut
FNRC-03-5603 Wenge
FNRC-03-5803 Bleached Oak
 535(w) x 800(h) x 215(d) mm



SHELF
FNSH-70-1018 White
FNSH-70-1218 Beige
FNSH-70-1418 Anthracite
FNSH-70-1818 Terra Matt
FNSH-70-5218 Nilo
FNSH-70-5418 Walnut
FNSH-70-5618 Wenge
FNSH-70-5818 Bleached Oak
 1800(w) x 320(d) mm

Furniture colour key

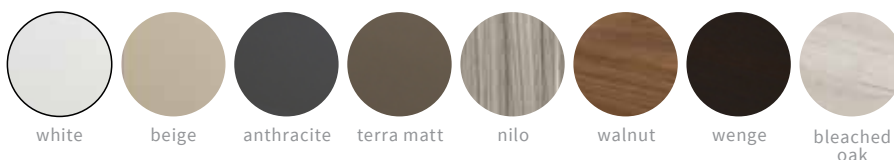



Pure Range



PURE BASIN & VANITY



Pure solid surface basins – protected by Evermite Protective Coating

Completely safe for users and environmentally friendly.

Evermite is a polymer-based material, which makes cast marble products more durable and resistant than composite products covered with standard gelcoats. A unique formula of components builds a protective barrier, thus minimizing the risk of use-related defects.



PURE F 60 BASIN & VANITY UNIT (60cm)

- Slim basin with Evermite coating
- Sleek under-basin furniture
- Single drawer
- Unit dimensions - 560(w) x 450(h) x 450(d) mm
- Overall dimensions with basin - 565(w) x 490(h) x 452(d) mm

Please note:

Does not include tap.



White



UNIT:
FNUB-30-1060 £429.00

BASIN
VBSW-30-0060 £199.00

TOTAL **£628.00**

Beige



UNIT:
FNUB-30-1260 £429.00

BASIN
VBSW-30-0060 £199.00

TOTAL **£628.00**

Anthracite



UNIT:
FNUB-30-1460 £429.00

BASIN
VBSW-30-0060 £199.00

TOTAL **£628.00**

Terra Matt



UNIT:
FNUB-30-1860 £429.00

BASIN
VBSW-30-0060 £199.00

TOTAL **£628.00**

Optional internal drawer



60cm internal drawer:
FNAC-30-9060 £119.00

Nilo



UNIT:
FNUB-30-5260 £399.00

BASIN
VBSW-30-0060 £199.00

TOTAL **£598.00**

Walnut



UNIT:
FNUB-30-5460 £399.00

BASIN
VBSW-30-0060 £199.00

TOTAL **£598.00**

Wenge



UNIT:
FNUB-30-5660 £399.00

BASIN
VBSW-30-0060 £199.00

TOTAL **£598.00**

Bleached Oak



UNIT:
FNUB-30-5860 £399.00

BASIN
VBSW-30-0060 £199.00

TOTAL **£598.00**

Suggested trap for pre-wall installation - pg 388



EVERMITE:

- 40% MORE RESISTANT TO ABRASION
- 20% MORE RESISTANT TO SCRATCHING
- 50% MORE RESISTANT TO LUSTRE FADING DUE TO CLEANING

Pure F 60 basin for use with Pure furniture only.



PURE 80cm BASIN

(VBSW-30-3780)

- Size: 800(w) x 470(d) x 140(h) mm
- Wall-mounted or sit-on
- White

£449.00



PURE 50cm BASIN

(VBSW-30-3750)

- Size: 500(w) x 420(d) x 140(h) mm
- Wall-mounted or sit-on
- White

£299.00



PURE CLOAKROOM BASIN

(VBSW-30-3241)

- Size: 400(w) x 260(d) x 140(h) mm
- Wall-mounted
- White

£189.00



PURE SEMI-RECESSED 55cm BASIN

(VBSW-30-4055)

- Size: 550(w) x 425(d) x 140(h) mm
- One tap hole
- With overflow
- White

£399.00



BASIN ACCESSORIES



FOR BASIN
WALL-MOUNTING
FRAMES
see page 188



BASIN FIXING BOLT SET
ANFX-20-0005
£7.80



ROUND BOTTLE TRAP
VETW-05-0510
£59.50



SQUARE BOTTLE TRAP
VETW-05-0515
£83.00

SUGGESTED TAPS



LOGIK



PLAN



EDITION



ALA-S

PURE WALL-HUNG WC PAN

(VBSW-30-0505)

- Size: 375(w) x 560(d) mm
- Wall-hung
- White

£499.00



PURE WC SEAT & COVER - SOFT CLOSE

(VBSW-30-7505)

- Soft close
- White

£269.00



PURE WALL-HUNG BIDET

(VBSW-30-6505)

- Size: 375(w) x 560(d) mm
- Wall-hung
- One tap hole
- White

£499.00



Pure Collection

Basins



PURE CLOAKROOM BASIN
VBSW-30-3241 400 x 260mm
○○



PURE 50cm BASIN
VBSW-30-3750 500 x 420mm
○○



PURE 55cm SEMI-RECESSED BASIN
VBSW-30-4055 550 x 425mm
○○



PURE 80cm BASIN
VBSW-30-3780 800 x 470mm
○○

Basin key

○○○ suitable for 3-hole tap fittings, centre tap holes punched out

○ suitable for single hole tap fittings only

○ with integral overflow

Pure Collection

Furniture



PURE 60cm BASIN VANITY UNIT

FNUB-30-1060 White
FNUB-30-1260 Beige
FNUB-30-1460 Anthracite
FNUB-30-1860 Terra Matt
FNUB-30-5260 Nilo
FNUB-30-5460 Walnut
FNUB-30-5660 Wenge
FNUB-30-5860 Bleached Oak

560(w) x 450(h) x 450(d) mm
Suitable for basin VBSW-30-0060



PURE VANITY UNIT DRAWER INSERT OPTION
FNAC-30-9060 for 60cm vanity unit

Furniture colour key



white



beige



anthracite



terra matt



nilo



walnut



wenge



bleached oak

Pure Collection

WC



PURE WALL-HUNG WC
VBSW-30-0505 375 x 560mm



PURE WC SEAT & COVER - SOFT CLOSE
VBSW-30-7505



PURE WALL-HUNG BIDET
VBSW-30-6505 375 x 560mm



Complementary Furniture

The ultimate solution for stylish bathroom storage.

Trio Recessed Cabinet – a classic mirrored cupboard and shelving combination designed to be installed in a pre-wall designed bathroom, which utilises all available space in a practical yet fashionable way.

To make the installation of the recessed cabinets as simple as possible, we offer a unique range of installation frames. These frames can be installed whilst building the void wall and create a tile guide to achieve an exact sized opening for the cabinet. This means the installation of the cabinet can be done very easily at the final stage of the bathroom installation.



TRIO RECESSED CABINET INSTALLATION FRAME

(EPCA-05-1505)

The installation frame is not necessarily required to fit the cabinets, but it is recommended to ease installation.

- Galvanised steel installation frame
- For Trio recessed cabinet
- 761(h) x 498(w) mm

£54.00

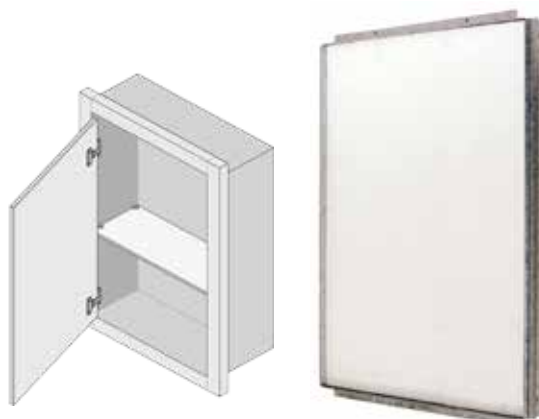

TRIO RECESSED STORAGE CABINET

- Recessed cabinet
- Pre-wall installation
- Left or right hand hinge opening
- 535(w) x 800(h) x 215(d) mm

FROM £399.00



White	Beige	Anthracite	Terra Matt	Nilo	Walnut	Wenge	Bleached Oak
							
FNRC-03-1003 £399.00	FNRC-03-1203 £489.00	FNRC-03-1403 £489.00	FNRC-03-1803 £489.00	FNRC-03-5203 £399.00	FNRC-03-5403 £399.00	FNRC-03-5603 £399.00	FNRC-03-5803 £399.00

Complement your Trio cabinet with a matching shelf

SHELF (1800 x 320mm)

- Shelves can be cut to size, length and depth

FROM £199.00



White 	Beige 	Anthracite 	Terra Matt 
FNSH-70-1018 £199.00	FNSH-70-1218 £249.00	FNSH-70-1418 £249.00	FNSH-70-1818 £249.00
Nilo 	Walnut 	Wenge 	Bleached Oak 
FNSH-70-5218 £199.00	FNSH-70-5418 £199.00	FNSH-70-5618 £199.00	FNSH-70-5818 £199.00

All prices inclusive of VAT



UNI WALL STORAGE CABINET

- Uni wall storage cabinet
- Left or right hand opening
- 300(w) x 1500(h) x 240(d) mm

FROM £449.00



White



FNWU-20-1016
£449.00

Beige



FNWU-20-1216
£499.00

Anthracite



FNWU-20-1416
£499.00

Terra Matt



FNWU-20-1816
£499.00

Nilo



FNWU-20-5216
£449.00

Walnut



FNWU-20-5416
£449.00

Wenge



FNWU-20-5616
£449.00

Bleached Oak



FNWU-20-5816
£449.00

Hands & Faces Basins



ZOLI 430mm ROUND BASIN

(VBSW-90-3570)

- With overflow
- Supplied with a freeflow waste with ceramic cover

£299.00



ZOLI 430mm SQUARE BASIN

(VBSW-90-3578)

- With overflow
- Supplied with a freeflow waste with ceramic cover

£299.00



ALLURE FLAT BASIN

(VBSW-90-3580)

- With overflow
- Supplied with a freeflow waste with ceramic cover

£299.00



PURE 50cm BASIN

(VBSW-30-3750)

- Sit-on
- With overflow
- One tap hole
- White

£299.00



PURE 80cm BASIN

(VBSW-30-3780)

- Sit-on
- With overflow
- One tap hole
- White

£449.00



SIMPLE 60cm COUNTER TOP

- For use with Simple 60cm Basin Vanity Unit
- For use with sit-on basins
- Size: 500(w) x 425(d) x 16(h) mm

White



FNCT-22-1005
£109.00

Anthracite



FNCT-22-1405
£109.00

Terra Matt



FNCT-22-1805
£109.00



Walnut



FNCT-22-5405
£99.00

Wenge



FNCT-22-5605
£99.00

Bleached Oak



FNCT-22-5805
£99.00

SIMPLE 80cm COUNTER TOP

- For use with Simple 80cm Basin Vanity Unit
- For use with sit-on basins
- Size: 750(w) x 450(d) x 16(h) mm

White



FNCT-22-1007
£119.00

Anthracite



FNCT-22-1407
£119.00

Terra Matt

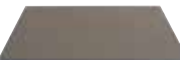

FNCT-22-1807
£119.00



Walnut



FNCT-22-5407
£109.00

Wenge



FNCT-22-5607
£109.00

Bleached Oak



FNCT-22-5807
£109.00

SIMPLE 130cm COUNTER TOP

- For use with Simple 130cm Basin Vanity Unit
- For use with sit-on basins
- Size: 1250(w) x 450(d) x 16(h) mm

White

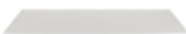

FNCT-22-1012
£159.00

Anthracite



FNCT-22-1412
£159.00

Terra Matt



FNCT-22-1812
£159.00



Walnut



FNCT-22-5412
£139.00

Wenge

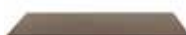

FNCT-22-5612
£139.00

Bleached Oak



FNCT-22-5812
£139.00

ISOLA SIT-ON BASIN – MATT BEIGE MARBLE

(VBSW-90-3558)

- Matt beige marble
- Without overflow

£699.00



ISOLA SIT-ON BASIN – DARK MARBLE

(VBSW-90-3559)

- Polished dark Emperador marble
- Without overflow

£699.00



MERANO SIT-ON BASIN – MATT BEIGE

(VBSW-90-3560)

- Matt beige stone
- Without overflow

£399.00



MERANO SIT-ON BASIN – DARK MARBLE

(VBSW-90-3561)

- Polished dark Emperador marble
- Without overflow

£399.00



ELEMENTS STANDARD TILEABLE VANITY UNITS



- Tileable vanity unit with shelf
- Available in three sizes

750(h) x 800(w) x 600(d) mm (EMWS-05-0800)
£475.00

750(h) x 1200(w) x 600(d) mm (EMWS-05-1200)
£595.00

750(h) x 1600(w) x 600(d) mm (EMWS-05-1600)
£695.00



Tiled Benches

Made from Elements structural foam these tileable benches are fully waterproof, supplied fully assembled, ready to tile and come with a 15 year guarantee.

Bespoke Benches

Bespoke sizes can be easily manufactured to suit any requirements.



Hands & Faces Collection

Zoli Ceramic Basins



ZOLI ROUND BASIN
VBSW-90-3570 430mm diameter



ZOLI SQUARE BASIN
VBSW-90-3578 430 x 430mm

Hands & Faces Collection

Allure Ceramic Basin



ALLURE FLAT BASIN
VBSW-90-3580 585 x 380mm

Hands & Faces Collection

Pure Ceramic Basins



PURE 50cm BASIN
VBSW-30-3750 500 x 420mm
○○



PURE 80cm BASIN
VBSW-30-3780 800 x 470mm
○○

Basin key

- suitable for 3-hole tap fittings, centre tap holes punched out
- suitable for single hole tap fittings only
- with integral overflow

Hands & Faces Collection

Simple Counter Tops



SIMPLE 60cm COUNTER TOP
FNCT-22-1005 White
FNCT-22-1405 Anthracite
FNCT-22-1805 Terra Matt
FNCT-22-5405 Walnut
FNCT-22-5605 Wenge
FNCT-22-5805 Bleached Oak

Size: 500(w) x 425(d) x 16(h) mm



SIMPLE 80cm COUNTER TOP
FNCT-22-1007 White
FNCT-22-1407 Anthracite
FNCT-22-1807 Terra Matt
FNCT-22-5407 Walnut
FNCT-22-5607 Wenge
FNCT-22-5807 Bleached Oak

Size: 750(w) x 450(d) x 16(h) mm



SIMPLE 130cm COUNTER TOP
FNCT-22-1012 White
FNCT-22-1412 Anthracite
FNCT-22-1812 Terra Matt
FNCT-22-5412 Walnut
FNCT-22-5612 Wenge
FNCT-22-5812 Bleached Oak

Size: 1250(w) x 450(d) x 16(h) mm

Furniture colour key



Hands & Faces Collection

Isola Stone Basins



ISOLA MATT BEIGE MARBLE
VBSW-90-3558 600 x 380mm



ISOLA DARK MARBLE
VBSW-90-3559 600 x 380mm

Hands & Faces Collection

Merano Stone Basins



MERANO MATT BEIGE STONE
VBSW-90-3560 400 x 400mm



MERANO DARK MARBLE
VBSW-90-3561 400 x 400mm

Hands & Faces Collection

Tileable Vanity Units



TILEABLE VANITY UNIT 80cm
EMWS-05-0800
750(h) x 800(w) x 600(d)mm



TILEABLE VANITY UNIT 120cm
EMWS-05-1200
750(h) x 1200(w) x 600(d)mm



TILEABLE VANITY UNIT 160cm
EMWS-05-1600
750(h) x 1600(w) x 600(d)mm



Mix & Match
Pure, Simple and D-Style
to create an individual look for
any contemporary bathroom.









BASIN / BIDET MIXER FLOW LIMITERS

DESCRIPTION	COLOUR INDICATOR	PRODUCT CODE	PRICE
5L FLOW LIMITER INSERT	ORANGE	VEAC-10-0005	£7.20
3L FLOW LIMITER INSERT	LILAC	VEAC-10-0003	£7.20

To be installed within the mono basin mixer aerator.

Note: Only to be installed with compatible Abacus brassware marked with the 'ECO' logo



Look out for this logo for compatible brassware products.

Why go Eco?

The Environment

Reducing water consumption helps preserve our natural resources and lower the impact on climate change.

Government Legislation

Changes to Building Regulations Part G requires that all new build domestic property and change of use renovation be subject to maximum daily water consumption per person. In addition, the Code for Sustainable Homes is a requirement that planning authorities use to grant permission for social housing developments and again, maximum daily water consumption levels must be achieved. The use of flow limiters help achieve these levels.

Money Saving

Fitting flow limiters within a domestic household can save hundreds of pounds in water bills annually. In addition, it can also help reduce energy bills since less water is needed to be heated during showering etc.

EXPOSED MIXER / WALL OUTLET FLOW LIMITERS

DESCRIPTION	COLOUR INDICATOR	PRODUCT CODE	PRICE
9L FLOW LIMITER	ORANGE	VEAC-12-0009	£9.00
6L FLOW LIMITER	BROWN	VEAC-12-0006	£9.00

To be installed on the shower outlet.

Note: Only to be installed with compatible Abacus brassware marked with the 'ECO' logo



TAP WATER PRESSURE KEY:



Taps & Brassware

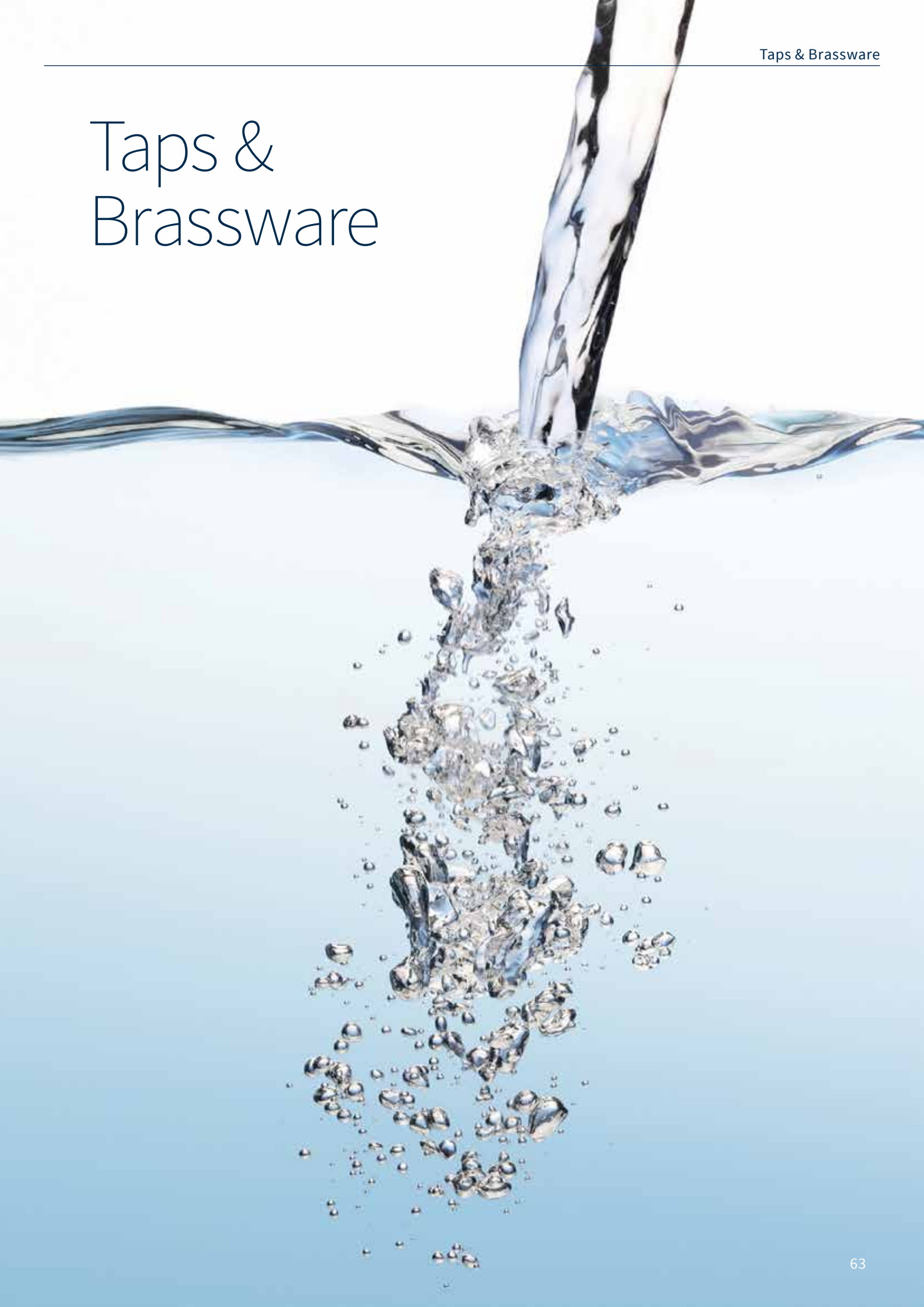

Logic





LP
>0.2

LOGIC
STANDARD MONO BASIN MIXER
(TBTS-33-1202)

- Chrome

£149.00



LP
>0.2

LOGIC
MINI MONO BASIN MIXER
(TBTS-33-1204)

- Chrome

£149.00



LP
>0.2

LOGIC
TALL MONO BASIN MIXER
(TBTS-33-1402)

- Chrome

£267.00



LP
>0.2

LOGIC
BATH FILLER
(TBTS-33-3202)

- Chrome

£199.00



LP
>0.2

LOGIC
BATH SHOWER MIXER
(TBTS-33-3204)

- Chrome

£228.00

Ki



ECO Flow Limiter available for this product - see page 62

MP
>0.5

KI
MONO BASIN MIXER
(VETS-05-1105)

- Chrome

£154.50



MP
>0.5

KI
TALL MONO BASIN MIXER
(VETS-05-1115)

- Chrome

£199.00



ECO Flow Limiter available for this product - see page 62

MP
>0.5

KI
WALL-MOUNTED BASIN MIXER
(VETS-05-1110)

- Chrome
- 23cm spout

£265.00



MP
>0.5

KI
WALL-MOUNTED BATH/
SHOWER MIXER
(VETS-05-2125)

- Chrome

£299.00



MP
>0.5

KI
MONO BIDET MIXER
(VETS-05-3130)

- Chrome

£178.00



HP
>1.0

KI
SINGLE LEVER BATH FILL VALVE
(VETS-05-2115)

- Chrome

£169.00



HP
>1.0

KI
WALL-MOUNTED BATH SPOUT
(VETS-05-2120)

- Chrome
- 230mm spout

£118.50



HP
>3.0

KI
3 HOLE DECK-MOUNTED
BATH MIXER WITH PULL OUT
HAND SHOWER - NO SPOUT
(VETS-05-2110)

- Chrome
- For use with bath filler waste or spout

£263.00



HP
>3.0

KI
4 HOLE DECK-MOUNTED
BATH MIXER WITH PULL OUT
HAND SHOWER - 18cm SPOUT
(VETS-05-2105)

- Chrome

£359.00



LP
>0.3

KI
2 HOLE BATH FILLER
(VETS-05-2130)

- Chrome

£238.00



LP
>0.3

KI
2 HOLE BATH SHOWER MIXER
(VETS-05-2135)

- Chrome

£275.00

Edition





LP
>0.2

EDITION
MONO BASIN MIXER
(TBTS-32-1202)

- Chrome

£159.00



LP
>0.2

EDITION
TALL MONO BASIN MIXER
(TBTS-32-1402)

- Chrome

£219.00



LP
>0.2

EDITION
BATH FILLER
(TBTS-32-3202)

- Chrome

£216.00



LP
>0.2

EDITION
BATH SHOWER MIXER
(TBTS-32-3204)

- Chrome

£234.00



COOL TOUCH
TECHNOLOGY

MP
>0.5

EDITION
EXPOSED THERMOSTATIC
SHOWER VALVE
(TBTS-32-4502)

- Chrome

£219.00

Plan



LP
>0.2

PLAN
STANDARD MONO BASIN MIXER
(TBTS-26-1202)

- Chrome

£169.00



LP
>0.2

PLAN
MINI MONO BASIN MIXER
(TBTS-26-1204)

- Chrome

£169.00



LP
>0.2

PLAN
TALL MONO BASIN MIXER
(TBTS-26-1402)

- Chrome

£239.00

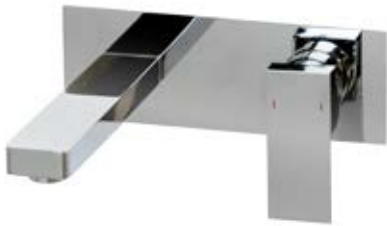

LP
>0.2

PLAN
WALL-MOUNTED BASIN MIXER
(TBTS-26-1602)

- Chrome

£199.00



LP
>0.2

PLAN
MONO BIDET MIXER
(TBTS-26-2202)

- Chrome

£189.00



LP
>0.2

PLAN
BATH SPOUT
(TBTS-26-3802)

- Chrome
- 180mm spout

£119.00



LP
>0.2

PLAN
BATH FILLER
(TBTS-26-3202)

- Chrome

£229.00



MP
>0.5

PLAN
BATH SHOWER MIXER
(TBTS-26-3212)

- Chrome

£249.00



MP
>0.5

PLAN
FREESTANDING BATH SHOWER MIXER
(TBTS-26-3602)

- Chrome

£499.00

Ala-S





LP
>0.2

ALA-S
STANDARD MONO BASIN MIXER
(TBTS-23-1202)

- Chrome

£159.00



LP
>0.2

ALA-S
MINI MONO BASIN MIXER
(TBTS-23-1204)

- Chrome

£159.00



LP
>0.2

ALA-S
TALL MONO BASIN MIXER
(TBTS-23-1402)

- Chrome

£239.00



LP
>0.2

ALA-S
BATH FILLER
(TBTS-23-3202)

- Chrome

£199.00

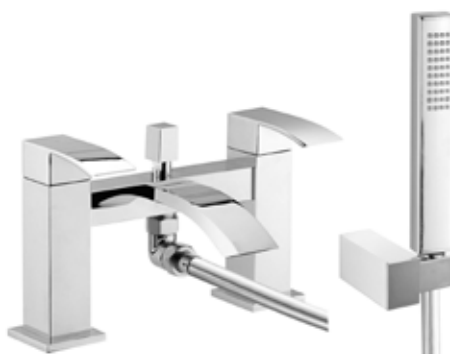

LP
>0.2

ALA-S
BATH SHOWER MIXER
(TBTS-23-3212)

- Chrome

£229.00



LP
>0.2

ALA-S
BATH SPOUT
(TBTS-23-3802)

- Chrome
- 140mm spout

£129.00

Twist





LP
>0.2

TWIST
MONO BASIN MIXER
(TBTS-29-1202)

- Chrome

£229.00



LP
>0.2

TWIST
BATH FILLER
(TBTS-29-3202)

- Chrome

£249.00



MP
>0.5

TWIST
SHOWER MIXER
(TBTS-29-4502)

- Chrome

£299.00



Iso





LP
>0.2

ISO
MONO BASIN MIXER
(TBTS-34-1202)

- Chrome

£119.00



LP
>0.2

ISO
TALL MONO BASIN MIXER
(TBTS-34-1402)

- Chrome

£149.00



LP
>0.2

ISO
WALL-MOUNTED BASIN MIXER
(TBTS-34-1602)

- Chrome

£149.00



LP
>0.2

ISO
BATH FILLER
(TBTS-34-3202)

- Chrome

£119.00



MP
>0.5

ISO
BATH SHOWER MIXER
(TBTS-34-3204)

- Chrome

£144.00



HP
>1.0

ISO
FREESTANDING BATH SHOWER MIXER
(TBTS-34-3602)

- Chrome

£499.00

XS





LP
>0.2

XS
MONO BASIN MIXER
(TBTS-35-1202)

- Chrome

£129.00



LP
>0.2

XS
WALL-MOUNTED BASIN MIXER
(TBTS-35-1602)

- Chrome

£179.00



LP
>0.2

XS
DECK-MOUNTED BATH FILLER
(TBTS-35-3202)

- Chrome

£159.00



LP
>0.2

XS
WALL-MOUNTED BATH FILLER
(TBTS-35-3402)

- Chrome

£229.00



MP
>0.5

XS
DECK-MOUNTED BATH SHOWER MIXER
(TBTS-35-3204)

- Chrome

£199.00



HP
>1.0

XS
FLOOR-MOUNTED BATH MIXER
(TBTS-35-3602)

- Chrome

£499.00

EXAFILL S BATH FILLER AND PUW FOR BATH TUBS COMPLETE WITH FINISH SET*

DESCRIPTION	FINISH	PRODUCT CODE	PRICE
EXAFILL S COMPLETE	CHROME	TBHG-58113000	£206.00

*will require DN50-2" adapter (not supplied)

FLEXIBLE CONNECTION TUBE FOR EXAFILL 800mm

DESCRIPTION	PRODUCT CODE	PRICE
FLEXIBLE CONNECTION TUBE 800mm	TBHG-58192000	£112.00



FLEXAPLUS S BATH POP UP WASTE FOR BATH TUBS COMPLETE WITH FINISH SET*

DESCRIPTION	FINISH	PRODUCT CODE	PRICE
FLEXAPLUS S COMPLETE	CHROME	TBHG-58150000	£110.00

*will require DN50-2" adapter (not supplied)



DN50-2" ADAPTER

DESCRIPTION	FINISH	PRODUCT CODE	PRICE
DN50-2" ADAPTER	N/A	ANPP-05-0005	£7.80



Wastes

CLICK BASIN WASTE SLOTTED

FINISH	PRODUCT CODE	PRICE
CHROME	VETW-10-0525	£19.50



FREEFLOW BASIN WASTE UNSLOTTED

FINISH	PRODUCT CODE	PRICE
CHROME	VETW-10-0535	£19.50



CLICK BASIN WASTE UNSLOTTED

FINISH	PRODUCT CODE	PRICE
CHROME	VETW-10-0530	£19.50



PRESSFLOW BASIN WASTE

FINISH	PRODUCT CODE	PRICE
CHROME UNSLOTTED	VETW-10-0520	£19.50
CHROME SLOTTED	VETW-10-0515	£19.50



Bottle Traps

DESIGNER BOTTLE TRAP SQUARE

FINISH	PRODUCT CODE	PRICE
CHROME	VETW-05-0515	£83.00



DESIGNER BOTTLE TRAP ROUND

FINISH	PRODUCT CODE	PRICE
CHROME	VETW-05-0510	£59.50



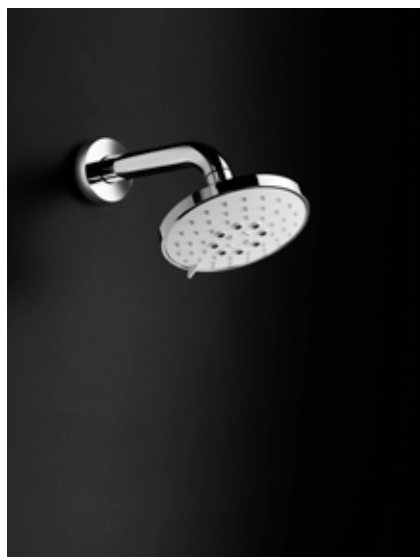

Showers & Shower Kits



Shower Valves

EMOTION



EMOTION ROUND THERMOSTATIC SHOWER MIXER (1 OUTLET)

(TBTS-06-2144)

- Chrome finish
- Minimum 1.5 bar pressure required

£339.00



EMOTION ROUND THERMOSTATIC BATH SHOWER MIXER (2 OUTLET)

(TBTS-06-2244)

- Chrome finish
- Minimum 1.5 bar pressure required

£389.00



EMOTION ROUND THERMOSTATIC BATH SHOWER MIXER (3 OUTLET)

(TBTS-06-2344)

- Chrome finish
- Minimum 1.5 bar pressure required

£429.00



EMOTION SQUARE THERMOSTATIC SHOWER MIXER (1 OUTLET)

(TBTS-07-2144)

- Chrome finish
- Minimum 1.5 bar pressure required

£339.00**EMOTION SQUARE THERMOSTATIC BATH SHOWER MIXER (2 OUTLET)**

(TBTS-07-2244)

- Chrome finish
- Minimum 1.5 bar pressure required

£389.00**EMOTION SQUARE THERMOSTATIC BATH SHOWER MIXER (3 OUTLET)**

(TBTS-07-2344)

- Chrome finish
- Minimum 1.5 bar pressure required

£429.00**EMOTION CROSSHEAD THERMOSTATIC SHOWER MIXER (1 OUTLET)**

(TBTS-08-2144)

- Chrome finish
- Minimum 1.5 bar pressure required

£339.00**EMOTION CROSSHEAD THERMOSTATIC BATH SHOWER MIXER (2 OUTLET)**

(TBTS-08-2244)

- Chrome finish
- Minimum 1.5 bar pressure required

£389.00**EMOTION CROSSHEAD THERMOSTATIC BATH SHOWER MIXER (3 OUTLET)**

(TBTS-08-2344)

- Chrome finish
- Minimum 1.5 bar pressure required

£429.00

EMOTION EXPOSED THERMOSTATIC SHOWER MIXER

(VETS-10-3120)

- Chrome finish
- Minimum 1.0 bar pressure required

£178.00



EMOTION EXPOSED THERMOSTATIC BATH SHOWER MIXER

(VETS-10-3125)

- Chrome finish
- Minimum 1.5 bar pressure required

£238.00



EMOTION EXPOSED THERMOSTATIC SHOWER MIXER WITH OVERHEAD SHOWER & RISER RAIL KIT

(VESK-65-0010)

- Chrome finish
- Minimum 1.5 bar pressure required

£358.00



Shower Accessories

EMOTION



Fixed shower heads

EMOTION ROUND SHOWER HEAD 200mm

(VESK-05-0505)

- Chrome
- Minimum 1.0 bar pressure required

£102.00



EMOTION ROUND SHOWER HEAD 250mm

(VESK-05-0510)

- Chrome
- Minimum 1.0 bar pressure required

£150.00



EMOTION ROUND SHOWER HEAD 300mm

(VESK-05-0515)

- Chrome
- Minimum 1.0 bar pressure required

£270.00



EMOTION SQUARE FIXED SHOWER HEAD 200mm CHROME & WHITE FINISH

(VESK-05-0540)

- Chrome
- Minimum 1.0 bar pressure required

£69.00



EMOTION SQUARE SHOWER HEAD 250mm

(VESK-05-0530)

- Chrome
- Minimum 1.0 bar pressure required

£139.00



EMOTION RECTANGLE ULTRA-THIN SHOWER HEAD 300 x 200mm

(VESK-05-1005)

- Polished stainless steel
- Minimum 1.0 bar pressure required

£139.00

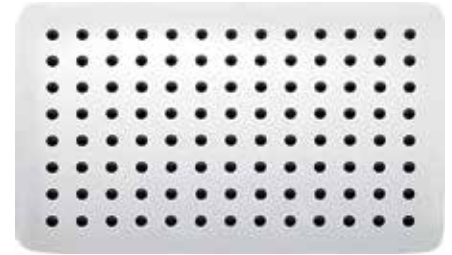

EMOTION SQUARE ULTRA-THIN SHOWER HEAD 350mm

(VESK-05-1035)

- Polished stainless steel
- Minimum 1.0 bar pressure required

£238.00

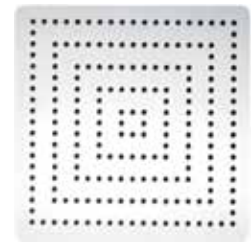

EMOTION SQUARE ULTRA-THIN SHOWER HEAD 500mm

(VESK-05-1050)

- Polished stainless steel
- Minimum 1.5 bar pressure required

£478.00

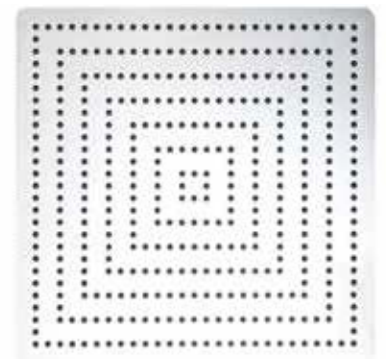

EMOTION RECTANGLE ULTRA-THIN 500 x 200mm

(VESK-20-0005)

- Polished stainless steel
- Minimum 1.0 bar pressure required

£358.00



Fixed shower arms

EMOTION ROUND FIXED WALL ARM 380mm

(VESK-10-0505)

- Chrome

£48.00



EMOTION ROUND FIXED CEILING ARM 200mm

(VESK-15-0505)

- Chrome

£48.00



EMOTION SQUARE FIXED WALL ARM 370mm

(VESK-10-0515)

- Chrome

£72.00



EMOTION SQUARE FIXED CEILING ARM 200mm

(VESK-15-0515)

- Chrome

£72.00



EMOTION ANGLED WALL ARM 135mm

(VESK-10-0520)

- Chrome

£29.00



EMOTION ECO FIXED HEAD PACK

(VEKT-10-0009)

- Chrome
- Minimum 1.0 bar pressure required
- Includes 200mm shower head and 135mm angled wall arm

£59.00

90



Shower outlets

EMOTION ROUND WALL OUTLET

(VESK-40-0505)

- Chrome

£28.50



EMOTION ROUND WALL OUTLET & HOLDER

(VESK-35-0505)

- Chrome

£39.50



EMOTION SQUARE WALL OUTLET

(VESK-40-0510)

- Chrome

£34.50



EMOTION SQUARE WALL OUTLET & HOLDER

(VESK-35-0510)

- Chrome

£46.50



Hand showers

EMOTION SLIMLINE HANDSHOWER

(VESK-25-0505)

- Chrome
- Minimum 0.3 bar pressure required

£33.50



EMOTION ROUND VARI HANDSHOWER

(VESK-25-0515)

- Chrome
- Minimum 0.3 bar pressure required

£28.50



EMOTION RECTANGLE HANDSHOWER

(VESK-25-0510)

- Chrome
- Minimum 0.3 bar pressure required

£22.50



EMOTION ROUND WALL-MOUNTED HAND SHOWER SUPPORT

(VESK-42-0505)

- Chrome

£15.00

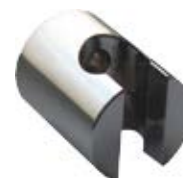

Wall bars & hoses

EMOTION SLIDE RAIL

(VESK-30-0505)

- Chrome

£58.50



EMOTION SHOWER HOSES

(VESK-45-0005) 1.25m **£21.50**

(VESK-45-0010) 1.6m **£22.50**



Slide rail kits

**EMOTION ROUND VARI HANDSHOWER,
RISER RAIL, 1.6m HOSE & ROUND WALL OUTLET**
(VEKT-10-0001)

- Chrome

£139.00



**EMOTION ROUND VARI HANDSHOWER,
RISER RAIL, 1.6m HOSE & SQUARE WALL OUTLET**
(VEKT-10-0002)

- Chrome

£145.00



**EMOTION SLIMLINE HANDSHOWER,
RISER RAIL, 1.6m HOSE & ROUND WALL OUTLET**
(VEKT-10-0003)

- Chrome

£145.00



**EMOTION SLIMLINE HANDSHOWER,
RISER RAIL, 1.6m HOSE & SQUARE WALL OUTLET**
(VEKT-10-0004)

- Chrome

£150.00



EMOTION RECTANGLE HANDSHOWER, RISER RAIL, 1.6m HOSE & ROUND WALL OUTLET

(VEKT-10-0005)

- Chrome

£142.00



EMOTION RECTANGLE HANDSHOWER, RISER RAIL, 1.6m HOSE & SQUARE WALL OUTLET

(VEKT-10-0006)

- Chrome

£139.00



EMOTION SLIMLINE HANDSHOWER, 1.25m HOSE & ROUND WALL OUTLET & HOLDER

(VEKT-10-0007)

- Chrome

£90.00



EMOTION SLIMLINE HANDSHOWER, 1.25m HOSE & SQUARE WALL OUTLET & HOLDER

(VEKT-10-0008)

- Chrome

£99.00



Shower Kits

EMOTION



KIT E01 - EMOTION THERMOSTATIC SHOWER & RISER RAIL

(TBKT-05-R001)

£399.00

Consisting of:

Slide rail • handshower • 1.6m hose
wall outlet • 1 outlet thermostatic mixer



KIT ALSO AVAILABLE WITH SQUARE AND CROSSHEAD HANDLES



TBKT-05-S001



TBKT-05-X001



All prices inclusive of VAT

KIT E02 - EMOTION THERMOSTATIC SHOWER & ROUND FIXED HEAD

(TBKT-05-R002)

£419.00

Consisting of:
250mm round head • round wall arm • 1 outlet thermostatic mixer

KIT ALSO AVAILABLE WITH SQUARE AND CROSSHEAD HANDLES



TBKT-05-S002



TBKT-05-X002



KIT E03 - EMOTION THERMOSTATIC SHOWER & SQUARE FIXED HEAD

(TBKT-05-R003)

£449.00

Consisting of:
250mm square head • square wall arm • 1 outlet thermostatic mixer

KIT ALSO AVAILABLE WITH SQUARE AND CROSSHEAD HANDLES



TBKT-05-S003



TBKT-05-X003



KIT E04 - EMOTION THERMOSTATIC SHOWER, ROUND FIXED HEAD & HAND SHOWER

(TBKT-05-R004)

£479.00

Consisting of:
250mm round head • round wall arm • 2 outlet thermostatic mixer
handshower • 1.25m hose • wall outlet & holder

KIT ALSO AVAILABLE WITH SQUARE AND CROSSHEAD HANDLES



TBKT-05-S004



TBKT-05-X004



KIT E05 - EMOTION THERMOSTATIC SHOWER, ROUND FIXED HEAD & HAND SHOWER

(TBKT-05-R005)

£499.00

Consisting of:
250mm square head • square wall arm • 2 outlet thermostatic mixer
handshower • 1.25m hose • wall outlet & holder

KIT ALSO AVAILABLE WITH SQUARE AND CROSSHEAD HANDLES



TBKT-05-S005



TBKT-05-X005



KIT E06 - EMOTION THERMOSTATIC SHOWER, FIXED HEAD & RISER RAIL

(TBKT-05-R006)

£515.00

Consisting of:
250mm round head • round wall arm • 2 outlet thermostatic mixer
handshower • slide rail • 1.6m hose • wall outlet

KIT ALSO AVAILABLE WITH SQUARE AND CROSSHEAD HANDLES



TBKT-05-S006



TBKT-05-X006



KIT E07 - EMOTION THERMOSTATIC SHOWER, RECTANGLE FIXED HEAD & HAND SHOWER

(TBKT-05-R007)

£699.00

Consisting of:
Rectangle head • 2 outlet thermostatic mixer • handshower
1.25m hose • wall outlet & holder

KIT ALSO AVAILABLE WITH SQUARE AND CROSSHEAD HANDLES



TBKT-05-S007



TBKT-05-X007



KIT E08 - EMOTION THERMOSTATIC SHOWER, RECTANGLE FIXED HEAD & RISER RAIL

(TBKT-05-R008)

£699.00

Consisting of:

Rectangle head • 2 outlet thermostatic mixer • slide rail handshower • 1.6m hose • wall outlet

KIT ALSO AVAILABLE WITH SQUARE AND CROSSHEAD HANDLES



TBKT-05-S008



TBKT-05-X008



Flow Limiter available for this product - see page 62

KIT E10 - EMOTION EXPOSED THERMOSTATIC BAR SHOWER & RISER RAIL

(TBKT-05-0010)

£238.00

Consisting of:

Exposed thermostatic mixer • slide rail handshower • 1.6m hose



Flow Limiter available for this product - see page 62

KIT E11 - EMOTION EXPOSED THERMOSTATIC BAR BATH SHOWER MIXER & RISER RAIL

(TBKT-05-0011)

£274.00

Consisting of:

Exposed thermostatic bath shower mixer slide rail • handshower • 1.6m hose



Flow Limiter available for this product - see page 62

Shower Valves

TEMPTATION

TEMPTATION UNIVERSAL i-BOX (FIRST FIX INSTALLATION SET)

(TBHG-01800180)

- Suitable for Temptation shower valves TBHG-15757000 and TBHG-15758000
- Supplied with waterproof sealing kit
- Rotationally symmetric installation

£114.00



TEMPTATION ROUND THERMOSTATIC SHOWER MIXER (1 OUTLET)

(TBHG-15757000)

- Chrome finish
- Thermostatic cartridge and shut-off valve
- Safety stop at 40°C
- Temperature limitation adjustable
- Flow rate 26 l/min at 3 bar

Required parts: must be used in conjunction with Temptation i-Box

£387.00



TEMPTATION ROUND THERMOSTATIC SHOWER MIXER (2 OUTLET)

(TBHG-15758000)

- Chrome finish
- Thermostatic cartridge, shut-off and diverter valve
- Safety stop at 40°C
- Temperature limitation adjustable
- Flow rate 26 l/min at 3 bar

Required parts: must be used in conjunction with Temptation i-Box

£429.00

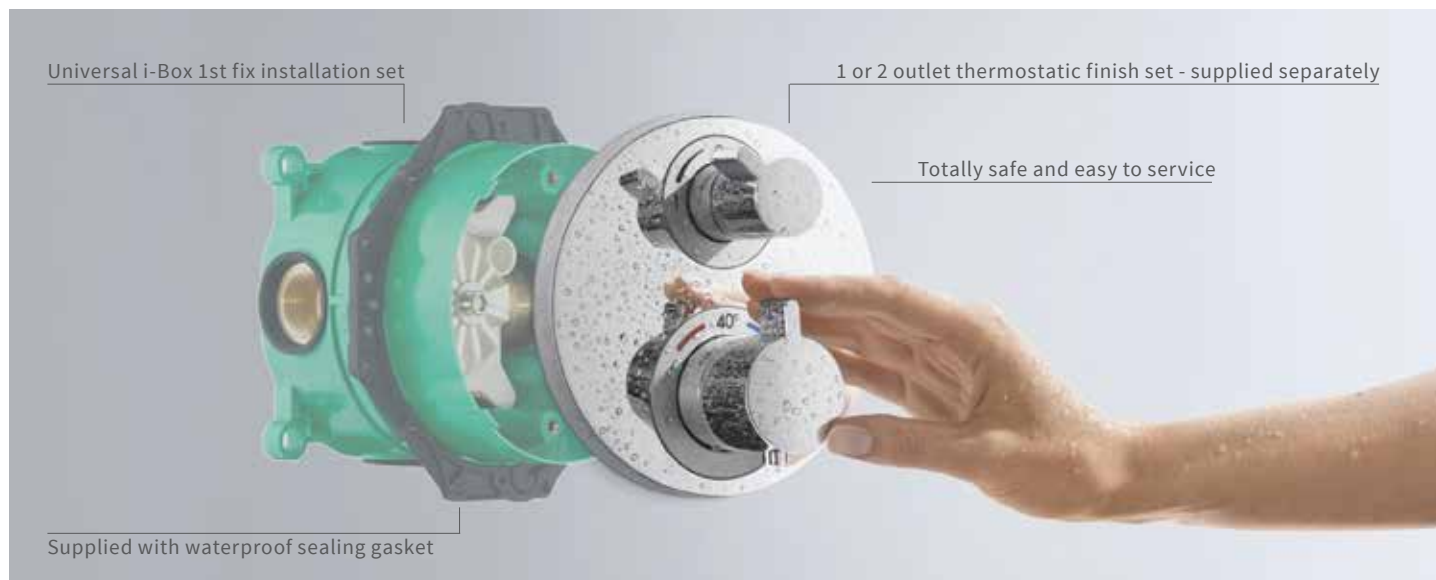



Shower Accessories

TEMPTATION

TEMPTATION CHROME SQUARE SHOWERHEAD 120mm

(TBTS-41-5202)

- Shower head
- Fixed
- Square 120mm
- Chrome finish

£47.00



TEMPTATION CHROME SQUARE SHOWERHEAD ECOAIR 200

(TBTS-41-5220)

- Shower head
- Fixed
- Square 200mm
- Chrome finish

£139.00



TEMPTATION CHROME CREAM SHOWER HEAD 250mm

(TBTS-41-5203)

- Shower head
- Fixed
- Square 250mm
- Chrome finish

£119.00



TEMPTATION CHROME ROUND SHOWER HEAD 100 ECOAIR

(TBTS-41-5602)

- Shower head
- Fixed
- Round
- Diameter 100mm
- Chrome finish

£34.00



TEMPTATION ROUND SHOWERHEAD 130mm

(TBTS-41-5002)

- Multifunction shower head
- Fixed
- Round diameter 130mm
- Chrome finish

£59.00



TEMPTATION CHROME ROUND SHOWER HEAD ECOAIR 250

(TBTS-41-5025)

- Shower head
- Fixed
- Round
- Diameter 250mm
- Chrome finish



£149.00

TEMPTATION CHROME RETRO SHOWER HEAD 200mm

(TBTS-41-5004)

- Shower head
- Fixed
- Round
- Chrome finish



£119.00

TEMPTATION REINFORCED CHROME WALL ARM 420mm

(TBTS-41-6142)

- Reinforced wall arm specifically designed for large shower heads
- Square
- Length 420mm
- Chrome finish



£199.00

TEMPTATION REINFORCED CHROME WALL ARM 420mm

(TBTS-41-6042)

- Round wall arm
- Reinforced wall arm specifically designed for large shower heads
- Length 420mm
- Chrome finish

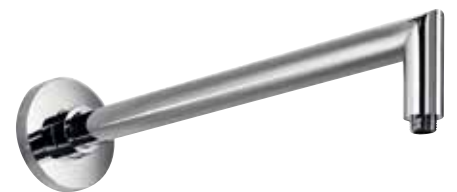

£195.00

TEMPTATION CHROME ROUND WALL ARM 165mm

(TBTS-41-6017)

- Wall fixed arm
- Length 165mm
- Chrome finish



£29.00

TEMPTATION CHROME ROTATING WALL ARM WITH OUTLET

(TBTS-41-6004)

- Rotating wall arm with outlet
- Chrome finish
- For use with hose and hand shower

£79.00



TEMPTATION CHROME ROTATING WALL ARM

(TBTS-41-6002)

- Rotating wall arm
- Fixed
- Chrome finish
- For use with wall outlet, hose and hand shower

£69.00



TEMPTATION FLUID SHOWER COLUMN 1200mm

(TBTS-41-6702)

- Fixed head shower column
- With hand shower
- Height 1200mm

£695.00



TEMPTATION CHROME SLIDE RAIL WITH WATER OUTLET

(TBTS-41-6606)

- Slide rail with water outlet
- Chrome finish

£139.00



TEMPTATION CHROME SLIDE RAIL

(TBTS-41-6604)

- Slide rail
- Chrome finish

£129.00



TEMPTATION CHROME WALL OUTLET TURN AND GO

(TBTS-41-7206)

- Turn and go design
- Holder, outlet with on/off
- Chrome finish

£119.00



TEMPTATION MULTIFUNCTION HAND SHOWER CHROME

(TBTS-41-6513)

- Hand shower
- Multifunction
- Chrome finish

£49.00



TEMPTATION CHROME WALL BRACKET

(TBTS-41-7204)

- Wall bracket
- Chrome finish

£26.00



TEMPTATION CHROME WALL OUTLET

(TBTS-41-7202)

- Wall outlet
- Chrome finish

£22.00



TEMPTATION SHOWER HOSE 1.60m

(TBTS-41-7015)

- Shower hose
- Length 1.60m
- Smooth Chromoflex finish

£25.00



TEMPTATION XL BUILT IN SHOWER HEAD 500mm STAINLESS STEEL

(TBTS-42-5850)

- Drench and waterfall function
- Ceiling-mounted shower head
- Square 500mm XL
- Stainless steel finish
- Dual flow outlet



£995.00

TEMPTATION WALL-MOUNTED WATERFALL SHOWER HEAD STAINLESS STEEL

(TBTS-42-5602)

- Wall-mounted shower head
- 590 x 250mm
- Stainless steel finish
- Dual flow outlet



£1,050.00

TEMPTATION BUILT IN SHOWER HEAD 300mm STAINLESS STEEL

(TBTS-42-5832)

- Ceiling-mounted shower head
- Square 300mm
- Stainless steel finish



£595.00

TEMPTATION WATERFALL BATH SPOUT

(TBTS-42-3802)

- Waterfall bath spout
- 175mm projection
- Deck-mounted
- Chrome finish



£595.00

TEMPTATION CHROME WATERFALL SHOWER HEAD/BATH FILLER

(TBTS-42-5612)

- Waterfall shower head or bath filler
- 175mm projection
- Chrome finish



£495.00



Shower Kits
EMOTION PLUS

KIT EP01 - EMOTION PLUS THERMOSTATIC SHOWER & RISER RAIL

(TBKT-20-R001)

£636.00

Consisting of:

Universal i-Box • slide rail • handshower • 1.6m hose
wall outlet • 1 outlet thermostatic mixer



KIT EP02 - EMOTION PLUS THERMOSTATIC SHOWER & ROUND FIXED HEAD

(TBKT-20-R002)

£699.00

Consisting of:

Universal i-Box • 250mm round head • round wall arm
1 outlet thermostatic mixer



KIT EP02C - WITH CEILING-MOUNTED OPTION

(TBKT-20-R02C)



£699.00



ECO Flow Limiter available for this product - see page 62

KIT EP03 - EMOTION PLUS THERMOSTATIC SHOWER & SQUARE FIXED HEAD

(TBKT-20-R003)

£736.00

Consisting of:

Universal i-Box • 250mm square head • square wall arm
1 outlet thermostatic mixer



KIT EP03C - WITH CEILING-MOUNTED OPTION

(TBKT-20-R03C)



£736.00



ECO Flow Limiter available for this product - see page 62

**KIT EP04 - EMOTION PLUS THERMOSTATIC SHOWER,
ROUND FIXED HEAD & HAND SHOWER**

(TBKT-20-R004)

£789.00

Consisting of:

Universal i-Box • 250mm round head • round wall arm

2 outlet thermostatic mixer • handshower • 1.25m hose • wall outlet & holder



KIT EP04C - WITH CEILING-MOUNTED OPTION

(TBKT-20-R04C)

£789.00



**KIT EP05 - EMOTION PLUS THERMOSTATIC SHOWER,
ROUND FIXED HEAD & HAND SHOWER**

(TBKT-20-R005)

£799.00

Consisting of:

Universal i-Box • 250mm square head • square wall arm

2 outlet thermostatic mixer • handshower • 1.25m hose • wall outlet & holder



KIT EP05C - WITH CEILING-MOUNTED OPTION

(TBKT-20-R05C)

£799.00



**KIT EP06 - EMOTION PLUS THERMOSTATIC, FIXED HEAD
& RISER RAIL**

(TBKT-20-R006)

£799.00

Consisting of:

Universal i-Box • 250mm round head • round wall arm

2 outlet thermostatic mixer • handshower • slide rail • 1.6m hose • wall outlet



KIT EP06C - WITH CEILING-MOUNTED OPTION

(TBKT-20-R06C)

£799.00



KIT EP07 - EMOTION PLUS THERMOSTATIC SHOWER, RECTANGLE FIXED HEAD & HAND SHOWER

(TBKT-20-R007)

£979.00

Consisting of:

Universal i-Box • rectangle head • 2 outlet thermostatic mixer • handshower • 1.25m hose • wall outlet & holder



ECO Flow Limiter available for this product - see page 62

KIT EP08 - EMOTION PLUS THERMOSTATIC SHOWER, RECTANGLE FIXED HEAD & RISER RAIL

(TBKT-20-R008)

£999.00

Consisting of:

Universal i-Box • rectangle head • 2 outlet thermostatic mixer • slide rail • handshower • 1.6m hose • wall outlet



ECO Flow Limiter available for this product - see page 62

Shower Kits

TEMPTATION



The ultimate in performance and luxury

KIT T01 - TEMPTATION 1 OUTLET THERMOSTATIC SHOWER, SLIDE RAIL & HAND SHOWER

(TBKT-10-T001)

£699.00

Consisting of:
Universal i-Box • 1 outlet thermostatic mixer • slide rail c/w outlet
Chromoflex hose • multi-function shower head



KIT T02 - TEMPTATION 1 OUTLET THERMOSTATIC SHOWER WITH FIXED ROUND SHOWER HEAD

(TBKT-10-T002)

£799.00

Consisting of:

Universal i-Box • 1 outlet thermostatic mixer reinforced round shower arm • EcoAir 250mm round shower head



KIT T03 - TEMPTATION 2 OUTLET THERMOSTATIC SHOWER WITH WALL-MOUNTED WATERFALL SHOWER HEAD

(TBKT-10-T003)

£1,599.00

Consisting of:

Universal i-Box • 2 outlet thermostatic mixer wall-mounted waterfall shower head



KIT T04 - TEMPTATION 2 OUTLET THERMOSTATIC SHOWER WITH CEILING-MOUNTED SHOWER HEAD & HAND SHOWER

(TBKT-10-T004)

£1,174.00

Consisting of:

Universal i-Box • 2 outlet thermostatic mixer ceiling-mounted shower head 300mm • wall outlet & holder Chromoflex hose • slimline hand shower



KIT T05 - TEMPTATION BATH & SHOWER KIT

(TBKT-10-T005)

£799.00

Consisting of:
 Universal i-Box • 2 outlet thermostatic mixer
 130mm multi-function shower head • fixed wall arm
 Exafill S bath filler & PUW complete



KIT T06 - TEMPTATION BATH & SHOWER KIT

(TBKT-10-T006)

£1,369.00

Consisting of:
 Universal i-Box • 2 outlet thermostatic mixer • reinforced square shower arm •
 EcoAir 200mm square shower head • waterfall wall-mounted bath filler



KIT T10 - TEMPTATION 1 OUTLET THERMOSTATIC SHOWER WITH TEMPTATION FLUID SHOWER COLUMN

(TBKT-10-T010)

£1,189.00

Consisting of:

- Universal i-Box • 1 outlet thermostatic mixer
- Temptation Fluid shower column with hand shower divert



ECO Flow Limiter available for this product - see page 62



Baths & Bath Screens



SERIES 1 SINGLE-ENDED BATHS

WITH SUPER STRENGTH ARMOUR+

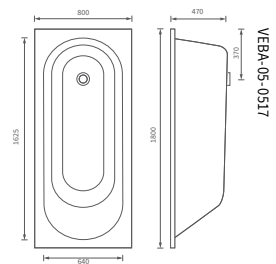
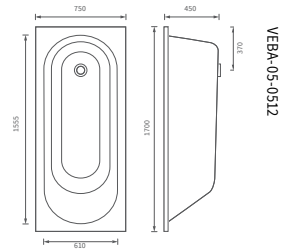
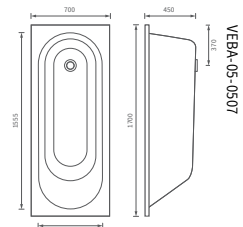

Can be drilled for overflow to give flexible overflow positions.

DESCRIPTION	DEPTH	CAPACITY	COLOUR	PRODUCT CODE	PRICE
SINGLE-ENDED BATH 1700 x 700mm	450mm	206 ltr	WHITE	VEBA-05-0507	£379.00
SINGLE-ENDED BATH 1700 x 750mm	450mm	215 ltr	WHITE	VEBA-05-0512	£429.00
SINGLE-ENDED BATH 1800 x 800mm	470mm	225 ltr	WHITE	VEBA-05-0517	£649.00

What is Armour+ ?

Armour+ baths have more strength and are heavier than standard acrylic baths. The extra layers created during the Armour+ process give a significantly reinforced product. The finished Armour+ bath offers a higher degree of comfort and luxury, backed with an unbeatable 30 year guarantee. Due to their enhanced rigidity, Armour+ baths are recommended for showering.



With Armour+
super strength acrylic

ARMOUR+ The Benefits

Lucite acrylic:

The world's most used sanitaryware cast acrylic sheet

- warm to touch
- easy to clean
- scratch & chemical resistant

increased insulation
keeps your bath water warmer for longer

totally encapsulated baseboard

Armour +
High performance reinforcement for super strength acrylic baths

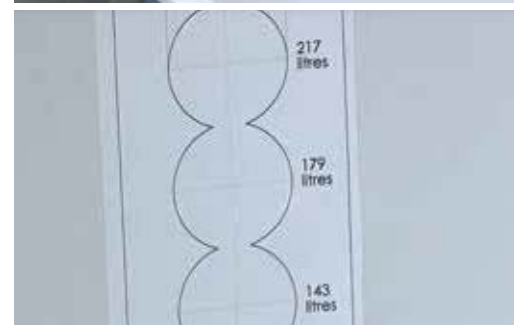

Series 1 single-ended baths can be drilled to give flexible overflow positions.

SERIES 1 DOUBLE-ENDED BATHS

WITH SUPER STRENGTH ARMOUR+

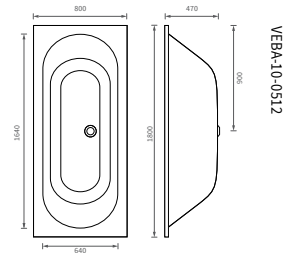
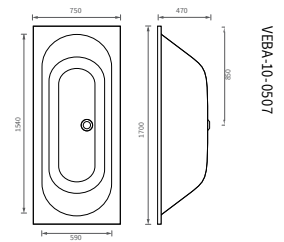

DESCRIPTION	DEPTH	CAPACITY	COLOUR	PRODUCT CODE	PRICE
DOUBLE-ENDED BATH 1700 x 750mm	470mm	225 ltr	WHITE	VEBA-10-0507	£529.00
DOUBLE-ENDED BATH 1800 x 800mm	470mm	235 ltr	WHITE	VEBA-10-0512	£669.00



With Armour +
super strength acrylic

EXAFILL S BATH FILLER AND PUW FOR BATH TUBS COMPLETE WITH FINISH SET*

DESCRIPTION	FINISH	PRODUCT CODE	PRICE
EXAFILL S COMPLETE	CHROME	TBHG-58113000	£206.00

*will require DN50-2" adapter (not supplied)



FLEXIBLE CONNECTION TUBE FOR EXAFILL 800mm

DESCRIPTION	PRODUCT CODE	PRICE
FLEXIBLE CONNECTION TUBE 800mm	TBHG-58192000	£112.00



FLEXAPLUS S BATH POP UP WASTE FOR BATH TUBS COMPLETE WITH FINISH SET*

DESCRIPTION	FINISH	PRODUCT CODE	PRICE
FLEXAPLUS S COMPLETE	CHROME	TBHG-58150000	£110.00

*will require DN50-2" adapter (not supplied)



DN50-2" ADAPTER

DESCRIPTION	FINISH	PRODUCT CODE	PRICE
DN50-2" ADAPTER	N/A	ANPP-05-0005	£7.80



SERIES 2 SINGLE-ENDED BATH

WITH SUPER STRENGTH ARMOUR+

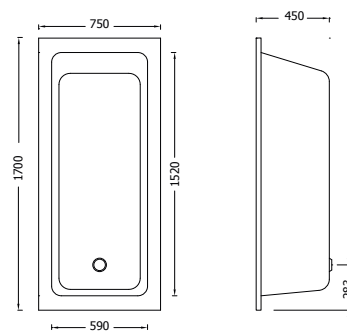

DESCRIPTION	DEPTH	CAPACITY	COLOUR	PRODUCT CODE	PRICE
SINGLE-ENDED BATH 1700 x 750mm	450mm	210 ltr	WHITE	VEBA-05-1005	£449.00



with Armour +
as standard

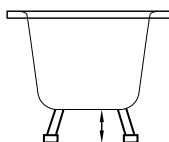

Height Adjustment

The minimum adjustment on the legs is 80mm and the maximum is 170mm.



SERIES 2 DOUBLE-ENDED BATH

WITH SUPER STRENGTH ARMOUR+

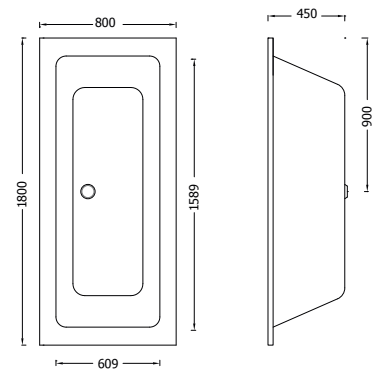
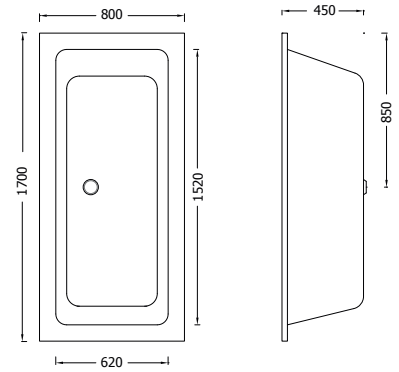

DESCRIPTION	DEPTH	CAPACITY	COLOUR	PRODUCT CODE	PRICE
DOUBLE-ENDED BATH 1700 x 800mm	450mm	215 ltr	WHITE	VEBA-10-1005	£549.00
DOUBLE-ENDED BATH 1800 x 800mm	450mm	232 ltr	WHITE	VEBA-10-1010	£699.00

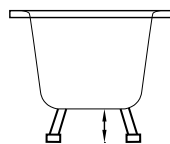

Height Adjustment

The minimum adjustment on the legs is 80mm and the maximum is 170mm.



with Armour +
as standard



SERIES 1 OVAL INSET BATH

WITH SUPER STRENGTH ARMOUR+

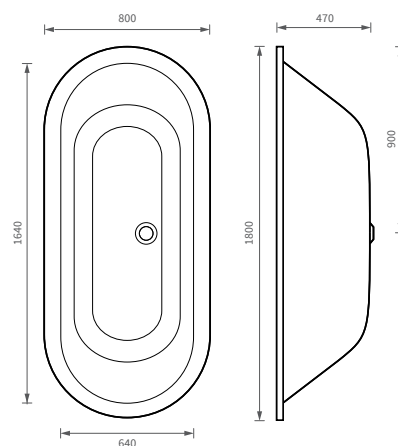

DESCRIPTION	DEPTH	CAPACITY	COLOUR	PRODUCT CODE	PRICE
OVAL INSET BATH 1800 x 800mm	470mm	233 ltr	WHITE	VEBA-15-1505	£699.00



with Armour +
as standard

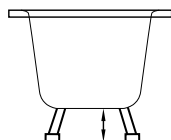

Height Adjustment

The minimum adjustment on the legs is 80mm and the maximum is 170mm.



Bath Surrounds for Oval Inset Bath

Unique multi-option kit will give your 1800 x 800mm oval bath the ultimate designer finish.

SERIES 1 OVAL MULTI-DESIGN TILEABLE BATH SURROUND KIT

(EMBP-25-0050)

- Create multiple design options from one kit
- Freestanding oval bath surround (to tile)
- To suit 1800 x 800mm Oval Bath Ref: VEBA-15-1505

£799.00

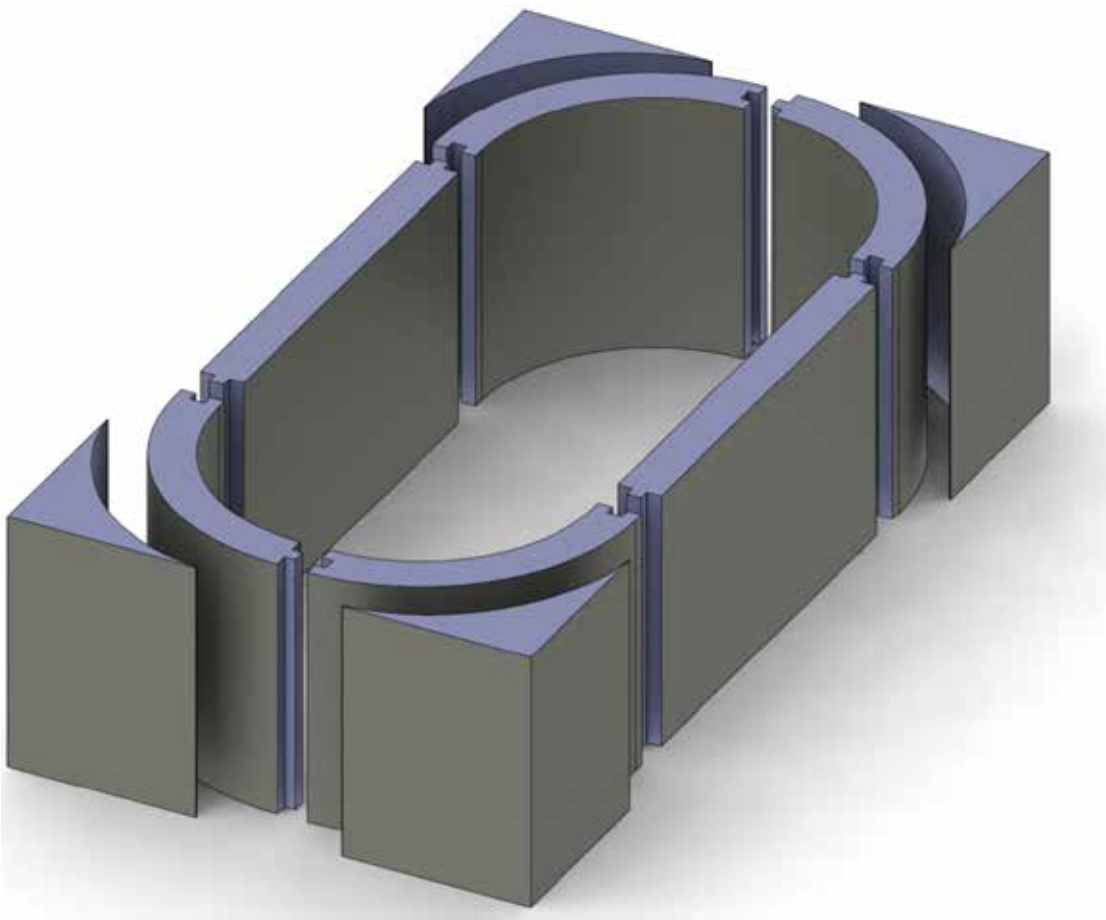

Option 1



Option 2
left or right hand



Option 3

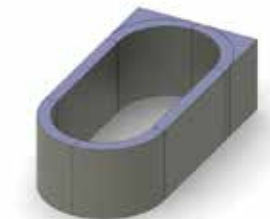

Option 4

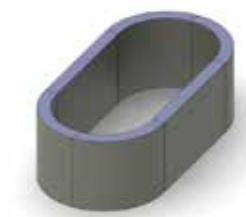

Option 5



VARESE FREESTANDING BATH - 1700 x 800mm

(BSFS-10-1708)



- Made from Lucite Acrylic
- Slimline waste required
- Bath trap can be sited above floor level
- No tap ledge so elegant floor or wall mounted taps can be chosen.

- The inner and outer of the baths have no seam joins giving that elegant one piece effect.
- Floor fixing kit available
- Capacity 216l

£1,399.00

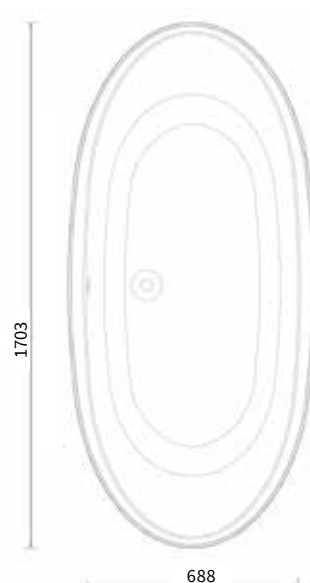

Bath height - 600mm
Bath weight - 56kg

For pop up wastes see Viega Multiplex M5 page 387

NOTE: the waste pipe for freestanding baths needs to be run within the floor

VARESE S FREESTANDING SLIPPER BATH - 1700 x 800mm

(BSFS-12-1708)



- Made from Lucite Acrylic
- Slimline waste required
- Bath trap can be sited above floor level
- No tap ledge so elegant floor or wall mounted taps can be chosen.

- The inner and outer of the baths have no seam joins giving that elegant one piece effect.
- Floor fixing kit available
- Capacity 216l

£1,499.00

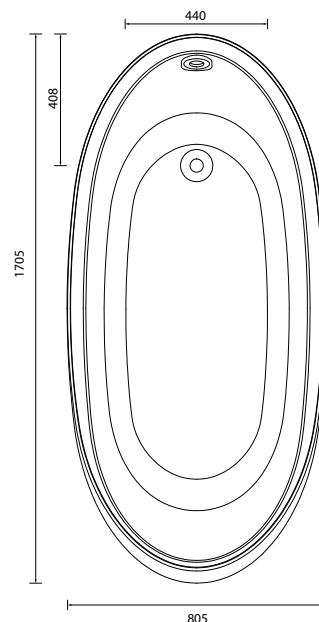

Bath height - 600mm
Back rest height - 715mm
Bath weight - 57kg

For pop up wastes see Viega Multiplex M5 page 387

NOTE: the waste pipe for freestanding baths needs to be run within the floor



LUGANO

(BSFS-02-1707)



- A beautifully designed cast solid-surface bath, incorporating innovative Evermite coating for easy cleaning and durability
- Sleek internal overflow
- Weight 110kg
- Capacity 180l

£3,250.00

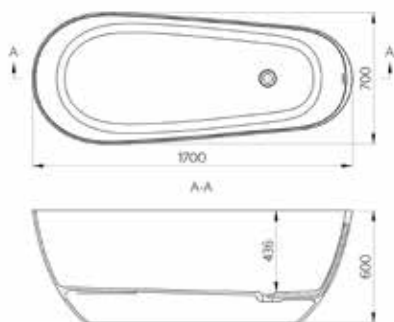

Requires a bath click waste.

NOTE: the waste pipe for freestanding baths needs to be run within the floor





Bath Screens



MINIMAL ONE-PART BATH SCREEN – WITH TOWEL BAR

8mm Toughened Safety Glass

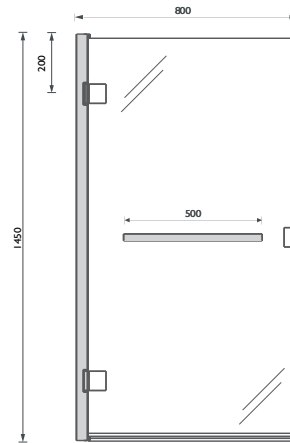

DESCRIPTION	WIDTH (mm)	HEIGHT (mm)	WALL ADJUSTMENT	GLASS THICKNESS	PRODUCT CODE	PRICE
ONE-PART BATH SCREEN	800	1450	150mm	8mm	VEGM-70-1110	£399.00

MINIMAL TWO-PART BATH SCREEN – WITH TOWEL BAR

8mm Toughened Safety Glass

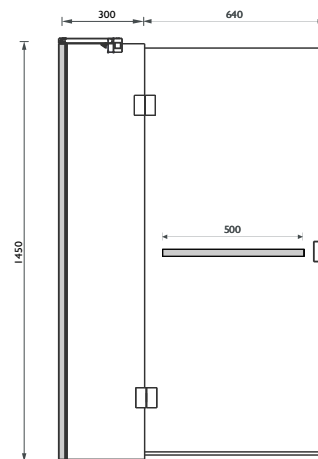

DESCRIPTION	WIDTH (mm)	HEIGHT (mm)	WALL ADJUSTMENT	GLASS THICKNESS	PRODUCT CODE	PRICE
TWO-PART BATH SCREEN	940	1450	15mm	8mm	VEGM-70-1120	£549.00

Tileable Bath Panels, Bath Steps & Accessories



STANDARD BATH FRONT PANELS

DESCRIPTION	SIZE (mm) W x L x H	PRODUCT CODE	PRICE
STANDARD BATH FRONT PANEL FOR BATHS UP TO 1800mm	1795 x 600 x 30	EMBP-05-0005	£71.50
STANDARD BATH FRONT PANEL FOR BATHS UP TO 2050mm	2050 x 600 x 30	EMBP-05-0010	£95.00



STANDARD BATH END PANEL

DESCRIPTION	SIZE (mm) W x L x H	PRODUCT CODE	PRICE
STANDARD BATH END PANEL	805 x 600 x 30	EMBP-05-0015	£36.00

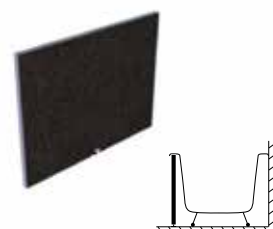

BATH FRONT PANEL WITH TILED LIP

DESCRIPTION	SIZE (mm) W x L x H	PRODUCT CODE	PRICE
BATH FRONT PANEL WITH TILED LIP FOR BATHS UP TO 2050mm	2050 x 580 x 30	EMBP-10-0005	£108.00

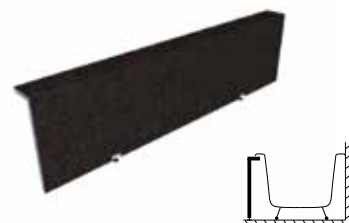

BATH END PANELS WITH TILED LIP

DESCRIPTION	SIZE (mm) W x L x H	PRODUCT CODE	PRICE
BATH END PANEL WITH TILED LIP - LEFT HAND	905 x 580 x 30	EMBP-10-0010	£71.00
BATH END PANEL WITH TILED LIP - RIGHT HAND	905 x 580 x 30	EMBP-10-0015	£71.00

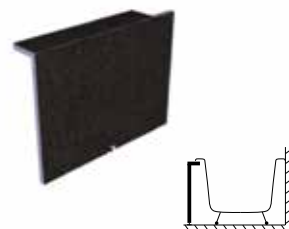

BATH PANEL MOUNTING KIT

DESCRIPTION	PRODUCT CODE	PRICE
BATH PANEL MOUNTING KIT INCLUDES 2 X FOAM STRIPS WITH FIXINGS	EMBP-15-0005	£9.50



BATH STEP

DESCRIPTION	SIZE (mm) W x L x H	PRODUCT CODE	PRICE
RAISED BATH STEP 200mm HEIGHT 300mm DEPTH	200 x 300	EMBP-20-0005	£159.00

PRICED PER LINEAR METER. (MADE TO LENGTH)

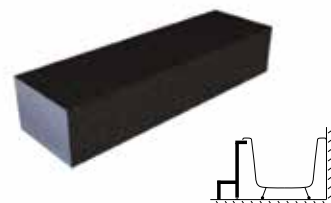

Bespoke Tileable Bath Panels



We are able to produce almost any bath panel solution to your specific requirements. Simply supply us with your detailed specification and we will be pleased to quote you prices and delivery times.



Towel Warmers & Radiators

ELEGANCE MILD STEEL CHROME & PAINTED



MICRO LINEA - CHROME

FROM

£150.00

- Option of 2 slimline sizes (H x W), 600mm x 300mm, 1120mm x 300mm
- Individually air-tested to 16 bar
- 10 year guarantee

SIZE (H x W) mm	COLOUR	OUTPUT Watts/BTU	PIPE CENTRES (mm)		SUMMER ELEMENT	TAPPINGS	PRODUCT CODE	PRICE
			RADIATOR	FROM WALL				
600 x 300	CHROME	133/454	250	62 - 87	75	½" BSP	ELL060030CP	£150.00
1120 x 300	CHROME	240/819	250	62 - 87	150	½" BSP	ELL112030CP	£246.00

MICRO LINEA - WHITE

FROM

£99.00

- Option of 2 slimline sizes (H x W), 600mm x 300mm, 1120mm x 300mm
- Custom colour options available to order
- Individually air-tested to 16 bar
- 10 year guarantee

SIZE (H x W) mm	COLOUR	OUTPUT Watts/BTU	PIPE CENTRES (mm)		SUMMER ELEMENT	TAPPINGS	PRODUCT CODE	PRICE
			RADIATOR	FROM WALL				
600 x 300	WHITE	173/590	250	62 - 87	75	½" BSP	ELL060030WH	£99.00
1120 x 300	WHITE	312/1063	250	62 - 87	150	½" BSP	ELL112030WH	£120.00



CUSTOM
COLOUR
OPTIONS
AVAILABLE
TO ORDER
see page 173

WHITE



CHROME



CHROME

LINEA - CHROME

FROM

£162.00

- Option of 3 heights and 3 widths giving a choice of 9 different sizes, Height - 750mm, 1120mm, 1700mm, Width - 400mm, 480mm, 600mm
- Individually air-tested to 16 bar
- 10 year guarantee

SIZE (H x W) mm	COLOUR	OUTPUT Watts/BTU	PIPE CENTRES (mm)		SUMMER ELEMENT	TAPPINGS	PRODUCT CODE	PRICE
			RADIATOR	FROM WALL				
750 x 400	CHROME	207/707	350	62 - 87	150	½" BSP	ELL075040CP	£162.00
750 x 480	CHROME	241/824	430	62 - 87	150	½" BSP	ELL075048CP	£168.00
750 x 600	CHROME	293/999	550	62 - 87	150	½" BSP	ELL075060CP	£174.00
1120 x 400	CHROME	301/1028	350	62 - 87	300	½" BSP	ELL112040CP	£243.00
1120 x 480	CHROME	350/1196	430	62 - 87	300	½" BSP	ELL112048CP	£249.00
1120 x 600	CHROME	424/1447	550	62 - 87	300	½" BSP	ELL112060CP	£258.00
1700 x 400	CHROME	465/1588	350	62 - 87	600	½" BSP	ELL170040CP	£375.00
1700 x 480	CHROME	542/1851	430	62 - 87	600	½" BSP	ELL170048CP	£378.00
1700 x 600	CHROME	658/2244	550	62 - 87	600	½" BSP	ELL170060CP	£396.00

LINEA - WHITE

FROM

£108.00

- Option of 3 heights and 3 widths giving a choice of 9 different sizes, Height - 750mm, 1120mm, 1700mm, Width - 400mm, 480mm, 600mm
- Custom colour options available to order
- Individually air-tested to 16 bar
- 10 year guarantee

SIZE (H x W) mm	COLOUR	OUTPUT Watts/BTU	PIPE CENTRES (mm)		SUMMER ELEMENT	TAPPINGS	PRODUCT CODE	PRICE
			RADIATOR	FROM WALL				
750 x 400	WHITE	269/919	350	62 - 87	150	½" BSP	ELL075040WH	£108.00
750 x 480	WHITE	314/1070	430	62 - 87	150	½" BSP	ELL075048WH	£108.00
750 x 600	WHITE	380/1297	550	62 - 87	150	½" BSP	ELL075060WH	£120.00
1120 x 400	WHITE	391/1335	350	62 - 87	300	½" BSP	ELL112040WH	£135.00
1120 x 480	WHITE	455/1553	430	62 - 87	300	½" BSP	ELL112048WH	£144.00
1120 x 600	WHITE	551/1879	550	62 - 87	300	½" BSP	ELL112060WH	£147.00
1700 x 400	WHITE	605/2063	350	62 - 87	600	½" BSP	ELL170040WH	£168.00
1700 x 480	WHITE	704/2403	430	62 - 87	600	½" BSP	ELL170048WH	£180.00
1700 x 600	WHITE	854/2914	550	62 - 87	600	½" BSP	ELL170060WH	£189.00

Optional towel hanger:

SIZE mm	COLOUR	PRODUCT CODE	PRICE
400	WHITE	ELAC-10-03WH	£27.00
480	WHITE	ELAC-10-05WH	£30.00
600	WHITE	ELAC-10-10WH	£30.00
400	CHROME	ELAC-10-03CP	£48.00
480	CHROME	ELAC-10-05CP	£48.00
600	CHROME	ELAC-10-10CP	£57.00

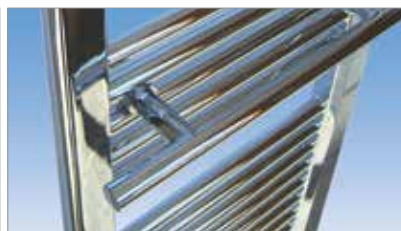

**CUSTOM
COLOUR
OPTIONS
AVAILABLE
TO ORDER**
see page 173



WHITE



RADIUS - CHROME

FROM

£210.00

- Option of 3 heights and 2 widths giving a choice of 6 different sizes, Height - 750mm, 1120mm, 1700mm, Width - 480mm, 600mm
- Individually air-tested to 16 bar
- 10 year guarantee

SIZE (H x W) mm	COLOUR	OUTPUT Watts/BTU	PIPE CENTRES (mm)		SUMMER ELEMENT	TAPPINGS	PRODUCT CODE	PRICE
			RADIATOR	FROM WALL				
750 x 480	CHROME	244/832	430	62 - 87	150	½" BSP	ELR075048CP	£210.00
750 x 600	CHROME	296/1009	550	62 - 87	150	½" BSP	ELR075060CP	£216.00
1120 x 480	CHROME	354/1208	430	62 - 87	300	½" BSP	ELR112048CP	£297.00
1120 x 600	CHROME	428/1462	550	62 - 87	300	½" BSP	ELR112060CP	£315.00
1700 x 480	CHROME	548/1869	430	62 - 87	600	½" BSP	ELR170048CP	£459.00
1700 x 600	CHROME	664/2266	550	62 - 87	600	½" BSP	ELR170060CP	£468.00

RADIUS - WHITE

FROM

£129.00

- Option of 3 heights and 2 widths giving a choice of 6 different sizes, Height - 750mm, 1120mm, 1700mm, Width - 480mm, 600mm
- Custom colour options available to order
- Individually air-tested to 16 bar
- 10 year guarantee

SIZE (H x W) mm	COLOUR	OUTPUT Watts/BTU	PIPE CENTRES (mm)		SUMMER ELEMENT	TAPPINGS	PRODUCT CODE	PRICE
			RADIATOR	FROM WALL				
750 x 480	WHITE	317/1081	430	62 - 87	150	½" BSP	ELR075048WH	£129.00
750 x 600	WHITE	384/1310	550	62 - 87	150	½" BSP	ELR075060WH	£135.00
1120 x 480	WHITE	460/1569	430	62 - 87	300	½" BSP	ELR112048WH	£159.00
1120 x 600	WHITE	556/1898	550	62 - 87	300	½" BSP	ELR112060WH	£168.00
1700 x 480	WHITE	711/2427	430	62 - 87	600	½" BSP	ELR170048WH	£198.00
1700 x 600	WHITE	863/2943	550	62 - 87	600	½" BSP	ELR170060WH	£210.00

Optional towel hanger:

SIZE mm	COLOUR	PRODUCT CODE	PRICE
480	WHITE	ELAC-10-30WH	£33.00
600	WHITE	ELAC-10-35WH	£36.00
480	CHROME	ELAC-10-30CP	£60.00
600	CHROME	ELAC-10-35CP	£66.00



**CUSTOM
COLOUR
OPTIONS
AVAILABLE
TO ORDER
see page 173**



WHITE



CHROME

QUADRIS - CHROME

FROM

£354.00

- 3 height options available - 800mm, 1200mm, 1600mm
- Width - 500mm
- Individually air-tested to 16 bar
- 10 year guarantee

SIZE (H x W) mm	COLOUR	OUTPUT Watts/BTU	PIPE CENTRES (mm)		SUMMER ELEMENT	TAPPINGS	PRODUCT CODE	PRICE
			RADIATOR	FROM WALL				
800 x 500	CHROME	301/1028	470	65	150	½" BSP	ELQU080050CP	£354.00
1200 x 500	CHROME	431/1472	470	65	300	½" BSP	ELQU120050CP	£450.00
1600 x 500	CHROME	561/1916	470	65	600	½" BSP	ELQU160050CP	£546.00

QUADRIS - ANTHRACITE

FROM

£216.00

- 3 height options available - 800mm, 1200mm, 1600mm
- Width - 500mm
- Available from stock in Anthracite
- Individually air-tested to 16 bar
- 10 year guarantee

SIZE (H x W) mm	COLOUR	OUTPUT Watts/BTU	PIPE CENTRES (mm)		SUMMER ELEMENT	TAPPINGS	PRODUCT CODE	PRICE
			RADIATOR	FROM WALL				
800 x 500	ANTHRACITE	372/1269	470	65	150	½" BSP	ELQU080050AN	£216.00
1200 x 500	ANTHRACITE	532/1816	470	65	300	½" BSP	ELQU120050AN	£270.00
1600 x 500	ANTHRACITE	693/2364	470	65	600	½" BSP	ELQU160050AN	£348.00

QUADRIS - TERRA MATT

FROM

£216.00

- 3 height options available - 800mm, 1200mm, 1600mm
- Width - 500mm
- Individually air-tested to 16 bar
- 10 year guarantee

SIZE (H x W) mm	COLOUR	OUTPUT Watts/BTU	PIPE CENTRES (mm)		SUMMER ELEMENT	TAPPINGS	PRODUCT CODE	PRICE
			RADIATOR	FROM WALL				
800 x 500	TERRA MATT	372/1269	470	65	150	½" BSP	ELQU080050TM	£216.00
1200 x 500	TERRA MATT	532/1816	470	65	300	½" BSP	ELQU120050TM	£288.00
1600 x 500	TERRA MATT	693/2364	470	65	600	½" BSP	ELQU160050TM	£366.00

Optional towel hanger:

SIZE mm	PRODUCT CODE	PRICE
500	ELAC-10-40CP	£90.00



**CUSTOM
COLOUR
OPTIONS
AVAILABLE
TO ORDER**
see page 173



CHROME



ANTHRACITE



TERRA MATT

PLANA - CHROME

FROM

£378.00

- 3 height options available - 800mm, 1200mm, 1600mm
- Width - 500mm
- Individually air-tested to 16 bar
- 10 year guarantee

SIZE (H x W) mm	COLOUR	OUTPUT Watts/BTU	PIPE CENTRES (mm)		SUMMER ELEMENT	TAPPINGS	PRODUCT CODE	PRICE
			RADIATOR	FROM WALL				
800 x 500	CHROME	214/729	465	68	150	½" BSP	ELPL080050CP	£378.00
1200 x 500	CHROME	320/1093	465	68	300	½" BSP	ELPL120050CP	£477.00
1600 x 500	CHROME	404/1378	465	68	600	½" BSP	ELPL160050CP	£594.00

PLANA - ANTHRACITE

FROM

£237.00

- 3 height options available - 800mm, 1200mm, 1600mm
- Width - 500mm
- Custom colour options available to order
- Individually air-tested to 16 bar
- 10 year guarantee

SIZE (H x W) mm	COLOUR	OUTPUT Watts/BTU	PIPE CENTRES (mm)		SUMMER ELEMENT	TAPPINGS	PRODUCT CODE	PRICE
			RADIATOR	FROM WALL				
800 x 500	ANTHRACITE	263/899	465	68	150	½" BSP	ELPL080050AN	£237.00
1200 x 500	ANTHRACITE	395/1348	465	68	300	½" BSP	ELPL120050AN	£288.00
1600 x 500	ANTHRACITE	498/1700	465	68	600	½" BSP	ELPL160050AN	£357.00

PLANA - BEIGE TEXTURED

FROM

£249.00

- 3 height options available - 800mm, 1200mm, 1600mm
- Width - 500mm
- Custom colour options available to order
- Individually air-tested to 16 bar
- 10 year guarantee

SIZE (H x W) mm	COLOUR	OUTPUT Watts/BTU	PIPE CENTRES (mm)		SUMMER ELEMENT	TAPPINGS	PRODUCT CODE	PRICE
			RADIATOR	FROM WALL				
800 x 500	BEIGE TEXTURED	263/899	465	68	150	½" BSP	ELPL080050BT	£249.00
1200 x 500	BEIGE TEXTURED	395/1348	465	68	300	½" BSP	ELPL120050BT	£297.00
1600 x 500	BEIGE TEXTURED	498/1700	465	68	600	½" BSP	ELPL160050BT	£366.00



**CUSTOM
COLOUR
OPTIONS
AVAILABLE
TO ORDER**
see page 173

ANTHRACITE



BEIGE TEXTURED



TIEMPO - CHROME

FROM
£327.00

- Option of 3 heights and 2 widths giving a choice of 6 different sizes
- Height - 900mm, 1400mm, 1800mm, Width - 380mm, 590mm
- Individually air-tested to 16 bar
- 10 year guarantee

SIZE (H x W) mm	COLOUR	OUTPUT Watts/BTU	PIPE CENTRES (mm)		SUMMER ELEMENT	TAPPINGS	PRODUCT CODE	PRICE
			RADIATOR	FROM WALL				
900 x 380	CHROME	244/834	VALVE DEPENDENT	68	N/A	½" BSP	ELT090038CP	£327.00
900 x 590	CHROME	379/1294	VALVE DEPENDENT	68	N/A	½" BSP	ELT090059CP	£357.00
1400 x 380	CHROME	364/1243	VALVE DEPENDENT	68	N/A	½" BSP	ELT140038CP	£498.00
1400 x 590	CHROME	566/1931	VALVE DEPENDENT	68	N/A	½" BSP	ELT140059CP	£558.00
1800 x 380	CHROME	460/1571	VALVE DEPENDENT	68	N/A	½" BSP	ELT180038CP	£669.00
1800 x 590	CHROME	716/2441	VALVE DEPENDENT	68	N/A	½" BSP	ELT180059CP	£729.00

TIEMPO - WHITE

FROM
£180.00

- Option of 3 heights and 2 widths giving a choice of 6 different sizes
- Height - 900mm, 1400mm, 1800mm, Width - 380mm, 590mm
- Custom colour options available to order
- Individually air-tested to 16 bar
- 10 year guarantee

SIZE (H x W) mm	COLOUR	OUTPUT Watts/BTU	PIPE CENTRES (mm)		SUMMER ELEMENT	TAPPINGS	PRODUCT CODE	PRICE
			RADIATOR	FROM WALL				
900 x 380	WHITE	317/1083	VALVE DEPENDENT	68	N/A	½" BSP	ELT090038WH	£180.00
900 x 590	WHITE	492/1680	VALVE DEPENDENT	68	N/A	½" BSP	ELT090059WH	£198.00
1400 x 380	WHITE	473/1615	VALVE DEPENDENT	68	N/A	½" BSP	ELT140038WH	£240.00
1400 x 590	WHITE	735/2508	VALVE DEPENDENT	68	N/A	½" BSP	ELT140059WH	£267.00
1800 x 380	WHITE	598/2040	VALVE DEPENDENT	68	N/A	½" BSP	ELT180038WH	£279.00
1800 x 590	WHITE	929/3171	VALVE DEPENDENT	68	N/A	½" BSP	ELT180059WH	£318.00

Optional towel hanger:

SIZE mm	COLOUR	PRODUCT CODE	PRICE
380	WHITE	ELAC-10-15WH	£30.00
590	WHITE	ELAC-10-20WH	£36.00
380	CHROME	ELAC-10-15CP	£48.00
590	CHROME	ELAC-10-20CP	£57.00



**CUSTOM
 COLOUR
 OPTIONS
 AVAILABLE
 TO ORDER
 see page 173**





TIEMPO - GLOSS ANTHRACITE

FROM

£399.00

gloss anthracite

- Option of 2 sizes (H x W), 1800mm x 380mm, 1800mm x 590mm
- Available as heating only
- 10 year guarantee

SIZE (H x W) mm	COLOUR	OUTPUT Watts/BTU	PIPE CENTRES (mm)		SUMMER ELEMENT	TAPPINGS	PRODUCT CODE	PRICE
			RADIATOR	FROM WALL				
1800 x 380	GLOSS ANTHRACITE	598/2040	VALVE DEPENDENT	68	N/A	½" BSP	ELT180038AN	£399.00
1800 x 590	GLOSS ANTHRACITE	929/3171	VALVE DEPENDENT	68	N/A	½" BSP	ELT180059AN	£499.00

TIEMPO - TERRA MATT

FROM

£399.00

terra matt

- Option of 2 sizes (H x W), 1800mm x 380mm, 1800mm x 590mm
- Available in Terra Matt
- 10 year guarantee

SIZE (H x W) mm	COLOUR	OUTPUT Watts/BTU	PIPE CENTRES (mm)		SUMMER ELEMENT	TAPPINGS	PRODUCT CODE	PRICE
			RADIATOR	FROM WALL				
1800 x 380	TERRA MATT	598/2040	VALVE DEPENDENT	68	N/A	½" BSP	ELT180038TM	£399.00
1800 x 590	TERRA MATT	929/3171	VALVE DEPENDENT	68	N/A	½" BSP	ELT180059TM	£499.00

Optional chrome towel hanger:

SIZE mm	COLOUR	PRODUCT CODE	PRICE
380	CHROME	ELAC-10-15CP	£44.50
590	CHROME	ELAC-10-20CP	£48.00





GLOSS ANTHRACITE

SHEER

(ELS140048AN)

- Option of 2 heights and 2 widths giving a choice of 4 different sizes
- Height - 1400mm, 1700mm, Width - 360mm, 480mm
- Custom colour options available to order
- Individually air-tested to 16 bar
- 10 year guarantee

FROM
£348.00

SIZE (H x W) mm	COLOUR	OUTPUT Watts/BTU	PIPE CENTRES (mm) RADIATOR	FROM WALL	SUMMER ELEMENT	TAPPINGS	PRODUCT CODE	PRICE
1400 x 360	WHITE	541/1845	VALVE DEPENDENT	65	N/A	½" BSP	ELS140036WH	£348.00
1400 x 480	WHITE	712/2429	VALVE DEPENDENT	65	N/A	½" BSP	ELS140048WH	£399.00
1700 x 360	WHITE	655/2236	VALVE DEPENDENT	65	N/A	½" BSP	ELS170036WH	£390.00
1700 x 480	WHITE	862/2942	VALVE DEPENDENT	65	N/A	½" BSP	ELS170048WH	£438.00
1400 x 360	ANTHRACITE	514/1753	VALVE DEPENDENT	65	N/A	½" BSP	ELS140036AN	£474.00
1400 x 480	ANTHRACITE	676/2307	VALVE DEPENDENT	65	N/A	½" BSP	ELS140048AN	£570.00
1700 x 360	ANTHRACITE	622/2124	VALVE DEPENDENT	65	N/A	½" BSP	ELS170036AN	£534.00
1700 x 480	ANTHRACITE	819/2795	VALVE DEPENDENT	65	N/A	½" BSP	ELS170048AN	£594.00

Optional towel hanger:

SIZE mm	COLOUR	PRODUCT CODE	PRICE
350	POLISHED S/S	ELAC-10-25PS	£74.00



WHITE



CUSTOM
COLOUR
OPTIONS
AVAILABLE
TO ORDER
see page 173

LAZO

(ELLA140065CP)

- Available in 2 sizes
- Available in Chrome finish only
- Individually air-tested to 16 bar
- 10 year guarantee
- Can be mounted left or right handed

FROM
£261.00



SIZE (H x W) mm	OUTPUT Watts/BTU	PIPE CENTRES (mm)		SUMMER ELEMENT	TAPPINGS	PRODUCT CODE	PRICE
		RADIATOR	FROM WALL				
1000 x 500	228/778	72	60	N/A	½" BSP	ELLA100050CP	£261.00
1400 x 650	362/1235	72	60	N/A	½" BSP	ELLA140065CP	£345.00

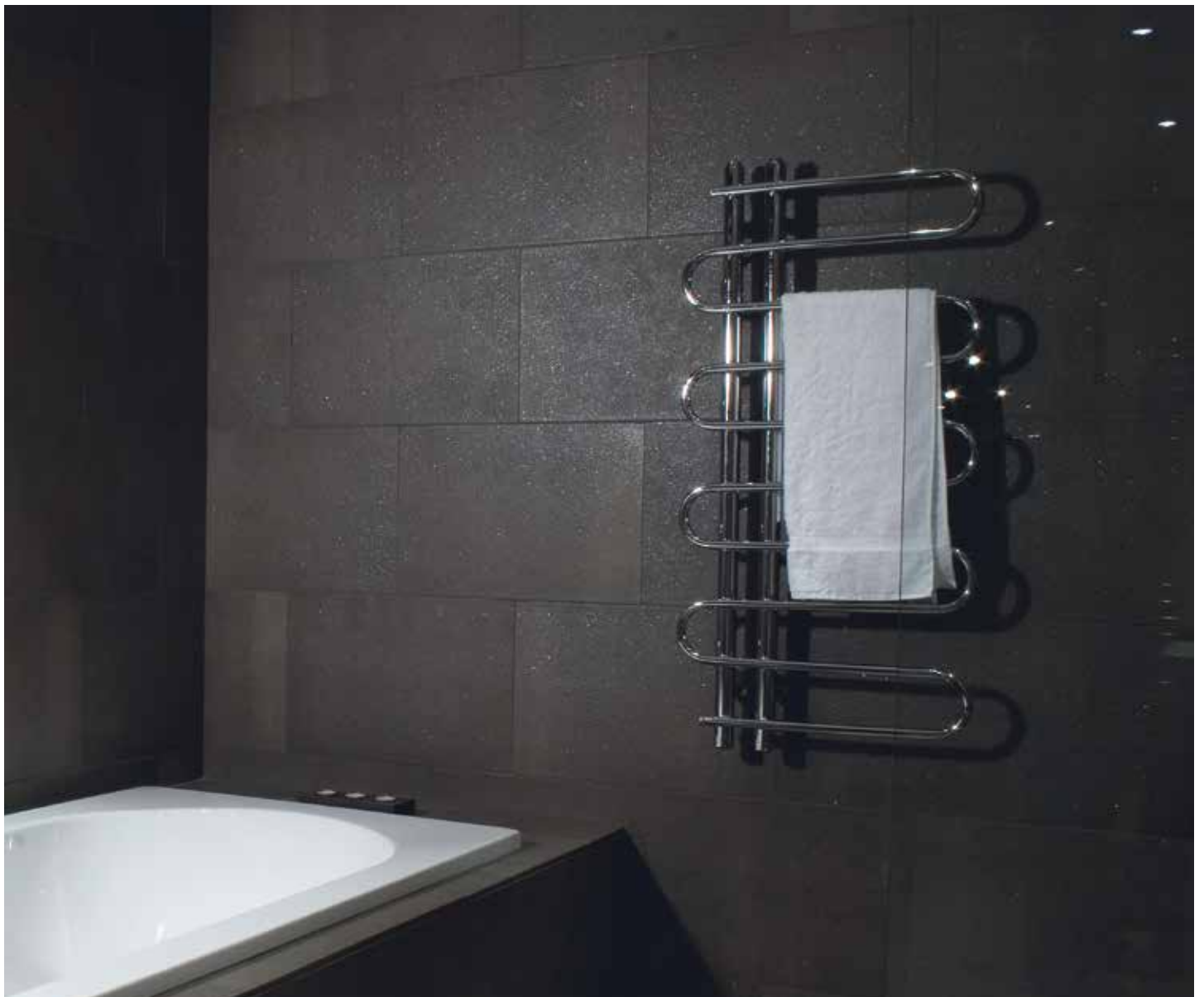

STRATO

(ELST084048CP)

- Option of 3 heights and 2 widths giving a choice of 6 different sizes
- Available in Chrome finish only
- Height - 840mm, 1250mm, 1700mm, Width - 480mm, 600mm
- Individually air-tested to 16 bar
- 10 year guarantee

FROM

£249.00

SIZE (H x W) mm	OUTPUT Watts/BTU	PIPE CENTRES (mm)		SUMMER ELEMENT	TAPPINGS	PRODUCT CODE	PRICE
		RADIATOR	FROM WALL				
840 x 480	289/985	440	40	150	½" BSP	ELST084048CP	£249.00
840 x 600	346/1182	560	40	150	½" BSP	ELST084060CP	£255.00
1250 x 480	411/1403	440	40	300	½" BSP	ELST125048CP	£369.00
1250 x 600	491/1676	560	40	300	½" BSP	ELST125060CP	£375.00
1700 x 480	546/1864	440	40	600	½" BSP	ELST170048CP	£558.00
1700 x 600	652/2225	560	40	600	½" BSP	ELST170060CP	£579.00



Towel Warmers & Radiators

ELEGANCE MILD STEEL
TRADITIONAL



FARTHING

(ELFA068068CP)

- Available in Chrome only
- Individually air-tested to 16 bar
- 10 year guarantee

£339.00



SIZE (H x W) mm	OUTPUT Watts/BTU	PIPE CENTRES (mm)		SUMMER ELEMENT	TAPPINGS	PRODUCT CODE	PRICE
		RADIATOR	FROM WALL				
674 x 674	171/583	600	50	N/A	½" BSP	ELFA068068CP	£339.00

SHILLING

(ELSH095068CP)

- Available in Chrome only
- Individually air-tested to 16 bar
- 10 year guarantee

£348.00



SIZE (H x W) mm	OUTPUT Watts/BTU	PIPE CENTRES (mm)		SUMMER ELEMENT	TAPPINGS	PRODUCT CODE	PRICE
		RADIATOR	FROM WALL				
950 x 600	232/792	VALVE DEPENDENT	105	N/A	½" BSP	ELSH095068CP	£348.00

CROWN

(ELCR077068CP)

- Available in Chrome only
- Individually air-tested to 16 bar
- 10 year guarantee

£780.00



SIZE (H x W) mm	OUTPUT Watts/BTU	PIPE CENTRES (mm)		SUMMER ELEMENT	TAPPINGS	PRODUCT CODE	PRICE
		RADIATOR	FROM WALL				
778 x 686	489/1669	VALVE DEPENDENT	VARIABLE	N/A	½" BSP	ELCR077068CP	£780.00

HALF SOVEREIGN

(ELHS095050CP)

- Available in Chrome only
- The centre section of this rail is in a white finish
- Individually air-tested to 16 bar
- 10 year guarantee

£465.00



SIZE (H x W) mm	OUTPUT Watts/BTU	PIPE CENTRES (mm)		SUMMER ELEMENT	TAPPINGS	PRODUCT CODE	PRICE
		RADIATOR	FROM WALL				
960 x 500	680/2320	VALVE DEPENDENT	120	N/A	½" BSP	ELHS095050CP	£465.00

SOVEREIGN

(ELSO095068CP)

- Available in Chrome only
- The centre section of this rail is in a white finish
- Individually air-tested to 16 bar
- 10 year guarantee

£489.00



SIZE (H x W) mm	OUTPUT Watts/BTU	PIPE CENTRES (mm)		SUMMER ELEMENT	TAPPINGS	PRODUCT CODE	PRICE
		RADIATOR	FROM WALL				
940 x 674	980/3344	VALVE DEPENDENT	120	N/A	½" BSP	ELSO095068CP	£489.00

The benefits of stainless steel – lifetime guarantee

Leading the way in the UK's expanding stainless steel market



LIFE CYCLE

A durable and low maintenance material, stainless steel will last a lifetime and in the long run will often turn out to be the most inexpensive option.



HEAT OUTPUT

Offers a higher output than equivalent sizes in chrome finish.



CORROSION RESISTANCE

A robust material offering high resistance to chemicals and pressures.



RESISTANCE TO EXTREME TEMPERATURES

Stainless steel has the ability to withstand extreme temperature fluctuations.



AESTHETIC APPEAL

A range of radiators in both polished and brushed stainless steel which are timeless in their beauty and function.



IDEAL FOR COMMERCIAL PROJECTS

Stainless steel is a perfect material for commercial projects.



**ALL OUR STAINLESS STEEL
RADIATORS AND TOWEL WARMERS
ARE HANDMADE FOR A
LIFETIME GUARANTEE**



Towel Warmers & Radiators

ELEGANCE STAINLESS STEEL



MICRO LINEA S

FROM
£269.00

- Polished stainless steel
- Lifetime guarantee
- Option of 2 sizes (H x W), 600mm x 300mm, 1120mm x 300mm

SIZE (H x W) mm	OUTPUT Watts/BTU	PIPE CENTRES (mm)		SUMMER ELEMENT	TAPPINGS	PRODUCT CODE	PRICE
		RADIATOR	FROM WALL				
600 x 300	149/508	262	62 - 87	75	½" BSP	ELL060030PS	£269.00
1120 x 300	260/887	262	62 - 87	150	½" BSP	ELL112030PS	£369.00



LINEA S

FROM
£339.00

- Polished stainless steel
- Lifetime guarantee
- Option of 9 sizes

SIZE (H x W) mm	OUTPUT Watts/BTU	PIPE CENTRES (mm)		SUMMER ELEMENT	TAPPINGS	PRODUCT CODE	PRICE
		RADIATOR	FROM WALL				
750 x 400	223/761	368	62 - 87	150	½" BSP	ELL075040PS	£339.00
750 x 480	261/891	442	62 - 87	150	½" BSP	ELL075048PS	£359.00
750 x 600	317/1082	562	62 - 87	150	½" BSP	ELL075060PS	£429.00
1120 x 400	329/1123	368	62 - 87	300	½" BSP	ELL112040PS	£459.00
1120 x 480	384/1310	442	62 - 87	300	½" BSP	ELL112048PS	£489.00
1120 x 600	466/1590	562	62 - 87	300	½" BSP	ELL112060PS	£599.00
1700 x 400	494/1686	368	62 - 87	600	½" BSP	ELL170040PS	£699.00
1700 x 480	577/1969	442	62 - 87	600	½" BSP	ELL170048PS	£749.00
1700 x 600	700/2388	562	62 - 87	600	½" BSP	ELL170060PS	£849.00

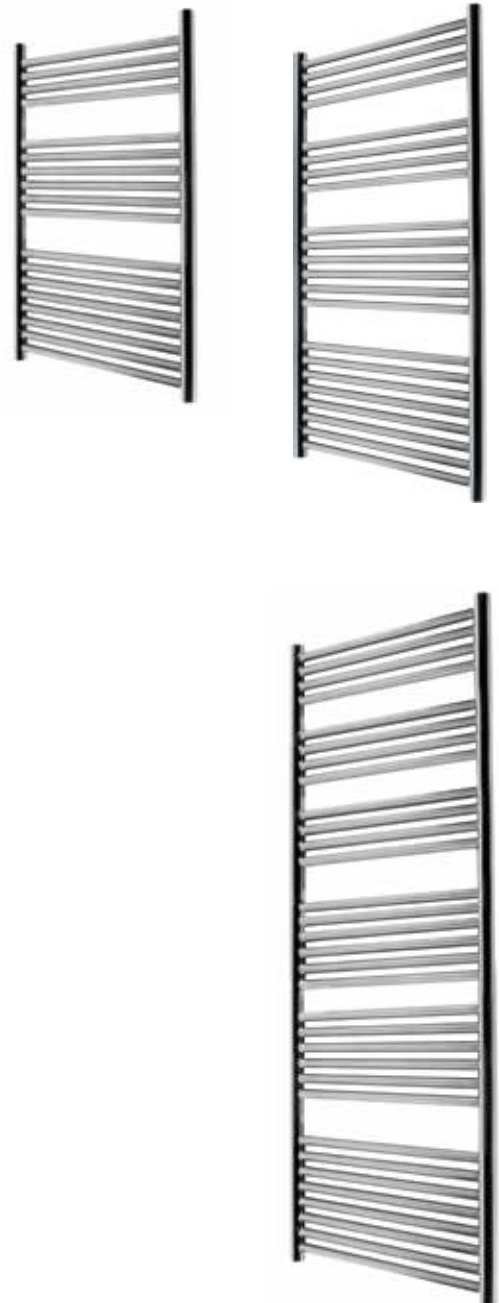

PROFILE

FROM
£299.00

- Polished stainless steel
- Lifetime guarantee
- Option of 4 sizes

SIZE (H x W) mm	OUTPUT Watts/BTU	PIPE CENTRES (mm)		SUMMER ELEMENT	TAPPINGS	PRODUCT CODE	PRICE
		RADIATOR	FROM WALL				
700 x 500	179/611	470	65	150	½" BSP	ELPR070050PS	£299.00
700 x 600	206/703	570	65	150	½" BSP	ELPR070060PS	£319.00
1250 x 500	305/1041	470	65	300	½" BSP	ELPR125050PS	£399.00
1250 x 600	350/1194	570	65	300	½" BSP	ELPR125060PS	£469.00



RADIUS S

FROM

£419.00

- Polished stainless steel
- Lifetime guarantee
- Option of 6 sizes

SIZE (H x W) mm	OUTPUT Watts/BTU	PIPE CENTRES (mm)		SUMMER ELEMENT	TAPPINGS	PRODUCT CODE	PRICE
		RADIATOR	FROM WALL				
750 x 480	263/897	442	62 - 87	150	½" BSP	ELR075048PS	£419.00
750 x 600	320/1092	562	62 - 87	150	½" BSP	ELR075060PS	£499.00
1120 x 480	388/1324	442	62 - 87	300	½" BSP	ELR112048PS	£569.00
1120 x 600	420/1432	562	62 - 87	300	½" BSP	ELR112060PS	£699.00
1700 x 480	583/1989	442	62 - 87	600	½" BSP	ELR170048PS	£849.00
1700 x 600	707/2412	562	62 - 87	600	½" BSP	ELR170060PS	£899.00



CALA

FROM

£849.00

- Polished stainless steel
- Lifetime guarantee
- Option of 2 sizes (H x W), 1225mm x 480mm, 1750mm x 480mm

SIZE (H x W) mm	OUTPUT Watts/BTU	PIPE CENTRES (mm)		SUMMER ELEMENT	TAPPINGS	PRODUCT CODE	PRICE
		RADIATOR	FROM WALL				
1225 x 480	523/1788	440	65	150	½" BSP	BDLRD-05-05PS	£849.00
1750 x 480	746/2536	440	65	300	½" BSP	BDLRD-05-10PS	£989.00





KUBIK MINI

FROM
£899.00

- Polished stainless steel
- Lifetime guarantee
- Option of 3 sizes (H x W), 900mm x 500mm, 1150mm x 500mm, 1400mm x 500mm

SIZE (H x W) mm	OUTPUT Watts/BTU	PIPE CENTRES (mm)		SUMMER ELEMENT	TAPPINGS	PRODUCT CODE	PRICE
		RADIATOR	FROM WALL				
900 x 500	588/1999	460	65	300	½" BSP	BDLRD-20-05PS	£899.00
1150 x 500	738/2509	460	65	300	½" BSP	BDLRD-20-10PS	£1,099.00
1400 x 500	889/3023	460	65	600	½" BSP	BDLRD-20-15PS	£1,249.00



KUBIK

FROM
£799.00

- Polished stainless steel
- Lifetime guarantee
- Option of 3 sizes (H x W), 900mm x 500mm, 1170mm x 500mm, 1440mm x 500mm

SIZE (H x W) mm	OUTPUT Watts/BTU	PIPE CENTRES (mm)		SUMMER ELEMENT	TAPPINGS	PRODUCT CODE	PRICE
		RADIATOR	FROM WALL				
900 x 500	769/2615	460	65	300	½" BSP	BDLRD-15-05PS	£799.00
1170 x 500	850/2890	460	65	300	½" BSP	BDLRD-15-10PS	£999.00
1440 x 500	928/3155	460	65	600	½" BSP	BDLRD-15-15PS	£1,199.00





KOLONNA SQUARE

FROM

£1,949.00

- Polished stainless steel
- Lifetime guarantee
- Option of 2 sizes (H x W), 800mm x 780mm, 800mm x 975mm

SIZE (H x W) mm	OUTPUT Watts/BTU	PIPE CENTRES (mm)		SUMMER ELEMENT	TAPPINGS	PRODUCT CODE	PRICE
		RADIATOR	FROM WALL				
800 x 780	1385/4709	VALVEDEPENDENT	75	N/A	½" BSP	BDLRD-10-05PS	£1,949.00
800 x 975	1713/5824	VALVEDEPENDENT	75	N/A	½" BSP	BDLRD-10-10PS	£2,299.00

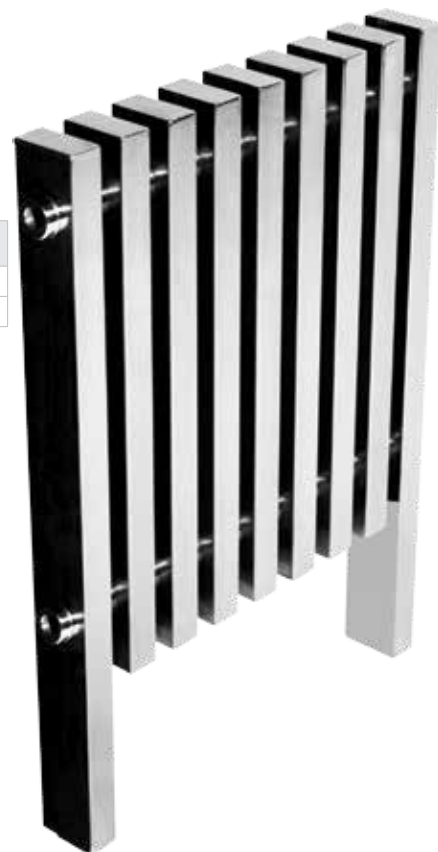

ZOLA

FROM

£1,099.00

- Brushed stainless steel
- Lifetime guarantee
- Option of 2 sizes (H x W), 1800mm x 290mm, 1800mm x 500mm
- Includes towel hanger

SIZE (H x W) mm	OUTPUT Watts/BTU	PIPE CENTRES (mm)		SUMMER ELEMENT	TAPPINGS	PRODUCT CODE	PRICE
		RADIATOR	FROM WALL				
1800 x 290	930/3170	VALVE DEPENDENT	48 - 63	N/A	½" BSP	BDLRD-25-05BS	£1,099.00
1800 x 500	1443/4922	VALVE DEPENDENT	48 - 63	N/A	½" BSP	BDLRD-25-10BS	£1,699.00



VIENTO

FROM
£849.00

- Brushed stainless steel
- Lifetime guarantee
- Option of 4 sizes

SIZE (H x W) mm	OUTPUT Watts/BTU	PIPE CENTRES (mm)		SUMMER ELEMENT	TAPPINGS	PRODUCT CODE	PRICE
		RADIATOR	FROM WALL				
1400 x 410	563/1921	VALVEDEPENDENT	75	N/A	½" BSP	ELVI140041BS	£849.00
1400 x 550	754/2573	VALVEDEPENDENT	75	N/A	½" BSP	ELVI140055BS	£989.00
1800 x 410	718/2450	VALVEDEPENDENT	75	N/A	½" BSP	ELVI180041BS	£1,099.00
1800 x 550	956/3262	VALVEDEPENDENT	75	N/A	½" BSP	ELVI180055BS	£1,249.00



Optional towel hanger:

SIZE mm	COLOUR	PRODUCT CODE	PRICE
350	POLISHED STAINLESS STEEL	ELAC-10-25PS	£59.00



TIERRA

FROM
£849.00

- Brushed stainless steel
- Lifetime guarantee
- Option of 3 sizes (H x W), 800mm x 500mm, 1200mm x 500mm, 1595mm x 500mm

SIZE (H x W) mm	OUTPUT Watts/BTU	PIPE CENTRES (mm)		SUMMER ELEMENT	TAPPINGS	PRODUCT CODE	PRICE
		RADIATOR	FROM WALL				
800 x 500	381/1300	380	75	150	½" BSP	ELTI080050BS	£849.00
1200 x 500	543/1853	380	75	300	½" BSP	ELTI120050BS	£1,199.00
1595 x 500	704/2402	380	75	600	½" BSP	ELTI159050BS	£1,349.00



AQUILA

FROM
£699.00

- Brushed stainless steel
- Lifetime guarantee
- Option of 2 sizes (H x W), 800mm x 500mm, 1200mm x 500mm

SIZE (H x W) mm	OUTPUT Watts/BTU	PIPE CENTRES (mm)		SUMMER ELEMENT	TAPPINGS	PRODUCT CODE	PRICE
		RADIATOR	FROM WALL				
800 x 500	555/1893	470	75	150	½" BSP	BDLRD-30-05BS	£699.00
1200 x 500	795/2712	470	75	300	½" BSP	BDLRD-30-10BS	£899.00





ROBE HOOK – LINEA/RADIUS/STRATO/TIEMPO

FROM
£15.00

SIZE/ TYPE	PRODUCT CODE	PRICE
WHITE	ELAC-05-05WH	£15.00
CHROME	ELAC-05-05CP	£18.00



PIPE INSTALLATION KIT

• Note: 2 x chrome-plated copper 15mm pipes (length 400mm) and flanges

£30.00

SIZE/ TYPE	PRODUCT CODE	PRICE
15mm CHROME PIPE KIT	ELAC-15-05CP	£30.00



LINEA TOWEL HANGER

FROM
£27.00

SIZE/ TYPE	PRODUCT CODE	PRICE
WHITE 400mm	ELAC-10-03WH	£27.00
WHITE 480mm	ELAC-10-05WH	£30.00
WHITE 600mm	ELAC-10-10WH	£30.00
CHROME 400mm	ELAC-10-03CP	£48.00
CHROME 480mm	ELAC-10-05CP	£48.00
CHROME 600mm	ELAC-10-10CP	£57.00



RADIUS TOWEL HANGER

FROM
£33.00

SIZE/ TYPE	PRODUCT CODE	PRICE
WHITE 480mm	ELAC-10-30WH	£33.00
WHITE 600mm	ELAC-10-35WH	£36.00
CHROME 480mm	ELAC-10-30CP	£60.00
CHROME 600mm	ELAC-10-35CP	£66.00



QUADRIS TOWEL HANGER

FROM
£69.00

SIZE/ TYPE	PRODUCT CODE	PRICE
ANTHRACITE 500	ELAC-10-40AN	£69.00
CHROME 500	ELAC-10-40CP	£87.00



TIEMPO TOWEL HANGER

FROM
£30.00

SIZE/ TYPE	PRODUCT CODE	PRICE
WHITE 380mm	ELAC-10-15WH	£30.00
WHITE 590mm	ELAC-10-20WH	£36.00
CHROME 380mm	ELAC-10-15CP	£48.00
CHROME 590mm	ELAC-10-20CP	£57.00



SHEER/VIENTO TOWEL HANGER

£72.00

SIZE/ TYPE	PRODUCT CODE	PRICE
POLISHED S/S 350MM	ELAC-10-25PS	£72.00



Electric Heating Options

There are two options for electrically heating towel warmers:

ELECTRIC ONLY

Factory filled and sealed with a special heating solution. Allows the towel rail to be fitted without connection to the central heating system.

(Please check summer element rating for your rail)

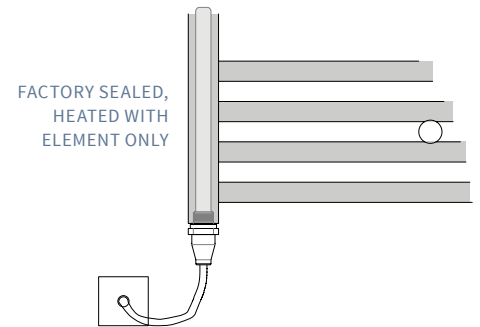

DUAL FUEL KITS

For heating towel warmers during summer months, or when the central heating system is turned off, supplied with a chrome T piece.

(Please check summer element rating for your rail)

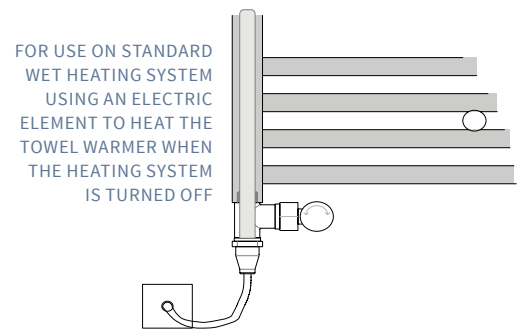

DISCLAIMER

When an electrical element is used to heat a towel warmer or radiator you will not get identical performance as you would connected to a central heating system. There is no circulation and it will therefore take longer to heat up and will be noticeably hotter near the element. After 1 to 2 hours of continuous use the heat would have spread but there will still be temperature variances across the surface. This is not a fault.

NOTE: All electrical elements carry a 12 month guarantee

Bathroom Zones & IP Ratings

The bathroom is divided into zones based on a level of risk. Each zone has specific requirements regarding the installation of electrical equipment in that zone. The diagram below is only a guide. Please refer to I.E.E. Wiring Regulations for detailed information.

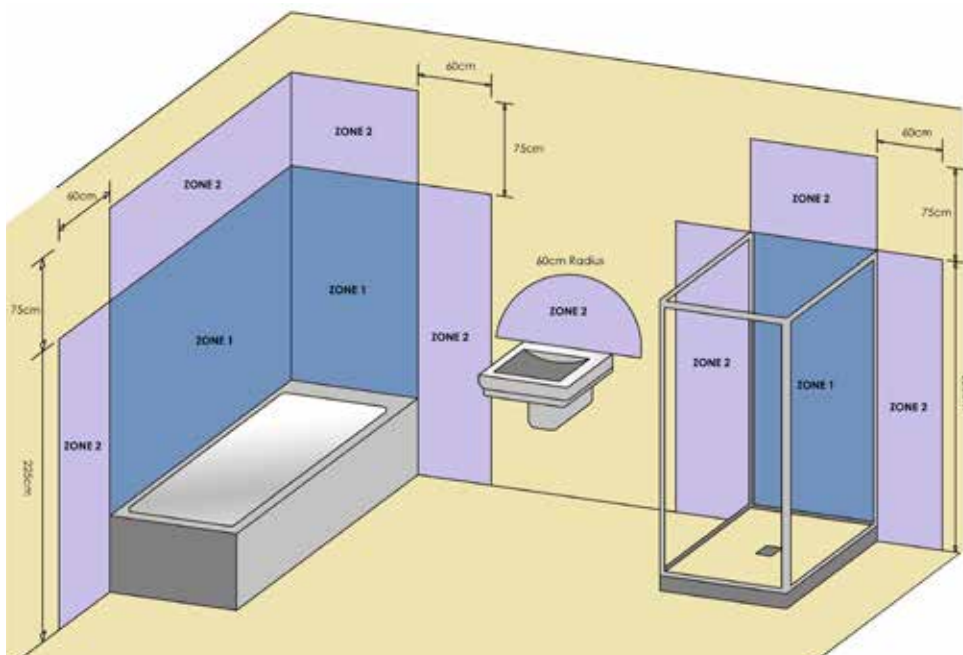

IP RATINGS

IP Rating: 'X' denotes level of security against dust particles. The second digit denotes level of 'watertightness'.

IPX5: protected against low pressure water jets.

IPX4: protected against splashing water.

ZONES

Zone 0: the area inside the bath, sink or shower tray. Not recommended for radiator fitting.

Zone 1: the area above the bath/shower tray to a height of 2.25m. Minimum rating of IPX4 should be used unless water spray will be present. In this case, a rating of IPX5 should be used.

Zone 2: the area stretching 0.6m from zone 1 and above the sink to a radius of 0.6m. Minimum rating of IPX4 should be used here.

Zone 3: the area outside zones 1 & 2. Assuming water jets are not to be used for cleaning this area, lower IP ratings can be used.

Types of Heating Elements

STANDARD ELEMENT

- NON-ADJUSTABLE (unless used with digital wall controller below)
- IP55 RATED (suitable for installation into IEE Zone 1, 2 or 3)
- PERFECT FOR USE WITH DIGITAL WALL CONTROLLER (see below)

With a standard heating element the wattage of the element is matched according to the size of the radiator. It will then heat the liquid inside the radiator and the heat is dispersed by the surface area of the radiator. It has the protection of a thermal 'cut out' should the element become too hot, however there is no control over the radiator or the room temperature.



STANDARD ELEMENT - ELECTRIC ONLY

WATTS	TYPE	PRODUCT CODE	PRICE
75W	Standard E75	ELEO-05-05WC	£120.00
150W	Standard E150	ELEO-05-10WC	£123.00
300W	Standard E300	ELEO-05-15WC	£126.00
600W	Standard E600	ELEO-05-20WC	£129.00

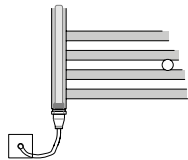

STANDARD ELEMENT - DUAL FUEL

WATTS	TYPE	PRODUCT CODE	PRICE
75W	Standard DE75	ELDF-05-05WC	£78.00
150W	Standard DE150	ELDF-05-10WC	£78.00
300W	Standard DE300	ELDF-05-15WC	£81.00
600W	Standard DE600	ELDF-05-20WC	£84.00

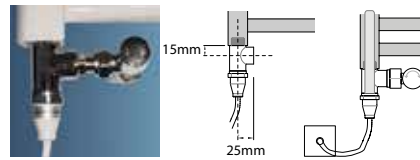

DUAL FUEL

Note: Valve centres when using a dual fuel element will alter. Please see central image (left) for dimensions.

DIGITAL WALL CONTROLLER

IP44

Option for use with standard element

- Digital Wall Controller with four button control plate
- CE Approved
- For use with standard elements
- Controls towel rail surface temperature
- Alternative to thermostatic element
- Fits standard UK single back box
- Temperature 'increase/decrease' buttons
- 'Eco' control reduces power consumption by 15% or more
- Can be fitted inside the bathroom

FROM
£96.00

TYPE	PRODUCT CODE	PRICE
Digital Wall Controller White	ELAC-20-05WH	£99.00
Digital Wall Controller Chrome	ELAC-20-05CP	£96.00



Types of Heating Elements

BLUETOOTH ELEMENT

- Bluetooth connectivity
- Next generation controller
- 24/7 programming via dedicated app (Android & iOS)
- Compact design
- Manual override boost mode
- IPX4
- Energy consumption data via app

BLUETOOTH ELEMENT - ELECTRIC ONLY

WATTS	TYPE	PRODUCT CODE	PRICE
150W	Chrome	ELEO-30-15CP	£294.00
150W	White	ELEO-30-15WH	£276.00
300W	Chrome	ELEO-30-30CP	£299.00
300W	White	ELEO-30-30WH	£279.00



BLUETOOTH ELEMENT - DUAL FUEL

WATTS	FINISH	PRODUCT CODE	PRICE
150W	Chrome	ELDF-30-15CP	£264.00
150W	White	ELDF-30-15WH	£246.00
300W	Chrome	ELDF-30-30CP	£270.00
300W	White	ELDF-30-30WH	£249.00



The next generation of towel warmer control



Towel Warmer Care

It is very important for the care and guarantee of your towel warmer that it is looked after in the following two ways:

1. INTERNAL PROTECTION OF THE TOWEL WARMER / HEATING SYSTEM

It is a requirement of our guarantee (and all new heating systems) that the water within a heating system is cleaned and protected in accordance with BS7593. This is very important for all components of the heating system in addition to the towel warmer.

Abacus recommend the use of Fernox water treatment chemicals for the protection of our towel warmers. Fernox are world leaders in the treatment of heating systems. To protect a system in accordance with BS7593 the system should first be flushed with Fernox F5 cleanser (or similar) and then re-filled with the addition of Fernox F1 Protector (or similar).



Eliminating magnetite

If your heating system suffers from magnetite (black sludge) we would recommend the installation of a Fernox TF1 Magnetic Filter which will not only protect your towel warmer and radiators but also make your heating system more efficient.

Magnetite (sludge) is a major problem with many heating systems and is caused by a build-up of oxides within the heating system. This can largely be eliminated by the installation of a Fernox TF1 Magnetic Filter. These filters will not only enhance the efficiency of a heating system but also remove the harmful and corrosive magnetite which is a major cause of problems and failures. This is available in an 'installer pack' and comes complete with the F1 inhibitor and F5 cleanser which are required for protecting the system.



FOR PRICING, PLEASE SEE OUR 'PARTNER BRANDS' SECTION (Page 338)

2. EXTERNAL CLEANING AND PROTECTION OF THE SURFACE FINISH

It is very important that consumers are aware that chrome, stainless steel and painted towel warmers are not self-cleaning.

Mains water can often contain many oxides and if a towel warmer is left wet for long periods of time then surface oxidation (rust) can form on the surface of the product. This can be avoided by using the cleaner supplied with your towel warmer as a sample.

It is important that towel warmers are periodically cleaned externally to maintain the finish of the chrome, painted or stainless steel. For this purpose, we supply a sample of Peek surface polishing chemical with all our towel warmers from new.

Further quantities of this can be purchased as detailed opposite. Just like cleaning the chrome parts on a car this cleaner is designed to protect surface finishes from chemical attack in a damp environment.

DESCRIPTION	PRODUCT CODE	PRICE
Peek Metal Polish 100ml tube	ELSP-25-0010	£9.00



Bespoke Colour Options

Pick a colour...any colour!

TOWEL WARMER COLOUR OPTIONS

We can supply any of our powder coated radiators or towel warmers in a RAL colour of your choice. For a fixed price, regardless of model or size, we can powder coat in any RAL colour. Delivery normally takes 7 to 10 days and all you need to do is order a standard colour product with a custom colour option and tell us the RAL code that you require. For example;



1 x ELR112060WH Radius
1120mm x 600mm White

£168.00

Select the custom RAL colour of
your choice (e.g. Traffic Red)



Traffic Red
RAL 3020

1 x ELAC-80-0000 Custom Colour Option
RAL3020 Red

£120.00



1 x ELR112060WH Radius
1120mm x 600mm in Bespoke Traffic Red

£288.00

PLEASE NOTE::

Custom colour option items are specially made to order and cannot be cancelled or returned. Unless otherwise specified, custom colour towel warmers will be supplied with chrome-finished brackets.

DESCRIPTION	PRODUCT CODE	PRICE
Custom Colour Option	ELAC-80-0000	£120.00





Radiator Valves

ULTIMA



ULTIMA SQUARE VALVE

FROM
£41.50

DESCRIPTION	CODE	PRICE
15mm ANGLED CHROME	ULRV-35-0505	£41.50 (EACH)
15mm ANGLED BRUSHED	ULRV-35-5005	£47.50 (EACH)
15mm ANGLED BLACK	ULRV-35-5505	£49.50 (EACH)



CHROME



BRUSHED
NICKEL



BLACK
NICKEL



ULTIMA CORNER VALVE SET (PAIR)

£34.50

DESCRIPTION	CODE	PRICE
CHROME	ULRV-45-0505	£34.50



ULTIMA STANDARD VALVE

FROM
£4.70

DESCRIPTION	CODE	PRICE
10mm WHEELHEAD ANGLED	ULRV-05-0505	£4.70 (EACH)
10mm LOCKSHIELD ANGLED	ULRV-05-0510	£4.70 (EACH)
15mm WHEELHEAD ANGLED	ULRV-05-0515	£4.70 (EACH)
15mm LOCKSHIELD ANGLED	ULRV-05-0520	£4.70 (EACH)
15mm WHEELHEAD STRAIGHT	ULRV-05-0535	£5.90 (EACH)
15mm LOCKSHIELD STRAIGHT	ULRV-05-0540	£5.90 (EACH)



ULTIMA ARC VALVE

£17.50

DESCRIPTION	CODE	PRICE
15mm WHEELHEAD ANGLED	ULRV-20-0505	£17.50 (EACH)
15mm WHEELHEAD STRAIGHT	ULRV-20-0510	£17.50 (EACH)



ULTIMA QUATTRO VALVE

FROM
£23.50

DESCRIPTION	CODE	PRICE
15mm WHEELHEAD ANGLED	ULRV-25-0505	£23.50 (EACH)
15mm WHEELHEAD STRAIGHT	ULRV-25-0510	£24.50 (EACH)



ULTIMA TRADITIONAL VALVE

£18.50

DESCRIPTION	CODE	PRICE
15mm TRADITIONAL ANGLED	ULRV-40-0505	£18.50 (EACH)



ULTIMA THERMOSTATIC VALVE PACK STRAIGHT TRV8

FROM
£46.50

DESCRIPTION	PRODUCT CODE	PRICE
10/15mm CHROME	ULRV-50-0510	£46.50
10/15mm BRUSHED NICKEL	ULRV-50-5010	£58.50
10/15mm BLACK NICKEL	ULRV-50-5510	£63.00



- Larger valve body
- Designer lockshield valve



ULTIMA THERMOSTATIC VALVE PACK CORNER TRV8

FROM
£45.00

DESCRIPTION	PRODUCT CODE	PRICE
15mm CHROME	ULRV-45-0510	£45.00
15mm BRUSHED NICKEL	ULRV-45-5010	£53.50
15mm BLACK NICKEL	ULRV-45-5510	£58.50



- Larger valve body
- Designer lockshield valve



ULTIMA THERMOSTATIC VALVE PACK ANGLED TRV8

FROM
£46.50

DESCRIPTION	PRODUCT CODE	PRICE
10/15mm CHROME	ULRV-50-0505	£46.50
10/15mm BRUSHED NICKEL	ULRV-50-5005	£58.50
10/15mm BLACK NICKEL	ULRV-50-5505	£63.00



- Larger valve body
- Designer lockshield valve

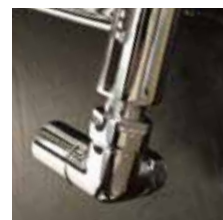

Complete Sanitary Fixing Solutions

- Easi-plan is an ultra flexible range of concealed sanitaryware installation frames that allow the bathroom designer to design with flair and imagination with no need to compromise installation quality.
- The hidden frames cover all aspects of sanitaryware and brassware installation including WCs, basins and bidets. They create a pre-wall fixing system eliminating the need for unsightly pipe boxing and exposed pipes.
- Easi-plan has been designed specifically for the UK market and its innovative design and installation features make this the future of bathroom design.

PRE-WALL INSTALLATION PLANNING

The key to any stylish bathroom is in the planning. With Easi-plan any bathroom structure is possible and space can be used more efficiently. Some examples of innovative use of pre-wall design are shown opposite.



The Easi-plan range is not just restricted to sanitaryware fixing frames. Using the voids created by the Easi-plan frame offers the option of having stylish recessed natural timber cabinets to make maximum use of space within the bathroom. These offer vital storage space, an area often overlooked in bathrooms, whilst giving the room the ultimate designer look.

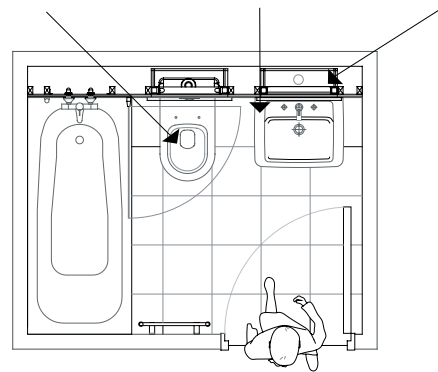

STANDARD FRAME FEATURES

Frames supplied complete with extension bolt set & quick fix nuts

Easy install wall brackets for vertical or horizontal fixing

WRAS
APPROVED PRODUCT

WRAS approved dual flush cistern adjustable from 6/3 litre to 4.5/3 litre

0-280mm adjustable feet with rubber sound deadening pads

Wall bracket and top of frame designed for easy shelf installation

All cisterns supplied with easy use water isolation valve

Trend 2

Iso 2

Stainless Steel

Lustrolite

A large selection of designer press panels

Large feet for easy rear fixing (specially designed for UK timber floor)

Frame fully tested to 400kg support weight

YouTube

CHECK OUT OUR INSTALLATION VIDEOS

SEE PAGES 10 & 11

Flushing & Support Systems



WC frames

WALL-MOUNTED 0.82m WC FRAME

(EPWC-05-1005)



820mm WC frame with dual flush cistern

- Top or front access
- Suitable for all non- electronic press panels
- Supplied with full pre-wall installation kit (extension bolts included)
- The siphon can be modified to provide a full flush of either 6L/3L (standard) or 4.5L/3L
- Supplied with both straight and angled soil pipe

£315.00

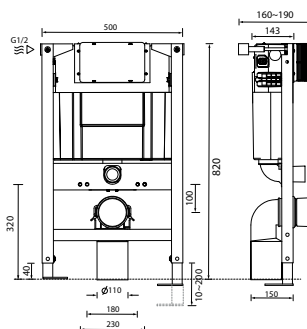

Note: All dimensions are in millimetres



WALL-MOUNTED 0.98m WC FRAME

(EPWC-05-1505)



980mm WC frame with dual flush cistern

- Top or front access
- Suitable for all non- electronic press panels
- Supplied with full pre-wall installation kit (extension bolts included)
- The siphon can be modified to provide a full flush of either 6L/3L (standard) or 4.5L/3L
- Supplied with both straight and angled soil pipe

£315.00

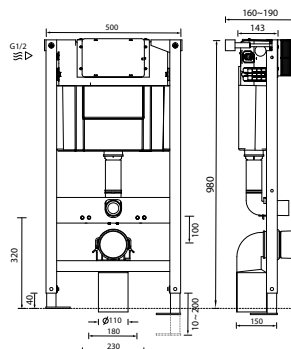

Note: All dimensions are in millimetres



WALL-MOUNTED 1.18m WC FRAME

(EPWC-05-2005)



1180mm WC frame with dual flush cistern

- Top or front access
- Suitable for all press panels
- Supplied with full pre-wall installation kit (extension bolts included)
- The siphon can be modified to provide a full flush of either 6L/3L
- Supplied with both straight and angled soil pipe

£299.00

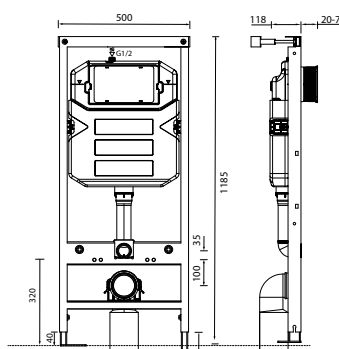

Note: All dimensions are in millimetres



LOW HEIGHT PAN FIXING FRAME

(EPWC-20-0005)

Wall-hung support frame only

- Requires separate concealed cistern
- Supplied with full pre-wall installation bolt kit

£195.00

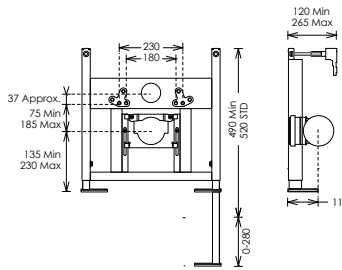

Note: All dimensions are in millimetres



WC frame – accessories

STRAIGHT WC ADAPTOR

DESCRIPTION	PRODUCT CODE	PRICE
STRAIGHT WC ADAPTOR	EPAC-10-0005	£19.00



EXTENSION BOLT SET

DESCRIPTION	PRODUCT CODE	PRICE
EXTENSION BOLT SET	EPAC-15-0005	£16.00



CORNER BRACKET SET

DESCRIPTION	PRODUCT CODE	PRICE
CORNER BRACKET SET	EPAC-15-0010	£47.00



WATERPROOF TILEABLE FRONT PANEL - 12mm

DESCRIPTION	PRODUCT CODE	PRICE
WATERPROOF TILEABLE FRONT PANEL	EPBO-MB-1012	£19.00

1210mm x 600mm to cut on site



UNI-STRUT FIXING RAIL

DESCRIPTION	PRODUCT CODE	PRICE
1.08M FIXING RAIL	EPAC-20-0005	£11.00
1.80M FIXING RAIL	EPAC-20-0010	£18.00
3.0M FIXING RAIL	EPAC-20-0015	£27.00



Slimline WC Frame

- 80mm depth cistern
- Front access only
- Supplied with both straight and angled soil pipe
- Suitable for all press panels
- Supplied with full pre-wall installation bolt kit adjustable from 90mm - 110mm depth
- The siphon can be modified to provide a full flush of either 6L / 3L (standard) or 4.5L / 3L



9cm SLIMLINE WC FRAME (EPWC-30-2005)



£335.00

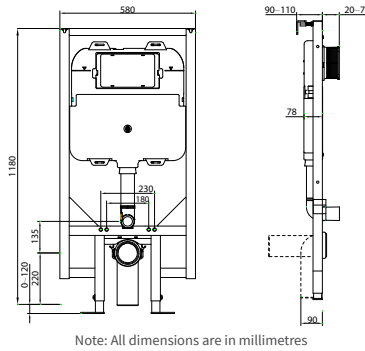

SLIMLINE FRAME TILEABLE BOX (EPAC-25-0005)

£215.00

Tiles, frame, pushplate and WC not included.

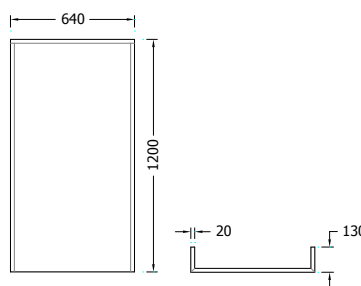

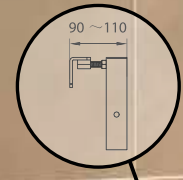

EASI-PLAN DUAL FLUSH CISTERN ONLY - 820

(EPWC-25-1005)

820mm concealed dual flush cistern

- Suitable for all press panels (See pages 184-185)
- Top or front access
- The siphon can be modified to provide a full flush of either 6L / 3L (standard) or 4.5L / 3L
- Supplied as cistern only with mounting brackets. Does not include soil pipe.

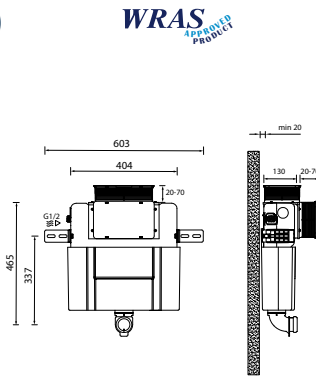

Note: All dimensions are in millimetres



£135.00

EASI-PLAN DUAL FLUSH CISTERN ONLY - 980

(EPWC-25-1505)

980mm concealed dual flush cistern

- Suitable for all press panels (See pages 184-185)
- Top or front access
- The siphon can be modified to provide a full flush of either 6L / 3L (standard) or 4.5L / 3L
- Supplied as cistern only with mounting brackets. Does not include soil pipe.

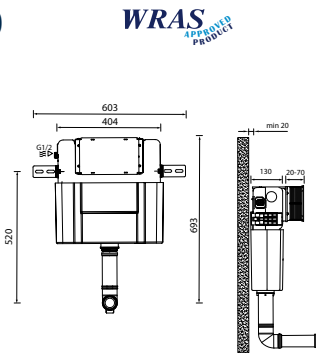

Note: All dimensions are in millimetres



£135.00

EASI-PLAN DUAL FLUSH CISTERN ONLY - 1180

(EPWC-25-2005)

1180mm concealed dual flush cistern

- Suitable for all press panels
- Front access only
- The siphon can be modified to provide a full flush of either 6L / 3L (standard) or 4.5L / 3L
- Supplied as cistern only with mounting brackets. Does not include soil pipe.

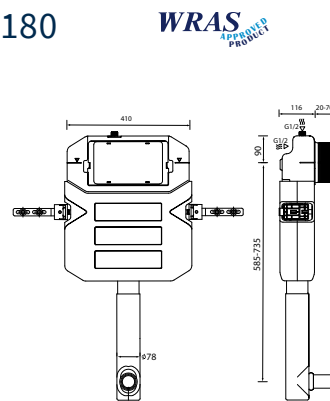

Note: All dimensions are in millimetres



£135.00

CONCEALED CISTERN WITH MECHANICAL DUAL FLUSH AND CHROME BUTTON

(EPWC-25-0005)

Concealed cistern with mechanical dual flush and chrome button

£79.00

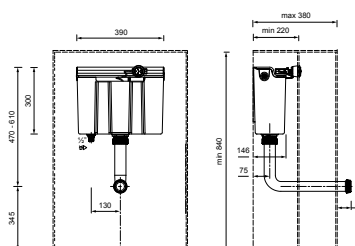

Note: All dimensions are in millimetres





ZONE

- Zone press panels are suitable for all WC frames and 820, 980, 1180 Cisterns
- Zone press panels are indented and therefore suitable for the blind and partially sighted

FROM **£33.00**

DESCRIPTION	PRODUCT CODE	PRICE
ZONE PRESS PANEL - CHROME	EPPR-10-05CP	£35.00
ZONE PRESS PANEL - SATIN CHROME	EPPR-10-05SA	£35.00
ZONE PRESS PANEL - WHITE	EPPR-10-05WH	£33.00

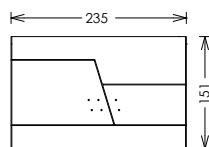

Note: All dimensions are in millimetres



MODE

- Mode press panels are suitable for all WC frames and 820, 980, 1180 Cisterns

FROM **£33.00**

DESCRIPTION	PRODUCT CODE	PRICE
MODE PRESS PANEL - CHROME	EPPR-15-05CP	£35.00
MODE PRESS PANEL - SATIN CHROME	EPPR-15-05SA	£35.00
MODE PRESS PANEL - WHITE	EPPR-15-05WH	£33.00

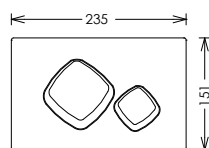

Note: All dimensions are in millimetres



TREND 2

- Trend 2 press panels are suitable for all WC frames and 820, 980, 1180 Cisterns

FROM **£42.00**

DESCRIPTION	PRODUCT CODE	PRICE
TREND 2 PRESS PANEL - CHROME	EPPR-30-05CP	£54.00
TREND 2 PRESS PANEL - SATIN	EPPR-30-05SA	£54.00
TREND 2 PRESS PANEL - BLACK	EPPR-30-05BK	£54.00
TREND 2 PRESS PANEL - WHITE	EPPR-30-05WH	£42.00

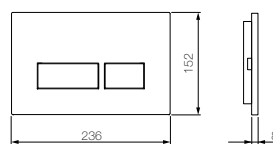

Note: All dimensions are in millimetres



ISO 2

- Iso 2 press panels are suitable for all WC frames and 820, 980, 1180 Cisterns

FROM **£42.00**

DESCRIPTION	PRODUCT CODE	PRICE
ISO 2 PRESS PANEL - CHROME	EPPR-35-05CP	£54.00
ISO 2 PRESS PANEL - SATIN	EPPR-35-05SA	£54.00
ISO 2 PRESS PANEL - BLACK	EPPR-35-05BK	£54.00
ISO 2 PRESS PANEL - WHITE	EPPR-35-05WH	£42.00

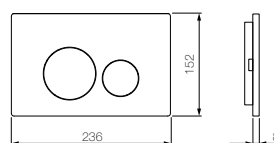

Note: All dimensions are in millimetres



TREND 2S STAINLESS STEEL

BRUSHED OR POLISHED FINISH

- Trend 2S press panels are suitable for all WC frames and 820, 980, 1180 Cisterns

DESCRIPTION	PRODUCT CODE	PRICE
TREND 2S POLISHED STAINLESS STEEL	EPPR-30-05PS	£168.00
TREND 2S BRUSHED STAINLESS STEEL	EPPR-30-05BS	£168.00

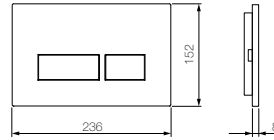

Note: All dimensions are in millimetres



ISO 2S STAINLESS STEEL

BRUSHED OR POLISHED FINISH

- Iso 2S press panels are suitable for all WC frames and 820, 980, 1180 Cisterns

DESCRIPTION	PRODUCT CODE	PRICE
ISO 2S POLISHED STAINLESS STEEL	EPPR-35-05PS	£168.00
ISO 2S BRUSHED STAINLESS STEEL	EPPR-35-05BS	£168.00

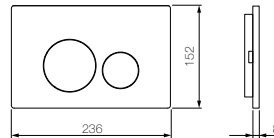

LUSTROLITE GLASS-EFFECT PRESS PANELS

- Lustrolite press panels are suitable for all WC frames and 820, 980, 1180 Cisterns
- Supplied as a kit with replacement syphon (air operated)

£168.00

COLOUR	PRODUCT CODE	PRICE
ARCTIC	EPPR-50-0510	£168.00
GLACIER	EPPR-50-0542	£168.00
BLUE ATOLL	EPPR-50-0543	£168.00
ROUGE	EPPR-50-0546	£168.00
MOCHA	EPPR-50-0545	£168.00
TITAN	EPPR-50-0541	£168.00
CARBON	EPPR-50-0520	£168.00
SAFARI	EPPR-50-0544	£168.00
FOREST	EPPR-50-0547	£168.00

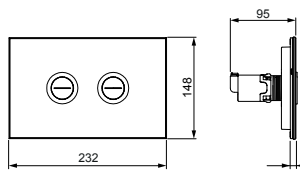

Note: All dimensions are in millimetres



GLISS AUTO ELECTRONIC PRESS PANEL

WITH MANUAL FLUSH OPTION

- Gliss auto press panels are suitable for 1180 frame/ cistern only
- Mains operated
- Touchless full or half flush control

£599.00

DESCRIPTION	PRODUCT CODE	PRICE
GLISS AUTO PRESS PANEL - CHROME	EPPR-60-05BK	£599.00

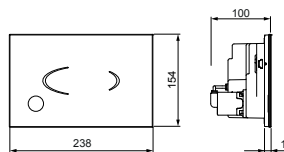

Note: All dimensions are in millimetres



Bidet frames

WALL-MOUNTED 0.82m BIDET FRAME

(EPBI-05-1005)

820mm Bidet Frame

- Supplied with full pre-wall installation bolt kit adjustable depth from 120mm - 265mm
- Supplied with 2 x universal isolation valves

£234.00

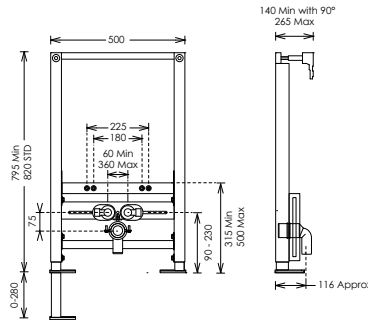

Note: All dimensions are in millimetres



WALL-MOUNTED 0.98m BIDET FRAME

(EPBI-05-1505)

980mm Bidet Frame

- Supplied with full pre-wall installation bolt kit adjustable depth from 120mm - 265mm
- Supplied with 2 x universal isolation valves

£234.00

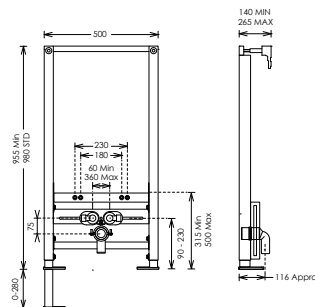

Note: All dimensions are in millimetres



WALL-MOUNTED 1.18m BIDET FRAME

(EPBI-05-2005)

1180mm Bidet Frame

- Supplied with full pre-wall installation bolt kit adjustable depth from 120mm - 265mm
- Supplied with 2 x universal isolation valves

£234.00

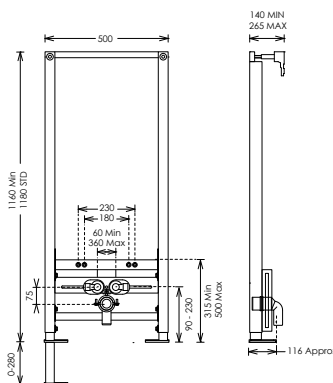

Note: All dimensions are in millimetres



Bidet frame – accessories

EXTENSION BOLT SET

DESCRIPTION	PRODUCT CODE	PRICE
EXTENSION BOLT SET	EPAC-15-0005	£16.00



CORNER BRACKET SET

DESCRIPTION	PRODUCT CODE	PRICE
CORNER BRACKET SET	EPAC-15-0010	£47.00



WATERPROOF TILEABLE FRONT PANEL - 12MM

DESCRIPTION	PRODUCT CODE	PRICE
WATERPROOF TILEABLE FRONT PANEL	EPBO-MB-1012	£19.00

1210mm x 600mm to cut on site



UNI-STRUT FIXING RAIL

DESCRIPTION	PRODUCT CODE	PRICE
1.08M FIXING RAIL	EPAC-20-0005	£11.00
1.80M FIXING RAIL	EPAC-20-0010	£18.00
3.0M FIXING RAIL	EPAC-20-0015	£27.00



Basin frames



WALL-MOUNTED 0.82m / 0.98m BASIN FRAME

(EPBA-05-0005)

Easi-plan basin frame 820 - 980mm height

- Can be height adjusted from 820mm to 980mm by extending the feet and adjusting fixing and connection points
- Supplied with full pre-wall installation bolt kit adjustable depth from 120mm - 265mm
- Supplied with 2 x universal isolation valves

£191.00

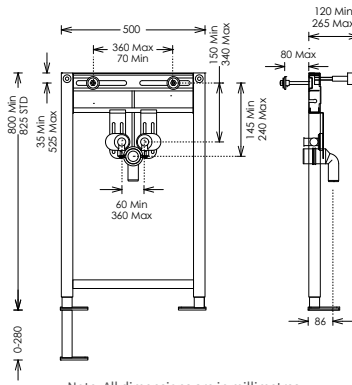

Note: All dimensions are in millimetres



WALL-MOUNTED 1.18m BASIN FRAME

(EPBA-05-2005)

Easi-plan basin frame 1180mm height

- Supplied with full pre-wall installation bolt kit adjustable depth from 120mm - 265mm
- Supplied with 2 x universal isolation valves

£191.00

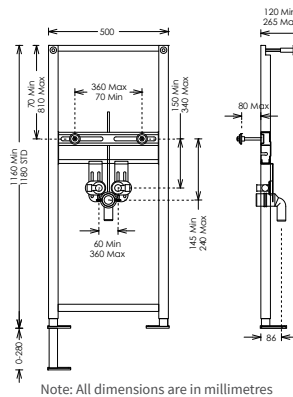

Note: All dimensions are in millimetres



IN-WALL BASIN FRAME

(EPBA-10-0005)

In-wall basin frame

- Includes 30mm marine plywood bearer for secure universal basin fixing
- Supplied with 2 x universal isolation valves and basin fixing bolts

£119.00

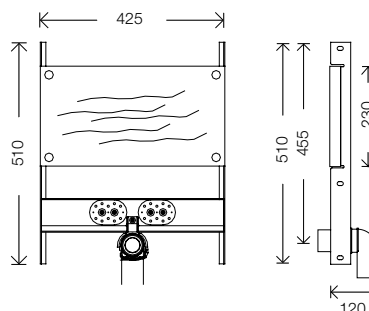

Note: All dimensions are in millimetres



MODUL BASIN AND FURNITURE FRAME

- Chrome or White trap cover and waste pipe
- Maximises storage space with no space wasting P-traps
- Neat and tidy plumbing
- Supplied with two chrome isolation valves for all tap makes
- Trap and housing easily adjustable for all wall furniture
- Marine ply board allows secure basin fitting with included fischer bolts
- Supplied with secure fixing points for furniture brackets

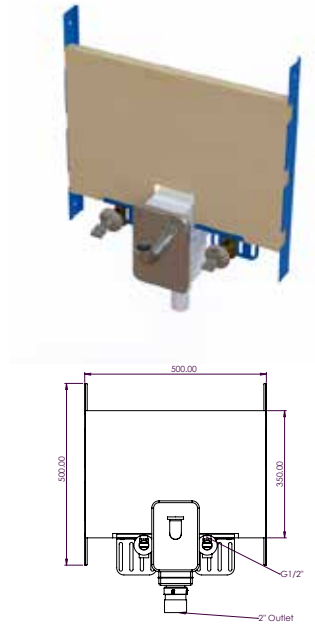

Note: All dimensions are in millimetres

DESCRIPTION	PRODUCT CODE	PRICE
MODUL FRAME CHROME	EPBA-10-0015	£240.00
MODUL FRAME WHITE	EPBA-10-0010	£228.00

Basin frame – accessories

BASIN FIXING BOLT SET (for standard walls)

DESCRIPTION	PRODUCT CODE	PRICE
BASIN FIXING BOLT SET	ANFX-20-0005	£7.50



EXTENSION BOLT SET

DESCRIPTION	PRODUCT CODE	PRICE
EXTENSION BOLT SET	EPAC-15-0005	£16.00



CORNER BRACKET SET

DESCRIPTION	PRODUCT CODE	PRICE
CORNER BRACKET SET	EPAC-15-0010	£47.00



WATERPROOF TILEABLE FRONT PANEL - 12mm

DESCRIPTION	PRODUCT CODE	PRICE
WATERPROOF TILEABLE FRONT PANEL	EPBO-MB-1012	£19.00

1210mm x 600mm to cut on site



UNI-STRUT FIXING RAIL

DESCRIPTION	PRODUCT CODE	PRICE
1.08M FIXING RAIL	EPAC-20-0005	£11.00
1.80M FIXING RAIL	EPAC-20-0010	£18.00
3.0M FIXING RAIL	EPAC-20-0015	£27.00



Installation fitting plates

Perfect for creating the ultimate build quality for your bathroom.



SINGLE FITTING PLATE 1/2"

DESCRIPTION	PRODUCT CODE	PRICE
SINGLE FITTING PLATE 1/2"	EPFP-05-0505	£23.00

- Fixed shower heads
- Shower wall outlets
- Body jets

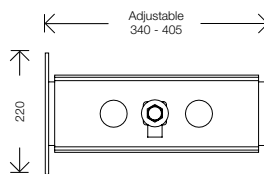

Note: All dimensions are in millimetres

DOUBLE FITTING PLATE 1/2"

DESCRIPTION	PRODUCT CODE	PRICE
DOUBLE FITTING PLATE 1/2"	EPFP-05-1005	£29.00

- Wall-mounted bath taps
- Surface bar type shower valves

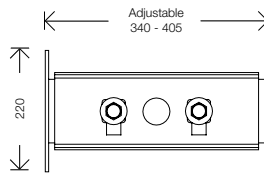

Note: All dimensions are in millimetres

RECESSED FITTING PLATE 3/4"

DESCRIPTION	PRODUCT CODE	PRICE
RECESSED FITTING PLATE 3/4"	EPFP-05-1505	£25.00

- Wall-mounted bath spouts

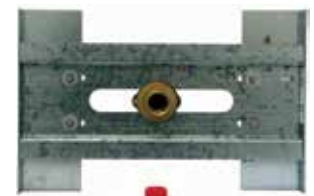
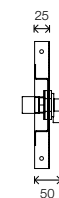
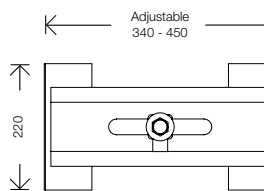

Note: All dimensions are in millimetres

UNIVERSAL SHOWER VALVE PLATE

DESCRIPTION	PRODUCT CODE	PRICE
UNIVERSAL SHOWER VALVE PLATE	EPFP-05-2005	£35.00

- Concealed shower valves

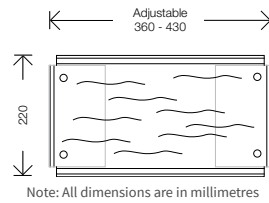

HANSGROHE i-BOX FITTING PLATE

DESCRIPTION	PRODUCT CODE	PRICE
HANSGROHE i-BOX FITTING PLATE WITH i-BOX	EPFP-05-2505	£139.00
HANSGROHE i-BOX FITTING PLATE WITHOUT i-BOX	EPFP-05-2510	£25.00

- Hansgrohe concealed shower valves
- Optional with or without Hansgrohe i-Box

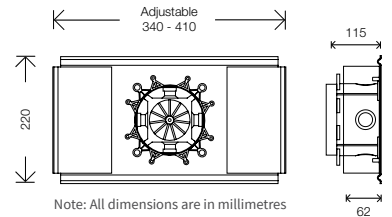

Recessed cabinets & installation frame

TRIO RECESSED CABINET INSTALLATION FRAME

(EPCA-05-1505)

The installation frame is not necessarily required to fit the cabinets, but it is recommended to ease installation.

- Galvanised steel installation frame
- For Trio recessed cabinet
- 761mm x 498mm (H x W)

£59.00



TRIO RECESSED CABINET

This classic mirrored cupboard and shelving range is designed to be installed in a pre-wall to utilise all available space in a practical yet fashionable way.

- Recessed cabinet
- Pre-wall installation
- Left or right hand hinge opening
- Width x height x depth (mm) - 535 x 800 x 215



White	Beige	Anthracite	Terra Matt	Nilo	Walnut	Wenge	Bleached Oak
FNRC-03-1003 £399.00	FNRC-03-1203 £489.00	FNRC-03-1403 £489.00	FNRC-03-1803 £489.00	FNRC-03-5203 £399.00	FNRC-03-5403 £399.00	FNRC-03-5603 £399.00	FNRC-03-5803 £399.00

Why use water distribution manifolds?

Please note: the use of water distribution manifolds is restricted to installations using mains pressure water supplies and/or combination boilers.

- The use of water distribution manifolds in mains pressure installations is an ideal way of giving ultimate serviceability to all your bathroom products. This offers a very professional installation that is both quiet and easy to install.
- The diagrams below show separate hot and cold water manifolds being positioned within the pre-wall void, so that they are accessible through the over basin shelf.
- Hot and cold water is connected to one end of each manifold which has a 3/4" thread. The separate appliances (i.e. WC system, bath/shower valve and basin) are then piped back to the 1/2" male threads on the manifolds.
- The manifolds can be marked up in either blue or red (i.e. hot or cold) and can also be configured so each outlet has the appliance name (i.e. WC, shower valve, etc.).
- To make plumbing even easier, the Easi-plan range can be plumbed using the Viega range of Profipress fittings for standard UK copper pipe - see page 394.

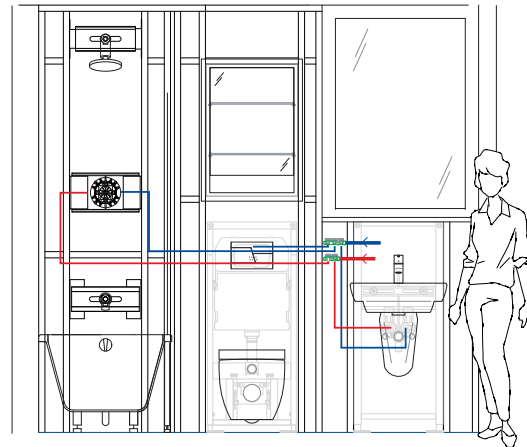

2 WAY MANIFOLD

DESCRIPTION	PRODUCT CODE	PRICE
2 WAY MANIFOLD	EPWD-05-0505	£47.00

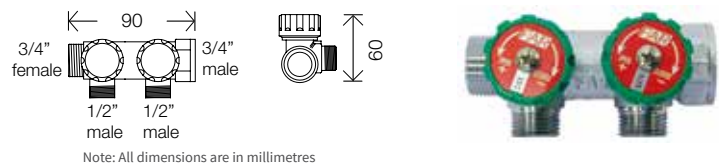

3 WAY MANIFOLD

DESCRIPTION	PRODUCT CODE	PRICE
3 WAY MANIFOLD	EPWD-05-0510	£69.00



4 WAY MANIFOLD

DESCRIPTION	PRODUCT CODE	PRICE
4 WAY MANIFOLD	EPWD-05-0515	£106.00

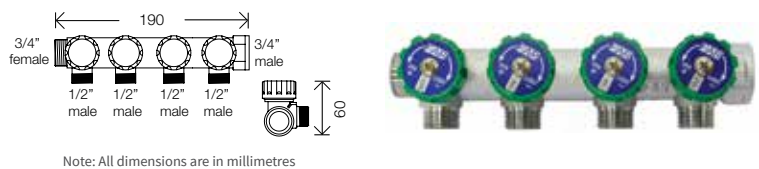

MANIFOLD BRACKET

DESCRIPTION	PRODUCT CODE	PRICE
MANIFOLD BRACKET	EPWD-10-0505	£16.00

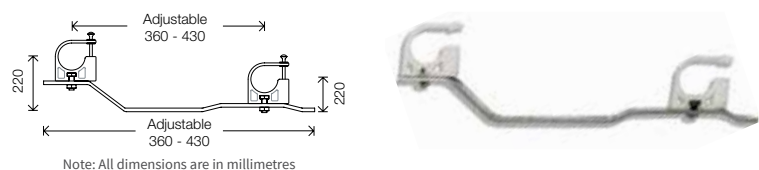

MANIFOLD PLUG & CAP

DESCRIPTION	PRODUCT CODE	PRICE
3/4" FEMALE CAP	EPWD-15-0505	£3.00
3/4" MALE PLUG	EPWD-15-0510	£4.00





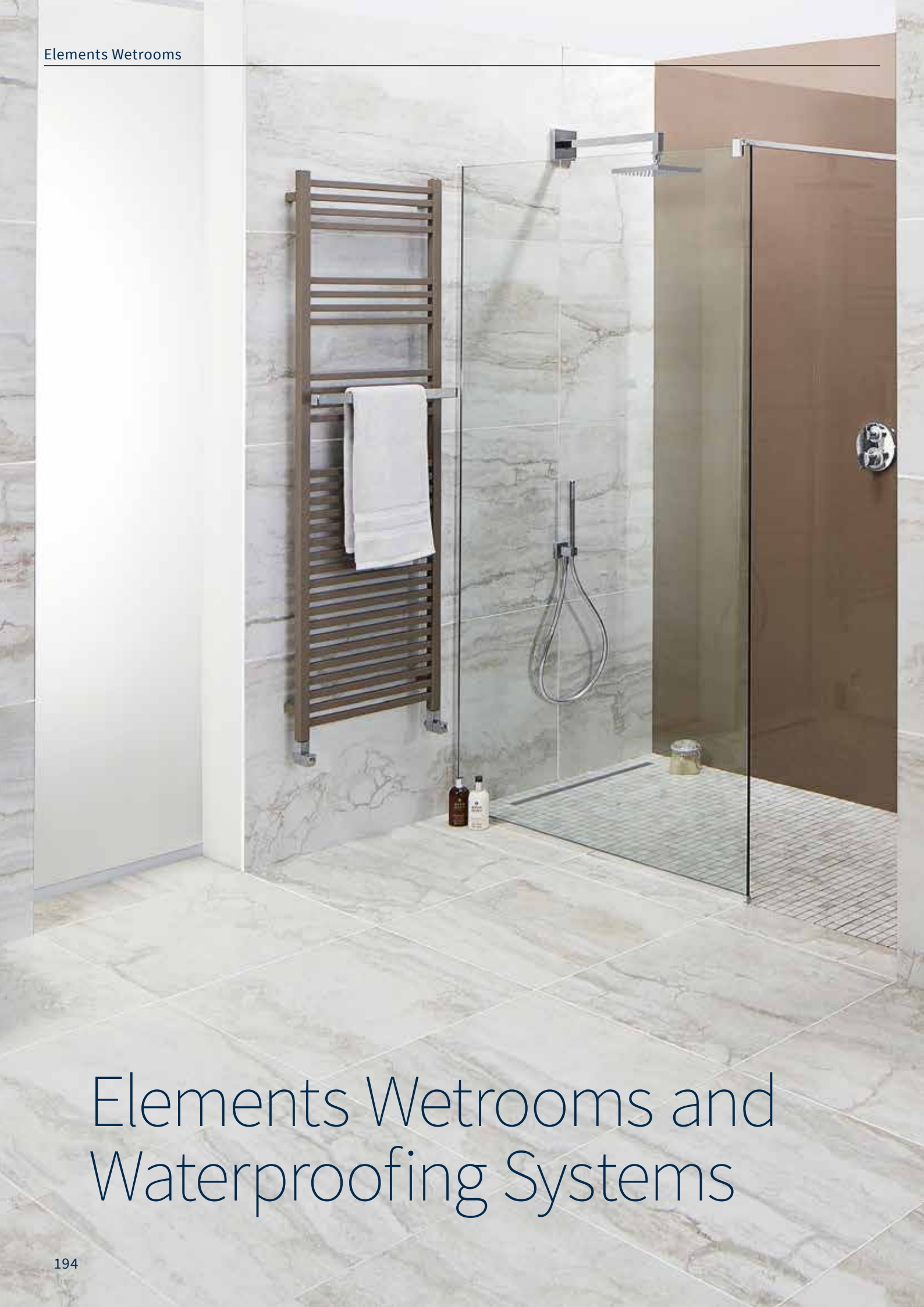

Elements Wetrooms and Waterproofing Systems

The most comprehensive wetroom system on the market, for complete peace of mind and total reassurance of a completely 100% waterproof finished room, all backed with a 15 year guarantee*.

**15
YEAR
GUARANTEE**

*Guarantee against manufacturing defects, see page 398 for details.

Raised Showering Concept Kits



RAISED SHOWERING CONCEPT KITS

The Elements Raised Concept Kit enables you to easily achieve that stylish, designer wetroom look where normal floor drainage systems would be difficult to install.

Create a tiled wet area raised above the standard bathroom floor. The system is lightweight, easy to install and totally flexible in dimensions and drainage types to suit virtually any application. They can even be raised to 140mm so that the drain trap does not need to be installed into the floor.

Supplied with high-capacity drain traps of up to 60 litres/per minute.

Ideal for bath replacements.

Perfect for apartments or solid floors.

Easy to cut length to exact required size.



THREE EASY STEPS

1. Choose your height

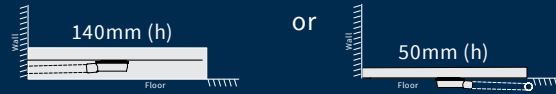

2. Choose your width

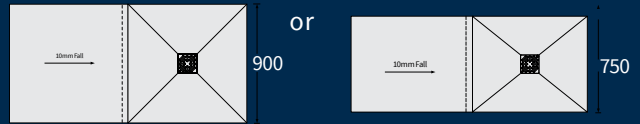

3. Choose your drain type

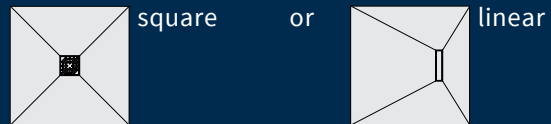

Don't forget to consider overboarding your floor. See page 220 for our kit options.



Complete your wetroom

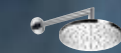

FOR SHOWERS SEE PAGES 83-114



FOR WETROOM SCREENS SEE PAGES 252-279

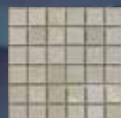

FOR TILES SEE PAGES 280-321



CONCEPT KIT 1 - SQUARE DRAIN

(EMKS-15-1809)

Concept 1 Raised Tray Kit includes complete installation kit

Size (mm) (W x L x H): 900 x 1850 x 130/140

The Concept 1 is designed for use where the customer cannot or chooses not to site the drain within the floor. This system is also suitable where longer runs are required for drainage pipework not achievable within the floor, up to 1.5m from the waste to the soil pipe. This typically will be used for apartment buildings or awkward joist locations on timber floors.

£838.00

Note:

- 1) Trays can be reduced in length & width by cutting with a hand saw, however we do not recommend cutting more than 80mm off each side of the tray when reducing the width.
- 2) Tray lengths can be extended by purchasing additional extension kit.

OPTIONAL:
OVERBOARD
FLOOR KITS
SEE PAGE 220

OPTIONAL:
WATERPROOF
WALL KITS
SEE PAGE 226

INCLUDES

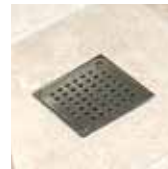

OPTIONAL DESIGNER
DRAIN COVERS
Ask for details

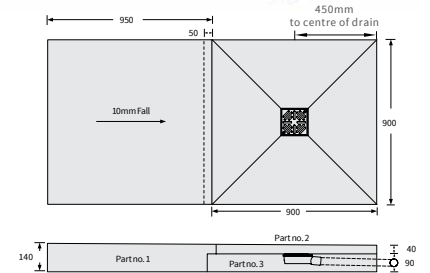
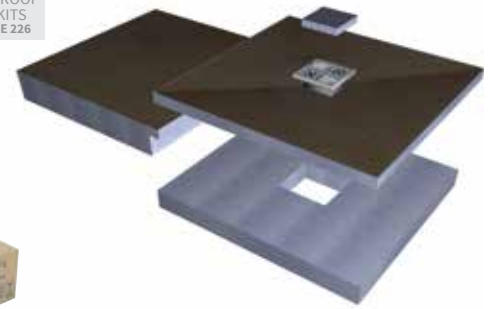

CONCEPT KIT 4 - SQUARE DRAIN

(EMKS-15-1807)

Concept 4 Raised Tray Kit includes complete installation kit

Size (mm) (W x L x H): 750 x 1850 x 130/140

The Concept 4 is designed for use where the customer cannot or chooses not to site the drain within the floor. This system is also suitable where longer runs are required for drainage pipework not achievable within the floor, up to 1.5m from the waste to the soil pipe. This typically will be used for apartment buildings or awkward joist locations on timber floors.

£825.00

Note:

- 1) Trays can be reduced in length & width by cutting with a hand saw, however we do not recommend cutting more than 80mm off each side of the tray when reducing the width.
- 2) Tray lengths can be extended by purchasing additional extension kit.

OPTIONAL:
OVERBOARD
FLOOR KITS
SEE PAGE 220

OPTIONAL:
WATERPROOF
WALL KITS
SEE PAGE 226

INCLUDES

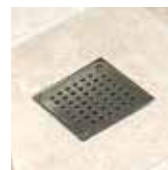

OPTIONAL DESIGNER
DRAIN COVERS
Ask for details

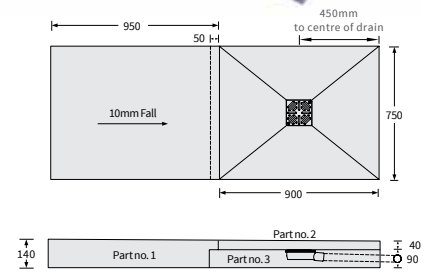
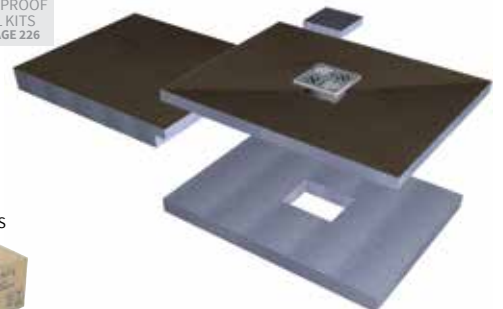

EXTENSION KIT – 900 x 750 x 140mm

(EMAP-40-0505)

140mm Height Extension Kit

Elements extension piece, waterproof tape, FIX-KST, Pro-SEAL extends by 750mm for kit 1, extends by 900mm for kit 4

£216.00

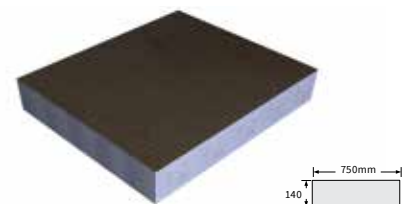



CONCEPT KIT 3 - SQUARE DRAIN

(EMKS-05-1809)

Concept 3 Raised Tray Kit includes complete installation kit

Size (mm) (W x L x H): 900 x 1850 x 40/50

The Concept 3 is designed for two principal applications where a distinctive shower tray i.e. 50mm off the ground is required. Some customers prefer a small step between the shower area and the rest of the bathroom floor.

If a customer wishes to achieve a level floor system on a screeded floor this can be achieved by sitting the 40mm tray within the screed. You must have sufficient clearance in the floor to achieve this.

£724.00

Note:

Trays can be reduced in length & width by cutting with a hand saw, however we do not recommend cutting more than 80mm off each side of the tray when reducing the width.

OPTIONAL:
OVERBOARD
FLOOR KITS
SEE PAGE 220

OPTIONAL:
WATERPROOF
WALL KITS
SEE PAGE 226

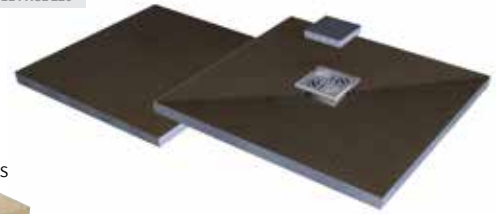

INCLUDES



OPTIONAL DESIGNER
DRAIN COVERS
Ask for details

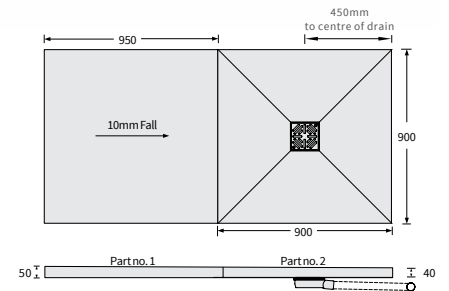

CONCEPT KIT 6 - SQUARE DRAIN

(EMKS-05-1807)

Concept 6 Raised Tray Kit includes complete installation kit

Size (mm) (W x L x H): 750 x 1850 x 40/50

The Concept 6 is designed for two principal applications where a distinctive shower tray i.e. 50mm off the ground is required. Some customers prefer a small step between the shower area and the rest of the bathroom floor.

If a customer wishes to achieve a level floor system on a screeded floor this can be achieved by sitting the 40mm tray within the screed. You must have sufficient clearance in the floor to achieve this.

£699.00

Note:

Trays can be reduced in length & width by cutting with a hand saw, however we do not recommend cutting more than 80mm off each side of the tray when reducing the width.

OPTIONAL:
OVERBOARD
FLOOR KITS
SEE PAGE 220

OPTIONAL:
WATERPROOF
WALL KITS
SEE PAGE 226

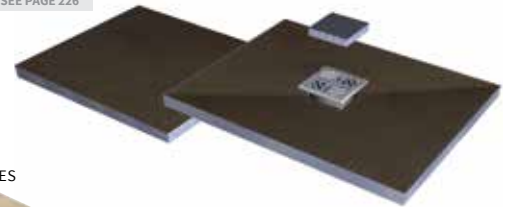

INCLUDES

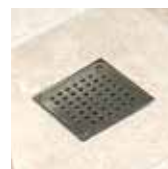

OPTIONAL DESIGNER
DRAIN COVERS
Ask for details

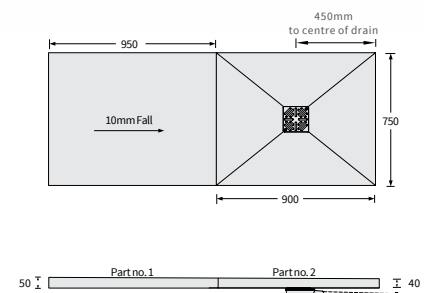



CONCEPT KIT 1L - LINEAR DRAIN 300mm

(EMK3-15-1809)

Linear Concept 1L Raised Tray Kit includes complete installation kit
 Size (mm) (W x L x H): 900 x 1850 x 130/140

The Concept 1L is designed for use where the customer cannot or chooses not to site the drain within the floor. This system is also suitable where longer runs are required for drainage pipework not achievable within the floor, up to 1.5m from the waste to the soil pipe. This typically will be used for apartment buildings or awkward joist locations on timber floors.

£882.00

Note:

- 1) Trays can be reduced in length & width by cutting with a hand saw, however we do not recommend cutting more than 80mm off each side of the tray when reducing the width.
- 2) Tray lengths can be extended by purchasing additional extension kit.

OPTIONAL:
OVERBOARD
FLOOR KITS
SEE PAGE 220

OPTIONAL:
WATERPROOF
WALL KITS
SEE PAGE 226

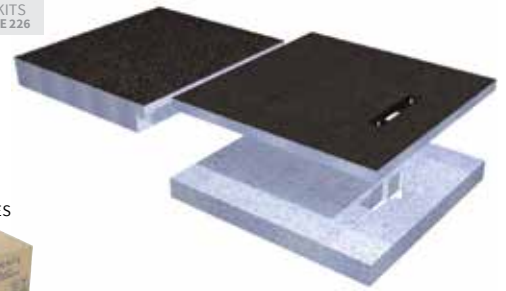

INCLUDES



OPTIONAL TILEABLE
DRAIN COVER
Ask for details

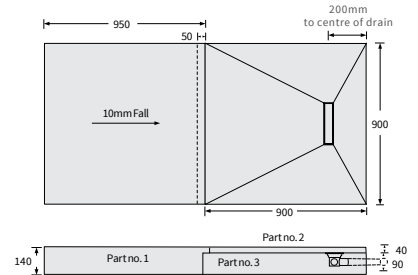

CONCEPT KIT 4L - LINEAR DRAIN 300mm

(EMK3-15-1809)

Linear Concept 4L Raised Tray Kit includes complete installation kit
 Size (mm) (W x L x H): 750 x 1850 x 130/140

The Concept 4L is designed for use where the customer cannot or chooses not to site the drain within the floor. This system is also suitable where longer runs are required for drainage pipework not achievable within the floor, up to 1.5m from the waste to the soil pipe. This typically will be used for apartment buildings or awkward joist locations on timber floors.

£870.00

Note:

- 1) Trays can be reduced in length & width by cutting with a hand saw, however we do not recommend cutting more than 80mm off each side of the tray when reducing the width.
- 2) Tray lengths can be extended by purchasing additional extension kit.

OPTIONAL:
OVERBOARD
FLOOR KITS
SEE PAGE 220

OPTIONAL:
WATERPROOF
WALL KITS
SEE PAGE 226

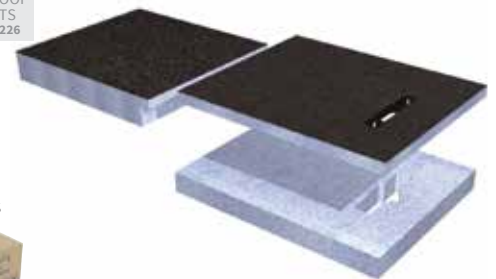

INCLUDES



OPTIONAL TILEABLE
DRAIN COVER
Ask for details

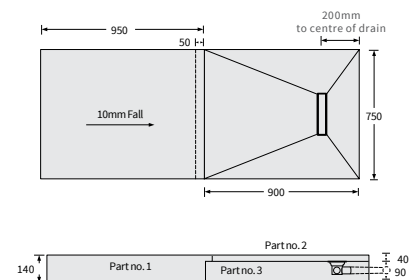

EXTENSION KIT – 900 x 750 x 140mm

(EMAP-40-0505)

140mm Height Extension Kit

Elements extension piece, waterproof tape, FIX-KST, Pro-SEAL extends by 750mm for kit 1, extends by 900mm for kit 4

£216.00

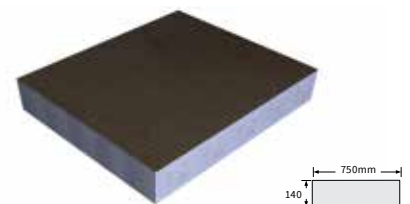



CONCEPT KIT 3L - LINEAR DRAIN 300mm

(EMK3-05-1809)

Linear Concept 3L Raised Tray Kit includes complete installation kit
 Size (mm) (W x L x H): 900 x 1850 x 40/50

The Concept 3L is designed for two principal applications where a distinctive shower tray i.e. 50mm off the ground is required. Some customers prefer a small step between the shower area and the rest of the bathroom floor. Secondly if a customer wishes to achieve a level floor system on a screeded floor this can be achieved by sitting the 40mm tray within the screed. You must have sufficient clearance in the floor to achieve this.

£768.00

Note:
 Trays can be reduced in length & width by cutting with a hand saw, however we do not recommend cutting more than 80mm off each side of the tray when reducing the width.

OPTIONAL:
 OVERBOARD
 FLOOR KITS
 SEE PAGE 220

OPTIONAL:
 WATERPROOF
 WALL KITS
 SEE PAGE 226



INCLUDES



OPTIONAL TILEABLE
 DRAIN COVER
 Ask for details

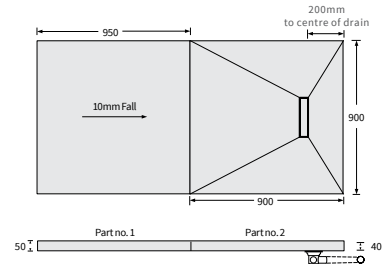

CONCEPT KIT 6L - LINEAR DRAIN 300mm

(EMK3-05-1807)

Linear Concept 6L Raised Tray Kit includes complete installation kit
 Size (mm) (W x L x H): 750 x 1850 x 40/50

The Concept 6L is designed for two principal applications where a distinctive shower tray i.e. 50mm off the ground is required. Some customers prefer a small step between the shower area and the rest of the bathroom floor. Secondly if a customer wishes to achieve a level floor system on a screeded floor this can be achieved by sitting the 40mm tray within the screed. You must have sufficient clearance in the floor to achieve this.

£744.00

Note:
 Trays can be reduced in length & width by cutting with a hand saw, however we do not recommend cutting more than 80mm off each side of the tray when reducing the width.

OPTIONAL:
 OVERBOARD
 FLOOR KITS
 SEE PAGE 220

OPTIONAL:
 WATERPROOF
 WALL KITS
 SEE PAGE 226

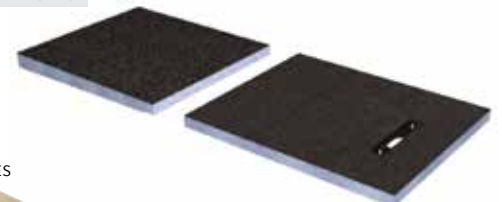

INCLUDES



OPTIONAL TILEABLE
 DRAIN COVER
 Ask for details

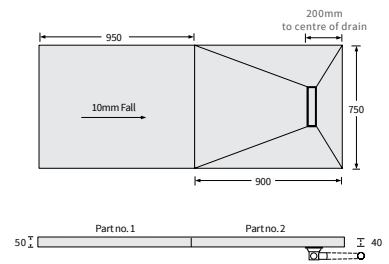

Level Access Shower Tray Kits



LEVEL ACCESS SHOWER TRAY KITS

Specifically designed for the UK market where bathroom floors are over boarded with either plywood or Element board. These trays are 30mm in height and give a completely flush tiled floor after installation.

If your desired shape or size of shower tray is not included in the standard shower tray range don't worry! Abacus Elements have the ability to make custom Shower Trays to your design. Virtually any shapes are possible - simply send your requirements to your Abacus Elements dealer.

Supplied with high-capacity drain traps of up to 42 litres/per minute.

Ideal for either timber or screeded floors.

A comprehensive range of tray sizes and drain options.

Easy installation.

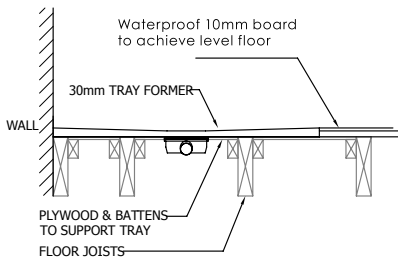

TWO EASY STEPS

1. Choose your shower tray size

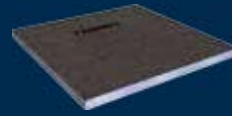

2. Choose your drain type

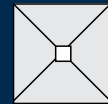

square



300 linear

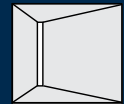

600 linear

It is recommended to overboard your floor with 10mm Abacus Elements boards. See page 220 for our kit options.



Complete your wetroom



FOR SHOWERS SEE PAGES 83-114



FOR WETROOM SCREENS SEE PAGES 252-279

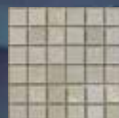

FOR TILES SEE PAGES 280-321

Level Access 30mm Shower Tray Kits WITH SQUARE DRAIN

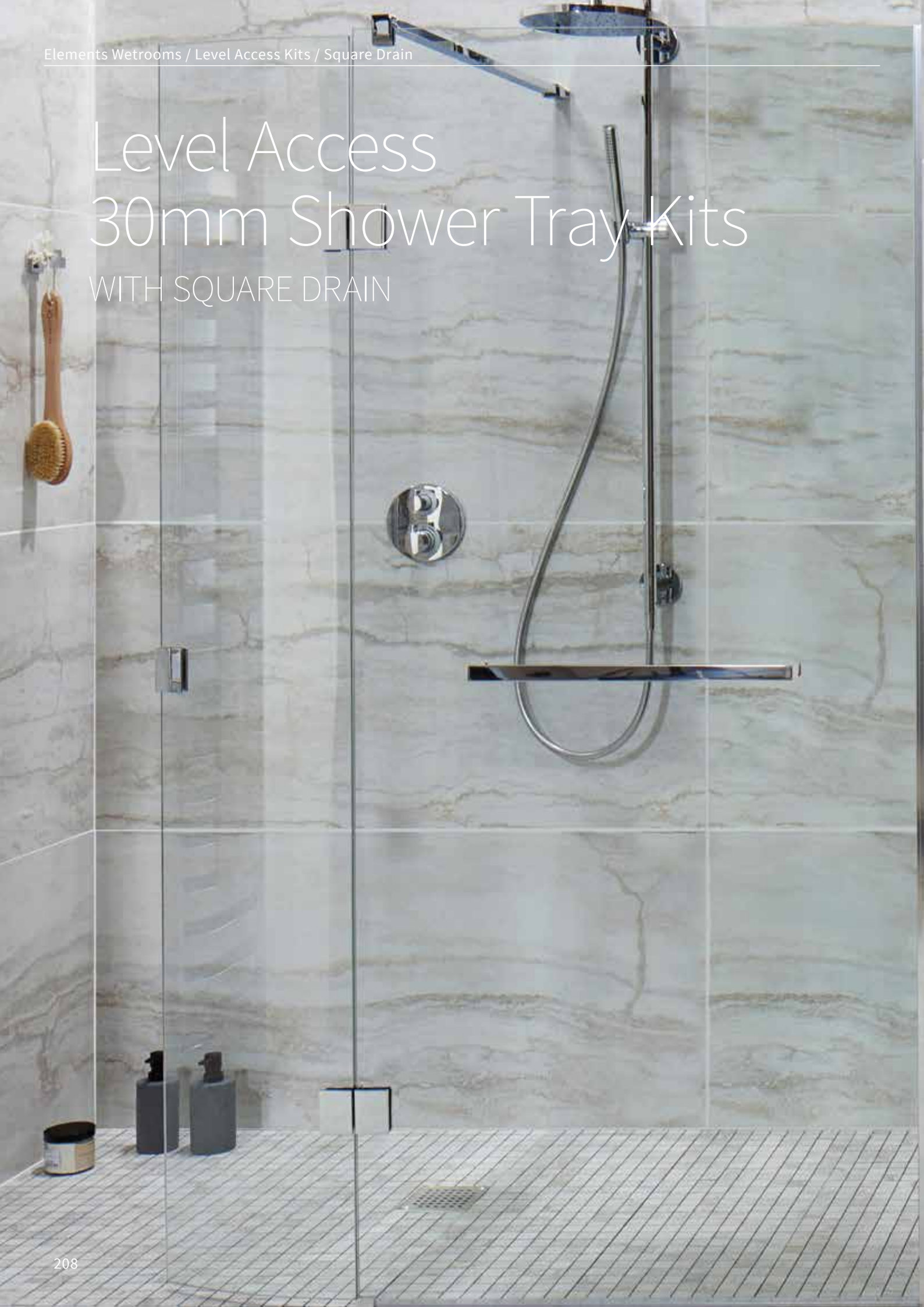

Complete Level Access Shower Tray Kits

All our shower tray kits come complete with a full installation kit

INSTALLATION & DRAINAGE KIT

Installation & Drainage Kit includes:

Pro-SEAL Premix, wood floor primer, horizontal shower waste, Fix-KST, Fix-MD, waterproof tape, waterproof internal corners, tile guide, paint brush, protective gloves, notched trowel



Corner Drain Kits

LEVEL TRAY KIT - 9 x 9 CORNER SQUARE DRAIN

(EMKS-CO-0909)

Level Access Kit Corner Drain

Size (mm) (W x L x H): 900 x 900 x 30

Includes installation & drainage kit

£549.00

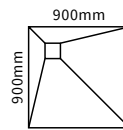

RECOMMENDED:
OVERBOARD
FLOOR KITS
SEE PAGE 220

OPTIONAL:
WATERPROOF
WALL KITS
SEE PAGE 226



LEVEL TRAY KIT - 10 x 10 CORNER SQUARE DRAIN

(EMKS-CO-1010)

Level Access Kit Corner Drain

Size (mm) (W x L x H): 1000 x 1000 x 30

Includes installation & drainage kit

£569.00

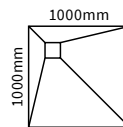

RECOMMENDED:
OVERBOARD
FLOOR KITS
SEE PAGE 220

OPTIONAL:
WATERPROOF
WALL KITS
SEE PAGE 226



LEVEL TRAY KIT - 12 x 12 CORNER SQUARE DRAIN

(EMKS-CO-1212)

Level Access Kit Corner Drain

Size (mm) (W x L x H): 1200 x 1200 x 30

Includes installation & drainage kit

£669.00

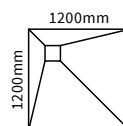

RECOMMENDED:
OVERBOARD
FLOOR KITS
SEE PAGE 220

OPTIONAL:
WATERPROOF
WALL KITS
SEE PAGE 226



End Drain Kits

LEVEL TRAY KIT - 12 x 9 END SQUARE DRAIN

(EMKS-EN-1209)

Level Access Kit End Drain

Size (mm) (W x L x H): 1200 x 900 x 30

Includes installation & drainage kit

£649.00



LEVEL TRAY KIT - 14 x 9 END SQUARE DRAIN

(EMKS-EN-1409)

Level Access Kit End Drain

Size (mm) (W x L x H): 1400 x 900 x 30

Includes installation & drainage kit

£659.00



LEVEL TRAY KIT - 15 x 8 END SQUARE DRAIN

(EMKS-EN-1508)

Level Access Kit End Drain

Size (mm) (W x L x H): 1500 x 800 x 30

Includes installation & drainage kit

£659.00



LEVEL TRAY KIT - 16 x 9 END SQUARE DRAIN

(EMKS-EN-1609)

Level Access Kit End Drain

Size (mm) (W x L x H): 1600 x 900 x 30

Includes installation & drainage kit

£679.00



Centre Drain Kits

LEVEL TRAY KIT - 9 x 9 CENTRE SQUARE DRAIN

(EMKS-CE-0909)

Level Access Kit Centre Drain

Size (mm) (W x L x H): 900 x 900 x 30

Includes installation & drainage kit

£549.00



USAGE: The level kits are suitable for both timber and screeded floors. Note: We recommend the use of 10mm Abacus Elements board on the rest of the floor outside the shower tray area. See page 220.

LEVEL TRAY KIT - 10 x 10 CENTRE SQUARE DRAIN

(EMKS-CE-1010)

Level Access Kit Centre Drain

Size (mm) (W x L x H): 1000 x 1000 x 30

Includes installation & drainage kit

£569.00



LEVEL TRAY KIT - 12 x 12 CENTRE SQUARE DRAIN

(EMKS-CE-1212)

Level Access Kit Centre Drain

Size (mm) (W x L x H): 1200 x 1200 x 30

Includes installation & drainage kit

£669.00



LEVEL TRAY KIT - 12 x 9 CENTRE SQUARE DRAIN

(EMKS-CE-1209)

Level Access Kit Centre Drain

Size (mm) (W x L x H): 1200 x 900 x 30

Includes installation & drainage kit

£649.00



LEVEL TRAY KIT - 14 x 9 CENTRE SQUARE DRAIN

(EMKS-CE-1409)

Level Access Kit Centre Drain

Size (mm) (W x L x H): 1400 x 900 x 30

Includes installation & drainage kit

£659.00



LEVEL TRAY KIT - 16 x 9 CENTRE SQUARE DRAIN

(EMKS-CE-1609)

Level Access Kit Centre Drain

Size (mm) (W x L x H): 1600 x 900 x 30

Includes installation & drainage kit

£679.00



LEVEL TRAY KIT - 18 x 9 CENTRE SQUARE DRAIN

(EMKS-CE-1809)

Level Access Kit Centre Drain

Size (mm) (W x L x H): 1800 x 900 x 30

Includes installation & drainage kit

£749.00



Level Access 30mm Shower Tray Kits

WITH LINEAR 300mm DRAIN



Complete Level Access Shower Tray Kits

All our shower tray kits come complete with a full installation kit

INSTALLATION & DRAINAGE KIT WITH STAINLESS STEEL COVER PLATE

Installation & Drainage Kit includes:

Pro-SEAL Premix, wood floor primer, horizontal & vertical shower waste, Fix-KST, Fix-MD, waterproof tape, waterproof internal corners, tile guide, paint brush, protective gloves, notched trowel and stainless steel 300mm drain cover.



End Drain Kits

LEVEL TRAY KIT - 9 x 9 END LINEAR 300 DRAIN

(EMK3-EN-0909)

Level Access Kit End Drain

Size (mm) (W x L x H): 900 x 900 x 30

Includes installation & drainage kit

£579.00



LEVEL TRAY KIT - 10 x 10 END LINEAR 300 DRAIN

(EMK3-EN-1010)

Level Access Kit End Drain

Size (mm) (W x L x H): 1000 x 1000 x 30

Includes installation & drainage kit

£599.00



LEVEL TRAY KIT - 12 x 12 END LINEAR 300 DRAIN

(EMK3-EN-1212)

Level Access Kit End Drain

Size (mm) (W x L x H): 1200 x 1200 x 30

Includes installation & drainage kit

£699.00



LEVEL TRAY KIT - 12 x 9 END LINEAR 300 DRAIN

(EMK3-EN-1209)

Level Access Kit End Drain

Size (mm) (W x L x H): 1200 x 900 x 30

Includes installation & drainage kit

£679.00



LEVEL TRAY KIT - 14 x 9 END LINEAR 300 DRAIN

(EMK3-EN-1409)

Level Access Kit End Drain

Size (mm) (W x L x H): 1400 x 900 x 30

Includes installation & drainage kit

£689.00



LEVEL TRAY KIT - 16 x 9 END LINEAR 300 DRAIN

(EMK3-EN-1609)

Level Access Kit End Drain

Size (mm) (W x L x H): 1600 x 900 x 30

Includes installation & drainage kit

£699.00



USAGE: The level kits are suitable for both timber and screeded floors. Note: We recommend the use of 10mm Abacus Elements board on the rest of the floor outside the shower tray area. See page 220.

All prices inclusive of VAT

Centre Drain Kits

LEVEL TRAY KIT - 9 x 9 CENTRE LINEAR 300 DRAIN

(EMK3-CE-0909)

Level Access Kit Centre Drain

Size (mm) (W x L x H): 900 x 900 x 30

Includes installation & drainage kit

£579.00



LEVEL TRAY KIT - 12 x 12 CENTRE LINEAR 300 DRAIN

(EMK3-CE-1212)

Level Access Kit Centre Drain

Size (mm) (W x L x H): 1200 x 1200 x 30

Includes installation & drainage kit

£699.00



LEVEL TRAY KIT - 12 x 9 CENTRE LINEAR 300 DRAIN

(EMK3-CE-1209)

Level Access Kit Centre Drain

Size (mm) (W x L x H): 1200 x 900 x 30

Includes installation & drainage kit

£679.00

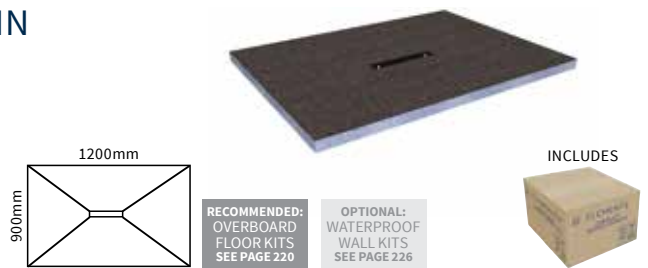

LEVEL TRAY KIT - 14 x 9 CENTRE LINEAR 300 DRAIN

(EMK3-CE-1409)

Level Access Kit Centre Drain

Size (mm) (W x L x H): 1400 x 900 x 30

Includes installation & drainage kit

£689.00



LEVEL TRAY KIT - 16 x 9 CENTRE LINEAR 300 DRAIN

(EMK3-CE-1609)

Level Access Kit Centre Drain

Size (mm) (W x L x H): 1600 x 900 x 30

Includes installation & drainage kit

£699.00



LEVEL TRAY KIT - 18 x 9 CENTRE LINEAR 300 DRAIN

(EMK3-CE-1809)

Level Access Kit Centre Drain

Size (mm) (W x L x H): 1800 x 900 x 30

Includes installation & drainage kit

£779.00

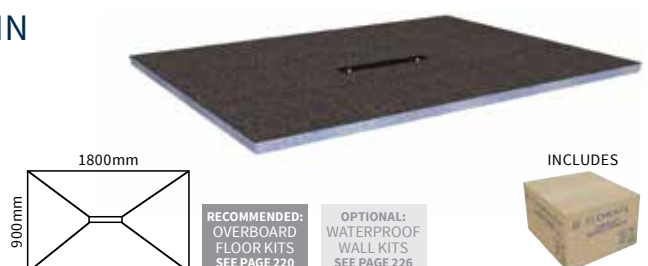



Level Access 30mm Shower Tray Kits

WITH LINEAR 600mm DRAIN

Complete Level Access Shower Tray Kits

All our shower tray kits come complete with a full installation kit

INSTALLATION & DRAINAGE KIT WITH STAINLESS STEEL COVER PLATE

Installation & Drainage Kit includes:

Pro-SEAL Premix, wood floor primer, horizontal & vertical shower waste, Fix-KST, Fix-MD, waterproof tape, waterproof internal corners, tile guide, paint brush, protective gloves, notched trowel and stainless steel 600mm drain cover.

Offset Centre Drain Kits

LEVEL TRAY KIT - 16 x 9 OFFSET CENTRE LINEAR 600 DRAIN

(EMK6-OF-1609)

Level Access Kit Offset Centre Linear 600 Drain

Size (mm) (W x L x H): 1600 x 900 x 30

Includes installation & drainage kit

£739.00

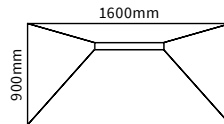

RECOMMENDED:
OVERBOARD
FLOOR KITS
SEE PAGE 220

OPTIONAL:
WATERPROOF
WALL KITS
SEE PAGE 226

INCLUDES



LEVEL TRAY KIT - 18 X 9 OFFSET CENTRE LINEAR 600 DRAIN

(EMK6-OF-1809)

Level Access Kit Offset Centre Linear 600 Drain

Size (mm) (W x L x H): 1800 x 900 x 30

Includes installation & drainage kit

£799.00

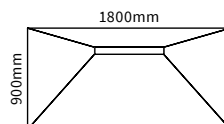

RECOMMENDED:
OVERBOARD
FLOOR KITS
SEE PAGE 220

OPTIONAL:
WATERPROOF
WALL KITS
SEE PAGE 226

INCLUDES



End Drain Kits

LEVEL TRAY KIT - 9 x 9 END LINEAR 600 DRAIN

(EMK6-EN-0909)

Level Access Kit End Linear 600 Drain

Size (mm) (W x L x H): 900 x 900 x 30

Includes installation & drainage kit

£599.00



LEVEL TRAY KIT - 12 x 12 END LINEAR 600 DRAIN

(EMK6-EN-1212)

Level Access Kit End Linear 600 Drain

Size (mm) (W x L x H): 1200 x 1200 x 30

Includes installation & drainage kit

£729.00



LEVEL TRAY KIT - 12 x 9 END LINEAR 600 DRAIN

(EMK6-EN-1209)

Level Access Kit End Linear 600 Drain

Size (mm) (W x L x H): 1200 x 900 x 30

Includes installation & drainage kit

£699.00



LEVEL TRAY KIT - 14 x 9 END LINEAR 600 DRAIN

(EMK6-EN-1409)

Level Access Kit End Linear 600 Drain

Size (mm) (W x L x H): 1400 x 900 x 30

Includes installation & drainage kit

£719.00



LEVEL TRAY KIT - 16 x 9 END LINEAR 600 DRAIN

(EMK6-EN-1609)

Level Access Kit End Linear 600 Drain

Size (mm) (W x L x H): 1600 x 900 x 30

Includes installation & drainage kit

£739.00

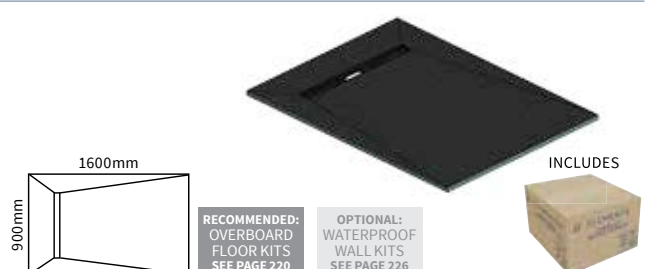

USAGE: The level kits are suitable for both timber and screeded floors. Note: We recommend the use of 10mm Abacus Elements board on the rest of the floor outside the shower tray area. See page 220.

All prices inclusive of VAT

Overboard Floor Kits for all tiling

PERFECT FOR WATERPROOFING ANY
FLOOR PRIOR TO TILING.

IDEAL FOR:

BATHROOMS

WETROOMS

KITCHENS

CONSERVATORIES





IDEAL FOR TILED KITCHENS



IDEAL FOR TILED CONSERVATORIES



Overboard Floor Kits

WITH ELEMENTS 10mm WATERPROOF INSULATION BOARD

CHOICE OF KIT SIZES AVAILABLE TO SUIT YOUR ROOM, IDEAL FOR WATERPROOFING BATHROOMS, WETROOMS, KITCHENS, CONSERVATORIES, OR ANY AREA YOU WISH TO TILE AND KEEP WATERPROOF AND INSULATED.

TYPICAL INSTALLATION

10mm Overboard Floor Kit

Level Access
30mm Shower tray

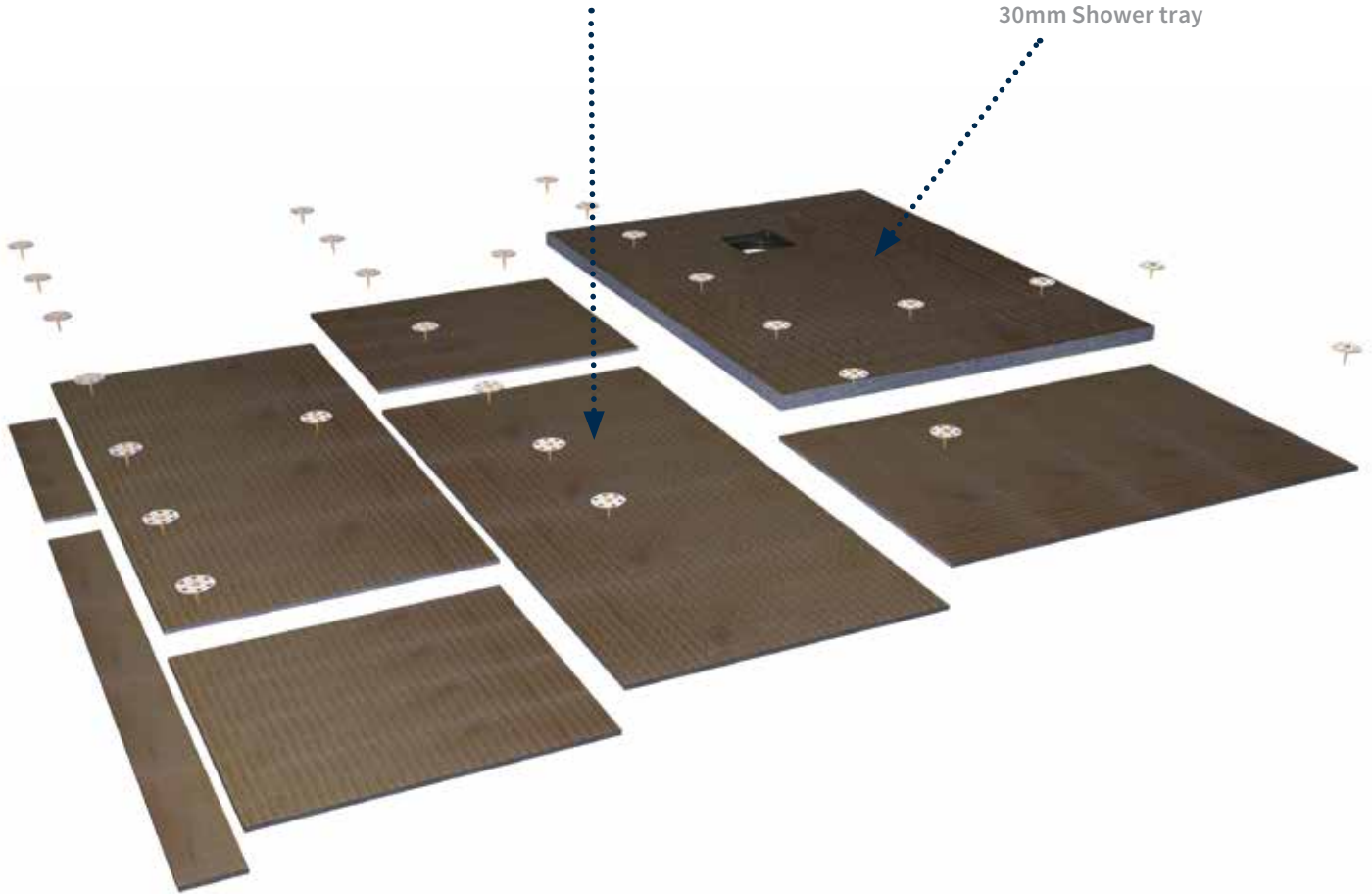

Typical Layout for
Level Access Shower Room

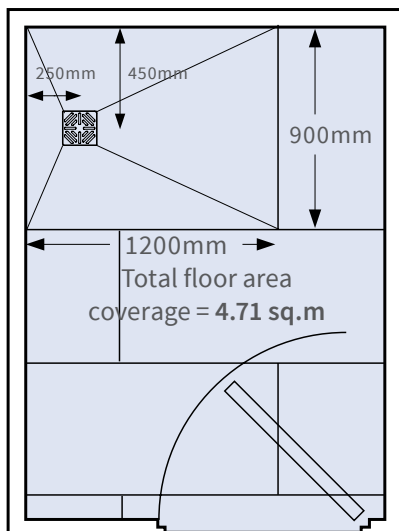

Components required
to overboard a floor:

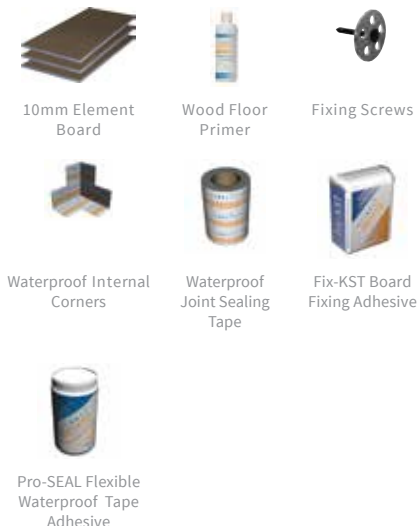

Perfect for use with electric under-tile heating (see pages 348-353)



OVERBOARD FLOOR KIT 1 - COVERAGE = 2.16 SQ.M

(EMKB-10-1216)

Kit includes:

- 3 x 1200 x 600 x 10mm waterproof boards
- Installation kit, including fixing adhesive, fixings, waterproof tape, waterproofing adhesive and accessories

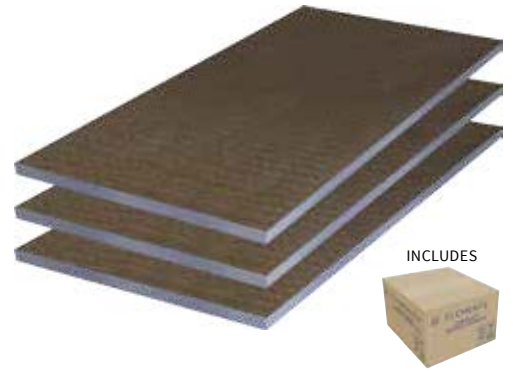
£189.00**OVERBOARD FLOOR KIT 2 - COVERAGE = 3.60 SQ.M**

(EMKB-10-2360)

Kit includes:

- 5 x 1200 x 600 x 10mm waterproof boards
- Installation kit, including fixing adhesive, fixings, waterproof tape, waterproofing adhesive and accessories

£249.00**OVERBOARD FLOOR KIT 3 - COVERAGE = 7.20 SQ.M**

(EMKB-10-3720)

Kit includes:

- 10 x 1200 x 600 x 10mm waterproof boards
- 2 x Installation kit, including fixing adhesive, fixings, waterproof tape, waterproofing adhesive and accessories

£498.00



Infinity Single Fall Level Access Wetroom System

INFINITY SINGLE FALL WETROOM TRAYS

Infinity gives the ultimate wetroom look for those who want to tile with large format tiles.

The Infinity range offers four standard shower tray sizes and Abacus Elements can also manufacture bespoke sizes to your specific needs.

The drains are flush with the wall and offer a stylish, minimalist look. There are two drain lengths, 700mm and 1000mm, and both come with a high capacity drain trap of 40 litres per minute.

The infinity trays are all supplied complete with waterproofing tapes attached and a comprehensive installation kit for total piece of mind and installation ease, all backed with a 15 year guarantee.

All trays are supplied with Lustrolite tapered tile trim.

15 year guarantee*

*Guarantee against manufacturing defects, see page 398 for details.



TWO EASY STEPS

1. Choose your shower tray size

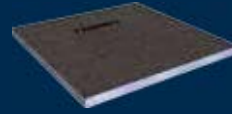

2. Choose your installation position

left hand

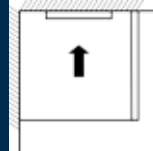

mid wall

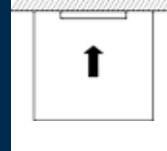

right hand

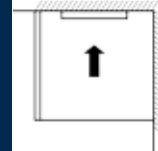

Complete your wetroom



FOR SHOWERS SEE PAGES 83-114



FOR WETROOM SCREENS SEE PAGES 252-279

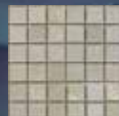

FOR TILES SEE PAGES 280-321



Infinity Single Fall Tray Kits

WITH TILEABLE SLOT DRAIN

INFINITY TRAY KIT - 12 x 9 LEFT HAND/RIGHT HAND

EMKE-L7-1209 (left hand)

EMKE-R7-1209 (right hand)

Size (mm) (W x L x H): 1200 x 950 x 30

Includes installation & drainage kit

Includes 700mm drain

£779.00

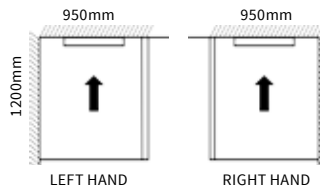

INFINITY TRAY KIT - 14 x 9 LEFT HAND/RIGHT HAND

EMKE-L7-1409 (left hand)

EMKE-R7-1409 (right hand)

Size (mm) (W x L x H): 1400 x 950 x 30

Includes installation & drainage kit

Includes 700mm drain

£799.00

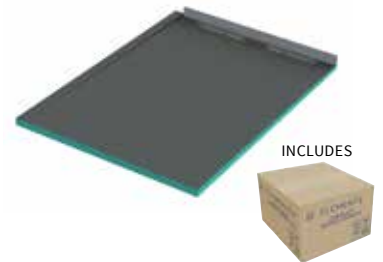
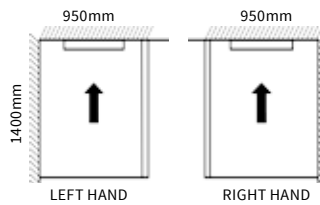

INFINITY TRAY KIT - 12 x 12 LEFT HAND/RIGHT HAND

EMKE-L1-1212 (left hand)

EMKE-R1-1212 (right hand)

Size (mm) (W x L x H): 1200 x 1250 x 30

Includes installation & drainage kit

Includes 1000mm drain

£899.00

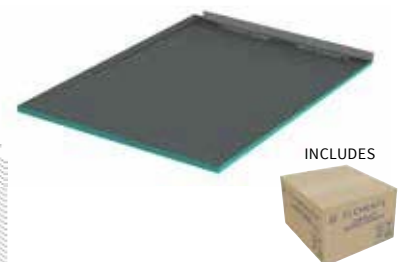
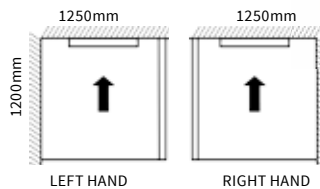

INFINITY TRAY KIT - 18 x 9 WALL TO WALL

EMKE-F1-1809

Size (mm) (W x L x H): 1800 x 900 x 30

Includes installation & drainage kit

Includes 1000mm drain

£899.00

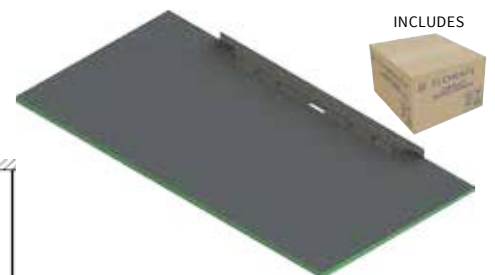
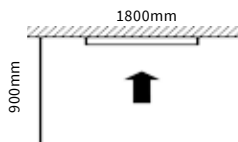

INFINITY TRAY EXTENSION PIECES

EMIT-90-0309

Size (mm) (W x L x H): 900 x 300 x 30

Includes 2 pieces

£199.00

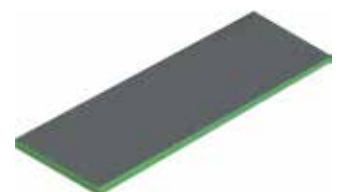
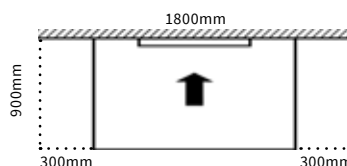

NOTE: only available for 18 x 9 wall-to-wall installation
Kit expands up to 300mm at either or both sides.

All prices inclusive of VAT

Elements Building Boards 6mm – 100mm

ELEMENTS



Kind to the Environment



High Compressive Strength



Lightweight & Easy to Handle



Waterproof Properties



Insulating Properties



Easy to Cut



Economical Construction Product

Features & benefits

- More stable in moist environments than timber
- Can be used for cladding walls and floors
- Can be used both internally and externally
- Can be either mechanically fixed, glued with Abacus Elements adhesive or both
- Cut easily with a hand saw to correct size, shape and around obstacles
- Good insulating product to help reduce condensation
- Offers higher adhesion to tiles than either timber or plasterboard
- Can be fixed onto almost any surface
- Has a high compressive strength of over 25 Tonnes per sq.m making it incredibly strong when tiled
- Can either be tiled or plastered
- A perfect product for the fast creation of tiled partition walls anywhere within the home
- Recommended for use with electric under tile heating systems

The most comprehensive wetroom and waterproofing system available in the UK.



all backed with a 15 year guarantee

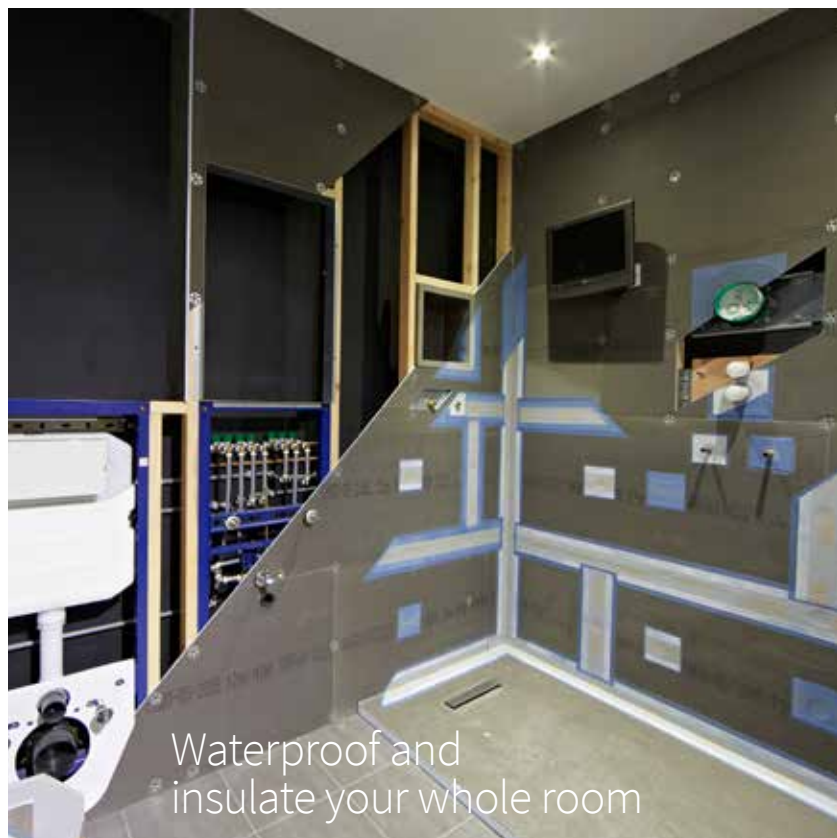

Wall Panelling Kits

The professional's choice prior to tiling



WATERPROOF WALL KIT 1 - COVERAGE = 4.32 SQ.M

Kit includes:

- 6 x 1200 x 600 x 12mm waterproof boards
- Installation kit, including, fixings, waterproof tape, waterproofing adhesive and accessories

12mm BOARD KIT (FOR REPLACING PLASTERBOARD)
£199.00 (EMKB-12-1432)

6mm BOARD KIT (FOR OVERBOARDING EXISTING WALL)
£189.00 (EMKB-06-1432)



WATERPROOF WALL KIT 2 - COVERAGE = 5.76 SQ.M

Kit includes:

- 8 x 1200 x 600 x 12mm waterproof boards
- Installation kit, including, fixings, waterproof tape, waterproofing adhesive and accessories

12mm BOARD KIT (FOR REPLACING PLASTERBOARD)
£249.00 (EMKB-12-2576)

6mm BOARD KIT (FOR OVERBOARDING EXISTING WALL)
£239.00 (EMKB-06-2576)

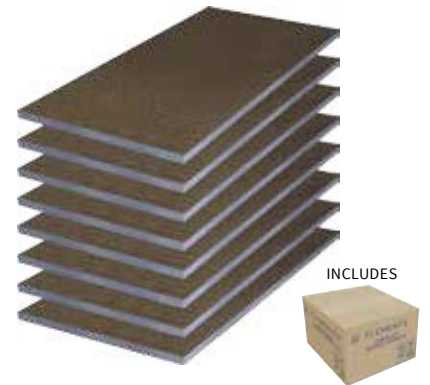

WATERPROOF WALL KIT 3 - COVERAGE = 7.20 SQ.M

Kit includes:

- 10 x 1200 x 600 x 12mm waterproof boards
- Installation kit, including, fixings, waterproof tape, waterproofing adhesive and accessories

12mm BOARD KIT (FOR REPLACING PLASTERBOARD)
£289.00 (EMKB-12-3720)

6mm BOARD KIT (FOR OVERBOARDING EXISTING WALL)
£279.00 (EMKB-06-3720)





Ready To Tile Waterproof Recessed Storage Units

- Available in two depths, 100mm and 180mm
- Fully waterproof
- Ready to tile

15 year guarantee against leaks

Note 1: These units can be stacked on top of each other to form multiple recesses
Note 2: Units are easily installed using Fix-PU fixing adhesive



WATERPROOF RECESSED STORAGE UNITS - 350 x 240mm

DESCRIPTION	EXTERNAL SIZE W x L x H (mm)	PRODUCT CODE	PRICE
SINGLE RECESSED WATERPROOF STORAGE UNIT - 100mm DEPTH	350 x 240 x 100	EMSU-05-0010	£114.00
SINGLE RECESSED WATERPROOF STORAGE UNIT - 180mm DEPTH	350 x 240 x 180	EMSU-05-0015	£118.00



WATERPROOF RECESSED STORAGE UNITS - 350 x 350mm

DESCRIPTION	EXTERNAL SIZE W x L x H (mm)	PRODUCT CODE	PRICE
SINGLE RECESSED WATERPROOF STORAGE UNIT - 100mm DEPTH	350 x 350 x 100	EMSU-05-0020	£114.00
SINGLE RECESSED WATERPROOF STORAGE UNIT - 180mm DEPTH	350 x 350 x 180	EMSU-05-0025	£118.00



WATERPROOF RECESSED STORAGE UNITS - 420 x 350mm

DESCRIPTION	EXTERNAL SIZE W x L x H (mm)	PRODUCT CODE	PRICE
SINGLE RECESSED WATERPROOF STORAGE UNIT - 100mm DEPTH	420 x 350 x 100	EMSU-05-0030	£132.00
SINGLE RECESSED WATERPROOF STORAGE UNIT - 180mm DEPTH	420 x 350 x 180	EMSU-05-0035	£138.00



WATERPROOF RECESSED STORAGE UNITS - 800 x 500mm

DESCRIPTION	EXTERNAL SIZE W x L x H (mm)	PRODUCT CODE	PRICE
SINGLE RECESSED WATERPROOF STORAGE UNIT - 100mm DEPTH	800 x 500 x 100	EMSU-05-0550	£154.00
SINGLE RECESSED WATERPROOF STORAGE UNIT - 180mm DEPTH	800 x 500 x 180	EMSU-05-0555	£166.00



Recessed Storage



WATERPROOF RECESSED STORAGE UNITS - 1600 x 350mm

DESCRIPTION	EXTERNAL SIZE W x L x H (mm)	PRODUCT CODE	PRICE
SINGLE RECESSED WATERPROOF STORAGE UNIT - 180mm DEPTH	1600 x 350 x 180	EMSU-05-0570	£226.00



Standard Shower Seat

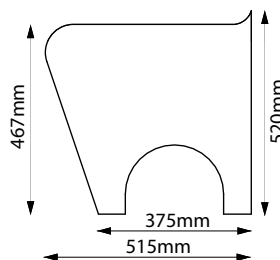

Seats require tiling in mosaic tiles with a maximum individual tile size of 35 x 35mm

Suitable for electric under-tile heating, see pages 348-353

Bespoke seats can be made to order.

STANDARD SHOWER SEAT

DESCRIPTION	SIZE (mm) W x L x H	PRODUCT CODE	PRICE
STANDARD SHOWER SEAT 1m LENGTH	515 x 1000 x 520	EMSC-80-1005	£394.00

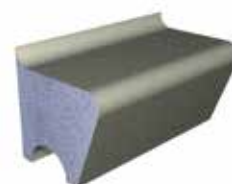

INTERNAL MITRE CUT SECTION

DESCRIPTION	SIZE (mm) W x L x H	PRODUCT CODE	PRICE
INTERNAL MITRE CUT SECTION - 700 x 700mm	700 x 700 x 520	EMSC-80-1010	£594.00

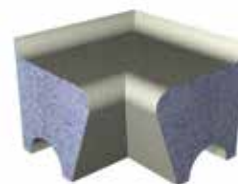

INTERNAL ROUND SECTION

DESCRIPTION	SIZE (mm) W x L x H	PRODUCT CODE	PRICE
INTERNAL ROUND SECTION - 700 x 700mm SUPPLIED WITH INFILL PIECE	700 x 700 x 520	EMSC-80-1015	£588.00

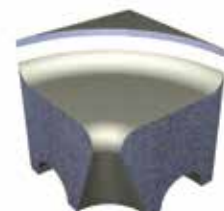

EXTERNAL ROUND SECTION

DESCRIPTION	SIZE (mm) W x L x H	PRODUCT CODE	PRICE
EXTERNAL ROUND SECTION	515 x 515 x 520	EMSC-80-1020	£540.00

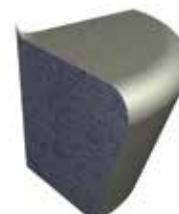

Shower Seating





Complete Shower Cubicles



Penta 1 Shower Cubicle

TYPICAL PENTA 1 ROOM LAYOUT

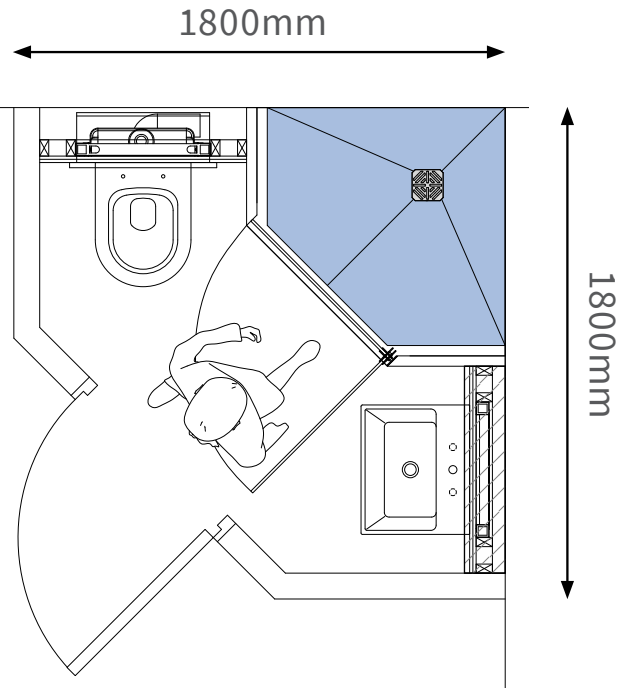

SPECIAL SUBSTRATE ELEMENT INCLUDED



The Penta 1 Cubicle is supplied complete with a specially developed Substrate Element. The Substrate Element incorporates drainage channels to allow pipework to be installed between the two solid walls.

SUPPLIED WITH



Full Installation & Drainage Kit



PENTA 1 CUBICLE - 1000 x 1000mm

DESCRIPTION	SIZE (mm) W x L x H	PRODUCT CODE	PRICE
PENTA 1 CUBICLE - 1000 x 1000mm INC. FULL INSTALLATION & DRAINAGE KIT	1000 x 1000 x 2616	EMSC-05-0505	£1,599.00



PENTA 1 CUBICLE - FRAMELESS GLASS DOOR

DESCRIPTION	SIZE (mm) W x L x H	PRODUCT CODE	PRICE
PENTA CUBICLE FRAMELESS GLASS DOOR	745 x 1900 x 8	VEGX-15-1305	£399.00

- Frameless glass shower door 8mm supplied with 2 chrome hinges
- Door suits L & R opening
- Note: These shower doors are not designed to be totally sealed
- Required opening dim: (tile to tile) 750 width
- Glass door dims: W 745 (inc. hinge) x H 1900

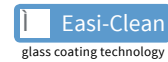

PENTA 1 - FLAT ROOF OPTION

DESCRIPTION	SIZE (mm) W x L x H	PRODUCT CODE	PRICE
PENTA 1 FLAT ROOF OPTION	N/A	EMSC-05-1005	£238.00



PENTA 1 - DOOR HEADER OPTION (FOR USE WITH STEAM DOORS)

DESCRIPTION	SIZE (mm) W x L x H	PRODUCT CODE	PRICE
PENTA 1 DOOR HEADER OPTION	600	EMSC-05-1010	£95.00

- Note: door header can be cut to size on site



Penta 2 Shower Cubicle

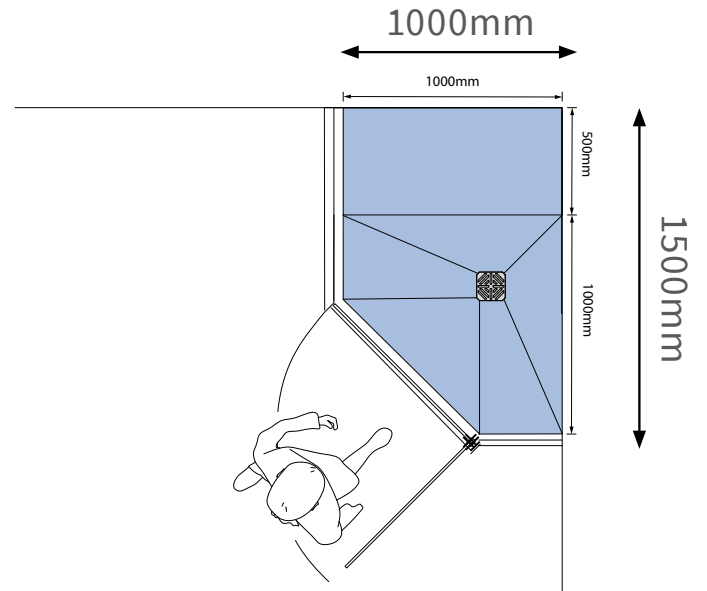

SUPPLIED WITH



Full Installation &
Drainage Kit

PENTA 2 CUBICLE - UNIVERSAL FOR LEFT & RIGHT HAND INSTALLATIONS

DESCRIPTION	SIZE (mm) W x L x H	PRODUCT CODE	PRICE
PENTA 2 CUBICLE INC. FULL INSTALLATION & DRAINAGE KIT	1500 x 1000 x 2460	EMSC-10-0505	£1,990.00



PENTA 2 CUBICLE - FRAMELESS GLASS DOOR

DESCRIPTION	SIZE (mm) W x L x H	PRODUCT CODE	PRICE
PENTA CUBICLE FRAMELESS GLASS DOOR	745 x 1900 x 8	VEGX-15-1305	£399.00

- Frameless glass shower door 8mm supplied with 2 chrome hinges
- Door suits L & R opening
- Note: These shower doors are not designed to be totally sealed
- Required opening dim: (tile to tile) 750 width
- Glass door dims: W 745 (inc. hinge) x H 1900

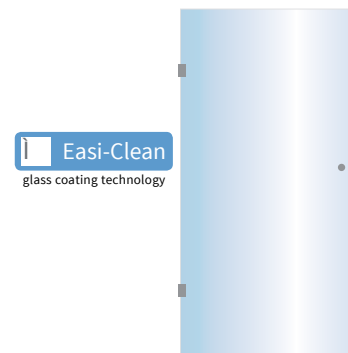

PENTA 2 SUBSTRATE ELEMENT - FOR LEFT OR RIGHT HAND

DESCRIPTION	SIZE (mm) W x L x H	PRODUCT CODE	PRICE
PENTA 2 SUBSTRATE ELEMENT - FOR L/H OR R/H	1500 x 1000 x 80	EMSC-10-1010	£114.00



PENTA 2 CUBICLE - SEAT OPTION

DESCRIPTION	SIZE (mm) W x L x H	PRODUCT CODE	PRICE
PENTA 2 CUBICLE - SEAT OPTION	525 x 920 x 520	EMSC-10-1015	£394.00

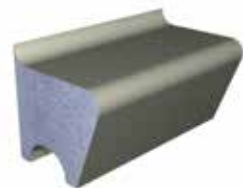

PENTA 2 - FLAT ROOF OPTION

DESCRIPTION	SIZE (mm) W x L x H	PRODUCT CODE	PRICE
PENTA 2 FLAT ROOF OPTION	1500 x 1000 x 80	EMSC-10-1005	£349.00



PENTA 2 - DOOR HEADER OPTION (FOR USE WITH STEAM DOORS)

DESCRIPTION	SIZE (mm) W x L x H	PRODUCT CODE	PRICE
PENTA 1 DOOR HEADER OPTION	600	EMSC-05-1010	£95.00



- Note: door header can be cut to size on site

Curva 1 Shower Cubicle



CURVA 1 CUBICLE - LEFT & RIGHT HANDED

DESCRIPTION	SIZE (mm) W x L x H	PRODUCT CODE	PRICE
CURVA 1 CUBICLE - LEFT HAND INC. FULL INSTALLATION & DRAINAGE KIT	1450 x 1000 x 2460	EMSC-15-0505	£1,795.00
CURVA 1 CUBICLE - RIGHT HAND INC. FULL INSTALLATION & DRAINAGE KIT	1450 x 1000 x 2460	EMSC-15-0510	£1,795.00

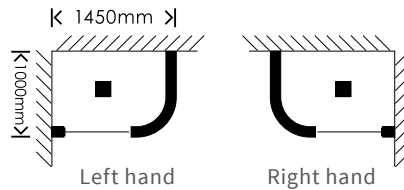

CURVA 1 CUBICLE - FRAMELESS GLASS DOOR

DESCRIPTION	SIZE (mm) W x L x H	PRODUCT CODE	PRICE
CURVA 1 CUBICLE FRAMELESS GLASS DOOR	672 x 1900 x 8	VEGX-15-1310	£399.00

- Frameless glass shower door 8mm supplied with 2 chrome hinges
- Door suits L & R opening
- Note: These shower doors are not designed to be totally sealed
- Required opening dim: (tile to tile) 677 width
- Glass door dims: W 672 (inc. hinge) x H 1900

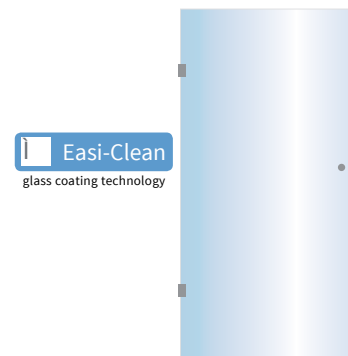

CURVA 1 SUBSTRATE ELEMENT - FOR LEFT & RIGHT HAND

DESCRIPTION	SIZE (mm) W x L x H	PRODUCT CODE	PRICE
CURVA 1 SUBSTRATE ELEMENT - FOR L/H OR R/H	1450 x 1000 x 80	EMSC-15-1005	£114.00



CURVA 1 CUBICLE - DECOR TRIM SET OPTION

DESCRIPTION	SIZE (mm) W x L x H	PRODUCT CODE	PRICE
CURVA 1 CUBICLE DECOR TRIM SET INC. 2X CURVED TRIM + 1X CURVED BASE PLATFORM	N/A	EMSC-15-1010	£294.00



CURVA 1 CUBICLE - FLAT ROOF OPTION

DESCRIPTION	SIZE (mm) W x L x H	PRODUCT CODE	PRICE
CURVA 1 CUBICLE - FLAT ROOF OPTION FOR L/H OR R/H	1450 x 1000 x 80	EMSC-15-1015	£349.00



CURVA 1 - DOOR HEADER OPTION (FOR USE WITH STEAM DOORS)

DESCRIPTION	SIZE (mm) W x L x H	PRODUCT CODE	PRICE
CURVA 1 DOOR HEADER OPTION	600	EMSC-15-1020	£95.00



- Note: door header can be cut to size on site

Quarto Shower Cubicle



QUARTO CUBICLE - RECESSED & CORNER VERSIONS

DESCRIPTION	SIZE (mm) W x L x H	PRODUCT CODE	PRICE
QUARTO CUBICLE - RECESSED FOR L/H OR R/H INSTALLATION- INC. FULL INSTALLATION & DRAINAGE KIT	900 x 1850 x 2460	EMSC-20-0505	£1,895.00
QUARTO CUBICLE - CORNER FOR L/H OR R/H INSTALLATION- INC. FULL INSTALLATION & DRAINAGE KIT	900 x 1850 x 2460	EMSC-20-0510	£1,995.00



Recessed Version

QUARTO CUBICLE - FRAMELESS GLASS DOOR

DESCRIPTION	SIZE (mm) W x L x H	PRODUCT CODE	PRICE
QUARTO CUBICLE FRAMELESS GLASS DOOR	672 x 1900 x 8	VEGX-15-1310	£399.00

- Frameless glass shower door 8mm supplied with 2 chrome hinges
- Door suits L & R opening
- Note: These shower doors are not designed to be totally sealed
- Required opening dim: (tile to tile) 677 width
- Glass door dims: W 672 (inc. hinge) x H 1900

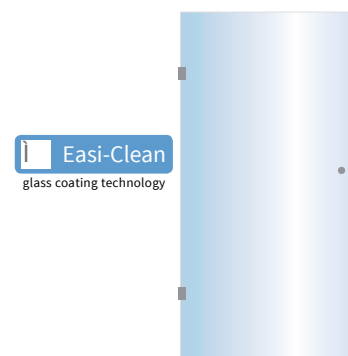

QUARTO SUBSTRATE ELEMENT - FOR LEFT & RIGHT HAND

DESCRIPTION	SIZE (mm) W x L x H	PRODUCT CODE	PRICE
QUARTO SUBSTRATE ELEMENT - FOR L/H OR R/H SUPPLIED IN 2 PARTS	900 x 1850 x 80	EMSC-20-1005	£138.00



QUARTO CUBICLE - SEAT OPTION

DESCRIPTION	SIZE (mm) W x L x H	PRODUCT CODE	PRICE
QUARTO CUBICLE - SEAT OPTION	525 x 820 x 520	EMSC-20-1015	£394.00

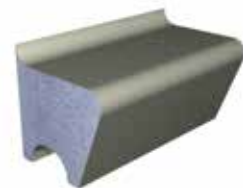

QUARTO CUBICLE - FLAT ROOF OPTION

DESCRIPTION	SIZE (mm) W x L x H	PRODUCT CODE	PRICE
QUARTO CUBICLE - FLAT ROOF OPTION	900 x 1850 x 80	EMSC-20-1010	£349.00



QUARTO - DOOR HEADER OPTION (FOR USE WITH STEAM DOORS)

DESCRIPTION	SIZE (mm) W x L x H	PRODUCT CODE	PRICE
QUARTO DOOR HEADER OPTION	600	EMSC-15-1020	£95.00



- Note: door header can be cut to size on site

Snail Shower Cubicle



SNAIL SHOWER - LEFT & RIGHT HANDED

DESCRIPTION	SIZE (mm) W x L x H	PRODUCT CODE	PRICE
SNAIL CUBICLE - LEFT HAND INC. FULL INSTALLATION & DRAINAGE KIT	1440 x 1950 x 2460	EMSC-25-0505	£3,354.00
SNAIL CUBICLE - RIGHT HAND INC. FULL INSTALLATION & DRAINAGE KIT	1440 x 1950 x 2460	EMSC-25-0510	£3,354.00

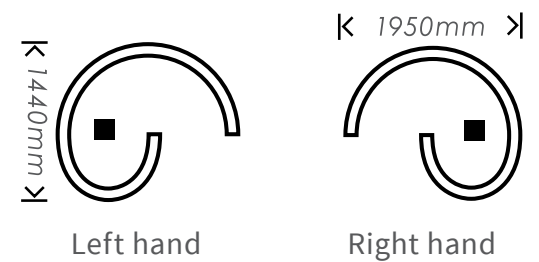

SNAIL SHOWER SUBSTRATE ELEMENT - FOR LEFT & RIGHT HAND

DESCRIPTION	SIZE (mm) W x L x H	PRODUCT CODE	PRICE
SNAIL SHOWER SUBSTRATE ELEMENT - L/H & R/H	1440 x 1950 x 80	EMSC-25-1005	£139.00



SNAIL SHOWER - FLAT ROOF OPTION

DESCRIPTION	SIZE (mm) W x L x H	PRODUCT CODE	PRICE
SNAIL SHOWER - FLAT ROOF OPTION - L/H & R/H	1440 x 1950 x 40	EMSC-25-1015	£479.00



SNAIL SHOWER - ROUND TO FLAT SECTION FOR VALVE INSTALLATION

DESCRIPTION	SIZE (mm) W x L x H	PRODUCT CODE	PRICE
SNAIL SHOWER - ROUND TO FLAT SECTION FOR VALVE INSTALLATION	350 x 35 x 2420 Supplied in 1.2m lengths	EMSC-25-1020	£199.00





Circo Shower Cubicle

CIRCO SHOWER - 1250 DIA. x 2460mm

DESCRIPTION	SIZE (mm) W x L x H	PRODUCT CODE	PRICE
CIRCO SHOWER - 1250 DIA. x 2460 INC. FULL INSTALLATION & DRAINAGE KIT	1250 dia. x 2460	EMSC-30-0505	£2,150.00



CIRCO CURVED - FRAMELESS GLASS DOOR

DESCRIPTION	SIZE (mm) W x L x H	PRODUCT CODE	PRICE
CIRCO CURVED FRAMELESS GLASS DOOR	N/A	VEGX-17-1305	£695.00

- Frameless glass shower door 8mm supplied with 2 chrome hinges
- Door suits L & R opening
- Note: These shower doors are not designed to be totally sealed

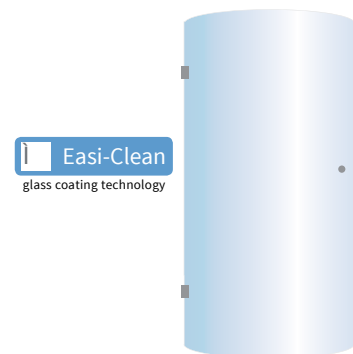

CIRCO SHOWER - SUBSTRATE ELEMENT

DESCRIPTION	SIZE (mm) W x L x H	PRODUCT CODE	PRICE
CIRCO SHOWER SUBSTRATE ELEMENT	1250 dia. x 80	EMSC-30-1005	£79.00



CIRCO SHOWER - DECOR TRIM SET

DESCRIPTION	SIZE (mm) W x L x H	PRODUCT CODE	PRICE
CIRCO SHOWER - DECOR TRIM SET 2x FINISHING COLUMN 80mm NOTE: CANNOT BE USED WITH GLASS DOOR OPTION	125 dia. x 2420	EMSC-30-1010	£199.00



CIRCO SHOWER - FLAT ROOF OPTION

DESCRIPTION	SIZE (mm) W x L x H	PRODUCT CODE	PRICE
CIRCO SHOWER - FLAT ROOF OPTION	1250 dia. x 80	EMSC-30-1015	£300.00



CIRCO SHOWER - ROUND TO FLAT SECTION FOR VALVE INSTALLATION

DESCRIPTION	SIZE (mm) W x L x H	PRODUCT CODE	PRICE
CIRCO SHOWER - ROUND TO FLAT SECTION FOR VALVE INSTALLATION	350 x 35 x 2420	EMSC-30-1020	£199.00





BESPOKE PRODUCTS

If you do not find your required product in this brochure do not worry! We have the ability to produce products specifically to our customers' own requirements.

With a dedicated in-house CAD design team, we have the ability to design bespoke applications for both domestic and commercial situations.

Whether your requirements are wetrooms, baths, vanity units, decorative elements or shower cubicles, please feel free to contact our sales department with your exact requirements.

Bespoke & Wellness Products



ELEMENTS BESPOKE

The only limit is
your imagination.





WETROOM GLASS PANELS

The ultimate in wetroom luxury.

X Series offers a range of twelve sizes of 10mm toughened glass panels all with Easi-Clean coating.

Together with a comprehensive range of support bars and channels, X Series lets you be totally creative in your wetroom design whilst offering outstanding value.

Easi-Clean:

- Keeps glass looking like new
- Reduces water spots (limescale and mineral deposits)
- Is always easier to clean
- Stays cleaner for longer
- Significantly reduces the growth of bacteria

 Easi-Clean
glass coating technology

Wetroom Glass

X SERIES



How to order X Series Wetroom Glass in 5 easy steps

THE POSSIBILITIES ARE TRULY LIMITLESS WITH THE NEW X SERIES RANGE OF GLASS, CHANNELS, CLAMPS AND SUPPORT BARS.

1. Create your design

By combining one or more pieces of X Series glass together with our range of vertical channels, you have the ability to create anything from a simple piece of glass to complex screens with return panels.



2. Choose your glass size

The X range of 10mm toughened glass covers a variety of sizes from 290mm right up to 1190mm in width and 2000mm height so you can be sure to find a size to suit.

X Series glass is supplied with Easi-Clean technology at no extra charge which helps reduce limescale deposit build-up and keeps your glass cleaner for longer.



3. Choose your preferred glass channel

Your X Series glass should be supported within a floor and wall channel and the range offers three options of floor and wall channel:

- Our X Surface Channel has a clever two layered base so that the glass is raised higher than the screw head. This channel is best suited for applications where the tile has already been laid.
- Alternatively our X Recessed Floor & Wall Channel can be installed when tiling to give a minimalistic look.
- Our innovative new V Fix channel allows you to use channelling without the need for silicone which is a great time-saving option.



4. Choose your wall/ceiling support

Depending on the size of the glass you are installing we would recommend that you give the glass panel additional support with an X Series Support Bar. These are available in both horizontal and vertical options and can be cut down to suit your application. See opposite for a guide to choosing glass supports.



5. Finish the look

The X Series includes a range of complementary accessories to give that final touch to your design. Why not add a Double Robe Hook or Towel Hanging Bar with Glass Shelf?



A Guide to Choosing Glass Support

1.

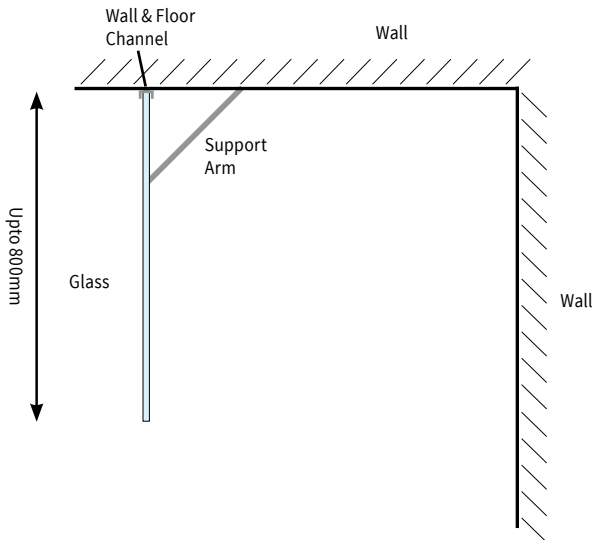

2.

General option for glass over 800mm

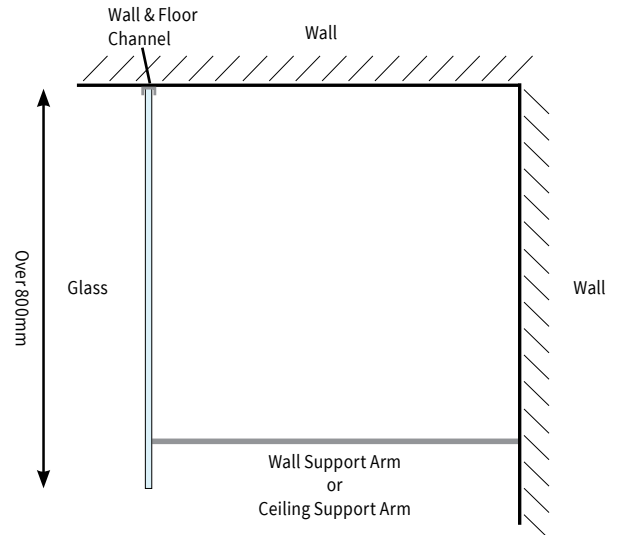

3.

General option for glass over 800mm

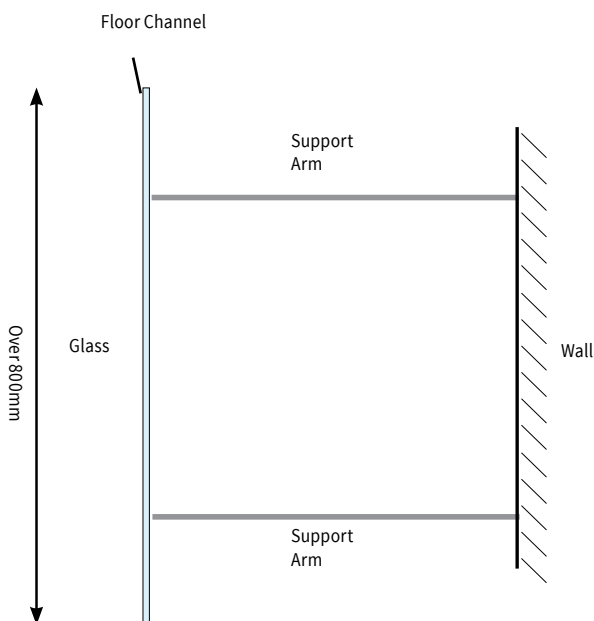

4.

General option for glass over 800mm

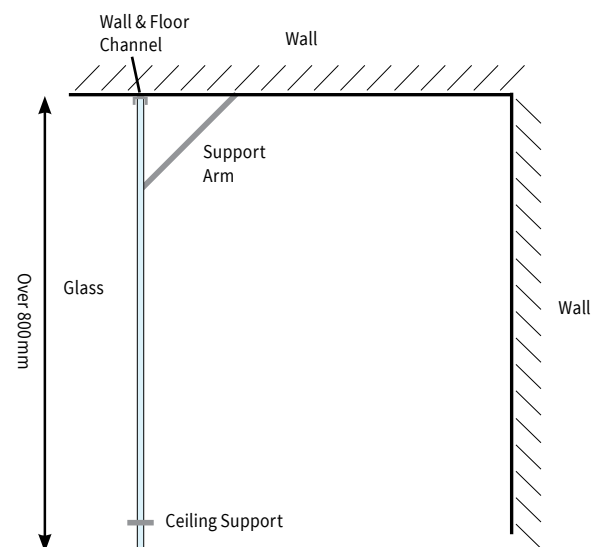

Note: These general options are suggestions only, there is no right or wrong way to support bespoke glass panels. Abacus Direct cannot be held responsible for the suggestions shown above as the designers and installers need to be comfortable with the correct level of support required for each project.



X Series Glass Panels

290mm - 1190mm WIDTH
10mm TOUGHENED SAFETY GLASS - 2.0m HIGH

The X Series begins with a range of 12 glass panels which can be used collectively or independently to create any shower combination you wish for. Specifically designed for use in wet rooms the X Series brings a timeless elegance to any shower setting.

X Series Bespoke Option

If you require a glass option outside our standard sizes please ring our sales office who will be pleased to quote you on any bespoke size. Options can include glass in different shapes and thicknesses and etched designs to your specification.

 **Easi-Clean**
glass coating technology



X SERIES GLASS PANELS – 290mm - 735mm WIDE

DESCRIPTION	WIDTH (mm)	HEIGHT (mm)	ADJUSTMENT (mm)	THICKNESS (mm)	PRODUCT CODE	PRICE
GLASS PANEL - 290mm WIDE	290	2000	Dependent on channel	10	VEGX-00-1005	£118.00
GLASS PANEL - 390mm WIDE	390	2000	Dependent on channel	10	VEGX-00-1010	£149.00
GLASS PANEL - 490mm WIDE	490	2000	Dependent on channel	10	VEGX-00-1015	£179.00
GLASS PANEL - 590mm WIDE	590	2000	Dependent on channel	10	VEGX-00-1020	£214.00
GLASS PANEL - 690mm WIDE	690	2000	Dependent on channel	10	VEGX-00-1025	£252.00
GLASS PANEL - 735mm WIDE	735	2000	Dependent on channel	10	VEGX-00-1030	£258.00

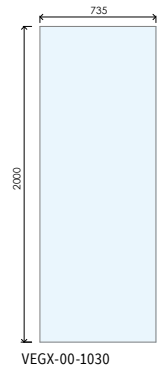
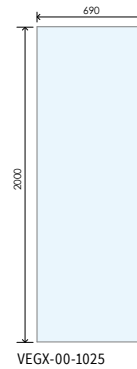
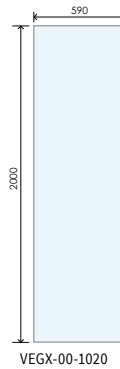
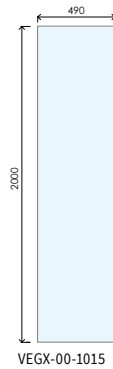
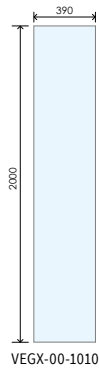
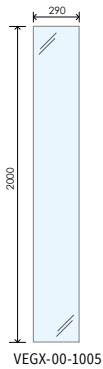

X SERIES GLASS PANELS – 790mm - 1190mm WIDE

DESCRIPTION	WIDTH (mm)	HEIGHT (mm)	ADJUSTMENT (mm)	THICKNESS (mm)	PRODUCT CODE	PRICE
GLASS PANEL - 790mm WIDE	790	2000	Dependent on channel	10	VEGX-00-1035	£282.00
GLASS PANEL - 835mm WIDE	835	2000	Dependent on channel	10	VEGX-00-1040	£294.00
GLASS PANEL - 890mm WIDE	890	2000	Dependent on channel	10	VEGX-00-1045	£348.00
GLASS PANEL - 990mm WIDE	990	2000	Dependent on channel	10	VEGX-00-1050	£372.00
GLASS PANEL - 1090mm WIDE	1090	2000	Dependent on channel	10	VEGX-00-1055	£450.00
GLASS PANEL - 1190mm WIDE	1190	2000	Dependent on channel	10	VEGX-00-1060	£477.00

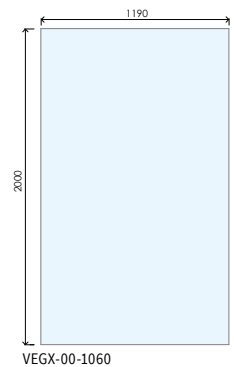
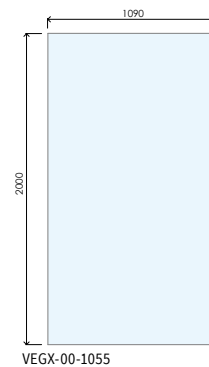
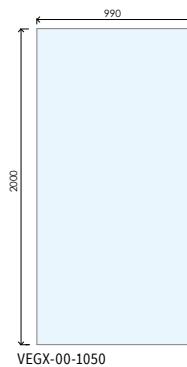
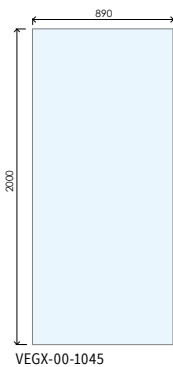
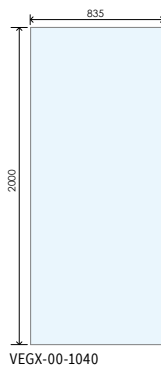
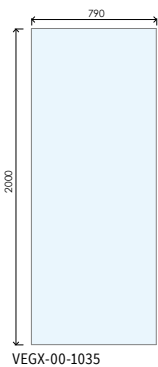



X Series Glass Channels & Clamps

SURFACE CHANNEL WITH CONCEALED SCREWS

X Series Surface Channel for 10mm Glass

FINISH	LENGTH (mm)	PRODUCT CODE	PRICE
POLISHED	1000	VEGX-80-0105	£14.40
POLISHED	2000	VEGX-80-0110	£28.80
BRUSHED NICKEL	1000	VEGX-80-0705	£21.60
BRUSHED NICKEL	2000	VEGX-80-0710	£35.40

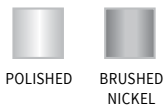
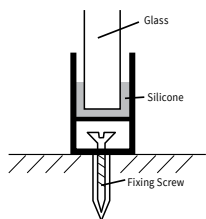

- Special two layered base for concealing screw heads
- Supplied with end caps

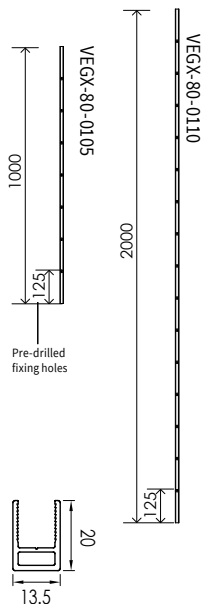

RECESSED CHANNEL

X Series Recessed Channel for 10mm Glass

FINISH	LENGTH (mm)	PRODUCT CODE	PRICE
POLISHED	1000	VEGX-80-0115	£14.40
POLISHED	2000	VEGX-80-0120	£28.80

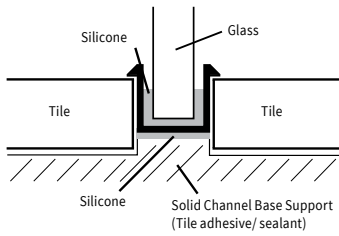

Channels used on the floor require base support to support glass weight

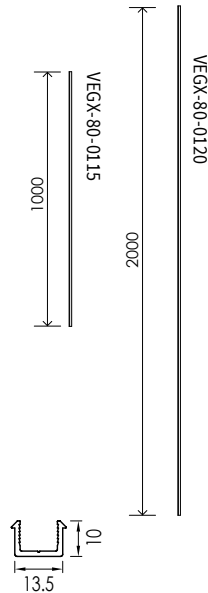

V-FIX CHANNEL - SILICONE-FREE

V-Fix Silicone-free Channel for 10mm Glass

FINISH	LENGTH (mm)	PRODUCT CODE	PRICE
POLISHED	1200	VEGC-80-0135	£30.60
POLISHED	2200	VEGC-80-0140	£47.40
BRUSHED NICKEL	1200	VEGC-80-0735	£34.80
BRUSHED NICKEL	2200	VEGC-80-0740	£52.20

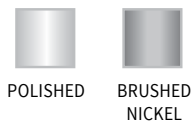
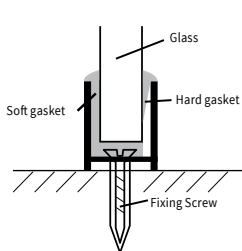

Can be adhered to floor tiled surfaces using Abacus Elements Fix-MD Adhesive

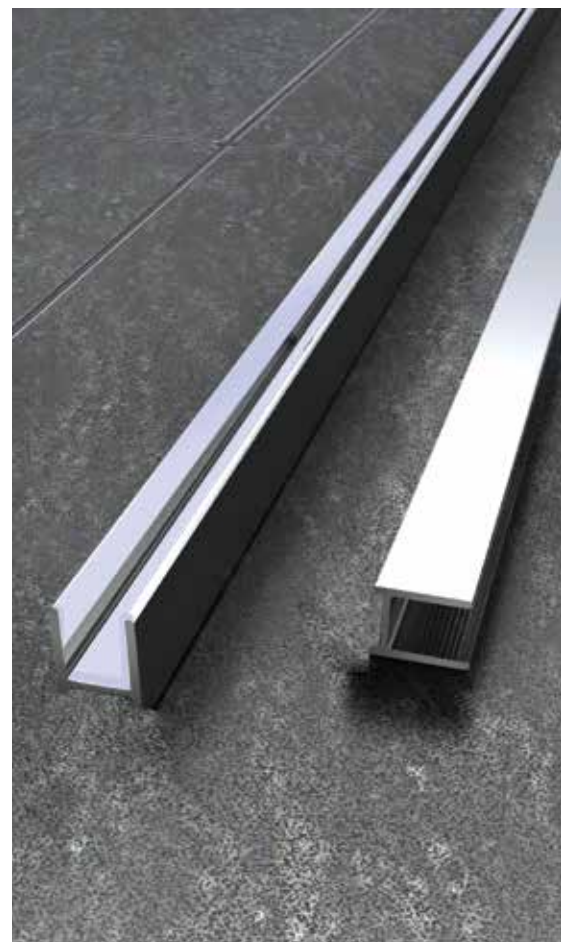
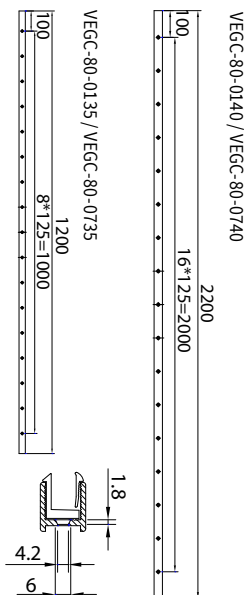

X Series Designer Wall & Ceiling Bars

X SERIES DESIGNER WALL SUPPORT ARM GLASS-WALL

LENGTH (mm)	PRODUCT CODE	PRICE
1000	VEGX-85-0320	£129.00
1200	VEGX-85-0325	£139.00

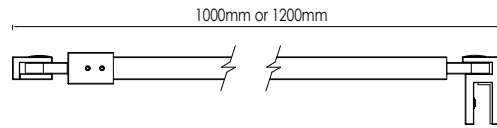

The support arms can be cut down to required length.



X SERIES DESIGNER CORNER SUPPORT ARM GLASS-GLASS & GLASS-WALL

LENGTH (mm)	PRODUCT CODE	PRICE
300	VEGX-85-0305	£78.00

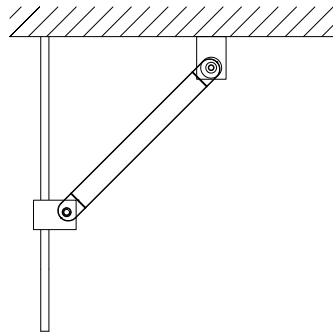

Supplied complete with fitting to support glass to glass and glass to wall.



X SERIES DESIGNER CEILING SUPPORT ARM GLASS-CEILING

HEIGHT (mm)	PRODUCT CODE	PRICE
400	VEGX-85-0310	£85.00
1200	VEGX-85-0315	£129.00

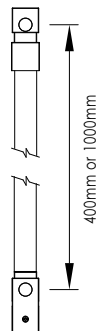

The support arms can be cut down to required length. To be used in conjunction with wall support.



X SERIES DOUBLE ROBE HOOK

LENGTH (mm)	PRODUCT CODE	PRICE
N/A	VEGX-90-0305	£25.80 (EACH)

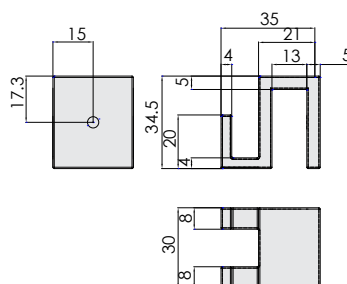

Clamps easily on to the top of all X Series glass panels.



X Series Support Bars & Accessories

X SERIES DESIGNER TOWEL HANGING BAR WITH GLASS SHELF

WIDTH (mm)	HEIGHT (mm)	PRODUCT CODE	PRICE
430	685	VEGX-90-0310	£119.50

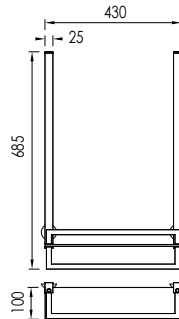

Hangs easily on to the top of all X Series glass panels.

STANDARD WALL SUPPORT ARM GLASS-WALL (TELESCOPIC)

LENGTH MAX-MIN (mm)	PRODUCT CODE	PRICE
780 - 1020	VEGC-05-0505	£58.80

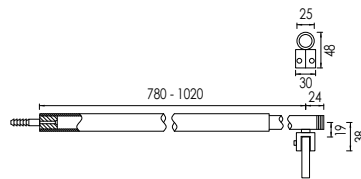

Minimum Adjustment - 780mm
Maximum Adjustment - 1020mm
For use on 8 - 12mm glass



STANDARD SUPPORT ARM GLASS-GLASS

LENGTH MAX-MIN (mm)	PRODUCT CODE	PRICE
980 - 1220	VEGC-05-0507	£58.80

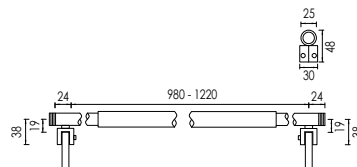

Minimum Adjustment - 980mm
Maximum Adjustment - 1220mm
For use on 8 - 12mm glass

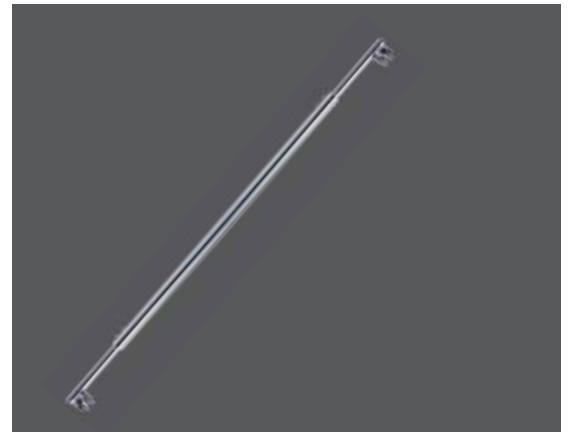

X Series Glass Channels & Clamps

MAKE YOUR OWN DESIGN OF GLASS WITH OUR
VERSATILE RANGE OF CHANNELS AND CLAMPS



X SERIES STRAIGHT CONNECTING CHANNEL 2000mm

HEIGHT (mm)	PRODUCT CODE	PRICE
2000	VEGX-80-0140	£38.40

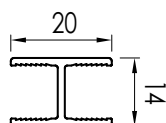

X SERIES 135 DEGREE CORNER CHANNEL 2000mm

HEIGHT (mm)	PRODUCT CODE	PRICE
2000	VEGX-80-0130	£38.40

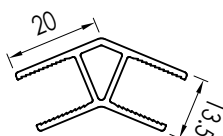

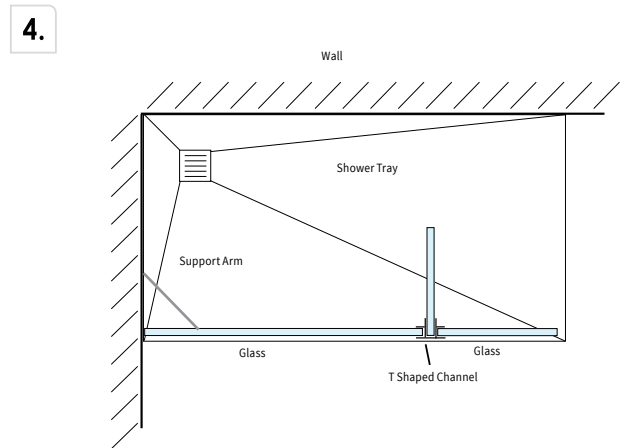
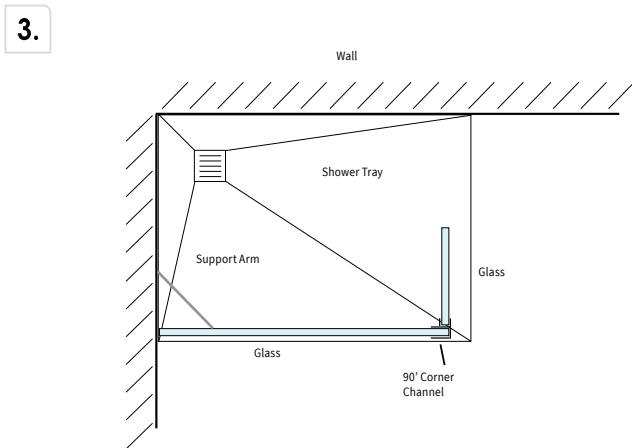
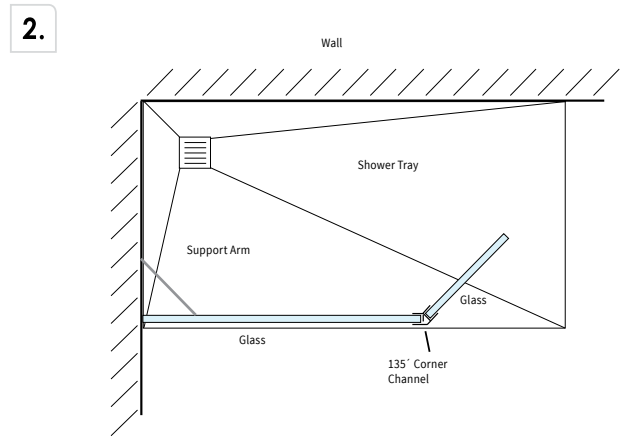
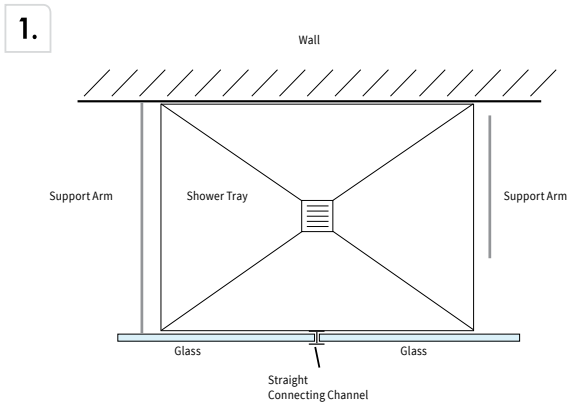

X SERIES 90 DEGREE CORNER CHANNEL 2000mm

HEIGHT (mm)	PRODUCT CODE	PRICE
2000	VEGX-80-0125	£38.40

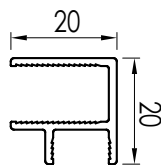

X SERIES T SHAPED CHANNEL 2000mm

HEIGHT (mm)	PRODUCT CODE	PRICE
2000	VEGX-80-0135	£42.00

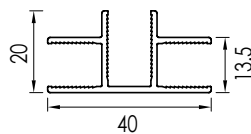



E SERIES WALK-IN GLASS SCREENS

The E Series offers the ultimate in affordable luxury. Incorporating a range of walk-in shower screens and end panels, bath screens and sliding shower screens.

The E Series comes with Easi-Clean Glass Coating Technology as standard.

Easi-Clean:

- Keeps glass looking like new
- Reduces water spots (limescale and mineral deposits)
- Is always easier to clean
- Stays cleaner for longer
- Significantly reduces the growth of bacteria



Walk-in Glass Screens

E SERIES





E Series
Walk-in Screens
& End Panels

6mm TOUGHENED SAFETY GLASS
1.85m HIGH

WALK-IN SHOWER SCREEN WITH 180° RETURN PANEL

DESCRIPTION	WIDTH (mm)	HEIGHT (mm)	ADJUSTMENT (mm)	THICKNESS (mm)	PRODUCT CODE	PRICE
WALK-IN SCREEN 700 + 350mm	700 + 350	1850	15	6	VEGE-10-1105	£546.00
WALK-IN SCREEN 900 + 350mm	900 + 350	1850	15	6	VEGE-10-1110	£582.00

 **Easi-Clean**
glass coating technology

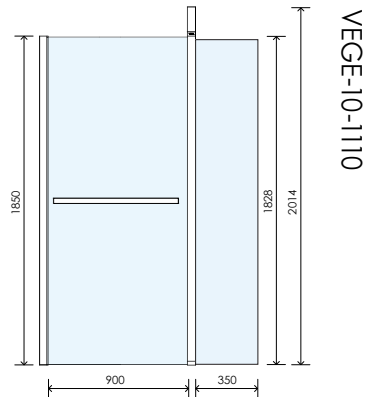
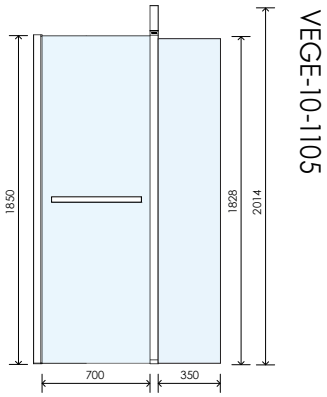

WALK-IN SHOWER SCREEN END PANEL

DESCRIPTION	WIDTH (mm)	HEIGHT (mm)	ADJUSTMENT (mm)	THICKNESS (mm)	PRODUCT CODE	PRICE
WALK-IN SCREEN END PANEL	700	1850	15	6	VEGE-05-1105	£450.00
WALK-IN SCREEN END PANEL	850	1850	15	6	VEGE-05-1110	£474.00

 **Easi-Clean**
glass coating technology

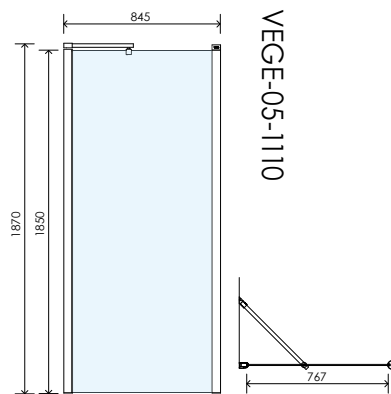
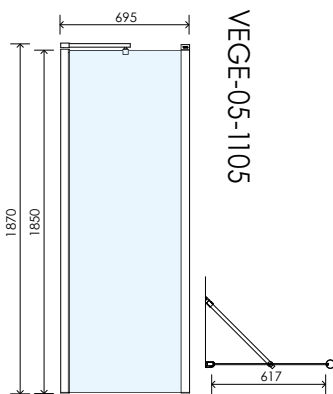

Curved Glass Walk-in Screen

E SERIES CURVED GLASS SCREEN 8mm TOUGHENED SAFETY GLASS - 2.0m HIGH

DESCRIPTION	WIDTH (mm)	HEIGHT (mm)	ADJUSTMENT (mm)	THICKNESS (mm)	PRODUCT CODE	PRICE
CURVED GLASS SCREEN - 1050mm WIDE	1050	2000	5	8	VEGE-12-1105	£630.00

Note: Glass Floor Fixing Clip included.

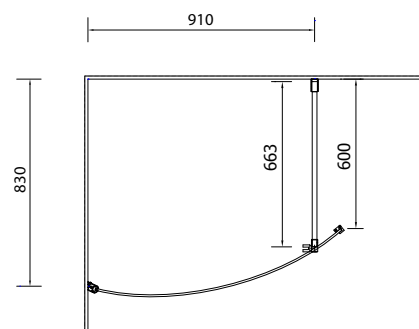
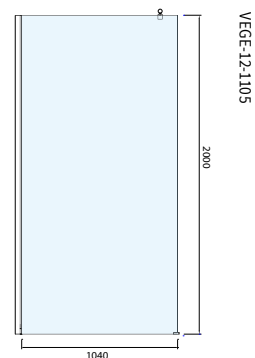

 Easi-Clean
glass coating technology

Curved Glass Screen



M SERIES DESIGNER WETROOM SHOWER SCREENS.

Elegant Simplicity

The M series 8mm wetroom screens incorporate a 350mm return splash panel and are available in two sizes to suit almost any size of wetroom, however small.

They feature elegant glass-to-glass hinges and a designer towel bar as standard.

There are also two matching end panels for these screens and all products come as standard with Easi-Clean technology.



Wetroom Glass

M SERIES





M Series Walk-in Screens & End Panels

8mm TOUGHENED SAFETY GLASS
2.0m HIGH

WALK-IN SHOWER SCREEN WITH 180° RETURN PANEL

DESCRIPTION	WIDTH (mm)	HEIGHT (mm)	ADJUSTMENT (mm)	THICKNESS (mm)	PRODUCT CODE	PRICE
WALK-IN SCREEN 700 + 350mm	700 + 350	2000	15	8	VEGM-10-1105	£718.00
WALK-IN SCREEN 900 + 350mm	900 + 350	2000	15	8	VEGM-10-1110	£750.00

 **Easi-Clean**
glass coating technology

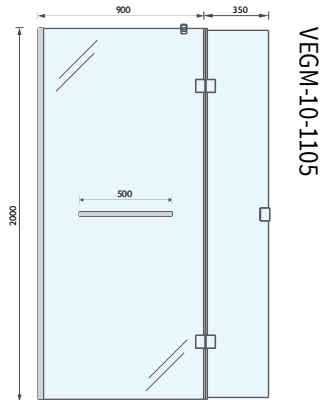
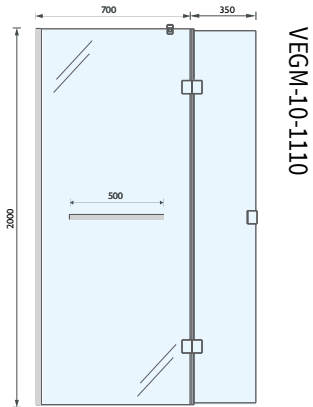

WALK-IN SHOWER SCREEN END PANEL

DESCRIPTION	WIDTH (mm)	HEIGHT (mm)	ADJUSTMENT (mm)	THICKNESS (mm)	PRODUCT CODE	PRICE
WALK-IN SCREEN END PANEL	700	2000	15	8	VEGM-05-1105	£372.00
WALK-IN SCREEN END PANEL	850	2000	15	8	VEGM-05-1110	£390.00

 **Easi-Clean**
glass coating technology

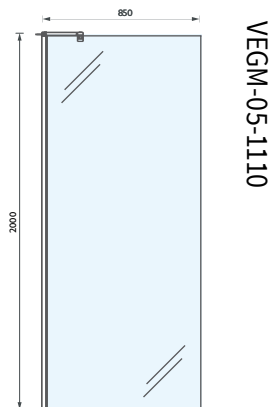
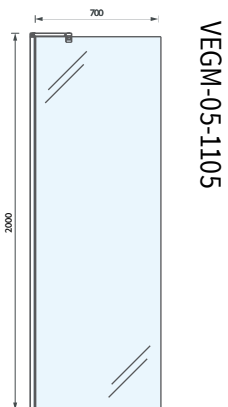

Bespoke Doors & Panels

CREATE YOUR OWN GLASS DESIGNS AND TURN YOUR DREAMS INTO A REALITY





Bespoke Doors & Panels

CREATE YOUR OWN DESIGN AND TURN YOUR DREAMS INTO A REALITY

As wet rooms and walk-in shower rooms become ever more popular, so does the production of bespoke glass screens. Curved or flat, clear or tinted; send us your ideas and get a quote for your unique design which will be produced for you to the highest quality.



Bespoke Doors & Panels

All glass is made out of safety toughened glass, standard components and can be ordered in a number of different finishes. With our range of hinges, handles and accessories and our ability to manufacture glass in almost any size and thickness you can create your own bespoke piece to meet your requirements.

Please contact your Abacus Bathrooms dealer or email us at enquiries@abacus-bathrooms.co.uk





Designer Bathroom Tiles

NATURAL STONE

PORCELAIN

SPECIALIST MOSAICS



The timeless beauty of natural stone

ADVICE ON NATURAL STONE PRODUCTS

Colour

Stone tiles are manufactured from natural materials so it is normal to experience colour variations within each pallet of material. This is part of the beauty of natural stone. Should you wish to enhance the colour of your stone then it should be sealed with colour enhancing sealer which greatly accentuates the colour of the stone.

Sealing

Natural stone tiles require sealing to protect them from staining. It is recommended that this be done twice - once prior to grouting and again after grouting. Ongoing additional cleaning and sealing may be required dependent on use.

Fixing

Stone tiles and large porcelain tiles can be quite heavy. We recommend that they are fixed onto a suitable substrate. The strength of the substrate should be checked prior to installation. For floors we recommend 10mm Elements Board. For walls we recommend a minimum of 12mm Elements Board.

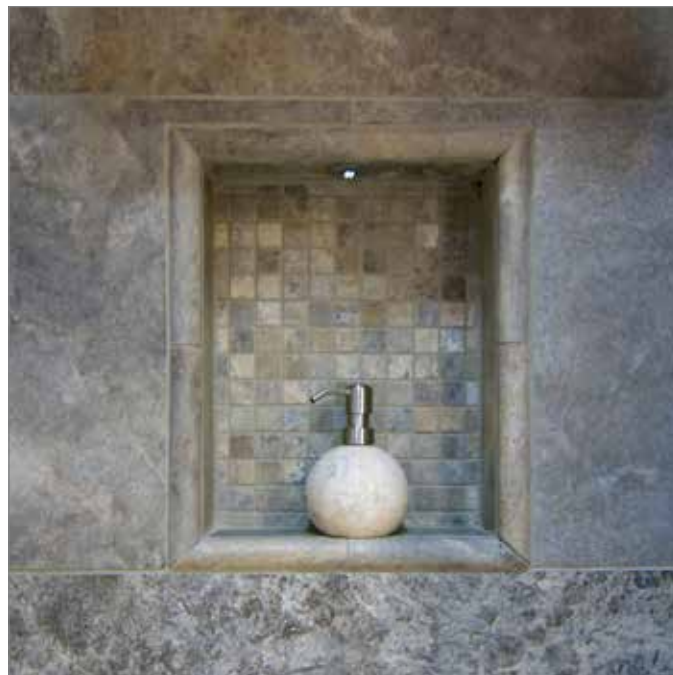



Beige Travertine



Our Travertine is 1st grade premium quality and is supplied in a 'honed' finish and filled to give an even surface.

Also unlike most other Travertine our tiles have chamfered edges to avoid sharp edges.

Natural stone tiles are formed geologically over millions of years and part of their beauty is their colour and shading variations. This should be appreciated before making your purchase. In addition it is important that your installer blends your natural tiles prior to installation to ensure that the shades are distributed evenly.

BEIGE TRAVERTINE MARBLE TILE

61cm x 40.6cm Chamfered Edge - Thickness = 1.2cm

	SUPPLIED IN POLYSTYRENE CARTONS
PRODUCT CODE	TLNT-05-0505
No. of tiles per sq.m	4.04
No. of tiles per carton	5
sq.m per carton	1.238
No. of tiles per crate	100
sq.m per crate	24.60
Price per sq.m	£63.81
Price per box	£79.00



BEIGE TRAVERTINE MARBLE TILE

40.6cm x 40.6cm Chamfered Edge - Thickness = 1.2cm

	SUPPLIED IN POLYSTYRENE CARTONS
PRODUCT CODE	TLNT-05-0510
No. of tiles per sq.m	6.07
No. of tiles per carton	5
sq.m per carton	0.824
No. of tiles per crate	100
sq.m per crate	16.4
Price per sq.m	£58.25
Price per box	£48.00



BEIGE TRAVERTINE MARBLE BORDER TILE

2.7cm x 30.5cm x 2.0cm

	SUPPLIED IN POLYSTYRENE CARTONS
PRODUCT CODE	TLNT-05-2005
No. of pieces per box	53
Price per piece	£13.00



TRAVERTINE MARBLE MOSAIC BEIGE 3 COLOUR MIX

30cm x 30cm x 1.0cm (mesh mat)

PRODUCT CODE	TLNT-05-1505
No. of sheets per box	5
sq.m per box	0.465
Boxes per crate	81
sq.m per crate	37.67
Price per box	£41.00

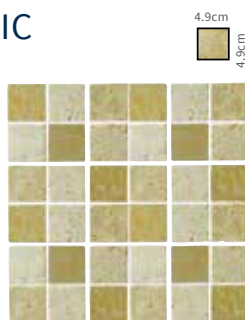

TRAVERTINE MARBLE MOSAIC BEIGE SINGLE COLOUR

30cm x 30cm x 1.0cm (mesh mat)

PRODUCT CODE	TLNT-05-1520
No. of sheets per box	5
sq.m per box	0.465
Boxes per crate	81
sq.m per crate	37.67
Price per box	£41.00



TRAVERTINE MARBLE MOSAIC BEIGE 3 COLOUR MIX

30cm x 30cm x 1.0cm (mesh mat)

PRODUCT CODE	TLNT-05-1510
No. of sheets per box	5
sq.m per box	0.465
Boxes per crate	81
sq.m per crate	37.67
Price per box	£52.00



TRAVERTINE MARBLE MOSAIC BEIGE SINGLE COLOUR

30cm x 30cm x 1.0cm (mesh mat)

PRODUCT CODE	TLNT-05-1525
No. of sheets per box	5
sq.m per box	0.465
Boxes per crate	81
sq.m per crate	37.67
Price per box	£52.00

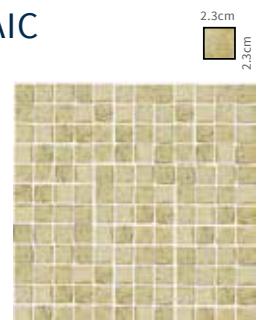

Note: We recommend that Travertine is used in a bathroom environment only, and not for higher traffic areas or commercial applications.

All prices inclusive of VAT. All tiles supplied on an ex-works basis.

Silver Travertine

Silver Travertine, formed by the deposition of calcium carbonate by springs and rivers is a beautiful and unique colour of Travertine. Its bold shading and banding is caused by a mixture of iron and organic compounds.

Natural stone tiles are formed geologically over millions of years and part of their beauty is their colour and shading variations. This should be appreciated before making your purchase. In addition it is important that your installer blends your natural tiles prior to installation to ensure that the shades are distributed evenly.

SILVER TRAVERTINE MARBLE TILE

61cm x 40.6cm Chamfered Edge - Thickness = 1.2cm

	SUPPLIED IN POLYSTYRENE CARTONS
PRODUCT CODE	TLNT-10-0505
No. of tiles per sq.m	4.04
No. of tiles per carton	5
sq.m per carton	1.238
No. of tiles per crate	100
sq.m per crate	24.60
Price per sq.m	£79.97
Price per box	£99.00

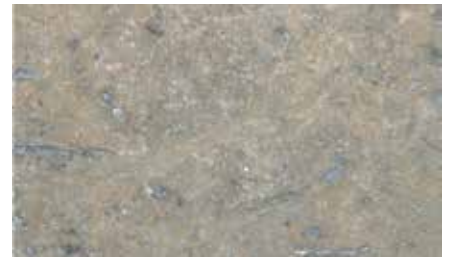
**SILVER TRAVERTINE MARBLE TILE**

40.6cm x 40.6cm Chamfered Edge - Thickness = 1.2cm

	SUPPLIED IN POLYSTYRENE CARTONS
PRODUCT CODE	TLNT-10-0510
No. of tiles per sq.m	6.07
No. of tiles per carton	5
sq.m per carton	0.824
No. of tiles per crate	100
sq.m per crate	16.4
Price per sq.m	£77.67
Price per box	£64.00

**SILVER TRAVERTINE MARBLE BORDER TILE**

2.7cm x 30.5cm x 2.0cm

	SUPPLIED IN POLYSTYRENE CARTONS
PRODUCT CODE	TLNT-10-2005
No. of pieces per box	53
Price per piece	£14.00

**SILVER TRAVERTINE MARBLE MOSAIC**

30cm x 30cm x 1.0cm (mesh mat) SINGLE COLOUR

	TLNT-10-1505
PRODUCT CODE	TLNT-10-1505
No. of sheets per box	5
sq.m per box	0.465
Boxes per crate	81
sq.m per crate	37.67
Price per box	£47.00

**SILVER TRAVERTINE MARBLE MOSAIC**

30cm x 30cm x 1.0cm (mesh mat) SINGLE COLOUR

	TLNT-10-1510
PRODUCT CODE	TLNT-10-1510
No. of sheets per box	5
sq.m per box	0.465
Boxes per crate	81
sq.m per crate	37.67
Price per box	£58.00



Note: We recommend that Travertine is used in a bathroom environment only, and not for higher traffic areas or commercial applications.

All prices inclusive of VAT. All tiles supplied on an ex-works basis.

Porcelain stoneware

RE-CREATING THE BEST OF NATURAL MARBLE & LIMESTONES

A stylish and practical alternative to natural stone, porcelain makes for a low maintenance floor or wall covering. Look out for our exciting ranges; whether they cleverly replicate the beauty of natural stone or offer that urban, minimalistic look, our Porcelain collection covers all bases.

Porcelain tiles are a type of ceramic with a very low absorbency. They are usually made from kaolin clays and fired at around 1,200°C, due to this high firing temperature and high density they are very hardwearing. A majority of our Porcelains are 'rectified', which means there will be little variation in size.

Porcelains are usually colour glazed to give a matt or gloss finish. Unlike natural stone they do not require continuous sealing. We recommend just one coat after installation.

As with all tiles, due to the manufacturing process, shading variation may occur between batches.





Designer Bathroom Tiles

PORCELAIN

Area Beige



AREA BEIGE TILE

60cm x 60cm Matt Finish Rectified Porcelain - Thickness = 1.0cm

	SUPPLIED IN BOXES
PRODUCT CODE	TLCT-42-0606
No. of tiles per sq.m	2.77
No. of tiles per box	3
No. of boxes per pallet	40
sq.m per box	1.08
sq.m per pallet	43.2
Price per sq.m	£45.37
Price per box	£49.00



AREA BEIGE TILE

60cm x 30cm Matt Finish Rectified Porcelain - Thickness = 1.0cm

	SUPPLIED IN BOXES
PRODUCT CODE	TLCT-42-0306
No. of tiles per sq.m	5.55
No. of tiles per box	6
No. of boxes per pallet	48
sq.m per box	1.08
sq.m per pallet	51.84
Price per sq.m	£45.37
Price per box	£49.00



AREA BEIGE MOSAIC

30cm x 30cm Matt Finish Rectified Porcelain - Thickness = 1.0cm

	TLCT-42-1505
PRODUCT CODE	TLCT-42-1505
No. of sheets per sq.m	11.1
No. of sheets per box	9
No. of boxes per pallet	36
sq.m per box	0.81
sq.m per pallet	29.16
Price per box	£99.00



Area Grey



AREA GREY TILE

60cm x 60cm Matt Finish Rectified Porcelain - Thickness = 1.0cm

	SUPPLIED IN BOXES
PRODUCT CODE	TLCT-44-0606
No. of tiles per sq.m	2.77
No. of tiles per box	3
No. of boxes per pallet	40
sq.m per box	1.08
sq.m per pallet	43.2
Price per sq.m	£45.37
Price per box	£49.00



AREA GREY TILE

60cm x 30cm Matt Finish Rectified Porcelain - Thickness = 1.0cm

	SUPPLIED IN BOXES
PRODUCT CODE	TLCT-44-0306
No. of tiles per sq.m	5.55
No. of tiles per box	6
No. of boxes per pallet	48
sq.m per box	1.08
sq.m per pallet	51.84
Price per sq.m	£45.37
Price per box	£49.00



AREA GREY MOSAIC

30cm x 30cm Matt Finish Rectified Porcelain - Thickness = 1.0cm

	TLCT-44-1505
No. of sheets per sq.m	11.1
No. of sheets per box	9
No. of boxes per pallet	36
sq.m per box	0.81
sq.m per pallet	29.16
Price per box	£99.00



Lastra





Available in four colours:
Grey, Beige, Almond & Dark Grey

LASTRA GREY TILE

120cm x 60cm Matt Finish Rectified Porcelain
Thickness = 1.0cm

	SUPPLIED IN BOXES
PRODUCT CODE	TLCT-83-0612
No. of tiles per sq.m	1.39
No. of tiles per box	2
No. of boxes per pallet	27
sq.m per box	1.44
sq.m per pallet	38.88
Price per sq.m	£76.39
Price per box	£110.00



Also available with 'ribbed' finish - see page 300

LASTRA GREY TILE

60cm x 60cm Matt Finish Rectified Porcelain - Thickness = 1.0cm

	SUPPLIED IN BOXES
PRODUCT CODE	TLCT-83-0560
No. of tiles per sq.m	2.77
No. of tiles per box	3
No. of boxes per pallet	32
sq.m per box	1.08
sq.m per pallet	34.50
Price per sq.m	£53.70
Price per box	£58.00



LASTRA GREY TILE

60cm x 30cm Matt Finish Rectified Porcelain - Thickness = 1.0cm

	SUPPLIED IN BOXES
PRODUCT CODE	TLCT-83-0536
No. of tiles per sq.m	5.55
No. of tiles per box	5
No. of boxes per pallet	48
sq.m per box	0.9
sq.m per pallet	43.2
Price per sq.m	£50.56
Price per box	£45.50



LASTRA GREY MOSAIC

30cm x 30cm Matt Finish Rectified Porcelain - Thickness = 1.0cm

	TLCT-83-1530
PRODUCT CODE	TLCT-83-1530
No. of sheets per sq.m	11.1
No. of sheets per box	4
No. of boxes per pallet	72
sq.m per box	0.36
sq.m per pallet	25.92
Price per box	£59.50

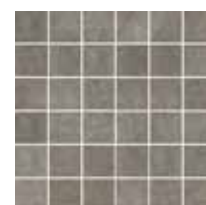

LASTRA BEIGE TILE

120cm x 60cm Matt Finish Rectified Porcelain
Thickness = 1.0cm

	SUPPLIED IN BOXES
PRODUCT CODE	TLCT-82-0612
No. of tiles per sq.m	1.39
No. of tiles per box	2
No. of boxes per pallet	27
sq.m per box	1.44
sq.m per pallet	38.88
Price per sq.m	£76.39
Price per box	£110.00



Also available with 'ribbed' finish - see page 300

LASTRA BEIGE TILE

60cm x 60cm Matt Finish Rectified Porcelain - Thickness = 1.0cm

	SUPPLIED IN BOXES
PRODUCT CODE	TLCT-82-0560
No. of tiles per sq.m	2.77
No. of tiles per box	3
No. of boxes per pallet	32
sq.m per box	1.08
sq.m per pallet	34.50
Price per sq.m	£53.70
Price per box	£58.00



LASTRA BEIGE TILE

60cm x 30cm Matt Finish Rectified Porcelain - Thickness = 1.0cm

	SUPPLIED IN BOXES
PRODUCT CODE	TLCT-82-0536
No. of tiles per sq.m	5.55
No. of tiles per box	5
No. of boxes per pallet	48
sq.m per box	0.9
sq.m per pallet	43.2
Price per sq.m	£50.56
Price per box	£45.50



LASTRA BEIGE MOSAIC

30cm x 30cm Matt Finish Rectified Porcelain - Thickness = 1.0cm

	TLCT-82-1530
PRODUCT CODE	TLCT-82-1530
No. of sheets per sq.m	11.1
No. of sheets per box	4
No. of boxes per pallet	72
sq.m per box	0.36
sq.m per pallet	25.92
Price per box	£59.50

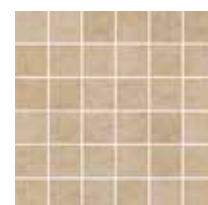

LASTRA ALMOND TILE

120cm x 60cm Matt Finish Rectified Porcelain
Thickness = 1.0cm

	SUPPLIED IN BOXES
PRODUCT CODE	TLCT-81-0612
No. of tiles per sq.m	1.39
No. of tiles per box	2
No. of boxes per pallet	27
sq.m per box	1.44
sq.m per pallet	38.88
Price per sq.m	£76.39
Price per box	£110.00



Also available with 'ribbed' finish - see page 300

LASTRA ALMOND TILE

60cm x 60cm Matt Finish Rectified Porcelain - Thickness = 1.0cm

	SUPPLIED IN BOXES
PRODUCT CODE	TLCT-81-0560
No. of tiles per sq.m	2.77
No. of tiles per box	3
No. of boxes per pallet	32
sq.m per box	1.08
sq.m per pallet	34.50
Price per sq.m	£53.70
Price per box	£58.00



LASTRA ALMOND TILE

60cm x 30cm Matt Finish Rectified Porcelain - Thickness = 1.0cm

	SUPPLIED IN BOXES
PRODUCT CODE	TLCT-81-0536
No. of tiles per sq.m	5.55
No. of tiles per box	5
No. of boxes per pallet	48
sq.m per box	0.9
sq.m per pallet	43.2
Price per sq.m	£50.56
Price per box	£45.50



LASTRA ALMOND MOSAIC

30cm x 30cm Matt Finish Rectified Porcelain - Thickness = 1.0cm

	TLCT-81-1530
PRODUCT CODE	TLCT-81-1530
No. of sheets per sq.m	11.1
No. of sheets per box	4
No. of boxes per pallet	72
sq.m per box	0.36
sq.m per pallet	25.92
Price per box	£59.50



LASTRA DARK GREY TILE

120cm x 60cm Matt Finish Rectified Porcelain
Thickness = 1.0cm

	SUPPLIED IN BOXES
PRODUCT CODE	TLCT-84-0612
No. of tiles per sq.m	1.39
No. of tiles per box	2
No. of boxes per pallet	27
sq.m per box	1.44
sq.m per pallet	38.88
Price per sq.m	£76.39
Price per box	£110.00



Also available with 'ribbed' finish - see page 300

LASTRA DARK GREY TILE

60cm x 60cm Matt Finish Rectified Porcelain - Thickness = 1.0cm

	SUPPLIED IN BOXES
PRODUCT CODE	TLCT-84-0560
No. of tiles per sq.m	2.77
No. of tiles per box	3
No. of boxes per pallet	32
sq.m per box	1.08
sq.m per pallet	34.50
Price per sq.m	£53.70
Price per box	£58.00



LASTRA DARK GREY TILE

60cm x 30cm Matt Finish Rectified Porcelain - Thickness = 1.0cm

	SUPPLIED IN BOXES
PRODUCT CODE	TLCT-84-0536
No. of tiles per sq.m	5.55
No. of tiles per box	5
No. of boxes per pallet	48
sq.m per box	0.9
sq.m per pallet	43.2
Price per sq.m	£50.56
Price per box	£45.50



LASTRA DARK GREY MOSAIC

30cm x 30cm Matt Finish Rectified Porcelain - Thickness = 1.0cm

	TLCT-84-1530
PRODUCT CODE	TLCT-84-1530
No. of sheets per sq.m	11.1
No. of sheets per box	4
No. of boxes per pallet	72
sq.m per box	0.36
sq.m per pallet	25.92
Price per box	£59.50



LASTRA GREY RIBBED

120cm x 60cm Matt Finish Rectified Porcelain
Thickness = 1.0cm

	SUPPLIED IN BOXES
PRODUCT CODE	TLCT-83-R612
No. of tiles per sq.m	1.39
No. of tiles per box	2
No. of boxes per pallet	27
sq.m per box	1.44
sq.m per pallet	38.88
Price per sq.m	£82.99
Price per box	£119.50



LASTRA BEIGE RIBBED

120cm x 60cm Matt Finish Rectified Porcelain
Thickness = 1.0cm

	SUPPLIED IN BOXES
PRODUCT CODE	TLCT-82-R612
No. of tiles per sq.m	1.39
No. of tiles per box	2
No. of boxes per pallet	27
sq.m per box	1.44
sq.m per pallet	38.88
Price per sq.m	£82.99
Price per box	£119.50



LASTRA ALMOND RIBBED

120cm x 60cm Matt Finish Rectified Porcelain
Thickness = 1.0cm

	SUPPLIED IN BOXES
PRODUCT CODE	TLCT-81-R612
No. of tiles per sq.m	1.39
No. of tiles per box	2
No. of boxes per pallet	27
sq.m per box	1.44
sq.m per pallet	38.88
Price per sq.m	£82.99
Price per box	£119.50



LASTRA DARK GREY RIBBED

120cm x 60cm Matt Finish Rectified Porcelain
Thickness = 1.0cm

	SUPPLIED IN BOXES
PRODUCT CODE	TLCT-84-R612
No. of tiles per sq.m	1.39
No. of tiles per box	2
No. of boxes per pallet	27
sq.m per box	1.44
sq.m per pallet	38.88
Price per sq.m	£82.99
Price per box	£119.50





R11 SLIP RESISTANCE

LAMIERA ANTHRACITE METALLIC FEATURE TILE

60cm x 30cm Semi-polished Finish Rectified Porcelain - Thickness = 1.0cm

	SUPPLIED IN BOXES
PRODUCT CODE	TLCT-87-0536
No. of tiles per sq.m	5.55
No. of tiles per box	5
No. of boxes per pallet	48
sq.m per box	0.9
sq.m per pallet	43.2
Price per sq.m	£110.56
Price per box	£99.50



LAMIERA BROWN METALLIC FEATURE TILE

60cm x 30cm Semi-polished Finish Rectified Porcelain - Thickness = 1.0cm

	SUPPLIED IN BOXES
PRODUCT CODE	TLCT-88-0536
No. of tiles per sq.m	5.55
No. of tiles per box	5
No. of boxes per pallet	48
sq.m per box	0.9
sq.m per pallet	43.2
Price per sq.m	£110.56
Price per box	£99.50





Genus White Marble



GENUS WHITE POLISHED TILE120cm x 60cm Polished Finish Rectified Porcelain
Thickness = 1.1 cm - Full Body

	SUPPLIED IN BOXES
PRODUCT CODE	TLCT-35-0612
No. of tiles per sq.m	1.39
No. of tiles per box	2
No. of boxes per pallet	27
sq.m per box	1.44
sq.m per pallet	38.88
Price per sq.m	£98.96
Price per box	£142.50

**GENUS WHITE POLISHED TILE**

60cm x 60cm Polished Finish Rectified Porcelain Thickness = 1.1 cm - Full Body

	SUPPLIED IN BOXES
PRODUCT CODE	TLCT-35-0606
No. of tiles per sq.m	2.78
No. of tiles per box	3
No. of boxes per pallet	32
sq.m per box	1.08
sq.m per pallet	34.50
Price per sq.m	£99.07
Price per box	£107.00

**GENUS WHITE MATT MOSAIC TILE**

30cm x 30cm Rectified Porcelain Thickness = 1.0cm

	PRODUCT CODE
No. of sheets per sq.m	11.1
No. of sheets per box	6
No. of boxes per pallet	N/A
sq.m per box	0.54
sq.m per pallet	N/A
Price per box	£59.00

**GENUS WHITE SMALL MIXED MOSAIC TILE (MATT & POLISHED)**

30cm x 30cm Rectified Porcelain Thickness = 1.0cm

	PRODUCT CODE
No. of sheets per sq.m	11.1
No. of sheets per box	6
No. of boxes per pallet	N/A
sq.m per box	0.54
sq.m per pallet	N/A
Price per box	£99.00



Genus Beige Marble



GENUS BEIGE POLISHED TILE120cm x 60cm Polished Finish Rectified Porcelain
Thickness = 1.1 cm - Full Body

	SUPPLIED IN BOXES
PRODUCT CODE	TLCT-36-0612
No. of tiles per sq.m	1.39
No. of tiles per box	2
No. of boxes per pallet	27
sq.m per box	1.44
sq.m per pallet	38.88
Price per sq.m	£89.58
Price per box	£129.00

**GENUS BEIGE POLISHED TILE**

60cm x 60cm Polished Finish Rectified Porcelain Thickness = 1.1 cm - Full Body

	SUPPLIED IN BOXES
PRODUCT CODE	TLCT-36-0606
No. of tiles per sq.m	2.78
No. of tiles per box	3
No. of boxes per pallet	32
sq.m per box	1.08
sq.m per pallet	34.50
Price per sq.m	£89.81
Price per box	£97.00

**GENUS BEIGE MATT MOSAIC TILE**

30cm x 30cm Rectified Porcelain Thickness = 1.0cm

	PRODUCT CODE
No. of sheets per sq.m	11.1
No. of sheets per box	6
No. of boxes per pallet	N/A
sq.m per box	0.54
sq.m per pallet	N/A
Price per box	£59.00

**GENUS BEIGE SMALL MIXED MOSAIC TILE (MATT & POLISHED)**

30cm x 30cm Rectified Porcelain Thickness = 1.0cm

	PRODUCT CODE
No. of sheets per sq.m	11.1
No. of sheets per box	6
No. of boxes per pallet	N/A
sq.m per box	0.54
sq.m per pallet	N/A
Price per box	£99.00





Orobianco White Travertine

OROBIANCO WHITE POLISHED TILE

120cm x 60cm Polished Finish Rectified Porcelain
Thickness = 1.0cm

	SUPPLIED IN BOXES
PRODUCT CODE	TLCT-20-0612
No. of tiles per sq.m	1.39
No. of tiles per box	2
No. of boxes per pallet	27
sq.m per box	1.44
sq.m per pallet	38.88
Price per sq.m	£99.65
Price per box	£143.50



OROBIANCO WHITE MATT TILE

60cm x 60cm Matt Finish Rectified Porcelain Thickness = 1.0cm

	SUPPLIED IN BOXES
PRODUCT CODE	TLCT-20-0606
No. of tiles per sq.m	2.78
No. of tiles per box	3
No. of boxes per pallet	32
sq.m per box	1.08
sq.m per pallet	34.50
Price per sq.m	£67.13
Price per box	£72.50



OROBIANCO WHITE MATT MOSAIC TILE

30cm x 30cm Matt Finish Rectified Porcelain Thickness = 1.0cm

	TLCT-20-1530
PRODUCT CODE	TLCT-20-1530
No. of sheets per sq.m	11.1
No. of sheets per box	6
No. of boxes per pallet	N/A
sq.m per box	0.54
sq.m per pallet	N/A
Price per box	£99.50



Orobianco Beige Travertine



OROBIANCO BEIGE POLISHED TILE

120cm x 60cm Polished Finish Rectified Porcelain
Thickness = 1.0cm

	SUPPLIED IN BOXES
PRODUCT CODE	TLCT-22-0612
No. of tiles per sq.m	1.39
No. of tiles per box	2
No. of boxes per pallet	27
sq.m per box	1.44
sq.m per pallet	38.88
Price per sq.m	£99.65
Price per box	£143.50



OROBIANCO BEIGE MATT TILE

60cm x 60cm Matt Finish Rectified Porcelain Thickness = 1.0cm

	SUPPLIED IN BOXES
PRODUCT CODE	TLCT-22-0606
No. of tiles per sq.m	2.77
No. of tiles per box	3
No. of boxes per pallet	32
sq.m per box	1.08
sq.m per pallet	34.50
Price per sq.m	£67.13
Price per box	£72.50



OROBIANCO BEIGE MATT MOSAIC TILE

30cm x 30cm Matt Finish Rectified Porcelain Thickness = 1.0cm

	TLCT-22-1530
PRODUCT CODE	TLCT-22-1530
No. of sheets per sq.m	11.1
No. of sheets per box	6
No. of boxes per pallet	N/A
sq.m per box	0.54
sq.m per pallet	N/A
Price per box	£99.50





Noce Natural Oak Porcelain Tile

NOCE NATURAL OAK PLANK TILE

120cm x 20cm Semi-polished Finish Rectified Porcelain - Thickness = 1.05cm

	SUPPLIED IN BOXES
PRODUCT CODE	TLCT-40-2012
No. of tiles per sq.m	4.17
No. of tiles per box	6
No. of boxes per pallet	32
sq.m per box	1.44
sq.m per pallet	46.08
Price per sq.m	£81.60
Price per box	£117.50



Nirvana White Oak Porcelain Tile

NIRVANA WHITE OAK PLANK TILE

120cm x 20cm Semi-polished Finish Rectified Porcelain - Thickness = 1.05cm

	SUPPLIED IN BOXES
PRODUCT CODE	TLCT-70-2012
No. of tiles per sq.m	4.17
No. of tiles per box	6
No. of boxes per pallet	32
sq.m per box	1.44
sq.m per pallet	46.08
Price per sq.m	£81.60
Price per box	£117.50





STONE, GLASS, MIXED, PEBBLE

The specialist mosaic tiles offered in this section allow the creative bathroom designer the ability to achieve total individuality and innovation in design.

The mosaics can be purchased in individual sheets so you never have to buy more than you require!

Specialist mosaic tiles





STONE - SQUARE ANTHRACITE

30.5cm x 30.5cm A1005



PRODUCT CODE	TLSM-05-1005
Sheet Size (mm)	305 x 305
No. of Sheets per sq.m	10.75
No. of Sheets Per Box	11
Weight per Sheet (g)	2250g
Price per sheet	£14.50



STONE - BRICK ANTHRACITE

30.5cm x 30.5cm A1010



PRODUCT CODE	TLSM-05-1010
Sheet Size (mm)	305 x 305
No. of Sheets per sq.m	10.75
No. of Sheets Per Box	11
Weight per Sheet (g)	2250g
Price per sheet	£14.50



STONE - PENCIL ANTHRACITE

30.5cm x 30.5cm A1015



PRODUCT CODE	TLSM-05-1015
Sheet Size (mm)	305 x 305
No. of Sheets per sq.m	10.75
No. of Sheets Per Box	11
Weight per Sheet (g)	2250g
Price per sheet	£16.50



STONE - SQUARE NATURAL

30.5cm x 30.5cm A1020



PRODUCT CODE	TLSM-05-1020
Sheet Size (mm)	305 x 305
No. of Sheets per sq.m	10.75
No. of Sheets Per Box	11
Weight per Sheet (g)	2250g
Price per sheet	£16.50



STONE - BRICK NATURAL

30.5cm x 30.5cm A1025



PRODUCT CODE	TLSM-05-1025
Sheet Size (mm)	305 x 305
No. of Sheets per sq.m	10.75
No. of Sheets Per Box	11
Weight per Sheet (g)	2250g
Price per sheet	£16.50



STONE - PENCIL NATURAL

30.5cm x 30.5cm A1030

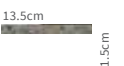

PRODUCT CODE	TLSM-05-1030
Sheet Size (mm)	305 x 305
No. of Sheets per sq.m	10.75
No. of Sheets Per Box	11
Weight per Sheet (g)	2250g
Price per sheet	£16.50



STONE - SQUARE MIXED BROWN

30.5cm x 30.5cm A1035



PRODUCT CODE	TLSM-05-1035
Sheet Size (mm)	305 x 305
No. of Sheets per sq.m	10.75
No. of Sheets Per Box	11
Weight per Sheet (g)	2250g
Price per sheet	£16.50



STONE - RANDOM PENCIL MIXED BROWN

30.5cm x 30.5cm A1040

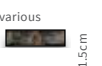

PRODUCT CODE	TLSM-05-1040
Sheet Size (mm)	305 x 305
No. of Sheets per sq.m	10.75
No. of Sheets Per Box	11
Weight per Sheet (g)	2250g
Price per sheet	£16.50





Glass

GLASS - SQUARE BROWN

32.7cm x 32.75cm B1005

PRODUCT CODE	TLSM-10-1005
Sheet Size (mm)	327 x 327
No. of Sheets per sq.m	9.35
No. of Sheets Per Box	20
Weight per Sheet (g)	685g
Price per sheet	£11.00

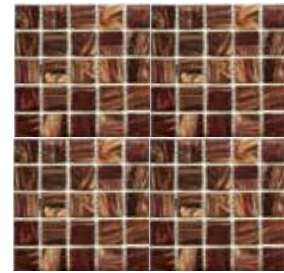
**GLASS - SQUARE BLUE**

32.7cm x 32.75cm B1010

PRODUCT CODE	TLSM-10-1010
Sheet Size (mm)	327 x 327
No. of Sheets per sq.m	9.35
No. of Sheets Per Box	20
Weight per Sheet (g)	685g
Price per sheet	£11.00

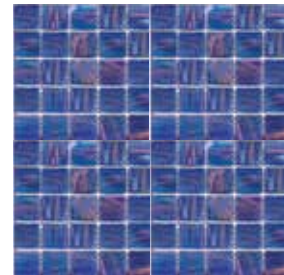
**GLASS - SQUARE COPPER BRONZE SILVER MIX**

30cm x 30cm B1015

PRODUCT CODE	TLSM-10-1015
Sheet Size (mm)	300 x 300
No. of Sheets per sq.m	11.1
No. of Sheets Per Box	11
Weight per Sheet (g)	1600g
Price per sheet	£19.50

**GLASS - SQUARE BRONZE & BLACK MIX**

30cm x 30cm B1020

PRODUCT CODE	TLSM-10-1020
Sheet Size (mm)	300 x 300
No. of Sheets per sq.m	11.1
No. of Sheets Per Box	11
Weight per Sheet (g)	1600g
Price per sheet	£19.50

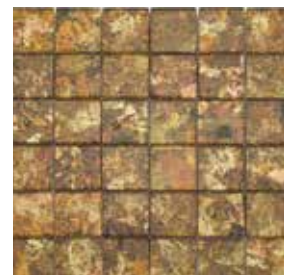



MIXED - SQUARE BLACK & CHROME - SMALL

30cm x 30cm C1005

PRODUCT CODE	TLSM-15-1005
Sheet Size (mm)	300 x 300
No. of Sheets per sq.m	11.1
No. of Sheets Per Box	11
Weight per Sheet (g)	1400g
Price per sheet	£24.50

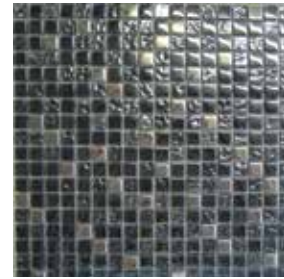
**MIXED - SQUARE BLACK & CHROME - LARGE**

30cm x 30cm C1010

PRODUCT CODE	TLSM-15-1010
Sheet Size (mm)	300 x 300
No. of Sheets per sq.m	11.1
No. of Sheets Per Box	11
Weight per Sheet (g)	1427g
Price per sheet	£23.00

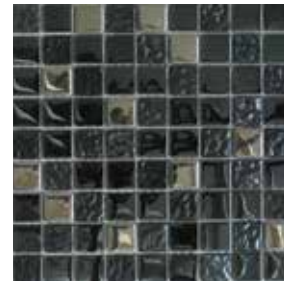
**MIXED - SQUARE BROWNS - LARGE**

30cm x 30cm C1015

PRODUCT CODE	TLSM-15-1015
Sheet Size (mm)	300 x 300
No. of Sheets per sq.m	11.1
No. of Sheets Per Box	11
Weight per Sheet (g)	1427g
Price per sheet	£23.00

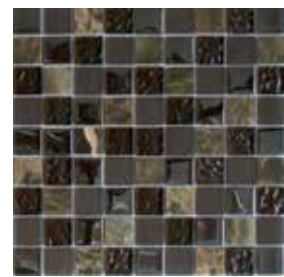
**ROUND - BLUE**

31.5cm x 29.4cm D1005

PRODUCT CODE	TLSM-20-1005
Sheet Size (mm)	315 x 294
No. of Sheets per sq.m	10.8
No. of Sheets Per Box	23
Weight per Sheet (g)	1000g
Price per sheet	£14.50

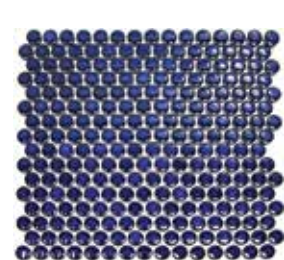
**PEBBLE - NATURAL MIXED**

30.5cm x 30.5cm E1005

PRODUCT CODE	TLSM-25-1005
Sheet Size (mm)	305 x 305
No. of Sheets per sq.m	10.75
No. of Sheets Per Box	11
Weight per Sheet (g)	2250g
Price per sheet	£14.50



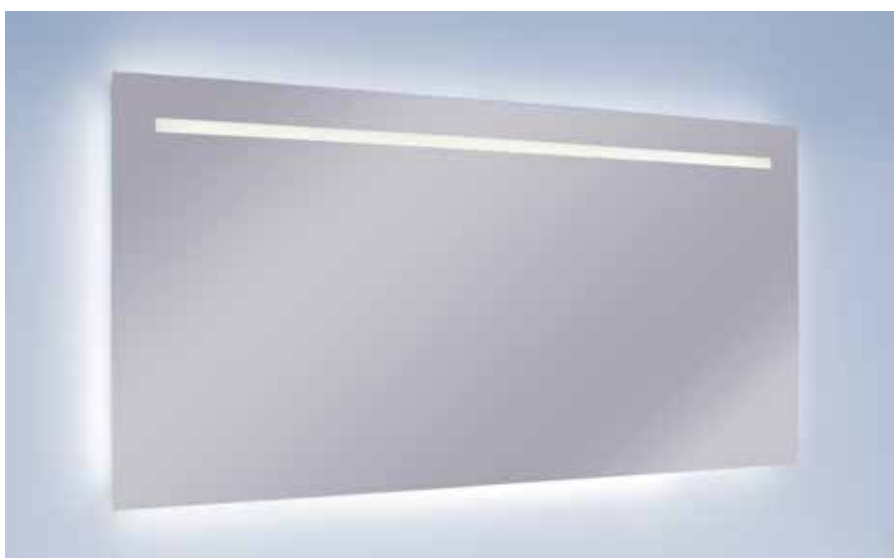

Mirrors & Cabinets



Mirrors

Finish your bathroom design in style with our sophisticated and practical LED mirrors. Stylish and functional, there is a mirror to suit all basin types and sizes.

PURE MIRROR 40

(FNMR-04-0406)

- 5mm safety film backed mirror glass
- 220-240V input, 12V output LED lamp
- IP44 rated
- IR Sensor Switch
- Demister
- 600(h) x 400(w) x 43(d) mm

£199.00



PURE MIRROR 50

(FNMR-04-0506)

- 5mm safety film backed mirror glass
- 220-240V input, 12V output LED lamp
- IP44 rated
- IR Sensor Switch
- Demister
- 600(h) x 500(w) x 43(d) mm

£279.00



PURE MIRROR 60

(FNMR-04-0606)

- 5mm safety film backed mirror glass
- 220-240V input, 12V output LED lamp
- IP44 rated
- IR Sensor Switch
- Demister
- 600(h) x 600(w) x 43(d) mm

£289.00



PURE MIRROR 80

(FNMR-04-0806)

- Ambient Light around
- 6400K/4100K LED Colour Shift
- Sensor Switch
- IP44 rated
- 600(h) x 800(w) x 38(d) mm

£299.00



PURE MIRROR 120

(FNMR-04-1206)

- Ambient Light around
- 6400K/4100K LED Colour Shift
- Sensor Switch
- IP44 rated
- 600(h) x 1200(w) x 38(d) mm

£399.00



D-STYLE MIRROR 80/60

(FNMR-02-0806)

- 5mm safety film backed mirror glass
- 220-240V input, 12V output LED lamp
- IP44 rated
- IR Sensor Switch
- Demister
- 640(h) x 800(w) x 45(d) mm
- Portrait or landscape

£299.00



Surface Cabinets

Our range of surface cabinets give a perfect blend of convenient bathroom storage and stylish designer looks. They're easy to install and will complement any contemporary bathroom decor.

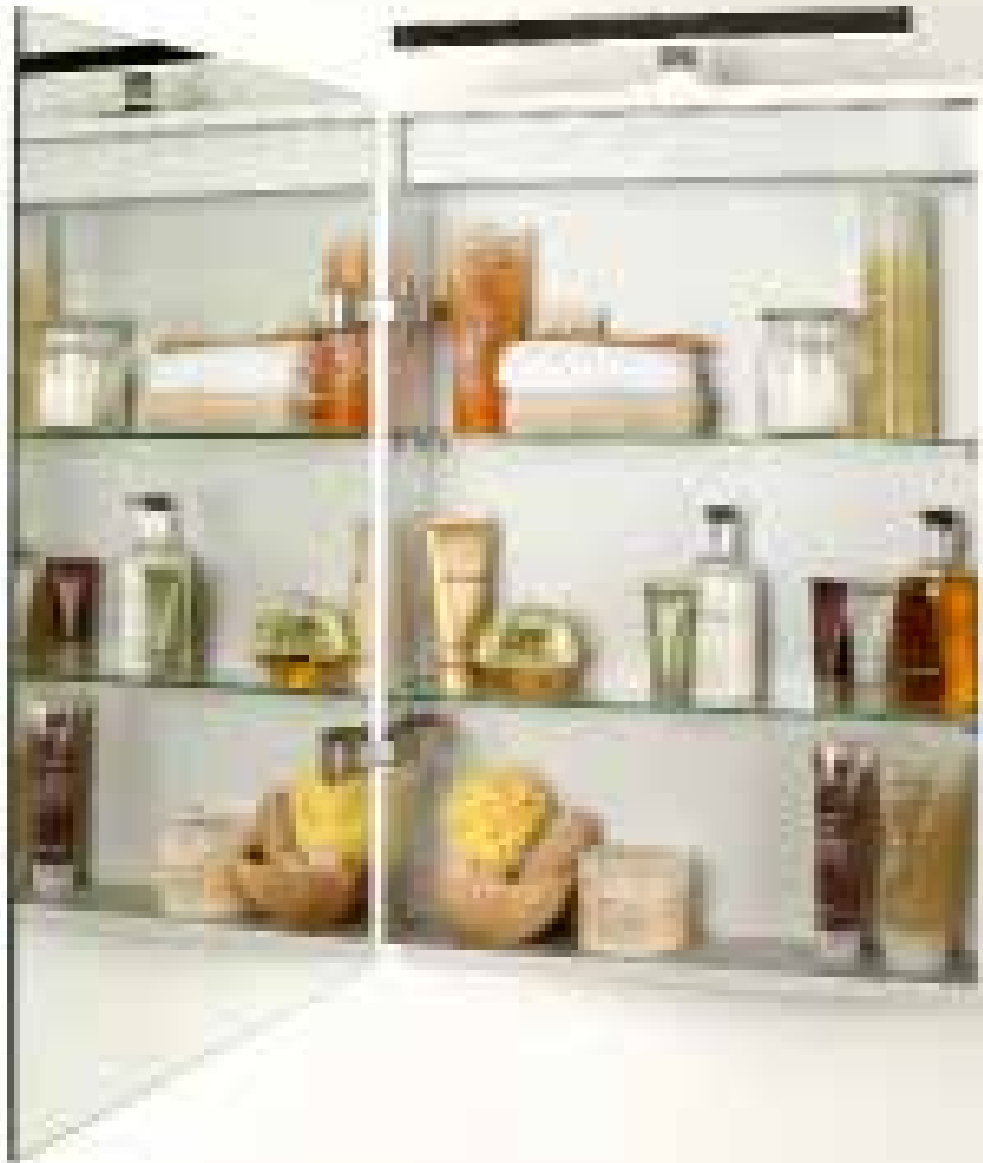

Blum hinge with soft closing



Shaver socket



Infra Red sensor switch

PURE MIRROR CABINET 50

(FNMC-01-3005)

- 220-240V input, 12V output LED lamp
- Blum hinge with soft closing
- Left hand hinge only
- Double side mirror door
- Shaver socket
- 3 adjustable glass shelves
- IR sensor switch
- 700(h) x 500(w) x 125(d) mm



Left hand hinge only

£499.00**PURE MIRROR CABINET 80**

(FNMC-02-3108)

- 220-240V input, 12V output LED lamp
- Blum hinge with soft closing
- Double side mirror door
- Shaver socket
- 3 adjustable glass shelves
- IR sensor switch
- 700(h) x 800(w) x 125(d) mm

**£599.00****PURE MIRROR CABINET 60**

(FNMC-02-3006)

- 220-240V input, 12V output LED lamp
- Double side mirror door
- Shaver socket
- Soft close hinge
- IP44 rated
- IR sensor switch
- 700(h) x 600(w) x 125(d) mm

**£549.00****D-STYLE MIRROR CABINET 50**

(FNMC-01-3105)

- 220-240V input, 12V output LED lamp
- Shaver socket
- Soft close hinge
- Left hand hinge only
- Double-sided mirror door with de-mister
- IP44 rated
- IR sensor switch
- 700(h) x 500(w) x 125(d) mm



Left hand hinge only

£499.00

Recessed Cabinets

Trio Recessed Cabinet – a classic mirrored cupboard and shelving combination designed to be installed in a pre-wall to utilise all available space in a practical yet fashionable way.



To make the installation of the recessed cabinets as simple as possible, we offer a unique range of installation frames. These frames can be installed whilst building the void wall and create a tile guide in order to achieve an exact sized opening for the cabinet. This means the installation of the cabinet can be done very easily at the final stage of the bathroom installation.

TRIO RECESSED CABINET INSTALLATION FRAME

(EPCA-05-1505)

The installation frame is not necessarily required to fit the cabinets, but it is recommended to ease installation.

- Galvanised Steel Installation Frame
- For Trio recessed cabinet
- 761(h) mm x 498(w) mm

£54.00

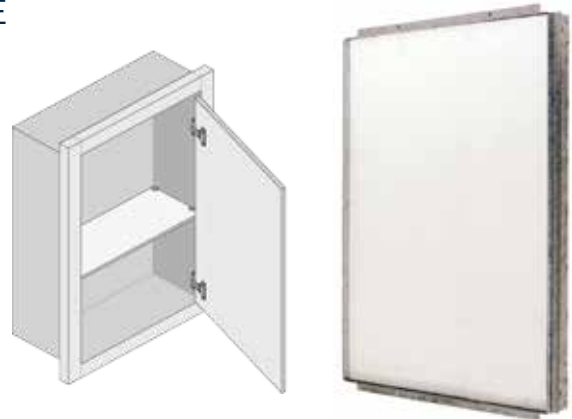

TRIO RECESSED STORAGE CABINET

- Recessed cabinet
- Pre-wall installation
- Left or right hand hinge opening
- 535(w) x 800(h) x 215(d) mm
- Optional lighting available

FROM £399.00



Shown with optional LED light

All prices inclusive of VAT





Bathroom Accessories

PURE STAINLESS STEEL TOILET ROLL HOLDER

(ACBX-20-2802)

£89.00



PURE STAINLESS STEEL ROBE HOOK

(ACBX-20-2402)

£29.00



PURE STAINLESS STEEL SOAP DISH

(ACBX-20-2202)

£79.00



PURE STAINLESS STEEL DUAL TUMBLER

(ACBX-20-3205)

£119.00



PURE STAINLESS STEEL SOAP DISPENSER

(ACBX-20-2204)

£139.00



PURE STAINLESS STEEL SINGLE TOWEL BAR

(ACBX-20-2601)

£129.00



PURE STAINLESS STEEL TRIPLE TOWEL BAR

(ACBX-20-2603)

£399.00



PURE STAINLESS STEEL SINGLE TOWEL RING

(ACBX-20-3002)

£179.00



PURE STAINLESS STEEL SHELF TOWEL BAR

(ACBX-20-0402)

£349.00



LINE SOAP DISH

(ACBX-11-2202)

£19.50



LINE WIRE SOAP DISH

(ACBX-11-2204)

£29.00



LINE SINGLE TUMBLER HOLDER & CUP

(ACBX-11-3202)

£22.50



LINE DOUBLE TUMBLER HOLDER & CUPS

(ACBX-11-3204)

£33.00



LINE TOILET ROLL HOLDER

(ACBX-11-2802)

£24.00



LINE TOILET BRUSH & HOLDER

(ACBX-11-3402)

£33.00



LINE SINGLE ROBE HOOK

(ACBX-11-2402)

£14.50



LINE TOWEL RING

(ACBX-11-3002)

£24.50



LINE TOWEL RAIL SINGLE

(ACBX-11-2602)

£39.00



LINE TOWEL RAIL DOUBLE

(ACBX-11-2604)

£49.50



HALO SOAP DISH

(ACBX-10-2202)

£19.50



HALO WIRE SOAP DISH

(ACBX-10-2204)

£29.00



HALO SOAP DISPENSER

(ACBX-10-2206)

£24.00



HALO SINGLE TUMBLER HOLDER & CUP

(ACBX-10-3202)

£22.50



HALO DOUBLE TUMBLER HOLDER & CUPS

(ACBX-10-3204)

£33.00



HALO TOILET ROLL HOLDER

(ACBX-10-2802)

£24.00



HALO TOILET BRUSH & HOLDER

(ACBX-10-3402)

£33.00

HALO DOUBLE ROBE HOOK

(ACBX-10-2402)

£14.50

HALO TOWEL RING

(ACBX-10-3002)

£24.50

HALO SINGLE TOWEL RAIL

(ACBX-10-2602)

£29.00

HALO DOUBLE TOWEL RAIL

(ACBX-10-2604)

£39.00

HALO SHELF & TOWEL RAIL

(ACBX-10-2606)

£59.00

HALO GLASS SHELF

(ACBX-10-2608)

£32.00



Partner Brands

Abacus Bathrooms are proud to partner with some of the world's finest brands to deliver the ultimate finishing touches for your bathroom.



High gloss wall panelling



Electric underfloor heating solutions

LED

Specialist bathroom lighting

R O C A T E X

High performance adhesives, grouts and silicones



Shower pumps



Assisted living components



Bathroom ventilation



High performance drainage and plumbing solutions

Lustrolite glass-effect panelling

THE AWARD WINNING LUSTROLITE PANEL BRINGS LIFE TO SHOWER WALLS AND KITCHEN SPLASHBACKS

Lustrolite® is an advanced multi-layer acrylic sheet that looks just like glass. Lustrolite applications include shower walls, bathrooms and kitchens.

Weighing less than a quarter of a traditional glass sheet, Lustrolite has 20 times the impact strength. The colour is permanently fused to the clear layer and cannot be separated by moisture. Its unique hard coated surface is highly resistant to typical shower and glass cleaners, and also offers a high scratch resistance.

EFFORTLESS TO INSTALL

Lustrolite is easy to work with and can be installed rapidly over new or existing wall finishes.

- Can be cut and drilled on site with standard wood working tools
- Typical panel install takes about a third of the time of ceramic tiles
- Joints can be sealed with neutral cure silicone or specially designed profiles

EASY TO MAINTAIN

Lustrolite is easy to clean using warm water and a soft microfibre cloth or chamois. Strong chemicals are not required.

- No grouting and less joints
- Non-stick surface will not promote mould, bacteria, soap or calcium build-up
- Highly resistant to typical shower and glass cleaners

LUXURIOUS AND ELEGANT FINISH

Each Lustrolite polymer panel is meticulously finished, perfectly smooth, and looks just like glass.

- High gloss lustrous surface
- Glass like depth of colour
- Will transform and add colour to any bathroom or kitchen





Lustrolite

THE FULLY WORKABLE ACRYLIC
ALTERNATIVE TO GLASS

Colour range

Lustrolite is available in both kitchen and bathroom specific sizes in all 9 high gloss colours

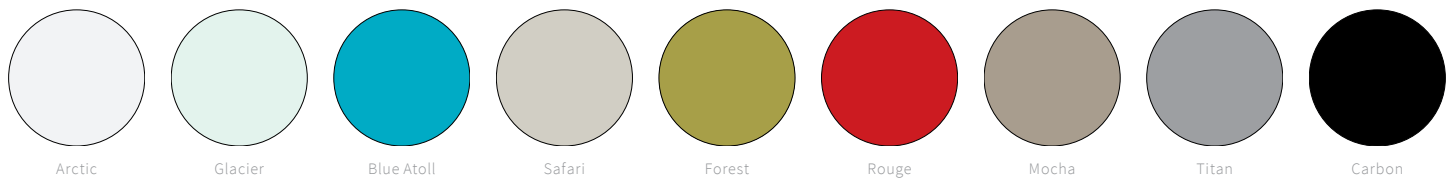

Sheet sizes

BATHROOM
PANELS



2440 x 1220mm

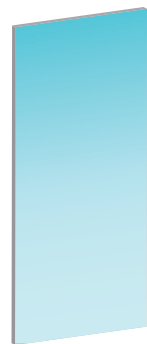

2440 x 1000mm



2070 x 1000mm

KITCHEN
PANELS



2440 x 605mm



2070 x 500mm



1220 x 1000mm



760 x 700mm

Accessories

Edge profiles - matt aluminium or colour matched



The four profiles (from left): Internal Corner, Straight Joint, External Corner, Edge Cap



Brushed Aluminium (left) and Colour Matched PVC (right) Edge Profiles

Bathroom panels

LUSTROLITE PANEL
2070 x 1000 x 4mm
£283.20

COLOUR	PRODUCT CODE
	ARCTIC LUAP-40-0005
	GLACIER LUAP-40-0010
	BLUE ATOLL LUAP-40-0015
	ROUGE LUAP-40-0020
	MOCHA LUAP-40-0025
	TITAN LUAP-40-0030
	CARBON LUAP-40-0035
	SAFARI LUAP-40-0045
	FOREST LUAP-40-0050

LUSTROLITE PANEL
2440 x 1000 x 4mm
£299.88

COLOUR	PRODUCT CODE
	ARCTIC LUAP-05-0005
	GLACIER LUAP-05-0010
	BLUE ATOLL LUAP-05-0015
	ROUGE LUAP-05-0020
	MOCHA LUAP-05-0025
	TITAN LUAP-05-0030
	CARBON LUAP-05-0035
	SAFARI LUAP-05-0045
	FOREST LUAP-05-0050

LUSTROLITE PANEL
2440 x 1220 x 4mm
£382.80

COLOUR	PRODUCT CODE
	ARCTIC LUAP-35-0005
	GLACIER LUAP-35-0010
	BLUE ATOLL LUAP-35-0015
	ROUGE LUAP-35-0020
	MOCHA LUAP-35-0025
	TITAN LUAP-35-0030
	CARBON LUAP-35-0035
	SAFARI LUAP-35-0045
	FOREST LUAP-35-0050



Note: Lustrolite is 5.5mm thick when installed using the 1.5mm thick self adhesive tape in the installation pack.

BATHROOM INSTALLATION KIT
(FOR UP TO 2 PANELS)
£28.20
(LUAP-10-0005)



LUSTROLITE MICROFIBRE CLEANING CLOTH 400 x 400mm
£1.98
(MMPG-57-0010)





Kitchen panels*

*suitable for ceramic, electric or induction hobs. Panels are not to be used directly behind or adjacent to a heat source above a continuous service temperature of 77°C. When used behind electric, ceramic or induction hobs a clearance of at least 50mm is essential between the edge of the hob and the panel. Lustrolite is NOT TO BE USED behind a gas hob (naked flame). Please see page 346 for the gas hob installation options.

LUSTROLITE PANEL
760 x 700 x 4mm
£127.20

COLOUR	PRODUCT CODE
 ARCTIC	LUAP-30-0005
 GLACIER	LUAP-30-0010
 BLUE ATOLL	LUAP-30-0015
 ROUGE	LUAP-30-0020
 MOCHA	LUAP-30-0025
 TITAN	LUAP-30-0030
 CARBON	LUAP-30-0035
 SAFARI	LUAP-30-0045
 FOREST	LUAP-30-0050

LUSTROLITE PANEL
1220 x 1000 x 4mm
£196.80

COLOUR	PRODUCT CODE
 ARCTIC	LUAP-25-0005
 GLACIER	LUAP-25-0010
 BLUE ATOLL	LUAP-25-0015
 ROUGE	LUAP-25-0020
 MOCHA	LUAP-25-0025
 TITAN	LUAP-25-0030
 CARBON	LUAP-25-0035
 SAFARI	LUAP-25-0045
 FOREST	LUAP-25-0050

LUSTROLITE PANEL
2070 x 500 x 4mm
£159.60

COLOUR	PRODUCT CODE
 ARCTIC	LUAP-20-0005
 GLACIER	LUAP-20-0010
 BLUE ATOLL	LUAP-20-0015
 ROUGE	LUAP-20-0020
 MOCHA	LUAP-20-0025
 TITAN	LUAP-20-0030
 CARBON	LUAP-20-0035
 SAFARI	LUAP-20-0045
 FOREST	LUAP-20-0050

LUSTROLITE PANEL
2440 x 605 x 4mm
£208.80

COLOUR	PRODUCT CODE
 ARCTIC	LUAP-45-0005
 GLACIER	LUAP-45-0010
 BLUE ATOLL	LUAP-45-0015
 ROUGE	LUAP-45-0020
 MOCHA	LUAP-45-0025
 TITAN	LUAP-45-0030
 CARBON	LUAP-45-0035
 SAFARI	LUAP-45-0045
 FOREST	LUAP-45-0050

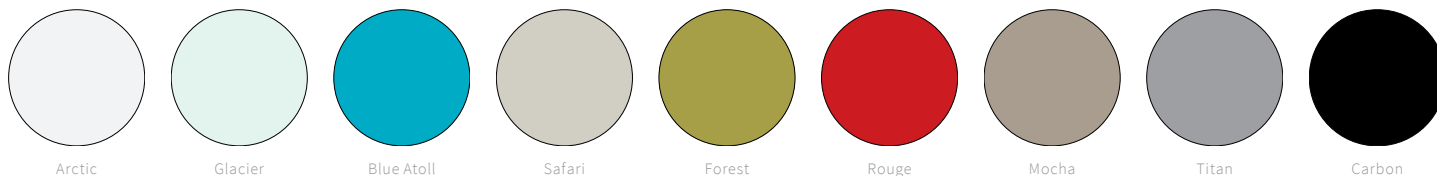





















Bathroom and kitchen profiles









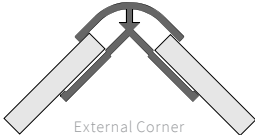

High Gloss Colour Matched or Matt Aluminium









BATHROOM 2.5m

KITCHEN 1.25m

DESCRIPTION	FINISH	BATHROOM PROFILE 2500mm PRODUCT CODE	PRICE	KITCHEN PROFILE 1250mm PRODUCT CODE	PRICE
 <p>Edge Profile</p>	 ARCTIC	LUAP-17-0505	£17.40	LUAP-17-0535	£13.08
	 GLACIER	LUAP-17-1005	£17.40	LUAP-17-1035	£13.08
	 BLUE ATOLL	LUAP-17-1505	£17.40	LUAP-17-1535	£13.08
	 ROUGE	LUAP-17-2005	£17.40	LUAP-17-2035	£13.08
	 MOCHA	LUAP-17-2505	£17.40	LUAP-17-2535	£13.08
	 TITAN	LUAP-17-3005	£17.40	LUAP-17-3035	£13.08
	 CARBON	LUAP-17-3505	£17.40	LUAP-17-3535	£13.08
	 SAFARI	LUAP-17-4505	£17.40	LUAP-17-4535	£13.08
	 FOREST	LUAP-17-5005	£17.40	LUAP-17-5035	£13.08
	 MATT ALUMINIUM	LUAP-15-0050	£19.80	LUAP-15-1005	£15.00

 <p>Straight Joint</p>	 ARCTIC	LUAP-17-0510	£22.80	LUAP-17-0540	£17.10
	 GLACIER	LUAP-17-1010	£22.80	LUAP-17-1040	£17.10
	 BLUE ATOLL	LUAP-17-1510	£22.80	LUAP-17-1540	£17.10
	 ROUGE	LUAP-17-2010	£22.80	LUAP-17-2040	£17.10
	 MOCHA	LUAP-17-2510	£22.80	LUAP-17-2540	£17.10
	 TITAN	LUAP-17-3010	£22.80	LUAP-17-3040	£17.10
	 CARBON	LUAP-17-3510	£22.80	LUAP-17-3540	£17.10
	 SAFARI	LUAP-17-4510	£22.80	LUAP-17-4540	£17.10
	 FOREST	LUAP-17-5010	£22.80	LUAP-17-5040	£17.10
	 MATT ALUMINIUM	LUAP-15-0010	£25.20	LUAP-15-1010	£18.90

 <p>External Corner</p>	 ARCTIC	LUAP-17-0515	£27.00	LUAP-17-0545	£20.28
	 GLACIER	LUAP-17-1015	£27.00	LUAP-17-1045	£20.28
	 BLUE ATOLL	LUAP-17-1515	£27.00	LUAP-17-1545	£20.28
	 ROUGE	LUAP-17-2015	£27.00	LUAP-17-2045	£20.28
	 MOCHA	LUAP-17-2515	£27.00	LUAP-17-2545	£20.28
	 TITAN	LUAP-17-3015	£27.00	LUAP-17-3045	£20.28
	 CARBON	LUAP-17-3515	£27.00	LUAP-17-3545	£20.28
	 SAFARI	LUAP-17-4515	£27.00	LUAP-17-4545	£20.28
	 FOREST	LUAP-17-5015	£27.00	LUAP-17-5045	£20.28
	 MATT ALUMINIUM	LUAP-15-0015	£29.88	LUAP-15-1015	£22.44

 <p>Internal Corner</p>	 ARCTIC	LUAP-17-0520	£27.00	LUAP-17-0550	£20.28
	 GLACIER	LUAP-17-1020	£27.00	LUAP-17-1050	£20.28
	 BLUE ATOLL	LUAP-17-1520	£27.00	LUAP-17-1550	£20.28
	 ROUGE	LUAP-17-2020	£27.00	LUAP-17-2050	£20.28
	 MOCHA	LUAP-17-2520	£27.00	LUAP-17-2550	£20.28
	 TITAN	LUAP-17-3020	£27.00	LUAP-17-3050	£20.28
	 CARBON	LUAP-17-3520	£27.00	LUAP-17-3550	£20.28
	 SAFARI	LUAP-17-4520	£27.00	LUAP-17-4550	£20.28
	 FOREST	LUAP-17-5020	£27.00	LUAP-17-5050	£20.28
	 MATT ALUMINIUM	LUAP-15-0020	£29.88	LUAP-15-1020	£22.44

Note: Lustrolite is 5.5mm thick when installed using the 1.5mm thick self adhesive tape in the installation pack.

KITCHEN INSTALLATION KIT (FOR UP TO 2 PANELS)

£23.88

(LUAP-10-0010)



LUSTROLITE MICROFIBRE CLEANING CLOTH 400 x 400mm

£1.98

(MMPG-57-0010)



Kitchen accessories

Aluminium Pan Protectors – Brushed Aluminium

DESCRIPTION	FINISH	PRODUCT CODE	PRICE
ALUMINIUM PAN SPLASH BACK 700 x 200 x 4mm	Matt Aluminium	LUAP-15-9005	£58.80
ALUMINIUM PAN SPLASH BACK 1000 x 200 x 4mm	Matt Aluminium	LUAP-15-9010	£82.80



Gas hob splashbacks

Aluminium Hob Protectors – Brushed Aluminium

DESCRIPTION	FINISH	PRODUCT CODE	PRICE
ALUMINIUM HOB PROTECTORS 760 x 700 x 4mm	Matt Aluminium	LUAP-15-9015	£168.00
ALUMINIUM HOB PROTECTORS 1000 x 760 x 4mm	Matt Aluminium	LUAP-15-9020	£198.00



Toughened Glass for use behind Gas Hobs

The glass is the same thickness as the Lustrolite panel (4mm) and colour matched to ensure a seamless look. Toughened glass cannot be cut or shaped

DESCRIPTION		FINISH	PRODUCT CODE	PRICE
TOUGHENED GLASS UPSTAND 760 x 700 x 4mm		ARCTIC	LUAP-31-0005	£139.20
TOUGHENED GLASS UPSTAND 760 x 700 x 4mm		GLACIER	LUAP-31-0010	£139.20
TOUGHENED GLASS UPSTAND 760 x 700 x 4mm		BLUE ATOLL	LUAP-31-0015	£139.20
TOUGHENED GLASS UPSTAND 760 x 700 x 4mm		ROUGE	LUAP-31-0020	£139.20
TOUGHENED GLASS UPSTAND 760 x 700 x 4mm		MOCHA	LUAP-31-0025	£139.20
TOUGHENED GLASS UPSTAND 760 x 700 x 4mm		TITAN	LUAP-31-0030	£139.20
TOUGHENED GLASS UPSTAND 760 x 700 x 4mm		CARBON	LUAP-31-0035	£139.20
TOUGHENED GLASS UPSTAND 760 x 700 x 4mm		SAFARI	LUAP-31-0045	£139.20
TOUGHENED GLASS UPSTAND 760 x 700 x 4mm		FOREST	LUAP-31-0050	£139.20

Bespoke Panel Service

Lustrolite panels can be cut to any specific size or shape with any valve or socket cut outs required. We will require signed off drawings before we cut or shape any panel and please note all bespoke items are non-returnable and non-refundable. Please contact our sales office on 0333 323 5161 or email info@lustrolite.co.uk for further information and cost.

www.lustrolite.co.uk

Due to our commitment to continuous product development we reserve the right to alter specifications without notice. Guarantee: Lustrolite products are guaranteed against manufacturing defects for 10 years for the first purchaser. The product will be replaced or refunded at the manufacturer's discretion. No other loss is guaranteed. The guarantee is non-transferable. Proof of purchase will be required. Note: All prices are subject to change, product availability and supplied in accordance with our terms and conditions. For a copy of our full terms and conditions, please contact our sales office on 0333 323 5161



Devi

UNDERFLOOR HEATING SOLUTIONS





DEVireg™ Smart

YOUR SMARTPHONE.
PERFECT TEMPERATURE.
SMART.



find out more at www.devismart.com



Enjoy superior comfort and control of electric floor heating with the new DEVireg™ Smart and DEVismart™ App.



Intuitive app control



Reduce energy costs



Safe and private cloud connection



Adjust your floor heating from your smartphone



Schedule your home heating and save energy



Control all your thermostats in multiple locations

- Simple and intuitive touchscreen operation
- Sleek, stylish design that fits all frames with 55 x 55mm hole
- The smartest, coolest-looking controller on the market



DEVIREG™ SMART POLAR WHITE

(DE140F1140)

£199.00



DEVIREG™ SMART BLACK

(DE140F1143)

£199.00



DEVIREG™ Touch

CONVENIENT. EASY. RELIABLE.

5 YEAR
WARRANTY



Touchdown! - Installation and programming simplicity with the Devi Touch controller.

With its back-lit, 2" touch screen, the DEVIREG™ Touch controller brings the very latest in convenience to every home. As intuitive and easy to use as the latest smartphones, it provides a simple touch screen that you will love using.

- Complements even the most chic designer interiors
- Ensures perfect comfort, exactly when it's needed
- Saves energy and reduces heating costs
- Unique 5 year warranty
- ... and all controlled from a simple touch screen!



DEVIREG™ TOUCH POLAR WHITE

(DE140F1064)

£129.00



DEVIREG™ TOUCH BLACK

(DE140F1069)

£129.00

DEVI mat

FOR AN EVEN, LUXURIOUS
WARM FLOOR.



DEVI mat is ultra-thin, easy to install within the tile adhesive, adding no extra height to the bathroom floor.

Selecting your Devimat system is as easy as 1, 2, 3

1. Select the Devimat type

For timber floors use Devimat 100
For concrete and Abacus
Elements floors use Devimat 150

2. Select the Devimat size

Match the free floor area of the room to the nearest Devimat size, always rounding down the requirement.
i.e. If your floor area measures at 4.3m² then select 4m² Devimat

3. Select the controller

Generally only one controller will be required, but for larger areas the following applies:

- For timber floors use one controller per 35m²
- For concrete floors use one controller per 23m²

DEVI mat

FOR AN EVEN, LUXURIOUS
WARM FLOOR.



Devimat - mats. 100W/m ² for timber construction floors (mats are 500mm wide)			
DE83030500	DEVImat DTIR-100 50w	0.5 m ²	£75.00
DE83030502	DEVImat DTIR-100 100w	1.0 m ²	£84.00
DE83030504	DEVImat DTIR-100 150w	1.5 m ²	£105.00
DE83030506	DEVImat DTIR-100 200w	2.0 m ²	£120.00
DE83030508	DEVImat DTIR-100 250w	2.5 m ²	£135.00
DE83030510	DEVImat DTIR-100 300w	3.0 m ²	£156.00
DE83030512	DEVImat DTIR-100 350w	3.5 m ²	£174.00
DE83030514	DEVImat DTIR-100 400w	4.0 m ²	£189.00
DE83030516	DEVImat DTIR-100 500w	5.0 m ²	£225.00
DE83030518	DEVImat DTIR-100 600w	6.0 m ²	£249.00
DE83030520	DEVImat DTIR-100 700w	7.0 m ²	£279.00
DE83030522	DEVImat DTIR-100 800w	8.0 m ²	£300.00
DE83030524	DEVImat DTIR-100 900w	9.0 m ²	£327.00
DE83030526	DEVImat DTIR-100 1000w	10.0 m ²	£354.00
DE83030528	DEVImat DTIR-100 1200w	12.0 m ²	£399.00



Devimat - mats. 150W/m ² for concrete construction floors (mats are 500mm wide)			
DE83030560	DEVImat DTIR-150 75w	0.5 m ²	£75.00
DE83030562	DEVImat DTIR-150 150w	1.0 m ²	£84.00
DE83030564	DEVImat DTIR-150 225w	1.5 m ²	£105.00
DE83030566	DEVImat DTIR-150 300w	2.0 m ²	£129.00
DE83030568	DEVImat DTIR-150 375w	2.5 m ²	£150.00
DE83030570	DEVImat DTIR-150 450w	3.0 m ²	£165.00
DE83030572	DEVImat DTIR-150 525w	3.5 m ²	£186.00
DE83030574	DEVImat DTIR-150 600w	4.0 m ²	£210.00
DE83030576	DEVImat DTIR-150 750w	5.0 m ²	£255.00
DE83030578	DEVImat DTIR-150 900w	6.0 m ²	£285.00
DE83030580	DEVImat DTIR-150 1050w	7.0 m ²	£318.00
DE83030582	DEVImat DTIR-150 1200w	8.0 m ²	£345.00
DE83030584	DEVImat DTIR-150 1350w	9.0 m ²	£369.00
DE83030586	DEVImat DTIR-150 1500w	10.0 m ²	£426.00
DE83030588	DEVImat DTIR-150 1800w	12.0 m ²	£480.00

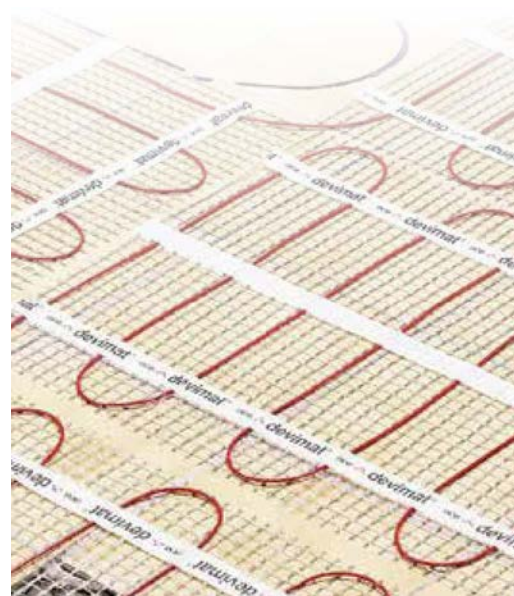

find out more at www.devi.co.uk





Lighting &
Electrical

LED Kits

LED LIGHTING TAPE KIT

- Width 8mm x depth 4mm
- Cuttable every 50mm
- IP65 Rated
- Voltage: 12v
- Kits are supplied with a non-dimming driver
- 120° beam angle
- LED tape 9.6W per metre daylight amp including driver



DESCRIPTION	PRODUCT CODE	LENGTH	PRICE
LED LIGHTING TAPE KIT	MSLD-30-1105	500mm	£42.90
LED LIGHTING TAPE KIT	MSLD-30-1110	1000mm	£43.90
LED LIGHTING TAPE KIT	MSLD-30-1120	2000mm	£82.50
LED LIGHTING TAPE KIT	MSLD-30-1130	3000mm	£109.50



RECESSED LED PLASTIC 2m PROFILE

- Can be cut to any length up to 2 metres
- Can be butt jointed for longer lengths
- Internal dimensions: H: 8mm, W: 12mm
- Tape shown in image not included

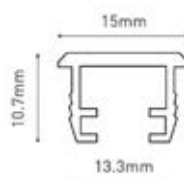
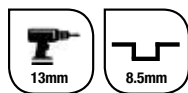

DESCRIPTION	PRODUCT CODE	WIDTH	PRICE
RECESSED LED PLASTIC PROFILE	MSLD-35-0020	8.5mm	£33.95

SMART SURFACE ALUMINIUM 2m PROFILE DIFFUSER & END CAPS

- Complete with end caps & surface mounted fixings
- Can be cut to any length up to 2 metres
- Can be butt jointed for longer lengths
- External dimensions: W: 12mm D: 12mm

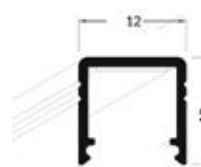

DESCRIPTION	PRODUCT CODE	WIDTH	PRICE
SMART SURFACE ALUMINIUM PROFILE	MSLD-35-0021	12mm	£39.00

SMART RECESSED ALUMINIUM 2m PROFILE DIFFUSER & END CAPS

- Can be cut to any length up to 2m
- Lengths can be butt jointed for longer runs
- Can be supplied with any LED tape
- Complete with end caps

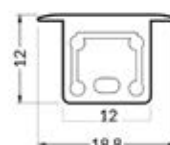

DESCRIPTION	PRODUCT CODE	WIDTH	PRICE
SMART RECESSED ALUMINIUM PROFILE	MSLD-35-0022	18.8mm	£27.90

LED Kits

10-LED POLISHED STAINLESS STEEL WALKOVER KIT

- 1.5 meters of cable per light
- IP44 driver
- 80mm recess
- 20mm cut out
- Non replaceable Daylight LED



DESCRIPTION	PRODUCT CODE	DIAMETER	PRICE
10 LIGHT LED ROUND WALKOVER KIT	MSLD-05-2012	25mm	£85.50

ROUND PRESENCE DETECTOR

- Works in conjunction with MSLD-05-2012 (discard 1 of 10 lights)
- Activates on movement
- Complete with built in Photocell & PIR
- Cut out 32mm overall 45mm diameter



DESCRIPTION	PRODUCT CODE	DIAMETER	PRICE
ROUND PRESENCE DETECTOR IP67	MSLD-50-0005	45mm	£28.50

0.4W MINI COOL WHITE LED SPOTLIGHT KIT

- Finish: Polished Chrome
- Plug and Play driver included
- IP65 Rated
- Cut Out: 23mm
- Recess Depth: 13mm
- Zone 1
- Add up to a further 5 of MSLD-05-3106 spotlights using the supplied plug & play driver



DESCRIPTION	PRODUCT CODE	DIAMETER	PRICE
0.4W MINI COOL WHITE LED SPOTLIGHT KIT	MSLD-05-3002	23mm	£52.42

0.4W MINI COOL WHITE LED SPOTLIGHT

- For use with Mini Day Light LED Spotlight Kit
- Add up to a further 5
- Finish: Polished Chrome
- 110 degree beam angle
- Cut Out: 23mm
- Recess Depth: 13mm



DESCRIPTION	PRODUCT CODE	DIAMETER	PRICE
0.4W MINI COOL WHITE LED SPOTLIGHT	MSLD-05-3106	23mm	£10.66

Under Cabinet Recessed Downlights

UNDER CABINET RECESSED KIT - COOL WHITE

- COB LED technology allows a wider beam angle
- Split connector cable for ease of installation or replacement
- Cut out 53mm
- Recess depth - 10.5mm
- Overall diameter - 65mm
- Wattage - 2.6W
- (D) - 187lm
- (D) 6500K
- Driver included (can run up to 5 lights) - 15watt



DESCRIPTION	PRODUCT CODE	PRICE
LED RECESSED UNDER CABINET LIGHT KIT WITH DRIVER	MSLD-01-0102	£84.10



LED RECESSED UNDER CABINET LIGHT - COOL WHITE

DESCRIPTION	PRODUCT CODE	PRICE
LED RECESSED UNDER CABINET LIGHT	MSLD-01-0100	£31.54



SURFACE MOUNT SPACER

DESCRIPTION	PRODUCT CODE	PRICE
SURFACE MOUNT SPACER	MSLD-01-0101	£2.81

- Designed for the LED recessed under cabinet light MSLD-01-0100
- Available in polished chrome or stainless steel



Ceiling Recessed Downlights

AURORA ENLITE

- EnFiniti™ edge-to-edge multifaceted polycarbonate lens for low glare and halogen like appearance
- Wide 60° beam angle delivers increased light distribution
- Fibre based insulation coverable - up to 250mm
- Integrated driver with push fit loop in/out terminals suitable for use with solid or stranded cable for easy installation
- Super slim interchangeable bezels for fixed version provide a high end sleek finish. Bezel included with adjustable version.
- Community Design Registrations for E5™ and E8™
- BS EN 1365-2: 2014 (Fire resistance)
- BS EN ISO 10140-2: 2010 & BS EN ISO 10140-3: 2010 + A1: 2015 (Acoustics)
- BS EN 13141-1:2004 (Air leakage) - excluding adjustable version
- 3 year warranty



DESCRIPTION	PRODUCT CODE	PRICE
LED FIRE RATED DOWNLIGHT - WARM WHITE	MSLD-35-0005	£25.50
LED FIRE RATED DOWNLIGHT - COOL WHITE	MSLD-35-0010	£25.50

AURORA ENLITE BEZEL

- Designed to suit LED Fire Rated Downlight MSLD-35-0005 and MSLD-35-0010

DESCRIPTION	PRODUCT CODE	PRICE
ENLITE BEZEL - WHITE	MSLD-35-1005	£4.65
ENLITE BEZEL - SATIN NICKEL	MSLD-35-1010	£6.75
ENLITE BEZEL - POLISHED CHROME	MSLD-35-1015	£6.75



CHROME DUAL VOLTAGE SHAVER SOCKET

- Polished chrome
- Requires 47mm back box

DESCRIPTION	PRODUCT CODE	PRICE
SHAVER SOCKET	MSLD-45-0005	£49.50



Rocatex

HIGH PERFORMANCE ADHESIVES,
GROUTS & SILICONES



ROCATEX

The industry's leading range of professional tiling products is designed to complement the preparation, fixing and maintenance of natural stone, porcelain and ceramic tiles.

find out more at www.rocatex.com



ROCATEX C2FT S2 RAPID FLEX WHITE ADHESIVE

(TLTA-05-2020) 20kg

White rapid set highly flexible adhesive for natural stone and tiles.

- Ceramic/Porcelain/Mosaics
- Natural Stone/Flagstones
- Screeds/Timber/Chipboard
- Underfloor Heating
- Swimming Pools/Wet Areas
- Ultimate Grab
- Non-Slip
- Interior/Exterior

£32.50



Average Coverage 6.0sq.m at 3mm thickness For 20kg Bag



ROCATEX C2FT S1 RAPID FLEX WHITE ADHESIVE

(TLTA-05-2016) 20kg

White rapid set highly flexible adhesive for natural stone and tiles.

- Ceramic/Porcelain/Mosaics
- Natural Stone/Flagstones
- Screeds/Concrete/Timber
- Underfloor Heating
- Swimming Pools/Wet Areas
- Ultimate Grab
- Non-Slip
- Interior/Exterior

£24.50



Average Coverage 6.0sq.m at 3mm thickness For 20kg Bag



ROCATEX C2FT S1 RAPID FLEX GREY ADHESIVE

(TLTA-05-2012) 20kg

Grey rapid set highly flexible adhesive for natural stone and tiles.

- Ceramic/Porcelain/Mosaics
- Natural Stone/Flagstones
- Screeds/Concrete/Timber
- Underfloor Heating
- Swimming Pools/Wet Areas
- Ultimate Grab
- Non-Slip
- Interior/Exterior

£22.00



Average Coverage 6.0sq.m at 3mm thickness For 20kg Bag



ROCATEX C2TE S1 SEMI-RAPID FLEX WHITE ADHESIVE

(TLTA-05-2018) 20kg

White semi-rapid set flexible adhesive for natural stone and tiles.

- Ceramic/Porcelain/Mosaics
- Natural Stone/Flagstones
- Screeds/Concrete/Timber
- Underfloor Heating
- Swimming Pools/Wet Areas
- Ultimate Grab
- Non-Slip
- Interior/Exterior

£24.50



Average Coverage 6.0sq.m at 3mm thickness For 20kg Bag



ROCATEX C2TE S1 SEMI-RAPID FLEX GREY ADHESIVE

(TLTA-05-2014) 20kg

Grey semi-rapid set flexible adhesive for natural stone and tiles.

- Ceramic/Porcelain/Mosaics
- Natural Stone/Flagstones
- Screeds/Concrete/Timber
- Underfloor Heating
- Swimming Pools/Wet Areas
- Ultimate Grab
- Non-Slip
- Interior/Exterior

£22.00



Average Coverage 6.0sq.m at 3mm thickness For 20kg Bag



ROCATEX CG2 WA ULTIMATE GROUT

5kg

Fibre reinforced flexible anti-mould wall and floor grout

- Anti-Mould Technology
- Flexible/Fibre Reinforced
- Highly Water Repellent
- Advanced Colour Stability
- Easy Clean-Off Formulation
- Rapid Hardening/Excellent Durability
- Contains Over 50% Recycled Material
- Colour Matched Silicones And Expansion Joints

£14.90

PRODUCT CODE	COLOUR	PRICE PER BAG
TLTA-10-2002	WHITE	£14.90
TLTA-10-2004	JASMINE	£14.90
TLTA-10-2008	LIMESTONE	£14.90
TLTA-10-2010	BEIGE	£14.90
TLTA-10-2012	GREY BEIGE	£14.90
TLTA-10-2020	LIGHT GREY	£14.90
TLTA-10-2022	DARK GREY	£14.90
TLTA-10-2024	ANTHRACITE	£14.90

1-20mm JOINT WIDTH **45 mins OPEN TIME** **90 mins SET TIME**



ROCATEX FGS ULTIMATE SILICONE

310ml

- 100% Pure silicone with a high quality matt finish
- Colour matched to Rocatex grouts
- Anti-fungal - protects against mould, mildew and bacteria
- Non-staining formula - suitable for natural stone and marble
- Easy to tool and highly flexible - movement capability up to 50%
- Excellent adhesion to most surfaces (plastics, tiles, paint, glass, metals etc.)
- Outstanding UV resistance - anti-aging and weather resistant
- Advanced low odour formulation

£9.95

PRODUCT CODE	COLOUR	PRICE PER BAG
TLTA-35-2001	TRANSLUCENT	£9.95
TLTA-35-2002	WHITE	£9.95
TLTA-35-2004	JASMINE	£9.95
TLTA-35-2008	LIMESTONE	£9.95
TLTA-35-2010	BEIGE	£9.95
TLTA-35-2012	GREY BEIGE	£9.95
TLTA-35-2020	LIGHT GREY	£9.95
TLTA-35-2022	DARK GREY	£9.95
TLTA-35-2024	ANTHRACITE	£9.95



ROCATEX FIBREFLOW RAPID FLEX LEVELLER

(TLTA-15-2015) 25kg

Hi-flow smooth finish self-levelling screed

- High Flow Rate/Easily Pumped
- Wet Edge Technology/Seamless Gelling
- Rapid Drying/High Flexural Strength
- Durable Finish/Non-Shrink
- Fibre Reinforced/Protein Free
- Underfloor Heating
- Concrete/Screeds/Timber Floors
- Tiling/Vinyl/Soft Floor Coverings

£34.50

3-50mm BED THICKNESS **25-30 mins OPEN TIME** **90 mins FOOT TRAFFIC**



All prices inclusive of VAT

ROCATEX ACRYLIC PRIMER

Rocatex Acrylic Primer is a water-based polymer emulsion, designed to give maximum penetration into the substrate to enhance surface preparation for bonding when tiling or screeding.

- Concrete/Screeds
- Anhydrite/Gypsum
- Timber/Plasterboard
- Blockwork/Brickwork
- Existing Tiles/Metal
- Interior/Exterior

PRODUCT CODE	SIZE	PRICE PER BAG
TLTA-15-2050	5 LITRE	£37.50
TLTA-15-2010	1 LITRE	£12.50



ROCATEX WATERPROOF TANKING COAT

(TLTA-15-2030) 5kg

A premium grade, rapid drying, highly flexible, one part liquid rubber membrane.

- Advanced Liquid Rubber Technology
- 100% Waterproof / Highly Flexible
- Rapid Drying / Tile in Just 1 Hour
- Easy To Apply / No Priming Required
- Excellent Adhesion / Sticks All Tapes
- Interior / Exterior / Domestic / Commercial

£45.00



ROCATEX ULTIMATE GRIP PRIMER

(TLTA-15-2025) 5kg

A solvent-free, rapid drying one-coat bonding primer.

- Multi-Purpose / Easy To Use
- Ultimate Bond / Textured 'Key Coat' Finish
- Rapid Drying / One Coat Application
- Very Low Emissions / EC1 Plus (VOC)
- Non-Absorbent / Absorbent Surfaces
- Existing Tiles / Asphalt / Bitumen
- Concrete / Blockwork / Screeds / Timber
- Interior / Exterior / Domestic / Commercial

£58.00



ROCATEX C10 ULTIMATE SEALER

A high performing VOC free water-based impregnating sealer designed using the very latest technology in Fluorochemistry. This versatile and easy to apply penetrating and invisible sealer provides a durable non-film-forming, protective barrier against oil and water on porous acid sensitive surfaces including polished and unpolished natural stone, paving, concrete, render and grout. C-10 Ultimate Sealer allows the surface to breathe and provides excellent oil, grease and water repellency, stain resistance and ease of cleaning.

PRODUCT CODE	SIZE	PRICE PER BAG
TLTA-20-2006	5 LITRE	£179.00
TLTA-20-2004	1 LITRE	£34.50



ROCATEX C10 ULTIMATE SEALER SPRAY

(TLTA-20-2008) 500ml

A high performing VOC free water-based impregnating sealer designed using the very latest technology in Fluorochemistry. This versatile and easy to apply penetrating and invisible sealer provides a durable non-film-forming, protective barrier against oil and water on porous acid sensitive surfaces including polished and unpolished natural stone, paving, concrete, render and grout. C-10 Ultimate Sealer allows the surface to breathe and provides excellent oil, grease and water repellency, stain resistance and ease of cleaning.

£24.50



ROCATEX TILE & STONE CLEANER

A high quality liquid soap containing a trace of linseed oil especially formulated to clean without damaging the most delicate surfaces. Has a fresh, clean fragrance.

PRODUCT CODE	SIZE	PRICE PER BAG
TLTA-20-2036	5 LITRE	£95.00
TLTA-20-2034	1 LITRE	£19.50



ROCATEX GROUT & CEMENT REMOVER

(TLTA-20-2026) 1 litre

A rapid action cleaning agent for removing cement residues, grout stain, efflorescence and other similar deposits from glazed and unglazed ceramics, slate, quarry tiles, brick, terracotta and stone.

£19.50



ROCATEX TILE & STONE RENOVATOR

(TLTA-20-2028) 1 litre

Intensive cleaner, effective for removing oil, grease, ingrained dirt, grime and old wax layers. Ideal for intensive stone care and for renovating heavily soiled floors.

£19.50



ROCATEX MOULD REMOVER

(TLTA-20-2032) 500ml

Targets and removes mould spores, fungus, algae and moss from grout joints, tiles, silicone surfaces and other damp places. Antibacterial properties help to prevent re-growth.

£18.50





Specialist Tile Trims

FLAT EDGE TILE TRIM - 2.5m length

Flat edge metal tile trims

PRODUCT CODE	SIZE (mm)	FINISH	PRICE
TLTA-75-0505	8	BRIGHT SILVER	£20.50
TLTA-75-0510	10	BRIGHT SILVER	£21.50
TLTA-75-0515	12	BRIGHT SILVER	£24.50
TLTA-75-0520	8	MATT SILVER	£19.00
TLTA-75-0525	10	MATT SILVER	£20.00
TLTA-75-0530	12	MATT SILVER	£21.50
TLTA-75-0535	10	GRAPHITE	£35.00
TLTA-75-0540	12	GRAPHITE	£37.50

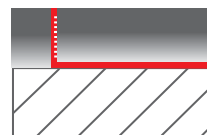

FLEXIBLE FLAT EDGE TILE TRIM - 2.5m length

Flexible Metal Tile Trim For Specialist Features

PRODUCT CODE	SIZE (mm)	FINISH	PRICE
TLTA-75-1005	8	NATURAL SILVER	£26.50
TLTA-75-1010	10	NATURAL SILVER	£27.50
TLTA-75-1015	12	NATURAL SILVER	£29.00



QUADRANT TILE TRIM - 2.5m length

Quadrant Metal Tile Trim

PRODUCT CODE	SIZE (mm)	FINISH	PRICE
TLTA-75-1505	8	BRIGHT SILVER	£24.00
TLTA-75-1510	10	BRIGHT SILVER	£25.50
TLTA-75-1515	12	BRIGHT SILVER	£29.50
TLTA-75-1520	8	MATT SILVER	£19.50
TLTA-75-1525	10	MATT SILVER	£20.50
TLTA-75-1530	12	MATT SILVER	£22.50



METALLIC BORDER TRIM - 2.5m length

Border Metallic Tile Trims

PRODUCT CODE	SIZE (mm)	FINISH	PRICE
TLTA-75-2005	12 x 6.4 (w)	BRIGHT SILVER	£29.50
TLTA-75-2010	12 x 10 (w)	BRIGHT SILVER	£32.50

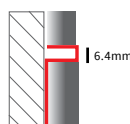
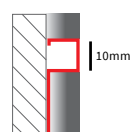

Grundfos

SHOWER PUMPS



Positive Head Pumps

STR2 - 1.5 BAR TWIN - POSITIVE HEAD

(STR2 - 1.5 C)

DESCRIPTION	PRODUCT CODE	PRICE
NIAGARA 1.5 BAR TWIN IMPELLER CENTRIFUGAL	MSGW-04-2215	£216.00

WRAS
APPROVED
PRODUCT



AMAZON 3.0 BAR SINGLE - POSITIVE HEAD

(SSP-3.0 B)

DESCRIPTION	PRODUCT CODE	PRICE
AMAZON 3.0 BAR SINGLE - POSITIVE REGENERATIVE	MSGW-02-4130	£399.00

WRAS
APPROVED
PRODUCT



AMAZON 2.0 BAR TWIN - POSITIVE HEAD

(STP-2.0 B)

DESCRIPTION	PRODUCT CODE	PRICE
AMAZON 2.0 BAR TWIN - POSITIVE REGENERATIVE	MSGW-02-4220	£567.00

WRAS
APPROVED
PRODUCT



AMAZON 3.0 BAR TWIN - POSITIVE HEAD

(STP-3.0 B)

DESCRIPTION	PRODUCT CODE	PRICE
AMAZON 3.0 BAR TWIN - POSITIVE REGENERATIVE	MSGW-02-4230	£659.00

WRAS
APPROVED
PRODUCT



Negative Head Pumps

AMAZON 3.0 BAR TWIN - NEGATIVE HEAD (STN-3.0 B)



DESCRIPTION	PRODUCT CODE	PRICE
AMAZON 3.0 BAR TWIN - NEGATIVE/UNIVERSAL	MSGW-02-5230	£873.00

SURREY / YORK FLANGES

DESCRIPTION	PRODUCT CODE	PRICE
SURREY FLANGE 15mm (1")	MSGW-02-9008	£42.75
SURREY FLANGE 22mm (1")	MSGW-02-9009	£43.50
YORK FLANGE DEFLECTOR 22mm	MSGW-02-9010	£49.50



Surrey Flange



York Flange

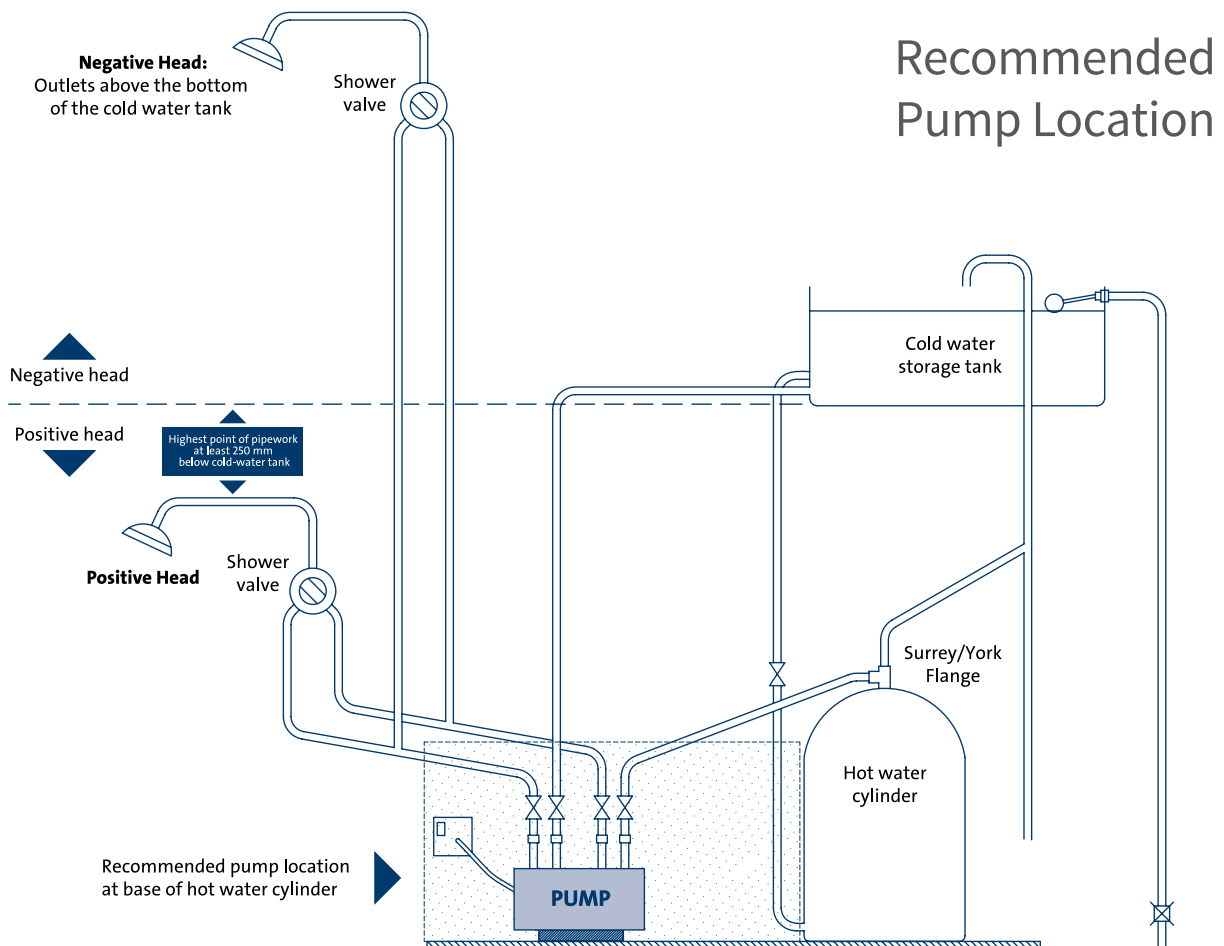

All prices inclusive of VAT

Grundfos Home Booster

BE. THINK. INNOVATE.



The Home Booster is available in two models:

Home Booster 3.0 Bar
is fitted with the CM 3-4 l

Home Booster 4.5 Bar
is fitted with the CM 3-6 l



Home Booster
180 litre Slave Unit
for additional water
capacity if required

The Home Booster is a compact, efficient and quiet solution for meeting the demands of modern pressurised domestic hot and cold water systems.

The Grundfos Home Booster is a self-contained cold water booster set, designed for domestic properties where the existing mains water supply is insufficient to meet the demand requirements of pressurised hot and cold water systems.

The Home Booster is suitable for most domestic properties with one or two standard bathrooms with standard fittings, or en-suite, and cloakroom, plus other normal household appliances.

- Integrated 200 litre storage tank (180 litres usable volume)
- Electronically on/off controlled
- Nominal performance 3.0 bar or 4.5 bar at 0.5 l/s (depending on model)
- Packaged set ready for installation
- Dry run protection
- WRAS Approved Components



find out more at www.grundfos.co.uk

Grundfos Home Booster

BE. THINK. INNOVATE.

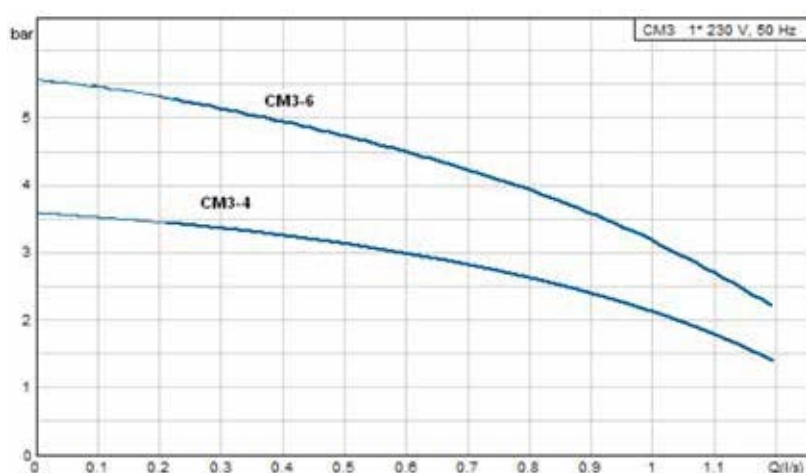

The Home Booster is controlled by the PM2 pressure manager.

The PM2 is the all-round control solution, offering adjustable pump start at 1.5 to 5 bar. This enables customisation to different types of installation and desired comfort levels. The start pressure is set inside the unit, whereas current pressure is read on the intuitive LED display on the front of the Pressure Manager.

HOME BOOSTER 3.0 BAR

(MSGW-10-0030)

£POA

HOME BOOSTER 4.5 BAR

(MSGW-10-0045)

£POA

HOME BOOSTER SLAVE UNIT

(MSGW-12-0180)

£POA

The unit features an integral 200 litre storage tank with Type AB air gap, in accordance with Water Byelaws regulations. The high quality stainless steel pump delivers high efficiency, sustained performance, long working life and quiet operation. The Grundfos PM2 controller on/off controls the pump, and also provides dry run protection should the storage tank run out of water.

The Home Booster has been developed to provide a compact and cost-effective solution. It is self-contained and its compact size makes it ideal for domestic installations where space is at a premium, and may be typically installed in a utility room or a garage.

For larger properties, the Max-E Boost should be considered, it is not recommended to install two Home Boosters operating together to achieve increased flow.

Installation is straightforward, requiring connection of mains cold water supply, discharge pipe, overflow pipe and electrical connections.

For properties with 4 to 5 occupants, or where the storage tank refills very slowly due to poor mains water pressure, an additional 180 litre water storage slave tank option is recommended to increase the storage capacity.

CONVERT THIS
DESIGNER
BATHROOM...

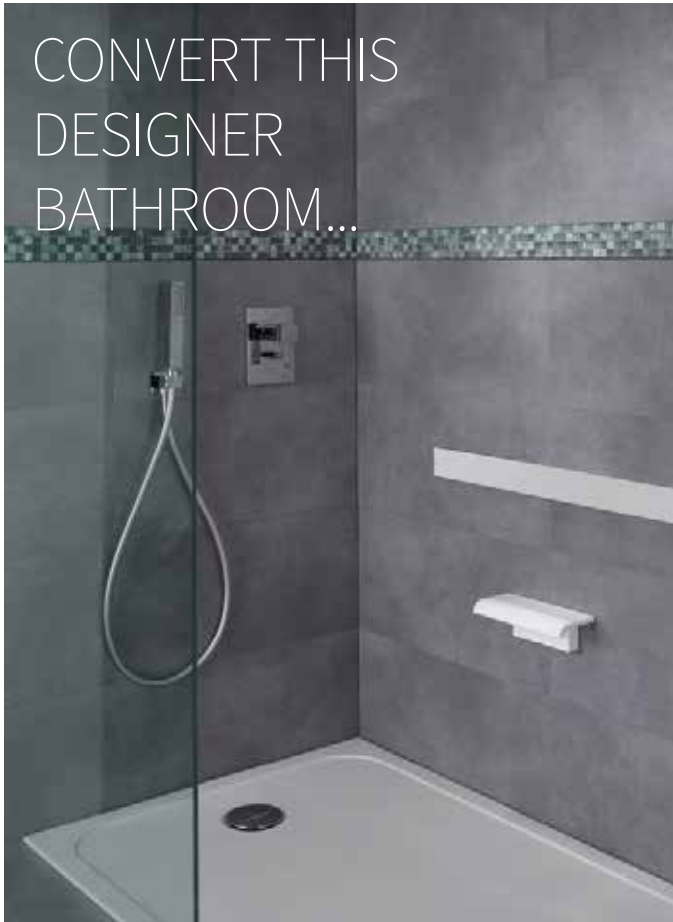

...INTO THIS
STYLISH, ASSISTED
LIVING BATHROOM

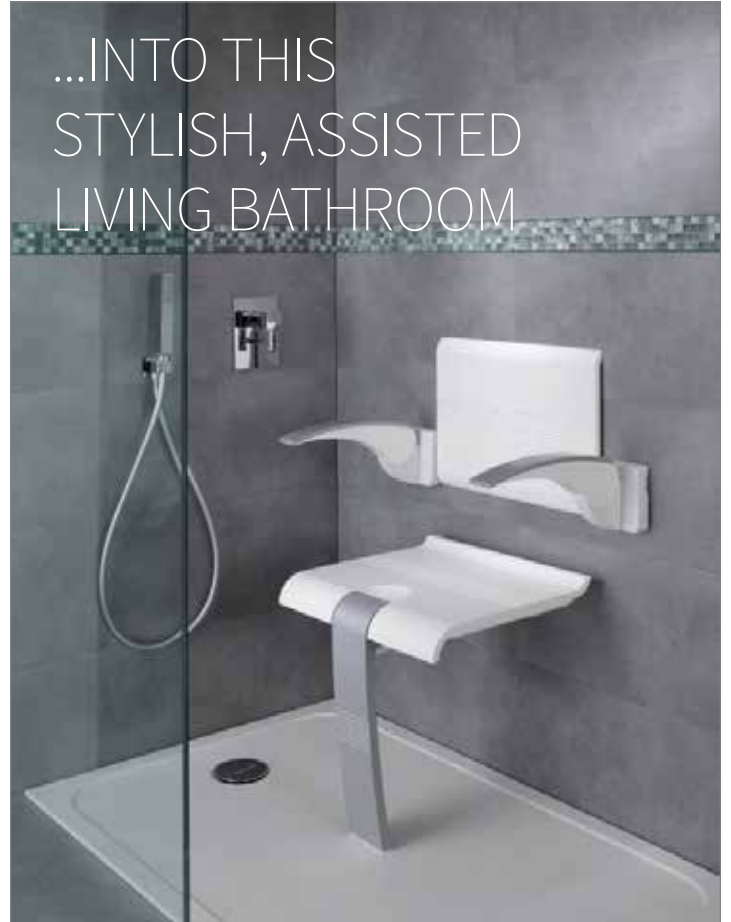

Pellet's modular concept allows for easy transformation of your bathroom with removable and interchangeable components.

find out more at www.pellet-asc.fr



The logo for Pellet, featuring a blue stylized bird-like shape above the word "PELLET" in bold, black, uppercase letters.

PELLET



Pellet
ASSISTED LIVING WITH
COMFORT AND SAFETY

Arsis Comfort & Safety

ARSIS STRAIGHT GRAB BAR 400mm, 600mm

DESCRIPTION	FINISH	PRODUCT CODE	PRICE
ARSIS STRAIGHT GRAB BAR 400mm	WHITE/CHROME	ALAC-12-2604	£66.00
ARSIS STRAIGHT GRAB BAR 600mm	WHITE/CHROME	ALAC-12-2606	£75.00
ARSIS STRAIGHT GRAB BAR 400mm	BRIGHT ANODISED	ALAC-02-2604	£96.00
ARSIS STRAIGHT GRAB BAR 600mm	BRIGHT ANODISED	ALAC-02-2606	£108.00



ARSIS ANGLED GRAB BAR 200mm

DESCRIPTION	FINISH	PRODUCT CODE	PRICE
ARSIS ANGLED GRAB BAR 200mm	WHITE	ALAC-10-0802	£66.00
ARSIS ANGLED GRAB BAR 200mm	WHITE/CHROME	ALAC-12-0802	£78.00
ARSIS ANGLED GRAB BAR 200mm	BRIGHT ANODISED	ALAC-02-0802	£120.00



ARSIS ANGLED GRAB BAR 400mm

DESCRIPTION	FINISH	PRODUCT CODE	PRICE
ARSIS ANGLED GRAB BAR 400mm	WHITE	ALAC-10-0806	£108.00
ARSIS ANGLED GRAB BAR 400mm	WHITE/CHROME	ALAC-12-0806	£120.00
ARSIS ANGLED GRAB BAR 400mm	BRIGHT ANODISED	ALAC-02-0806	£159.00



ARSIS HINGED WALL BAR 600mm

DESCRIPTION	FINISH	PRODUCT CODE	PRICE
ARSIS HINGED WALL BAR 600mm	WHITE	ALAC-10-1006	£240.00
ARSIS HINGED WALL BAR 600mm	WHITE/CHROME	ALAC-12-1006	£294.00



ARSIS HINGED WALL BAR 770mm

DESCRIPTION	FINISH	PRODUCT CODE	PRICE
ARSIS HINGED WALL BAR 770mm	WHITE	ALAC-10-1008	£258.00
ARSIS HINGED WALL BAR 770mm	WHITE/CHROME	ALAC-12-1008	£294.00



ARSIS SEAT WITH SUPPORT

DESCRIPTION	FINISH	PRODUCT CODE	PRICE
ARSIS SEAT WITH EPOXY GREY SUPPORT	WHITE	ALAC-12-0202	£339.00



ARSIS SHELF & WALL BRACKET

DESCRIPTION	FINISH	PRODUCT CODE	PRICE
ARSIS SHELF & WALL BRACKET	WHITE	ALAC-10-0404	£36.00
ARSIS SHELF (ONLY)	WHITE	ALAC-10-0402	£27.00



Arsis Accessories

ARSIS DOUBLE ROBE HOOK

DESCRIPTION	FINISH	PRODUCT CODE	PRICE
ARSIS DOUBLE ROBE HOOK	WHITE/CHROME	ALAC-12-2402	£45.00
ARSIS DOUBLE ROBE HOOK	BRIGHT ANODISED	ALAC-02-2402	£57.00



ARSIS DOUBLE TOWEL RAIL

DESCRIPTION	FINISH	PRODUCT CODE	PRICE
ARSIS DOUBLE TOWEL RAIL	WHITE/CHROME	ALAC-12-2602	£49.50
ARSIS DOUBLE TOWEL RAIL	BRIGHT ANODISED	ALAC-02-2602	£78.00



ARSIS TOILET ROLL HOLDER - SINGLE

DESCRIPTION	FINISH	PRODUCT CODE	PRICE
ARSIS TOILET ROLL HOLDER - SINGLE	WHITE	ALAC-10-2801	£37.50
ARSIS TOILET ROLL HOLDER - SINGLE	WHITE/CHROME	ALAC-12-2801	£48.00
ARSIS TOILET ROLL HOLDER - SINGLE	BRIGHT ANODISED	ALAC-02-2801	£63.00



ARSIS TOILET ROLL HOLDER - TWIN

DESCRIPTION	FINISH	PRODUCT CODE	PRICE
ARSIS TOILET ROLL HOLDER - TWIN	WHITE	ALAC-10-2802	£43.50
ARSIS TOILET ROLL HOLDER - TWIN	WHITE/CHROME	ALAC-12-2802	£57.00
ARSIS TOILET ROLL HOLDER - TWIN	BRIGHT ANODISED	ALAC-02-2802	£69.00

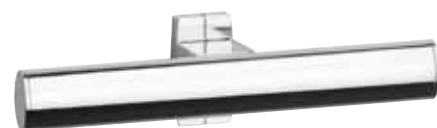

ARSIS SLIDE RAIL SHOWER BAR

DESCRIPTION	FINISH	PRODUCT CODE	PRICE
ARSIS SLIDE RAIL SHOWER BAR	ANTHRACITE	ALAC-02-2002	£270.00
ARSIS SLIDE BRACKET	ANTHRACITE	ALAC-10-2204	£33.00
ARSIS SOAP HOLDER FOR SHOWER BAR	ANTHRACITE	ALAC-02-2202	£21.00



Silent 100 Design

EnviroVent's stylish SILENT 100 DesignFan is ideal for bathrooms, utility rooms and WCs.

It is available in two colours, white or silver and has four smart looking interchangeable front panel trims in four evocative shades. What's more, by incorporating whisper-quiet silent technology, the presence of the SILENT 100 Design Fan promises never to ruin the ambiance of the room it is installed in.

In 2013, the SILENT 100 Design Fan received the Noise Abatement's Society's seal of approval - the Quiet Mark. This versatile little number can be wall or ceiling mounted and is also available with timer and humidity sensor options.



find out more at www.envirovent.com

SILENT 100 DESIGN SHADOW SILVER

- Sealed for life ball bearings
- Silent elastic blocks
- Numerous quality features
- IP44 rated
- Backdraught shutter and airflow guide vanes as standard
- Incredibly silent running
- High performance
- Significant energy savings
- Complies with building regulations
- Five year guarantee

DESCRIPTION	PRODUCT CODE	PRICE
SILENT 100 DESIGN STANDARD	ENV-SILDES100SS	£72.38
SILENT 100 DESIGN ADJUSTABLE TIMER	ENV-SILDES100TS	£137.88
SILENT 100 DESIGN ADJUSTABLE TIMER & HUMIDITY SENSOR	ENV-SILDES100HTS	£155.58

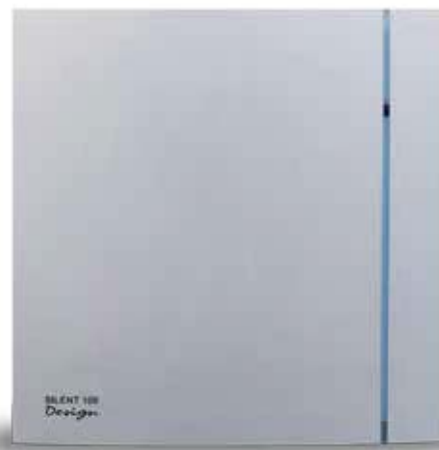

SILENT 100 DESIGN WHITE

- Sealed for life ball bearings
- Silent elastic blocks
- Numerous quality features
- IP44 rated
- Backdraught shutter and airflow guide vanes as standard
- Incredibly silent running
- High performance
- Significant energy savings
- Complies with building regulations
- Five year guarantee

DESCRIPTION	PRODUCT CODE	PRICE
SILENT 100 DESIGN STANDARD	ENV-SILDES100S	£64.80
SILENT 100 DESIGN ADJUSTABLE TIMER	ENV-SILDES100T	£114.71
SILENT 100 DESIGN ADJUSTABLE TIMER & HUMIDITY SENSOR	ENV-SILDES100HT	£142.40



EnviroVent

BATHROOM
VENTILATION

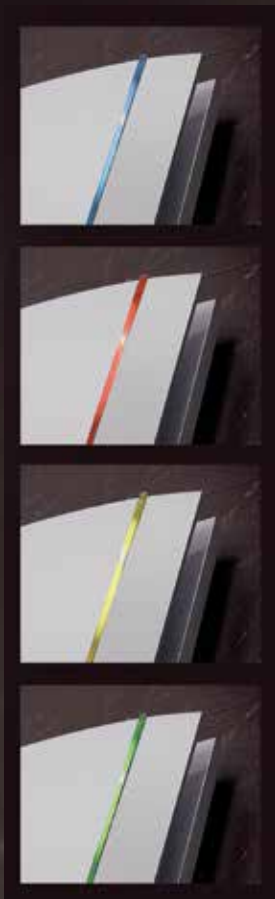

SILENT 100
Design

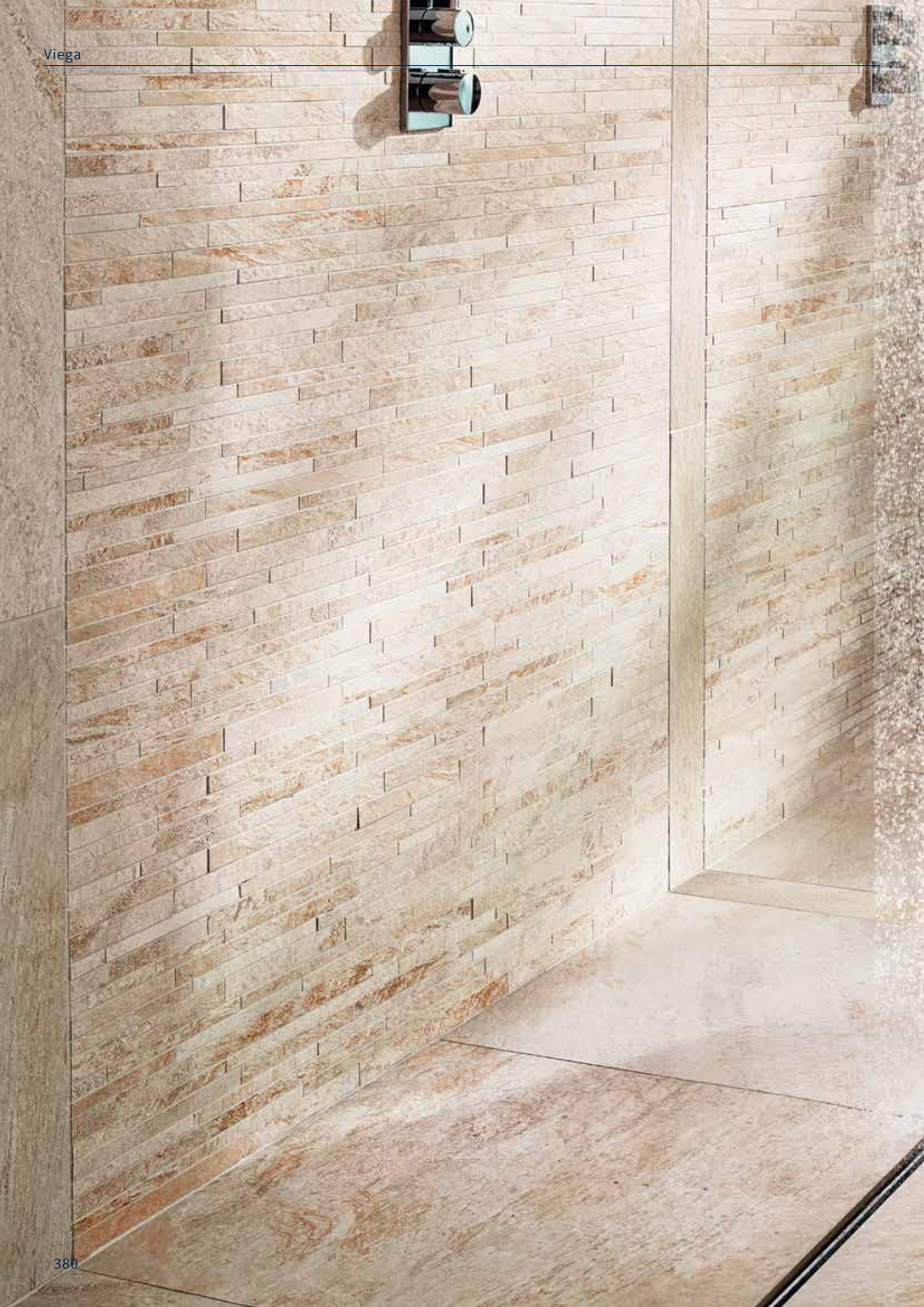



Viega
HIGH PERFORMANCE DRAINAGE AND
PLUMBING SOLUTIONS

find out more at www.viega.com

Advantix Vario

THE FIRST TAILOR-MADE SHOWER CHANNEL



Viega Advantix Vario is the first shower channel which can be shortened exactly to the required length.

Whether installed directly on the wall or free-standing in the room, whether straight, corner or U-shape – the Advantix Vario shower channel makes it easy to design your bathroom individually, while satisfying all the structural demands.



1. Simple, quick assembly

Step 1: Shorten the channel base unit using a hacksaw and a saw guide, deburr the cut edges, attach the protective caps and screw on. Step 2: Determine the construction height, shorten the height adjustment piece and mount the drain set and support feet. Step 3: Align the shower channel, connect to the drain pipe and fasten the feet.



2. Secure sealing concept

A durable and practicable seal is the most important feature of a floor level shower. All of the materials required, such as special adhesive and sealing strip, are included in the scope of delivery.



3. Height adjustable

Using an adjustable bridge bracket, the grate height can be adjusted to tile heights of 5 to 20 mm. For thicker floor coverings (e.g. natural stone), Viega offers an accessories kit, with which the metal grate can be adjusted to between 15 and 30mm. For corner, U and long designs, there are additional connectors available. The connections to the channel are sealed with a special sealant which guarantees a secure connection.

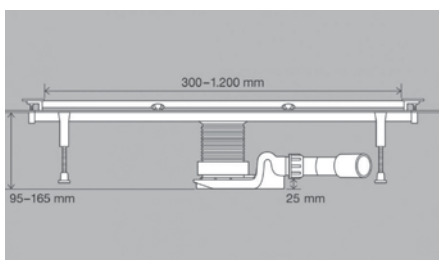

4. Variable installation height

The installation height of the Advantix Vario is between 95 and 165mm. In its flattest installation state, the height difference between the drain support and foundation is just 25mm. For standard inclines, this means 250cm of connecting pipes can be installed without having to raise the shower channel. The drainage capacity for each individual channel is 0.4 to 0.8l/s depending on the installation height.

- Prize-winning design
- Attractive colours
- Limitless design options
- Permits all channel lengths from 30cm to 280cm
- Quick and simple assembly
- Variable installation height
- Secure sealing concept
- Height-adjustable grate
- Self-cleaning drain
- Drainage capacity of up to 2.4l/s
- Extensive accessories

STANDARD MODEL ADVANTIX VARIO SHOWER CHANNEL

(VIE-686277)

- Base unit, 300–1,200 mm
- Variable construction height between 95 and 165 mm

£360.34



RECONSTRUCTION MODEL ADVANTIX VARIO SHOWER CHANNEL

(VIE-721671)

- Base unit, 300–1,200 mm
- Construction height 70 mm

£360.34



ADVANTIX VARIO STANDING GRATE

(VIE-686284)

- For shower channel, 300–1,200 mm
- Stainless steel matt

£89.71



ADVANTIX VARIO CONNECTION PIECE

(VIE-708917)

£98.34



ADVANTIX VARIO ACCESSORY SET

(VIE-711795)

- For end closing piece and connection piece
- Stainless steel matt

£62.14



Advantix Vario

CORNER VARIANT

viega



ADVANTIX VARIO END CLOSING PIECE

(VIE-708924)

£134.53

RECONSTRUCTION MODEL

(VIE-721688)

£134.53



ADVANTIX VARIO ACCESSORY SET

(VIE-711788)

- For connection piece 90°
- Stainless steel matt

£62.14



ADVANTIX VARIO CLEANING DEVICE

(VIE-689711)

- For plunger
- Suitable for Advantix Vario shower channel

£34.13



Advantix Vario

WALL DRAIN

viega



ADVANTIX VARIO WALL DRAIN

(VIE-736552)

- Base unit, 300–1,200 mm

£410.98

RECONSTRUCTION MODEL

(VIE-736736)

£438.98



ADVANTIX VARIO STANDING GRATE

(VIE-736569)

- Stainless steel matt

£89.71



Viega Visign

BATH POP UP WASTES



SIMPLEX DRAIN AND OVERFLOW

- Flat version, only 33 mm space required behind the bathtub
- Supplied with: rotatable rosette, cover plate

DESCRIPTION	PRODUCT CODE	PRICE
SIMPLEX DRAIN AND OVERFLOW	VIE-133825	£53.98
SIMPLEX DRAIN AND OVERFLOW - FOR EXTRA LARGE BATHS	VIE-595685	£62.35



MULTIPLEX DRAIN/OVERFLOW VISIGN M5

- Flat version, only 33 mm space required behind the bathtub
- Chrome plated
- Available with or without rotatable rosette and valve cone

DESCRIPTION	PRODUCT CODE	PRICE
MULTIPLEX DRAIN/OVERFLOW VISIGN M5	VIE-101909	£91.83
MULTIPLEX DRAIN/OVERFLOW VISIGN M5 - EXTRA LARGE BATHS	VIE-138561	£100.54



BATH WASTE FILLERS - SIDE FILL

MULTIPLEX TRIO DRAIN/OVERFLOW/FILLER

- Flat version; only 33 mm space required behind the bathtub
- For water inlet through the overflow unit,
- Supplied with: rotatable rosette, overflow rosette, valve cone, odour trap



DESCRIPTION	PRODUCT CODE	PRICE
MULTIPLEX TRIO DRAIN	VIE-727734	£275.62
MULTIPLEX TRIO DRAIN - EXTRA LARGE BATHS	VIE-727741	£293.12

MULTIPLEX TRIO MOTORISED DRAIN/OVERFLOW/FILLER

(VIE-731618)

- Flat version; only 33 mm space required behind the bathtub
- For water inlet through the overflow unit
- Suitable for all Multiplex Trio E models
- Valve cone motor-driven
- Chrome-plated overflow rosette, chrome-plated valve cone, supply flange, odour trap, drain elbow 45°, electrical valve cone actuation, DC motor 12 V/0.5 A, on-off pulse count, pulse duration max. 3 sec., with 3 m connection cable with JST/XHP 5



£ 411.64

BATH WASTE FILLERS - BOTTOM FILL

MULTIPLEX TRIO F DRAIN/OVERFLOW/FILLER

- Flat version, only 33 mm space required behind the bathtub
- Chrome plated
- For water inlet via drain unit, supplied without: rotatable rosette, overflow rosette, valve cone



DESCRIPTION	PRODUCT CODE	PRICE
MULTIPLEX TRIO F DRAIN	VIE-672027	£470.51
MULTIPLEX TRIO F DRAIN - EXTRA LARGE BATHS	VIE-675462	£476.87

MULTIPLEX TRIO F MOTORISED DRAIN/OVERFLOW/FILLER

(VIE-675493)

- For water inlet through the drain unit
- Suitable for all Multiplex Trio E models
- Valve cone motor-driven
- Chrome-plated overflow rosette, chrome-plated cover plate, inlet element, odour trap, drain elbow 45°, concealed pipe interrupter DN20, DIN EN 1717 safety device DB with rosette RU2, electrical valve cone actuation, DC motor 12 V/0.5 A, on off pulse count, pulse duration max. 3 sec., with 3 m connection cable with JST/XHP 5



£ 692.95

Viega Visign

SHOWER & BASIN DRAINAGE



DOMOPLEX SHOWER DRAIN 90mm

(VIE-208615)

- Chrome-plated cover plate
- Removable odour trap
- Drain elbow 45°
- Requires DN 50 adapter (see page 80)



£ 32.88

TEMPOPLEX PLUS 90 SHOWER DRAIN

(VIE-578916)

- Construction height 90
- Drainage capacity 0.85 l/s
- Requires DN 50 adapter (see page 80)
- Chrome-plated cover plate



£73.08

BASIN ODOUR TRAP

- For concealed mounting
- Plastic
- Height-adjustable



DESCRIPTION	PRODUCT CODE	PRICE
BASIN ODOUR TRAP - CHROME	VIE-553753	£56.01
BASIN ODOUR TRAP - WHITE	VIE-553760	£38.07

BASIN ODOUR TRAP

(VIE-570323)

- For wall-mounted assembly
- Plastic
- Height-adjustable



£34.32

**viega**

Viega Visign

ELECTRONIC MIXERS FOR BATHS & SHOWERS

The electronic bathtub fittings Multiplex Trio E are characterised by the comfort they offer in terms of fully-automated tub filling as well as their long service life, easy operation, and award-winning design. Timelessly beautiful and made of chrome and glass, their shape and materials complement any bathroom design.

Viega Visign

NEW COMFORT - ELECTRONIC MIXER UNITS

Fully automated bathtub filling

The multi-functional operating elements of the Multiplex Trio E fittings (MT E) regulate and save the water temperature, volume and filling level. The settings can be accessed at any time – there's no need to watch the bath filling up. In addition, the electrical valve cone of the optional Viega drainage and overflow fittings can be opened and closed using the MT E controls.



Multiplex Trio E3: with display and control element

The display element makes it intuitive to operate. It shows the individual default settings, water temperature and water inlet volume and a user menu is displayed when you press lightly, allowing you to select all further functions to do with filling the bath. The temperature selection and On/Off function are combined into one chrome-plated control element.



MULTIPLEX TRIO E3 CONTROL ELEMENTS

The rotatable display element with a glass surface and the element made completely of chrome ensure intuitive handling. That makes Trio E3 especially attractive for use in semi-public buildings (hotel or medical uses).

Multiplex Trio E2: with two control elements

The bath is filled using two control elements. One controls the On/Off function and water temperature. Another regulates the water inlet volume and the switchover to the adjustable shower head.



MULTIPLEX TRIO E2 CONTROL ELEMENTS

A clear separation of the functions in two control elements, but optically identical. The Multiplex Trio E2 stands for clarity in control and function.

Multiplex Trio E: with all functions in one control element

One button for everything: all functions can be called up using one control element.



MULTIPLEX TRIO E CONTROL ELEMENT

Everything is concentrated in one central control element. Information about the water temperature and the flow volume can be seen on the lighting.

MULTIPLEX TRIO E MIXER UNIT

(VIE-662295)

- For filling a bathtub (electronically controlled), in connection with Multiplex Trio, Multiplex Trio F, Rotaplex Trio or Rotaplex Trio F (optional electric driven), electrical opening/closing of a Viega drain fitting
- Chrome-plated control element, memory function for temperature and water flow volume and filling height, 3 personalized pre-settings, bath-tub inlet/hand shower function can be changed manually, temperatures above the 38 °C block can be set manually, flexible connection hoses, corner valves, power pack
- Mains voltage 100–240 V AC/50–60 Hz

£1,969.60



MULTIPLEX TRIO E2 MIXER UNIT

(VIE-682972)

- Control electronics and monitoring: water temperature, water flow volume
- Memory function for 3 personalized settings, bathtub inlet/hand shower function can be changed manually
- Power pack: mounted at tub rim
- For wall mounting, an additional mounting set is required
Article 671 358 (2 pcs.) £ 127.48

£2192.34



MULTIPLEX TRIO E3 MIXER UNIT

(VIE-684655)

- Control electronics and monitoring: water temperature, water flow volume
- Memory function for 3 personalized settings, bathtub inlet/hand shower function can be changed manually, integrated graphic display, statistics functions
- Power pack: mounted at tub rim
- For wall mounting, an additional mounting set is required, Article 671 358 (1 pc.) £ 127.48, and mounting set Article 684 877 (1 pc.) £ 181.95

£2399.50



Viega Profipress

PIPE FITTINGS



Viega Profipress sets standards in quality and hygiene. High quality materials and intelligent technology guarantee the necessary quality of drinking water at any extraction point.

Copper and gunmetal: ideal materials for drinking water hygiene.

Drinking water regulations stipulate that materials must not be able to cause any unauthorised change to the properties of the drinking water. For this reason, only copper and gunmetal are used in the Profipress system. Quality materials, which are both long lasting and corrosion-resistant. All the connectors are delivered, hygienically packaged in a bag.

Recommended: installation as closed circular and series pipelines.

To avoid any risk to the drinking water quality caused by stagnation, a constant exchange of water must be ensured in all areas of the drinking water installation. For this reason, extraction points that are not in regular use must be installed in either closed circular or series pipelines. Viega has the right technology on offer for both of these.

Profipress connections in 15mm, 22mm and 28mm sizes to suit the UK market.

The low pressure losses of Profipress connections make it possible to tailor the dimensioning to demand. There are economic and hygienic advantages to this. The Profipress fittings are for use with UK standard copper tube manufactured to BS 2871.



Viega press connection pipe fittings

STRAIGHT COUPLING

DESCRIPTION	PRODUCT CODE	PRICE
15mm COUPLING	VIE-292690	£2.11
22mm COUPLING	VIE-292683	£3.40



MALE IRON – PIPE CONNECTOR

DESCRIPTION	PRODUCT CODE	PRICE
15mm x R 1/2"	VIE-105044	£3.10
22mm x R 3/4"	VIE-104306	£5.39



FEMALE IRON – PIPE CONNECTOR

DESCRIPTION	PRODUCT CODE	PRICE
15mm x R-p 1/2"	VIE-107543	£3.52
22mm x R-p 3/4"	VIE-108465	£5.95



REDUCER

DESCRIPTION	PRODUCT CODE	PRICE
22mm x 15mm REDUCER 22-SC	VIE-296377	£2.49



REDUCER

DESCRIPTION	PRODUCT CODE	PRICE
22mm x 15mm REDUCER SC-SC	VIE-325794	£12.20



ELBOWS

DESCRIPTION	PRODUCT CODE	PRICE
15mm ELBOW SC-SC	VIE-291501	£2.23
22mm ELBOW SC-SC	VIE-291518	£3.79



STREET ELBOW

DESCRIPTION	PRODUCT CODE	PRICE
15mm STREET ELBOW 15-SC	VIE-291662	£2.26
22mm STREET ELBOW 22-SC	VIE-291679	£3.75



45° STREET ELBOW (M&F)

DESCRIPTION	PRODUCT CODE	PRICE
15mm 45° STREET ELBOW 15-SC	VIE-292508	£2.24
22mm 45° STREET ELBOW 22-SC	VIE-292515	£3.71



BACK PLATE ELBOW

DESCRIPTION	PRODUCT CODE	PRICE
15mm x 1/2" BACKPLATE ELBOW	VIE-107345	£10.27



EXTENDED BACK PLATE ELBOW

DESCRIPTION	PRODUCT CODE	PRICE
15mm x 1/2" BACKPLATE ELBOW	VIE-347307	£22.03



V BACK PLATE ELBOW

DESCRIPTION	PRODUCT CODE	PRICE
15mm x 1/2" BACKPLATE ELBOW	VIE-687892	£7.84



THROUGH BACK PLATE ELBOW

DESCRIPTION	PRODUCT CODE	PRICE
15mm x 1/2" BACKPLATE ELBOW	VIE-644864	£5.84



PIPE CROSSOVER

DESCRIPTION	PRODUCT CODE	PRICE
PIPE CROSSOVER 15mm SC-SC	VIE-352134	£18.10
PIPE CROSSOVER 22mm SC-SC	VIE-352158	£22.63



EQUAL TEE

DESCRIPTION	PRODUCT CODE	PRICE
EQUAL TEE 15mm SC	VIE-291952	£3.36
EQUAL TEE 22mm SC	VIE-291969	£6.16



UNEQUAL TEE

DESCRIPTION	PRODUCT CODE	PRICE
UNEQUAL TEE 22-15-22mm SC	VIE-292027	£5.37
UNEQUAL TEE 22-22-15mm SC	VIE-315047	£10.24



STOP END

DESCRIPTION	PRODUCT CODE	PRICE
15mm STOP END SC	VIE-349301	£5.43
22mm STOP END SC	VIE-349356	£9.39



150mm MOUNTING UNIT

DESCRIPTION	PRODUCT CODE	PRICE
150mm MOUNTING UNIT	VIE-308681	£5.65



BALL VALVE

DESCRIPTION	PRODUCT CODE	PRICE
BALL VALVE 15mm SC	VIE-475857	£28.35
BALL VALVE 22mm SC	VIE-475871	£42.97



50mm RADIATOR CONNECTION

DESCRIPTION	PRODUCT CODE	PRICE
50mm RADIATOR CONNECTION	VIE-662509	£14.67



Viega Pressgun



VIEGA PRESSGUN PICCO

(VIE-735456)

- with rechargeable battery
- with press jaws for metallic press connector systems
- equipped with Press jaws: 15mm, 22mm, 28mm
- lithium ion rechargeable battery technology
- rechargeable battery 18 V/2.0 Ah
- battery charger 230 V/18 V
- patented safety mechanism
- automatic maintenance display
- LED lamp for lighting of press position
- case with space saver for power pack



£ POA



FERNOX F1 EXPRESS PROTECTOR 265ml

(MSFE-01-0001)

- Quick and convenient – doses in 30 seconds
- Simple to use with no mess
- Protects against corrosion and limescale
- 100% recyclable can
- Maintains system efficiency and extends boiler life
- Suitable for use with all metals and materials including aluminium
- Non toxic, environmentally friendly

£23.50



FERNOX F5 EXPRESS CLEANER 280ml

(MSFE-05-0005)

- Quick, convenient and simple to use – doses in 30 seconds
- 100% recyclable cans
- Added via a radiator adapter or filling loop supplied
- Compatible with all metals and materials including aluminium
- Removes sludge and scale and restores heating efficiency
- Removes flux residues and other debris
- Neutral, non-hazardous and environmentally formulation

£26.50



FERNOX TF1 INSTALLER PACK WITH FILTER

(MSFE-20-0005)

- Award winning Total Filter TF1's unique action removes magnetic and non-magnetic contaminants
- Easy to fit and clean – the TF1 makes servicing simple
- Fernox Express doses via the TF1 in 30 seconds to save time spent on-site
- Fernox best in class for innovative design, formulations, and applications

£139.50



Index

Sanitaryware & Furniture

D-STYLE	16
SIMPLE	25
PURE	40
COMPLEMENTARY FURNITURE	47
HANDS & FACES	51
MIX & MATCH	58

Taps & Brassware

LOGIC	64
KI	66
EDITION	68
PLAN	70
ALA-S	72
TWIST	74
ISO	76
XS	78
TRAPS & WASTES	80

Showers & Shower Kits

EMOTION SHOWER VALVES	84
EMOTION SHOWER ACCESSORIES	87
EMOTION SHOWER KITS	95
TEMPTATION SHOWER VALVES	99
TEMPTATION SHOWER ACCESSORIES	101
EMOTION PLUS SHOWER KITS	107
TEMPTATION SHOWER KITS	111

Baths & Bath Screens

BATHS	116
FREESTANDING BATHS	122
BATH SCREENS	126
TILEABLE BATH PANELS & STEPS	128

Towel Warmers & Radiators

ELEGANCE MILD STEEL CHROME & PAINTED	131
ELEGANCE MILD STEEL TRADITIONAL	149
ELEGANCE STAINLESS STEEL	153
ELEGANCE ACCESSORIES	166
ELECTRIC HEATING OPTIONS	168
TOWEL WARMER CARE	172
ULTIMA RADIATOR VALVES	174

Flushing & Support Systems

WC FRAMES & CISTERNS	176
WATER DISTRIBUTION MANIFOLDS	192

Elements Wetrooms

RAISED SHOWERING CONCEPT KITS	196
LEVEL ACCESS SHOWER TRAY KITS	206
LEVEL ACCESS 30mm SHOWER TRAY KITS	208
OVERBOARD FLOOR KITS	218
INFINITY SINGLE FALL WETROOM SYSTEM	222
ELEMENTS BUILDING BOARDS	226
SHOWER WALL PANELLING KITS	228
WATERPROOF RECESSED STORAGE UNITS	230
SHOWER SEATING	232
COMPLETE SHOWER CUBICLES	234
BESPOKE & WELLNESS PRODUCTS	248
WETROOM GLASS	252

Designer Bathroom Tiles

NATURAL STONE TILES	282
PORCELAIN TILES	288
SPECIALIST MOSAIC TILES	314

Mirrors & Cabinets

MIRRORS	324
SURFACE CABINETS	326
RECESSED CABINETS	328

Bathroom Accessories

PURE STAINLESS STEEL	332
LINE	334
HALO	336

Partner Brands

LUSTROLITE GLASS EFFECT PANELLING	340
DEVI UNDERFLOOR HEATING	348
LED LIGHTING	354
ROCATEX ADHESIVES & GROUTS	360
GRUNDFOS SHOWER PUMPS	368
PELLET ASSISTED LIVING	374
ENVIROVENT BATHROOM VENTILATION	378
VIEGA HIGH PERFORMANCE DRAINAGE	380
FERNOX HEATING PROTECTION	396

General

CARE & MAINTENANCE	398
PRODUCT GUARANTEE	398
TERMS AND CONDITIONS	399
ABACUS BATHROOM DESIGN TIPS	400

General

Prices

The prices displayed throughout this catalogue supersede all other previous publicised price lists. All prices include VAT and are subject to change without prior notice.

Returns

Goods may be returned for credit only following written approval by Abacus.

Special-order or bespoke items are non-returnable.

Order cancellation will be subject to a 25% re-stocking charge.

Abacus reserve the right to refuse credit on goods returned damaged or in a condition unfit for resale.

Also there may be an applicable charge for the re-boxing of a returned product.

Delivery

All orders below a nett invoice value of £100 (ex. VAT) will incur a £6.95 delivery charge.

The Company must be notified within 14 days of any claim for a product not delivered.

Abacus will do our best to deliver all orders on time and complete, however we cannot accept any liability for delays or failure to deliver products.

Care and maintenance

Abacus products are manufactured to exacting standards and following the care and cleaning guidelines below will ensure that your bathroom will give you years of effective use.

Sanitaryware

Ceramic items such as wash basins, WCs and bidets should be cleaned with a cream type bathroom cleaner applied with a damp cloth or sponge using warm water.

Resin cast basins have a protective 'Evermite' surface to help against the build-up of dirt and limescale. They should be cleaned using diluted detergent in warm water and applied with a non-abrasive cloth.

Toilet seats should be cleaned using a mild detergent and a non-abrasive cloth. Cleaning products containing bleach should not be used on toilet seats as this may cause discolouring.

Furniture

Our furniture is a high quality timber product and needs to be installed in a bathroom with appropriate extraction/ventilation. It should not be sited in a position within the bathroom where it will become constantly wet. For best results, any standing water left on the furniture should be removed daily with a moist microfibre cloth.

Taps & Brassware

Taps and brassware products should be cleaned with a diluted mild detergent such as washing up liquid applied with a soft sponge or cloth, and then buffed dry with a microfibre cloth.

Avoid using acids, rough sponges or steel wool and do not leave detergent on the products for long periods of time.

Towel Warmers

Both mild steel and stainless steel towel warmers should be cleaned only when cold with a moist soft or microfibre cloth. Any surface oxidation on the products should be removed using a metal polishing cream such as 'PEEK'. We also recommend that towel warmers are polished with a PEEK type product on an annual basis to give long-lasting surface protection.

Natural & Porcelain Tiles

Both natural and porcelain tiles should be cleaned and protected with the appropriate Rocatex cleaner or sealer (found within our Partner Brands Section), and as directed by the specific instructions for the individual product.

Glass

Our glass wetroom screens are protected by an easyclean nano-technology coating to make cleaning easier. We recommend that glass screens are cleaned with a diluted detergent and dried with a microfibre cloth. We recommend regular wiping of glass screens in order to remove excess water, which in some areas can be quite aggressive.

GENERAL

NEVER use products containing bleach on bathroom products or any cleaners or cloths of an abrasive nature.

Product Guarantee*

Unless stated below all Abacus products carry a 15 year guarantee.

- The guarantee covers products which have been installed to the manufacturer's instructions, and if used in a bathroom, the room is deemed to have suitable ventilation in accordance with UK building regulations.
- The guarantee is available to original purchasers who have proof of purchase and is non-transferable.
- Abacus operate a policy of continued product development. In the event that a faulty product has been superseded, Abacus will replace the product with the nearest equivalent item. Abacus reserve the right to change designs and specifications without prior notice.
- In the event of a product fault after installation, Abacus must be given the opportunity to inspect the item in its installed state.
- The guarantee does not cover consequential loss. (Your statutory rights are not affected).
- The guarantee does not cover products that have been modified in any way.
- The guarantee does not cover any products that have previously been on display in a showroom.
- The guarantee covers products in normal use. Faults or damage caused by neglect, misuse, wilful or accidental damage, inappropriate cleaning and incorrect installation are not covered under the guarantee.
- The guarantee covers UK installations only.

*Exceptions to the Abacus 15 Year Guarantee

* Mild Steel Towel Warmers – 10 years

* Furniture & Cabinets - 5 years

* Cistern Fittings, Toilet Seats & Light Bulbs – 1 year

* Electrical Parts – 1 year

Terms and conditions

1. INTERPRETATION

1.1 Definitions

In these Conditions, the following definitions apply:

Abacus: Abacus Direct Limited a company registered in England and Wales with company number 04331572 whose registered office is at Abacus House Jubilee Court, Copgrove, Harrogate, North Yorkshire, HG3 3TB.

Business Day: a day (other than a Saturday, Sunday or public holiday) when banks in London are open for business.

Conditions: the terms and conditions set out in this document as amended from time to time in accordance with condition 13.9 and all other documents referred to therein including, but not limited to, the Returns Policy and the Delivery Guide.
Contract: the contract between Abacus and the Customer for the sale and purchase of the Goods in accordance with these Conditions.

Customer: the person or firm who purchases the Goods from Abacus.

Delivery Guide: Abacus' guide to delivery costs and services which is available online at www.abacus-bathrooms.co.uk.

End-User: the person or firm to which the Customer re-sells the Goods.

Force Majeure Event: an event beyond the reasonable control of the affected party including but not limited to strikes, lock-outs or other industrial disputes (whether involving the workforce of the party or any other party), failure of a utility service or transport network, act of God, war, riot, civil commotion, malicious damage, compliance with any law or governmental order, fire, regulation or direction, accident, breakdown of plant or machinery, telecommunications failure (including problems with internet transmission) fire, flood, storm or default of suppliers or subcontractors.

Goods: the goods (or any part of them) set out in the Order.

OEM Branding: the OEM Customer's brand.

OEM Customer: a Customer who requests Abacus to manufacture the Goods to include OEM Branding.

Order: the Customer's order for the Goods that can be placed either by email, telephone, fax or such other electronic means as Abacus and the Customer may agree from time to time.

Product Portfolio: Abacus' catalogue listing all the Goods supplied by Abacus and setting out the description of the Goods, the prices and the Product Warranty as may be amended or updated by Abacus from time to time.

Product Warranty: the warranty provided by Abacus (or the manufacturer of the Goods) in respect of each of the Goods as set out in the Product Portfolio.

Returns Policy: Abacus' returns policy which is available online at www.abacus-bathrooms.co.uk.

Services: dealing with enquiries or complaints raised by End-Users, the processing of returns of Goods and/or showroom design and fitting services.

Specification: any specification for the Goods, including OEM Branding and any related plans and drawings that is agreed in writing by the Customer and Abacus.

VAT: value added tax.

Warranty Period: has the meaning set out in condition 5.1.

Website: Abacus' website at www.abacusedirecttd.com.

1.2 Construction

In these Conditions, the following rules apply:

1.2.1 A person includes a natural person, corporate or unincorporated body (whether or not having separate legal personality).

1.2.2 A reference to a party includes its personal representatives, successors or permitted assigns.

1.2.3 A reference to a statute or statutory provision is a reference to such statute or provision as amended or re-enacted. A reference to a statute or statutory provision includes any subordinate legislation made under that statute or statutory provision, as amended or re-enacted.

1.2.4 Any phrase introduced by the terms including, include, in particular or any similar expression shall be construed as illustrative and shall not limit the sense of the words preceding those terms.

1.2.5 A reference to writing or written includes faxes and e-mails.

2. BASIS OF CONTRACT

2.1 These Conditions apply to the Contract to the exclusion of any other terms that the Customer seeks to impose or incorporate, or which are implied by trade, custom, practice or course of dealing.

2.2 The Order constitutes an offer by the Customer to purchase the Goods in accordance with these Conditions. The Customer is responsible for ensuring that the terms of the Order and any applicable Specification submitted by the Customer are complete and accurate.

2.3 The Order shall only be deemed to be accepted when Abacus issues a written order acknowledgement, at which point the Contract shall come into existence.

2.4 The Contract constitutes the entire agreement between the parties. The Customer acknowledges that it has not relied on any statement, promise, representation, assurance or warranty made or given by or on behalf of Abacus which is not set out in the Contract.

2.5 Any samples, drawings, descriptive matter, or advertising produced by Abacus and any descriptions or illustrations contained in the Product Portfolio and/or the Website are produced for the sole purpose of giving an approximate idea of the Goods described in them. They shall not form part of the Contract or have any contractual force.

3. GOODS

3.1 The Goods are described in the Product Portfolio and the Website as modified by any applicable Specification.

3.2 To the extent that the Goods are to be manufactured in accordance with a Specification supplied by the Customer, the Customer shall indemnify Abacus against all liabilities, costs, expenses, damages and losses (including any direct, indirect or consequential losses, loss of profit, loss of reputation and all interest, penalties and legal and other professional costs and expenses) suffered or incurred by Abacus in connection with any claim made against Abacus for actual or alleged infringement of a third party's intellectual property rights arising out of or in connection with Abacus' use of the Specification. This condition 3.2 shall survive termination of the Contract.

3.3 Abacus reserves the right to amend the Specification if required by any applicable statutory or regulatory requirements.

4. DELIVERY

4.1 All deliveries shall be carried out in accordance with this condition 4 and the Delivery Guide.

4.2 Abacus shall deliver the Goods to the location set out in the Order or such other location as the parties may agree (Delivery Location).

4.3 Delivery of the Goods shall be completed on the Goods' arrival at the Delivery Location.

4.4 On delivery, the Customer shall check the Goods. If the Goods were damaged during transport or delivery, or if the quantity of Goods delivered is different to the quantity of Goods ordered, then the Customer must report any issues to Abacus' sales office as soon as possible and in any event no later than 2 Business Days after delivery.

4.5 Any dates quoted for delivery are approximate only, and the time of delivery is not of the essence. Abacus shall not be liable for any delay in delivery of the Goods that is caused by a Force Majeure Event or the Customer's failure to provide Abacus with adequate delivery instructions or any other instructions that are relevant to the supply of the Goods.

4.6 If Abacus fails to deliver the Goods, its liability shall be limited to the costs and expenses incurred by the Customer in obtaining replacement goods of similar description and quality in the cheapest market available, less the price of the Goods. Abacus shall have no liability for any failure to deliver the Goods to the extent that such failure is caused by a Force Majeure Event or the Customer's failure to provide Abacus with adequate delivery instructions or any other instructions that are relevant to the supply of the Goods.

4.7 If the Customer fails to accept delivery of the Goods within three Business Days of Abacus notifying the Customer that the Goods are ready, then, except where such failure or delay is caused by a Force Majeure Event or Abacus' failure to comply with its obligations under the Contract:

4.7.1 delivery of the Goods shall be deemed to have been completed at 9.00 am on the third Business Day after the day on which Abacus notified the Customer that the Goods were ready; and

4.7.2 Abacus shall store the Goods until delivery takes place, and charge the Customer for all related costs and expenses (including insurance).

4.8 If 10 Business Days after the day on which Abacus notified the Customer that the Goods were ready for delivery the Customer has not accepted delivery of them, Abacus may resell or otherwise

dispose of part or all of the Goods and, after deducting reasonable storage and selling costs, account to the Customer for any excess over the price of the Goods or charge the Customer for any shortfall below the price of the Goods.

4.9 Abacus may deliver the Goods by instalments, which shall be invoiced and paid for separately. Each instalment shall constitute a separate Contract. Any delay in delivery or defect in an instalment shall not entitle the Customer to cancel any other instalment.

5. QUALITY

5.1 Abacus warrants that on delivery, and for the period specified by each Product Warranty (warranty period), the Goods shall:

5.1.1 conform in all material respects with their description and any applicable Specification;

5.1.2 be of satisfactory quality; and

5.1.3 be fit for any purpose held out by Abacus.

5.2 Subject to condition 5.3, if:

5.2.1 the Customer gives notice in writing to Abacus during the warranty period within a reasonable time of discovery that some or all of the Goods do not comply with the warranty set out in condition 5.1;

5.2.2 Abacus is given a reasonable opportunity of examining such Goods; and

5.2.3 the Customer (if asked to do so by Abacus) returns such Goods to the Abacus' place of business at the Customer's cost, Abacus shall, at its option, repair or replace the defective Goods, or refund the price of the defective Goods in full.

5.3 Abacus shall not be liable for any failure of the Goods to comply with the warranty set out in condition 5.1 in any of the following events:

5.3.1 the Customer makes any further use of such Goods after giving notice in accordance with condition 5.2;

5.3.2 the defect arises because the Customer failed to follow Abacus' oral or written instructions as to the storage, commissioning, installation, use and maintenance of the Goods or (if there are none) good trade practice regarding the same;

5.3.3 the defect arises as a result of Abacus following any drawing, design or Specification supplied by the Customer;

5.3.4 the Customer alters or repairs such Goods without the written consent of Abacus;

5.3.5 the defect arises as a result of fair wear and tear, wilful damage, negligence, or abnormal storage or working conditions; or

5.3.6 the Goods differ from their description or the Specification as a result of changes made to ensure they comply with applicable statutory or regulatory requirements.

5.4 Except as provided in this condition 5, Abacus shall have no liability to the Customer in respect of the Goods' failure to comply with the warranty set out in condition 5.1.

5.5 These Conditions shall apply to any repaired or replacement Goods supplied by Abacus and should be read in conjunction with the Returns Policy.

6. TITLE AND RISK

6.1 The risk in the Goods shall pass to the Customer on completion of delivery.

6.2 Title to the Goods shall not pass to the Customer until the earlier of:

6.2.1 Abacus receives payment in full (in cash or cleared funds) for the Goods and any other goods that Abacus has supplied to the Customer in respect of which payment has become due, in which case title to the Goods shall pass at the time of payment of all such sums; and

6.2.2 the Customer resells the Goods, in which case title to the Goods shall pass to the Customer at the time specified in condition 6.4.

6.3 Until title to the Goods has passed to the Customer, the Customer shall:

6.3.1 store the Goods separately from all other goods held by the Customer so that they remain readily identifiable as Abacus' property;

6.3.2 not remove, deface or obscure any identifying mark or packaging on or relating to the Goods;

6.3.3 maintain the Goods in satisfactory condition and keep them insured against all risks for their full price from the date of delivery;

6.3.4 notify Abacus immediately if it becomes subject to any of the events listed in condition 10.1; and

6.3.5 give Abacus such information relating to the Goods as Abacus may require from time to time.

6.4 Subject to condition 6.5, the Customer may resell or use the Goods in the ordinary course of its business (but not otherwise) before Abacus receives payment for the Goods. However, if the Customer resells the Goods before that time:

6.4.1 it does so as principal and not as Abacus agent; and

6.4.2 title to the Goods shall pass from Abacus to the Customer immediately before the time at which resale by the Customer occurs.

6.5 If before title to the Goods passes to the Customer the Customer becomes subject to any of the events listed in condition 10.1, then, without limiting any other right or remedy Abacus may have:

6.5.1 the Customer's right to resell the Goods or use them in the ordinary course of its business ceases immediately; and

6.5.2 Abacus may at any time:

6.5.2.1 require the Customer to deliver up all Goods in its possession which have not been resold, or irrevocably incorporated into another product; and

6.5.2.2 if the Customer fails to do so promptly, enter any premises of the Customer or of any third party where the Goods are stored in order to recover them.

7. PRICE AND PAYMENT

7.1 The price of the Goods shall be the price set out in the Order; or, if no price is quoted, the price set out in the Product Portfolio as at the date of delivery.

7.2 Abacus may, by giving notice to the Customer at any time before delivery, increase the price of the Goods to reflect any increase in the cost of the Goods that is due to:

7.2.1 any factor beyond Abacus' control (including foreign exchange fluctuations, increases in taxes and duties, and increases in labour, materials and other manufacturing costs);

7.2.2 any request by the Customer to change the delivery date(s), quantities or types of Goods ordered, or the Specification; or

7.2.3 any delay caused by any instructions of the Customer or failure of the Customer to give Abacus adequate or accurate information or instructions.

7.3 The price of the Goods is exclusive of the costs and charges of packaging, transport of the Goods (which are set out in the Delivery Guide) and insurance, which shall be invoiced to the Customer.

7.4 The price of the Goods is exclusive of amounts in respect of VAT. The Customer shall, on receipt of a valid VAT invoice from Abacus, pay to Abacus such additional amounts in respect of VAT as are chargeable on the supply of the Goods.

7.5 Abacus may invoice the Customer for the Goods on or at any time after the completion of delivery.

7.6 Payment terms will be agreed in writing by Abacus and the Customer and confirmed in the written order acknowledgement. Abacus shall not be obliged to offer credit terms, and credit terms may be revoked at any time. Payment shall be made to a bank account nominated in writing by Abacus. Time of payment is of the essence.

7.7 If Abacus and the Customer agree any volume rebate or other discount, the Customer agrees that Abacus' calculations of such rebate or discount will be final and binding.

7.8 The Customer shall pay all amounts due under the Contract in full without any set-off, counterclaim, deduction or withholding (except for any deduction or withholding required by law). Abacus may at any time, without limiting any other rights or remedies it may have, set off any amount owing to it by the Customer against any amount payable by Abacus to the Customer.

8. INTELLECTUAL PROPERTY - OEM CUSTOMERS

8.1 All OEM Customers hereby grant Abacus a non-exclusive licence to use the OEM Branding and any other Intellectual Property Rights necessary to manufacture and supply the Goods in accordance with any Specification.

8.2 Abacus acknowledges and agrees that all rights in the OEM Branding and other relevant Intellectual Property Rights belonging to the OEM Customer shall remain in the OEM Customer.

9. SERVICES

9.1 If requested by the Customer and agreed in writing by Abacus, Abacus may supply the Services.

9.2 Abacus shall use all reasonable endeavours to meet any performance dates agreed between the parties, but any such dates shall be estimates only and time shall not be of the essence for performance of the Services.

9.3 Abacus shall have the right to make any changes to the services which are necessary to comply with any applicable law or safety requirement, or which do not materially affect the nature or quality of the Services, and Abacus shall notify the Customer in any such event.

9.4 Abacus warrants to the Customer that the Services will be provided using reasonable care and skill.

10. TERMINATION AND SUSPENSION

10.1 Abacus may terminate the Contract without liability immediately on giving notice to the Customer, if the Customer:

10.1.1 commits a material breach of its obligations under this Contract and (if such breach is remediable) fails to remedy that breach within a period of 30 days after receipt of written notice requiring it to do so;

10.1.2 commits a series of persistent minor breaches which, when taken together, amount to a material breach;

10.1.3 (being a natural person) is deemed either unable to pay its debts or as having no reasonable prospect of so doing, in either case, within the meaning of section 268 of the Insolvency Act 1986 or (being a partnership) has any partner to whom any of the foregoing apply;

10.1.4 (being a natural person) is declared bankrupt or makes any arrangement with or for the benefit of his creditors or has a county court administration order made against him under the County Court Act 1984;

10.1.5 enters into compulsory or members voluntary liquidation or passes a resolution for voluntary winding up or its directors convene a meeting of shareholders for that purpose (save for the purposes of solvent amalgamation or reconstruction where the amalgamated or reconstructed company agrees to adhere to this agreement);

10.1.6 has an administrative receiver or receiver appointed over all or any part of its assets or undertaking;

10.1.7 suspends, or threatens to suspend, payment of its debts, is unable to pay its debts as they fall due, admits inability to pay its debts or (being a partnership) has any partner to whom any of the foregoing apply or who is declared bankrupt;

10.1.8 is the subject of any judgment or order made against it or is the subject of any execution, distress, sequestration or other process levied upon or enforced against any of its assets;

10.1.9 has any action, step, legal proceedings or other procedure taken in respect of it by its directors, shareholders, bankers, creditors or any person seeking to appoint a liquidator or an administrator or takes any such act or step itself;

10.1.10 ceases or threatens to cease to carry on business; or

10.1.11 any event occurs, or proceeding is taken, with respect to the other party in any jurisdiction to which it is subject that has an effect equivalent or similar to any of the events mentioned in Condition 10.1.3 to Condition 10.1.9.

10.2 Without limiting its other rights or remedies, Abacus may suspend provision of the Goods under the Contract or any other contract between the Customer and Abacus if the Customer becomes subject to any of the events listed in condition 10.1.3 to condition 10.1.9, or Abacus reasonably believes that the Customer is about to become subject to any of them, or if the Customer fails to pay any amount due under this Contract on the due date for payment.

10.3 On termination of the Contract for any reason the Customer shall immediately pay to Abacus all of Abacus' outstanding unpaid invoices and interest.

10.4 Termination of the Contract, however arising, shall not affect any of the parties' rights, remedies, obligations and liabilities that have accrued as at termination.

10.5 Conditions which expressly or by implication survive termination of the Contract shall continue in full force and effect.

11. LIMITATION OF LIABILITY

11.1 Nothing in these Conditions shall limit or exclude Abacus' liability for:

11.1.1 death or personal injury caused by its negligence, or the negligence of its employees, agents or subcontractors (as applicable);

11.1.2 fraud or fraudulent misrepresentation; or

11.1.3 any matter in respect of which it would be unlawful for Abacus to exclude or restrict liability.

11.2 Subject to condition 11.1:

11.2.1 Abacus shall under no circumstances whatever be liable to the Customer, whether in contract, tort (including negligence), breach of statutory duty, or otherwise, for any loss of profit, or any indirect or consequential loss arising under or in connection with the Contract; and

11.2.2 Abacus' total liability to the Customer in respect of all other losses arising under or in connection with the Contract, whether in contract, tort (including negligence), breach of statutory duty, or otherwise, shall in no circumstances exceed the price of the Goods.

12. PRODUCT WITHDRAWAL/RECALL

12.1 Abacus shall notify the Customer as soon as practicable of any product withdrawal or recall relating to the Goods.

12.2 If Abacus decides to withdraw or recall any of the Goods, the Customer shall co-operate fully and promptly with any request by Abacus in respect of such withdrawal or recall.

12.3 Risk and title in the Goods shall pass to Abacus at the time the decision is made to withdraw or recall.

13. GENERAL

13.1 Abacus may assign the Contract or any part of it to any person, firm or company. Abacus shall use all reasonable endeavours to notify the Customer prior to making any such assignment. The Customer shall not be entitled to assign the Contract or any part of it without the prior written consent of Abacus and on such terms as Abacus shall reasonably specify.

13.2 Abacus maintains the right to employ any sub-contractor.

13.3 Notices under these Conditions shall be given in writing and may be given by delivery or first class post to the Customer at the address stated in the Order or as otherwise notified and to Abacus at the address stated in these Conditions or as other address notified. Notices sent by first class post shall be deemed to have been received within forty-eight hours of posting. Notices delivered by hand shall be deemed to have been received at the time of delivery.

13.4 No failure or delay by a party to exercise any right or remedy provided under this agreement or by law shall constitute a waiver of that or any other right or remedy.

13.5 If any court or competent authority finds that any provision of these Conditions (or part of any provision) is invalid, illegal or unenforceable, that provision or part-provision shall, to the extent required, be deemed to be deleted, and the validity and enforceability of the other provisions of these Conditions shall not be affected.

13.6 If any invalid, unenforceable or illegal provision of these Conditions would be valid, enforceable and legal if some part of it were deleted, the provision shall apply with the minimum modification necessary to make it legal, valid and enforceable.

13.7 Nothing in these Conditions is intended to, or shall be deemed to, constitute a partnership or joint venture of any kind between any of the parties, nor constitute any party the agent of another party for any purpose. No party shall have authority to act as agent for, or to bind, the other party in any way.

13.8 A person who is not a party to the Contract shall not have any rights under or in connection with it.

13.9 Except as set out in these Conditions, any variation, including the introduction of any additional terms and conditions, to the Contract, shall only be binding when agreed in writing and signed by Abacus.

13.10 The Contract shall be governed by, and construed in accordance with, English law, and the parties irrevocably submit to the exclusive jurisdiction of the English courts.

Abacus suggested bathroom design tips

1. Storage is important. Try to design storage into your bathroom. There are three main ways –
 - under the basin
 - in the shower area
 - within a pre-wall



2. Consider pre-wall bathroom design using wall-mounted sanitaryware. This gives a very clean and modern look. It is easier to clean and service than traditional close-coupled WCs and basins with pedestals.



3. Try to avoid placing the basin directly beneath a window, it is much better design practice (and more practical for the end-user) to site a mirror above a washbasin.



4. Carefully consider how you use lighting in the bathroom. Lights over basins are particularly important and the use of low-level LED 'night lights' can create a particularly pleasant ambience, ideal for night time use.



5. Don't try to overcrowd a bathroom. Carefully consider your requirements. Sometimes it may be better to have a large walk-in shower than trying to fit a separate shower cubicle and bath within a room. Remember, make your bathroom suit your lifestyle!



6. Consider the use of electric under-tile heating in your bathroom. This is very controllable in both winter and summer and offers a luxurious warm feeling underfoot as well as helping to control condensation and thereby enhancing the life of your bathroom.



7. And finally, most important of all...
...use Elements waterproof tile boards for walls and floors. These will insulate and waterproof your bathroom and make it last much longer than traditional building methods, protecting your investment for many years to come.

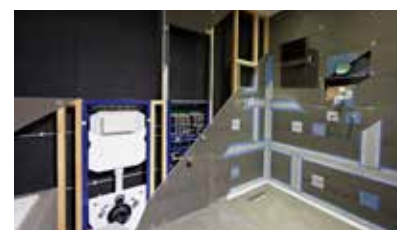

Design your bathroom

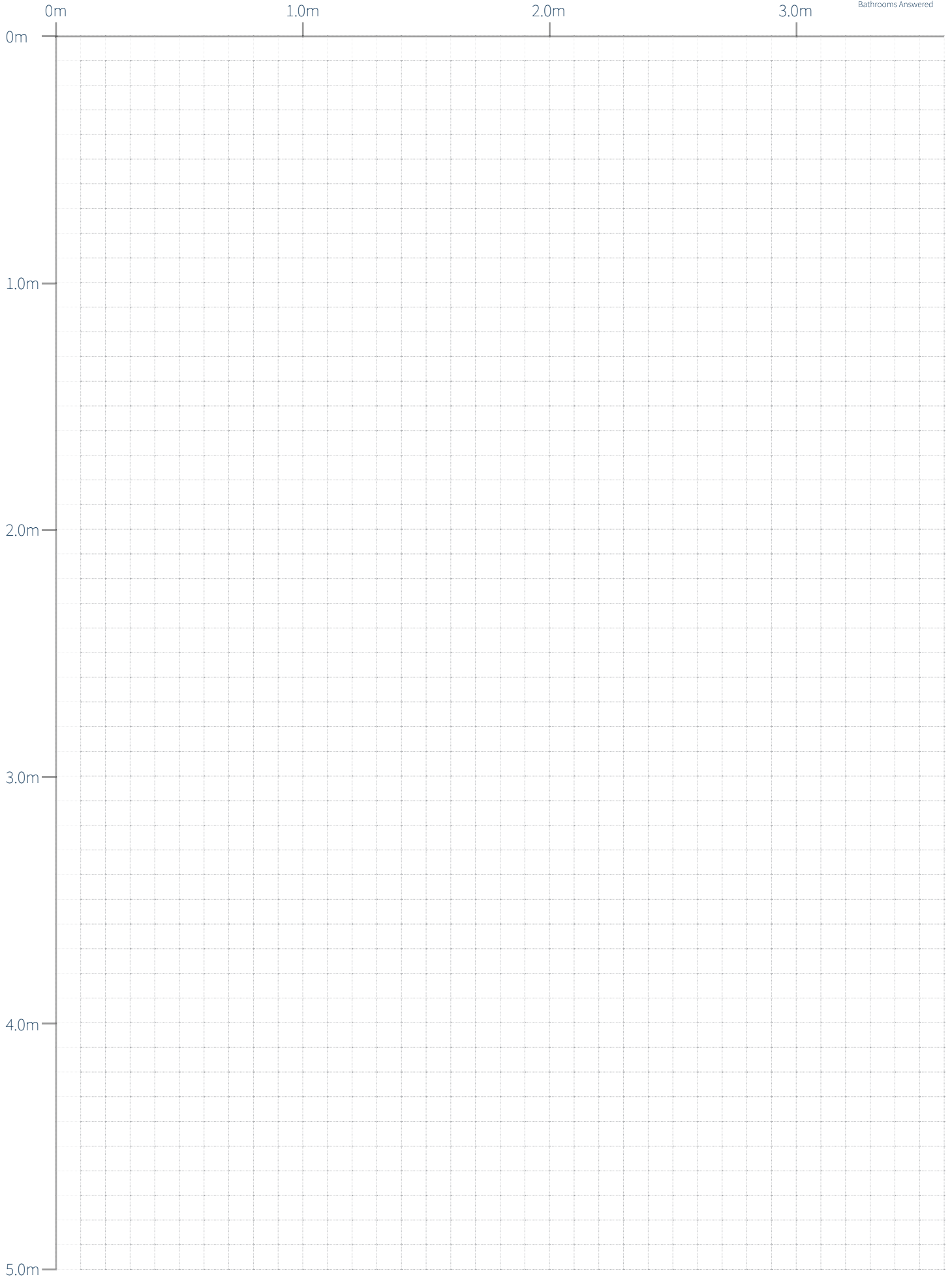



Tel: +44 (0) 345 850 50 40

Fax: +44 (0) 345 850 50 30

Sales:

sales@abacus-bathrooms.co.uk

General enquiries:

enquiries@abacus-bathrooms.co.uk

Abacus
Abacus House
Jubilee Court
Copgrove
Harrogate
HG3 3TB
UK

www.abacus-bathrooms.co.uk



MMBR-05-1705

Version 1.0

All information correct at time of going to print.
E&OE. Prices subject to change without prior notice.
Colours printed in this catalogue are as accurate as the
printing process allows and are for guidance only.

designed and produced by PridDesign
www.priddesign.co.uk