

A BFCMA GUIDE

C1/Sfb

(56-11)

(A3)

October 2007

A GUIDE TO CHOOSING AND USING FLUES AND CHIMNEYS FOR DOMESTIC SOLID FUEL AND WOOD BURNING APPLIANCES



This document has been produced by the BFCMA to provide advice and general guide lines on choosing and maintaining chimneys and flues for maximum performance, safety and durability. It is important to ensure that the chosen chimney and heating arrangements as a whole are suitable for the purpose intended and conform to the relevant regulations and standards.

The BFCMA is Britain's only Trade Association representing manufacturers and sole UK distributors of factory made chimney and flue products. It was established to promote the advantages of chimneys and encourage continued improvements in standards, efficiency and service.

Practically all the products manufactured by members of the British Flue and Chimney Manufacturers Association are suitable for solid fuel and wood burning appliances. Some products are specifically produced for solid fuel and wood burning equipment only. This leaflet is designed to act as a guide and to indicate which products may be specified and incorporated according to the appliances being used.

All members of the BFCMA offer a free information service on request.

The BFCMA also publish a similar document providing relevant guidance and useful information relating to chimneys for gas-fired appliances.

Published by the:-

BRITISH FLUE AND CHIMNEY MANUFACTURERS ASSOCIATION
2 Waltham Court, Milley Lane, Hare Hatch, Berks, RG10 9TH
Tel: 0118 940 3416 Fax: 0118 940 6258
Email: info@feta.co.uk Website: <http://www.feta.co.uk>

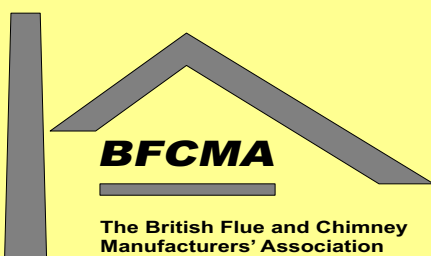

A GUIDE TO FLUES AND CHIMNEYS FOR SOLID FUEL AND WOOD BURNING APPLIANCES

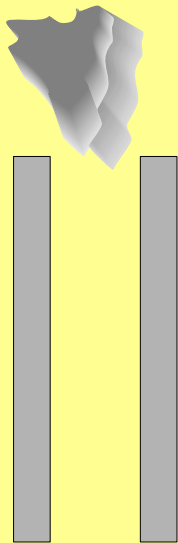

INTRODUCTION

The constructions and application of any chimney or flue serving solid fuel and wood burning equipment is covered by UK Building Regulations as well as European and British Standards. Whilst these differ in emphasis, they all mandate the safe application of the chimney no matter where and how used. These Regulations and Standards dictate the minimum criteria which it is necessary to apply if the chimney / flue is to function safely and correctly. Building control approval is necessary for building new chimneys and in some cases for relining old chimneys particularly if some alteration or change of the heating appliance occurs. The appropriate Regulations and Standards are listed later in this document.

An efficient chimney is a practical asset for any house. It allows the freedom to choose a wide range of heating systems from stoves, cookers to the warming enjoyment of a real open fire. A working chimney creates natural ventilation which helps to provide a healthy atmosphere and reduces the risk of condensation.

A chimney or rather the "flue" (which is the working part) operates on the principle of drawing the products of combustion (the fumes and gases created by the fuel burning process) from the appliance or fire and discharging them safely into the outside atmosphere. A successful "chimney draw" is dependant on maintaining hot flue gases of between 150°C and 500°C which creates an up draught. The correct sizing and installation of a well insulated flue together with the correct operation of the appliance are important factors to ensure a good draw.

A suitable and adequate air supply is also needed for the appliance of fire to operate safely and efficiently. To help understand more about chimneys they are a few terms that need to be mentioned. Examples of two common types of chimney and appliance arrangement are also shown.

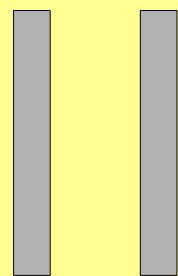
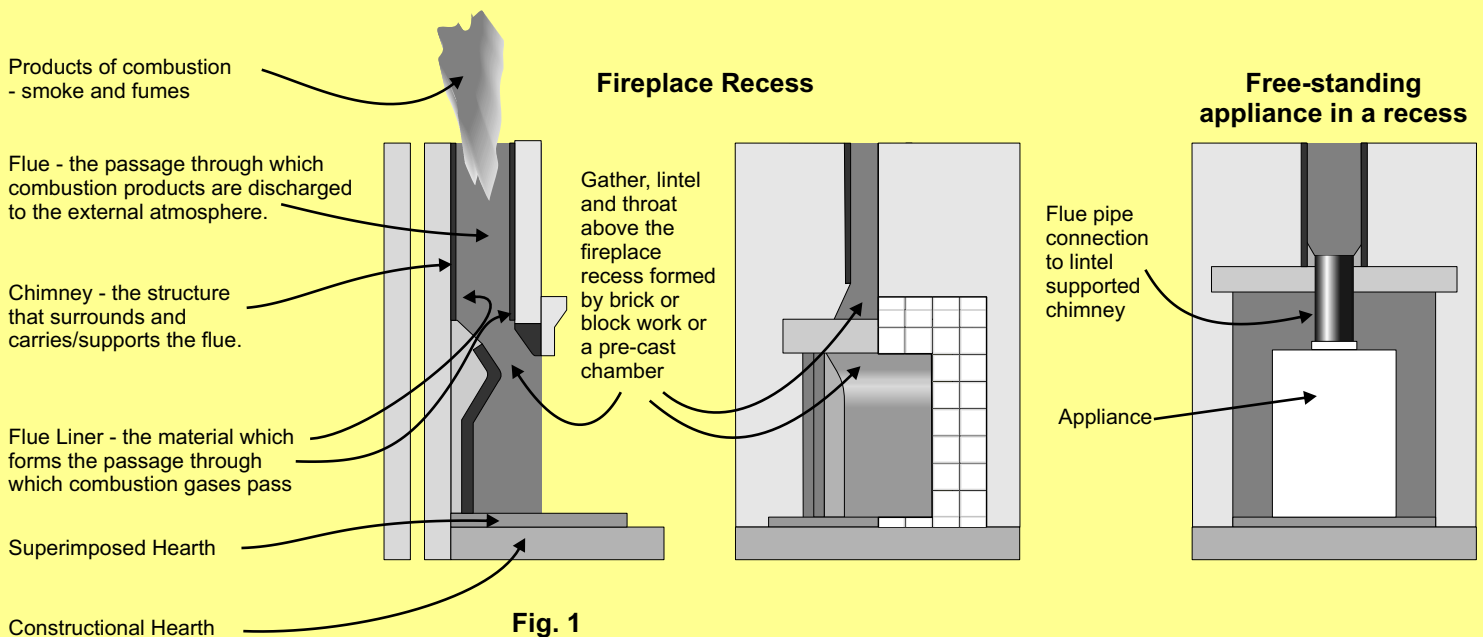

There is a wide choice of factory made chimney and flue products available from members of the BFCMA. These are listed in the separate BFCMA Directory, available on request. It is recommended that you get professional advice, together with the full product and installation details before committing yourself to a particular system. If you require a guarantee or warranty on a product be sure to get full printed details of what is covered and what the conditions are. Most manufacturers warranties are very specific on the use and maintenance requirements for their products.

Beware of any products that do not have independent proof of testing approvals and are not available with full installation and user instructions. Verbal warranties that are not backed up in writing with all the small print should be carefully checked to make sure you do in fact have the cover you think you are getting.

If you are thinking of using your chimney with a gas fired appliance or Decorative Fuel Effect gas fire that imitates a solid fuel burning open fire, there are different requirements that must be followed. A separate leaflet on chimneys and flues for gas fired appliances is published by the BFCMA. It is important to remember that by law the fitting, alteration and connection of all gas fires can only be done by a CORGI registered installer.

TYPES OF CHIMNEY AND FLUE SYSTEMS

The introduction of European Standard BS EN 1443: Chimneys - General Requirements, resulted in the categorising of chimneys and flues into three basic designations, defined as....

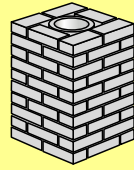

CUSTOM BUILT CHIMNEYS

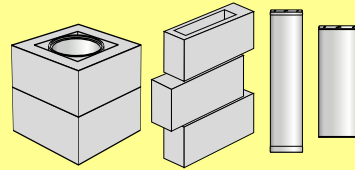
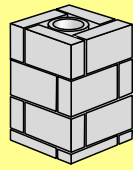

SYSTEM CHIMNEYS



CONNECTING FLUE PIPES

STAINLESS STEEL LINED PREFABRICATED CHIMNEYS



CERAMIC OR CONCRETE LINED PREFABRICATED CHIMNEYS



There are several basic chimney/flue systems that can be used with solid fuel and wood burning appliances.

Prefabricated metal chimney systems which consist of two concentric stainless steel metal walls with insulation filling the annular space between them. Some systems have a ceramic or refractory concrete liner, which can offer a longer life. Factory made in easy to handle sections and with a choice of fittings such as elbows, tees and terminals all of which simply lock together, they are easily assembled and supported with purpose designed brackets. These products can be used internally and externally, must be certified to BS EN 1856 and are designated **System Chimneys**.

There are also metal chimneys specifically designed for use with gas fired appliances, which **must not be used with solid fuel appliances**.

MASONRY CHIMNEYS

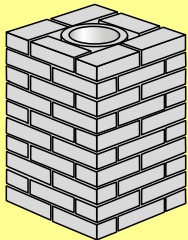

(a)

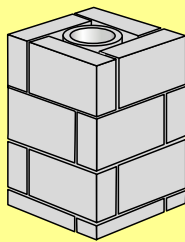

(b)

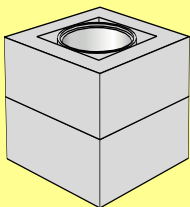

(c)

These can be divided into three categories:

a) Conventional brick or masonry construction with either clay/ceramic liners certified to BS EN 1457 or refractory concrete flue liners certified to BS EN 1857, are designated **Custom Built Chimneys**. To form a chimney, the liners have to be surrounded with at least 100mm thick brick, block or stonework with the gap in between filled with insulating concrete or lean mix mortar. In some cases, where used with solid fuel or wood burning appliances it will be necessary to utilise a stainless steel flexible liner in addition to the constructed liner. **NOTE** It is not permitted to substitute a ceramic or concrete liner with a steel liner of any description.

b) Prefabricated chimney block systems certified to BS EN 1858 comprise of an inner liner of concrete or clay/ceramic as specified above and an outer block of insulating concrete. Chimney blocks are designed to be used as a building unit and can normally accommodate a range of appliances. These are designated **System Chimneys**.

c) Gas Flue Blocks certified to BS EN 1858 are designated **System Chimneys** and comprise of rectangular clay or concrete blocks with an integral narrow rectangular flue way. They are of the same modular size as a masonry building block and are usually designed so that they bond into adjacent brick or block work. **This category of flue system should not under any circumstances be used with any solid fuel or wood burning appliances.**

Before using any existing chimney or re-fitting a solid fuel or wood burning appliance, it is vital to check that the chimney is safe, structurally sound and non-porous. Oversized, leaking or rough chimneys can be inefficient and dangerous. Blocked chimneys can kill!

Fig. 3

FLUE SIZING

To keep options open, it is recommended to have a minimum internal flue size of 185mm square or 200mm round, as this size is suitable for most solid fuel burning appliances and also gas fires.

These are the minimum sizes for a flue above a fireplace recess or for an open fire with an opening up to 500mm wide by 550mm high. For large open fires, such as inglenooks, dog grate installations or special appliances/ stoves designed to operate with a fire opening greater than 500mm x 550mm, the flue size should be between 14% and 16% of the free unobstructed area of the fire opening (including sides if open). For free-standing boilers, cookers or stoves that are not in a fireplace recess the minimum flue size is 150mm round or square, depending on the appliance manufacturers instructions.

The appliance manufacturers chimney sizing recommendations should always be followed. The flue size should never be less than the outlet size on the appliance. Many Decorative Fuel Effect gas fires (DFE's) that imitate a coal or log burning open fire require the same chimney arrangement as for solid fuel open fires and must be installed in accordance with British Standard BS5871 : Part3.

CHIMNEY POSITION

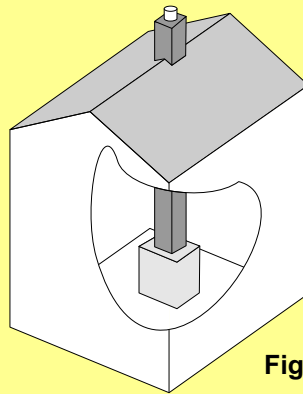

The ideal location for any chimney is inside the building so it can benefit from being kept warm. Chimneys situated outside the building can be affected by cold weather causing poor up-draught and condensation, particularly if they are un-insulated. It is therefore important that a cavity wall is continued around a lined masonry chimney or a factory made insulated chimney system is used for external applications.

BENDS IN THE CHIMNEY

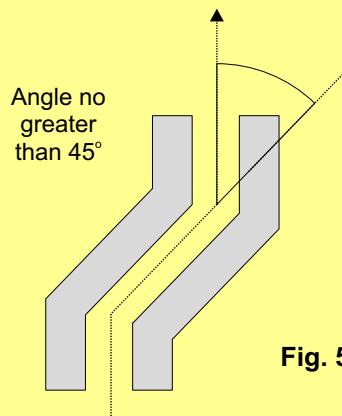

Regulations and Standards recommend that bends in the chimney are avoided, as a straight chimney gives better performance. If bends are absolutely necessary there must be no more than two in the length of the chimney (i.e. one offset). The angle of the bend should be no greater than 45° from the vertical. However, in some cases such as for chimney installations in flats it may be necessary to have more than two bends in each flue. In this situation advice must be sought from the manufacturer to ensure that the flue will create sufficient draw. Where System Chimneys are used, always use the standard offset components which are available from the chimney manufacturer. For metal chimneys to BS EN 1856, the distance between bends must be no greater than 20% of the total chimney length.

CONNECTION TO THE CHIMNEY

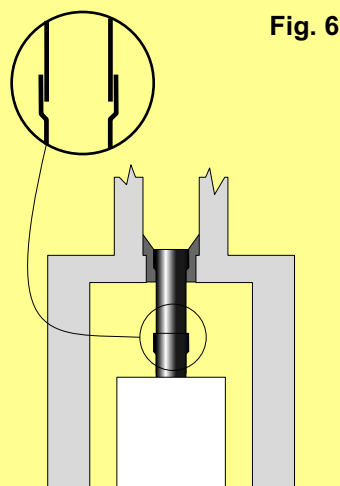

Room heaters, stoves, cookers and boilers must be connected to the chimney using correctly sized metal flue pipes which conforms to BS EN 1856, or alternative materials identified by Building Regulations such as Vitreous Enamelled flue pipe to BS 6999. The flue pipe must be suitably sealed with spigot end facing down (into the socket of the pipe below). As excessive bends and horizontal runs can accumulate soot with the risk of blockage, keep the flue pipe as vertical as possible and the angle of bends no more than 45° from the vertical. The maximum horizontal length of flue pipe allowed from the back of an appliance into any chimney is 150mm. Ensure all flue pipes are correctly installed and that there is easy access for cleaning the flue ways, particularly at any change of direction in the flue run.

CONNECTION TO THE CHIMNEY

(CONTINUED)

ACCESS FOR CHIMNEY CLEANING AND INSPECTION

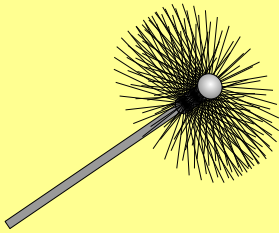
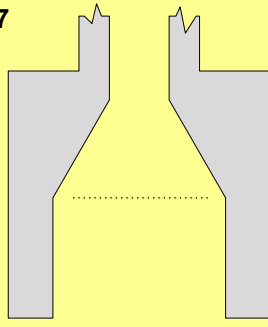
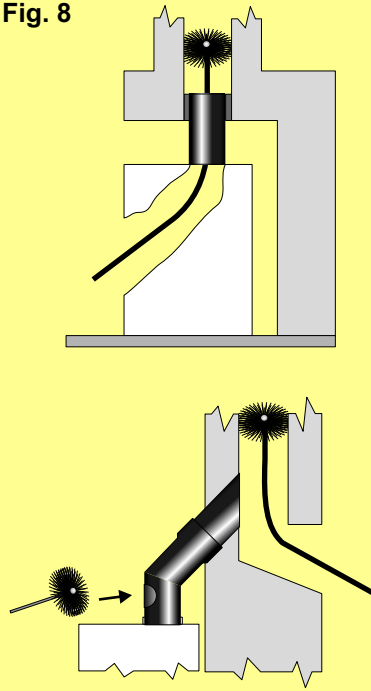

Fig. 7



For open fires a suitable throated front lintel and gather must be provided above the fire opening, so that the front, back and sides slope up smoothly into the flue opening in the chimney at an angle no greater than 30° from the vertical. Avoid flat surfaces or shelves which can cause turbulence and smoky fires. Most flue and chimney manufacturers provide standard gather and fireplace components, including precast fire chambers.

Fig. 8



Some appliances such as free-standing and inset open fires have built in gathers Building Regulations require that the flue inside the flue pipe and chimney are easily accessible for regular inspection and sweeping to prevent blockage. If this is not possible through the appliance or open fire, a purpose made access/sootdoor must be provided in the chimney. Most chimney manufacturers can provide components to suit. Where the appliance connection is made with a flue pipe going into the side of the chimney a space must be provided with sootdoor access below this point to collect debris such as soot that may fall down the chimney.

CHIMNEY POTS AND TERMINALS

To avoid any terminals interfering with draught, open ended chimney termination is always best for solid fuel appliances.

Fig. 9

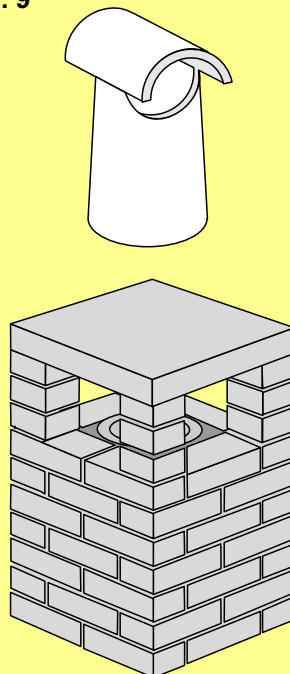

There are many types of chimney pots and terminals, in different styles and shapes to suit almost any taste and application. However, it is important to ensure the chosen pot or terminal does not restrict the exit of the products of combustion. The area of the outlet must therefore be the same as the flue area. All too often pots and terminals which have a reduced or tapered top are fitted, such as inserts, particularly the ½ round or hood insert, which are primarily designed for ventilating a chimney where the fireplace has been closed off.

If “down draught” is being experienced (i.e. smoke being blown back into the room) it is best to check that there is nothing wrong with the chimney arrangement, before resorting to a special terminal. In many cases, the problem may be due to factors such as lack of ventilation, poor throating above an open fire or insufficient chimney height. Most of the time these problems can be easily cured with the help of an expert and sometimes by raising the height of the chimney or the fitting of a taller pot. If you want to stop rain from dropping down the chimney there are various pots and terminals available. The T shaped clay pot shown on the left is an example and commonly used with solid fuel and gas open fires.

Another alternative for traditional masonry chimneys is to build a “Dovecote” type termination, where a slab is placed on 4 masonry piers above the flue. It is important to ensure all four sides are left open. The height and width of each opening must not be less than the maximum horizontal cross section of the flue.

CHIMNEY HEIGHTS AND TERMINATION

The minimum chimney height recommended for minimum performance of solid fuel appliances is 4.5 m from the top of the appliance to the top of the chimney. It is best to position the chimney, so that it goes straight up as near to the roof ridge as possible. Figure 10 shows the minimum flue discharge heights and positions for all solid fuel combustion applications. In some cases, particularly when chimneys are towards the bottom of a sloping roof or at the eaves, it may be necessary to increase the chimney height above these minimum mandatory requirements. The reason for this, is to clear pressure zones created by wind hitting the roof and nearby structures, trees etc. which may interfere with the updraught required by the appliance or fire.

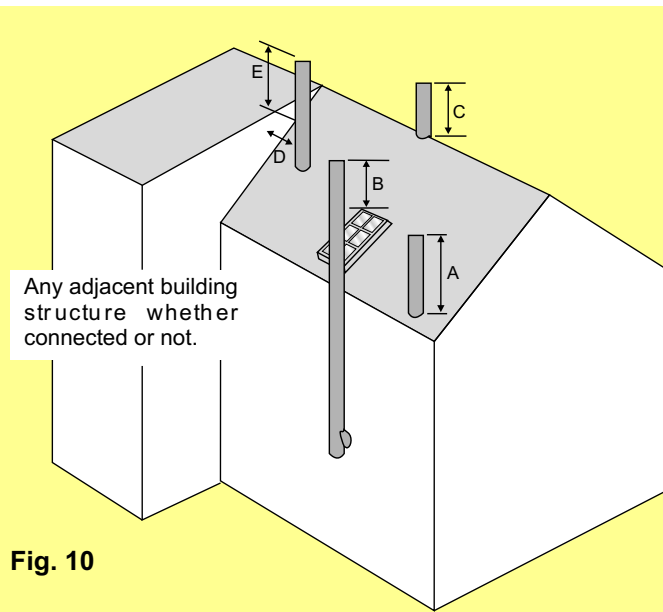

Fig. 10

The maximum free-standing stack height above the roof for a traditional masonry or block system chimney is $4\frac{1}{2}$ times the narrowest horizontal part of the chimney. This measurement is taken from the last point where the chimney stack passes the through or past the edge of the roof up to the chimney capping or termination.

Tall chimneys may need bracing, always consult the manufacturer for advice.

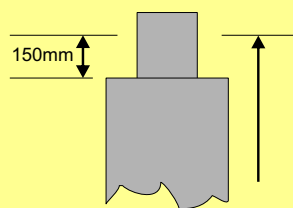

Fig. 11

Termination height relates to a point no greater than 150mm above the top of the insulated part of the chimney.

Dimension	Minimum distance measured from the top of the chimney construction, excluding any pot or terminal.
A	Not less than 1 metre from the highest part of the chimney's intersection with the roof.
B	1 metre above the top of any flat roof, and the top of any openable roof light, dormer window or ventilator, etc., if it is located within 2.3 metres.
C	Not less than 600 mm above the ridge if the pitch is less than 10° , otherwise not less than 1 metre
D/E	If D is less than 2.3 metres, E shall be not less than 600 mm.

BALANCED COMPARTMENT

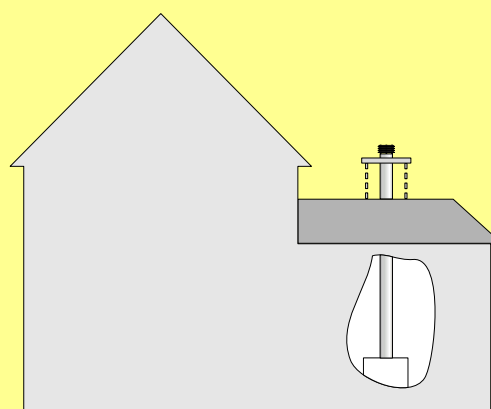
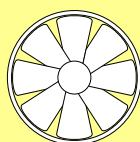

Fig. 12

Note: When a fan assisted solid fuel boiler is to be installed into a single storey boiler house and it is not possible to achieve the minimum freestanding chimney height, a vertical factory made chimney system operating on the balanced fluing principle may be used. However, the expert advice of the manufacturer must be sought. This system should not be used with solid fuel fired equipment which is not fan assisted.

FAN ASSISTED FLUE ARRANGEMENTS



The use of electrically powered fans to augment natural chimney draught is a subject that must be discussed with both the fan and heating appliance manufacturers who will normally provide technical advice to ensure safe operation. Where used with solid fuel appliances, the natural draught must still be able to continue to safely evacuate all the products of combustion, which will continue to be produced until the appliance is extinguished.

COMBUSTION AIR REQUIREMENT

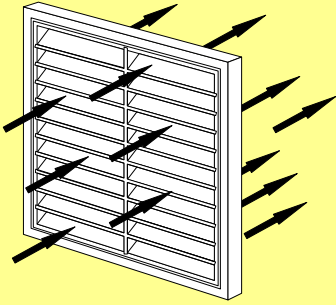

CHECKING AND RELINING EXISTING CHIMNEYS

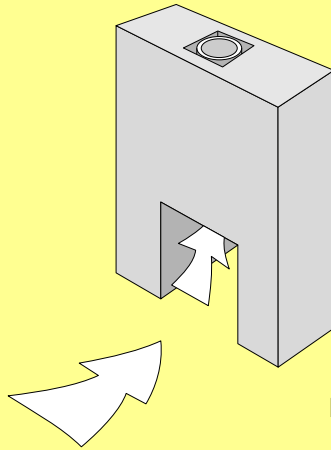
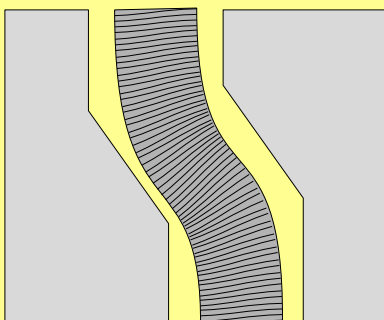
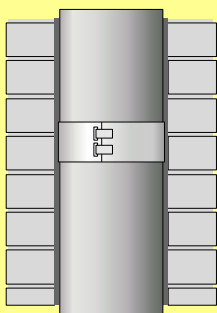
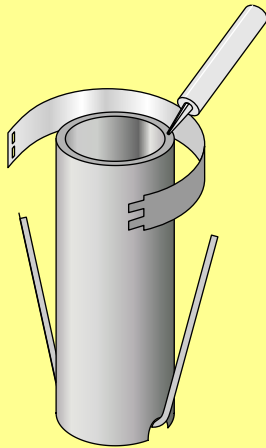

Fig. 13

All heating appliances and particularly open fires need air to work efficiently and safely. Ensure that the appropriate permanent air supply as required by the appliance manufacturer and Building Regulations is provided into the room where the appliance or fire is situated. As a guideline a permanent air vent with an opening or openings giving a total free area of at least 550mm^2 per kW of rated output above 5 kW must be provided for open fires. Generally the same size of ventilation is used for room heaters or stoves, but always refer to the appliance manufacturers recommendations and Building Regulations.

This is important as an inadequate supply of combustion air can create problems. Situations assumed to be “down draught” and spillage of smoke and fumes back into the room, which can be unpleasant and dangerous, are more frequently caused by insufficient provision of combustion air. Either the openings have not been provided, are not large enough or have been simply blocked off. If the appliance does not get all the air it needs to burn the fuel efficiently, incomplete combustion will occur resulting in the production of carbon monoxide and, if badly deprived of air, copious volumes of soot.

Old chimneys are often very in-efficient and particularly if unlined, can leak products of combustion and tars through the chimney walls. It is quite common to find that old chimneys are in a poor condition due to the flue surface and mortar joints being eaten away by corrosive condensates and soot deposits. The size of the flue may also be too large to suit the operating requirements of many modern heating appliances. It was only in 1965 that Building Regulations required that all new chimneys had to be built with suitable flue liners of the correct flue size to protect the chimney structure.

It is therefore very wise to have any old chimney you are using checked for its condition and particularly if you are planning to re-open an old chimney after many years of not being used. The check is best done by a chimney specialist and would start with the chimney being swept to make sure it is clear of obstructions such as dislodged masonry or bird's nests. A smoke test should then be carried out to establish whether there is any major fault that can cause products of combustion to leak through the chimney walls. A smoke test procedure is given later on in this guide. The general condition of the chimney in terms of structural stability should also be checked, as well as making sure it is wind and water tight.

Carrying out these checks should identify the repair work that is needed and more often than not, it is also necessary to have the chimney fitted with a new liner, which should improve both performance and safety. There are many factory made refining systems available and it is important to make sure that the correct flue size is fitted to suit the appliance or fire that will be used. Many of the same installation requirements as for new chimneys also apply.

Made from clay, ceramics or refractory concrete consisting of pumice or kiln burnt aggregate bonded with high alumina cement. These liners are simply lowered down the chimney on guide ropes with locating bands at the joints. The gap between the liners and chimney is then backfilled with an insulating lightweight concrete. Whilst this type of lining offers a long life, the existing flue opening has to be large enough for the liners to be installed. Pre-made bends are available with most systems.

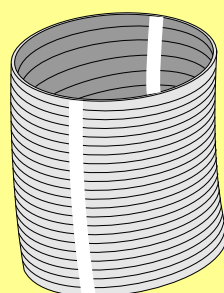

Not to be confused with single skin liners for gas only. These multifuel flexible liners are factory made from two overlapping strips of high grade stainless steel to give a smooth sealed flueway. They are simply lowered down or pulled up the chimney and can go around most bends. Whilst their slim profile enables quick installation into chimneys where other systems might not fit, their life can be reduced if abnormally high corrosive soot or condensate deposits are created and allowed to accumulate in the flue or have not been thoroughly removed from the walls of the existing chimney flue.

FUEL BURNING

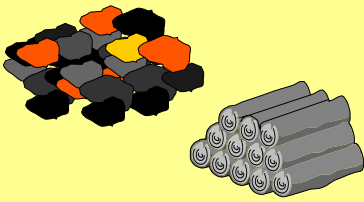
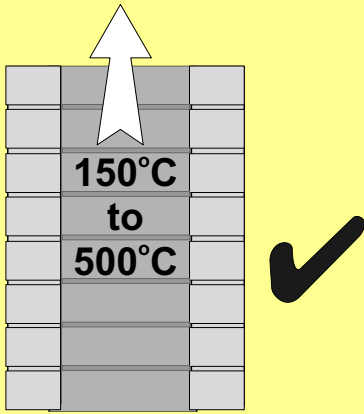

All chimneys operate on the principle of having a natural up draught created by maintaining warm flue gases of between 150°C to 500°C. It is therefore very important to use the appliance correctly and maintain a bright, warm fire so that under normal operating conditions the flue gas temperatures created are kept between 150°C and 500°C.

Burning solid fuel slowly with insufficient air supply, particularly on stoves or closed appliances must be avoided. Low flue gas temperatures will cause condensation and greatly increases the risk of producing excessive tar and corrosive soot deposits. This is a common problem, particularly when burning wet wood or coal and must be avoided. If soot and condensate deposits are allowed to accumulate in a flue, the deposits can ignite causing a chimney fire which is likely to cause damage to the chimney and appliance. These deposits can also be very corrosive and if they are not regularly removed can cause corrosion of metal parts of both the chimney and appliances.

Always use suitable solid fuels. There are some processed fuels such as "petrocok" which is derived from an oil processing by-product. It can cause spitting when being burned and also produce abnormally high temperatures together with very corrosive deposits. As it produces very little ash during the combustion process, the cast iron or steel bars of the appliance have no protection which is otherwise provided by the ash produced from solid fuel burning. Consequently the metal components are not protected and serious damage is inevitable. It is therefore recommended to get advice from an Approved Coal Merchants. Never burn household waste, plastics or chemicals which can produce harmful fumes and corrosive vapours, as this can be dangerous to health and cause premature corrosion of metals.

If wood is used as a fuel it is important to ensure that it is dry and well seasoned. This means timber that has been cut into logs, then split and stacked out in the open under a waterproof cover which is open on all sides to allow free flow of air for natural drying. Most timber needs one or two years drying Out depending on moisture content. Taking logs into the house a few days before burning will help to reduce the moisture content and improve performance.

REGULAR INSPECTION

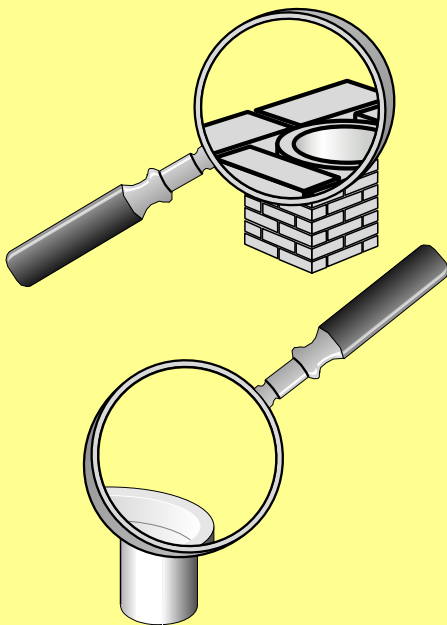

To start with all flueways should be checked monthly to assess the amount of deposits being created. The frequency of sweeping needed to prevent build up of deposits can then be determined. As a guide all flues should be swept before and during the heating season, and ideally at the end of the heating season to prevent tar and soot deposits having a corrosive effect on the chimney and appliance during the dormant period.

It is not recommended that the appliance is overfired, (allowed to burn fiercely and out of control), or chimney fires be started in an attempt to clean the chimney. Deposits of soot and tar will be greatly increased if unseasoned wood is burnt, which can lead to chimney fires. Should a chimney fire occur, it is advisable to have your chimney and appliance arrangement checked for damage before reusing the fire or heating appliance.

It is also good practise to check at least every year or two the exposed parts of a chimney, flashings and terminals for signs of damage. Just like the outside of a house chimneys can suffer from the wear and tear of extreme weathering.

If at any time smoke or fumes are apparent or suspected from the appliance, chimney or liner, seek advice immediately from the installer or fuel authority in case there is a blockage or failure. Do not use the fire appliance or chimney until they have been thoroughly checked for safety and soundness. The escape of fumes can be dangerous.

CHIMNEY CLEANING

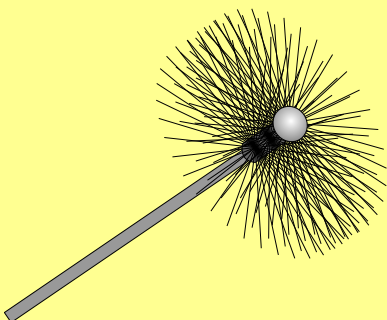

Mechanical sweeping with brush and rods is the only method of cleaning recommended because materials other than soot can block flueways i.e. pargeting in old flues, mortar, brickwork, birds nests etc. For this reason cleaning a flue using just chemical chimney cleaners or vacuum cleaning cannot be recommended as an alternative for correct chimney cleaning.

Sweeping brushes should be made from suitable bristle and be of the same diameter or area as the flueway being swept, and be fitted with a ball or free running wheelboss on the end to prevent scraping the flue walls, particularly at bends. Many chimney manufacturers give recommendations of brush types to suit their systems. Use a qualified chimney sweep or member of NACS (National Association of Chimney Sweeps) who provide an inspection and sweeping certificate.

SMOKE TESTING

If there is doubt about the condition of a chimney, or an old chimney is to be put in use after a long period of being un-used, it is advisable to have it smoke tested. The purpose of the smoke test is to discover if there are any major defects which can cause a leak of fumes through the chimney walls during normal operation. A smoke test should be carried out by a qualified person using the following procedure which is based on the test described in British Standard BS 6461 Part 1. There is a different procedure for smoke testing flues for gas fires. It is also recommended that this smoke test is carried out during the construction of traditional masonry chimneys and on completion of all chimney installations.

It must be remembered that the purpose of the smoke test is to identify and deal with any faults which would cause fumes to escape during the normal operation of the appliance and chimney. By closing the bottom and top of the chimney during the test, the smoke generated by the pellet together with normal barometric conditions will generate a positive pressure that would not be created during the normal use of the installation, which operates under negative pressure i.e. sucking in air and drawing the products of combustion up the flue.

The conditions created during the procedure is therefore more than capable of creating minor leakage of smoke from either joints in a traditionally masonry chimney, or connections between pre-fabricated metal chimneys and flue pipes.

Minor leakage detected during this test, would therefore not be a major risk when the installation is used during normal operating conditions, providing the point of leakage does not indicate a fault that could get worse. However, if significant or heavy smoke leakage is seen, the cause must be investigated and rectified. Broken components, incorrect fitting and incomplete jointing of flue liners are the most common problems which cause major leakage and require remedial action.

1 If there is an appliance fitted at the base of the bottom of the chimney, burn some newspaper in the fire/grate for 2 to 3 minutes to establish a flue draw. A longer warming up time may be needed with wet or cold flues. If there is no grate or fire box fitted use a blow lamp for 10 minutes or more to establish a flue draw. It should be realised that neither of these methods create the same temperatures or volume of hot gases that would normally be created whilst the appliance is in use. They therefore are intended to assist the testing and not simulate real conditions.

2. Place two* flue testing smoke pellets on a brick or similar in the opening at the base of the flue or in the appliance if it is fitted. Follow the pellet manufacturers safety instructions.

3. Ignite the pellets and when it starts smoking seal the opening with a board or plate sealed at the edges or if an appliance is fitted, close all doors, ashpit cover and vents.

4. When smoke begins rising out of the top of the chimney, seal the top of the flue, terminal or pot. (i.e. use an inflated football bladder or plastic bag sealed in position with tape). It is now a requirement that when smoke testing a flue over a solid fuel appliance chimney, a hole of minimum 50mm diameter must be left in the capping or sealing device.

5. Examine the full length of the chimney for any leakage of smoke. If possible check for signs of smoke leakage from wall cavities at the sides and back of the chimney, if it is built into a wall. Also check for smoke leakage at openings around windows near to the chimney and the roof space area.

6. If any smoke is seen establish the point of leakage and carry out remedial work to correct any faults.

7. After completing the remedial work repeat the testing procedure until no major leakage or fault is apparent. Remove the closures at the top and bottom of the chimney.

* It should be noted that the number of smoke pellets used will be determined by circumstances and the size of the pellets used. Generally, the larger the flue diameters the lesser the number of pellets required because of the ratio of flue diameter compared to the surface area of the flue.

CHIMNEY, FLUE AND APPLIANCE ON SITE IDENTIFICATION (Notice Plate)

Where any of the chimney or flue products and/or a combustion appliance, (irrespective of fuel burned), is installed or renovated, it is a Mandatory Requirement that a Notice Plate is provided which identifies the appropriate equipment on site. It must be located in a convenient and accessible location, eg., near a services meter. Completion of the data required on the Notice Plate can be by the heating appliance installer, builder, chimney supplier/installer or other competent person. This is an example of the Notice Plate as defined in Building Regulation Approved Document J.

IMPORTANT SAFETY INFORMATION	
This label must not be removed or covered	
Property address	20 Main Street new Town
The hearth and chimney installed in the	Lounge
are suitable for	decorative fuel effect gas fire
Chimney liner	Double skin stainless steel flexible 200 diameter
Suitable for condensing appliance	no
Installed on	date
Other information (optional)	Designation of stainless steel liner stated by manufacturer to be T540 N2 S D 3
e.g. installers name, product trade names installation and maintenance advice, European chimney product designations, warnings on performance limitations of imitation elements e.g. false hearths	

Fig. 14

BUILDING REGULATIONS & STANDARD REFERENCES

Building Regulations appropriate to the UK are:-

England & Wales.

The Building Regulations Approved Document J

Scotland

Building Regulations Technical Standards Section 3

Northern Ireland

Building Regulations Northern Ireland Technical Booklet L

Copies of these Building Regulations can be obtained from the Stationery Office. Advice is also available from Local Authority Building Control Departments.

OTHER USEFUL CONTACTS

HETAS

Orchard Business Centre, Stoke Orchard, Gloucestershire. GL52 7RZ
Tel: 0845 634 5626

HETAS produce an annual Guide for Approved Solid Fuel Products and Services, which includes a comprehensive list of chimney and flue systems available from members of the BFCMA.

NACS

National Association of Chimney Sweeps

Unit 15, Emerald Way,
Stone Business Park Stone,
Staffordshire ST15 0SR
Tel: 01785 811732

NACS provide a list of their members throughout the UK.

NFA

National Fireplace Association

PO Box 583, High Wycombe. HP15 6XT
Tel: 0845 643 1901

The NFA publish a series of guides on fireplaces and associated work including chimneys.

European and British Standards which relate to Flues and Chimneys

All of the standards referenced below are either directly applicable to chimneys and flues, or contain relevant content and are correct at the time of publication of this document.

As many of the standards relate to flue and chimneys for all fuels, for convenience and information, every relevant standard for all residential fuel types has been listed. Any Standards which are NOT pertinent to solid fuel fired appliances have been *italicised*.

<i>BS EN 483:2000</i>	<i>Gas-fired central heating boilers. Type C boilers of nominal heat input not exceeding 70 kW. Replaced BS 5258: Pt 1; 1986</i>
<i>BS EN 509:2000</i>	<i>Decorative fuel-effect gas appliances. Replaced BS 5258: Pt 12; 1990.</i>
<i>BS 715: 2005</i>	<i>Specification for metal flue boxes for gas-fired appliances not exceeding 20kW.</i>
<i>BS 1251: 1987</i>	<i>Specification for open fireplace components.</i>
<i>BS EN 1443: 2003</i>	<i>Chimneys – general requirements</i>
<i>BS EN 1457: 1999</i>	<i>Chimneys, Clay/Ceramic flue liners. Requirements and test methods. Replaced BS 1181: 1989</i>
<i>BS EN 1806: 2006</i>	<i>Chimneys Clay/ceramic flue blocks for single wall chimneys. Requirements and test methods</i>
<i>BS EN 1856 - 1: 2003</i>	<i>Chimneys. Requirements for metal chimneys. System chimney products. Replaced BS 4543: Pts 2 and 3 & BS 715: 1993</i>
<i>BS EN 1856 - 2: 2004</i>	<i>Chimneys. Requirements for metal chimneys. Metal liners and connecting metal flue pipes Replaced BS 715: 1993</i>
<i>BS EN 1857: 2003</i>	<i>Chimneys - Components. Concrete flue liners. Replaced BS 7435: Pts 1-2</i>
<i>BS EN 1858: 2003</i>	<i>Chimneys, Components, Concrete flue blocks. Replaced BS 1289: Pt 1</i>
<i>BS EN 1859: 2000</i>	<i>Chimneys. Metal chimneys. Test methods. Replaced BS 4543: Pt 1:1990</i>
<i>BS 5871: 2005</i>	<i>Specification for installation of gas fires, convector heaters, fire/back boilers and decorative fuel effect gas appliances</i>
	<i>Pt 1: Gas fires, convector heaters and fire/back boilers.</i>
	<i>Pt 2: Inset live fuel effect gas fires of heat input not exceeding 15kW.</i>
	<i>Pt 3: Decorative fuel effect gas appliances of heat input not exceeding 15kW.</i>
<i>BS 5440: 2000</i>	<i>Installation of flues and ventilation for gas appliances of rated input not exceeding 70 kW.</i>
	<i>Pt 1: 1990 Specification for installation of flues.</i>
	<i>Pt 2: 1989 Specification for installation of ventilation for gas appliances.</i>
<i>BS 6461-1:1984</i>	<i>Installation of chimneys and flues for domestic appliances burning solid fuel (including wood and peat). Code of practice for masonry chimneys and flue pipes</i>
<i>BS 6999:1989</i>	<i>Specification for vitreous-enamelled low carbon steel flue pipes</i>
<i>BS 7977-1:2002</i>	<i>Specification for safety and rational use of energy of domestic gas appliances. Radiant/convectors Replaced BS 5258: Pts 5 and 16</i>
<i>BS 7977-2:2003</i>	<i>Specification for safety and rational use of energy of domestic gas appliances. Combined appliances. Gas fire/back boiler. Replaced BS 5258: Part B</i>
<i>BS EN 12391-1: 2003</i>	<i>Chimneys. Execution Standard for metal chimneys. Chimneys for non-room-sealed appliances.</i>
<i>BS EN 12446 : 2003</i>	<i>Chimneys. Components. Concrete outer wall elements</i>
<i>BS EN 13063-1: 2005</i>	<i>Chimneys. System chimneys with clay/ceramic flue liners. Requirements and test methods for sootfire resistance</i>
<i>BS EN 13063-2: 2005</i>	<i>Chimneys. System chimneys with clay/ceramic flue liners. Requirements and test methods under wet conditions</i>
<i>BS EN 13069: 2005</i>	<i>Chimneys. Clay/ceramic outer walls for system chimneys. Requirements and test methods</i>
<i>BS EN 13216 : 2004</i>	<i>Chimneys. Test methods for system chimneys. Replaced BS 4543</i>
<i>BS EN 13502 : 2002</i>	<i>Chimneys. Requirements and test methods for clay/ceramic flue terminals. Replaced BS 1181:1999.</i>

Copies of European and British Standards can be obtained from:

British Standards Institution, 389 Chiswick High Road, Chiswick, London. W4 4AL.
Tel: 0208 9969000

SOME DO'S AND DON'T'S

DO ...

DO ensure that when an appliance is fitted to an existing chimney system that it is inspected and tested for soundness and any defects are rectified.

DO ensure that chimney or flue system is always installed and supported and that all joints are properly, securely and efficiently made strictly in accordance with the manufacturers instructions.

DO ensure that the flue pipe connection from the appliance rises vertically for at least 600 mm (24") before any change of direction is contemplated. The reason for this is that the flue draught is crucial nearer the appliance because of the higher flue gas temperature. Any horizontal or angled runs at the bottom of the flue will create severe restriction to gas movement and affect appliance operation.

DO try to construct the chimney vertically all the way to the terminal that where bends are necessary, no part of the flue is installed at an angle more than 45° from the vertical.

DO ensure that the flue diameter is not less than the diameter of the appliance outlet.

DO ensure that the effective height of any chimney with bends (vertical distance between appliance and terminal) is at least twice the horizontal distance between the appliance and terminal.

DO try to position the chimney inside the building to avoid excessive cooling and risk of condensation.

DO ensure that the chimney is installed and located in accordance with Building Regulations and British Standards, particularly where distinct distances from combustible materials are required.

DO ensure that the chimney is thoroughly inspected, and that smoke tests are carried out before the appliance is used.

DO remind the householder that a chimney and appliance must breathe which is why a permanent supply of combustion air must be provided and kept clear from obstruction.

DO advise the householder to have the appliance regularly checked and the flues expertly swept.

DO ensure that the installation is carried out by a HETAS registered installer.

DON'T ...

DON'T use any single wall flue system as a chimney.

DON'T allow clothes, furnishings or any combustible materials to come into contact with the surface of any flue pipe or prefabricated metal chimney.

DON'T use bends if they can be avoided.

DON'T run horizontal flue anywhere in the system other than a maximum 150mm horizontal length into the chimney from a back outlet appliance.

DON'T position the chimney externally if it can be avoided.

DON'T be tempted to use non BS EN certificated flue and chimney systems; they may only last for a short time and will have to be replaced by the correct product. It will then be at least twice as expensive in the long run. Use of non-approved products is also illegal.

