



Articulated Trucks TA25 TA27 TA30 NEW TA35 NEW TA40

BUILDING ON
TECHNOLOGY





Building on technology

Terex has grown to become one of the most influential companies within the Construction industry.

Terex has invested in research and development, engineering, rigorous testing and training plus state-of-the-art manufacturing processes to develop a portfolio of new Construction products. By building on technology and pioneering innovation, Terex has developed a Construction range that consistently exceeds the customers' expectations by providing world class **reliability, durability, safety and productivity.**

- **Construction**

- Off Highway Rigid and Artic Trucks
- Crawler and Mobile Excavators
- Mini/Midi Excavators
- Material Handlers
- Railroad Excavators
- Wheel Loaders
- Backhoe Loaders
- Hydraulic Hammers
- Telescopic Handlers
- Pumps
- Mixers and Light Construction Equipment
- Site Dumpers
- Rollers and Compaction Equipment
- Motor Graders
- Scrapers

- **Aerial Work Platforms**

- **Cranes**

- **Roadbuilding and Utility**

- **Mining and Material Processing**



BUILDING ON TECHNOLOGY



Terex is committed to manufacturing high quality, reliable, construction products for diverse applications including roadbuilding, quarrying and mining to optimise your productivity and profitability.

With more than 60 years experience and a powerful global distribution network, Terex undertakes all research, development, manufacturing and marketing of its off-highway trucks and scrapers from its Scottish factory.

Terex's range of class-leading, rough terrain articulated trucks have the ability to go where others can't follow. This articulated range work on sites ranging from sand and gravel quarries to underground coal mines and major road construction projects. The Terex articulated trucks offer high productivity at low cost. With a payload choice of 25 to 42 tons (23 to 38 tonnes) each machine in the range delivers effective performance and low maintenance requirements.

Building on technology

LATEST IN ENGINE TECHNOLOGY

- TA25, TA27 and TA30 feature the well-proven QSM11 tier 3 engine which provides the TA25 with a gross power of 224kW (300hp), TA27 with 270kW (365hp) and the TA30 with 287kW (385hp) giving high power for exceptional performance.
- TA35 and TA40 are powered by the Detroit Diesel Series 60, 14 litre engine with the latest DDEC V electronic management system meeting Tier 3 engine emissions.
- These engines are tuned to produce high torque levels, resulting in excellent acceleration and the ability to operate in the most arduous of conditions.



TRANSMISSIONS WITH THE LATEST TECHNOLOGY IN ELECTRONICS

TA25, TA27 and TA30

- Smooth-shifting transmissions with integral torque converter and six forward and three reverse gears
- Fully automatic transmission with a manual over-ride function
- The TA25, TA27 and TA30 models have engine retarder as standard.

TA35 and TA40

- Fitted with the Allison HD4560 transmission with integral retarder, mounted directly to the engine
- Fully automatic transmissions with planetary gearing, electronic control with six forward and one reverse gear
- Fitted with a remote mounted 2 speed transfer gearbox taking drive from the transmission to the front and rear axles



Building on technology

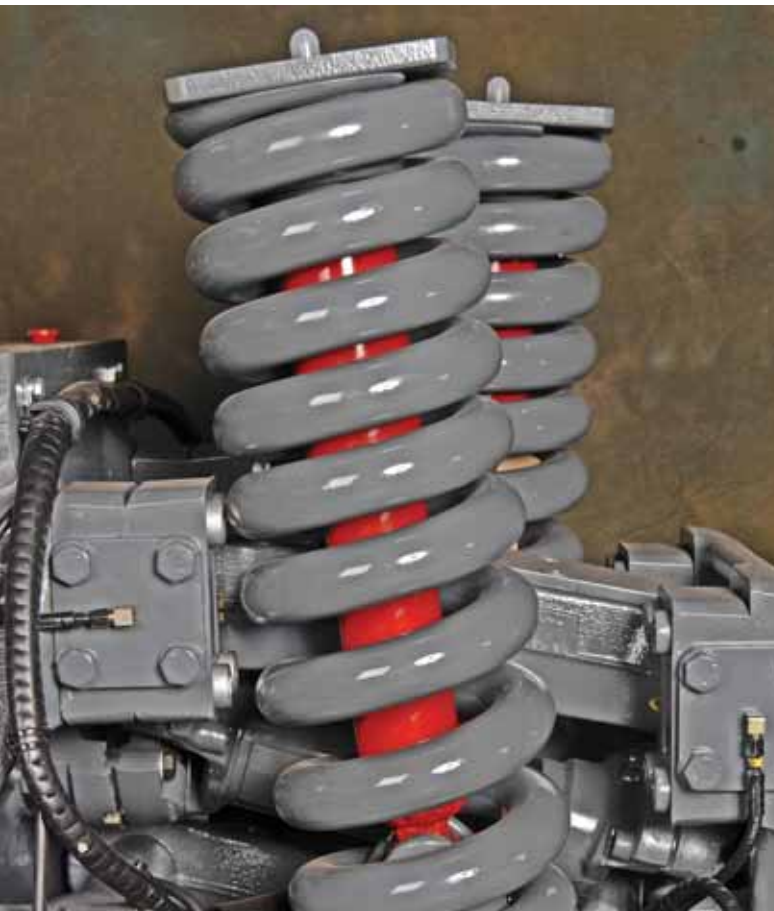

BRAKING POWER

- Robust and reliable full power hydraulic actuation reduces regular servicing requirements and eliminates the daily maintenance required with compressed air systems
- Secondary brake control actuates service and parking brakes
- Stopping power - Multi disc sealed and oil cooled brakes on all three axles

SUSPENSION

- Now available - on TA25, TA27 and TA30, full independent suspension, excellent operator comfort, increased production and faster haul speeds



HIGH CAPACITY BODY DESIGN

- Extra tonnage per payload
- Rugged flat plate design made from impact resistant high strength steel
- The high hinge point, dual slope tailchute and tapered sides ensure controlled release of the load
- Pivot area protected from material spills due to spill guard
- Fast dump cycle due to high oil flow and pressure within the advanced hydraulic system



PRODUCT OVERVIEW

- High powered, heavy-duty trucks with powerful engines providing class leading performance and ability to go where others can't follow
- Heavy duty transmissions have built-in reserve for long life and reliability
- Heavy duty, large diameter drivelines are maintenance free, providing strength and longevity
- Featured on the Generation 7 articulated trucks is the ability to TILT the cab, giving unrestricted access for inspection and maintenance. Ensuring maximum production and minimum down time.

- Stopping power – Oil immersed multi discs on all axles
- High capacity body – maximum payload (ranging from 23t to 38t (25 to 42 US Ton)) means optimum productivity and lowest cost per tonne



TA25, TA27 & TA30

Benefits

- Optimum clearance with the body raised, when dumping at hoppers and stock piles
- Better performance and handling in harsh conditions due to high torque output
- Faster cycle times and improved hill climbing ability given by the increased horsepower output
- Large capacity body provides a lower cost per tonne, thus more profit for the customer
- Higher power to weight ratio provides a faster cycle time even in arduous conditions and steep gradients

TA35 & TA40

Benefits

- High torque and horse-power output provides better performance in the harshest of conditions
- High capacity engines - world class Detroit Diesel engines give outstanding performance, reliability and durability
- Both trucks are fitted with a 14.0 litre engine with overhaul intervals between 15,000 and 20,000 hours
- Excellent braking thanks to the oil cooled multi disc pack on all axles, thus ensuring efficient braking



Building on technology

TA25 TA27 TA30 TA35 TA40



- High power, high torque, emission-certified engine for maximum performance
- Engines certified to Tier/Stage 3 emissions
- Refined, quiet cab for greater operator comfort
- Multiplate oil immersed brakes on all axles
- 500 hour service intervals
- Hydraulically actuated multiplate transverse diff-lock differentials for 100% cross axle lock up.
TA25, TA27, TA30
- Fully CAN enabled
- Full independent suspension as an option - TA25, TA27, TA30

	TA25	TA27	TA30	TA35	TA40
Maximum Payload	23 tonne (25 US ton)	25 tonne (27.5 US ton)	28 tonne (30.9 US ton)	34 tonne (37.5 US ton)	38 tonne (41.88 US ton)
Heaped Capacity	13.5 m ³ (17.7 yd ³)	15.5 m ³ (20.3 yd ³)	17.5 m ³ (22.9 yd ³)	21.0 m ³ (27.5 yd ³)	23.3 m ³ (30.3 yd ³)
Gross Power	224 kW (300 hp)	272 kW (365 hp)	287 kW (385 hp)	298 kW (400 hp)	336 kW (450 hp)
PLI	A920 MAY 07	A889 MAY 06	A894 MAY 06	A917 MAY 07	A865 MAY 06

Generation 7 articulated trucks



Engines

	TA25	TA27
Engine	Cummins QSM11	Cummins QSM11
Type	Four cycle, emission certified, direct injection diesel, 6 cylinder, in line, water-cooled, turbocharged with air to air charge cooling.	
Piston Displacement - litres	10.8	10.8
Bore x Stroke - mm (in)	125 x 147 (4.92 x 5.79)	125 x 147 (4.92 x 5.79)
Gross Power - kW (hp) @ rpm	224 (300) @ 1800	272 (365) @ 1800
Rated Power - kW (hp) @ rpm	224 (300) @ 2100	250 (335) @ 2100
Net Power - kW (hp) @ rpm	221 (296) @ 2100	238 (319) @ 2100
Maximum Torque - Nm (lbf ft) @ rpm	1 424 (1 050) @ 1400	1 673 (1 234) @ 1400
Gross Power rated	SAE J1995 Jun 90	SAE J1995 Jun 90
Engine emissions	Meets USA EPA Tier 3 / CARB MOH 40 CFR 89 Tier 3 and proposed EUNRMM (non-road mobile machinery directive) stage 3	
Electrical	24 volt electric start. 70A alternator. Two 12 volt 170 Ah batteries.	
Air cleaner	Dry-type air cleaner with safety element, automatic dust ejector and restriction indicator.	
Fan	Modulating fan reduces noise level and consumes engine power as required.	
Altitude - Electronic derate @m (ft)	3 048 (10 000)	3 048 (10 000)



Transmission

	ZF 6WG 260 Fully automatic with manual over-ride.	ZF 6WG 260 RPC Fully automatic with manual over-ride.			
Assembly	Consists of a torque converter close-coupled to a countershaft type gearbox with integral output transfer gearing. Automatic shifting throughout the range, with kick-down feature. Lockup in all forward gears. A torque-proportioning output differential transmits drive permanently to front and rear axles. This differential may be locked by the driver for use in difficult traction conditions.				
	Forward	Reverse	Forward	Reverse	
	Gear				
Speeds - km/h (mph)	1	5.5 (3.4)	5.5 (3.4)	5.5 (3.4)	5.5 (3.4)
	2	8.6 (5.4)	13.4 (8.4)	8.6 (5.4)	13.4 (8.4)
	3	13.4 (8.4)	30.7 (19.0)	13.4 (8.4)	30.7 (19.0)
	4	20.8 (12.9)		20.8 (12.9)	
	5	30.7 (19.0)		30.7 (19.0)	
	6	50.4 (31.3)		50.4 (31.3)	

TA30	TA35	TA40
Cummins QSM11	Detroit Diesel Series 60	Detroit Diesel Series 60
6 cylinder, in-line, four cycle, water cooled, turbocharged with air to air charge cooling, direct injection, electronic engine management.		
10.8	14.0 (855)	14 (855)
125 x 147 (4.92 x 5.79)	133 x 168 (5.24 x 6.61)	133 x 168 (5.24 x 6.61)
287 (385) @ 1800	298 (400) @ 2 100	336 (450) @ 2 100
261 (350) @ 2100		
248 (333) @ 2100	289 (388) @ 2 100	326 (437) @ 2 100
1 775 (1 309) @ 1400	2 000 (1 475) @ 1 200	2 100 (1 548) @ 1 350
SAE J1995 Jun 90	SAE J1995 Jun 90	SAE J1995 Jun 90
Meets USA EPA Tier 3 /CARB MOH 40 CFR 89 Tier 3 and proposed EUNRMM (non-road mobile machinery directive) stage 3.		
24 volt electric start. 70A alternator. Two 12 volt 170 Ah batteries.	24 volt electric start. 100A alternator. Two 12 volt 175 Ah batteries.	
Dry-type air cleaner with safety element, automatic dust ejector and restriction indicator.		
Modulating fan reduces noise level and consumes engine power as required. Note: Net hp with fan clutch disengaged		
3 048 (10 000)	3 048 (10 000)	3 048 (10 000)

ZF 6WG 310 RPC Fully automatic with manual over-ride.	Allison HD4560 with integral retarder mounted directly to the engine, fully automatic transmission with planetary gearing, electronic control with six forward and one reverse gear.								
Consists of a torque converter close-coupled to a countershaft type gearbox with integral output transfer gearing. Automatic shifting throughout the range, with kick-down feature. Lockup in all forward gears. A torque-proportioning output differential transmits drive permanently to front and rear axles. This differential may be locked by the driver for use in difficult traction conditions.	Remote mounted 2 speed transfer gearbox taking drive from the transmission and feeding it via a lockable differential to front and rear wheels.								
Forward	Reverse	Forward	Reverse	Forward	Reverse				
5.5 (3.4)	5.5 (3.4)	5.2 (3.2)	4.6 (2.9)	7.9 (4.9)	7.0 (4.3)	5.5 (3.4)	4.8 (3.0)	8.4 (5.2)	7.4 (4.6)
8.6 (5.4)	13.4 (8.4)	11.0 (6.8)		16.8 (10.4)		11.7 (7.3)		17.8 (11.0)	
13.4 (8.4)	30.7 (19.0)	15.9 (9.9)		24.3 (15.1)		16.9 (10.5)		25.8 (16.0)	
20.8 (12.9)		24.3 (15.1)		37.1 (23.1)		25.8 (16.0)		39.5 (24.5)	
30.7 (19.0)		31.0 (19.3)		47.7 (29.6)		33.0 (20.5)		50.4 (31.3)	
50.4 (31.3)		35.2 (21.9)		53.9 (33.5)		37.5 (23.3)		60.0 (37.3)	

Generation 7 articulated trucks



Steering

	TA25	TA27
Steering angle to either side	45°	45°
Lock to lock turns, steering wheel	4	4
System pressure - bar (lbf/in ²)	241 (3 500)	241 (3 500)
SAE Turning Radius mm (ft/ins)	8 470 (27-9)	8 470 (27-9)
Clearing Radius mm (ft/ins)	8 950 (29-4)	8 950 (29-4)



Frame

	TA25	TA27
	<p>Front and rear frames are all-welded high grade steel fabrications with rectangular box-section beams forming the main side and cross members. Inter-frame oscillation is provided by a large diameter cylindrical coupling which houses nylon bushings. Frames articulate 45° to either side for steering by means of two widely-spaced pivot pins in back-to-back sealed taper roller bearings.</p>	



Body

	TA25	TA27
	<p>All welded construction, fabricated from high hardness (min.360 BHN) 1 000 MPa (145 000 lbf/in²) yield strength steel. Dual slope tailchute controls material ejection from body.</p>	
Plate thickness - mm (in):		
Floor and tailchute	12.0 (0.47)	14.0 (0.55)
Sides	12.0 (0.47)	12.0 (0.47)
Front	8.0 (0.31)	8.0 (0.31)
Volume - m ³ (yd ³)		
Struck	10.0 (13.07)	12.5 (16.4)
Heaped 2:1 (SAE)	13.5 (17.65)	15.5 (20.3)



Hoist

	TA25	TA27
	<p>Two single-stage, double-acting hoist cylinders, cushioned at the base end. Variable displacement / load sensing piston pump driven from power take-off on transmission. Full flow return line filtration. Full electro-hydraulic hoist control, with electronic detent in power down.</p>	
System pressure - bar (lbf/in ²)	220 (3 200)	220 (3 200)
Pump output flow rate - litre/sec (gal/min)	4.9 (77.6)	4.9 (77.6)
Raise (loaded)	12	12
Lower - seconds	7.5	7.5

TA30	TA35	TA40
Hydrostatic power steering by two double-acting cushioned steering cylinders with pressure supplied by a variable displacement / load sensing piston pump. Secondary steering pressure is provided by a ground driven pump mounted on the dropbox. An audible alarm and warning light indicates should the secondary system activate.		
45°	45°	45°
4	4	4
241 (3 500)	240 (3 480)	240 (3 480)
8 470 (27-9)	9 185 (30-1)	9 185 (30-1)
8 950 (29-4)	9 675 (31-9)	9 675 (31-9)

TA30	TA35	TA40
Front and rear frames are all-welded high grade steel fabrications with rectangular box-section beams forming the main side and cross members. Inter-frame oscillation is provided by a large diameter cylindrical coupling which houses nylon bushings. Frames articulate 45° to either side for steering by means of two widely-spaced pivot pins in back-to-back sealed taper roller bearings.		

TA30	TA35	TA40
All welded construction, fabricated from high hardness (min 360 BHN) 1 000 MPa (145 000 lbf/in ²) yield strength steel. Dual slope tailchute improves material ejection from body.		
14.0 (0.55)	15.0 (0.58)	15.0 (0.58)
12.0 (0.47)	12.0 (0.47)	12.0 (0.47)
8.0 (0.31)	8.0 (0.31)	8.0 (0.31)
13.8 (18.0)	15.5 (20.3)	17.4 (22.8)
17.5 (22.9)	21.0 (27.5)	23.3 (30.3)

TA30	TA35	TA40
Two single-stage, double-acting hoist cylinders, cushioned at the base end. Variable displacement / load sensing piston pump driven from power take-off on transmission. Full flow return line filtration. Full electro-hydraulic hoist control, with electronic detent in power down.		
220 (3 200)	240 (3 480)	240 (3 480)
4.9 (77.6)	5.4 (85.6)	5.4 (85.6)
12	12.5	12.5
7.5	8	8

Generation 7 articulated trucks



Tyres and Wheels

	TA25	TA27
Tyres	Standard 23.5. Optional 750/65	
Rims	Standard 25 x 19.50. For optional tyre, 25 x 22.00	
Wheels	3-piece earthmover rims with 12 stud fixing	



Axles

	TA25	TA27
	<p>Heavy duty axles with fully floating axle shafts and outboard planetary reduction gearing. The three axles are in permanent all-wheel drive (6x6) with a differential coupling between the front and rear axles. All three axles also have hydraulically actuated multiplate transverse diff-lock differentials for 100% cross-axle lock up. The inter-axle and cross-axle diff locks are controlled by the operator, and can be actuated when required in poor traction conditions.</p>	
Differential ratio	3.875:1	3.875:1
Planetary reduction	5.71:1	5.71:1
Overall Drivetrain reduction	22.12:1	22.12:1



Suspension

	TA25	TA27
Front	<p>Axle is carried on the leading arms of a sub-frame which pivots on the main frame. Suspension by rubber elements with four heavy duty hydraulic dampers.</p>	
Rear	<p>Each axle is coupled to the frame by three rubberbushed links with lateral restraint by a transverse link. Pivoting inter-axle balance beams equalise load on each rear axle. Suspension movement is cushioned by rubber/ metal laminated compression units between each axle and underside of balance beam ends.</p> <p>Pivot points on leading and trailing links are rubberbushed and maintenance-free.</p>	



Brakes

	TA25	TA27
	<p>All hydraulic braking systems with multiplate sealed and oil cooled brake packs at each wheel. Independent circuits for front and rear brake systems.</p>	
Parking	Spring-applied, hydraulic-released disc on rear driveline.	
Secondary	Secondary brake control actuates service and parking brakes.	
Retarder	Engine compression brake is standard.	

TA30	TA35	TA40
Standard 23.5. Optional 750/65	Standard 26.5	Standard 29.5
Standard 25 x 19.50. For optional tyre, 25 x 22.00	Standard 25 x 22.00	Standard 25 x 25.00
3-piece earthmover rims with 12 stud fixing	3-piece earthmover rims with 19 stud fixing	

TA30	TA35	TA40
Heavy duty axles with fully floating axle shafts and outboard planetary reduction gearing. The three axles are in permanent all-wheel drive (6x6) with a differential coupling between the front and rear axles. All three axles also have hydraulically actuated multiplate transverse diff-lock differentials for 100% cross-axle lock up. The inter-axle and cross-axle diff locks are controlled by the operator, and can be actuated when required in poor traction conditions.	Three axles in permanent all-wheel drive (6x6) with differential coupling between each axle to prevent driveline wind-up. Heavy duty axles with full floating axle shafts and outboard planetary reduction gearing. Automatic limited slip differentials in each axle. Leading rear axle incorporates a through drive differential to transmit drive to the rearmost axle. This differential and the dropbox output differential are locked simultaneously using one switch selected by the operator.	
3.875:1	3.70:1	3.70:1
5.71:1	6.35:1	6.35:1
22.12:1	23.50:1	23.50:1

TA30	TA35	TA40
Axle is carried on the leading arms of a sub-frame which pivots on the main frame. Suspension by rubber elements with four heavy duty hydraulic dampers.	Four trailing links and a panhard rod locate the front axle giving a high roll centre. The optimised front axle position along with the wide spaced main and rebound mounts, mounted directly above the axle and long suspension travel, combine with the two heavy duty dampers each side to give excellent handling and ride.	
Each axle is coupled to the frame by three rubber-bushed links with lateral restraint by a transverse link. Pivoting inter-axle balance beams equalise load on each rear axle. Suspension movement is cushioned by rubber/metal laminated compression units between each axle and underside of balance beam ends.		
Pivot points on leading and trailing links are rubber-bushed and maintenance-free.		

TA30	TA35	TA40
All hydraulic braking systems with multiplate sealed and oil cooled brake packs at each wheel. Independent circuits for front and rear brake systems.	All hydraulic system with sealed, forced oil cooled, multi discs on all axles. Independent circuits for front and rear brake systems. Warning lights and audible alarm indicate low brake system pressure. Brake system conforms to ISO 3450, SAE J1473.	
Spring-applied, hydraulic-released disc on rear driveline.		
Secondary brake control actuates service and parking brakes.		
Engine compression brake is standard.	Engine brake and transmission retarder are standard. Engine brake operates automatically should engine approach overspeed	

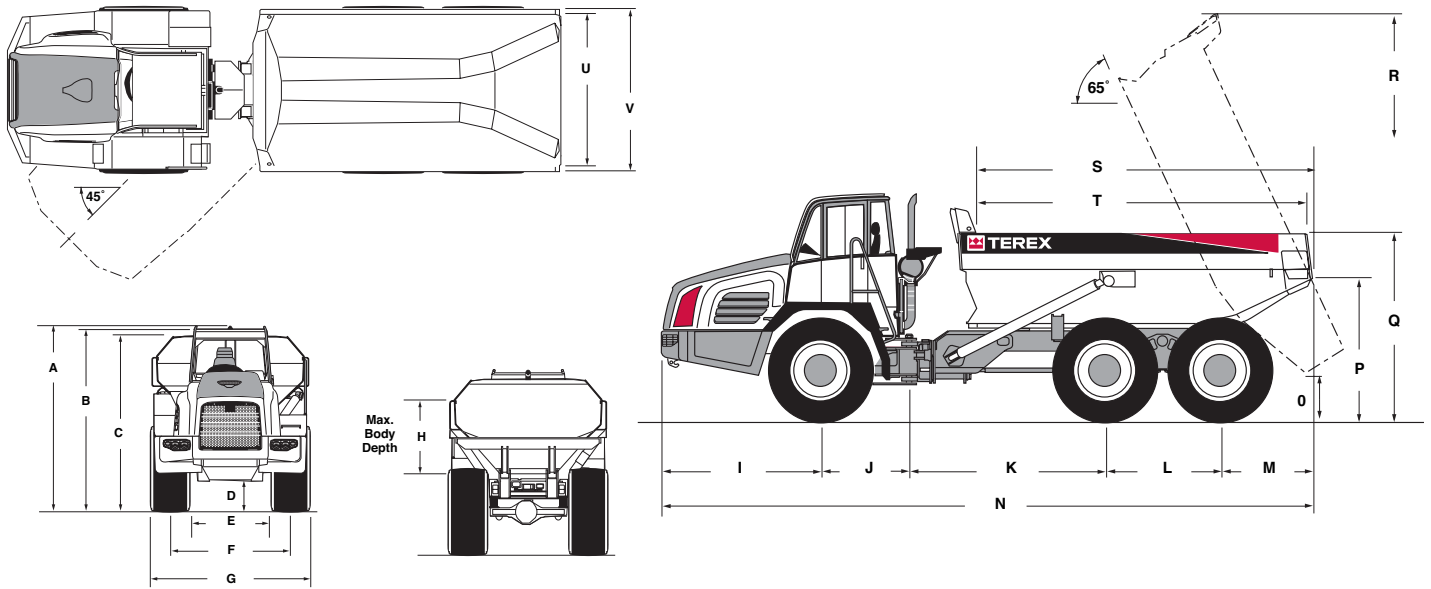

Dimensions in mm (ft-in)

	TA25	TA27	TA30	TA35	TA40
A	3 450 (11-3)	3 450 (11-3)	3 450 (11-3)	3 888 (12-9)	3 942 (12-11)
B	3 420 (11-2)	3 420 (11-2)	3 420 (11-2)	3 686 (12-1)	3 740 (12-3)
C	2 985 (9-10)	3 120 (10-3)	3 325 (10-10)	3 494 (11-5)	3 548 (11-8)
D	405 (1-6)	405 (1-6)	405 (1-6)	553 (1-10)	607 (2-0)
E	1 580 (5-3)	1 580 (5-3)	1 580 (5-3)	1 837 (6-0)	1 837 (6-0)
F	2 200 (7-2)	2 200 (7-2)	2 200 (7-2)	2 520 (8-3)	2 596 (8-6)
G	2 895 (9-6)	2 895 (9-6)	2 895 (9-6)	3 206 (10-6)	3 356 (11-0)
H	1 110 (3-8)	1 240 (4-1)	1 445 (4-9)	1 380 (4-6)	1 494 (4-11)
I	2 400 (7-9)	2 400 (7-9)	2 400 (7-9)	2 914 (9-7)	2 914 (9-7)
J	1 310 (4-4)	1 310 (4-4)	1 310 (4-4)	1 310 (4-4)	1 310 (4-4)
K	2 945 (9-8)	2 945 (9-8)	2 945 (9-8)	2 990 (9-10)	2 990 (9-10)
L	1 690 (5-6)	1 690 (5-6)	1 690 (5-6)	1 950 (6-5)	1 950 (6-5)
M	1 410 (4-9)	1 410 (4-9)	1 410 (4-9)	1 780 (5-10)	1 781 (5-10)
N	9 755 (32-0)	9 755 (32-0)	9 755 (32-0)	10 944 (35-11)	10 944 (35-11)
O	725 (2-3)	725 (2-3)	725 (2-3)	851 (2-9)	905 (3-0)
P	2 175 (7-2)	2 175 (7-2)	2 175 (7-2)	2 414 (7-11)	2 468 (8-1)
Q	2 605 (8-6)	2 740 (8-11)	2 895 (9-6)	2 967 (9-9)	3 140 (10-4)
R	5 995 (19-8)	6 015 (19-9)	6 110 (20-0)	6 872 (22-7)	6 926 (22-9)
S	4 990 (16-5)	5 000 (16-5)	5 010 (16-5)	5 651 (18-6)	5 658 (18-7)
T	4 735 (16-2)	4 930 (16-2)	4 920 (16-2)	5 576 (18-3)	5 570 (18-3)
U	2 670 (8-9)	2 670 (8-9)	2 685 (8-10)	3 131 (10-3)	3 131 (10-3)
V	N/A	2 890 (9-5)	2 895 (9-6)	3 315 (10-11)	3 315 (10-11)





Weights

	TA25		TA27		TA30		TA35		TA40	
	kg	lb	kg	lb	kg	lb	kg	lb	kg	lb
Standard Unit										
Net Distribution										
Front Axle	11 564	(25 494)	11 724	(25 793)	11 753	(25 913)	15 844	(34 930)	15 880	(34 936)
Bogie Axle Leading	4 785	(10 549)	5 205	(11 451)	5 315	(11 718)	7 293	(16 078)	7 500	(16 500)
Bogie Axle Trailing	4 856	(10 706)	5 276	(11 709)	5 417	(11 942)	7 233	(15 946)	7 440	(16 368)
Vehicle, Net	21 205	(46 749)	22 205	(48 953)	22 485	(49 573)	30 370	(66 594)	30 820	(67 804)
Payload	23 000	(50 705)	25 000	(55 115)	28 000	(61 730)	34 000	(74 956)	38 000	(83 775)
Gross Distribution										
Front Axle	14 880	(32 805)	15 880	(34 936)	16 821	(37 086)	17 374	(38 303)	17 620	(38 845)
Bogie Axle Leading	14 592	(32 170)	15 592	(34 302)	16 740	(36 904)	23 528	(51 870)	25 600	(56 438)
Bogie Axle Trailing	14 633	(32 260)	15 733	(34 830)	16 924	(37 313)	23 468	(51 738)	25 000	(55 000)
Vehicle Gross	44 205	(97 455)	47 205	(104 068)	50 485	(111 303)	64 370	(141 911)	68 820	(151 500)
Bare Chassis	17 335	(38 217)	17 335	(38 213)	17 555	(38 703)	4 760	(54 586)	24 760	(54 444)
Body	3 100	(6 835)	4 100	(9 040)	4 400	(9700)	4 950	(10 915)	5 400	(11 905)
Hoists, pair	530	(1 170)	530	(1 170)	530	(1 170)	660	(1 455)	660	(1 455)

Ground Pressure

These figures are at 15% shrinkage of unloaded radius and specified weights using tyres referred to below

	TA25		TA27		TA30		TA35		TA40	
	23.5 R25 kPa	23.5 R25 PSi	23.5 R25 kPa	23.5 R25 PSi	23.5 R25 kPa	23.5 R25 PSi	26.5 R25 kPa	26.5 R25 PSi	29.5 R25 kPa	29.5 R25 PSi
Unloaded										
Front	113	(16.4)	118	(17.1)	119	(17.2)	137	(19.8)	112	(16.2)
Rear	46	(6.6)	53	(7.6)	54	(7.8)	61	(8.8)	53	(7.7)
Loaded										
Front	146	(21.2)	161	(23.3)	170	(24.6)	145	(21.1)	121	(17.5)
Rear	143	(20.8)	158	(22.9)	170	(24.6)	192	(27.9)	180	(26.1)



Building on technology

Standard equipment

	TA25	TA27	TA30	TA35	TA40		TA25	TA27	TA30	TA35	TA40
Cab and Operator						Secondary Steering	✓	✓	✓	✓	✓
Air Conditioning	✓	✓	✓	✓	✓	Transmission 'CHECK'				✓	✓
Air Filter Restriction Indicator	✓	✓	✓	✓	✓	Transmission Oil Filter Change				✓	✓
Audible Alarm						Transmission 'STOP'	✓	✓	✓	✓	✓
Brakes Tractor, Low Pressure	✓	✓	✓	✓	✓	Warning Lights Test Switch	✓	✓	✓	✓	✓
Brakes Trailer, Low Pressure	✓	✓	✓	✓	✓	Window Protection Grille, rear	✓	✓	✓	✓	✓
Engine Stop	✓	✓	✓	✓	✓	Wiper and Washer, front and rear windows	✓	✓	✓	✓	✓
Steering, Low Pressure	✓	✓	✓	✓	✓	General					
Transmission Stop	✓	✓	✓	✓	✓	Articulation and Oscillation Lock	✓	✓	✓	✓	✓
Battery Master Switch	✓	✓	✓	✓	✓	Brakes Fully Hydraulic Dual Circuit System	✓	✓	✓	✓	✓
Cigar Lighter, 24v	✓	✓	✓	✓	✓	Brake Splash Guards	N/A	N/A	N/A	N/A	N/A
Coathook	✓	✓	✓	✓	✓	Body Prop	✓	✓	✓	✓	✓
Electrical Jack Point 12V	✓	✓	✓	✓	✓	Diagnostic Pressure Test Points	✓	✓	✓	✓	✓
Electrical Jack Point 24V	✓	✓	✓	✓	✓	Engine Brake	✓	✓	✓	✓	✓
Engine Diagnostic Facility	✓	✓	✓	✓	✓	Engine Electronic Management System	✓	✓	✓	✓	✓
Gauges						Engine Exhaust Brake					
Brake Cooling Oil Temperature					✓	Engine Underguard	✓	✓	✓	✓	✓
Fuel Level	✓	✓	✓	✓	✓	Engine Hood Electrically Operated					
Speedometer/Odometer	✓	✓	✓	✓	✓	Exhaust Muffler	✓	✓	✓	✓	✓
Transmission Oil Temperature	✓	✓	✓	✓	✓	Fan, Modulating	✓	✓	✓	✓	✓
Tachometer with Hourmeter	✓	✓	✓	✓	✓	Guards Rear Lights	✓	✓	✓	✓	✓
Voltmeter	✓	✓	✓	✓	✓	Handrails on Fenders	✓	✓	✓	✓	✓
Coolant Temperature	✓	✓	✓	✓	✓	Headlamp Guards	✓	✓	✓	✓	✓
Heater and Demister	✓	✓	✓	✓	✓	Hydraulic Diagnostic Facility RS232	✓	✓	✓	✓	✓
Horn, Electric 117 db	✓	✓	✓	✓	✓	Hydraulic Filter Restriction Indicator					
Indicators - Lights & Alarms						Hydraulic Oil Cooler	✓	✓	✓	✓	✓
Body up	✓	✓	✓	✓	✓	Interaxle Differential Lock	✓	✓	✓	✓	✓
Direction Indicators	✓	✓	✓	✓	✓	Lights					
Dropbox High or Low Selection	✓	✓	✓	✓	✓	Direction and Hazard Warning Indicators	✓	✓	✓	✓	✓
Headlight High Beam	✓	✓	✓	✓	✓	Headlamps, (4) halogen	✓	✓	✓	✓	✓
Inter-Axle Diff. Lock 'ON'	✓	✓	✓	✓	✓	Side, Tail, Top and Reverse	✓	✓	✓	✓	✓
Parking Brake 'ON'	✓	✓	✓	✓	✓	Working Lights, Roof Mounted	✓	✓	✓	✓	✓
Retarder 'ON'	✓	✓	✓	✓	✓	Mudflaps at Front and Centre	✓	✓	✓	✓	✓
Insulation, Thermal and Acoustic	✓	✓	✓	✓	✓	Pivot Protection Guard	✓	✓	✓	✓	✓
Interior Light	✓	✓	✓	✓	✓	Reverse Alarm Audible J994	✓	✓	✓	✓	✓
Mirror Rear View (4)	✓	✓	✓	✓	✓	Secondary Steering	✓	✓	✓	✓	✓
Mug Holder	✓	✓	✓	✓	✓	Security Kit	✓	✓	✓	✓	✓
Neutral Start Interlock	✓	✓	✓	✓	✓	Servo Assisted Body Hoist control	✓	✓	✓	✓	✓
Radio Cassette	✓	✓	✓	✓	✓	Tilting Cab for Maintenance	✓	✓	✓	✓	✓
ROPS/FOPS Protection ISO 3471/3449 SAE J1040 Apr 88/J231	✓	✓	✓	✓	✓	Tow Points Front and Rear	✓	✓	✓	✓	✓
Seat Belts, Retractable J386	✓	✓	✓	✓	✓	Transmission Automatic Electronically Controlled	✓	✓	✓	✓	✓
Seat, Operator, air suspension, high back, headrest and adjustable armrests	✓	✓	✓	✓	✓	Transmission Electronic Diagnostics	✓	✓	✓	✓	✓
Seat Passenger	✓	✓	✓	✓	✓	Transmission Downshift Inhibitor	✓	✓	✓	✓	✓
Steering Wheel, tilt/telescopic	✓	✓	✓	✓	✓	Transmission Hydraulic Retarder					
Storage Compartment	✓	✓	✓	✓	✓	Transmission Oil Cooler with Modulating Fan	✓	✓	✓	✓	✓
Sun Visor (internal)	✓	✓	✓	✓	✓	Transmission Sump Guard	✓	✓	✓	✓	✓
Sun Visor (external)	✓	✓	✓	✓	✓	Tyre Inflation Nitrogen	✓	✓	✓	✓	✓
Tinted Glass	✓	✓	✓	✓	✓						
Transmission Visual Display Unit	✓	✓	✓	✓	✓						
Warning Lights											
Alternator Charging	✓	✓	✓	✓	✓						
Brake Cooling Oil Pressure	✓	✓	✓	✓	✓						
Brake Pressure - Front and Rear	✓	✓	✓	✓	✓						
Coolant Level	✓	✓	✓	✓	✓						
Coolant Temperature	✓	✓	✓	✓	✓						
Engine 'CHECK'	✓	✓	✓	✓	✓						
Engine 'STOP'	✓	✓	✓	✓	✓						
Fuel, Low Level	✓	✓	✓	✓	✓						
Maintenance (engine)	✓	✓	✓	✓	✓						
Low Steering Pressure / Secondary Steering	✓	✓	✓	✓	✓						

Optional equipment

	TA25	TA27	TA30	TA35	TA40		TA25	TA27	TA30	TA35	TA40
Body Options						Mirrors					
Spillguard Extension	✓	✓	✓	✓	✓	Mirror Front Mounted	✓	✓	✓	✓	✓
Heated Body	✓	✓	✓	✓	✓	Mirror with Wide Angle	✓	✓	✓	✓	✓
Liner Plates		✓	✓	✓	✓	Mirrors Heated	✓	✓	✓	✓	✓
Body Side Extensions		✓	✓	✓	✓	Other Options					
Tailgate Overhinged chain operated	✓	✓	✓	✓	✓	Automatic Lubrication	✓	✓	✓	✓	✓
Tailgate Underhinged		✓	✓	✓	✓	Fast Fuel Adapter				✓	✓
Lights						Fire Extinguisher	✓	✓	✓	✓	✓
Beacon Flashing	✓	✓	✓	✓	✓	First Aid Kit	✓	✓	✓	✓	✓
Fog Rear	✓	✓	✓	✓	✓	Hydraulic Oil Cooler	✓	✓	✓	STD	STD
Reverse Flashing	✓	✓	✓	✓	✓	Independent Suspension	✓	✓	✓	✓	✓
Floodlights Rear Working	✓	✓	✓	✓	✓	Parking Brake Guard	✓	✓	✓	✓	✓
						Retarder Transmission	NA	✓	✓	STD	STD
						Seat Heated	✓	✓	✓	✓	✓
						Television Monitor Rear View	✓	✓	✓	✓	✓
						Tool Kit	✓	✓	✓	✓	✓

Service data

	TA25	TA27	TA30
Fuel Tank	390 litres (103.0 US gal)	390 litres (103.0 US gal)	390 litres (103.0 US gal)
Hydraulic System (steering & body)	202 litres (53.4 US gal)	202 litres (53.4 US gal)	202 litres (53.4 US gal)
Engine Crankcase	41 litres (10.8 US gal)	41 litres (10.8 US gal)	41 litres (10.8 US gal)
Cooling System	54 litres (14.3 US gal)	54 litres (14.3 US gal)	54 litres (14.3 US gal)
Transmission (inc filters and cooler)	54 litres (14.3 US gal)	54 litres (14.3 US gal)	60 litres (15.9 US gal)
Differentials - Front & Rear (each)	21 litres (5.5 US gal)	21 litres (5.5 US gal)	21 litres (5.5 US gal)
Differential - Centre	23 litres (6.0 US gal)	23 litres (6.0 US gal)	23 litres (6.0 US gal)
Planetaries (each)	7.5 litres (2.0 US gal)	7.5 litres (2.0 US gal)	7.5 litres (2.0 US gal)

	TA35	TA40
Fuel Tank	481 litres (127.0 US gal)	481 litres (127.0 US gal)
Hydraulic System (steering, braking & body)	330 litres (87.0 US gal)	330 litres (87.0 US gal)
Engine Crankcase	40 litres (10.5 US gal)	40 litres (10.5 US gal)
Cooling System	80 litres (21.1 US gal)	80 litres (21.1 US gal)
Transmission (inc filters and cooler)	56 litres (12.3 US gal)	56 litres (14.8 US gal)
Differentials - Front & Rear (each)	38 litres (10.0 US gal)	38 litres (10.0 US gal)
Differential - Centre	39 litres (10.3 US gal)	39 litres (10.3 US gal)
Planetaries (each)	8.5 litres (2.2 US gal)	8.5 litres (2.2 US gal)
Brake Cooling System	175 litres (42.6 US gal)	175 litres (42.6 US gal)

Optional equipment



Tailgate



Tailgate



Television Monitor Rear View



Auto Lube

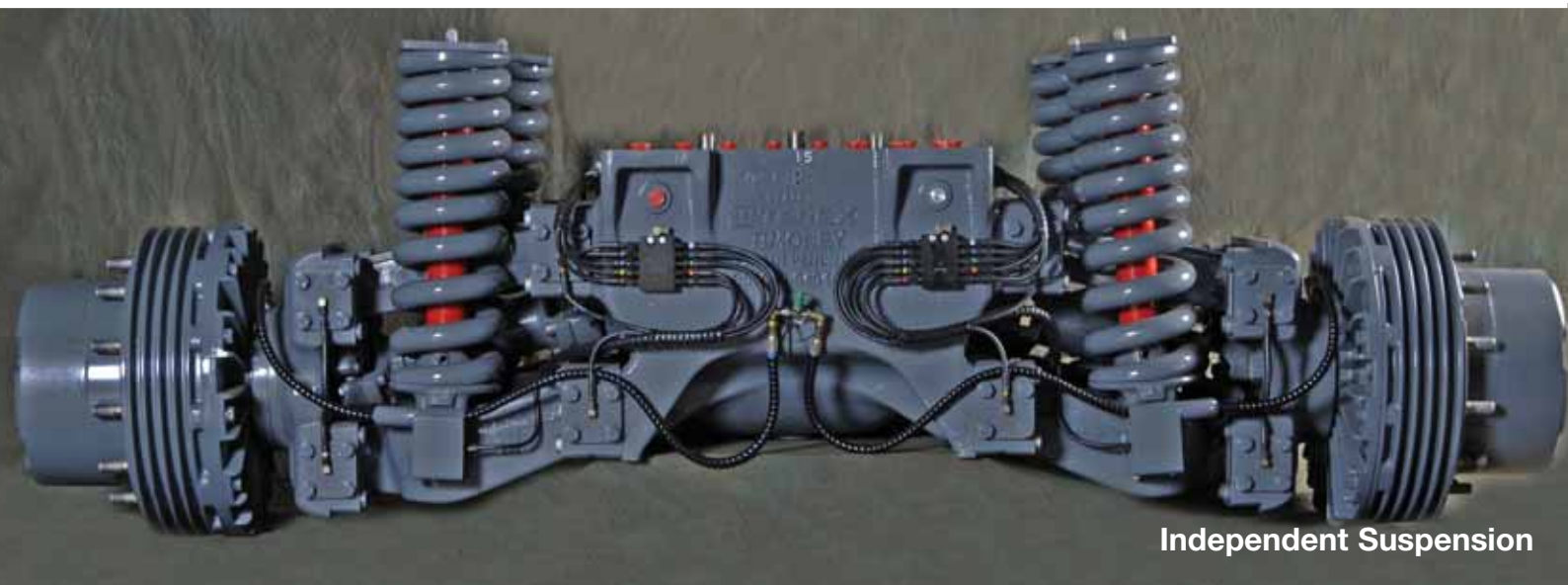

Independent Suspension

Building on technology

Performance data

TA25

Unit equipped with 23.5 R 25 tyres

Graphs based on 2% Rolling Resistance

GRADEABILITY

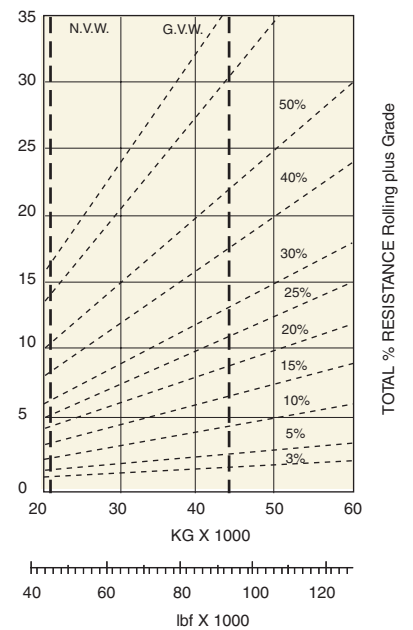
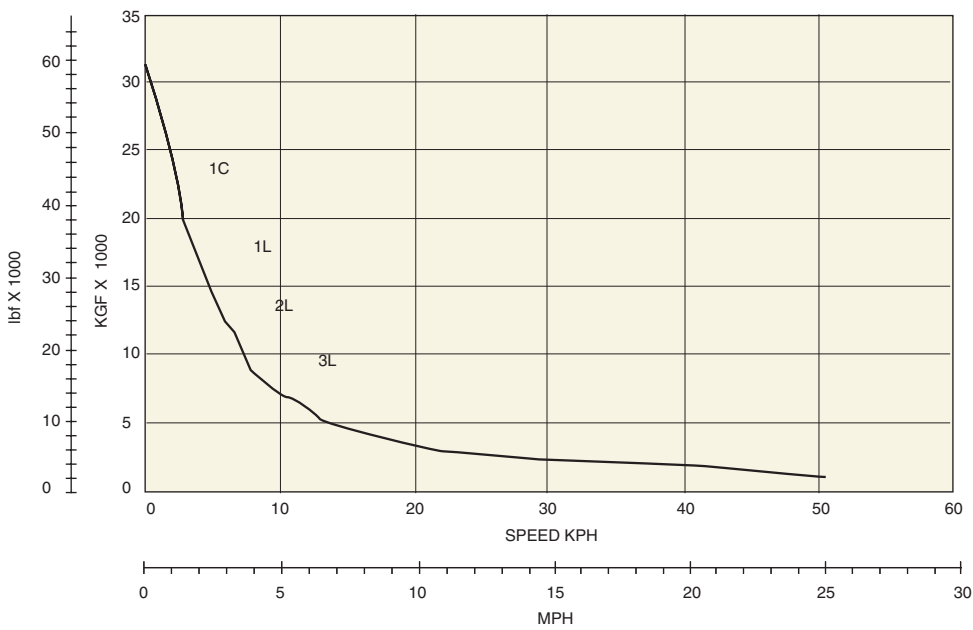

RETARDATION

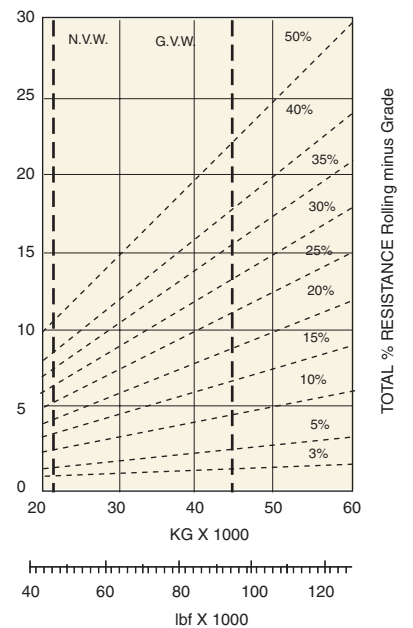
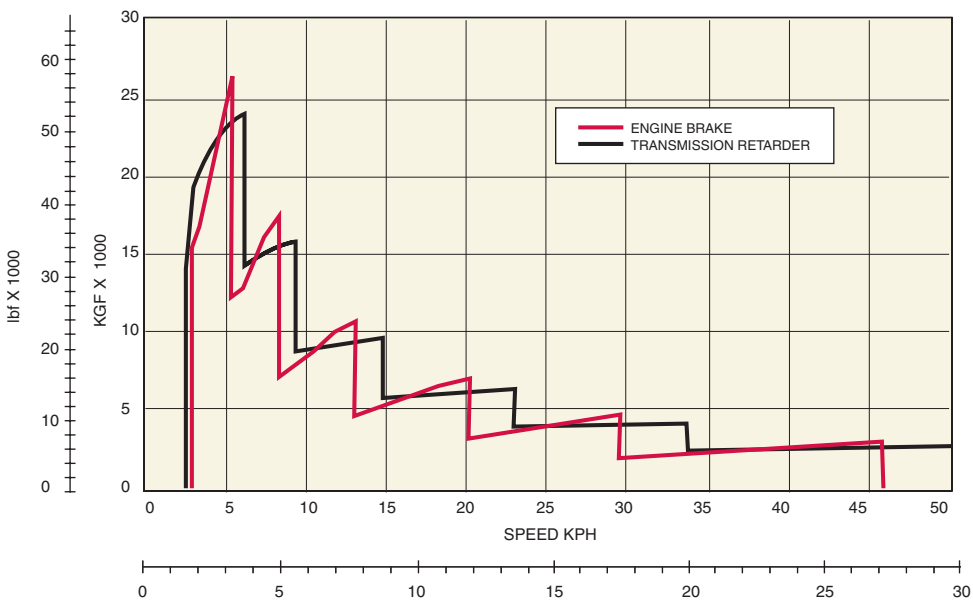

Instructions: From intersection of vehicle weight with percentage resistance line read across to determine maximum gear attainable, and then downwards for speed.

Performance data

TA27

Unit equipped with 23.5 R 25 tyres

Graphs based on 2% Rolling Resistance

GRADEABILITY

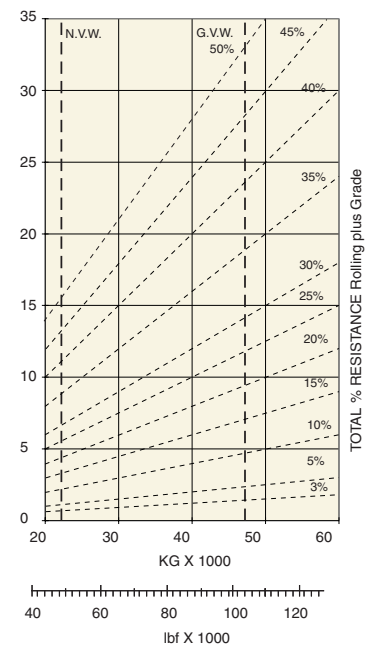
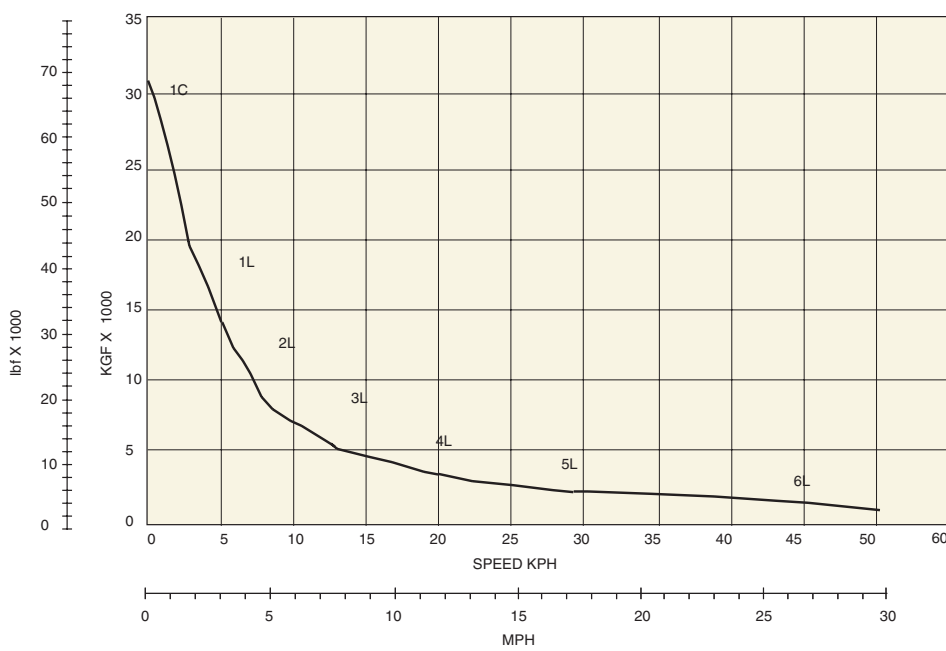

RETARDATION

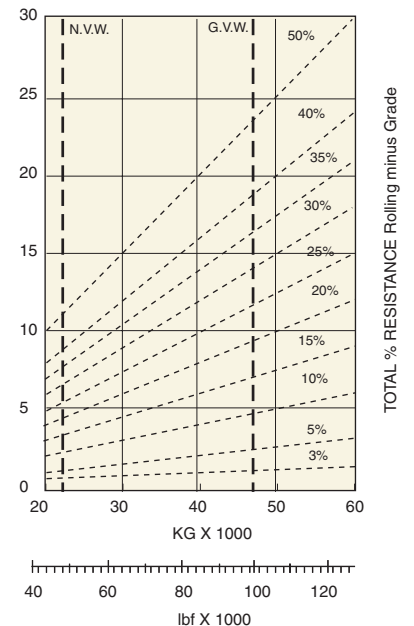
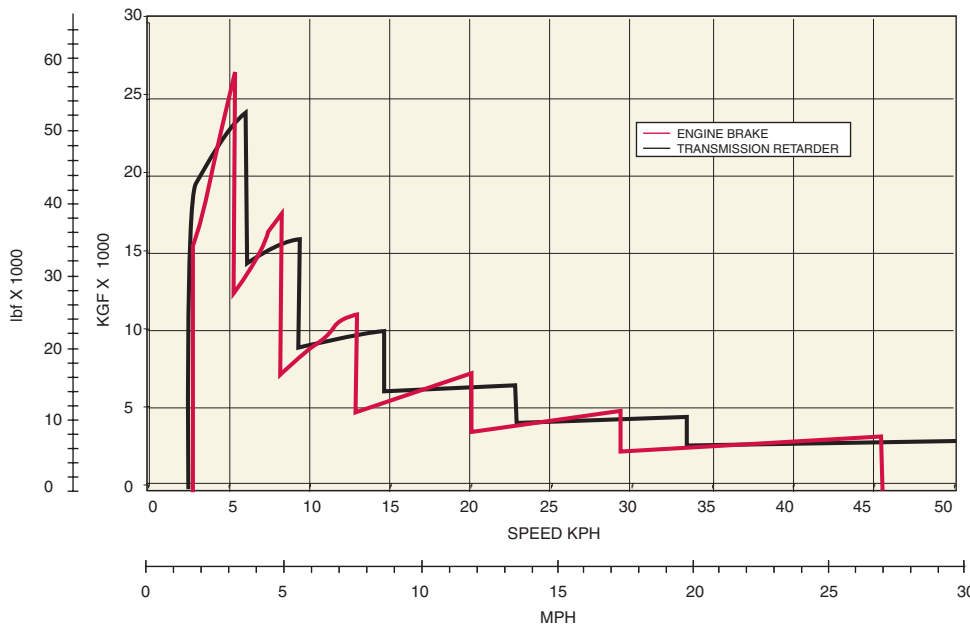

Instructions: From intersection of vehicle weight with percentage resistance line read across to determine maximum gear attainability, and then downwards for speed.

Building on technology

TA30

Unit equipped with 23.5 R 25 tyres

Graphs based on 2% Rolling Resistance

GRADEABILITY

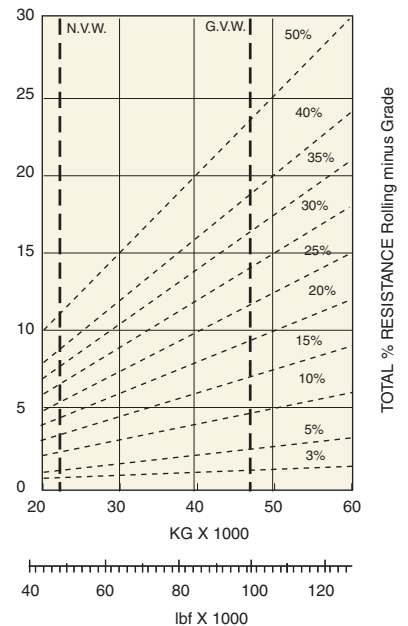
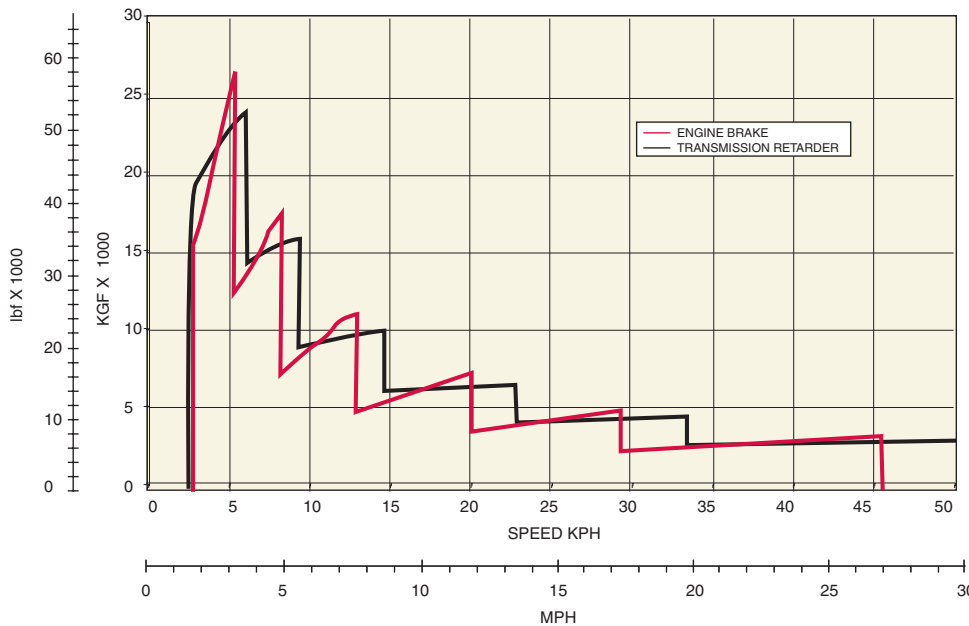
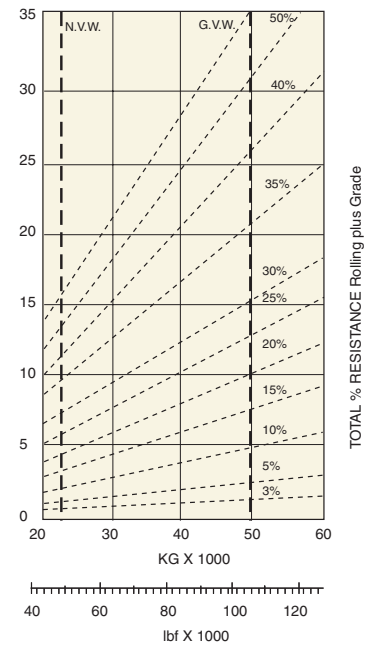
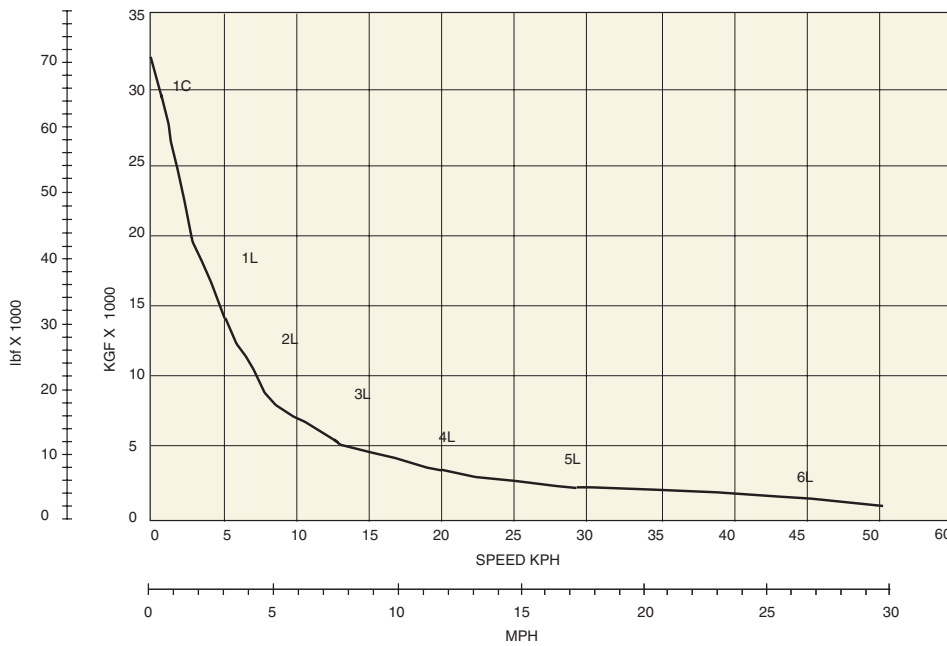

Instructions: From intersection of vehicle weight with percentage resistance line read across to determine maximum gear attainable, and then downwards for speed.

Performance data

TA35

Graphs based on 2% Rolling Resistance

GRADEABILITY

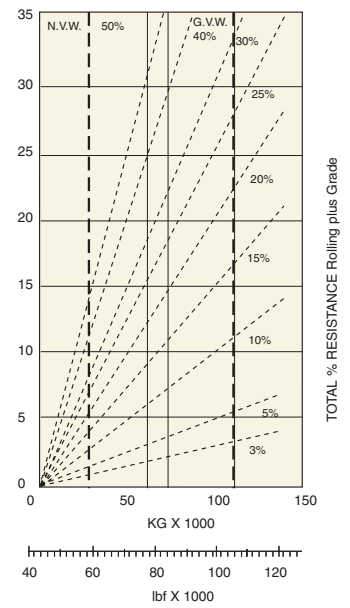
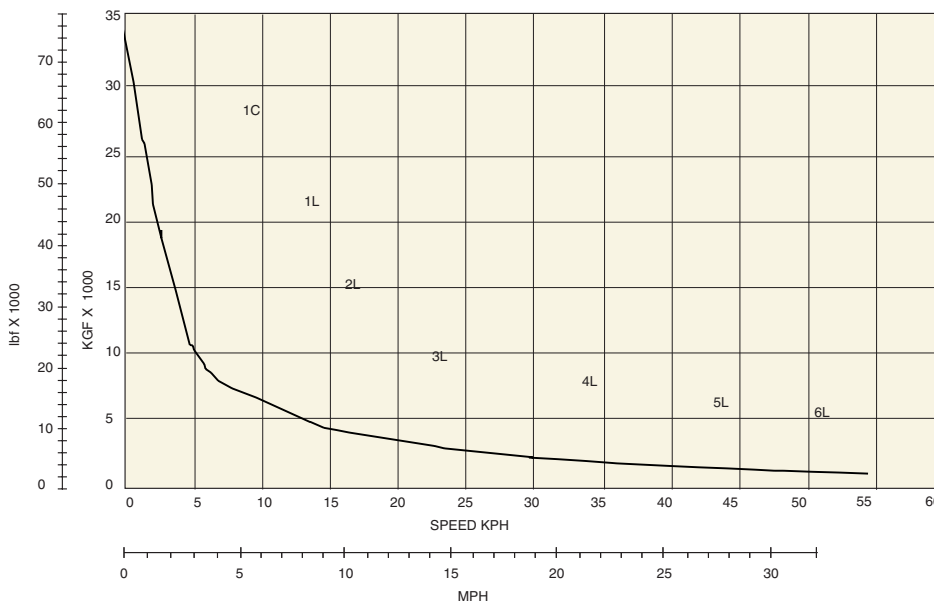

RETARDATION - ENGINE BRAKE AND TRANSMISSION RETARDER

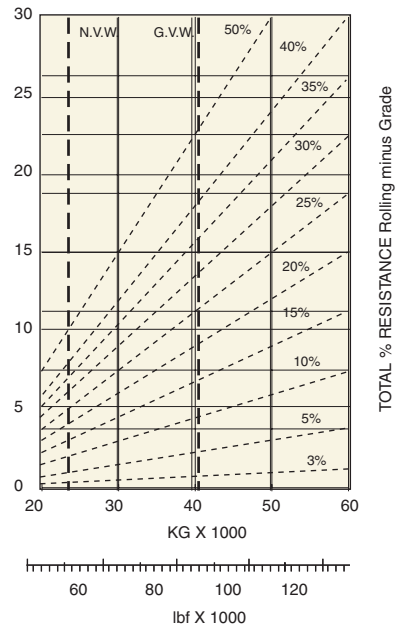
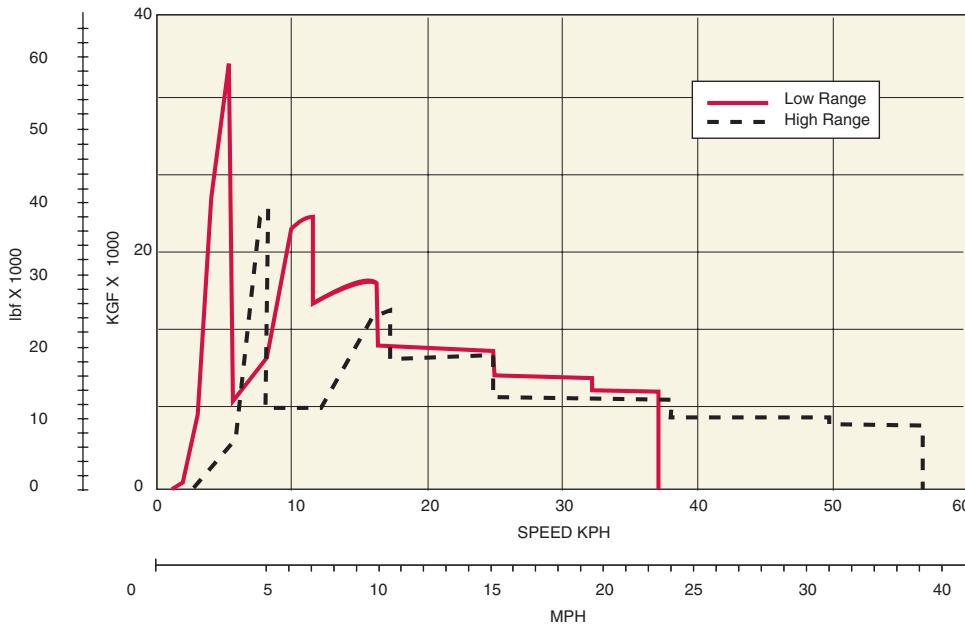

Instructions: From intersection of vehicle weight with percentage resistance line read across to determine maximum gear attainable, and then downwards for vehicle speed.

Building on technology

TA40

Graphs based on 2% Rolling Resistance

GRADEABILITY

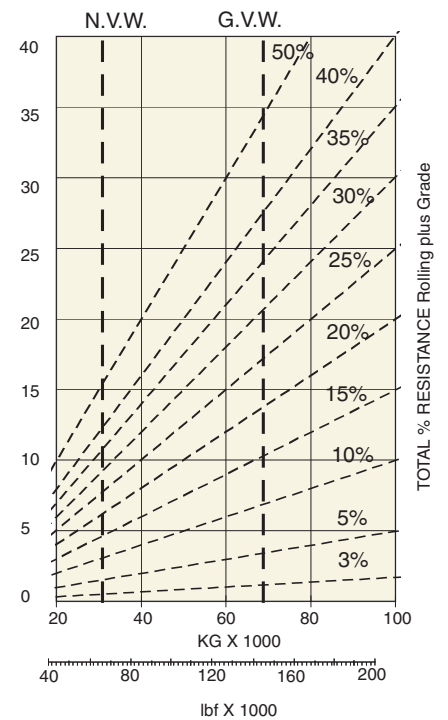
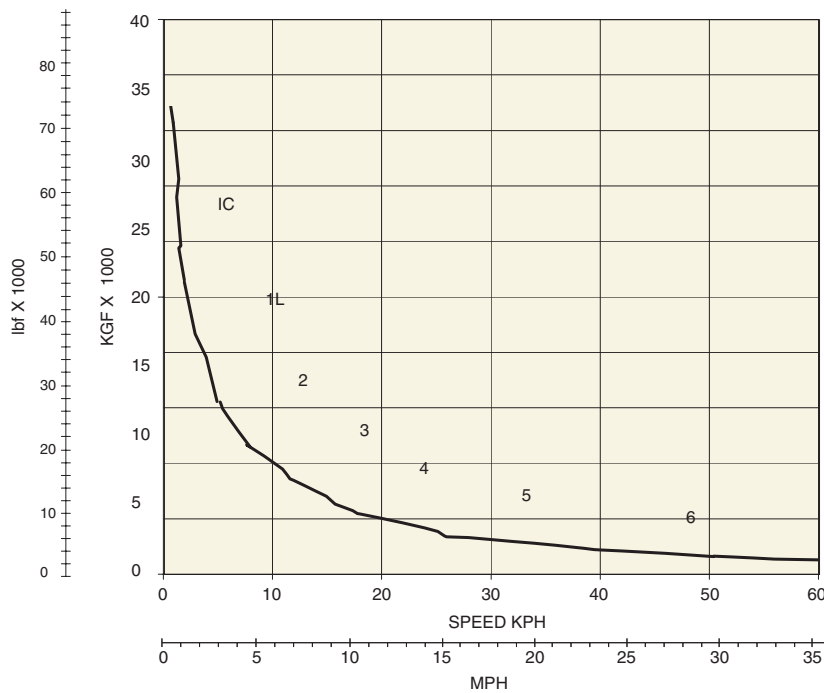

RETARDATION - ENGINE BRAKE AND TRANSMISSION RETARDER

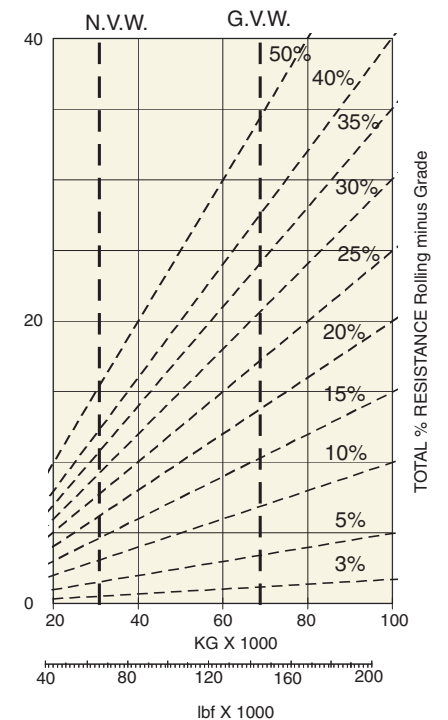
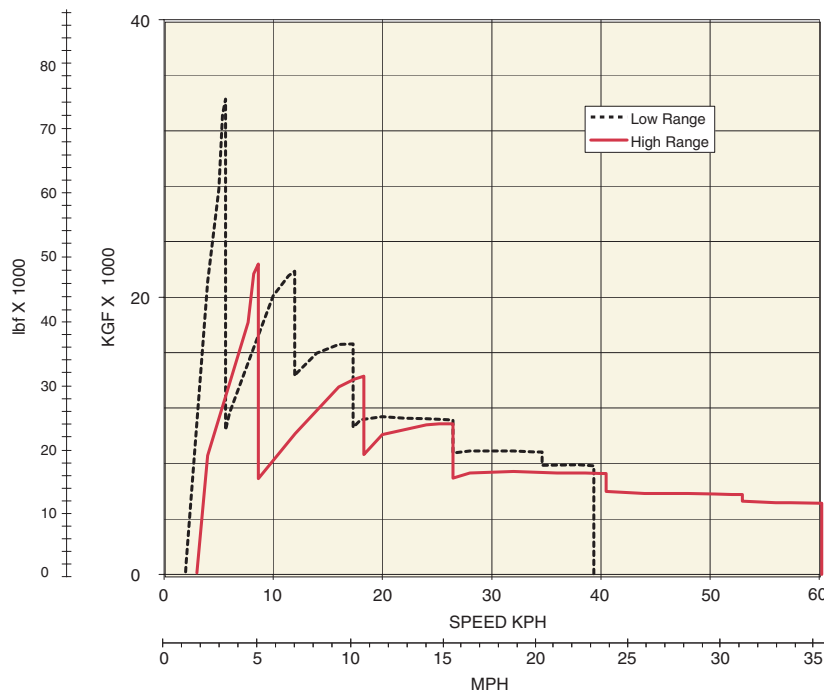

Instructions: From intersection of vehicle weight with percentage resistance line read across to determine maximum gear attainable, and then downwards for speed.

Building on technology



ARTICULATED TRUCKS

	Maximum payload	Heaped capacity	Engine gross power
TA 25	23 mt (25 ton)	13.5 m ³ (17.6 yd ³)	224 kW (300 hp)
TA 27	25 mt (27.5 ton)	15.5 m ³ (20.3 yd ³)	272 kW (365 hp)
TA 30	28 mt (30.9 ton)	17.5 m ³ (22.9 yd ³)	287 kW (385 hp)
NEW TA 35	34 mt (37.5 ton)	21.0 m ³ (27.5 yd ³)	298 kW (400 hp)
NEW TA 40	38 mt (41.9 ton)	23.3 m ³ (30.3 yd ³)	336 kW (450 hp)



OFF-HIGHWAY RIGID TRUCKS

	Maximum payload	Heaped capacity	Engine gross power
TR 35	31.75 mt (35 ton)	19.4 m ³ (25 yd ³)	298 kW (400 hp)
TR 45	41 mt (45 ton)	26 m ³ (34 yd ³)	392 kW (525 hp)
TR 60	55 mt (60 ton)	35 m ³ (46 yd ³)	485 kW (650 hp)
TR 70	65 mt (72 ton)	41.5 m ³ (54.3 yd ³)	567 kW (760 hp)
TR 100	91 mt (100 ton)	57 m ³ (74.5 yd ³)	783 kW (1 050 hp)

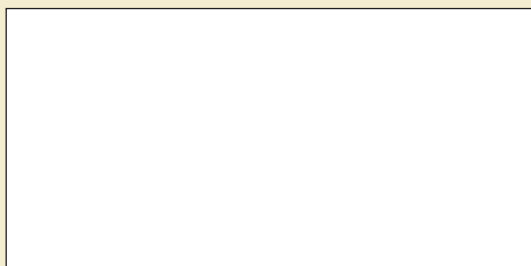

Terex Equipment Limited

Newhouse Industrial Estate, Motherwell, Scotland, ML1 5RY

Tel: +44 (0)1698 732 121 Fax: +44 (0)1698 734 046 Email: info@terex.co.uk Web: www.terex.com

Effective date: January 1, 2006. For further information, please contact your local distributor or Terex contact. Product specifications are subject to change without notice or obligation. The photographs and drawings in this brochure are for illustrative purposes only. Refer to the appropriate Operator's Manual for instructions on the proper use of this equipment. Failure to follow the appropriate Operator's Manual when using our equipment or to otherwise act irresponsibly may result in serious injury or death. Prices and specifications subject to change without notice. The only warranty applicable is the standard written warranty applicable to the particular product and sale. Terex makes no other warranty, expressed or implied. Products and services listed may be trademarks, service marks or trade-names of Terex Corporation and/or its subsidiaries in the USA and other countries and all rights are reserved. "Terex" is a Registered Trademark of Terex Corporation in the USA and many other countries. Copyright © 2006 Terex Corporation.

AFB03 Apr 2007