

# ZETTLER

## CONTENT



KSD301A 1/2" (12.7mm) Series Snap-Action Temperature Controls \_\_\_\_\_ P1



KSD301B Series Temperature Controls \_\_\_\_\_ P10



KSD301C 3/4" (19mm) Series Temperature Controls \_\_\_\_\_ P15



KSD301C Heat Sequencers - Time Delay \_\_\_\_\_ P21



KSD301C Series Temperature Sensing Controls \_\_\_\_\_ P24

Catalog Revision A

This catalog features our most popular thermostats and temperature controls. This is a small sampling of the many configurations and variations that we offer. We welcome the opportunity to discuss any requirements that you may have. **Please send your inquiries to: [sales@zettler.com](mailto:sales@zettler.com)**



## KSD301A 1/2" (12.7mm) Series Snap-Action Temperature Controls

**Similar to TOD Series 36T**

### Specifications

1. Electrical Ratings: AC120V 5A, 10A, 16A, AC250V 10A, 16A, 20A
2. OFF Temperature Range
  - a. Ceramic: -0°C ~ 250°C (-32F~ 482°F)
  - b. Bakelite: -30°C ~ 150°C (-22F~ 287°F)
3. Tolerance: Min ± 2°C Standard ± 5°C
4. A variety of terminal, switch case and mounting configurations are available for maximum design flexibility
5. NOTE: Please contact us to discuss specific custom requirements

### Applications:

Boiler, Water Heater, Vacuum Cleaner, Copier, Electric Stove, Oven, Dryer, Refrigerator, Dish Washer, Air-Conditioning etc.

**Approvals: UL CQC TUV VDE CUL CE**



A013

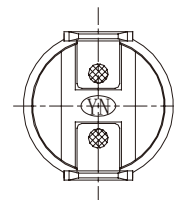
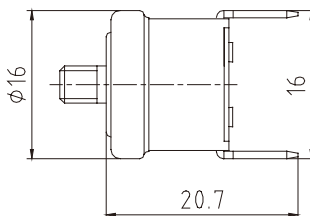

**Material:**  
Bakelite  
Ceramic  
PPS



A013R

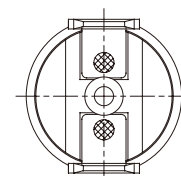
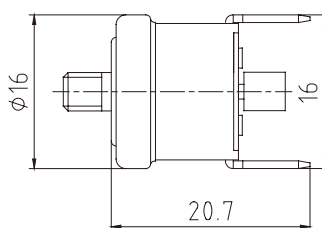

**Material:**  
Bakelite  
Ceramic





**A113**

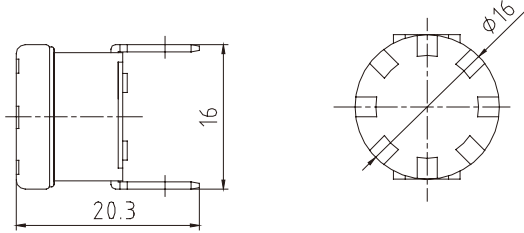

**Material:**  
Bakelite  
Ceramic  
PPS



**A113B**

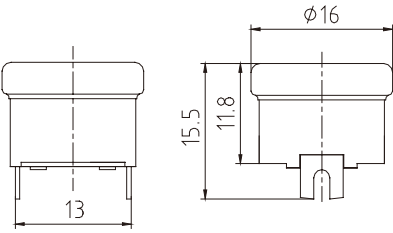

**Material:**  
Bakelite  
Ceramic  
PPS



**A113E**

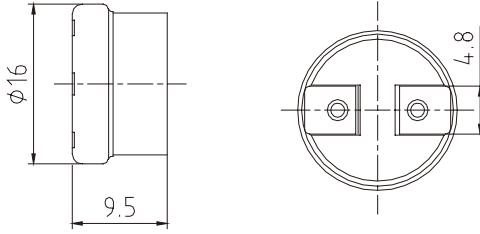

**Material:**  
Bakelite



**A113F**

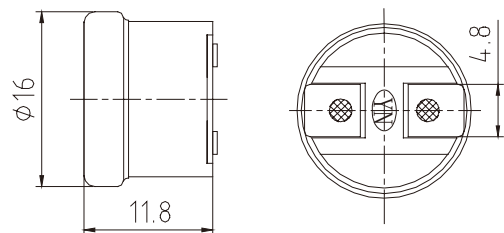

**Material:**  
Bakelite  
Ceramic  
PPS



**A113R**

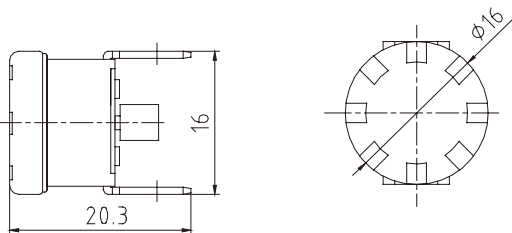

**Material:**  
Bakelite  
Ceramic



**A113T**

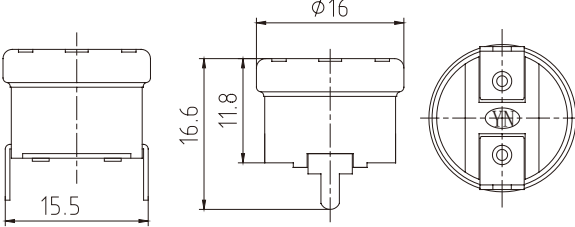

**Material:**  
Bakelite  
Ceramic  
PPS



**A114**

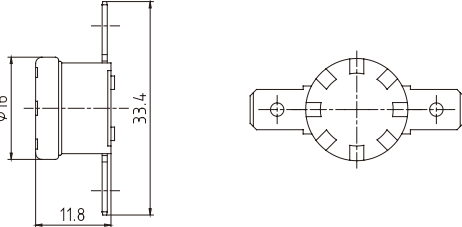

**Material:**  
Bakelite  
Ceramic  
PPS



**A313**

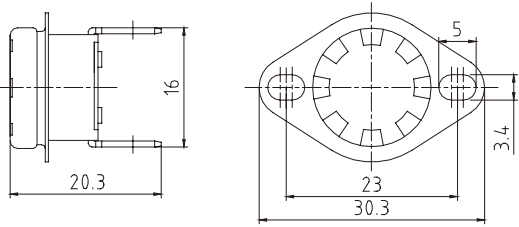

**Material:**  
Bakelite  
Ceramic  
PPS



**A313R**

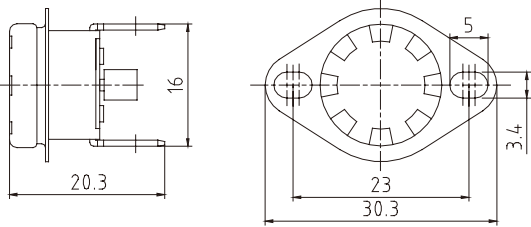

**Material:**  
Bakelite  
Ceramic



**A314**

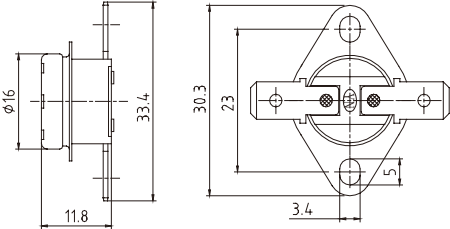

**Material:**  
Bakelite  
Ceramic  
PPS





**A323**

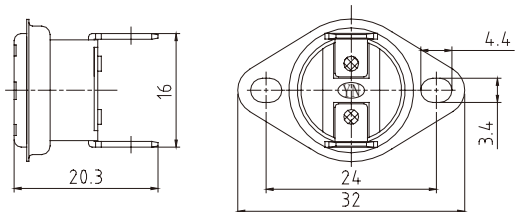

**Material:**  
Bakelite  
Ceramic  
PPS



**A333**

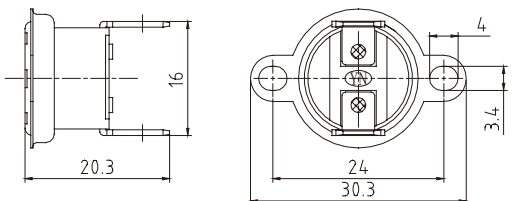

**Material:**  
Bakelite  
Ceramic  
PPS



**A333R**

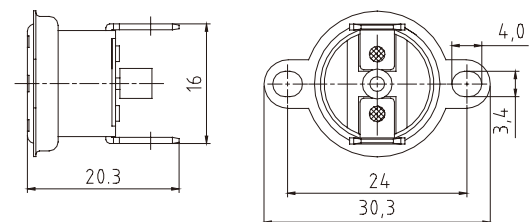

**Material:**  
Bakelite  
Ceramic



**A324**

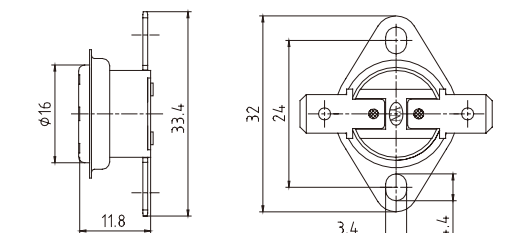

**Material:**  
Bakelite  
Ceramic  
PPS



**A324R**

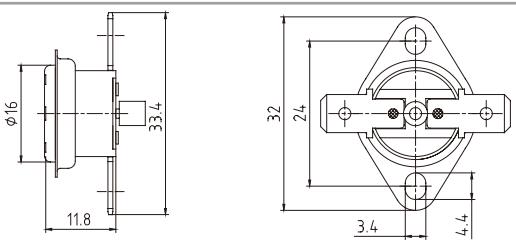

**Material:**  
Bakelite  
Ceramic



**A334**

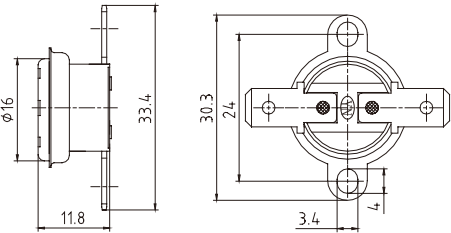

**Material:**  
Bakelite  
Ceramic  
PPS



**A443**

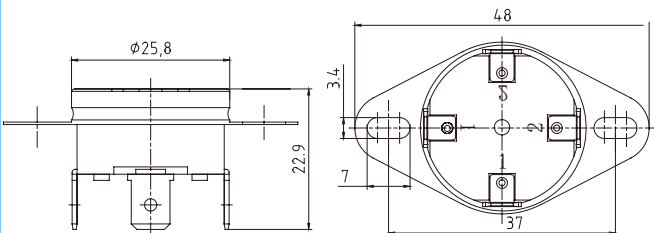

**Material:**  
Bakelite



**A443R**

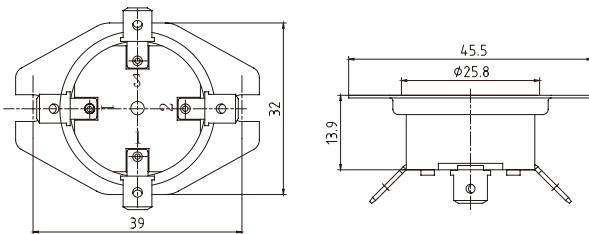

**Material:**  
Bakelite



**A617**

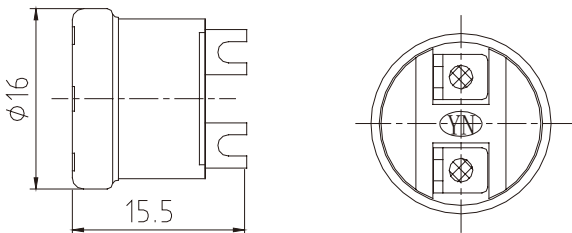

**Material:**  
Bakelite  
Ceramic  
PPS



**A813**

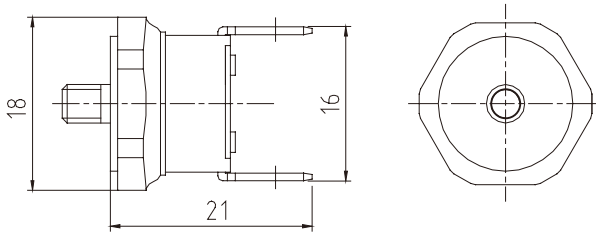

**Material:**  
Bakelite  
Ceramic  
PPS





**A813R**

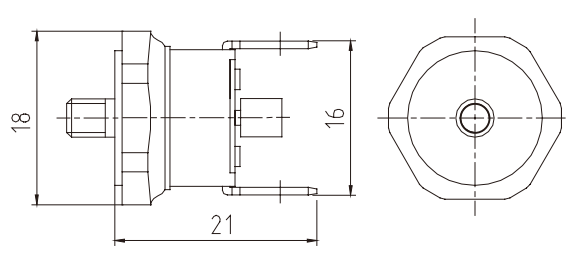

**Material:**  
Bakelite  
Ceramic  
PPS



**PTC**

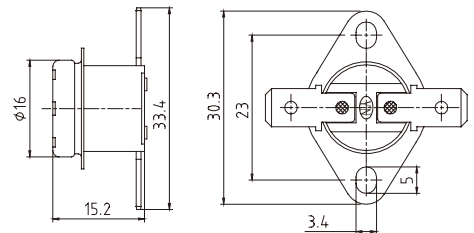

**Material:**  
Bakelite



**A2-002R**

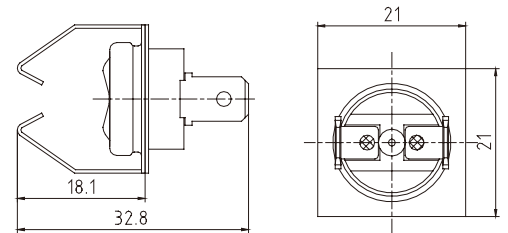

**Material:**  
Bakelite  
Ceramic



**A2-003**

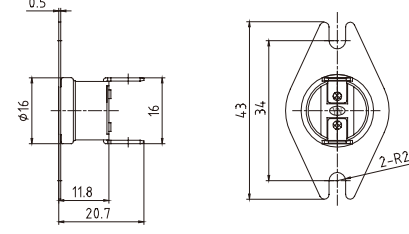

**Material:**  
Bakelite  
Ceramic  
PPS



**A2-007C**

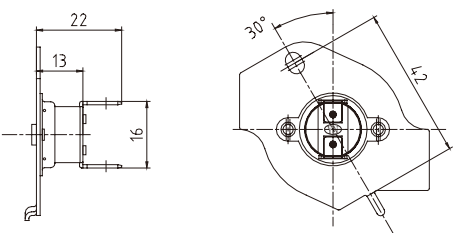

**Material:**  
Bakelite  
Ceramic

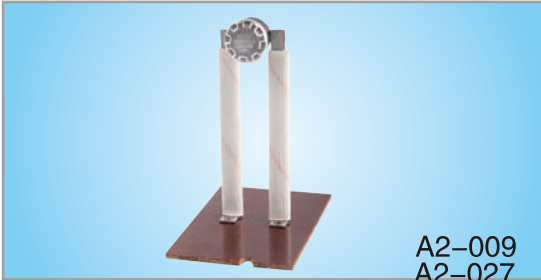

A2-009  
A2-027

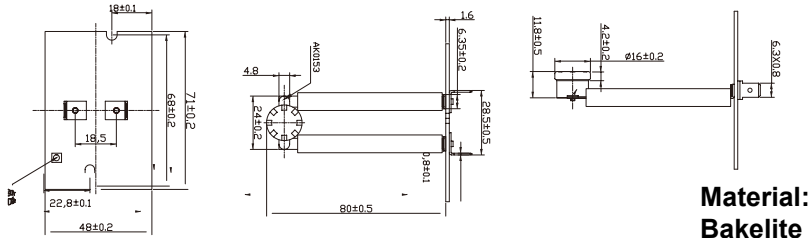

**Material:**  
Bakelite



A2-010

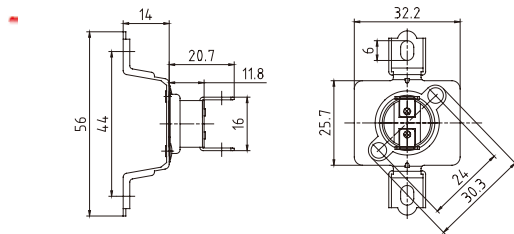

**Material:**  
Bakelite  
Ceramic



A2-018

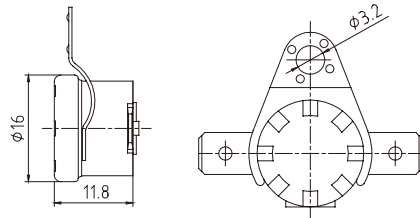

**Material:**  
Bakelite  
Ceramic  
PPS



A2-022B

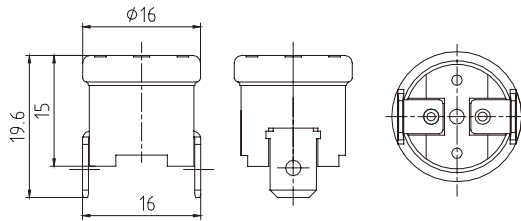

**Material:**  
Bakelite  
Ceramic  
PPS



A2-029

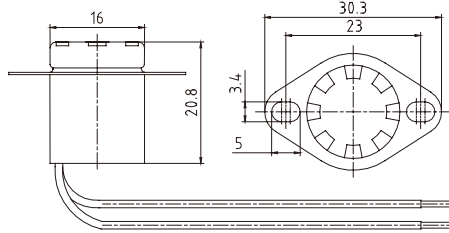

**Material:**  
Bakelite  
PPS





A2-030

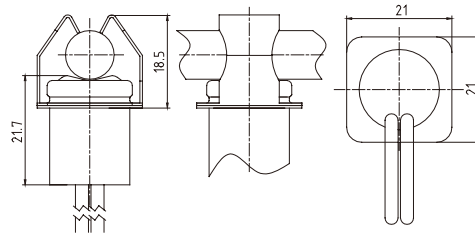

**Material:**  
Bakelite  
PPS

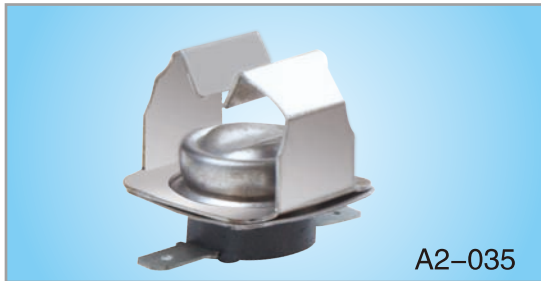

A2-035

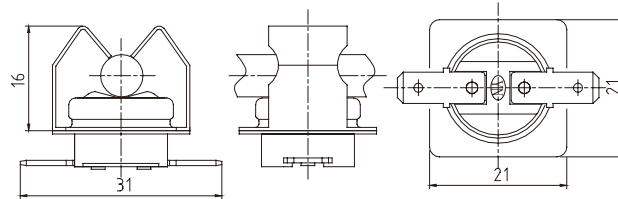

**Material:**  
Bakelite  
Ceramic  
PPS



A2-038A

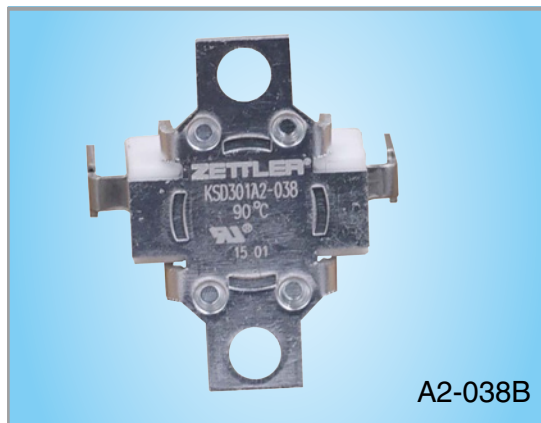
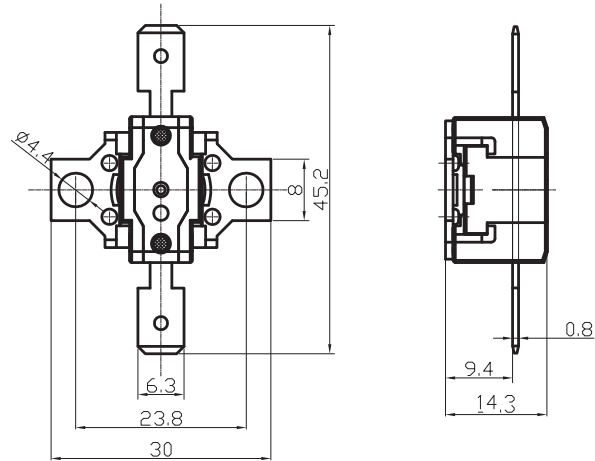

A2-038B

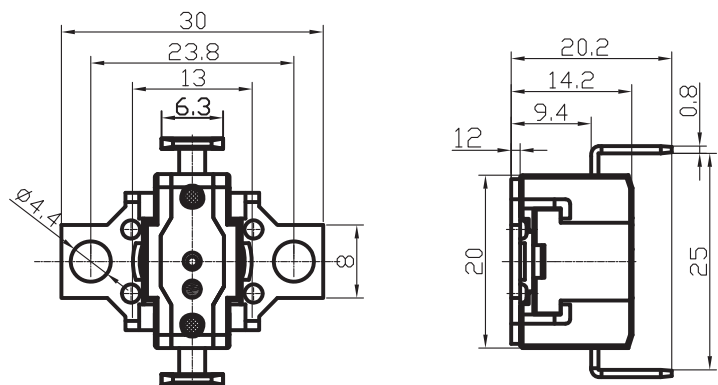

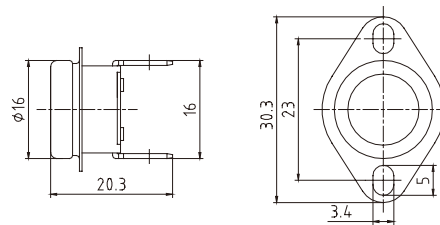
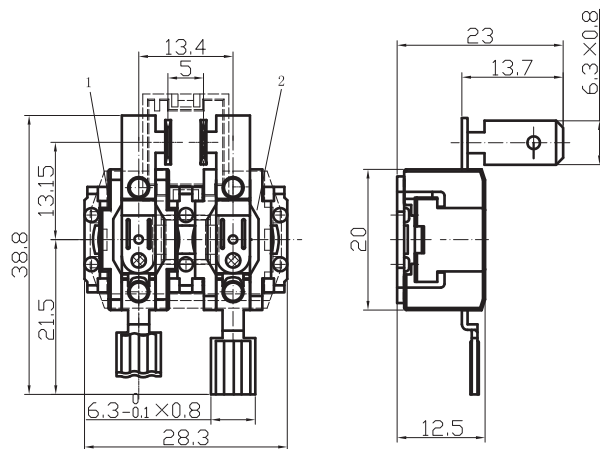
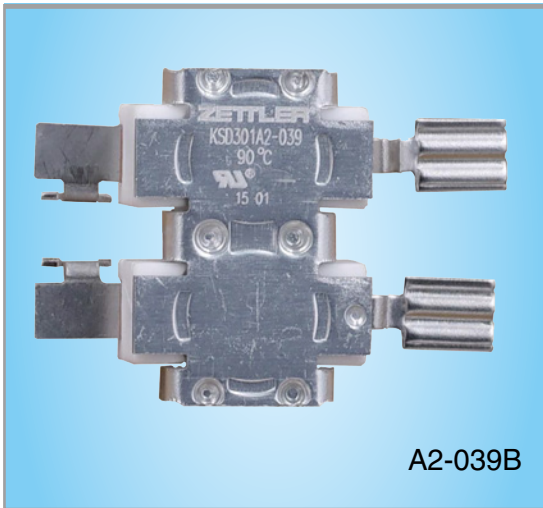
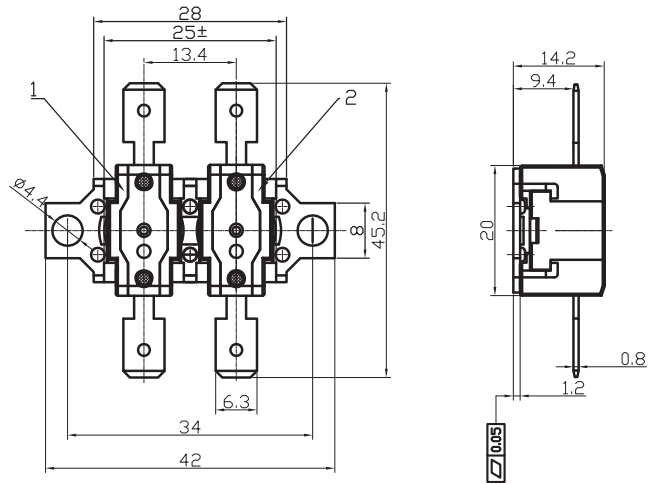

**Material:**  
**Bakelite**  
**Ceramic**  
**PPS**

## KSD301B Series Temperature Controls

### Specifications







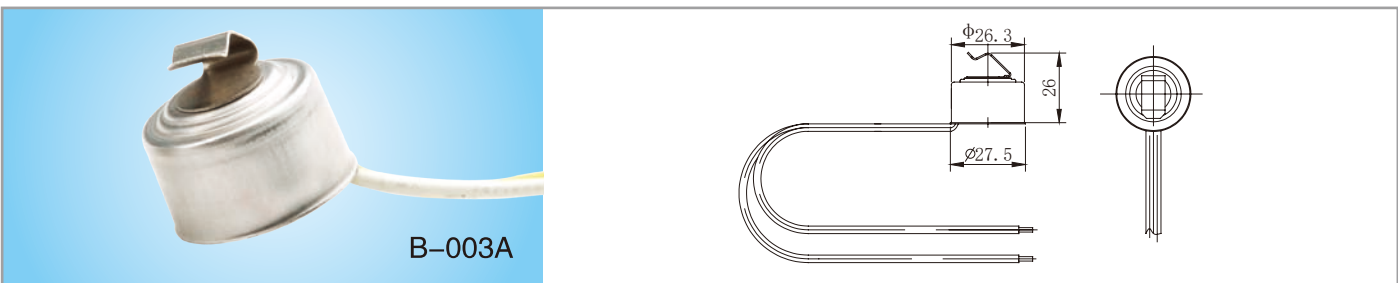
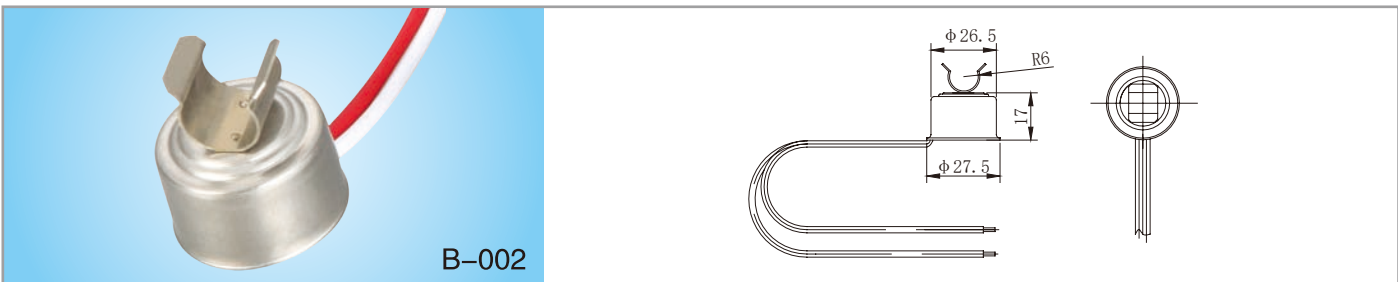

1. Electrical Ratings: AC120V/240V/277V 5A 15A, AC250V 10A 16A 25A
2. OFF Temperature Range -30°C ~ 105°C (-22°F~ 221°F)
3. Diff Temp: Min 5°C ; Standard 15~25°C
4. Tolerance: Min ± 3°C Standard ± 5°C
5. A variety of terminal, switch case and mounting configurations are available for maximum design flexibility
6. NOTE: Please contact us to discuss specific custom requirements

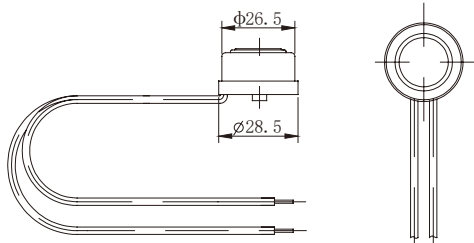
### Applications:

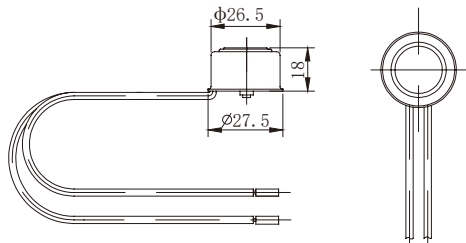
Refrigerator, Air-Conditioning, Ice maker, Freezer, etc.

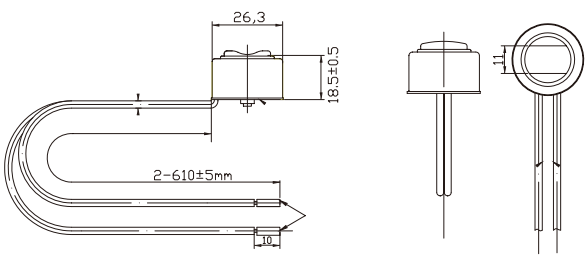
**Approvals: UL CQC TUV VDE CUL CE**

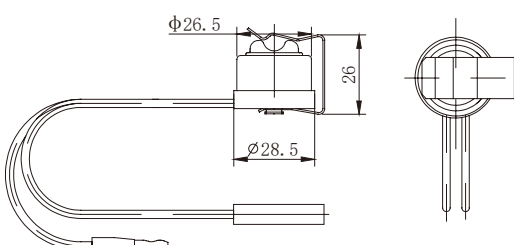

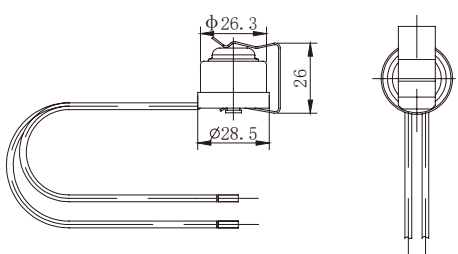

 <p>B-004</p>	
 <p>B-006</p>	
 <p>B-006B (φ 16)</p>	
 <p>B-007</p>	
 <p>B-008</p>	





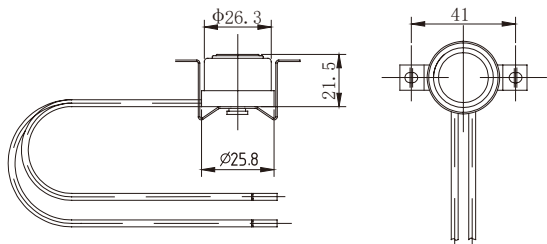

**B-010**





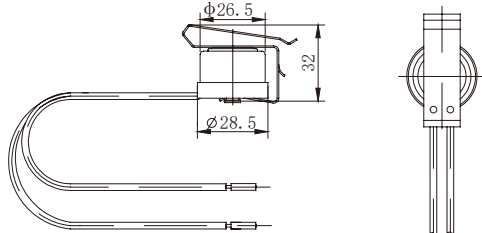

**B-012**





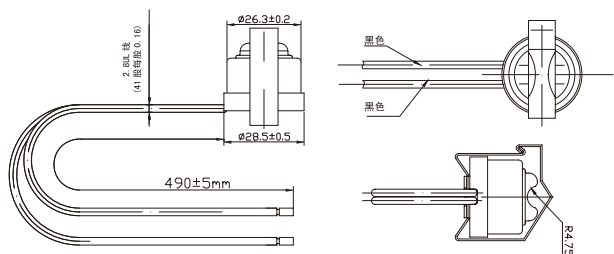

**B-017**



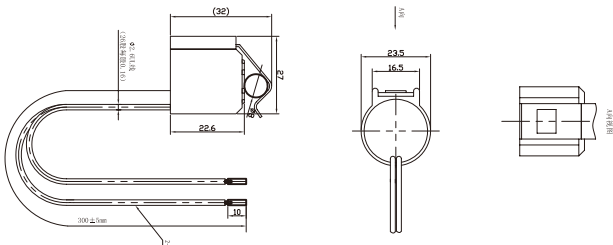

**B-018**





**B-019**

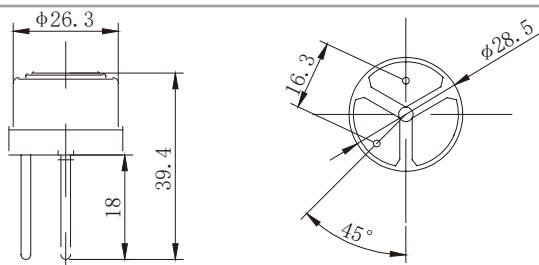



B-022

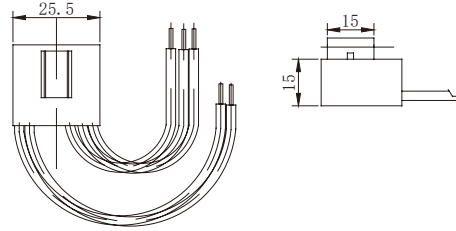

B-023

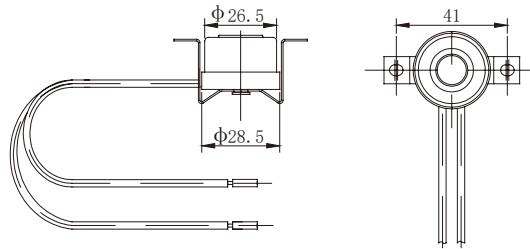

B-024

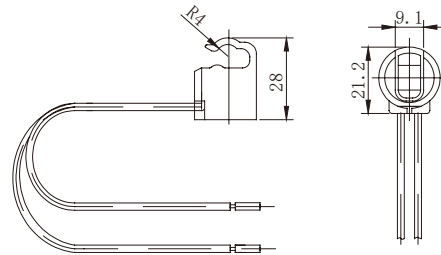

B-025

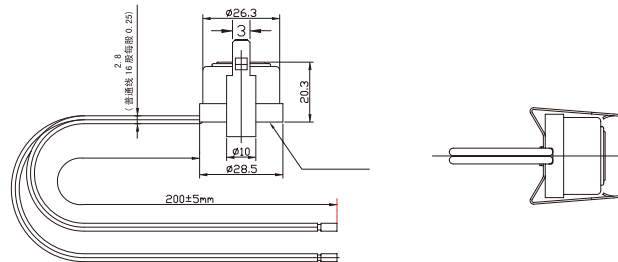

B-301

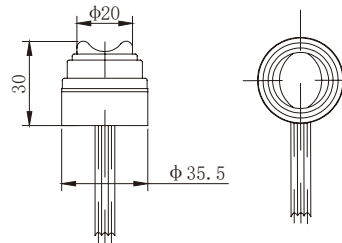



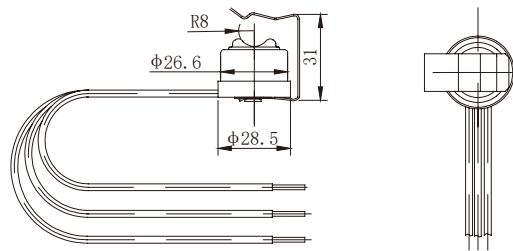
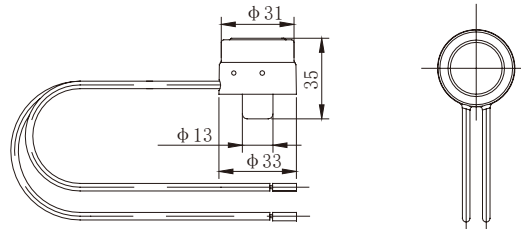
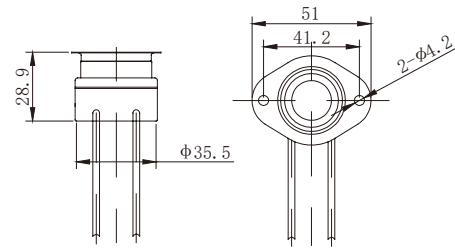
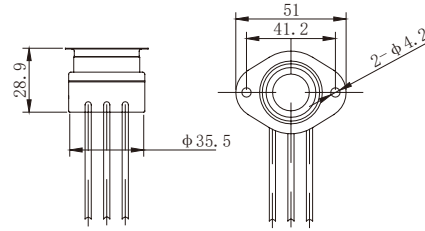
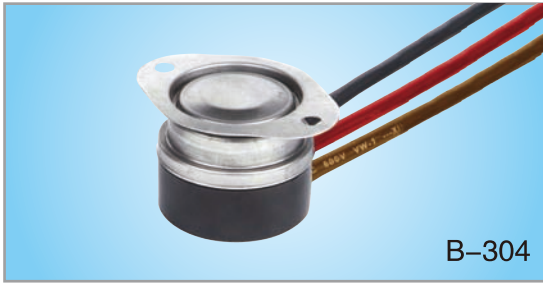

## KSD301C 3/4" (19mm) Series Temperature Controls

### Specifications

Similar to TOD Series 60T

1. Electrical Ratings: AC125V 5A 15A, AC250V 5A 10A 16A
2. OFF Temperature Range:
3. Bakelite: Automatic -30°C ~ 150°C; 30°C ~ 150°C
4. Tolerance: Automatic: Min ± 3°C Standard ± 5°C, Manual: Min ± 4°C Standard ± 5°C
5. A variety of mounting flanges are available to meet the insulation requirements.

### Applications:

Air Conditioners, heating and ventilating equipment, vending machines, dryers, unit heaters, tabletop appliances, etc.

**Approvals: UL CQC TUV VDE CUL**



C-001R

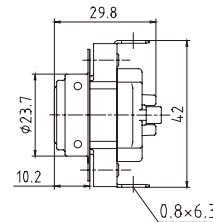
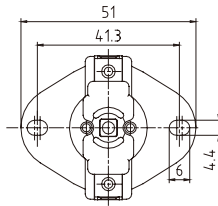

**Material:**  
a. Bakelite  
**Load:**  
250V / 25A  
**Switch Action:**  
SPST



C-002

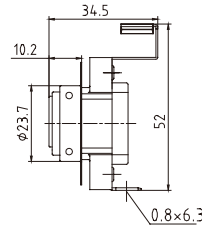
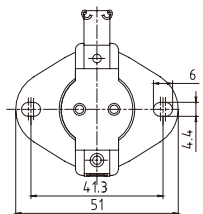

**Material:**  
a. Bakelite  
**Load:**  
250V / 25A 600V / 15A  
**Switch Action:**  
SPST



C-003

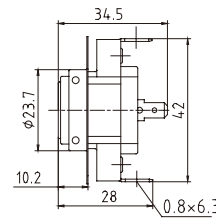
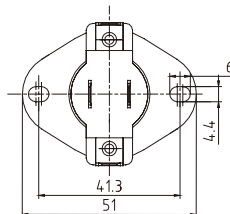

**Material:**  
a. Bakelite  
**Load:**  
250V / 25A 600V / 15A  
**Switch Action:**  
SPST



C-004

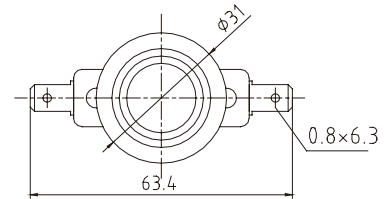
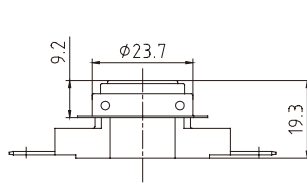

**Material:** a. Bakelite **Load:** 250V / 25A 600V / 15A **Switch Action:** SPST



C-004A

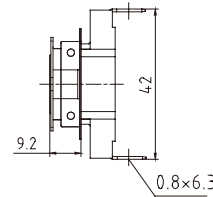
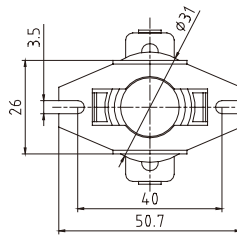

**Material:**  
a. Bakelite  
**Load:**  
250V / 25A  
**Switch Action:**  
SPST



C-005

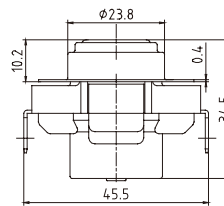
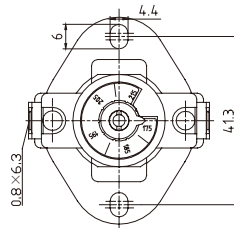

**Material:**  
a. Bakelite  
**Load:**  
250V / 25A  
**Switch Action:**  
SPST



C-007

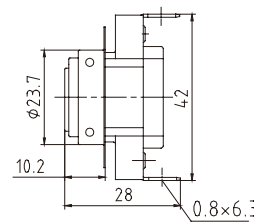
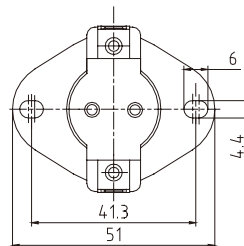

**Material:**  
a. Bakelite  
**Load:**  
250V / 25A 600V / 15A  
**Switch Action:**  
SPST



C-007S

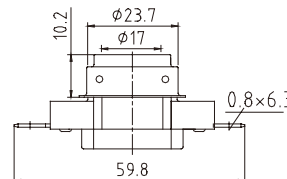
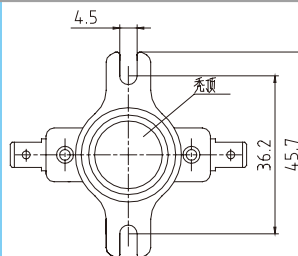

**Material:**  
a. Bakelite  
**Load:**  
250V / 25A 600V / 15A  
**Switch Action:**  
SPST

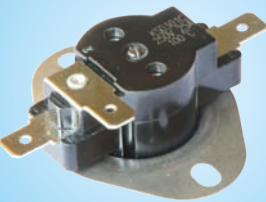
**C-008**

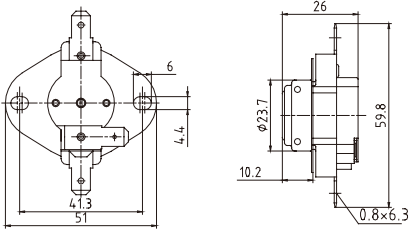

**Material:**  
a. Bakelite

**Load:**  
250V / 25A 600V / 15A

**Switch Action:**  
SPDT



**C-008B**      **C-008C**

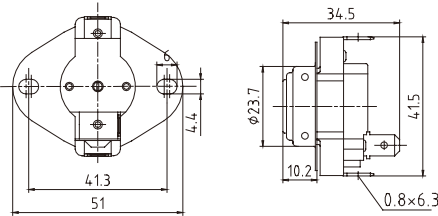

**Material:**  
a. Bakelite

**Load:**  
250V / 25A 600V / 15A

**Switch Action:**  
SPDT



**C-009**      **C-009B**

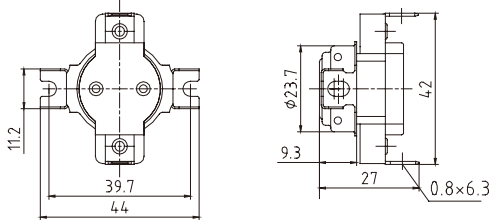

**Material:**  
a. Bakelite

**Load:**  
250V / 25A 600V / 15A

**Switch Action:**  
SPST



**C-011**

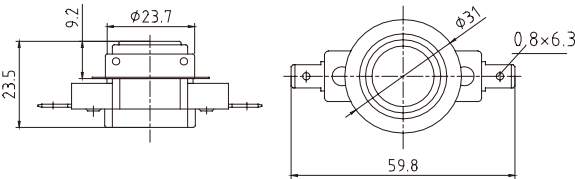

**Material:**  
a. Bakelite, b. Ceramic

**Load:**  
250V / 25A 600V / 15A

**Switch Action:**  
SPST



**C-013R**      **C-013**

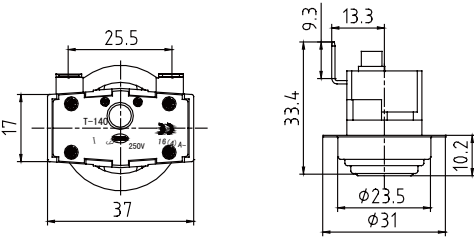

**Material:**  
a. Bakelite

**Load:**  
250V / 25A

**Switch Action:**  
SPST



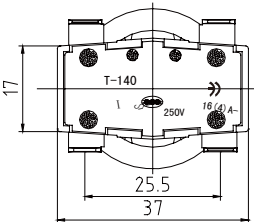
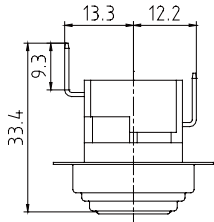

**C-014(4Pin)**

**Material:**  
a. Bakelite

**Load:**  
250V / 16A

**Switch Action:**  
SPST DPST

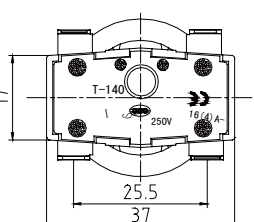
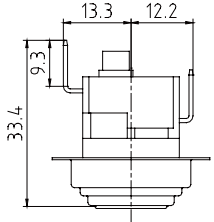

**C-014R(4Pin)**

**Material:**  
a. Bakelite

**Load:**  
250V / 16A

**Switch Action:**  
SPST DPST

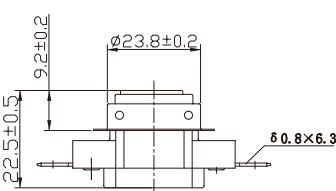
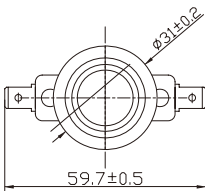

**C-017**

**Material:**  
a. Bakelite b. Ceramic

**Load:**  
250V / 25A 600V / 15A

**Switch Action:**  
SPST

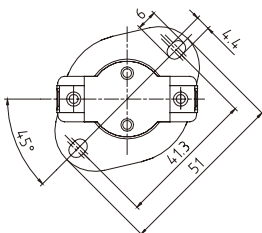
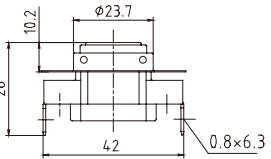

**C-018**

**Material:**  
a. Bakelite b. Ceramic

**Load:**  
250V / 25A 600V / 15A

**Switch Action:**  
SPST

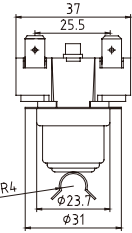
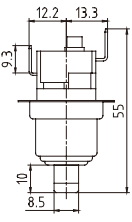

**C-021R**

**Material:**  
a. Bakelite

**Load:**  
250V / 16A

**Switch Action:**  
SPST DPST







**C-022**

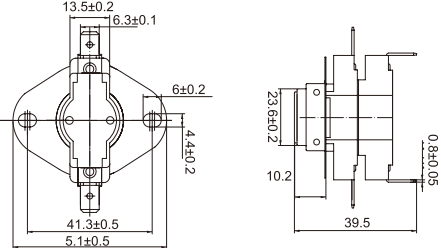

**Material:**  
a. Bakelite

**Load:**  
250V / 25A

**Switch Action:**  
DPST 2SPST



**C-022R**

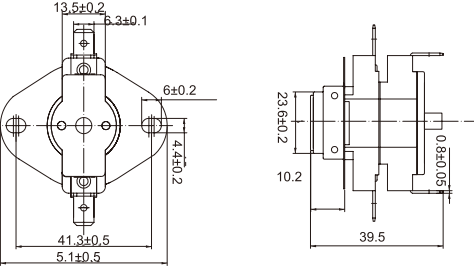

**Material:**  
a. Bakelite

**Load:**  
250V / 25A

**Switch Action:**  
DPST 2SPST



**C-023R**

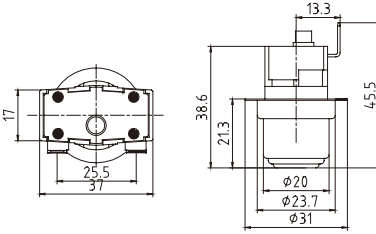

**Material:**  
a. Bakelite

**Load:**  
250V / 16A

**Switch Action:**  
SPST



**C-025**

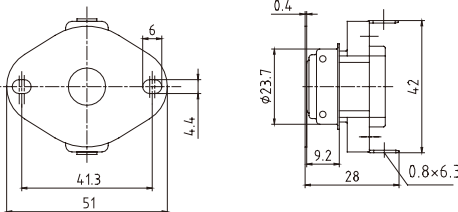

**Material:**  
a. Bakelite b. Ceramic

**Load:**  
250V / 25A 600V / 15A

**Switch Action:**  
SPST



**C-027**

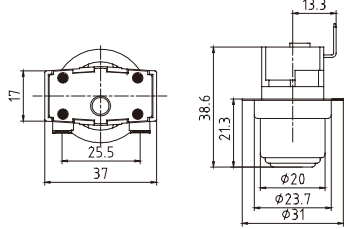

**Material:**  
a. Bakelite

**Load:**  
250V / 16A

**Switch Action:**  
SPST

**Terminal:**  
Nickell plated Brass







**C-301**

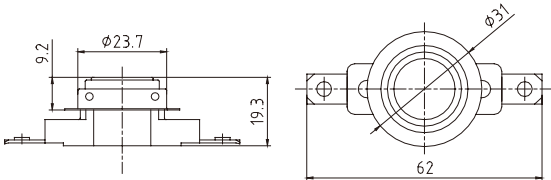

**Material:**  
a. Bakelite

**Load:**  
250V / 45A

**Switch Action:**  
SPST



**C-301R**

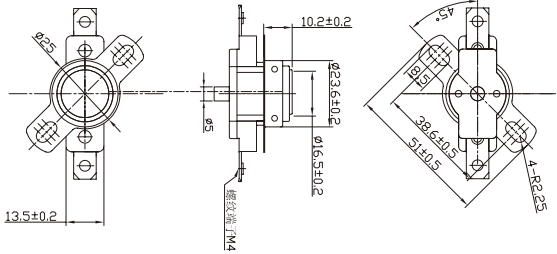

**Material:**  
a. Bakelite

**Load:**  
250V / 45A

**Switch Action:**  
SPST



**C-302**

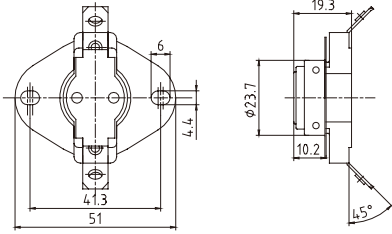

**Material:**  
a. Bakelite

**Load:**  
250V / 45A

**Switch Action:**  
SPST



**C-305**

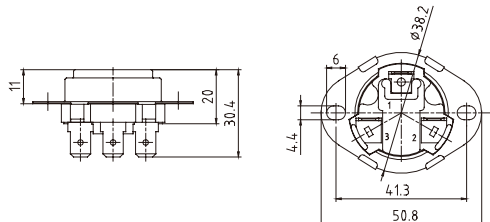

**Material:**  
a. Bakelite

**Load:**  
250V / 25A

**Switch Action:**  
SPST

## KSD301C Heat Sequencers - Time Delays

### Features

Controls the delayed operation of heating elements or fans in electric furnaces and heat pumps

Combines a solid-state positive temperature coefficient (PTC) heater, Option of single, double, or three independent timing contacts.

UL and CUL approval

### Applications

Electric Furnaces, Heat Pumps, Gas Furnaces, etc.

### Approvals: UL CUL

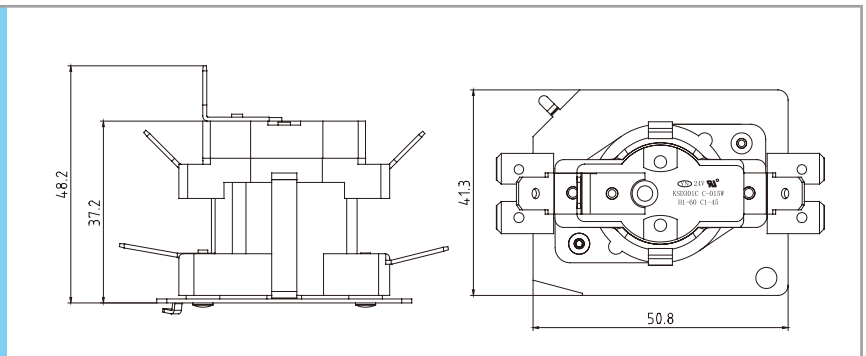
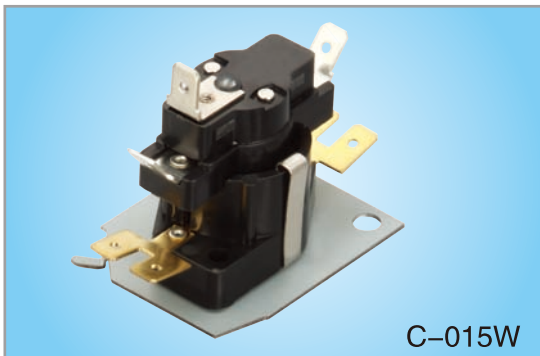
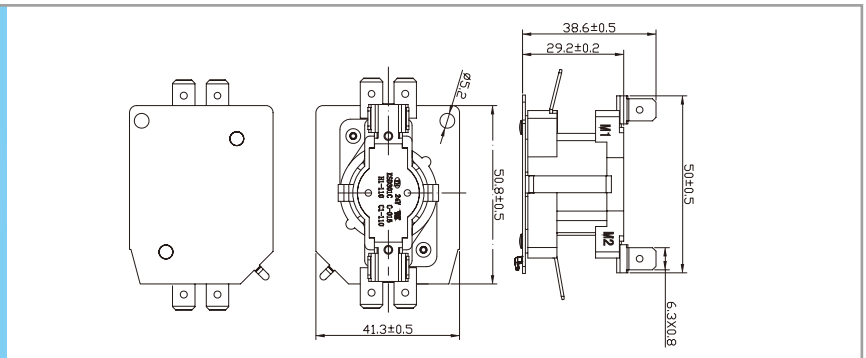
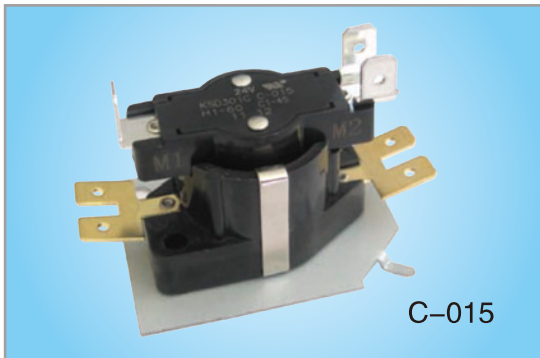

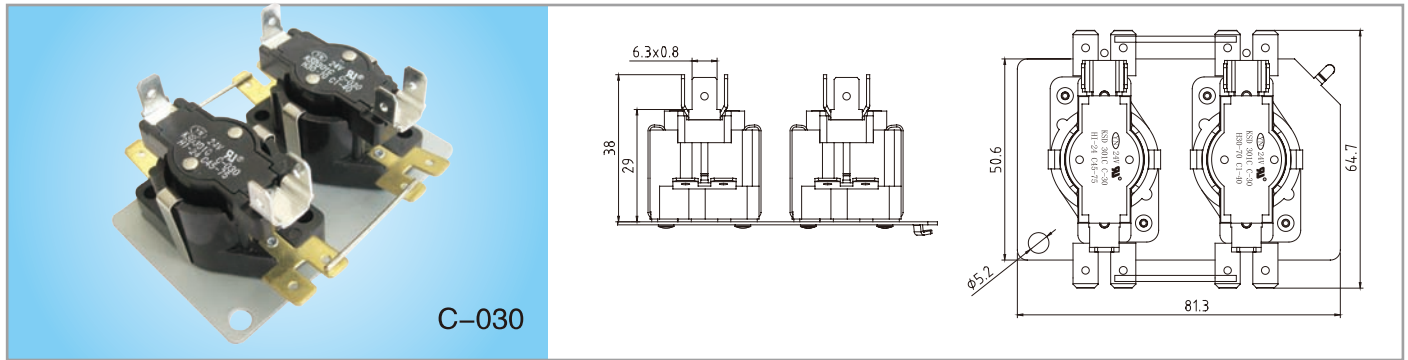
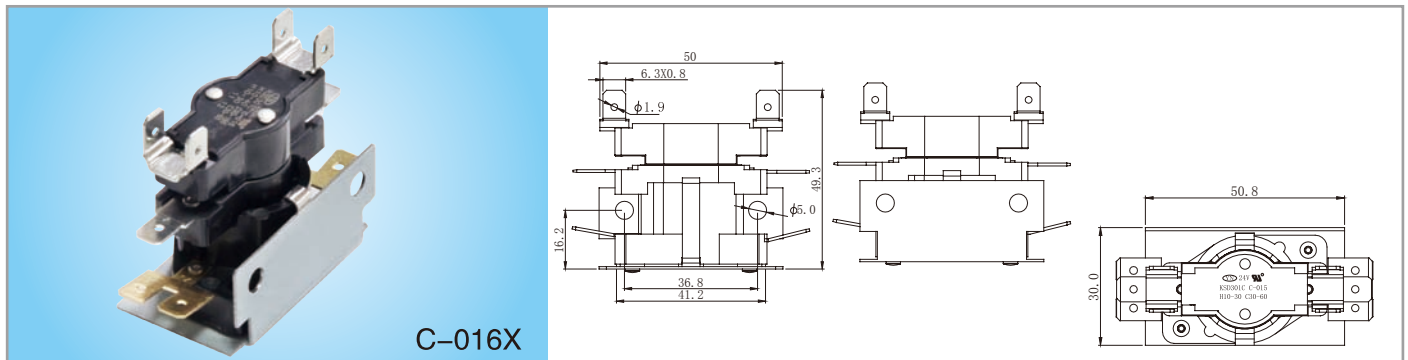
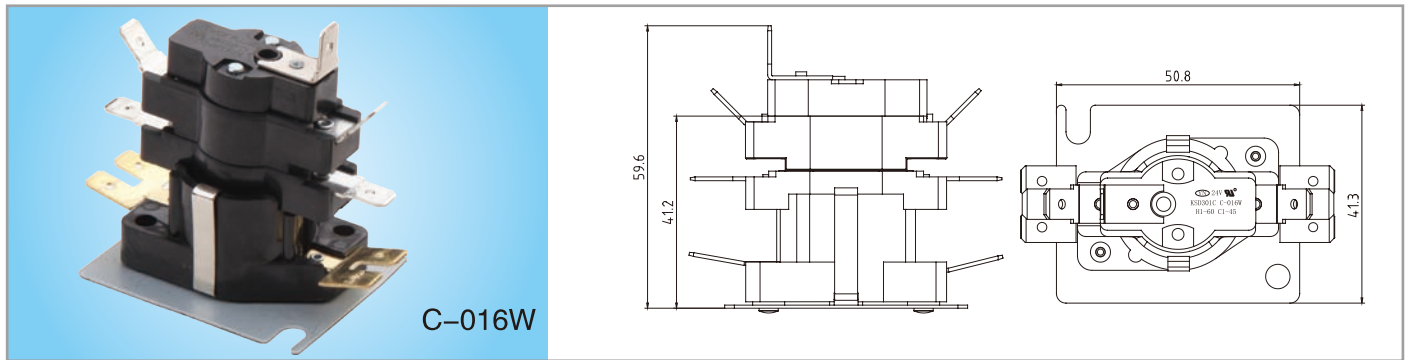
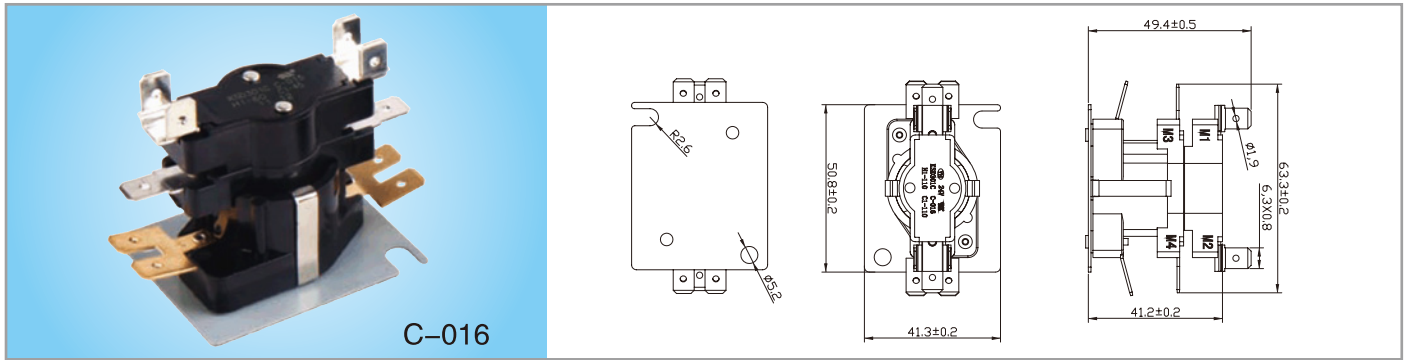

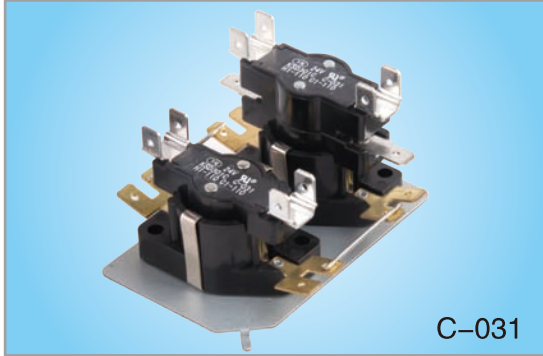

C-031

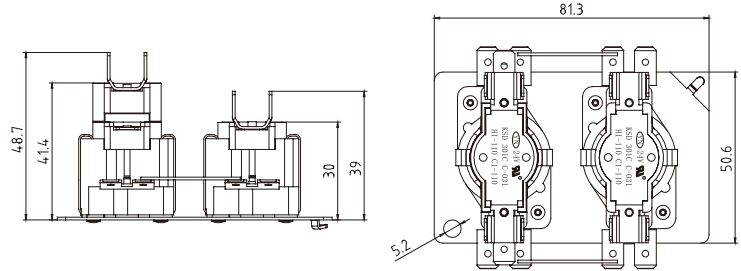

C-032

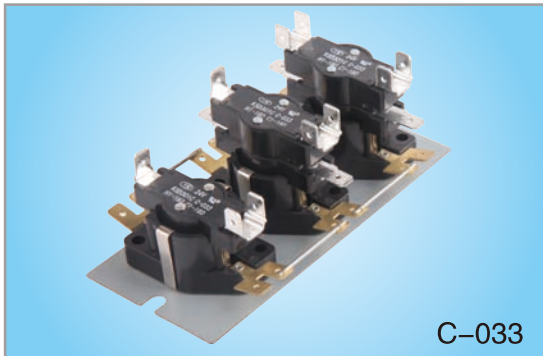
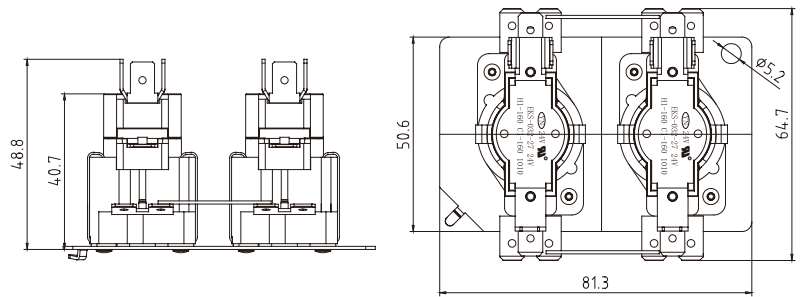

C-033

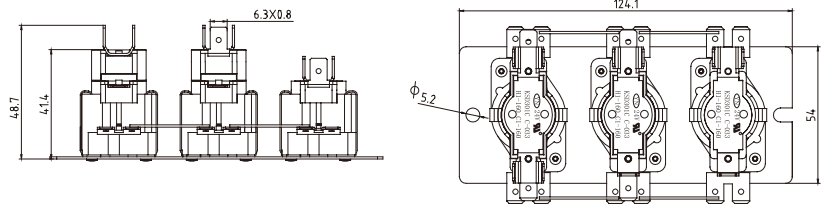

## KSD301C Series Temperature Sensing Controls





UNIVERSAL REPLACEMENTS FOR ELECTRIC WATER HEATER THERMOSTATS

Panel Mount Temperature Sensing Controls

### Features

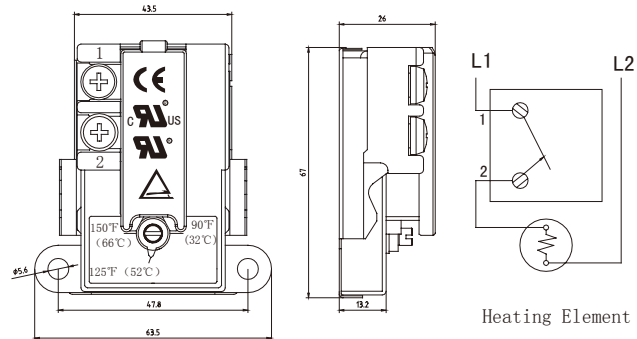
1. High Electrical capacity
2. Snap-Action cont
3. Long life-proven reliability
4. Adjustable control or manual reset sty

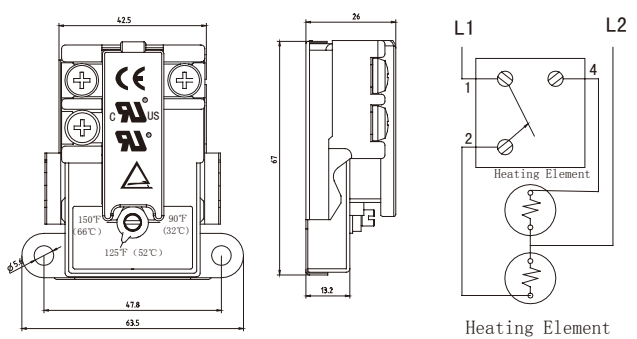
**Approval: UL TUV CUL CE**

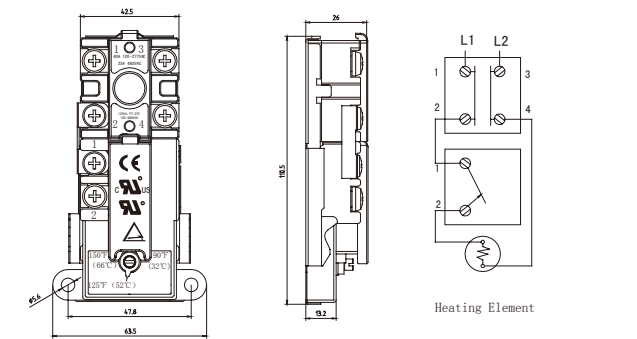
 <p style="text-align: right;"><b>C-200</b></p>	 <p style="text-align: right;">Heating Element</p>
 <p style="text-align: right;"><b>C-201</b></p>	 <p style="text-align: right;">Heating Element</p>
 <p style="text-align: right;"><b>C-202</b></p>	 <p style="text-align: right;">Heating Element</p>



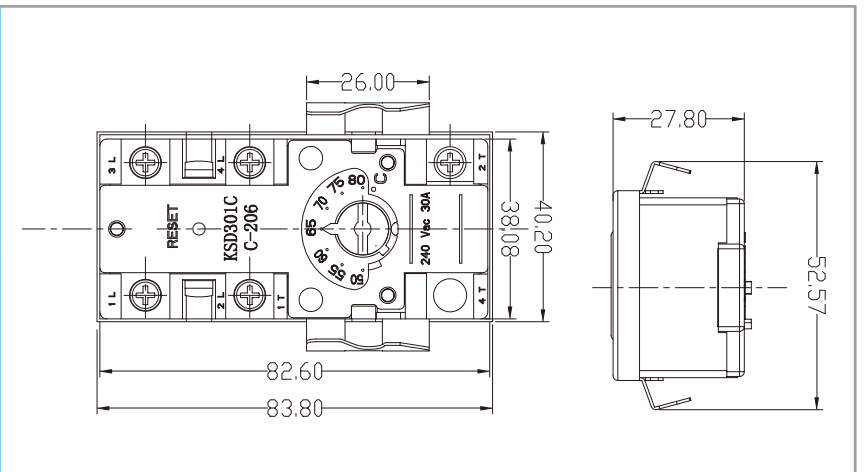
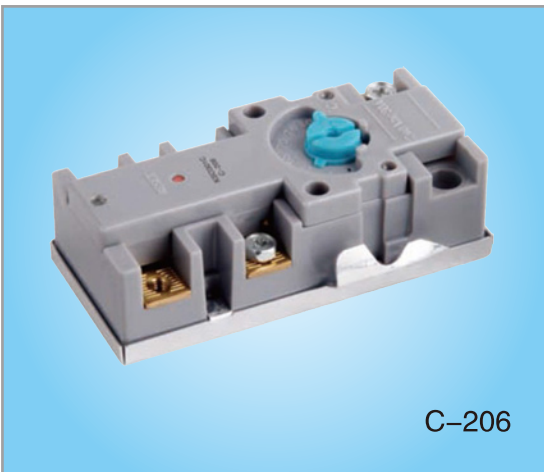
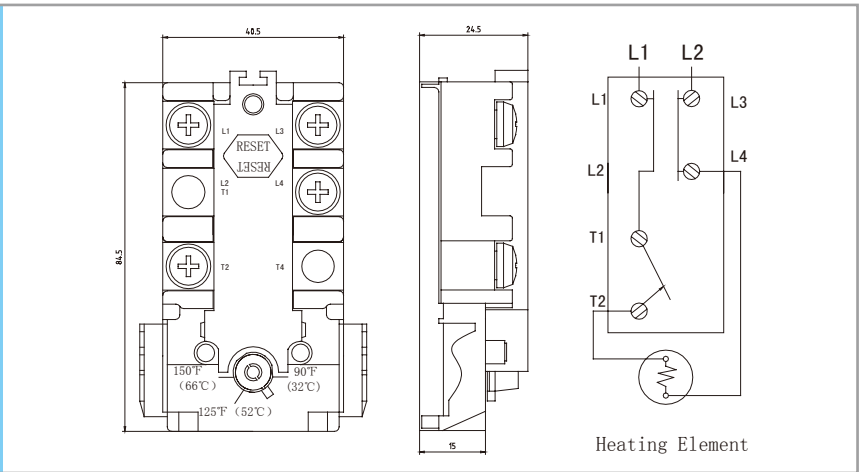
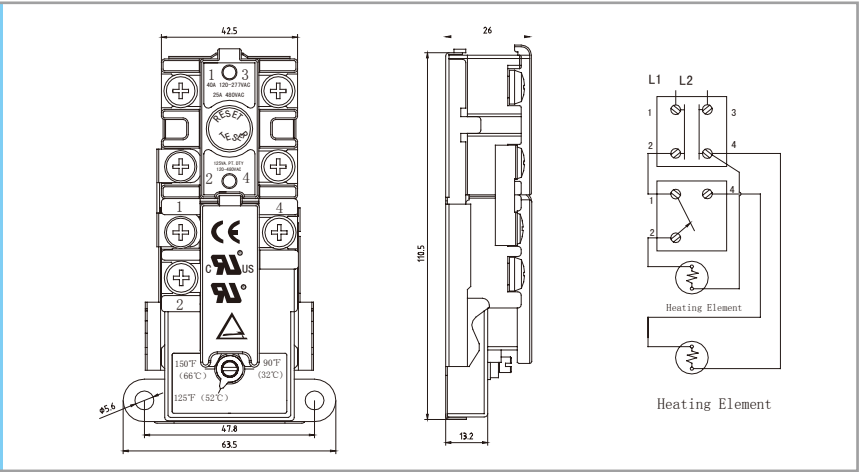





C-207

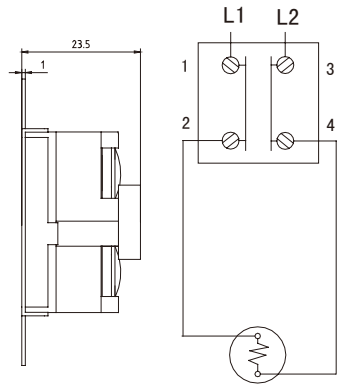
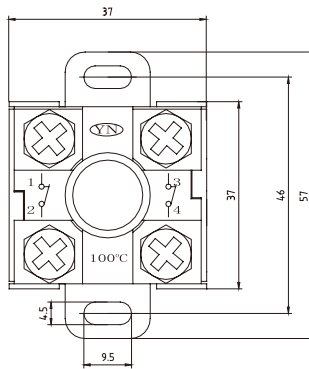

Heating Element



C-207C

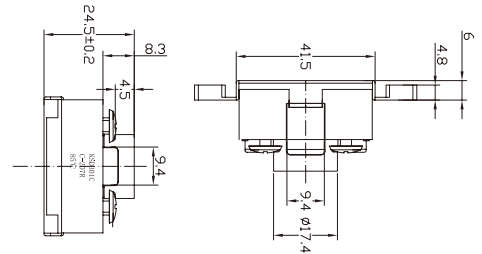
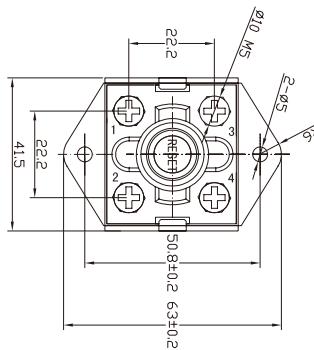

C-207R

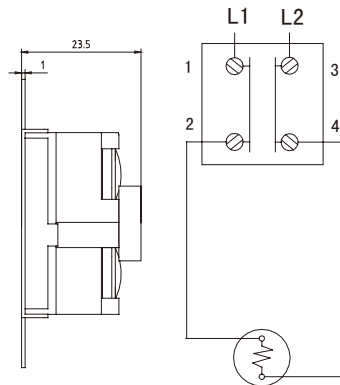
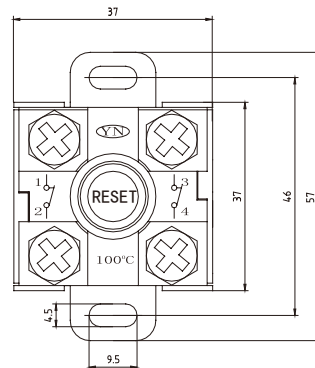

Heating Element

