

High-Performance Taps

Beyond High-Performance Solid Carbide Taps	L2-L29
Tool Selection Guide	L4-L5
Taps	L10-L21
Application Data	L22
Cross Reference Charts • Taps and Drills	L24-L29
High-Performance HSS-E-PM Taps	L30-L79
Tool Selection Guide	L32-L33
Taps	L36-L57
Wind Energy Taps	L58-L63
Application Data	L64
Cross Reference Charts	L66-L79
High-Performance Solid Carbide Thread Mills	L80-L97
Solid Thread Mills Selection Guide	L82
Thread Mills	L86-L90
Application Data	L91-L92
CNC Programming	L93-L97
Taps and Thread Milling Technical Information	L98-L114
Informational Icons	L115-L116





Beyond™ High-Performance Solid Carbide Taps

Primary Application

Solid carbide taps offer higher productivity and outstanding performance in a wider range of materials than formerly possible. Get more production from a single tool and superior accuracy of product thread that surpasses the competition. Kennametal High-Performance Solid Carbide Taps are available in various specifications with enhanced precision and design, which translates into longer tool life, excellent performance, and exceptional wear resistance.

- High performance to surpass competitive taps.
- More production from a single tool.
- Available in various specifications.

Features and Benefits

Advanced Technology

- Manufactured with micrograin carbide for exceptional wear life.
- Ideal for long production runs where fewer tool changes equate to greater productivity.
- Designed for outstanding tool life in steel, cast iron, aluminium, and hardened materials.
- Runs 4x faster and lasts 4x longer than conventional taps.
- Tap runout less than 10 microns (.0004").
- PVD nanolayer TiAlN/TiN coated carbide grade.

Customisation

- Engineered solutions available upon request.
- Available in various specifications.

Application Information

- Maximum chip control and free cutting in through holes.
- For use on CNC machines with synchronous or rigid tapping control and precision toolholders.
- Straight-flute taps for sizes M4 and larger for ductile or cast iron.
- Can be factory reconditioned to original specifications and tolerances.



Optimised flute design
Better chip evacuation.

Carbide substrate
Higher heat resistance,
higher speed.

Chamfer design
Helps chip load,
lower torque.



Application-specific coatings
Extremely high wear resistance,
longer tool life.

Cylindrical h6 shank
Low runout, higher
quality threads.

To learn more, [scan here](#).
For instructions on how to scan, please see page xxix.



Beyond™ Series HP Solid Carbide Taps and Solid Carbide Forming Taps • Metric

● first choice
○ alternate choice

Beyond HP Solid Carbide Taps	series	grade	shank/dimension	P	M	K	N	S	H
	T320	KC7542	6535 HA	●	○				
	T321	KC7542	6535 HA	●	○				
	T331	KC7542	6535 HA	●	○				
	T340	KC7542	6535 HA			●			
	T351	KC7542	6535 HA			●			
	T410	KCU36	DIN 371, 374, 376 HA						●
	T461	KC7512	6535				●		
	T471	KC7512	6535 HA				●		

Beyond HP Solid Carbide Forming Taps

Taps

	T381	KC7542	6535 HA	●					
	T391	KC7542	6535 HA	●					
	T481	KC7512	6535 HA				●		
	T491	KC7512	6535 HA				●		

* Through coolant 1/4" and larger.

size range (inch and metric)	through hole	blind hole	chamfer form	helix angle	external coolant	internal coolant	page(s)	recommended cutting parameters
M6-M16							L10	L22
M6-M16							L11	L22
M6-M16							L12	L22
M4-M20							L13	L22
M4*-M16							L14	L22
M3-M16							L17	L22
M6-M16							L18	L22
M6-M16							L19	L22
M4*-M10							L15	L22
M4*-M10							L16	L22
M4*-M12							L20	L22
M4*-M12							L21	L22



Carbide Tap Identification System

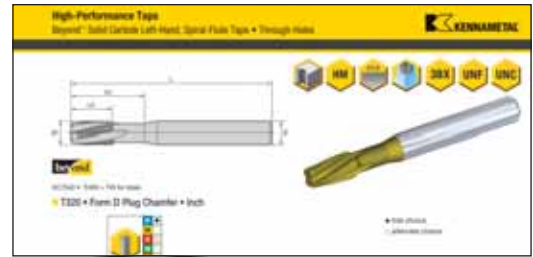

T320MF120X150R6HX
T320NC06250-11R3BX

Metric

T320 **MF** **120** **X** **150** **R** **6HX**

Inch

T320 **NC** **06250** **-** **11** **R** **3BX**

Tap Design

Type of Thread

Nominal Diameter of Thread

-

Pitch

Cutting Direction

Tolerance Class

mm or inch
(depending on type)

mm or TPI
(depending on type)

- M** = Metric coarse-pitch thread (ISO form)
- MF** = Metric fine-pitch thread (ISO form)
- NC** = Unified coarse series thread
- NF** = Unified fine series thread

Style

- T320** = Steel, through holes, LHSF
- T321** = Steel, through holes, LHSF coolant
- T331** = Steel, blind holes, RHSF coolant
- T340** = Cast iron and cast aluminium, through holes, STFL
- T351** = Cast iron and cast aluminium, blind holes, STFL coolant
- T381** = Steel, through holes, forming FT, coolant
- T391** = Steel, blind holes, forming FT, coolant
- T410** = Hard materials, up to 63 HRC
- T461** = Aluminium, through holes, STFL, coolant
- T471** = Aluminium, blind holes, STFL, coolant
- T481** = Aluminium, through holes, forming FT, coolant
- T491** = Aluminium, blind holes, forming FT, coolant

Taps



The **SPEED** to **EXCEED**

Solid Carbide Taps

The Kennametal Solid Carbide Taps deliver the accuracy you demand at up to four times the speed of HSS taps. Longer tool life, exceptional thread quality, and an array of sizes for ferrous and non-ferrous materials make our taps the most trusted and productive tools in the industry.

- Reduce your operating costs by up to 65%.
- Workpiece-specific grades: KC7542™ for steels and cast irons, KC7512™ for aluminium.
- Go 4x faster with 4x the service life of conventional HSS offerings.
- Wide array of styles and sizes for through or blind hole applications.

Tap into something great at your Authorised Kennametal Distributor or at www.kennametal.com.

www.kennametal.com

 **KENNAMETAL®**



Through Holes



Blind Holes

		Cutting		Forming		Cutting		Forming	
		Internal Coolant	Flood	Internal Coolant	Flood	Internal Coolant	Flood	Internal Coolant	Flood
P	<32 HRC	T321_KC7542 T621_KP6525	T320_KC7542 T620_KP6525	T381_KC7542 T623_KSP21	T622_KSP21	T331_KC7542 T631_KP6525 T633_KP6525 T651_KP6525	T630_KP6525 T630_KP6505 T632_KP6525 T650_KP6525	T391_KC7542 T623_KSP21	T622_KSP21
	32-44 HRC	—	T600_KSP2	—	—	—	T602_KSP21 T604_KSH26	—	—
M		T621_KM6515	T620_KM6515	—	—	T631_KM6515	T630_KM6515	—	—
K		T641_KP6525	T340_KC7542 T640_KP6525	—	—	T351_KC7542 T641_KP6525 T643_KP6525	T640_KP6525 T642_KP6525	—	—
N	Wrought, Low Si	—	T670_KSN38	T481_KC7512 T623_KSN28	T622_KSN28	—	T680_KSN38	T491_KC7512 T623_KSN28	T622_KSN28
	Cast, Si<12%	T461_KC7512 T641_KP6525	T640_KP6525	T481_KC7512 T623_KSN28	T622_KSN28	T471_KC7512 T641_KP6525 T643_KP6525	T640_KP6525 T642_KP6525	T491_KC7512 T623_KSN28	T622_KSN28
S	Titanium Alloys	—	T614_KSN25	—	—	—	T616_KSN25	—	—
	Ni and Co Alloys	—	T610_KSSH22	—	—	—	T612_KSSH22	—	—
H	44-55 HRC	—	T606_KSSH22	—	—	—	T606_KSSH22	—	—
	55-63 HRC	—	T410_KCU36	—	—	—	T410_KCU36	—	—

Solid Carbide = **bold**
HSS-E-PM = regular

Taps

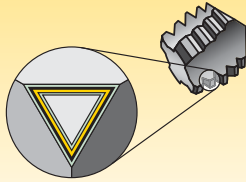

Coatings provide high-speed capability and are engineered for finishing to light roughing.

P	Steel
M	Stainless Steel
K	Cast Iron
N	Non-Ferrous Materials
S	High-Temp Alloys
H	Hardened Materials

wear resistance ← → toughness

NEW!

Taps

Coating	Grade Description	Performance Chart									
		05	10	15	20	25	30	35	40	45	
KC7542	Coated carbide. PVD — multilayer coating with TiAlN and TiN over a high-strength carbide substrate specifically designed for tap application. Use in steel up to 32 HRC and cast iron at four times faster speeds than HSS-E-PM taps.	P									
KC7512	Coated carbide. PVD — two-layer coating over fine-grain carbide. Coating consists of low friction Cr/C over wear-resistant TiN. Cr/C resists galling of non-ferrous materials to the tap. Provides superior performance for tapping cast aluminium and other non-ferrous materials.	N									
KCU36	Coated carbide. PVD — two-layer coating with heat-resistant TiAlN base layer and low-friction MoS ₂ top layer over carbide substrate. Use in hardened steel 55–63 HRC.	H									
KP6525	Coated HSS-E-PM. PVD — heat- and wear-resistant high vanadium — cobalt powder metal HSS substrate coated with wear-resistant TiCN base layer and low-friction TiN top layer. Use in steel, cast iron, and cast aluminium with silicon.	K									
KSP21	Coated HSS-E-PM. PVD — powder metal HSS-E substrate with TiN coating. Use for tapping steel 32–44 HRC and for forming threads in steel 32 HRC.	P									
KSH26	Coated HSS-E-PM. PVD — powder metal HSS-E substrate coated with TiN base layer and low-friction MoS ₂ top layer. Use in deep blind steel holes 32–44 HRC.	P									
KM6515	Coated HSS-E-PM. PVD — heat- and wear-resistant high vanadium — cobalt powder metal HSS substrate. Coating consists of low-friction Cr/C over wear-resistant TiN base layer. Use for tapping stainless steel and non-ferrous materials.	M									
KSN28	Coated HSS-E-PM. PVD — powder metal HSS-E substrate with DLC coating. Use for form tapping aluminium. Not recommended for steel.	N									
KSN38	Coated HSS-E. PVD — lower vanadium HSS-E substrate with DLC coating. Use for tapping non-ferrous materials with low cutting temperatures like wrought aluminium. Not recommended for steel.	N									
KSN25	Coated HSS-E-PM. PVD — powder metal HSS-E substrate with two-layer coating. TiN base layer and DLC top layer that resists galling of non-ferrous materials to the tap. Use for tapping titanium. Not recommended for steel.	S									
KSSH22	Coated HSS-E-PM. PVD — heat- and wear-resistant high vanadium — cobalt powder metal HSS substrate with high hardness TiCN coating. Use when tapping heat-treated steel 44–55 HRC and cobalt- or nickel-based heat-resistant alloys.	S									
		H									

High-Performance Taps

Beyond™ Solid Carbide Left-Hand Spiral-Flute Taps • Through Holes

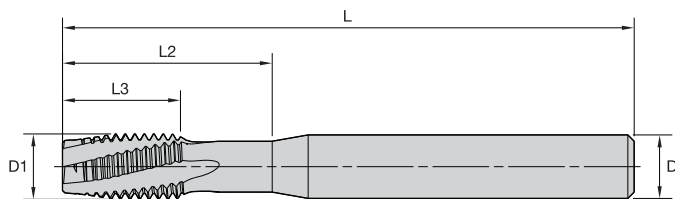

KC7542 TiAIN + TiN for steel.

■ T320 • Form D Plug Chamfer • Metric

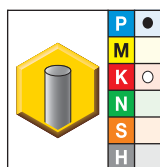

● first choice
○ alternate choice

Taps

KC7542	D1 size	L	L3	L2	D	number of flutes	class of fit
T320M060X100R6HX	M6 x 1	70	12	23	6,0	3	6HX
T320M080X125R6HX	M8 x 1,25	80	15	28	8,0	3	6HX
T320M100X150R6HX	M10 x 1,5	90	18	33	10,0	4	6HX
T320MF120X150R6HX	M12 x 1,5	100	21	40	12,0	4	6HX
T320M120X175R6HX	M12 x 1,75	100	21	40	12,0	4	6HX
T320MF140X150R6HX	M14 x 1,5	110	24	47	12,0	4	6HX
T320M140X200R6HX	M14 x 2	110	24	47	12,0	4	6HX
T320M160X200R6HX	M16 x 2	110	24	53	14,0	4	6HX

NOTE: Proprietary technology.

Shank Tolerance

D	tolerance h6
6	+0, -0,008
8-10	+0, -0,009
12-16	+0, -0,011

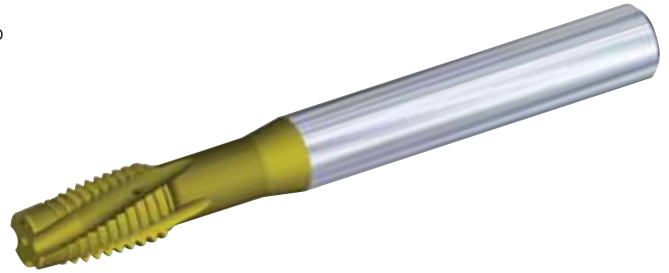
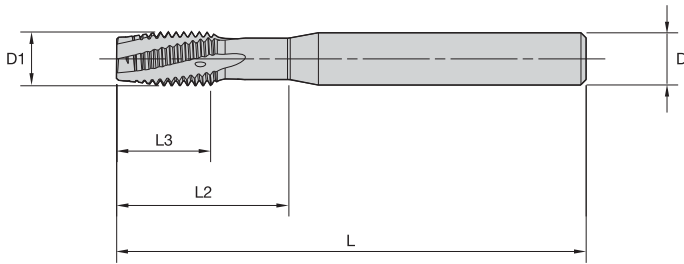

KC7542 TiAlN + TiN for steel.

■ T321 • Form D Plug Chamfer • Through Coolant • Metric

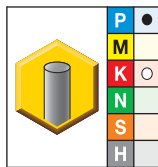

- first choice
- alternate choice

KC7542	D1 size	L	L3	L2	D	number of flutes	class of fit
T321M100X150R6HX	M10 x 1,5	90	18	33	10,0	4	6HX
T321MF120X150R6HX	M12 x 1,5	100	21	40	12,0	4	6HX
T321M120X175R6HX	M12 x 1,75	100	21	40	12,0	4	6HX
T321MF140X150R6HX	M14 x 1,5	110	24	47	12,0	4	6HX
T321M140X200R6HX	M14 x 2	110	24	47	12,0	4	6HX
T321M160X200R6HX	M16 x 2	110	24	53	14,0	4	6HX

NOTE: Proprietary technology.

Shank Tolerance

D	tolerance h6
6	+0, -0,008
8-10	+0, -0,009
12-16	+0, -0,011



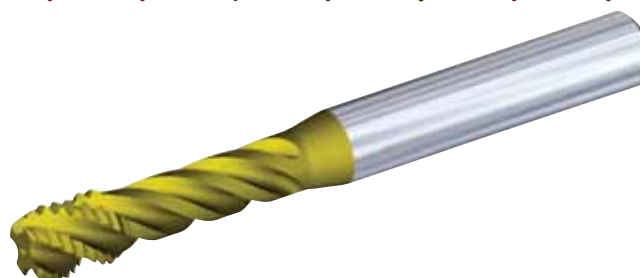
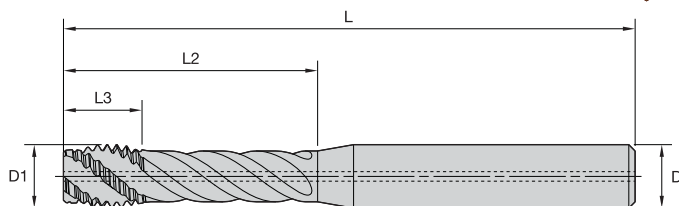

KC7542 TiAlN + TiN for steel.

■ T331 • Form C Semi-Bottoming Chamfer • Through Coolant • Metric

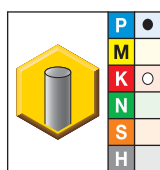

- first choice
- alternate choice

Taps

KC7542	D1 size	L	L3	L2	D	number of flutes	class of fit
T331M060X100R6HX	M6 x 1	70	8	24	6,0	3	6HX
T331M080X125R6HX	M8 x 1,25	80	10	32	8,0	3	6HX
T331MF100X100R6HX	M10 x 1	90	12	40	10,0	4	6HX
T331M100X150R6HX	M10 x 1,5	90	12	40	10,0	4	6HX
T331MF120X150R6HX	M12 x 1,5	100	14	48	12,0	4	6HX
T331M120X175R6HX	M12 x 1,75	100	14	48	12,0	4	6HX
T331MF140X150R6HX	M14 x 1,5	110	16	56	12,0	4	6HX
T331M140X200R6HX	M14 x 2	110	16	56	12,0	4	6HX
T331M160X200R6HX	M16 x 2	110	16	64	14,0	4	6HX

NOTE: Proprietary technology.

Shank Tolerance

D	tolerance h6
6	+0, -0,008
8-10	+0, -0,009
12-16	+0, -0,011

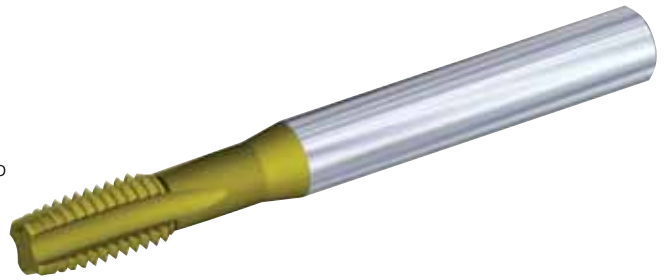
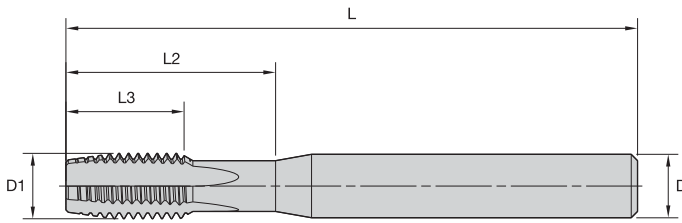

beyond

KC7542 TiAlN + TiN for cast iron.

■ T340 • Form D Plug Chamfer • Metric

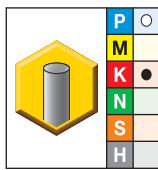

- first choice
- alternate choice

KC7542	D1 size	L	L3	L2	D	number of flutes	class of fit
T340M040X070R6HX	M4 x 0,7	60	6	16	6,0	3	6HX
T340M050X080R6HX	M5 x 0,8	60	7	20	6,0	3	6HX
T340M060X100R6HX	M6 x 1	70	12	23	6,0	4	6HX
T340M080X125R6HX	M8 x 1,25	80	15	28	8,0	4	6HX
T340M100X150R6HX	M10 x 1,5	90	18	33	10,0	4	6HX
T340MF100X100R6HX	M10 x 1	90	18	33	10,0	4	6HX
T340MF120X150R6HX	M12 x 1,5	100	21	40	12,0	4	6HX
T340M120X175R6HX	M12 x 1,75	100	21	40	12,0	4	6HX
T340M140X200R6HX	M14 x 2	110	24	47	12,0	4	6HX
T340MF140X150R6HX	M14 x 1,5	110	24	47	12,0	4	6HX
T340M160X200R6HX	M16 x 2	110	24	53	14,0	4	6HX
T340M180X250R6HX	M18 x 2,5	125	30	59	16,0	5	6HX
T340M200X250R6HX	M20 x 2,5	140	30	66	18,0	5	6HX

NOTE: Proprietary technology.

Shank Tolerance

D	tolerance h6
6	+0, -0,008
8-10	+0, -0,009
12-16	+0, -0,011



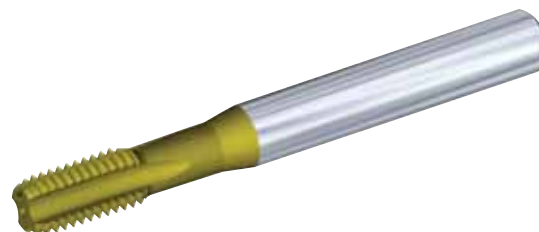
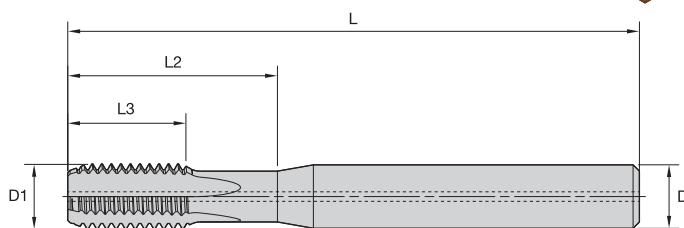

beyond

KC7542 TiAlN + TiN for cast iron.

■ T351 • Form E Bottoming Chamfer • Through Coolant M6 and Larger • Metric

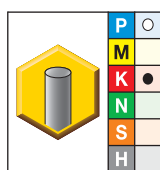

● first choice
○ alternate choice

Taps

KC7542	D1 size	L	L3	L2	D	number of flutes	class of fit
T351M040X070R6HX	M4 x 0,7	60	6	16	6,0	3	6HX
T351M050X080R6HX	M5 x 0,8	60	7	20	6,0	3	6HX
T351M060X100R6HX	M6 x 1	70	12	23	6,0	4	6HX
T351M080X125R6HX	M8 x 1,25	80	15	28	8,0	4	6HX
T351MF100X100R6HX	M10 x 1	90	18	33	10,0	4	6HX
T351M100X150R6HX	M10 x 1,5	90	18	33	10,0	4	6HX
T351MF120X150R6HX	M12 x 1,5	100	21	40	12,0	4	6HX
T351M120X175R6HX	M12 x 1,75	100	21	40	12,0	4	6HX
T351MF140X150R6HX	M14 x 1,5	110	24	47	12,0	4	6HX
T351M140X200R6HX	M14 x 2	110	24	47	12,0	4	6HX
T351M160X200R6HX	M16 x 2	110	24	53	14,0	4	6HX
T351M200X250R6HX	M20 x 2,5	140	30	66	18,0	5	6HX

NOTE: Proprietary technology.

Shank Tolerance

D	tolerance h6
6	+0, -0,008
8-10	+0, -0,009
12-16	+0, -0,011

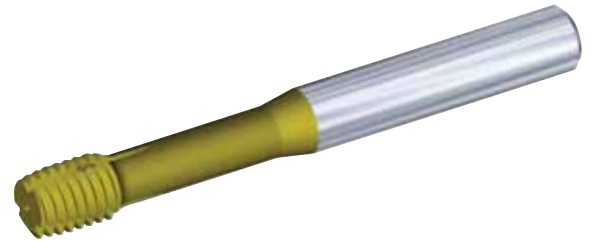
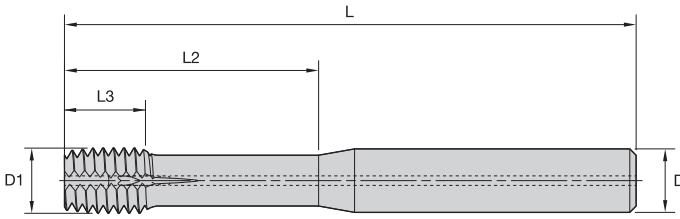

KC7542 TiAlN + TiN for steel.

■ T381 • Form D Plug Entry Taper • Through Coolant M6 and Larger • Metric

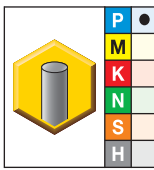

- first choice
- alternate choice

KC7542	D1 size	L	L3	L2	D	number of lube grooves	class of fit
T381M040X070R6HX	M4 x 0,7	60	6	16	6,0	2	6HX
T381M050X080R6HX	M5 x 0,8	60	7	20	6,0	2	6HX
T381M060X100R6HX	M6 x 1	70	8	24	6,0	2	6HX
T381M080X125R6HX	M8 x 1,25	80	10	32	8,0	2	6HX
T381M100X150R6HX	M10 x 1,5	90	12	40	10,0	3	6HX

NOTE: Proprietary technology.
Form taps require a larger drilled hole size prior to tapping than corresponding cutting taps.

Shank Tolerance

D	tolerance h6
6	+0, -0,008
8-10	+0, -0,009
12-16	+0, -0,011



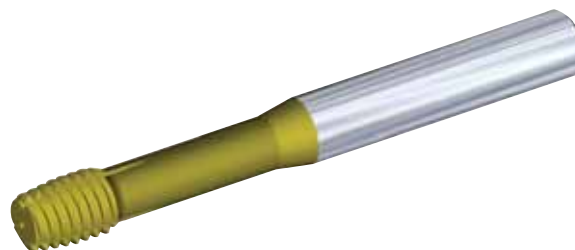
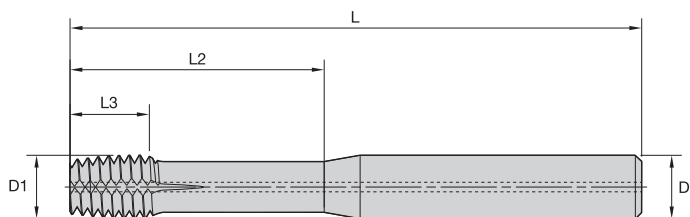

KC7542 TiAlN + TiN for steel.

■ T391 • Form E Bottoming Entry Taper • Through Coolant M6 and Larger • Metric

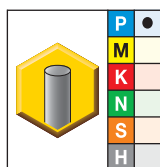

- first choice
- alternate choice

Taps

KC7542	D1 size	L	L3	L2	D	number of lube grooves	class of fit
T391M040X070R6HX	M4 x 0,7	60	6	16	6,0	2	6HX
T391M050X080R6HX	M5 x 0,8	60	7	20	6,0	2	6HX
T391M060X100R6HX	M6 x 1	70	8	24	6,0	2	6HX
T391M080X125R6HX	M8 x 1,25	80	10	32	8,0	2	6HX
T391M100X150R6HX	M10 x 1,5	90	12	40	10,0	3	6HX

NOTE: Proprietary technology.
Form taps require a larger drilled hole size prior to tapping than corresponding cutting taps.

Shank Tolerance

D	tolerance h6
6	+0, -0,008
8-10	+0, -0,009
12-16	+0, -0,011

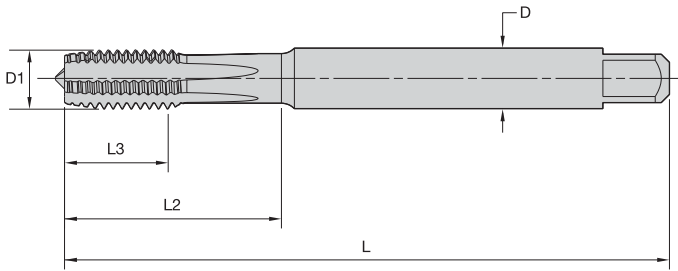

KCU36 • TiAlN/MoS₂ for tapping steel 55–63 HRC.

■ T410 • DIN 371, 374, and 376 • Form C Semi-Bottoming Chamfer • Metric

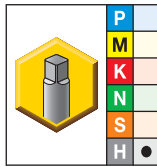

● first choice
○ alternate choice

KCU36	D1 size	L	L3	L2	D	number of flutes	dimension standard	class of fit
T410M030X050R6HX-D1	M3 x 0,5	63	6	18	4,5	4	DIN 371	6HX
T410M040X070R6HX-D1	M4 x 0,7	63	8	20	4,5	4	DIN 371	6HX
T410M050X080R6HX-D1	M5 x 0,8	70	10	26	6,0	4	DIN 371	6HX
T410M060X100R6HX-D1	M6 x 1	80	12	28	6,0	4	DIN 371	6HX
T410MF080X100R6HX-D4	M8 x 1	90	15	35	8,0	5	DIN 374	6HX
T410M080X125R6HX-D1	M8 x 1,25	90	15	35	8,0	5	DIN 371	6HX
T410MF100X100R6HX-D4	M10 x 1	100	18	38	10,0	5	DIN 374	6HX
T410M100X150R6HX-D1	M10 x 1,5	100	18	38	10,0	5	DIN 371	6HX
T410MF120X150R6HX-D4	M12 x 1,5	110	21	41	12,0	5	DIN 374	6HX
T410M120X175R6HX-D6	M12 x 1,75	110	21	41	12,0	5	DIN 376	6HX
T410MF140X150R6HX-D4	M14 x 1,5	110	24	44	14,0	5	DIN 374	6HX
T410M140X200R6HX-D6	M14 x 2	110	24	44	14,0	6	DIN 376	6HX
T410MF160X150R6HX-D4	M16 x 1,5	110	24	44	16,0	5	DIN 374	6HX

Shank Tolerance

D	tolerance h9
1–3	+0, -0,025
3,5–6	+0, -0,030
7–10	+0, -0,036
11–18	+0, -0,043



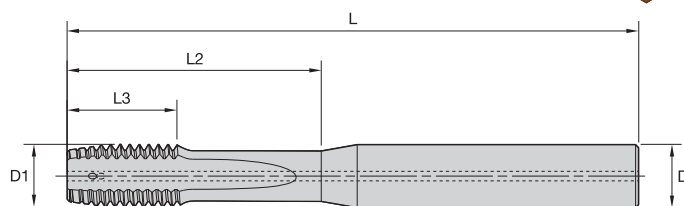

beyond

KC7512 TiN + CrC/C for aluminium.

■ T461 • Form D Plug Chamfer • Through Coolant M6 and Larger • Metric

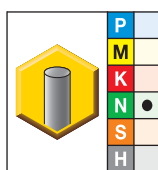

- first choice
- alternate choice

Taps

KC7512	D1 size	L	L3	L2	D	number of flutes	class of fit
T461M060X100R6HX	M6 x 1	70	12	24	6,0	3	6HX
T461M080X125R6HX	M8 x 1,25	80	15	32	8,0	3	6HX
T461MF100X100R6HX	M10 x 1	90	18	40	10,0	3	6HX
T461M100X150R6HX	M10 x 1,5	90	18	40	10,0	3	6HX
T461MF120X150R6HX	M12 x 1,5	100	21	48	12,0	3	6HX
T461M120X175R6HX	M12 x 1,75	100	21	48	12,0	3	6HX
T461MF140X150R6HX	M14 x 1,5	110	24	56	12,0	4	6HX
T461M140X200R6HX	M14 x 2	110	24	56	12,0	4	6HX
T461MF160X150R6HX	M16 x 1,5	110	24	64	14,0	4	6HX
T461M160X200R6HX	M16 x 2	110	24	64	14,0	4	6HX

NOTE: Proprietary technology.

Shank Tolerance

D	tolerance h6
6	+0, -0,008
8-10	+0, -0,009
12-16	+0, -0,011

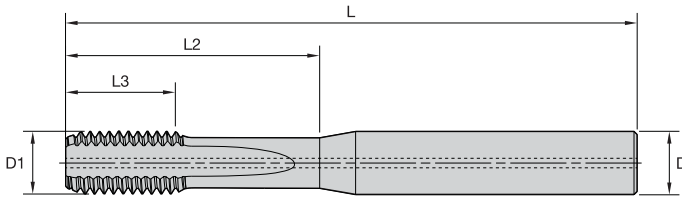

KC7512 TiN + CrC/C for aluminium.

■ T471 • Form E Bottoming Chamfer • Through Coolant M6 and Larger • Metric

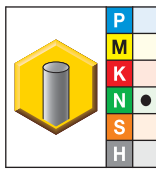

- first choice
- alternate choice

KC7512	D1 size	L	L3	L2	D	number of flutes	class of fit
T471M060X100R6HX	M6 x 1	70	12	24	6,0	3	6HX
T471M080X125R6HX	M8 x 1,25	80	15	32	8,0	3	6HX
T471MF100X100R6HX	M10 x 1	90	18	40	10,0	3	6HX
T471M100X150R6HX	M10 x 1,5	90	18	40	10,0	3	6HX
T471MF120X150R6HX	M12 x 1,5	100	21	48	12,0	3	6HX
T471M120X175R6HX	M12 x 1,75	100	21	48	12,0	3	6HX
T471MF140X150R6HX	M14 x 1,5	110	24	56	12,0	4	6HX
T471M140X200R6HX	M14 x 2	110	24	56	12,0	4	6HX
T471MF160X150R6HX	M16 x 1,5	110	24	64	14,0	4	6HX
T471M160X200R6HX	M16 x 2	110	24	64	14,0	4	6HX

NOTE: Proprietary technology.

Shank Tolerance

D	tolerance h6
6	+0, -0,008
8-10	+0, -0,009
12-16	+0, -0,011



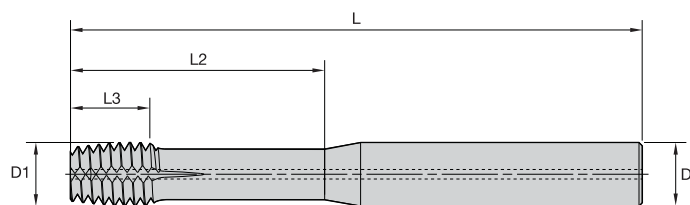

KC7512 TiN + CrC/C for aluminium.

■ T481 • Form D Plug Entry Taper • Through Coolant M6 and Larger • Metric

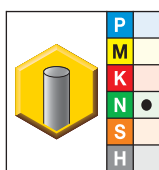

- first choice
- alternate choice

Taps

	D1 size	L	L3	L2	D	number of lube grooves	class of fit
KC7512							
T481M040X070R6HX	M4 x 0,7	60	6	16	6,0	2	6HX
T481M050X080R6HX	M5 x 0,8	60	7	20	6,0	2	6HX
T481M060X100R6HX	M6 x 1	70	8	24	6,0	2	6HX
T481M080X125R6HX	M8 x 1,25	80	10	32	8,0	2	6HX
T481MF100X100R6HX	M10 x 1	90	12	40	10,0	3	6HX
T481M100X150R6HX	M10 x 1,5	90	12	40	10,0	3	6HX
T481MF120X150R6HX	M12 x 1,5	100	14	48	12,0	3	6HX
T481M120X175R6HX	M12 x 1,75	100	14	48	12,0	3	6HX

NOTE: Proprietary technology.
Form taps require a larger drilled hole size prior to tapping than corresponding cutting taps.

Shank Tolerance

D	tolerance h6
6	+0, -0,008
8-10	+0, -0,009
12-16	+0, -0,011

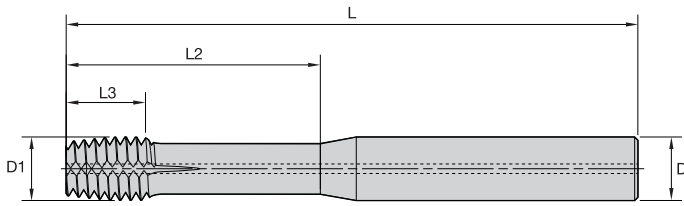

KC7512 TiN + CrC/C for aluminium.

■ T491 • Form E Bottoming Entry Taper • Through Coolant M6 and Larger • Metric

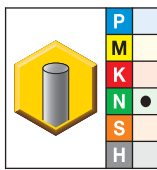

- first choice
- alternate choice

	D1 size	L	L3	L2	D	number of lube grooves	class of fit
KC7512							
T491M040X070R6HX	M4 x 0,7	60	6	16	6,0	2	6HX
T491M050X080R6HX	M5 x 0,8	60	7	20	6,0	2	6HX
T491M060X100R6H	M6 x 1	70	8	24	6,0	2	6HX
T491M080X125R6HX	M8 x 1,25	80	10	32	8,0	2	6HX
T491MF100X100R6H	M10 x 1	90	12	40	10,0	3	6HX
T491M100X150R6HX	M10 x 1,5	90	12	40	10,0	3	6HX
T491MF120X150R6HX	M12 x 1,5	100	14	48	12,0	3	6HX
T491M120X175R6HX	M12 x 1,75	100	14	48	12,0	3	6HX

NOTE: Proprietary technology.
Form taps require a larger drilled hole size prior to tapping than corresponding cutting taps.

Shank Tolerance

D	tolerance h6
6	+0, -0,008
8-10	+0, -0,009
12-16	+0, -0,011



■ Metric

Material Group	Through Holes						Blind Holes				
	Tap Style	Grade	Range – m/min			Tap Style	Grade	Range – m/min			
			min	Starting Value	max			min	Starting Value	max	
P	1	T320, T381	KC7542	80	100	130	T331, T381	KC7542	50	70	90
	2	T320, T381	KC7542	70	90	120	T331, T381	KC7542	50	60	80
	3	T320, T381	KC7542	60	80	100	T331, T381	KC7542	50	60	80
K	1	T340	KC7542	80	105	140	T351	KC7542	50	70	90
	2	T340	KC7542	80	100	130	T351	KC7542	50	70	90
	3	T340	KC7542	70	90	120	T351	KC7542	50	60	80
N	1	T461, T481	KC7512	90	120	160	T471, T491	KC7512	60	80	100
	2	T461, T481	KC7512	80	100	130	T471, T491	KC7512	50	70	90
	4	T461, T481	KC7512	70	85	110	T471, T491	KC7512	50	60	80
H	3	T410	KCU36	1,2	1,5	2,0	T410	KCU36	0,8	1,1	1,4
	4	T410	KCU36	0,6	0,8	1,0	T410	KCU36	0,4	0,5	0,7

NOTE: Increase speed of T321 coolant taps by up to 25% of speeds listed for non-coolant T320 taps.



Carbide Recycling

Help preserve and protect our planet!

It's easy for your company to be environmentally conscious with the Kennametal Carbide Recycling Program.

By sending us your used carbide tools, you help preserve and protect the environment and ensure that these products are recycled responsibly. Kennametal accepts any coated or non-coated carbide items, including inserts, drills, reamers, and taps.



By using the Kennametal Carbide Recycling Program, you will receive:

- A partner who cares about a sustainable environment.
- Easy-to-use web portal to value your used carbide.
- Access to our popular Green Box™ options for carbide collection.
- Systematic and efficient disposal of carbide materials.
- Improved profitability.

Program is not currently available in all geographical areas.
 For more information, please visit www.kennametal.com/carbiderecycling.



The Kennametal Solution

Kennametal Global Engineered Solutions. Coordinated global resources with world-class manufacturing, process development, and implementation capabilities.

No matter how small or large your project.

- Whether it's a single tailored tool or the development of a comprehensive manufacturing process, Kennametal's team can manage the development, personnel training, and successful implementation of the complete solution.







Regardless of where you're located, Kennametal is everywhere you are.

- With Kennametal's team, you receive globally coordinated manufacturing, process development, implementation, and optimisation support and key alliances with machine tool builders and other leading technology manufacturers that ensure a complete solution.

Experience the advantages at your Authorised Kennametal Distributor or at www.kennametal.com.

www.kennametal.com



Solid Carbide Taps		Recommended SC Drill		All Materials Alternate Tap Drill	
					
forming blind hole with coolant T391_KC7542	forming through hole with coolant T381_KC7542	approximately 3 x D with coolant B224_HP KCPK15	approximately 5 x D with coolant B225_HP KCPK15	approximately 3 x D with coolant B976_KC7315	approximately 5 x D with coolant B977_KC7315
T391NC#6-32R3BX	T381NC#6-32R3BX	B224A03175HP	B225A03175HP	B976A03175	B977A03175
T391M040X070R6HX	T381M040X070R6HX	B224A03700HP	B225A03700HP	B976A03700	B977A03700
T391NC#8-32R3BX	T381NC#8-32R3BX	B224A03797HP	B225A03797HP	B976A03797	B977A03797
T391NC#10-24R3BX	T381NC#10-24R3BX	B224A04366HP	B225A04366HP	B976A04366	B977A04366
T391NF#10-32R3BX	T381NF#10-32R3BX	B224A04496HP	B225A04496HP	B976A04496	B977A04496
T391M050X080R6HX	T381M050X080R6HX	B224A04700HP	B225A04700HP	B976A04700	B977A04700
-	-	B224A05000HP	B225A05000HP	B976A05000	B977A05000
-	-	B224A05106HP	B225A05106HP	B976A05106	B977A05106
-	-	B224A05410HP	B225A05410HP	B976A05410	B977A05410
T391M060X100R6HX	T381M060X100R6HX	B224A05600HP	B225A05600HP	B976A05600	B977A05600
T391NC2500-20R3BX	T381NC2500-20R3BX	B224A05791HP	B225A05791HP	B976A05791	B977A05791
T391NF2500-28R3BX	T381NF2500-28R3BX	B224A05944HP	B225A05944HP	B976A05944	B977A05944
-	-	B224A06528HP	B225A06528HP	B976A06528	B977A06528
-	-	B224A06700HP	B225A06700HP	B976A06700	B977A06700
-	-	B224A06909HP	B225A06909HP	B976A06909	B977A06909
T391NC3125-18R3BX	T381NC3125-18R3BX	B224A07366HP	B225A07366HP	B976A07366	B977A07366
T391M080X125R6HX	T381M080X125R6HX	B224A07400HP	B225A07400HP	B976A07400	B977A07400
-	-	B224A07938HP	B225A07938HP	B976A07938	B977A07938
-	-	B224A08433HP	B225A08433HP	B976A08433	B977A08433
-	-	B224A08500HP	B225A08500HP	B976A08500	B977A08500
-	-	B224A09000HP	B225A09000HP	B976A09000	B977A09000
T391NC3750-16R3BX	T381NC3750-16R3BX	B224A08839HP	B225A08839HP	B976A08839	B977A08839
-	-	B224A09093HP	B225A09093HP	B976A09093	B977A09093
T391M100X150R6HX	T381M100X150R6HX	B224A09400HP	B225A09400HP	B976A09400	B977A09400
-	-	B224A10200HP	B225A10200HP	B976A10200	B977A10200
-	-	B224A10500HP	B225A10500HP	B976A10500	B977A10500
-	-	B224A10716HP	B225A10716HP	B976A10716	B977A10716
-	-	B224A11509HP	B225A11509HP	B976A11509	B977A11509
-	-	B224A12000HP	B225A12000HP	B976A12000	B977A12000
-	-	B224A12304HP	B225A12304HP	B976A12304	B977A12304
-	-	B224A12500HP	B225A12500HP	B976A12500	B977A12500
-	-	B224A13495HP	B225A13495HP	B976A13495	B977A13495
-	-	B224A14000HP	B225A14000HP	B976A14000	B977A14000







Cast Iron

typical thread sizes		required tap drill diameter				Solid Carbide Taps	
cutting taps						blind hole with coolant T351_KC7542	through hole T340_KC7542
metric	inch	mm	inch	fraction	wire		
—	6-32	2.705	.1065	—	36	T351NC#6-32R3BX	—
M4 x 0,70	—	3.300	.1299	—	—	T351M040X070R6HX	T340M040X070R6HX
—	8-32 /8-36	3.454	.1360	—	29	T351NC#8-32R3BX	—
—	10-24	3.734	.1470	—	26	T351NC#10-24R3BX	—
—	10-32	4.039	.1590	—	21	T351NF#10-32R3BX	—
M5 x 0,80	—	4.200	.1654	—	—	T351M050X080R6HX	T340M050X080R6HX
M6 x 1,00	—	5.000	.1969	—	—	T351M060X100R6HX	T340M060X100R6HX
—	1/4-20	5.106	.2010	—	7	T351NC2500-20R3BX	T340NC2500-20R3BX
—	1/4-28	5.410	.2130	—	3	T351NF2500-28R3BX	T340NF2500-28R3BX
—	5/16-18	6.528	.2570	—	F	T351NC3125-18R3BX	T340NC3125-18R3BX
M8 x 1,25	—	6.700	.2638	—	—	T351M080X125R6HX	T340M080X125R6HX
—	3/8-16	7.938	.3125	5/16	—	T351NC3750-16R3BX	T340NC03750-16R3BX
—	3/8-24	8.433	.3320	—	Q	—	T340NF03750-24R3BX
M10 x 1,50	—	8.500	.3346	—	—	T351M100X150R6HX	T340M100X150R6HX
M10 x 1,00	—	9.000	.3543	—	—	T351MF100X100R6HX	T340MF100X100R6HX
—	7/16-14	9.093	.3580	—	T	T351NC4375-14R3BX	T340NC04375-14R3BX
M12 x 1,75	—	10.200	.4016	—	—	T351M120X175R6HX	T340M120X175R6HX
M12 x 1,50	—	10.500	.4134	—	—	T351MF120X150R6HX	T340MF120X150R6HX
—	1/2-13	10.716	.4219	27/64	—	T351NC5000-13R3BX	T340NC05000-13R3BX
—	1/2-20	11.509	.4531	29/64	—	—	T340NF05000-20R3BX
M14 x 2,00	—	12.000	.4724	—	—	T351M140X200R6HX	T340M140X200R6HX
—	9/16-12	12.304	.4844	31/64	—	T351NC5625-12R3BX	T340NC05625-12R3BX
M14 x 1,50	—	12.500	.4921	—	—	T351MF140X150R6HX	T340MF140X150R6HX
—	5/8-11	13.495	.5313	17/32	—	T351NC6250-11R3BX	T340NC06250-11R3BX
M16 x 2,00	—	14.000	.5512	—	—	T351M160X200R6HX	T340M160X200R6HX
M18 x 2,50	—	15.500	.6102	—	—	—	T340M180X250R6HX
—	3/4-10	16.670	.6563	21/32	—	T351NC7500-10R3BX	T340NC07500-10R3BX
M20 x 2,50	—	17.500	.6890	—	—	T351M200X250R6HX	T340M200X250R6HX



Taps





K		All Materials	
Recommended SC Drill		Alternate Tap Drill	
			
approximately 3 x D with coolant B254_YPC KCK10	approximately 5 x D with coolant B254_YPC KCK10	approximately 3 x D with coolant B976_KC7315	approximately 5 x D with coolant B977_KC7315
B254Z02705YPC	B255Z02705YPC	—	B051A02705CPG
B254A03300YPC	B255A03300YPC	B976A03300	B977A03300
B254A03454YPC	B255A03454YPC	B976A03454	B977A03454
B254A03734YPC	B255A03734YPC	B976A03734	B977A03734
B254A04039YPC	B255A04039YPC	B976A04039	B977A04039
B254A04200YPC	B255A04200YPC	B976A04200	B977A04200
B254A05000YPC	B255A05000YPC	B976A05000	B977A05000
B254A05106YPC	B255A05106YPC	B976A05106	B977A05106
B254A05410YPC	B255A05410YPC	B976A05410	B977A05410
B254A06528YPC	B255A06528YPC	B976A06528	B977A06528
B254A06700YPC	B255A06700YPC	B976A06700	B977A06700
B254A07938YPC	B255A07938YPC	B976A07938	B977A07938
B254A08433YPC	B255A08433YPC	B976A08433	B977A08433
B254A08500YPC	B255A08500YPC	B976A08500	B977A08500
B254A09000YPC	B255A09000YPC	B976A09000	B977A09000
B254A09093YPC	B255A09093YPC	B976A09093	B977A09093
B254A10200YPC	B255A10200YPC	B976A10200	B977A10200
B254A10500YPC	B255A10500YPC	B976A10500	B977A10500
B254A10716YPC	B255A10716YPC	B976A10716	B977A10716
B254A11509YPC	B255A11509YPC	B976A11509	B977A11509
B254A12000YPC	B255A12000YPC	B976A12000	B977A12000
B254A12304YPC	B255A12304YPC	B976A12304	B977A12304
B254A12500YPC	B255A12500YPC	B976A12500	B977A12500
B254A13495YPC	B255A13495YPC	B976A13495	B977A13495
B254A14000YPC	B255A14000YPC	B976A14000	B977A14000
B254A15500YPC	B255A15500YPC	B976A15500	B977A15500
B254A16670YPC	B255A16670YPC	B976A16670	B977A16670
B254A17500YPC	B255A17500YPC	B976A17500	B977A17500

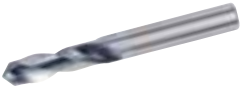

Aluminium

typical thread sizes		required tap drill diameter						N					
cutting taps		forming taps								Solid Carbide Taps		Solid Carbide Taps	
metric	inch	metric	inch	mm	inch	fraction	wire	blind hole with coolant T471_KC7512	through hole with coolant T461_KC7512	forming blind hole with coolant T491_KC7512			
—	—	—	6-32	3.175	.1250	1/8	—	—	—	T491NC#6—32R3B			
M4,5 x 0,75	—	M4 x 0,70	—	3.700	.1457	—	—	—	—	T491M040X070R6H			
—	—	—	8-32	3.797	.1495	—	25	—	—	T491NC#8—32R3B			
—	—	—	10-24	4.366	.1719	11/64	—	—	—	T491NC#10—24R3B			
—	12-24	—	10-32	4.496	.1770	—	16	—	—	T491NF#10—32R3B			
—	—	M5 x 0,80	—	4.700	.1850	—	13	—	—	T491M050X080R6H			
M6 x 1,00	—	—	—	5.000	.1969	—	—	T471M060X100R6H	T461M060X100R6H	—			
—	1/4-20	—	12-28	5.106	.2010	—	7	T471NC2500—20R3B	T461NC2500—20R3B	—			
—	1/4-28	—	—	5.410	.2130	—	3	T471NF2500—28R3B	T461NF2500—28R3B	—			
—	—	M6 x 1,00	—	5.600	.2205	—	—	—	—	—	T491M060X100R6H		
—	—	—	1/4-20	5.791	.2280	—	1	—	—	—	T491NC2500—20R3B		
—	—	—	1/4-28	5.944	.2340	—	A	—	—	—	T491NF2500—28R3B		
—	5/16-18	—	—	6.528	.2570	—	F	T471NC3125—18R3B	T461NC3125—18R3B	—			
M8 x 1,25	—	—	—	6.700	.2638	—	—	T471M080X125R6H	T461M080X125R6H	—			
—	—	—	5/16-18	7.366	.2900	—	L	—	—	—	T491NC3125—18R3B		
—	—	M8 x 1,25	—	7.400	.2913	—	—	—	—	—	T491M080X125R6H		
—	3/8-16	—	—	7.938	.3125	5/16	—	T471NC3750—16R3B	T461NC3750—16R3B	—			
M10 x 1,50	—	—	—	8.500	.3346	—	—	T471M100X150R6H	T461M100X150R6H	—			
M10 x 1,00	—	—	—	9.000	.3543	—	—	T471MF100X100R6H	T461MF100X100R6H	—			
—	—	—	3/8-16	8.839	.3480	—	S	—	—	—	T491NC3750—16R3B		
—	7/16-14	—	3/8-24	9.093	.3580	—	T	T471NC4375—14R3B	T461NC4375—14R3B	—			
—	—	M10 x 1,50	—	9.400	.3701	—	—	—	—	—	T491M100X150R6H		
—	—	M10 x 1,00	—	9.500	.3740	—	—	—	—	—	T491MF100X100R6H		
—	7/16-20	—	—	9.921	.3906	25/64	—	—	—	—	—		
M12 x 1,75	—	—	—	10.200	.4016	—	—	T471M120X175R6H	T461M120X175R6H	—			
—	—	—	7/16-14	10.262	.4040	—	Y	—	—	—	T491NC4375—14R3B		
M12 x 1,50	—	—	—	10.500	.4134	—	—	T471MF120X150R6H	T461MF120X150R6H	—			
—	1/2-13	—	—	10.716	.4219	27/64	—	T471NC5000—13R3B	T461NC5000—13R3B	—			
—	—	M12 x 1,75	—	11.300	.4449	—	—	—	—	—	T491M120X175R6H		
—	—	M12 x 1,50	—	11.300	.4449	—	—	—	—	—	T491MF120X150R6H		
—	—	—	1/2-13	11.908	.4688	15/32	—	—	—	—	T491NC5000—13R3B		
M14 x 2,00	—	—	—	12.000	.4724	—	—	T471M140X200R6H	T461M140X200R6H	—			
—	9/16-12	—	—	12.304	.4844	31/64	—	T471NC5625—12R3B	T461NC5625—12R3B	—			
M14 x 1,50	—	—	—	12.500	.4921	—	—	T471MF140X150R6H	T461MF140X150R6H	—			
—	5/8-11	—	9/16-12	13.495	.5313	17/32	—	T471NC6250—11R3B	T461NC6250—11R3B	—			
M16 x 2,00	—	—	—	14.000	.5512	—	—	T471M160X200R6H	T461M160X200R6H	—			
M16 x 1,50	—	—	—	14.500	.5709	—	—	T471MF160X150R6H	T461MF160X150R6H	—			

Taps

Solid Carbide Taps	N		All Materials	
	Recommended SC Drill		Alternate Tap Drill	
 forming through hole with coolant T481_KC7512	 approximately 3 x D with coolant B284_(HP) K715	 approximately 5 x D with coolant B411 KF1	 approximately 3 x D with coolant B976_KC7315	 approximately 5 x D with coolant B977_KC7315
T481NC#6—32R3B	—	—	B976A03175	B977A03175
T481M040X070R6H	—	—	B976A03700	B977A03700
T481NC#8—32R3B	—	—	B976A03797	B977A03797
T481NC#10—24R3B	—	—	B976A04366	B977A04366
T481NF#10—32R3B	—	—	B976A04496	B977A04496
T481M050X080R6H	—	—	B976A04700	B977A04700
—	B284A05000	B411A05000	B976A05000	B977A05000
—	—	—	B976A05106	B977A05106
—	—	—	B976A05410	B977A05410
T481M060X100R6H	—	B411A05600	B976A05600	B977A05600
T481NC2500—20R3B	—	—	B976A05791	B977A05791
T481NF2500—28R3B	—	—	B976A05944	B977A05944
—	—	—	B976A06528	B977A06528
—	—	—	B976A06700	B977A06700
T481NC3125—18R3B	—	—	B976A07366	B977A07366
T481M080X125R6H	—	B411A07400	B976A07400	B977A07400
—	—	—	B976A07938	B977A07938
—	—	B411A08500	B976A08500	B977A08500
—	—	B411A09000	B976A09000	B977A09000
T481NC3750—16R3B	—	—	B976A08839	B977A08839
—	—	—	B976A09093	B977A09093
T481M100X150R6H	—	—	B976A09400	B977A09400
T481MF100X100R6H	—	B411A09500	B976A09500	B977A09500
—	K284A03906	—	B976A09921	B977A09921
—	—	B411A10200	B976A10200	B977A10200
T481NC4375—14R3B	—	—	B976A10262	B977A10262
—	—	B411A10500	B976A10500	B977A10500
—	—	—	B976A10716	B977A10716
T481M120X175R6H	—	—	B976A11300	B977A11300
T481MF120X150R6H	—	—	B976A11300	B977A11300
T481NC5000—13R3B	K284A04688	—	B976A11908	B977A11908
—	—	B411A12000	B976A12000	B977A12000
—	—	—	B976A12304	B977A12304
—	—	B411A12500	B976A12500	B977A12500
—	—	—	B976A13495	B977A13495
—	—	B411A14000	B976A14000	B977A14000
—	—	B411A14500	B976A14500	B977A14500





High-Performance HSS-E-PM Taps



Primary Application

The High-Performance High-Speed Steel (HSS-E-PM) Taps are manufactured to both ANSI and DIN standards from powder metal, offering high productivity and reliable thread quality and are engineered for greater wear and heat resistance. HSS-E-PM tools can be used on conventional non-rigid and CNC-synchronous tapping machines for tapping through and blind holes in a variety of materials and is particularly efficient in tapping soft steel and aluminium.

The precision h6 shank enables usage in either conventional square drive tap holders or in precision round toolholders.

Features and Benefits

Improved Performance, Wide Range of Choices























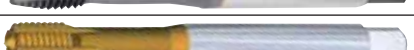



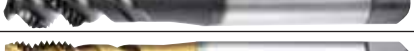
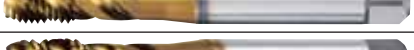

- Higher strength and wider range of applications versus carbide taps.
- Higher tapping speed capability and longer life than conventional HSS-E taps.
- Can be used on either conventional or synchronous tapping machines.
- Forming taps for soft steel and aluminium.
- Selection of taps for all materials:
 - Steel
 - Stainless steel
 - Iron
 - Aluminium, cast and wrought
 - Aerospace
 - Hard steel

Customisation

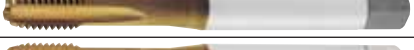
- Customised taps are available with short lead times from semi-finished blanks.



Beyond™ High-Performance HSS-E-PM Taps • DIN Metric

Beyond High-Performance HSS-E-PM				● first choice ○ alternate choice					
	series	grade	shank/dimension	P	M	K	N	S	H
	T600	KSP21	DIN 371, 374, 376	●	○			○	
	T602	KSP21	DIN 371, 374, 376	●				○	
	T604	KSH26	DIN 371, 374, 376	●					
	T606	KSSH22	DIN 371, 374, 376						●
	T610	KSSH22	DIN 371, 374, 376					●	
	T612	KSSH22	DIN 371, 374, 376					●	
	T614	KSN25	DIN 371, 376				○	●	
	T616	KSN25	DIN 371				○	●	
	T620	KP6525	DIN 371, 374, 376, XL	●				○	
	T620	KM6515	DIN 371, 374, 376		●		○	○	
	T621	KP6525	DIN 371, 376	●				○	
	T621	KM6515	DIN 371, 376		●		○	○	
	T622	KSP21	DIN 371, 374, 376	●					
	T622	'KSN28	DIN 371, 374, 376					●	
	T623	KSP21	DIN 371, 374, 376	●					
	T623	KSN28	DIN 371, 374, 376					●	
	T630	KP6525	DIN 371, 374, 376, XL	●				○	
	T630	KM6515	DIN 371, 374, 376		●		○	○	
	T630	KP6505	DIN 371, 376	●					
	T631	KP6525	DIN 371, 376, XL	●				○	
	T631	KM6515	DIN 371, 376		●		○	○	
	T632	KP6525	DIN 371, 374, 376	●				○	
	T633	KP6525	DIN 371, 374, 376	●					
	T640	KP6525	DIN 371, 376			●	●		
	T641	KP6525	DIN 371, 376			●	●		
	T642	KP6525	DIN 371, 374, 376			●	●		
	T643	KP6525	DIN 371, 374, 376			●	●		
	T650	KP6525	DIN 376, XL	●	○				
	T651	KP6525	DIN 376, XL	●	○				
	T670	KSN38	DIN 371, 376					●	
	T680	KSN38	DIN 371, 376					●	

Taps

size range (metric) size min-max	through hole	blind hole	chamfer form	helix angle	external coolant	internal coolant	page(s)	recommended cutting parameters
M3-M20							L36	L64
M3-M20							L37	L64
M3-M20							L38	L64
M6-M16							L39	L64
M3-M20							L40	L64
M3-M20							L41	L64
M3-M12							L42	L64
M3-M12							L43	L64
M3-M42							L44, L59	L64
M3-M20							L44	L64
M5-M14							L45	L64
M5-M14							L45	L64
M3-M16							L46	L64
M3-M16							L46	L64
M5-M16							L47	L64
M5-M16							L47	L64
M3-M42							L48, L60	L64
M3-M24							L48	L64
M3-M16							L48	L64
M5-M42							L49, L61	L64
M5-M16							L49	L64
M5-M16							L50	L64
M5-M16							L51	L64
M4-M22							L52	L64
M4-M20							L53	L64
M5-M16							L54	L64
M5-M16							L55	L64
M24-M42							L62	L64
M24-M42							L63	L64
M3-M16							L56	L64
M3-M20							L57	L64



HSS Taps Identification System



Metric

T620 **MF** **120** **X** **150** **R** **6HX** **-D4**

Inch

T620 **NC** **06250** **-** **11** **R** **3BX** **-A**

Tap Design

Type of Thread

Nominal Diameter of Thread

-

Pitch

Cutting Direction

Tolerance Class

Taps Dimension

mm or inch
(depending on type)

mm or TPI
(depending on type)

M = Metric coarse-pitch thread (ISO form)

MF = Metric fine-pitch thread (ISO form)

NC = Unified coarse series thread

NF = Unified fine series thread

A = ANSI

D1 = DIN 371

D4 = DIN 374

D6 = DIN 376

D74 = DIN 3174

J = JIS

XL = DIN extra length

Style

T620 = Steel and stainless steel, through holes, LH spiral flute, solid

T621 = Steel and stainless steel, through holes, LH spiral flute, coolant

T630 = Steel and stainless steel, blind holes, RH spiral flute, solid

T631 = Steel and stainless steel, blind holes, RH spiral flute, coolant

T640 = Cast iron, through and blind holes, straight flute, solid

T641 = Cast iron, through and blind holes, straight flute, coolant

NOTE: Other taps styles, see page L31.

Taps



WIND ENERGY TAPS

The new high-performance, large-sized HSS-E-PM taps called Wind Taps were developed for the manufacturers of some of the most important wind turbine components like hubs, rings, and gearbox housings to increase productivity and keep up with the rapid increase in demand for such components.

- Designed for both conventional non-rigid and CNC-synchronous tapping machines.
- Manufactured to DIN 376 dimension.
- Extra-long version developed to reach longer overhang that is very common on these big components.
- Precision h6 shanks enable use in either conventional tap holders with square drive or in precision round toolholders.

Tap into something great at your Authorised Kennametal Distributor or at www.kennametal.com.

www.kennametal.com

 **KENNAMETAL®**

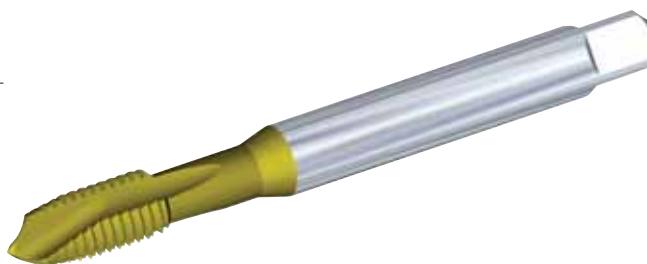
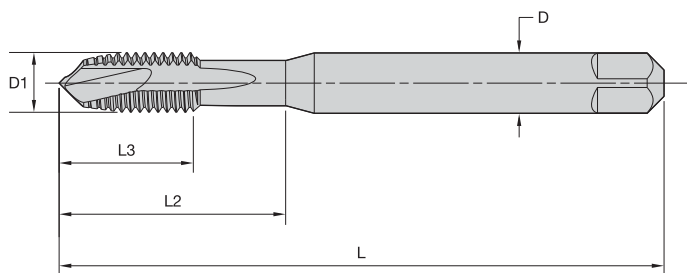

KSP21 • TiN for tapping steel 32–44 HRC.

■ T600 • DIN 371, 374, and 376 • Form B Plug Chamfer • Metric

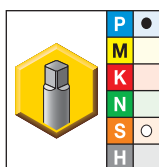

- first choice
- alternate choice

Taps

KSP21	D1 size	L	L3	L2	D	number of flutes	dimension standard	class of fit
T600M030X050R6HX-D1	M3 x 0,5	56	11	18	3,5	2	DIN 371	6HX
T600M040X070R6HX-D1	M4 x 0,7	63	13	21	4,5	2	DIN 371	6HX
T600M050X080R6HX-D1	M5 x 0,8	70	15	25	6,0	2	DIN 371	6HX
T600M060X100R6HX-D1	M6 x 1	80	17	30	6,0	3	DIN 371	6HX
T600MF080X100R6HX-D4	M8 x 1	90	17	—	6,0	3	DIN 374	6HX
T600M080X125R6HX-D1	M8 x 1,25	90	20	35	8,0	3	DIN 371	6HX
T600MF100X100R6HX-D4	M10 x 1	90	18	—	7,0	3	DIN 374	6HX
T600MF100X125R6HX-D4	M10 x 1,25	100	22	—	7,0	3	DIN 374	6HX
T600M100X150R6HX-D1	M10 x 1,5	100	22	39	10,0	3	DIN 371	6HX
T600MF120X125R6HX-D4	M12 x 1,25	100	22	—	9,0	3	DIN 374	6HX
T600MF120X150R6HX-D4	M12 x 1,5	100	22	—	9,0	3	DIN 374	6HX
T600M120X175R6HX-D6	M12 x 1,75	110	24	—	9,0	3	DIN 376	6HX
T600MF140X150R6HX-D4	M14 x 1,5	100	22	—	11,0	3	DIN 374	6HX
T600M140X200R6HX-D6	M14 x 2	110	26	—	11,0	3	DIN 376	6HX
T600MF160X150R6HX-D4	M16 x 1,5	100	22	—	12,0	4	DIN 374	6HX
T600M160X200R6HX-D6	M16 x 2	110	27	—	12,0	4	DIN 376	6HX
T600M180X250R6HX-D6	M18 x 2	125	30	—	14,0	4	DIN 376	6HX
T600M200X250R6HX-D6	M20 x 2,5	140	32	—	16,0	4	DIN 376	6HX

Shank Tolerance

D	tolerance h9
1–3	+0, -0,025
3,5–6	+0, -0,030
7–10	+0, -0,036
11–18	+0, -0,043

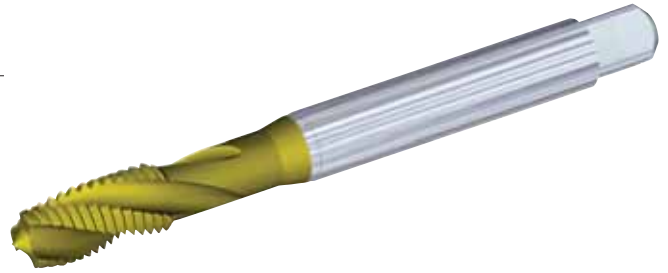
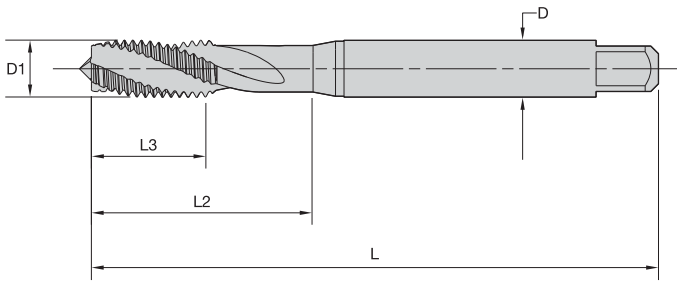

KSP21 • TiN for tapping steel 32–44 HRC (2 x D).

■ T602 • DIN 371, 374, and 376 • Form C Semi-Bottoming Chamfer • Metric

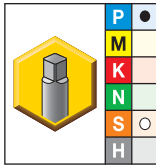

- first choice
- alternate choice

KSP21	D1 size	L	L3	L2	D	number of flutes	dimension standard	class of fit
T602M030X050R6H-D1	M3 x 0,5	56	11	18	3,5	3	DIN 371	6H
T602M040X070R6H-D1	M4 x 0,7	63	13	21	4,5	3	DIN 371	6H
T602M050X080R6H-D1	M5 x 0,8	70	15	25	6,0	3	DIN 371	6H
T602M060X100R6H-D1	M6 x 1	80	17	30	6,0	3	DIN 371	6H
T602MF080X100R6H-D4	M8 x 1	90	17	—	6,0	3	DIN 374	6H
T602M080X125R6H-D1	M8 x 1,25	90	20	35	8,0	3	DIN 371	6H
T602MF100X100R6H-D4	M10 x 1	90	18	—	7,0	3	DIN 374	6H
T602MF100X125R6H-D4	M10 x 1,25	100	22	—	7,0	3	DIN 374	6H
T602M100X150R6H-D1	M10 x 1,5	100	22	39	10,0	3	DIN 371	6H
T602MF120X125R6H-D4	M12 x 1,25	100	22	—	9,0	3	DIN 374	6H
T602MF120X150R6H-D4	M12 x 1,5	100	22	—	9,0	3	DIN 374	6H
T602M120X175R6H-D6	M12 x 1,75	110	24	44	12,0	3	DIN 376	6H
T602MF140X150R6H-D4	M14 x 1,5	100	22	—	11,0	3	DIN 374	6H
T602M140X200R6H-D6	M14 x 2	110	26	52	11,0	3	DIN 376	6H
T602MF160X150R6H-D4	M16 x 1,5	100	22	—	12,0	3	DIN 374	6H
T602M160X200R6H-D6	M16 x 2	110	27	—	12,0	3	DIN 376	6H
T602M180X250R6H-D6	M18 x 2	125	30	—	14,0	4	DIN 376	6H
T602M200X250R6H-D6	M20 x 2,5	140	32	—	16,0	4	DIN 376	6H

Shank Tolerance

D	tolerance h9
1–3	+0, -0,025
3,5–6	+0, -0,030
7–10	+0, -0,036
11–18	+0, -0,043



High-Performance Taps

Spiral-Flute HSS-E-PM Taps • Blind Holes (3 x D)

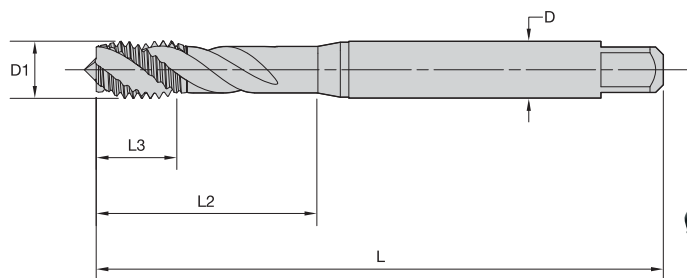

KSH26 • TiAlN/MoS₂ for tapping steel 32–44 HRC (3 x D).

■ T604 • DIN 371, 374, and 376 • Form C Semi-Bottoming Chamfer • Metric

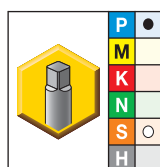

- first choice
- alternate choice

Taps

KSH26	D1 size	L	L3	L2	D	number of flutes	dimension standard	class of fit
T604M030X050R6H-D1	M3 x 0,5	56	6	18	3,5	3	DIN 371	6H
T604M040X070R6H-D1	M4 x 0,7	63	7	21	4,5	3	DIN 371	6H
T604M050X080R6H-D1	M5 x 0,8	70	8	25	6,0	3	DIN 371	6H
T604M060X100R6H-D1	M6 x 1	80	10	30	6,0	3	DIN 371	6H
T604MF080X100R6H-D4	M8 x 1	90	10	—	6,0	3	DIN 374	6H
T604M080X125R6H-D1	M8 x 1,25	90	14	35	8,0	3	DIN 371	6H
T604MF100X100R6H-D4	M10 x 1	90	10	—	7,0	3	DIN 374	6H
T604MF100X125R6H-D4	M10 x 1,25	100	16	—	7,0	3	DIN 374	6H
T604M100X150R6H-D1	M10 x 1,5	100	16	39	10,0	3	DIN 371	6H
T604MF120X125R6H-D4	M12 x 1,25	100	15	—	9,0	4	DIN 374	6H
T604MF120X150R6H-D4	M12 x 1,5	100	15	—	9,0	4	DIN 374	6H
T604M120X175R6H-D6	M12 x 1,75	110	18	—	9,0	4	DIN 376	6H
T604MF140X150R6H-D4	M14 x 1,5	100	15	—	11,0	4	DIN 374	6H
T604M140X200R6H-D6	M14 x 2	110	20	—	11,0	4	DIN 376	6H
T604MF160X150R6H-D4	M16 x 1,5	100	15	—	12,0	4	DIN 374	6H
T604M160X200R6H-D6	M16 x 2	110	22	—	12,0	4	DIN 376	6H
T604M180X250R6H-D6	M18 x 2	125	25	—	14,0	4	DIN 376	6H
T604M200X250R6H-D6	M20 x 2,5	140	25	—	16,0	4	DIN 376	6H

Shank Tolerance

D	tolerance h9
1–3	+0, -0,025
3,5–6	+0, -0,030
7–10	+0, -0,036
11–18	+0, -0,043

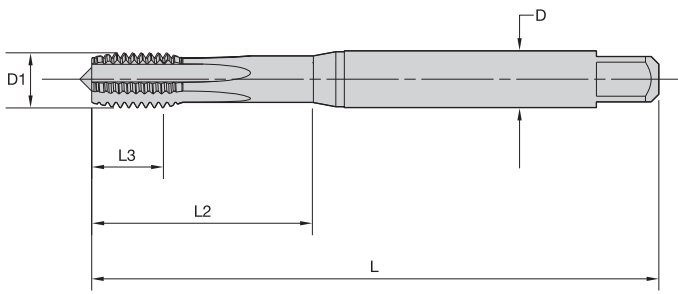

KSSH22 • TiCN for tapping steel 44–55 HRC.

■ T606 • DIN 371, 374, and 376 • Form C Semi-Bottoming Chamfer • Metric

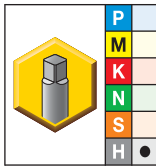

- first choice
- alternate choice

KSSH22	D1 size	L	L3	L2	D	number of flutes	dimension standard	class of fit
T606M060X100R6HX-D1	M6 x 1	80	10	30	6,0	4	DIN 371	6HX
T606MF080X100R6HX-D4	M8 x 1	90	10	35	8,0	5	DIN 374	6HX
T606M080X125R6HX-D1	M8 x 1,25	90	14	35	8,0	5	DIN 371	6HX
T606MF100X100R6HX-D4	M10 x 1	90	10	35	10,0	5	DIN 374	6HX
T606M100X150R6HX-D1	M10 x 1,5	100	16	39	10,0	5	DIN 371	6HX
T606MF120X150R6HX-D4	M12 x 1,5	100	15	—	9,0	5	DIN 374	6HX
T606M120X175R6HX-D6	M12 x 1,75	110	18	—	9,0	5	DIN 376	6HX
T606MF140X150R6HX-D4	M14 x 1,5	100	15	—	11,0	6	DIN 374	6HX
T606MF160X150R6HX-D4	M16 x 1,5	100	15	—	12,0	6	DIN 374	6HX
T606M160X200R6HX-D6	M16 x 2	110	22	—	12,0	6	DIN 376	6HX

Shank Tolerance

D	tolerance h9
1–3	+0, -0,025
3,5–6	+0, -0,030
7–10	+0, -0,036
11–18	+0, -0,043



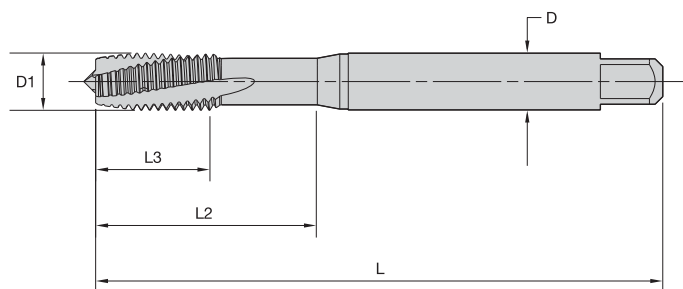

KSSH22 • TiCN for tapping cobalt and nickel alloys.

■ T610 • DIN 371 and 376 • Form D Plug Chamfer • Metric

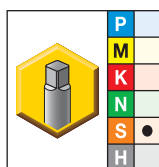

- first choice
- alternate choice

Taps

KSSH22	D1 size	L	L3	L2	D	number of flutes	dimension standard	class of fit
T610M030X050R6HX-D1	M3 x 0,5	56	11	18	3,5	2	DIN 371	6HX
T610M040X070R6HX-D1	M4 x 0,7	63	13	21	4,5	3	DIN 371	6HX
T610M050X080R6HX-D1	M5 x 0,8	70	15	25	6,0	3	DIN 371	6HX
T610M060X100R6HX-D1	M6 x 1	80	17	30	6,0	3	DIN 371	6HX
T610M080X125R6HX-D1	M8 x 1,25	90	20	35	8,0	3	DIN 371	6HX
T610M100X150R6HX-D1	M10 x 1,5	100	22	39	10,0	3	DIN 371	6HX
T610M120X175R6HX-D6	M12 x 1,75	110	24	—	9,0	3	DIN 376	6HX
T610M140X200R6HX-D6	M14 x 2	110	26	—	11,0	3	DIN 376	6HX
T610M160X200R6HX-D6	M16 x 2	110	27	—	12,0	3	DIN 376	6HX
T610M200X250R6HX-D6	M20 x 2,5	140	32	—	16,0	3	DIN 376	6HX

Shank Tolerance

D	tolerance h9
1-3	+0, -0,025
3,5-6	+0, -0,030
7-10	+0, -0,036
11-18	+0, -0,043

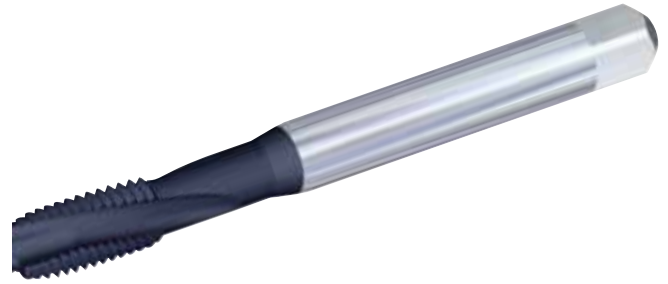
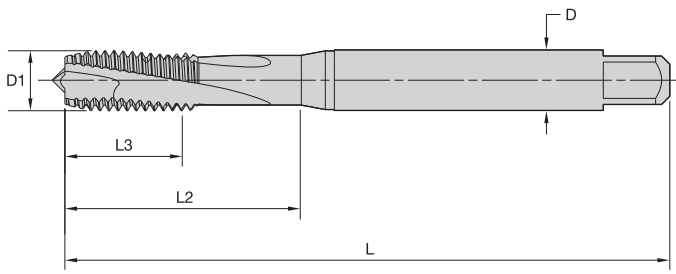

KSSH22 • TiCN for tapping cobalt and nickel alloys.

■ T612 • DIN 371 and 376 • Form C Semi-Bottoming Chamfer • Metric

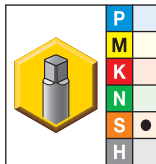

- first choice
- alternate choice

KSSH22	D1 size	L	L3	L2	D	number of flutes	dimension standard	class of fit
T612M030X050R6HX-D1	M3 x 0,5	56	11	18	3,5	2	DIN 371	6HX
T612M040X070R6HX-D1	M4 x 0,7	63	13	21	4,5	3	DIN 371	6HX
T612M050X080R6HX-D1	M5 x 0,8	70	15	25	6,0	3	DIN 371	6HX
T612M060X100R6HX-D1	M6 x 1	80	17	30	6,0	3	DIN 371	6HX
T612M080X125R6HX-D1	M8 x 1,25	90	20	35	8,0	3	DIN 371	6HX
T612M120X175R6HX-D6	M12 x 1,75	110	24	—	9,0	3	DIN 376	6HX
T612M100X150R6HX-D1	M10 x 1,5	100	22	39	10,0	3	DIN 371	6HX
T612M140X200R6HX-D6	M14 x 2	110	26	—	11,0	3	DIN 376	6HX
T612M160X200R6HX-D6	M16 x 2	110	27	—	12,0	3	DIN 376	6HX
T612M200X250R6HX-D6	M20 x 2,5	140	32	—	16,0	3	DIN 376	6HX

Shank Tolerance

D	tolerance h9
1-3	+0, -0,025
3,5-6	+0, -0,030
7-10	+0, -0,036
11-18	+0, -0,043



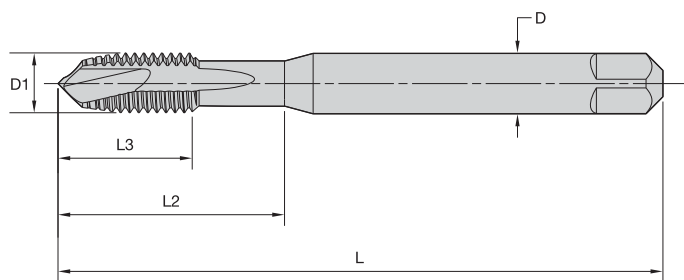

KSN25 • TiN/DLC for tapping titanium and titanium alloys.

■ T614 • DIN 371 and 376 • Form D Plug Chamfer • Metric



Taps

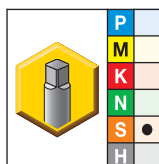

- first choice
- alternate choice

KSN25	D1 size	L	L3	L2	D	number of flutes	dimension standard	class of fit
T614M030X050R6HX-D1	M3 x 0,5	56	11	18	3,5	3	DIN 371	6HX
T614M040X070R6HX-D1	M4 x 0,7	63	13	21	4,5	3	DIN 371	6HX
T614M050X080R6HX-D1	M5 x 0,8	70	15	25	6,0	3	DIN 371	6HX
T614M060X100R6HX-D1	M6 x 1	80	17	30	6,0	3	DIN 371	6HX
T614M080X125R6HX-D1	M8 x 1,25	90	20	35	8,0	3	DIN 371	6HX
T614M100X150R6HX-D1	M10 x 1,5	100	22	39	10,0	3	DIN 371	6HX
T614M120X175R6HX-D6	M12 x 1,75	110	24	—	9,0	3	DIN 376	6HX

Shank Tolerance

D	tolerance h9
1-3	+0, -0,025
3,5-6	+0, -0,030
7-10	+0, -0,036
11-18	+0, -0,043

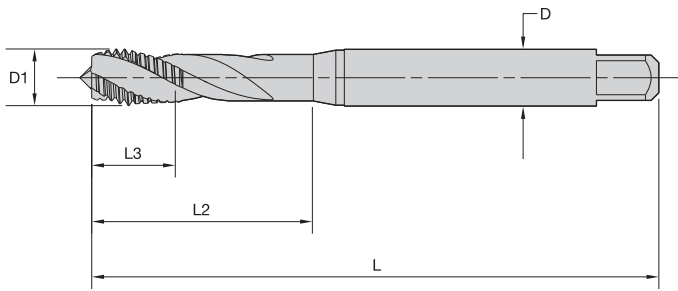

KSN25 • TiN/DLC for tapping titanium and titanium alloys.

■ T616 • DIN 371 • Form C Semi-Bottoming Chamfer • Metric

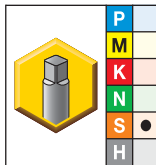

- first choice
- alternate choice

KSN25	D1 size	L	L3	L2	D	number of flutes	dimension standard	class of fit
T616M030X050R6HX-D1	M3 x 0,5	56	6	18	3,5	3	DIN 371	6HX
T616M040X070R6HX-D1	M4 x 0,7	63	7	21	4,5	3	DIN 371	6HX
T616M050X080R6HX-D1	M5 x 0,8	70	8	25	6,0	3	DIN 371	6HX
T616M060X100R6HX-D1	M6 x 1	80	10	30	6,0	3	DIN 371	6HX
T616M080X125R6HX-D1	M8 x 1,25	90	14	35	8,0	3	DIN 371	6HX
T616M100X150R6HX-D1	M10 x 1,5	100	16	39	10,0	3	DIN 371	6HX
T616M120X175R6HX-D1	M12 x 1,75	110	18	44	12,0	3	DIN 371	6HX

Shank Tolerance

D	tolerance h9
1-3	+0, -0,025
3,5-6	+0, -0,030
7-10	+0, -0,036
11-18	+0, -0,043



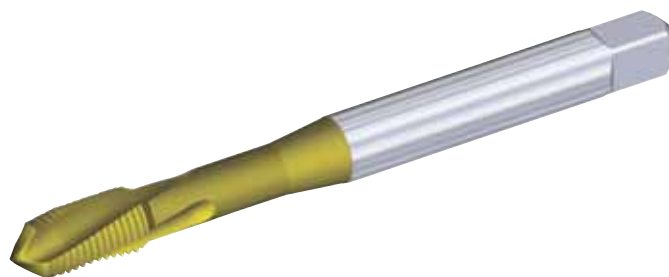
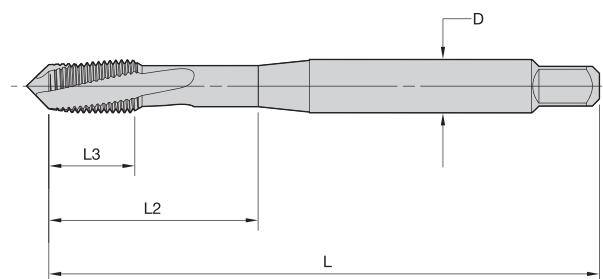

KM6515 • TiN + CrC/C for stainless steel.
 KP6525 • TiCN+ TiN for steel.

■ T620 • DIN 371, 374, and 376 • Form D Plug Chamfer • Metric

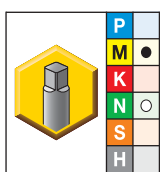
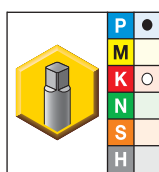

● first choice
 ○ alternate choice

Taps

	KP6525	KM6515	D1 size	L	L3	L2	D	number of flutes	dimension standard	class of fit
T620M030X050R6HX-D1		T620M030X050R6HX-D1	M3 x 0,5	56	8	18	3,5	3	DIN 371	6HX
T620M040X070R6HX-D1		T620M040X070R6HX-D1	M4 x 0,7	63	10	21	4,5	3	DIN 371	6HX
T620M050X080R6HX-D1		T620M050X080R6HX-D1	M5 x 0,8	70	10	25	6,0	3	DIN 371	6HX
T620M060X100R6HX-D1		T620M060X100R6HX-D1	M6 x 1	80	10	30	6,0	3	DIN 371	6HX
T620MF080X100R6HX-D4		T620MF080X100R6HX-D4	M8 x 1	90	13	35	6,0	3	DIN 374	6HX
T620M080X125R6HX-D1		T620M080X125R6HX-D1	M8 x 1,25	90	13	35	8,0	3	DIN 371	6HX
T620MF100X100R6HX-D4		T620MF100X100R6HX-D4	M10 x 1	90	10	35	7,0	3	DIN 374	6HX
T620MF100X125R6HX-D4		—	M10 x 1,25	100	15	39	7,0	3	DIN 374	6HX
T620M100X150R6HX-D1		T620M100X150R6HX-D1	M10 x 1,5	100	15	39	10,0	3	DIN 371	6HX
T620MF120X150R6HX-D4		T620MF120X150R6HX-D4	M12 x 1,5	100	15	39	9,0	3	DIN 374	6HX
T620M120X175R6HX-D6		T620M120X175R6HX-D6	M12 x 1,75	110	18	44	9,0	3	DIN 376	6HX
T620MF140X150R6HX-D4		T620MF140X150R6HX-D4	M14 x 1,5	100	15	47	11,0	4	DIN 374	6HX
T620M140X200R6HX-D6		T620M140X200R6HX-D6	M14 x 2	110	20	52	11,0	4	DIN 376	6HX
T620MF160X150R6HX-D4		T620MF160X150R6HX-D4	M16 x 1,5	100	15	46	12,0	4	DIN 374	6HX
T620M160X200R6HX-D6		T620M160X200R6HX-D6	M16 x 2	110	20	51	12,0	4	DIN 376	6HX
T620MF180X150R6HX-D4		T620MF180X150R6HX-D4	M18 x 1,5	110	15	50	14,0	4	DIN 374	6HX
T620M200X250R6HX-D6		T620M200X250R6HX-D6	M20 x 2,5	140	25	64	16,0	4	DIN 376	6HX

Shank Tolerance

D	tolerance h6
6	+0, -0,008
8-10	+0, -0,009
12-16	+0, -0,011

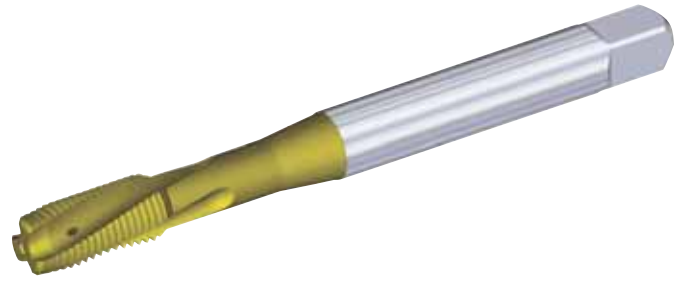
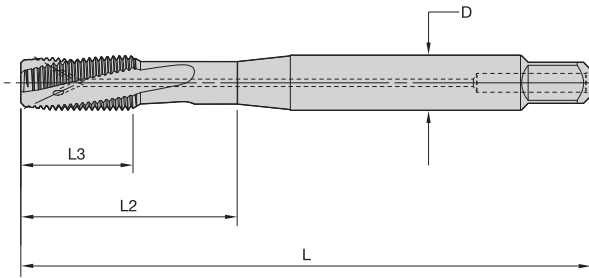

KM6515 • TiN + CrC/C for stainless steel.
 KP6525 • TiCN+ TiN for steel.

T621 • DIN 371, 374, and 376 • Form D Plug Chamfer • Through Coolant • Metric

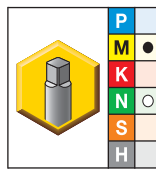
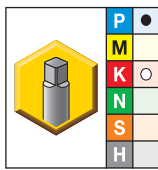

● first choice
 ○ alternate choice

		D1 size	L	L3	L2	D	number of flutes	dimension standard	class of fit
KP6525	KM6515								
T621M050X080R6HX-D1	T621M050X080R6HX-D1	M5 x 0,8	70	10	25	6,0	2	DIN 371	6HX
T621M060X100R6HX-D1	T621M060X100R6HX-D1	M6 x 1	80	10	30	6,0	3	DIN 371	6HX
T621MF080X100R6HX-D4	T621MF080X100R6HX-D4	M8 x 1	90	13	35	6,0	3	DIN 374	6HX
T621M080X125R6HX-D1	T621M080X125R6HX-D1	M8 x 1,25	90	13	35	8,0	3	DIN 371	6HX
T621MF100X100R6HX-D4	T621MF100X100R6HX-D4	M10 x 1	90	10	35	7,0	3	DIN 374	6HX
T621MF100X125R6HX-D4	T621MF100X125R6HX-D4	M10 x 1,25	100	15	39	7,0	3	DIN 374	6HX
T621M100X150R6HX-D1	T621M100X150R6HX-D1	M10 x 1,5	100	15	39	10,0	3	DIN 371	6HX
T621MF120X125R6HX-D4	—	M12 x 1,25	100	15	39	9,0	3	DIN 374	6HX
T621MF140X125R6HX-D4	—	M14 x 1,25	100	15	47	11,0	4	DIN 374	6HX
T621MF120X150R6HX-D4	T621MF120X150R6HX-D4	M12 x 1,5	100	15	39	9,0	3	DIN 374	6HX
T621M120X175R6HX-D6	T621M120X175R6HX-D6	M12 x 1,75	110	18	44	9,0	3	DIN 376	6HX
T621MF140X150R6HX-D4	T621MF140X150R6HX-D4	M14 x 1,5	100	15	47	11,0	4	DIN 374	6HX
T621M140X200R6HX-D6	T621M140X200R6HX-D6	M14 x 2	110	20	52	11,0	4	DIN 376	6HX
T621MF160X150R6HX-D4	T621MF160X150R6HX-D4	M16 x 1,5	100	15	46	12,0	4	DIN 374	6HX
T621M160X200R6HX-D6	T621M160X200R6HX-D6	M16 x 2	110	20	51	12,0	4	DIN 376	6HX
T621MF180X150R6HX-D4	T621MF180X150R6HX-D4	M18 x 1,5	110	15	50	14,0	4	DIN 374	6HX
T621M180X250R6HX-D6	T621M180X250R6HX-D6	M18 x 2,5	125	25	58	14,0	4	DIN 376	6HX

Shank Tolerance

D	tolerance h6
6	+0, -0,008
8-10	+0, -0,009
12-16	+0, -0,011



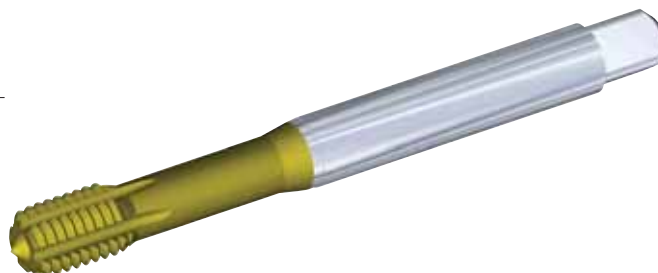
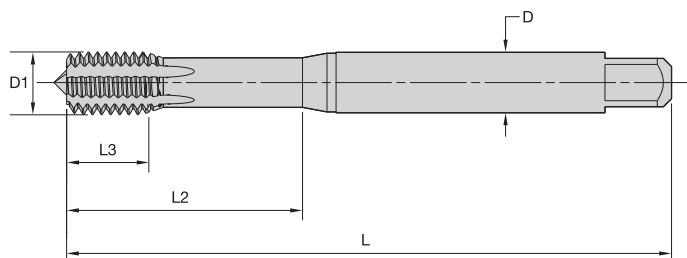

KSP21 • TiN for tapping steel.
KSN28 • DLC for tapping aluminium.

■ T622 • DIN 2174 • Form C Semi-Bottoming Entry Taper • Metric

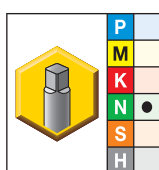
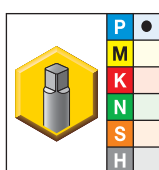

● first choice
○ alternate choice

Taps

	KSP21	KSN28	D1 size	L	L3	L2	D	number of lube grooves	dimension standard	class of fit
T622M030X050R6HX-D74	T622M030X050R6HX-D74	T622M030X050R6HX-D74	M3 x 0,5	56	6	18	3,5	4	DIN 2174	6HX
T622M040X070R6HX-D74	T622M040X070R6HX-D74	T622M040X070R6HX-D74	M5 x 0,7	63	7	21	4,5	4	DIN 2174	6HX
T622M050X080R6HX-D74	T622M050X080R6HX-D74	T622M050X080R6HX-D74	M5 x 0,8	70	8	25	6,0	4	DIN 2174	6HX
T622M060X100R6HX-D74	T622M060X100R6HX-D74	T622M060X100R6HX-D74	M6 x 1	80	10	30	6,0	5	DIN 2174	6HX
T622MF080X100R6HX-D74	T622MF080X100R6HX-D74	T622MF080X100R6HX-D74	M8 x 1	90	10	35	8,0	5	DIN 2174	6HX
T622M080X125R6HX-D74	T622M080X125R6HX-D74	T622M080X125R6HX-D74	M8 x 1,25	90	14	35	8,0	5	DIN 2174	6HX
T622MF100X100R6HX-D74	T622MF100X100R6HX-D74	T622MF100X100R6HX-D74	M10 x 1	90	10	35	10,0	5	DIN 2174	6HX
T622MF100X125R6HX-D74	T622MF100X125R6HX-D74	T622MF100X125R6HX-D74	M10 x 1,25	100	16	69	10,0	5	DIN 2174	6HX
T622M100X150R6HX-D74	T622M100X150R6HX-D74	T622M100X150R6HX-D74	M10 x 1,5	100	16	39	10,0	5	DIN 2174	6HX
T622MF120X125R6HX-D74	T622MF120X125R6HX-D74	T622MF120X125R6HX-D74	M12 x 1,25	100	15	27	9,0	6	DIN 2174	6HX
T622MF120X150R6HX-D74	T622MF120X150R6HX-D74	T622MF120X150R6HX-D74	M12 x 1,5	100	15	27	9,0	6	DIN 2174	6HX
T622M120X175R6HX-D74	T622M120X175R6HX-D74	T622M120X175R6HX-D74	M12 x 1,75	110	—	—	9,0	6	DIN 2174	6HX
T622MF140X150R6HX-D74	T622MF140X150R6HX-D74	T622MF140X150R6HX-D74	M14 x 1,5	100	—	—	11,0	6	DIN 2174	6HX
T622MF160X150R6HX-D74	T622MF160X150R6HX-D74	T622MF160X150R6HX-D74	M16 x 1,5	100	—	—	12,0	6	DIN 2174	6HX
T622M160X200R6HX-D74	T622M160X200R6HX-D74	T622M160X200R6HX-D74	M16 x 2	110	—	—	12,0	6	DIN 2174	6HX

Shank Tolerance

D	tolerance h9
1-3	+0, -0,025
3,5-6	+0, -0,030
7-10	+0, -0,036
11-18	+0, -0,043

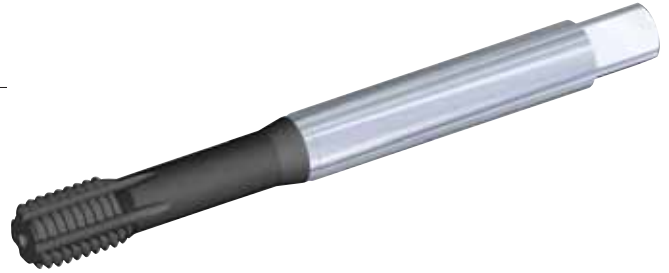
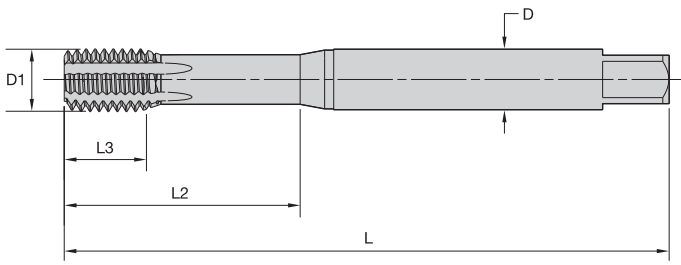

KSP21 • TiN for tapping steel.
KSP28 • DLC for tapping aluminium.

■ T623 • DIN 2174 • Form C Semi-Bottoming Entry Taper • Through Coolant • Metric

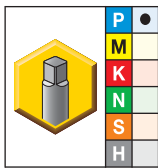

KSP21

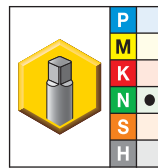

KSN28

● first choice
○ alternate choice

		D1 size	L	L3	L2	D	number of lube grooves	dimension standard	class of fit
T623M050X080R6HX-D74	T623M050X080R6HX-D74	M5 x 0,8	70	8	25	6,0	4	DIN 2174	6HX
T623M060X100R6HX-D74	T623M060X100R6HX-D74	M6 x 1	80	10	30	6,0	5	DIN 2174	6HX
T623MF080X100R6HX-D74	T623MF080X100R6HX-D74	M8 x 1	90	10	35	8,0	5	DIN 2174	6HX
T623M080X125R6HX-D74	T623M080X125R6HX-D74	M8 x 1,25	90	14	35	8,0	5	DIN 2174	6HX
T623MF100X100R6HX-D74	T623MF100X100R6HX-D74	M10 x 1	90	10	35	10,0	5	DIN 2174	6HX
T623M100X150R6HX-D74	T623M100X150R6HX-D1	M10 x 1,5	100	16	39	10,0	5	DIN 2174	6HX
T623MF120X150R6HX-D74	T623MF120X150R6HX-D74	M12 x 1,5	100	15	27	9,0	6	DIN 2174	6HX
T623M120X175R6HX-D74	T623M120X175R6HX-D74	M12 x 1,75	110	18	30	9,0	6	DIN 2174	6HX
T623MF140X150R6HX-D74	T623MF140X150R6HX-D74	M14 x 1,5	100	15	—	11,0	6	DIN 2174	6HX
T623MF160X150R6HX-D74	T623MF160X150R6HX-D74	M16 x 1,5	100	15	—	12,0	6	DIN 2174	6HX
T623M160X200R6HX-D74	T623M160X200R6HX-D74	M16 x 2	110	22	—	12,0	6	DIN 2174	6HX

Shank Tolerance

D	tolerance h9
1-3	+0, -0,025
3,5-6	+0, -0,030
7-10	+0, -0,036
11-18	+0, -0,043

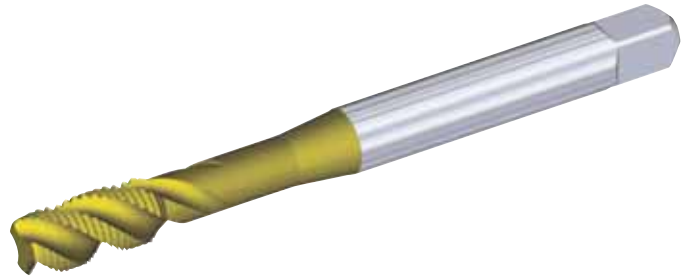
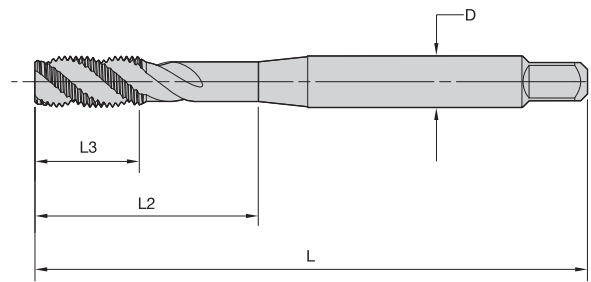

KM6515 • TiN + CrC/C for stainless steel.
 KP6525 • TiCN+ TiN for steel.
 KP6505 • Steam oxide for steel.

■ T630 • DIN 371, 374, and 376 • Form C Semi-Bottoming Chamfer • Metric

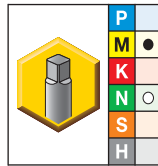
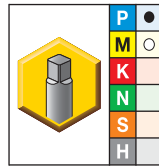
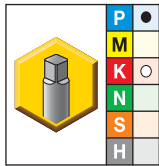

● first choice
 ○ alternate choice

Taps

KP6525		KP6505		KM6515		D1 size	L	L3	L2	D	number of flutes	dimension standard	class of fit
T630M030X050R6HX-D1	T630M030X050R6HX-D1	T630M030X050R6HX-D1	T630M030X050R6HX-D1	T630M030X050R6HX-D1	T630M030X050R6HX-D1	M3 x 0,5	56	8	18	3,5	3	DIN 371	6HX
T630M040X070R6HX-D1	T630M040X070R6HX-D1	T630M040X070R6HX-D1	T630M040X070R6HX-D1	T630M040X070R6HX-D1	T630M040X070R6HX-D1	M4 x 0,7	63	10	21	4,5	3	DIN 371	6HX
T630M050X080R6HX-D1	T630M050X080R6HX-D1	T630M050X080R6HX-D1	T630M050X080R6HX-D1	T630M050X080R6HX-D1	T630M050X080R6HX-D1	M5 x 0,8	70	10	25	6,0	3	DIN 371	6HX
T630M060X100R6HX-D1	T630M060X100R6HX-D1	T630M060X100R6HX-D1	T630M060X100R6HX-D1	T630M060X100R6HX-D1	T630M060X100R6HX-D1	M6 x 1	80	10	30	6,0	3	DIN 371	6HX
T630MF080X100R6HX-D4	—	T630MF080X100R6HX-D4	—	T630MF080X100R6HX-D4	—	M8 x 1	90	13	35	6,0	3	DIN 374	6HX
T630M080X125R6HX-D1	T630M080X125R6HX-D1	T630M080X125R6HX-D1	T630M080X125R6HX-D1	T630M080X125R6HX-D1	T630M080X125R6HX-D1	M8 x 1,25	90	13	35	8,0	3	DIN 371	6HX
T630MF100X100R6HX-D4	—	T630MF100X100R6HX-D4	—	T630MF100X100R6HX-D4	—	M10 x 1	90	10	35	7,0	3	DIN 374	6HX
T630MF100X125R6HX-D4	—	T630MF100X125R6HX-D4	—	T630MF100X125R6HX-D4	—	M10 x 1,25	100	15	39	7,0	3	DIN 374	6HX
T630M100X150R6HX-D1	T630M100X150R6HX-D1	T630M100X150R6HX-D1	T630M100X150R6HX-D1	T630M100X150R6HX-D1	T630M100X150R6HX-D1	M10 x 1,5	100	15	39	10,0	3	DIN 371	6HX
T630MF120X150R6HX-D4	—	T630MF120X150R6HX-D4	—	T630MF120X150R6HX-D4	—	M12 x 1,5	100	15	39	9,0	3	DIN 374	6HX
T630M120X175R6HX-D6	T630M120X175R6HX-D6	T630M120X175R6HX-D6	T630M120X175R6HX-D6	T630M120X175R6HX-D6	T630M120X175R6HX-D6	M12 x 1,75	110	18	44	9,0	3	DIN 376	6HX
T630MF140X150R6HX-D4	—	T630MF140X150R6HX-D4	—	T630MF140X150R6HX-D4	—	M14 x 1,5	100	15	47	11,0	4	DIN 374	6HX
T630M140X200R6HX-D6	T630M140X200R6HX-D6	T630M140X200R6HX-D6	T630M140X200R6HX-D6	T630M140X200R6HX-D6	T630M140X200R6HX-D6	M14 x 2	110	20	52	11,0	4	DIN 376	6HX
T630MF160X150R6HX-D4	—	T630MF160X150R6HX-D4	—	T630MF160X150R6HX-D4	—	M16 x 1,5	100	15	46	12,0	4	DIN 374	6HX
T630M160X200R6HX-D6	T630M160X200R6HX-D6	T630M160X200R6HX-D6	T630M160X200R6HX-D6	T630M160X200R6HX-D6	T630M160X200R6HX-D6	M16 x 2	110	20	51	12,0	4	DIN 376	6HX
T630MF180X150R6HX-D4	—	T630MF180X150R6HX-D4	—	T630MF180X150R6HX-D4	—	M18 x 1,5	110	15	50	14,0	4	DIN 374	6HX
T630M180X250R6HX-D6	T630M180X250R6HX-D6	T630M180X250R6HX-D6	T630M180X250R6HX-D6	T630M180X250R6HX-D6	T630M180X250R6HX-D6	M18 x 2,5	125	25	58	14,0	4	DIN 376	6HX
—	T630M200X250R6HX-D6	—	T630M200X250R6HX-D6	—	—	M20 x 2,5	140	25	64	16,0	4	DIN 376	6HX

Shank Tolerance

D	tolerance h6
6	+0, -0,008
8-10	+0, -0,009
12-16	+0, -0,011

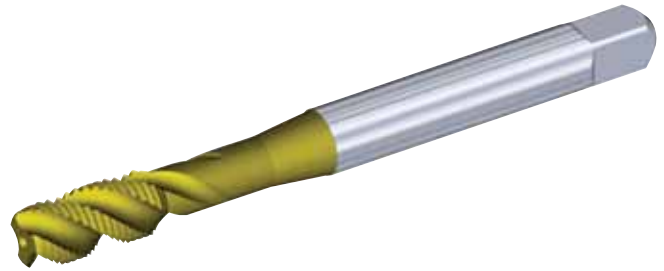
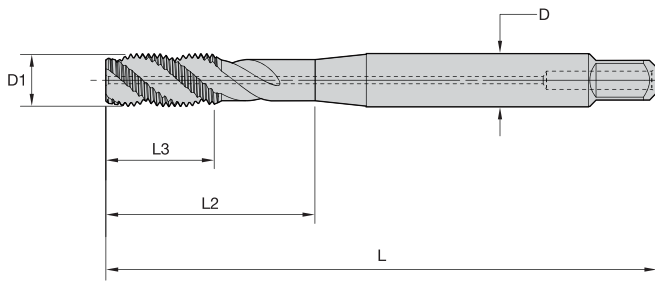

KM6515 • TiN + CrC/C for stainless steel.
 KP6525 • TiCN+ TiN for steel.

■ T631 • DIN 371, 374, and 376 • Form C Semi-Bottoming Chamfer • Through Coolant • Metric

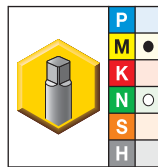
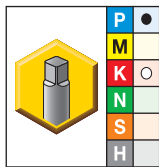

● first choice
 ○ alternate choice

		D1 size	L	L3	L2	D	number of flutes	dimension standard	class of fit
KP6525	KM6515								
T631M050X080R6HX-D1	T631M050X080R6HX-D1	M5 x 0,8	70	10	25	6,0	3	DIN 371	6HX
T631M060X100R6HX-D1	T631M060X100R6HX-D1	M6 x 1	80	10	30	6,0	3	DIN 371	6HX
T631MF080X100R6HX-D4	T631MF080X100R6HX-D4	M8 x 1	90	13	35	6,0	3	DIN 374	6HX
T631M080X125R6HX-D1	T631M080X125R6HX-D1	M8 x 1,25	90	13	35	8,0	3	DIN 371	6HX
T631MF100X100R6HX-D4	T631MF100X100R6HX-D4	M10 x 1	90	10	35	7,0	3	DIN 374	6HX
T631MF100X125R6HX-D4	T631MF100X125R6HX-D4	M10 x 1,25	100	15	39	7,0	3	DIN 374	6HX
T631M100X150R6HX-D1	T631M100X150R6HX-D1	M10 x 1,5	100	15	39	10,0	3	DIN 371	6HX
T631MF120X125R6HX-D4	T631MF120X125R6HX-D4	M12 x 1,25	100	15	39	9,0	4	DIN 374	6HX
T631MF140X125R6HX-D4	T631MF140X125R6HX-D4	M14 x 1,25	100	15	47	11,0	4	DIN 374	6HX
T631MF120X150R6HX-D4	T631MF120X150R6HX-D4	M12 x 1,5	100	15	39	9,0	4	DIN 374	6HX
T631M120X175R6HX-D6	T631M120X175R6HX-D6	M12 x 1,75	110	18	44	9,0	4	DIN 376	6HX
T631MF140X150R6HX-D4	T631MF140X150R6HX-D4	M14 x 1,5	100	15	47	11,0	4	DIN 374	6HX
T631M140X200R6HX-D6	T631M140X200R6HX-D6	M14 x 2	110	20	52	11,0	4	DIN 376	6HX
T631MF160X150R6HX-D4	T631MF160X150R6HX-D4	M16 x 1,5	100	15	46	12,0	4	DIN 374	6HX
T631M160X200R6HX-D6	T631M160X200R6HX-D6	M16 x 2	110	20	51	12,0	4	DIN 376	6HX
T631MF180X150R6HX-D4	T631MF180X150R6HX-D4	M18 x 1,5	110	15	50	14,0	4	DIN 374	6HX
T631M180X250R6HX-D6	T631M180X250R6HX-D6	M18 x 2,5	125	25	58	13,0	4	DIN 376	6HX

Shank Tolerance

D	tolerance h6
6	+0, -0,008
8-10	+0, -0,009
12-16	+0, -0,011



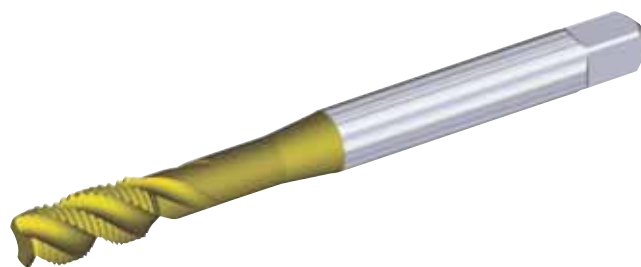
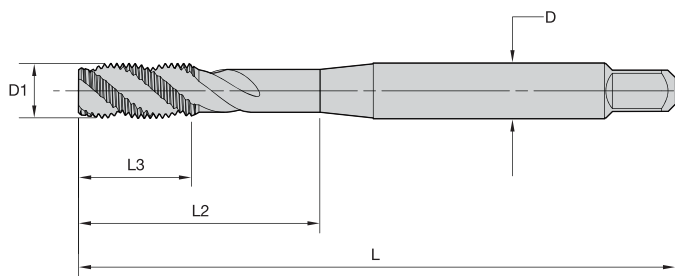

KP6525 • TiCN+TiN for tapping steel.

T632 • DIN 371, 374, and 376 • Form E Bottoming Chamfer • Metric

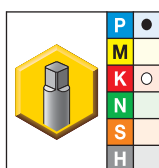

● first choice
○ alternate choice

Taps

KP6525	D1 size	L	L3	L2	D	number of flutes	dimension standard	class of fit
T632M050X080R6HX-D1	M5 x 0,8	70	10	25	6,0	3	DIN 371	6HX
T632M060X100R6HX-D1	M6 x 1	80	10	30	6,0	3	DIN 371	6HX
T632M080X125R6HX-D1	M8 x 1,25	90	13	35	8,0	3	DIN 371	6HX
T632M100X150R6HX-D1	M10 x 1,5	100	15	39	10,0	3	DIN 371	6HX
T632MF120X150R6HX-D4	M12 x 1,5	100	15	39	9,0	4	DIN 374	6HX
T632M120X175R6HX-D6	M12 x 1,75	110	18	44	9,0	4	DIN 376	6HX
T632MF140X150R6HX-D4	M14 x 1,5	100	15	47	11,0	4	DIN 374	6HX
T632M140X200R6HX-D6	M14 x 2	110	20	52	11,0	4	DIN 376	6HX
T632MF160X150R6HX-D4	M16 x 1,5	100	15	46	12,0	4	DIN 374	6HX

Shank Tolerance

D	tolerance h6
6	+0, -0,008
8-10	+0, -0,009
12-16	+0, -0,011

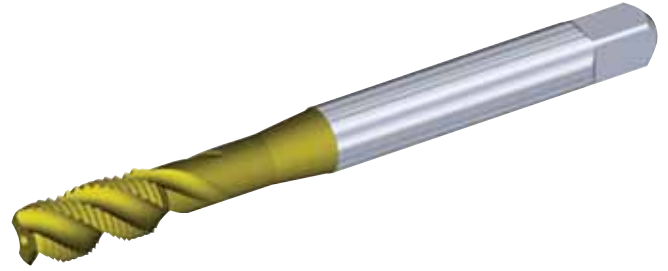
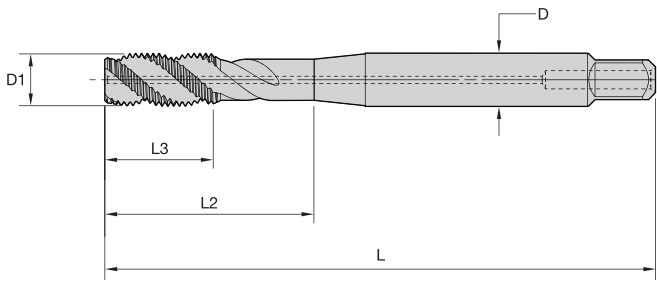

KP6525 • TiCN+TiN for tapping steel.

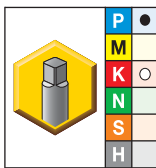
T633 • DIN 371, 374, and 376 • Form E Bottoming Chamfer • Through Coolant • Metric

- first choice
- alternate choice

KP6525	D1 size	L	L3	L2	D	number of flutes	dimension standard	class of fit
T633M050X080R6HX-D1	M5 x 0,8	70	10	25	6,0	3	DIN 371	6HX
T633M060X100R6HX-D1	M6 x 1	80	10	30	6,0	3	DIN 371	6HX
T633M080X125R6HX-D1	M8 x 1,25	90	13	35	8,0	3	DIN 371	6HX
T633M100X150R6HX-D1	M10 x 1,5	100	15	39	10,0	3	DIN 371	6HX
T633MF120X150R6HX-D4	M12 x 1,5	100	15	39	9,0	4	DIN 374	6HX
T633M120X175R6HX-D6	M12 x 1,75	110	18	44	9,0	4	DIN 376	6HX
T633MF140X150R6HX-D4	M14 x 1,5	100	15	47	11,0	4	DIN 374	6HX
T633M140X200R6HX-D6	M14 x 2	110	20	52	11,0	4	DIN 376	6HX
T633MF160X150R6HX-D4	M16 x 1,5	100	15	46	12,0	4	DIN 374	6HX

Shank Tolerance

D	tolerance h6
6	+0, -0,008
8-10	+0, -0,009
12-16	+0, -0,011



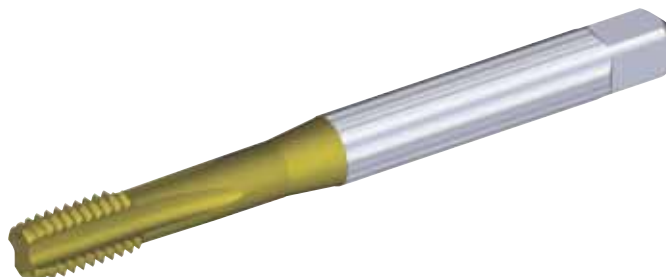
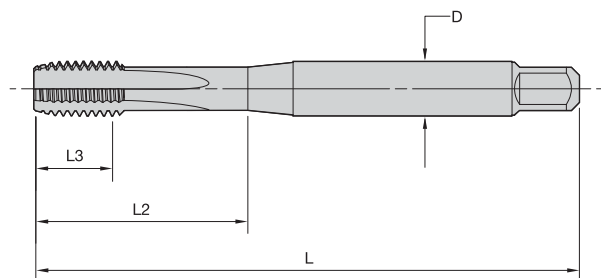

KP6525 • TiCN+ TiN for cast iron and cast aluminium.

■ T640 • DIN 371 and 376 • Form C Semi-Bottoming Chamfer • Metric

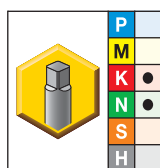

- first choice
- alternate choice

Taps

Model	D1 size	L	L3	L2	D	number of flutes	dimension standard	class of fit
KP6525								
T640M040X070R6HX-D1	M4 x 0,7	63	10	21	4,5	3	DIN 371	6HX
T640M050X080R6HX-D1	M5 x 0,8	70	10	25	6,0	3	DIN 371	6HX
T640M060X100R6HX-D1	M6 x 1	80	10	30	6,0	4	DIN 371	6HX
T640M080X125R6HX-D1	M8 x 1,25	90	13	35	8,0	4	DIN 371	6HX
T640M100X150R6HX-D1	M10 x 1,5	100	15	39	10,0	4	DIN 371	6HX
T640M120X175R6HX-D6	M12 x 1,75	110	18	44	9,0	4	DIN 376	6HX
T640M140X200R6HX-D6	M14 x 2	110	20	52	11,0	4	DIN 376	6HX
T640M160X200R6HX-D6	M16 x 2	110	20	51	12,0	4	DIN 376	6HX
T640M180X250R6HX-D6	M18 x 2,5	125	25	58	14,0	4	DIN 376	6HX
T640M200X250R6HX-D6	M20 x 2,5	140	25	64	16,0	4	DIN 376	6HX
T640M220X250R6HX-D6	M22 x 2,5	140	25	64	16,0	4	DIN 376	6HX

Shank Tolerance

D	tolerance h6
6	+0, -0,008
8-10	+0, -0,009
12-16	+0, -0,011

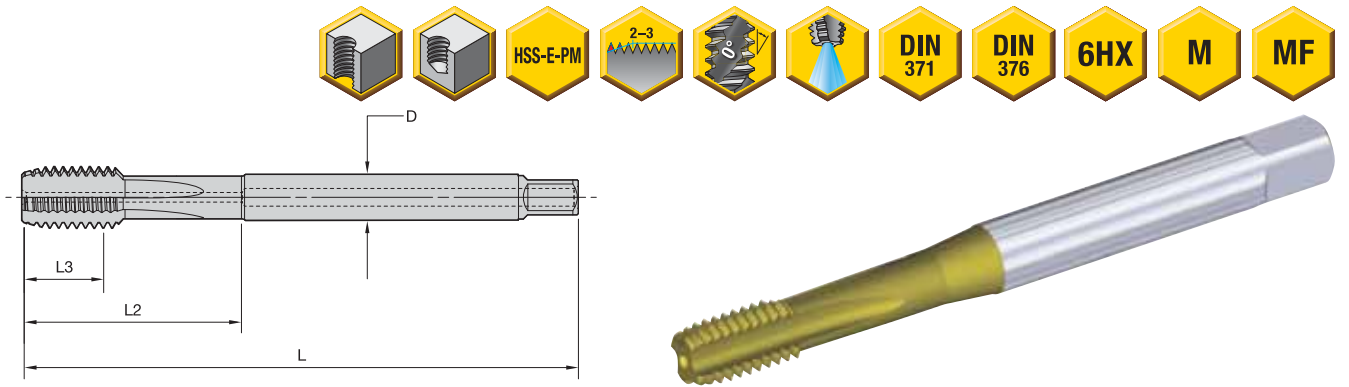

KP6525 • TiCN+ TiN for cast iron and cast aluminium.

■ T641 • DIN 371 and 376 • Form C Semi-Bottoming Chamfer • Through Coolant • Metric

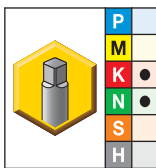

- first choice
- alternate choice

KP6525	D1 size	L	L3	L2	D	number of flutes	dimension standard	class of fit
T641M050X080R6HX-D1	M5 x 0,8	70	10	25	6,0	3	DIN 371	6HX
T641M060X100R6HX-D1	M6 x 1	80	10	30	6,0	4	DIN 371	6HX
T641M080X125R6HX-D1	M8 x 1,25	90	13	35	8,0	4	DIN 371	6HX
T641M100X150R6HX-D1	M10 x 1,5	100	15	39	10,0	4	DIN 371	6HX
T641M120X175R6HX-D6	M12 x 1,75	110	18	44	9,0	4	DIN 376	6HX
T641M140X200R6HX-D6	M14 x 2	110	20	52	11,0	4	DIN 376	6HX
T641M160X200R6HX-D6	M16 x 2	110	20	51	12,0	4	DIN 376	6HX
T641M180X250R6HX-D6	M18 x 2,5	125	25	58	14,0	4	DIN 376	6HX
T641M200X250R6HX-D6	M20 x 2,5	140	25	64	16,0	4	DIN 376	6HX

Shank Tolerance

D	tolerance h6
6	+0, -0,008
8-10	+0, -0,009
12-16	+0, -0,011



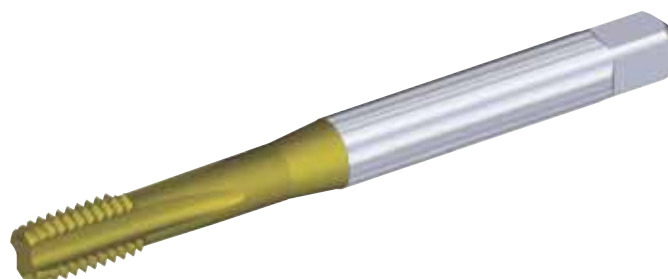
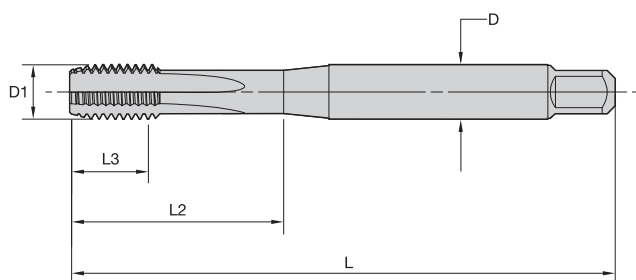

KP6525 • TiCN+TiN for cast iron and cast silicon aluminium.

T642 • DIN 371, 374, and 376 • Form E Bottoming Chamfer • Metric

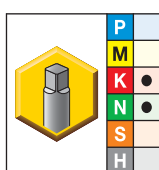

- first choice
- alternate choice

Taps

KP6525	D1 size	L	L3	L2	D	number of flutes	dimension standard	class of fit
T642M050X080R6HX-D1	M5 x 0,8	70	10	25	6,0	3	DIN 371	6HX
T642M060X100R6HX-D1	M6 x 1	80	10	30	6,0	4	DIN 371	6HX
T642M080X125R6HX-D1	M8 x 1,25	90	13	35	8,0	4	DIN 371	6HX
T642M100X150R6HX-D1	M10 x 1,5	100	15	39	10,0	4	DIN 371	6HX
T642MF120X150R6HX-D4	M12 x 1,5	100	15	39	9,0	4	DIN 374	6HX
T642M120X175R6HX-D6	M12 x 1,75	110	18	44	9,0	4	DIN 376	6HX
T642MF140X150R6HX-D4	M14 x 1,5	100	15	47	11,0	4	DIN 374	6HX
T642M140X200R6HX-D6	M14 x 2	110	20	52	11,0	4	DIN 376	6HX
T642MF160X150R6HX-D4	M16 x 1,5	100	15	46	12,0	4	DIN 374	6HX

Shank Tolerance

D	tolerance h6
6	+0, -0,008
8-10	+0, -0,009
12-16	+0, -0,011

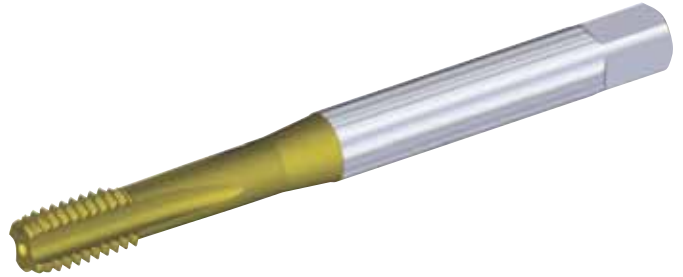
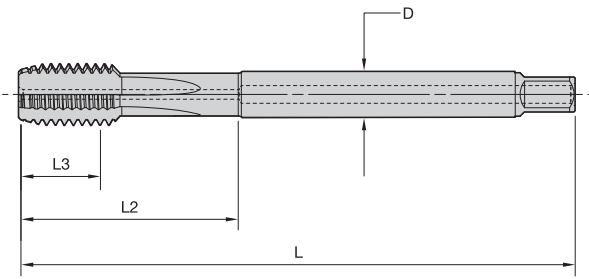

KP6525 • TiCN+TiN for tapping cast iron and cast silicon aluminium.

■ T643 • DIN 371, 374, and 376 • Form E Bottoming Chamfer • Through Coolant • Metric

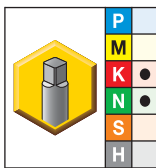

- first choice
- alternate choice

Part Number	D1 size	L	L3	L2	D	number of flutes	dimension standard	class of fit
T643M050X080R6HX-D1	M5 x 0,8	70	10	25	6,0	3	DIN 371	6HX
T643M060X100R6HX-D1	M6 x 1	80	10	30	6,0	4	DIN 371	6HX
T643M080X125R6HX-D1	M8 x 1,25	90	13	35	8,0	4	DIN 371	6HX
T643M100X150R6HX-D1	M10 x 1,5	100	15	39	10,0	4	DIN 371	6HX
T643MF120X150R6HX-D4	M12 x 1,5	100	15	39	9,0	4	DIN 374	6HX
T643M120X175R6HX-D6	M12 x 1,75	110	18	44	9,0	4	DIN 376	6HX
T643MF140X150R6HX-D4	M14 x 1,5	100	15	47	11,0	4	DIN 374	6HX
T643M140X200R6HX-D6	M14 x 2	110	20	52	11,0	4	DIN 376	6HX
T643MF160X150R6HX-D4	M16 x 1,5	100	15	46	12,0	4	DIN 374	6HX

Shank Tolerance

D	tolerance h6
6	+0, -0,008
8-10	+0, -0,009
12-16	+0, -0,011



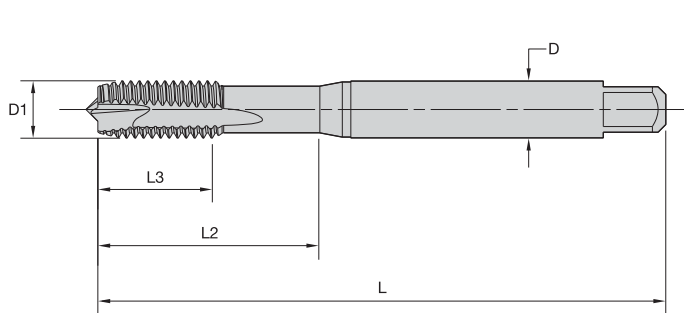

KSN38 • DLC for tapping aluminium.

T670 • DIN 371 and 376 • Form B Plug Chamfer • Metric

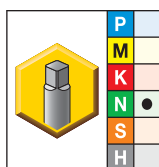

- first choice
- alternate choice

Taps

KSN38	D1 size	L	L3	L2	D	number of flutes	dimension standard	class of fit
T670M030X050R6H-D1	M3 x 0,5	56	11	18	3,5	2	DIN 371	6H
T670M040X070R6H-D1	M4 x 0,7	63	13	21	4,5	2	DIN 371	6H
T670M050X080R6H-D1	M5 x 0,8	70	15	25	6,0	2	DIN 371	6H
T670M060X100R6H-D1	M6 x 1	80	17	30	6,0	2	DIN 371	6H
T670M080X125R6H-D1	M8 x 1,25	90	20	35	8,0	2	DIN 371	6H
T670M100X150R6H-D1	M10 x 1,5	100	22	39	10,0	2	DIN 371	6H
T670M120X175R6H-D6	M12 x 1,75	110	24	—	9,0	3	DIN 376	6H
T670M160X200R6H-D6	M16 x 2	110	27	—	12,0	3	DIN 376	6H

Shank Tolerance

D	tolerance h9
1-3	+0, -0,025
3,5-6	+0, -0,030
7-10	+0, -0,036
11-18	+0, -0,043

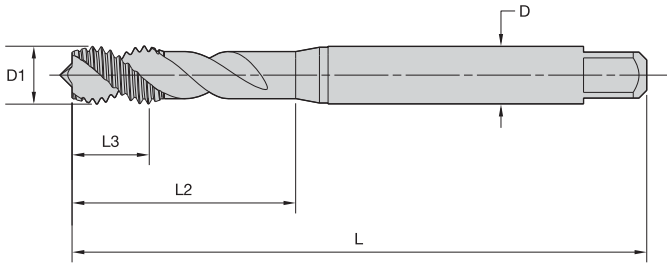

KSN38 • DLC for tapping aluminium.

■ T680 • DIN 371 and 376 • Form C Semi-Bottoming Chamfer • Metric

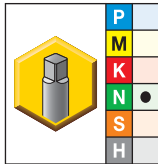

- first choice
- alternate choice

KSN38	D1 size	L	L3	L2	D	number of flutes	dimension standard	class of fit
T680M030X050R6H-D1	M3 x 0,5	56	6	18	3,5	2	DIN 371	6H
T680M040X070R6H-D1	M4 x 0,7	63	7	21	4,5	2	DIN 371	6H
T680M050X080R6H-D1	M5 x 0,8	70	8	25	6,0	2	DIN 371	6H
T680M060X100R6H-D1	M6 x 1	80	10	30	6,0	2	DIN 371	6H
T680M080X125R6H-D1	M8 x 1,25	90	14	35	8,0	2	DIN 371	6H
T680M100X150R6H-D1	M10 x 1,5	100	16	39	10,0	2	DIN 371	6H
T680M120X175R6H-D6	M12 x 1,75	110	18	—	9,0	3	DIN 376	6H
T680M160X200R6H-D6	M16 x 2	110	22	—	12,0	3	DIN 376	6H
T680M200X250R6H-D6	M20 x 2,5	140	25	—	16,0	3	DIN 376	6H

Shank Tolerance

D	tolerance h9
1-3	+0, -0,025
3,5-6	+0, -0,030
7-10	+0, -0,036
11-18	+0, -0,043

Taps

Wind Energy Taps



Primary Application

The new high-performance, large-sized HSS-E-PM Wind Taps were developed for manufacturers of some of the most important wind turbine components to increase productivity because of increased demand and can be used in conventional non-rigid and CNC-synchronous tapping machines. These Wind Taps are manufactured to DIN 376 dimensions and an extra-long version is available to reach the longer overhang that is common on these big components.

The precision h6 shanks enable use in either conventional tap holders with square drive or in precision round holders.

Features and Benefits

T620 LH Spiral Flute

- For through hole tapping.
- Push chips ahead, enabling free tapping on long chipping material.
- Form D plug chamfer.
- DIN 376 and extra-long versions available.

T630 RH Spiral Flute

- For blind hole tapping.
- Preferred for vertical tapping application.
- Form D plug chamfer.
- Internal coolant available as standard; see T631.
- DIN 376 and extra-long versions available.

T650 RH Spiral Flute

- For blind hole tapping.
- Preferred for horizontal tapping application.
- Form D plug chamfer.
- Internal coolant available as standard; see T651.
- DIN 376 and extra-long versions available.

T650 HSS-E-PM • Proven Solution

Case study:

- Manufacturer of large diameter bearing for wind turbines.

Conditions:

- Thread size: M24 x 2.5 6H
- Workpiece: bearing ring
- Material: low-carbon steel 1010 (C10)
- Thread depth: 35mm blind
- Tap drill size: 17,5mm
- Machine: CNC
- Coolant: water soluble



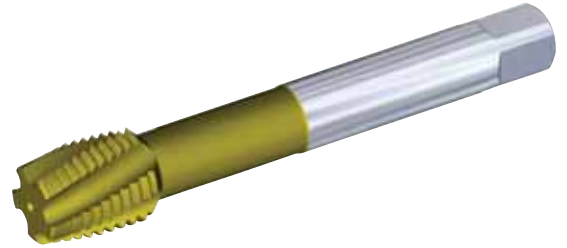
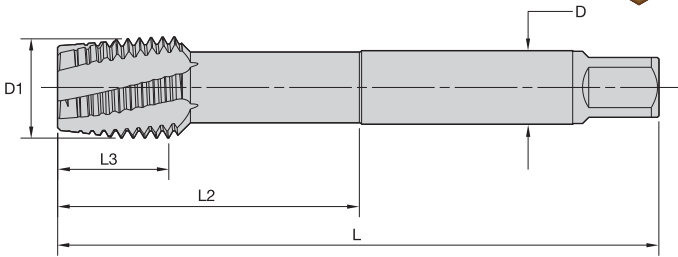

KP6525 • TiCN+TiN for tapping steel and cast iron.

■ T620 • DIN 376 • Form D Plug Chamfer • Larger Sizes • Metric

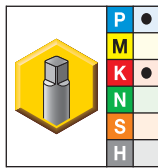

- first choice
- alternate choice

	D1 size	L	L3	L2	D	number of flutes	class of fit
KP6525							
T620M240X300R6HX-D6	M24 x 3	160	30	77	18,0	5	6HX
T620M300X350R6HX-D6	M30 x 3,5	180	35	91	22,0	5	6HX
T620M330X350R6HX-D6	M33 x 3,5	180	35	100	25,0	5	6HX
T620M360X400R6HX-D6	M36 x 4	200	40	110	28,0	6	6HX
T620M420X450R6HX-D6	M42 x 4,5	200	45	120	32,0	6	6HX

Shank Tolerance

D	tolerance h6
12-18	+0, -0,011
20-30	+0, -0,013
32-36	+0, -0,016

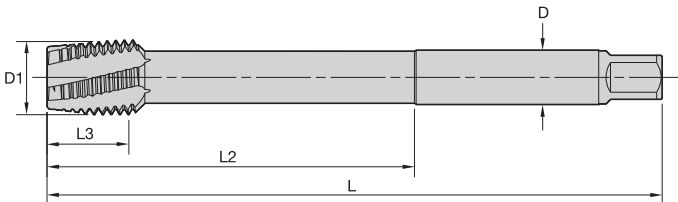

KP6525 • TiCN+TiN for tapping steel and cast iron.

■ T620 • Extra Long • Form D Plug Chamfer • Larger Sizes • Metric

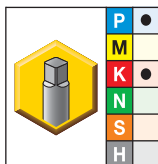

- first choice
- alternate choice

	D1 size	L	L3	L2	D	number of flutes	class of fit
KP6525							
T620M240X300R6H-XL	M24 x 3	200	30	120	18,0	5	6HX
T620M300X350R6H-XL	M30 x 3,5	250	35	150	22,0	5	6HX
T620M330X350R6H-XL	M33 x 3,5	250	35	150	25,0	5	6HX
T620M360X400R6H-XL	M36 x 4	250	40	150	28,0	6	6HX
T620M420X450R6H-XL	M42 x 4,5	300	45	180	32,0	6	6HX

Shank Tolerance

D	tolerance h6
12-18	+0, -0,011
20-30	+0, -0,013
32-36	+0, -0,016

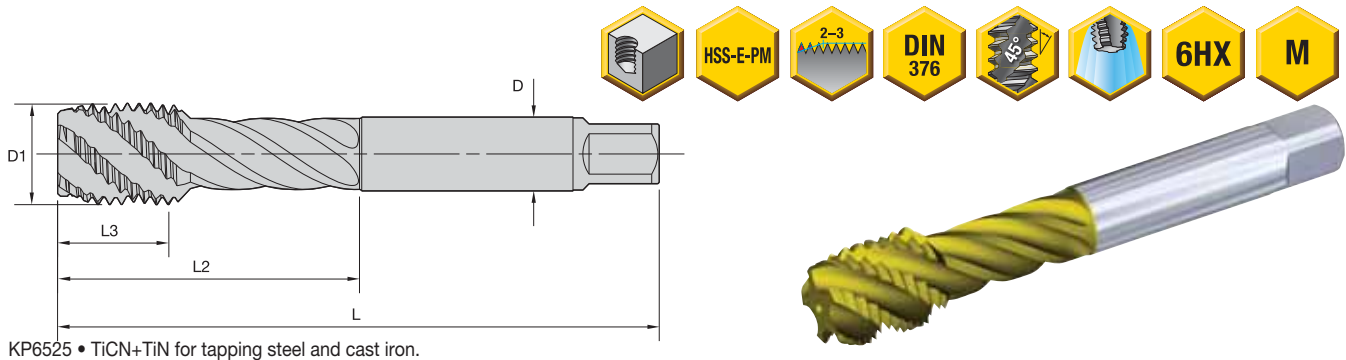

KP6525 • TiCN+TiN for tapping steel and cast iron.

■ T630 • DIN 376 • Form C Semi-Bottoming Chamfer • Larger Sizes • Metric

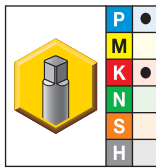

- first choice
- alternate choice

KP6525	D1 size	L	L3	L2	D	number of flutes	class of fit
T630M240X300R6HX-D6	M24 x 3	160	30	77	18,0	5	6HX
T630M300X350R6HX-D6	M30 x 3,5	180	35	91	22,0	5	6HX
T630M330X350R6HX-D6	M33 x 3,5	180	35	100	25,0	5	6HX
T630M360X400R6HX-D6	M36 x 4	200	40	110	28,0	5	6HX
T630M420X450R6HX-D6	M42 x 4,5	200	45	120	32,0	5	6HX

Shank Tolerance

D	tolerance h6
12-18	+0, -0,011
20-30	+0, -0,013
32-36	+0, -0,016

Taps

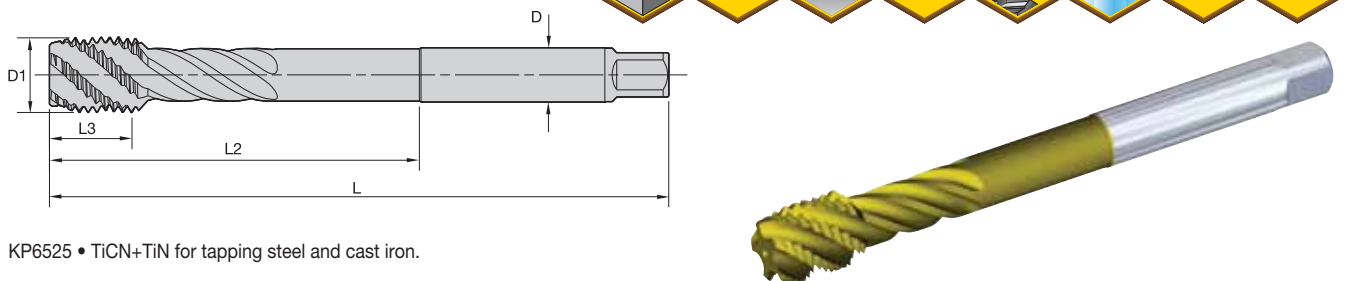

KP6525 • TiCN+TiN for tapping steel and cast iron.

■ T630 • Extra Long • Form C Semi-Bottoming Chamfer • Larger Sizes • Metric

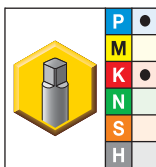

- first choice
- alternate choice

KP6525	D1 size	L	L3	L2	D	number of flutes	class of fit
T630M240X300R6HX-XL	M24 x 3	200	30	120	18,0	5	6HX
T630M300X350R6HX-XL	M30 x 3,5	250	35	150	22,0	5	6HX
T630M330X350R6HX-XL	M33 x 3,5	250	35	150	25,0	5	6HX
T630M360X400R6HX-XL	M36 x 4	250	40	150	28,0	5	6HX
T630M420X450R6HX-XL	M42 x 4,5	300	45	180	32,0	5	6HX

Shank Tolerance

D	tolerance h6
12-18	+0, -0,011
20-30	+0, -0,013
32-36	+0, -0,016

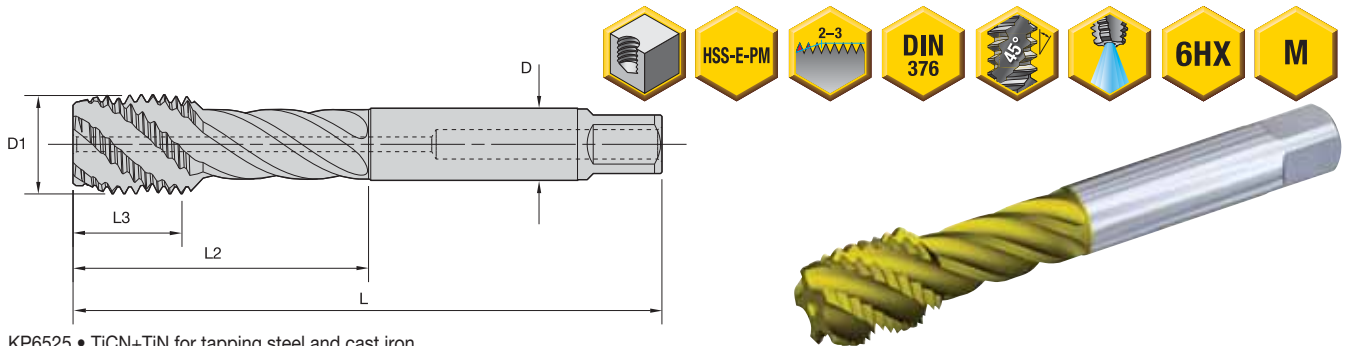

KP6525 • TiCN+TiN for tapping steel and cast iron.

■ T631 • DIN 376 • Form C Semi-Bottoming Chamfer • Through Coolant • Larger Sizes • Metric

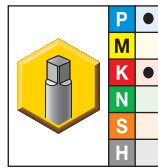

● first choice
○ alternate choice

KP6525	D1 size	L	L3	L2	D	number of flutes	class of fit
T631M240X300R6HX-D6	M24 x 3	160	30	77	18,0	5	6HX
T631M300X350R6HX-D6	M30 x 3,5	180	35	91	22,0	5	6HX
T631M330X350R6HX-D6	M33 x 3,5	180	35	100	25,0	5	6HX
T631M360X400R6HX-D6	M36 x 4	200	40	110	28,0	5	6HX
T631M420X450R6HX-D6	M42 x 4,5	200	45	120	32,0	5	6HX

Shank Tolerance

D	tolerance h6
12-18	+0, -0,011
20-30	+0, -0,013
32-36	+0, -0,016

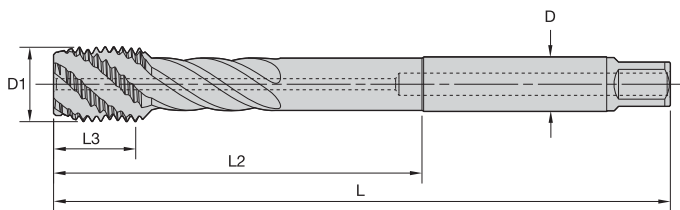

KP6525 • TiCN+TiN for tapping steel and cast iron.



■ T631 • Extra Long • Form C Semi-Bottoming Chamfer • Through Coolant • Larger Sizes • Metric

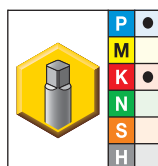

● first choice
○ alternate choice

KP6525	D1 size	L	L3	L2	D	number of flutes	class of fit
T631M240X300R6HX-XL	M24 x 3	200	30	120	18,0	5	6HX
T631M300X350R6HX-XL	M30 x 3,5	250	35	150	22,0	5	6HX
T631M330X350R6HX-XL	M33 x 3,5	250	35	150	25,0	5	6HX
T631M360X400R6HX-XL	M36 x 4	250	40	150	28,0	5	6HX
T631M420X450R6HX-XL	M42 x 4,5	300	45	180	32,0	5	6HX

Shank Tolerance

D	tolerance h6
12-18	+0, -0,011
20-30	+0, -0,013
32-36	+0, -0,016

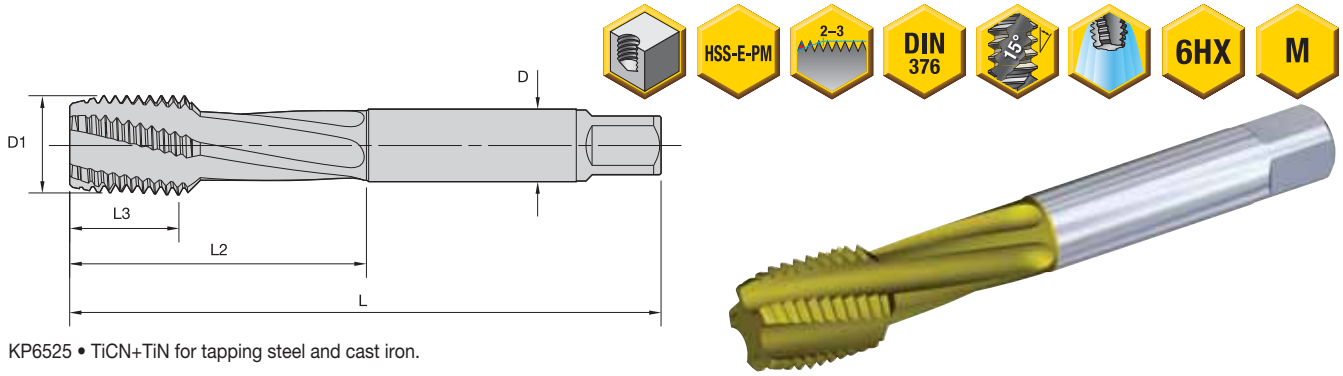

KP6525 • TiCN+TiN for tapping steel and cast iron.

■ T650 • DIN 376 • Form C Semi-Bottoming Chamfer • Larger Sizes • Metric

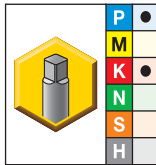

- first choice
- alternate choice

KP6525	D1 size	L	L3	L2	D	number of flutes	class of fit
T650M240X300R6HX-D6	M24 x 3	160	30	77	18,0	4	6HX
T650M300X350R6HX-D6	M30 x 3,5	180	35	91	22,0	5	6HX
T650M330X350R6HX-D6	M33 x 3,5	180	35	100	25,0	5	6HX
T650M360X400R6HX-D6	M36 x 4	200	40	110	28,0	5	6HX
T650M420X450R6HX-D6	M42 x 4,5	200	45	120	32,0	6	6HX

Shank Tolerance

D	tolerance h6
12-18	+0, -0,011
20-30	+0, -0,013
32-36	+0, -0,016

Taps

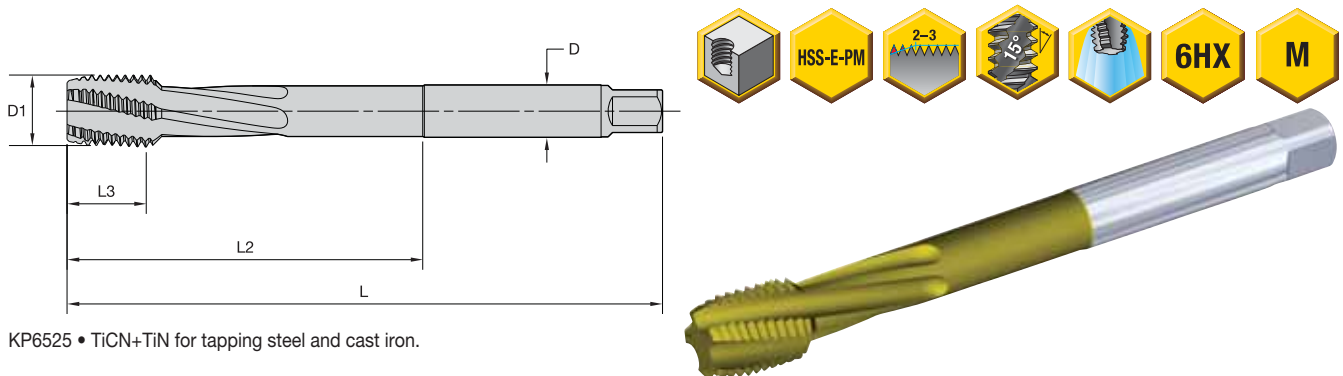

KP6525 • TiCN+TiN for tapping steel and cast iron.

■ T650 • Extra Long • Form C Semi-Bottoming Chamfer • Larger Sizes • Metric

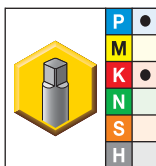

- first choice
- alternate choice

KP6525	D1 size	L	L3	L2	D	number of flutes	class of fit
T650M240X300R6HX-XL	M24 x 3	200	30	120	18,0	4	6HX
T650M300X350R6HX-XL	M30 x 3,5	250	35	150	22,0	5	6HX
T650M330X350R6HX-XL	M33 x 3,5	250	35	150	25,0	5	6HX
T650M360X400R6HX-XL	M36 x 4	250	40	150	28,0	5	6HX
T650M420X450R6HX-XL	M42 x 4,5	300	45	180	32,0	6	6HX

Shank Tolerance

D	tolerance h6
12-18	+0, -0,011
20-30	+0, -0,013
32-36	+0, -0,016

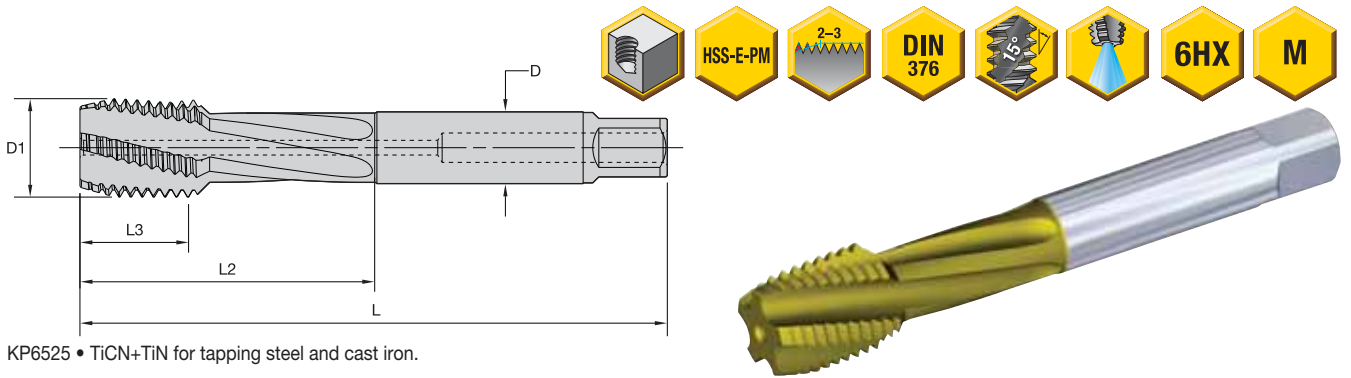

KP6525 • TiCN+TiN for tapping steel and cast iron.

■ T651 • DIN 376 • Form C Semi-Bottoming Chamfer • Through Hole • Larger Sizes • Metric

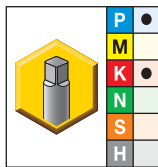

- first choice
- alternate choice

KP6525	D1 size	L	L3	L2	D	number of flutes	class of fit
T651M240X300R6HX-D6	M24 x 3	160	30	77	18,0	4	6HX
T651M300X350R6HX-D6	M30 x 3,5	180	35	91	22,0	5	6HX
T651M330X350R6HX-D6	M33 x 3,5	180	35	100	25,0	5	6HX
T651M360X400R6HX-D6	M36 x 4	200	40	110	28,0	5	6HX
T651M420X450R6HX-D6	M42 x 4,5	200	45	120	32,0	6	6HX

Shank Tolerance

D	tolerance h6
12-18	+0, -0,011
20-30	+0, -0,013
32-36	+0, -0,016

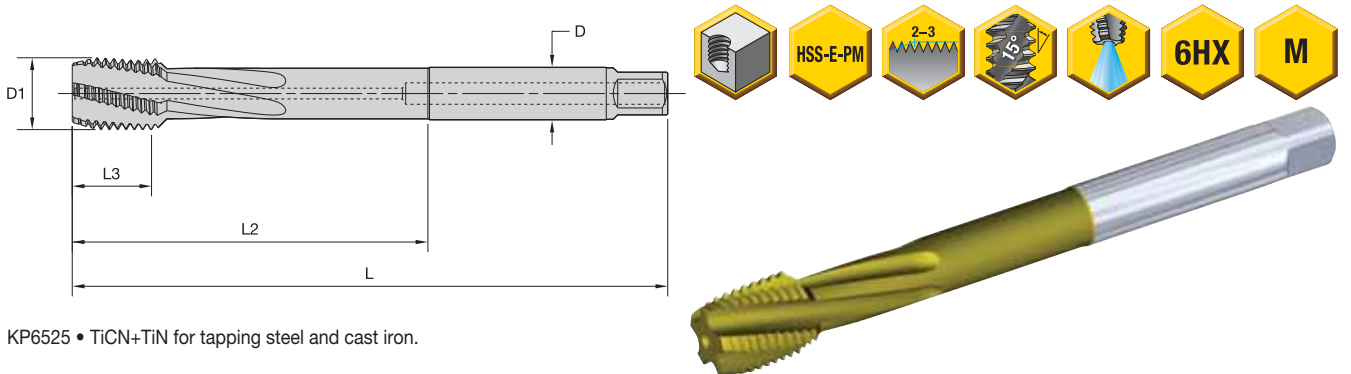

KP6525 • TiCN+TiN for tapping steel and cast iron.

■ T651 • Extra Long • Form C Semi-Bottoming Chamfer • Through Coolant • Larger Sizes • Metric

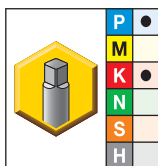

- first choice
- alternate choice

KP6525	D1 size	L	L3	L2	D	number of flutes	class of fit
T651M240X300R6HX-XL	M24 x 3	200	30	120	18,0	4	6HX
T651M300X350R6HX-XL	M30 x 3,5	250	35	150	22,0	5	6HX
T651M330X350R6HX-XL	M33 x 3,5	250	35	150	25,0	5	6HX
T651M360X400R6HX-XL	M36 x 4	250	40	150	28,0	5	6HX
T651M420X450R6HX-XL	M42 x 4,5	300	45	180	32,0	6	6HX

Shank Tolerance

D	tolerance h6
12-18	+0, -0,011
20-30	+0, -0,013
32-36	+0, -0,016

Material Group	 Through Holes					 Blind Holes					
	Tap Style	Grade	Range – m/min			Tap Style	Grade	Range – m/min			
			min	Starting Value	max			min	Starting Value	max	
P	1	T620	KP6525	20	30	45	T630,T632,T650	KP6525	14	21	32
		T622	KSP21	18	30	50	T622	KSP21	13	21	35
	2	T620	KP6525	17	25	38	T630,T632,T650	KP6525	12	18	26
		T622	KSP21	15	25	42	T622	KSP21	10	18	29
	3	T620	KP6525	12	15	20	T630,T632,T650	KP6525	8	11	14
	4	T600	KSP21	5	6	8	T602, T604	KSP21	3	4	5
M	5	T620	KP6525	12	15	20	T630,T632,T650	KP6525	8	11	14
	6	T600	KSP21	6	8	10	T602, T604	KSP21	4	6	7
	1	T620	KM6515	12	15	20	T630,T632,T650	KM6515	8	11	14
K	2	T620	KM6515	9	12	16	T630,T632,T650	KM6515	6	8	11
	3	T620	KM6515	8	10	13	T630,T632,T650	KM6515	5	7	9
	1	T640	KP6525	35	45	59	T640, T642	KP6525	24	32	41
N	2	T640	KP6525	31	40	52	T640, T642	KP6525	22	28	36
	3	T640	KP6525	23	30	39	T640, T642	KP6525	16	21	27
	1	T670	KSN38	42	55	72	T680	KSN38	30	39	50
S		T622	KSN28	37	55	83	T622	KSN28	26	39	58
	2	T640	KP6525	38	50	65	T640, T642	KP6525	27	35	46
		T622	KSN28	33	50	75	T622	KSN28	23	35	53
	4	T640	KP6525	4	6	9	T640, T642	KP6525	3	4	5
H	1	T620	KP6525	8	12	18	T630, T632	KP6525	6	8	11
	2	T610	KSSH22	3	5	8	T612	KSSH22	3	4	5
	3	T610	KSSH22	3	4	6	T612	KSSH22	2	3	4
	4	T614	KSN25	3	4	6	T616	KSN25	2	3	4
H	1	T606	KSSH22	1,3	2,0	3,0	T606	KSSH22	1,1	1,4	1,8
	2	T606	KSSH22	1,0	1,5	2,3	T606	KSSH22	0,8	1,1	1,4

NOTE: Increase speed by up to 25% when using coolant taps (T621,T623,T631,T633,T641,T643,T651).
Use grade KP6505™ in steels. Use 50% of the recommended speed listed for grade KP6525™.

Taps

Looking for a product that's not shown in this catalogue?
Check the Kennametal website!



Holemaking

Online product catalogue available 24/7

Visit <http://www.kennametal.com/holemaking/> to browse our electronic catalogue any time you're looking for Kennametal's best tooling solutions. It's fast, free, and always available. The online e-catalogue is updated weekly with products and solutions for milling, turning, holemaking, and tooling systems applications.



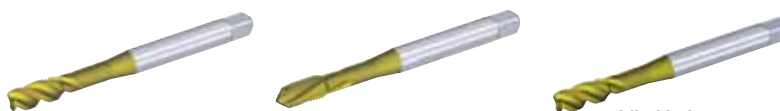

Steel • >32 HRC

P
HSS-E-PM Taps – Tapping Steel >32 HRC





typical thread sizes		required tap drill diameter						
cutting taps metric	inch	mm	inch	fraction	wire	blind hole	through hole	blind hole
						T630_KP6525	T620_KP6525	with coolant T631_KP6525
M3 x 0,50	—	2,500	.0984	—	—	T630M030X050R6HX-D1	T620M030X050R6HX-D1	—
—	5-40	2,578	.1015	—	38	T630NC#05-40R3BX-A	T620NC#05-40R3BX-A	—
—	6-32	2,705	.1065	—	36	T630NC#06-32R2BX-A	T620NC#06-32R2BX-A	—
M4 x 0,70	—	3,300	.1299	—	—	T630M040X070R6HX-D1	T620M040X070R6HX-D1	—
—	8-32	3,454	.1360	—	29	T630NC#08-32R2BX-A	T620NC#08-32R2BX-A	—
—	8-36	3,454	.1360	—	29	T630NF#08-36R3BX-A	T620NF#08-36R3BX-A	—
—	10-24	3,734	.1470	—	26	T630NC#10-24R3BX-A	T620NC#10-24R3BX-A	—
—	10-32	4,039	.1590	—	21	T630NF#10-32R2BX-A	T620NF#10-32R2BX-A	—
M5 x 0,80	—	4,200	.1654	—	—	T630M050X080R6HX-D1	T620M050X080R6HX-D1	T631M050X080R6HX-D1
—	12-24	4,496	.1770	—	16	T630NC#12-24R3BX-A	T620NC#12-24R3BX-A	—
M6 x 1,00	—	5,000	.1969	—	—	T630M060X100R6HX-D1	T620M060X100R6HX-D1	T631M060X100R6HX-D1
—	1/4-20	5,106	.2010	—	7	T630NC02500-20R2BX-A	T620NC02500-20R2BX-A	—
—	1/4-28	5,410	.2130	—	3	T630NF02500-28R2BX-A	T620NF02500-28R2BX-A	—
—	5/16-18	6,528	.2570	—	F	T630NC03125-18R2BX-A	T620NC03125-18R2BX-A	—
M8 x 1,25	—	6,700	.2638	—	—	T630M080X125R6HX-D1	T620M080X125R6HX-D1	T631M080X125R6HX-D1
M8 x 1,00	—	7,000	.2756	—	—	T630MF080X100R6HX D4	T620MF080X100R6HX D4	T631MF080X100R6HX D4
—	3/8-16	7,938	.3125	5/16	—	T630NC03750—16R3BX-A	T620NC03750-16R3BX-A	—
—	3/8-24	8,433	.3320	—	Q	T630NF03750—24R3BX-A	T620NF03750-24R3BX-A	—
M10 x 1,50	—	8,500	.3346	—	—	T630M100X150R6HX-D1	T620M100X150R6HX-D1	T631M100X150R6HX-D1
M10 x 1,25	—	8,700	.3425	—	—	T630MF100X125R6HX D4	—	T631MF100X125R6HX D4
M10 x 1,00	—	9,000	.3543	—	—	T630MF100X100R6HX D4	T620MF100X100R6HX D4	T631MF100X100R6HX D4
—	7/16-14	9,093	.3580	—	T	T630NC04375-14R3BX-A	T620NC04375-14R3BX-A	—
—	7/16-20	9,921	.3906	25/64	—	T630NF04375-20R3BX-A	T620NF04375-20R3BX-A	—
M12 x 1,75	—	10,200	.4016	—	—	T630M120X175R6HX-D6	T620M120X175R6HX-D6	T631M120X175R6HX-D6
M12 x 1,50	—	10,500	.4134	—	—	T630MF120X150R6HX-D4	T620MF120X150R6HX-D4	T631MF120X150R6HX-D4
—	1/2-13	10,716	.4219	27/64	—	T630NC05000-13R3BX-A	T620NC05000-13R3BX-A	—
M12 x 1,25	—	10,800	.4252	—	—	—	—	T631MF120X125R6HX-D4
—	1/2-20	11,509	.4531	29/64	—	T630NF05000-20R3BX-A	T620NF05000-20R3BX-A	—
M14 x 2,00	—	12,000	.4724	—	—	T630M140X200R6HX-D6	T620M140X200R6HX-D6	T631M140X200R6HX-D6
M14 x 1,50	—	12,500	.4921	—	—	T630MF140X150R6HX-D4	T620MF140X150R6HX-D4	T631MF140X150R6HX-D4
M16 x 2,00	—	14,000	.5512	—	—	T630M160X200R6HX-D6	T620M160X200R6HX-D6	T631M160X200R6HX-D6
M16 x 1,50	—	14,500	.5709	—	—	T630MF160X150R6HX-D4	T620MF160X150R6HX-D4	T631MF160X150R6HX-D4
M18 x 2,50	—	15,500	.6102	—	—	T630M180X250R6HX-D6	-	T631M180X250R6HX-D6
M18 x 1,50	—	16,500	.6496	—	—	T630MF180X150R6HX-D4	T620MF180X150R6HX-D4	T631MF180X150R6HX-D4
—	3/4-10	16,670	.6563	21/32	—	T630NC07500-10R3BX-A	T620NC07500-10R3BX-A	—
M20 x 2,50	—	17,500	.6890	—	—	T630M200X250R6HX-D6	T620M200X250R6HX-D6	T631M200X250R6HX-D6

Taps

HSS-E-PM Taps – Tapping Steel >32 HRC	P		All Materials	
	Recommended SC Drill		Alternate Tap Drill	
 through hole with coolant T621_KP6525	 approximately 3 x D with coolant B224_HP KCPK15	 approximately 5 x D with coolant B225_HP KCPK15	 approximately 3 x D with coolant B976_KC7315	 approximately 5 x D with coolant B977_KC7315
–	–	–	B976Z02500	–
–	–	–	B976Z02578	–
–	–	–	B976Z02705	–
–	B224A03300HP	B225A03300HP	B976A03300	B977A03300
–	–	–	B976A03454	B977A03454
–	–	–	B976A03454	B977A03454
–	–	–	B976A03734	B977A03734
–	–	–	B976A04039	B977A04039
T621M050X080R6HX-D1	B224A04200HP	B225A04200HP	B976A04200	B977A04200
–	B224A04496HP	B225A04496HP	B976A04496	B977A04496
T621M060X100R6HX-D1	B224A05000HP	B225A05000HP	B976A05000	B977A05000
–	B224A05106HP	B225A05106HP	B976A05106	B977A05106
–	B224A05410HP	B225A05410HP	B976A05410	B977A05410
–	B224A06528HP	B225A06528HP	B976A06528	B977A06528
T621M080X125R6HX-D1	B224A06700HP	B225A06700HP	B976A06700	B977A06700
T621MF080X100R6HX D4	B224A07000HP	B225A07000HP	B976A07000	B977A07000
–	B224A07938HP	B225A07938HP	B976A07938	B977A07938
–	B224A08433HP	B225A08433HP	B976A08433	B977A08433
T621M100X150R6HX-D1	B224A08500HP	B225A08500HP	B976A08500	B977A08500
T621MF100X125R6HX D4	B224A08700HP	B225A08700HP	B976A08700	B977A08700
T621MF100X100R6HX D4	B224A09000HP	B225A09000HP	B976A09000	B977A09000
–	B224A09093HP	B225A09093HP	B976A09093	B977A09093
–	B224A09921HP	B225A09921HP	B976A09921	B977A09921
T621M120X175R6HX-D6	B224A10200HP	B225A10200HP	B976A10200	B977A10200
T621MF120X150R6HX-D4	B224A10500HP	B225A10500HP	B976A10500	B977A10500
–	B224A10716HP	B225A10716HP	B976A10716	B977A10716
T621MF120X125R6HX-D4	B224A10800HP	B225A10800HP	B976A10800	B977A10800
–	B224A11509HP	B225A11509HP	B976A11509	B977A11509
T621M140X200R6HX-D6	B224A12000HP	B225A12000HP	B976A12000	B977A12000
T621MF140X150R6HX-D4	B224A12500HP	B225A12500HP	B976A12500	B977A12500
T621M160X200R6HX-D6	B224A14000HP	B225A14000HP	B976A14000	B977A14000
T621MF160X150R6HX-D4	B224A14500HP	B225A14500HP	B976A14500	B977A14500
T621M180X250R6HX-D6	B224A15500HP	B225A15500HP	B976A15500	B977A15500
T621MF180X150R6HX-D4	B224A16500HP	B225A16500HP	B976A16500	B977A16500
–	–	B225A16670HP	B976A16670	B977A16670
–	B224A17500HP	B225A17500HP	B976A17500	B977A17500









Steel • 32–44 HRC

		P						
		HSS-E-PM Taps – Tapping Steel 32–44 HRC						
typical thread sizes	required tap drill diameter				  			
	cutting taps metric	mm	inch	fraction	wire	blind hole T602_KSP21	blind hole (3 x D) T604_KSH26	through hole T600_KSP21
M3 x 0,50	2,500	.0984	—	—		T602M030X050R6HX-D1	T604M030X050R6HX-D1	T600M030X050R6HX-D1
M4 x 0,70	3,300	.1299	—	—		T602M040X070R6HX-D1	T604M040X070R6HX-D1	T600M040X070R6HX-D1
M5 x 0,80	4,200	.1654	—	—		T602M050X080R6HX-D1	T604M050X080R6HX-D1	T600M050X080R6HX-D1
M6 x 1,00	5,000	.1969	—	—		T602M060X100R6HX-D1	T604M060X100R6HX-D1	T600M060X100R6HX-D1
M8 x 1,25	6,700	.2638	—	—		T602M080X125R6HX-D1	T604M080X125R6HX-D1	T600M080X125R6HX-D1
M8 x 1,00	7,000	.2756	—	—		T602MF080X100R6HX D4	T604MF080X100R6HX D4	T600MF080X100R6HX D4
M10 x 1,50	8,500	.3346	—	—		T602M100X150R6HX-D1	T604M100X150R6HX-D1	T600M100X150R6HX-D1
M10 x 1,25	8,700	.3425	—	—		T602MF100X125R6HX D4	T604MF100X125R6HX D4	T600MF100X125R6HX D4
M10 x 1,00	9,000	.3543	—	—		T602MF100X100R6HX D4	T604MF100X100R6HX D4	T600MF100X100R6HX D4
M12 x 1,75	10,200	.4016	—	—		T602M120X175R6H-D6	T604M120X175R6H-D6	T600M120X175R6HX-D4
M12 x 1,50	10,500	.4134	—	—		T602MF120X150R6H-D4	T604MF120X150R6H-D4	T600MF120X150R6HX-D4
M12 x 1,25	10,800	.4252	—	—		T602MF120X125R6H D4	T604MF120X125R6H D4	T600MF120X125R6HX D4
M14 x 2,00	12,000	.4724	—	—		T602M140X200R6H-D6	T604M140X200R6H-D6	T600M140X200R6HX-D6
M14 x 1,50	12,500	.4921	—	—		T602MF140X150R6H-D4	T604MF140X150R6H-D4	T600MF140X150R6HX-D4
M16 x 2,00	14,000	.5512	—	—		T602M160X200R6H-D6	T604M160X200R6H-D6	T600M160X200R6HX-D6
M16 x 1,50	14,500	.5709	—	—		T602MF160X150R6H-D4	T604MF160X150R6H-D4	T600MF160X150R6HX-D4
M18 x 2,50	15,500	.6102	—	—		T602M180X250R6H-D6	—	—
M18 x 1,50	16,500	.6496	—	—		T602MF180X150R6H-D4	T604MF180X150R6H-D4	T600MF180X150R6HX-D4
M20 x 2,50	17,500	.6890	—	—		T602M200X250R6H-D6	T604M200X250R6H-D6	T600M200X250R6HX-D6





Taps

Steel • Forming Taps

		P					
		HSS-E-PM Taps – Forming Steel >32 HRC					
typical thread sizes	required tap drill diameter				 		
	forming taps metric	mm	inch	fraction	wire	blind and through hole T622_KSP21	blind and through hole with coolant T623_KSP21
M3 x 0,50	2,800	.1102	—	—		T622M030X050R6HX-D74	—
M4 x 0,70	3,700	.1457	—	—		T622M040X070R6HX-D74	—
M5 x 0,80	4,700	.1850	—	13		T622M050X080R6HX-D74	T623M050X080R6HX-D74
M6 x 1,00	5,600	.2205	—	—		T622M060X100R6HX-D74	T623M060X100R6HX-D74
M8 x 1,25	7,400	.2913	—	—		T622M080X125R6HX-D74	T623M080X125R6HX-D74
M8 x 1,00	7,600	.2992	—	—		T622MF080X100R6HX-D74	T623MF080X100R6HX-D74
M10 x 1,50	9,400	.3701	—	—		T622M100X150R6HX-D74	T623M100X150R6HX-D74
M10 x 1,00	9,500	.3740	—	—		T622MF100X100R6HX-D74	T623MF100X100R6HX-D74
M12 x 1,75	11,300	.4449	—	—		T622M120X175R6HX-D74	T623M120X175R6HX-D74
M12 x 1,50	11,300	.4449	—	—		T622MF120X150R6HX-D74	T623MF120X150R6HX-D74
M12 x 1,25	11,500	.4528	—	—		T622MF120X125R6HX-D74	T623MF120X125R6HX-D74
M14 x 1,50	13,400	.5276	—	—		T622MF140X150R6HX-D74	T623MF140X150R6HX-D74
M16 x 2,00	15,200	.5984	—	—		T622M160X200R6HX-D74	T623M160X200R6HX-D74
M16 x 1,50	15,400	.6063	—	—		T622MF160X150R6HX-D74	T623MF160X150R6HX-D74

P		All Materials	
Recommended SC Drill		Alternate Tap Drill	
			
approximately 3 x D with coolant B224_HP KCPK15	approximately 5 x D with coolant B225_HP KCPK15	approximately 3 x D with coolant B976_KC7315	approximately 5 x D with coolant B977_KC7315
—	—	B976Z02500	—
B224A03300HP	B225A03300HP	B976A03300	B977A03300
B224A04200HP	B225A04200HP	B976A04200	B977A04200
B224A05000HP	B225A05000HP	B976A05000	B977A05000
B224A06700HP	B225A06700HP	B976A06700	B977A06700
B224A07000HP	B225A07000HP	B976A07000	B977A07000
B224A08500HP	B225A08500HP	B976A08500	B977A08500
B224A08700HP	B225A08700HP	B976A08700	B977A08700
B224A09000HP	B225A09000HP	B976A09000	B977A09000
B224A10200HP	B225A10200HP	B976A10200	B977A10200
B224A10500HP	B225A10500HP	B976A10500	B977A10500
B224A10800HP	B225A10800HP	B976A10800	B977A10800
B224A12000HP	B225A12000HP	B976A12000	B977A12000
B224A12500HP	B225A12500HP	B976A12500	B977A12500
B224A14000HP	B225A14000HP	B976A14000	B977A14000
B224A14500HP	B225A14500HP	B976A14500	B977A14500
B224A15500HP	B225A15500HP	B976A15500	B977A15500
B224A16500HP	B225A16500HP	B976A16500	B977A16500
B224A17500HP	B225A17500HP	B976A17500	B977A17500







P		All Materials	
Recommended SC Drill		Alternate Tap Drill	
			
approximately 3 x D with coolant B224_HP KCPK15	approximately 5 x D with coolant B225_HP KCPK15	approximately 3 x D with coolant B976_KC7315	approximately 5 x D with coolant B977_KC7315
—	—	B976Z02800	—
B224A03700HP	B225A03700HP	B976A03700	B977A03700
B224A04700HP	B225A04700HP	B976A04700	B977A04700
B224A05600HP	B225A05600HP	B976A05600	B977A05600
B224A07400HP	B225A07400HP	B976A07400	B977A07400
—	B225A07600HP	—	B977A07600
B224A09400HP	B225A09400HP	B976A09400	B977A09400
B224A09500HP	B225A09500HP	B976A09500	B977A09500
—	B225A11300HP	B976A11300	B977A11300
—	B225A11300HP	B976A11300	B977A11300
B224A11500HP	B225A11500HP	B976A11500	B977A11500
—	B225A13400HP	—	—
—	B225A15200HP	—	—
—	B225A15400HP	—	—

Stainless Steel

typical thread sizes		required tap drill diameter				M HSS-E-PM Taps		
cutting taps		mm	inch	fraction	wire	blind hole	through hole	blind hole
metric	inch					T630_KM6515	T620_KM6515	T631_KM6515
—	2-56	1.778	0.07	—	50	T630NC#02-56R3BX-A	T620NC#02-56R3BX-A	—
—	4-40	2.261	0.089	—	43	T630NC#04-40R2BX-A	T620NC#04-40R2BX-A	—
M3 x 0,50	—	2.500	.0984	—	—	T630M030X050R6HX-D1	T620M030X050R6HX-D1	—
—	5-40	2.578	.1015	—	38	T630NC#05-40R2BX-A	T620NC#05-40R2BX-A	—
—	6-32	2.705	.1065	—	36	T630NC#06-32R2BX-A	T620NC#06-32R2BX-A	—
M4 x 0,70	—	3.300	.1299	—	—	T630M040X070R6HX-D1	T620M040X070R6HX-D1	—
—	8-32	3.454	.1360	—	29	T630NC#08-32R2BX-A	T620NC#08-32R2BX-A	—
—	8-36	3.454	.1360	—	29	T630NF#08-36R3BX-A	T620NF#08-36R3BX-A	—
—	10-24	3.734	.1470	—	26	T630NC#10-24R3BX-A	T620NC#10-24R3BX-A	—
—	10-32	4.039	.1590	—	21	T630NF#10-32R2BX-A	T620NF#10-32R2BX-A	—
M5 x 0,80	—	4.200	.1654	—	—	T630M050X080R6HX-D1	T620M050X080R6HX-D1	T631M050X080R6HX-D1
—	12-24	4.496	.1770	—	16	T630NC#12-24R3BX-A	T620NC#12-24R3BX-A	—
M6 x 1,00	—	5.000	.1969	—	—	T630M060X100R6HX-D1	T620M060X100R6HX-D1	T631M060X100R6HX-D1
—	1/4-20	5.106	.2010	—	7	T630NC02500-20R2BX-A	T620NC02500-20R2BX-A	—
—	1/4-28	5.410	.2130	—	3	T630NF02500-28R2BX-A	T620NF02500-28R2BX-A	—
—	5/16-18	6.528	.2570	—	F	T630NC03125-18R2BX-A	T620NC03125-18R2BX-A	—
M8 x 1,25	—	6.700	.2638	—	—	T630M080X125R6HX-D1	T620M080X125R6HX-D1	T631M080X125R6HX-D1
—	5/16-24	6.909	.2720	—	I	—	T620NF03125-24R3BX-A	—
M8 x 1,00	—	7.000	.2756	—	—	T630MF080X100R6HX D4	T620MF080X100R6HX D4	T631MF080X100R6HX D4
—	3/8-16	7.938	.3125	5/16	—	T630NC03750-16R3BX-A	T620NC03750-16R3BX-A	—
—	3/8-24	8.433	.3320	—	Q	T630NF03750-24R3BX-A	T620NF03750-24R3BX-A	—
M10 x 1,50	—	8.500	.3346	—	—	T630M100X150R6HX-D1	T620M100X150R6HX-D1	T631M100X150R6HX-D1
M10 x 1,25	—	8.700	.3425	—	—	T630MF100X125R6HX D4	—	T631MF100X125R6HX D4
M10 x 1,00	—	9.000	.3543	—	—	T630MF100X100R6HX D4	T620MF100X100R6HX D4	T631MF100X100R6HX D4
—	7/16-14	9.093	.3580	—	T	T630NC04375-14R3BX-A	T620NC04375-14R3BX-A	—
—	7/16-20	9.921	.3906	25/64	—	T630NF04375-20R3BX-A	T620NF04375-20R3BX-A	—
M12 x 1,75	—	10.200	.4016	—	—	T630M120X175R6HX-D6	T620M120X175R6HX-D6	T631M120X175R6HX-D6
M12 x 1,50	—	10.500	.4134	—	—	T630MF120X150R6HX-D4	T620MF120X150R6HX-D4	T631MF120X150R6HX-D4
—	1/2-13	10.716	.4219	27/64	—	T630NC05000-13R3BX-A	T620NC05000-13R3BX-A	—
M12 x 1,25	—	10.800	.4252	—	—	—	—	T631MF120X125R6HX-D4
—	1/2-20	11.509	.4531	29/64	—	T630NF05000-20R3BX-A	T620NF05000-20R3BX-A	—
M14 x 2,00	—	12.000	.4724	—	—	T630M140X200R6HX-D6	T620M140X200R6HX-D6	T631M140X200R6HX-D6
M14 x 1,50	—	12.500	.4921	—	—	T630MF140X150R6HX-D4	T620MF140X150R6HX-D4	T631MF140X150R6HX-D4
M14 x 1,25	—	12.800	.5039	—	—	—	—	T631MF140X125R6HX-D4
—	5/8-11	13.495	.5313	17/32	—	T630NC06250-10R3BX-A	T620NC06250-10R3BX-A	—
M16 x 2,00	—	14.000	.5512	—	—	T630M160X200R6HX-D6	T620M160X200R6HX-D6	T631M160X200R6HX-D6
M16 x 1,50	—	14.500	.5709	—	—	T630MF160X150R6HX-D4	T620MF160X150R6HX-D4	T631MF160X150R6HX-D4
M18 x 2,50	—	15.500	.6102	—	—	T630M180X250R6HX-D6	—	T631M180X250R6HX-D6
M18 x 1,50	—	16.500	.6496	—	—	T630MF180X150R6HX-D4	T620MF180X150R6HX-D4	T631MF180X150R6HX-D4
—	3/4-10	16.670	.6563	21/32	—	T630NC07500-10R3BX-A	T620NC07500-10R3BX-A	—
M20 x 2,50	—	17.500	.6890	—	—	T630M200X250R6HX-D6	T620M200X250R6HX-D6	—

Taps





HSS-E-PM Taps	M		All Materials	
	Recommended Drill		Alternative Tap Drill	
 through hole with coolant T621_KM6515	 approximately 3 x D with coolant B210_HP KCM15	 approximately 5 x D with coolant B211_HP KCM15	 approximately 3 x D with coolant B976_KC7315	 approximately 5 x D with coolant B977_KC7315
—	—	—	—	—
—	—	—	B976Z02500	—
—	—	—	B976Z02578	—
—	—	—	B976Z02705	—
—	B210A03300HP	B211A03300HP	B976A03300	B977A03300
—	—	B211A03454HP	B976A03454	B977A03454
—	—	B211A03454HP	B976A03454	B977A03454
—	—	—	B976A03734	B977A03734
—	—	—	B976A04039	B977A04039
T621M050X080R6HX-D1	B210A04200HP	B211A04200HP	B976A04200	B977A04200
—	—	—	B976A04496	B977A04496
T621M060X100R6HX-D1	B210A05000HP	B211A05000HP	B976A05000	B977A05000
—	B210A05106HP	—	B976A05106	B977A05106
—	B210A05410HP	—	B976A05410	B977A05410
—	B210A06528HP	—	B976A06528	B977A06528
T621M080X125R6HX-D1	B210A06700HP	B211A06700HP	B976A06700	B977A06700
—	—	—	B976A06909	B977A06909
T621MF080X100R6HX D4	B210A07000HP	B211A07000HP	B976A07000	B977A07000
—	B210A07938HP	—	B976A07938	B977A07938
—	B210A08433HP	—	B976A08433	B977A08433
T621M100X150R6HX-D1	B210A08500HP	B211A08500HP	B976A08500	B977A08500
T621MF100X125R6HX D4	B210A08700HP	B211A08700HP	B976A08700	B977A08700
T621MF100X100R6HX D4	B210A09000HP	B211A09000HP	B976A09000	B977A09000
—	B210A09093HP	—	B976A09093	B977A09093
—	B210A09921HP	—	B976A09921	B977A09921
T621M120X175R6HX-D6	B210A10200HP	B211A10200HP	B976A10200	B977A10200
T621MF120X150R6HX-D4	B210A10500HP	B211A10500HP	B976A10500	B977A10500
—	B210A10716HP	—	B976A10716	B977A10716
T621MF120X125R6HX-D4	B210A10800HP	B211A10800HP	B976A10800	B977A10800
—	B210A11509HP	—	B976A11509	B977A11509
T621M140X200R6HX-D6	B210A12000HP	B211A12000HP	B976A12000	B977A12000
T621MF140X150R6HX-D4	B210A12500HP	B211A12500HP	B976A12500	B977A12500
—	B210A12800HP	B211A12800HP	B976A12800	B977A12800
—	B210A13495HP	—	B976A13495	B977A13495
T621M160X200R6HX-D6	B210A14000HP	B211A14000HP	B976A14000	B977A14000
T621MF160X150R6HX-D4	B210A14500HP	B211A14500HP	B976A14500	B977A14500
T621M180X250R6HX-D6	B210A15500HP	B211A15500HP	B976A15500	B977A15500
T621MF180X150R6HX-D4	B210A16500HP	B211A16500HP	B976A16500	B977A16500
—	B210A16670HP	B211A16670HP	B976A16670	B977A16670
—	B210A17500HP	B211A17500HP	B976A17500	B977A17500

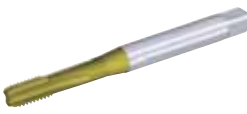
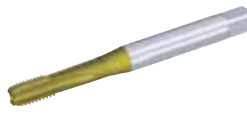

Cast and Ductile Iron

typical thread sizes		required tap drill diameter				K HSS-E-PM Taps	
cutting taps		mm	inch	fraction	wire	 blind and through hole T640 KP6525	 blind and through hole with coolant T641 KP6525
metric	inch						
M4 x 0,7	—	3,3	.1299	—	—	T640M040X070R6HX-D1	—
—	10-24	3,734	.1470	—	26	T640NC#10-24R3B-A	—
—	10-32	4,039	.1590	—	21	T640NF#10-32R3B-A	—
M5 x 0,8	—	4,2	.1654	—	—	T640M050X080R6HX-D1	T641M050X080R6HX-D1
M6 x 1,0	—	5,0	.1969	—	—	T640M060X100R6HX-D1	T641M060X100R6HX-D1
—	—	5,791	.2280	—	1	T640NC02500-20R3B-A	—
—	—	5,944	.2340	—	A	T640NF02500-28R3B-A	—
—	5/16-18	6,528	.2570	—	F	T640NC03125-18R3B-A	—
M8 x 1,25	—	6,7	.2638	—	—	T640M080X125R6HX-D1	T641M080X125R6HX-D1
—	5/16-24	6,909	.2720	—	I	T640NF03125-24R3B-A	—
—	3/8-16	7,938	.3125	5/16	—	T640NC03750-16R3B-A	—
—	3/8-24	8,433	.3320	—	Q	T640NF03750-24R3B-A	—
M10 x 1,5	—	8,5	.3346	—	—	T640M100X150R6HX-D1	T641M100X150R6HX-D1
—	7/16-14	9,093	.3580	—	T	T640NC04375-14R3B-A	—
—	7/16-20	9,921	.3906	25/64	—	T640NF04375-20R3B-A	—
M12 x 1,75	—	10,2	.4016	—	—	T640M120X175R6HX-D6	T641M120X175R6HX-D6
—	1/2-13	10,716	.4219	27/64	—	T640NC05000-13R3B-A	—
—	1/2-20	11,509	.4531	29/64	—	T640NF05000-20R3B-A	—
M14 x 2,0	—	12,0	.4724	—	—	T640M140X200R6HX-D6	T641M140X200R6HX-D6
—	5/8-11	13,495	.5313	17/32	—	T640NC06250-11R3B-A	—
M16 x 2,0	—	14,0	.5512	—	—	T640M160X200R6HX-D6	T641M160X200R6HX-D6
M18 x 2,5	—	15,5	.6102	—	—	T640M180X250R6HX-D6	T641M180X250R6HX-D6
—	3/4-10	16,67	.6563	21/32	—	T640NC07500-10R3B-A	—
M20 x 2,5	—	17,5	.6890	—	—	T640M200X250R6HX-D6	T641M200X250R6HX-D6
M22 x 2,5	—	19,5	.7677	—	—	T640M220X250R6HX-D6	—

Taps

K		All Materials	
Recommended Drill		Alternate Tap Drill	
 approximately 3 x D with coolant B254_YPC KCK10	 approximately 5 x D with coolant B255_YPC KCK10	 approximately 3 x D with coolant B976 KC7315	 approximately 5 x D with coolant B977 KC7315
B254A03300YPC	B255A03300YPC	B976A03300	B977A03300
B254A03734YPC	B255A03734YPC	B976A03734	B977A03734
B254A04039YPC	B255A04039YPC	B976A04039	B977A04039
B254A04200YPC	B255A04200YPC	B976A04200	B977A04200
B254A05000YPC	B255A05000YPC	B976A05000	B977A05000
B254A05791YPC	B255A05791YPC	B976A05791	B977A05791
B254A05944YPC	B255A05944YPC	B976A05944	B977A05944
B254A06528YPC	B255A06528YPC	B976A06528	B977A06528
B254A06700YPC	B255A06700YPC	B976A06700	B977A06700
B254A06909YPC	B255A06909YPC	B976A06909	B977A06909
B254A07938YPC	B255A07940YPC	B976A07938	B977A07938
B254A08433YPC	B255A08433YPC	B976A08433	B977A08433
B254A08500YPC	B255A08500YPC	B976A08500	B977A08500
B254A09093YPC	B255A09093YPC	B976A09093	B977A09093
B254A09921YPC	B255A09920YPC	B976A09921	B977A09921
B254A10200YPC	B255A10200YPC	B976A10200	B977A10200
B254A10716YPC	B255A10716YPC	B976A10716	B977A10716
B254A11509YPC	B255A11509YPC	B976A11509	B977A11509
B254A12000YPC	B255A12000YPC	B976A12000	B977A12000
B254A13495YPC	B255A13495YPC	B976A13495	B977A13495
B254A14000YPC	B255A14000YPC	B976A14000	B977A14000
B254A15500YPC	B255A15500YPC	B976A15500	B977A15500
B254A16670YPC	B255A16670YPC	B976A16670	B977A16670
B254A17500YPC	B255A17500YPC	B976A17500	B977A17500
B254A19500YPC	B255A19500YPC	B976A19500	B977A19500



Aluminium

typical thread sizes		required tap drill diameter				N			
						HSS-E Taps – Tapping Aluminium (Wrought, low Si)		HSS-E-PM Taps – Tapping Cast Aluminium (Si <12%)	
cutting taps						through hole T680_KSN38		blind hole T680_KSN38	blind and through hole T640_KP6525
metric	inch	mm	inch	fraction	wire				
M3 x 0,50	—	2,500	.0984	—	—	T680M030X050R6H-D1	T670M030X050R6H-D1	—	
M4 x 0,70	—	3,300	.1299	—	—	T680M040X070R6H-D1	T670M040X070R6H-D1	T640M040X070R6HX-D1	
—	10-24	3,734	.1470	—	26	—	—	T640NC#10-24R3B-A	
—	10-32	4,039	.1590	—	21	—	—	T640NF#10-32R3B-A	
M5 x 0,80	—	4,200	.1654	—	—	T680M050X080R6H-D1	T670M050X080R6H-D1	T640M050X080R6HX-D1	
M6 x 1,00	— 5,000	.1969	—	—	—	T680M060X100R6H-D1	T670M060X100R6H-D1	T640M060X100R6HX-D1	
—	—	5,791	.2280	—	1	—	—	T640NC02500-20R3B-A	
—	—	5,944	.2340	—	A	—	—	T640NF02500-28R3B-A	
—	5/16-18	6,528	.2570	—	F	—	—	T640NC03125-18R3B-A	
M8 x 1,25	—	6,700	.2638	—	—	T680M080X125R6H-D1	T670M080X125R6H-D1	T640M080X125R6HX-D1	
—	5/16-24	6,909	.2720	—	I	—	—	T640NF03125-24R3B-A	
—	3/8-16	7,938	.3125	5/16	—	—	—	T640NC03750-16R3B-A	
—	3/8-24	8,433	.3320	—	Q	—	—	T640NF03750-24R3B-A	
M10 x 1,50	—	8,500	.3346	—	—	T680M100X150R6H-D1	T670M100X150R6H-D1	T640M100X150R6HX-D1	
—	7/16-14	9,093	.3580	—	T	—	—	T640NC04375-14R3B-A	
—	7/16-20	9,921	.3906	25/64	—	—	—	T640NF04375-20R3B-A	
M12 x 1,75	—	10,200	.4016	—	—	T680M120X175R6H-D6	T670M120X175R6H-D6	T640M120X175R6HX-D6	
—	1/2-13	10,716	.4219	27/64	—	—	—	T640NC05000-13R3B-A	
—	1/2-20	11,509	.4531	29/64	—	—	—	T640NF05000-20R3B-A	
M14 x 2,00	—	12,000	.4724	—	—	—	—	T640M140X200R6HX-D6	
—	5/8-111	13,495	.5313	17/32	—	—	—	T640NC06250-11R3B-A	
M16 x 2,00	—	14,000	.5512	—	—	T680M160X200R6H-D6	T670M160X200R6H-D6	T640M160X200R6HX-D6	
M18 x 2,50	—	15,500	.6102	—	—	—	—	T640M180X250R6HX-D6	
—	3/4-10	16,670	.6563	21/32	—	—	—	T640NC07500-10R3B-A	
M20 x 2,50	—	17,500	.6890	—	—	T680M200X250R6H-D6	—	T640M200X250R6HX-D6	
M22 x 2,50	—	19,500	.7677	—	—	—	—	T640M220X250R6HX-D6	

Taps

Aluminium • Forming Taps

typical thread sizes		required tap drill diameter		N	
				HSS-E-PM Taps – Forming Aluminium (Wrought, low Si)	
forming taps				blind and through hole T622_KSN38	blind and through hole with coolant T622_KSN38
metric	inch	mm	inch		
M3 x 0,50	—	2,800	.1102	T622M030X050R6HX-D74	—
—	—	3,734	.1470	T622M040X070R6HX-D74	—
—	—	5,000	.1969	T622M050X080R6HX-D74	T623M050X080R6HX-D74
—	1/4-20	5,791	.2280	T622M060X100R6HX-D74	T623M060X100R6HX-D74
—	5/16-24	7,493	.2950	T622M080X125R6HX-D74	T623M080X125R6HX-D74
—	—	7,938	.3125	T622MF080X100R6HX-D74	T623MF080X100R6HX-D74
M10 x 1,25	—	9,500	.3740	T622M100X150R6HX-D74	T623M100X150R6HX-D74
—	—	9,921	.3906	T622MF100X100R6HX-D74	T623MF100X100R6HX-D74
M12 x 1,50	—	11,300	.4449	T622M120X175R6HX-D74	T623M120X175R6HX-D74
M12 x 1,25	—	11,500	.4528	T622MF120X150R6HX-D74	T623MF120X150R6HX-D74
—	—	11,509	.4531	T622MF120X125R6HX-D74	T623MF120X125R6HX-D74
M14 x 1,25	—	13,400	.5276	T622MF140X150R6HX-D74	T623MF140X150R6HX-D74
—	5/8-18	15,250	.6004	T622M160X200R6HX-D74	T623M160X200R6HX-D74
—	—	15,500	.6102	T622MF160X150R6HX-D74	T623MF160X150R6HX-D74

HSS-E-PM Taps – Tapping Cast Aluminium (Si <12%)	N		All Materials	
	Recommended SC Drill		Alternate Tap Drill	
 approximately 3 x D with coolant T641 KP6525	 approximately 3 x D with coolant B284_(HP) K715	 approximately 5 x D with coolant B411 KF1	 approximately 5 x D with coolant B976_KC7315	 with coolant B977_KC7315
–	–	–	B976Z02500	–
–	–	B411A03300	B976A03300	B977A03300
–	–	–	B976A03734	B977A03734
–	–	–	B976A04039	B977A04039
T641M050X080R6HX-D1	B284A04200	B411A04200	B976A04200	B977A04200
T641M060X100R6HX-D1	B284A05000	B411A05000	B976A05000	B977A05000
–	–	–	B976A05791	B977A05791
–	–	–	B976A05944	B977A05944
–	–	–	B976A06528	B977A06528
T641M080X125R6HX-D1	–	–	B976A06700	B977A06700
–	–	–	B976A06909	B977A06909
–	–	–	B976A07938	B977A07938
–	–	–	B976A08433	B977A08433
T641M100X150R6HX-D1	–	B411A08500	B976A08500	B977A08500
–	–	–	B976A09093	B977A09093
–	K284A03906	–	B976A09921	B977A09921
T641M120X175R6HX-D6	–	B411A10200	B976A10200	B977A10200
–	–	–	B976A10716	B977A10716
–	K284A04531	–	B976A11509	B977A11509
T641M140X200R6HX-D6	–	B411A12000	B976A12000	B977A12000
–	–	–	B976A13495	B977A13495
T641M160X200R6HX-D6	–	B411A14000	B976A14000	B977A14000
T641M180X250R6HX-D6	–	B411A15500	B976A15500	B977A15500
–	–	–	B976A16670	B977A16670
T641M200X250R6HX-D6	–	B411A17500	B976A17500	B977A17500
–	–	B411A19500	B976A19500	B977A19500



	N		All Materials	
	Recommended SC Drill		Alternate Tap Drill	
	 approximately 3 x D with coolant B284_(HP) K715	 approximately 5 x D with coolant B411 KF1	 approximately 3 x D with coolant B976_KC7315	 approximately 5 x D with coolant B977_KC7315
–	–	–	B976Z02800	–
–	–	–	B976A03734	B977A03734
B284A05000	–	B411A05000	B976A05000	B977A05000
–	–	–	B976A05791	B977A05791
–	–	–	–	–
–	–	–	B976A07938	B977A07938
–	–	B411A09500	B976A09500	B977A09500
–	–	K284A03906	B976A09921	B977A09921
–	–	–	B976A11300	B977A11300
–	–	B411A11500	B976A11500	B977A11500
K284A04531	–	–	B976A11509	B977A11509
–	–	–	–	–
–	–	–	–	–
–	–	B411A15500	B976A15500	B977A15500





High-Temperature Alloys





			S		
			HSS-E-PM Taps – Tapping Titanium Alloys		HSS-E-PM Taps – Tapping Nickel and Cobalt Alloys
typical thread sizes	required tap drill diameter		blind hole T616_KSN25	through hole T614_KSN25	blind hole T612_KSSH22
	metric	mm inch			
M3 x 0,50	2,500	.0984	T616M030X050R6HX-D1	T614M030X050R6HX-D1	T616M030X050R6HX-D1
M4 x 0,70	3,300	.1299	T616M040X070R6H-D1	T614M040X070R6H-D1	T616M040X070R6H-D1
M5 x 0,80	4,200	.1654	T616M050X080R6H-D1	T614M050X080R6H-D1	T616M050X080R6H-D1
M6 x 1,00	5,000	.1969	T616M060X100R6H-D1	T614M060X100R6H-D1	T616M060X100R6H-D1
M8 x 1,25	6,700	.2638	T616M080X125R6H-D1	T614M080X125R6H-D1	T616M080X125R6H-D1
M10 x 1,50	8,500	.3346	T616M100X150R6H-D1	T614M100X150R6H-D1	T616M100X150R6H-D1
M12 x 1,75	10,200	.4016	T616M120X175R6H-D6	T614M120X175R6H-D6	T616M120X175R6H-D6
M14 x 2,00	12,000	.4724	–	–	T612M140X200R6HX-D6
M16 x 2,00	14,000	.5512	–	–	T612M160X200R6HX-D6
M20 x 2,50	17,500	.6890	–	–	T612M200X250R6HX-D6

Taps

Hard Materials





			H		
			HSS-E-PM Taps – Tapping Hard Materials 44–55 HRC		Carbide Taps – Tapping Hard Materials 55–63 HRC
typical thread sizes	required tap drill diameter		blind and through hole T606_KSSH22	blind and through hole T410_KCU36	
	metric	mm inch			
M5 x 0,80	4,200	.1654	–	T410M050X080R6HX-D1	
M6 x 1,00	5,000	.1969	T606M060X100R6HX-D1	T410M060X100R6HX-D1	
M8 x 1,25	6,700	.2638	T606M080X125R6HX-D1	T410M080X125R6HX-D1	
M8 x 1,00	7,000	.2756	T606MF080X100R6HX-D4	T410MF080X100R6HX-D4	
M10 x 1,50	8,500	.3346	T606M100X150R6HX-D1	T410M100X150R6HX-D1	
M10 x 1,00	9,000	.3543	T606MF100X100R6HX-D4	T410MF100X100R6HX-D4	
M12 x 1,75	10,200	.4016	T606M120X175R6HX-D6	T410M120X175R6HX-D6	
M12 x 1,50	10,500	.4134	T606MF120X150R6HX-D4	T410MF120X150R6HX-D4	
M14 x 2,00	12,000	.4724	–	T410M140X200R6HX-D6	
M14 x 1,50	12,500	.4921	T606MF140X150R6HX-D4	T410MF140X150R6HX-D4	
M16 x 2,00	14,000	.5512	T606M160X200R6HX-D6	T612M160X200R6HX-D6	
M16 x 1,50	14,500	.5709	T606MF160X150R6HX-D4	T410MF160X150R6HX-D4	





HSS-E-PM Taps – Tapping Nickel and Cobalt Alloys	S		All Materials	
	Recommended SC Drill		Alternate Tap Drill	
 through hole T610_KSSH22	 approximately 3 x D with coolant B291_YPL KC7315	 approximately 5 x D with coolant B292_YPL KC7315	 approximately 3 x D with coolant B976_KC7315	 approximately 5 x D with coolant B977_KC7315
T610M030X050R6HX-D1	—	—	B976Z02500	—
T610M040X070R6H-D1	B291A03300YPL	B292A03300YPL	B976A03300	B977A03300
T610M050X080R6H-D1	—	B292A04200YPL	B976A04200	B977A04200
T610M060X100R6H-D1	B291A05000YPL	B292A05000YPL	B976A05000	B977A05000
T610M080X125R6H-D1	—	—	B976A06700	B977A06700
T610M100X150R6H-D1	B291A08500YPL	B292A08500YPL	B976A08500	B977A08500
T610M120X175R6H-D6	B291A10200YPL	B292A10200YPL	B976A10200	B977A10200
T610M140X200R6HX-D6	B291A12000YPL	B292A12000YPL	B976A12000	B977A12000
T610M160X200R6HX-D6	B291A14000YPL	B292A14000YPL	B976A14000	B977A14000
T610M200X250R6HX-D6	B291A17500YPL	B292A17500YPL	B976A17500	B977A17500





	H		All Materials	
	Recommended SC Drill		Alternative Tap Drill	
	 approximately 3 x D with coolant B291_YPL KC7315	 approximately 5 x D with coolant B292_YPL KC7315	 approximately 3 x D with coolant B976_KC7315	 approximately 5 x D with coolant B977_KC7315
	—	B292A04200YPL	B976A04200	B977A04200
	B291A05000YPL	B292A05000YPL	B976A05000	B977A05000
	—	—	B976A06700	B977A06700
	B291A07000YPL	B292A07000YPL	B976A07000	B977A07000
	B291A08500YPL	B292A08500YPL	B976A08500	B977A08500
	B291A09000YPL	B292A09000YPL	B976A09000	B977A09000
	B291A10200YPL	B292A10200YPL	B976A10200	B977A10200
	B291A10500YPL	B292A10500YPL	B976A10500	B977A10500
	B291A12000YPL	B292A12000YPL	B976A12000	B977A12000
	B291A12500YPL	B292A12500YPL	B976A12500	B977A12500
	B291A14000YPL	B292A14000YPL	B976A14000	B977A14000
	B291A14500YPL	B292A14500YPL	B976A14500	B977A14500







Taps

P HSS-E-PM Taps – Tapping Steel >32 HRC		P Recommended Modular Drill	
			
blind hole with coolant T631_KP6525	blind hole with coolant T651_KP6525	KSEM PLUS™ insert KCP15	KSEM PLUS™ tool body 3 x D
T631M240X300R6HX-D6	T651M240X300R6HX-D6	KTIP2100HPM	KSEM PLUS
T631M300X350R6HX-D6	T651M300X350R6HX-D6	KTIP2650HPM	KSEM PLUS
T631M330X350R6HX-D6	T651M330X350R6HX-D6	KSEM PLUS	KSEM PLUS
T631M360X400R6HX-D6	T651M360X400R6HX-D6	KSEM PLUS	KSEM PLUS
T631M420X450R6HX-D6	T651M420X450R6HX-D6	KSEM PLUS	KSEM PLUS

P HSS-E-PM Taps – Tapping Steel >32 HRC		P Recommended Modular Drill	
			
blind hole with coolant T631_KP6525	blind hole with coolant T651_KP6525	KSEM PLUS™ insert KCP15	KSEM PLUS™ tool body 3 x D
T631M240X300R6HX-XL	T651M240X300R6HX-XL	KTIP2100HPM	KSEM PLUS
T631M300X350R6HX-XL	T651M300X350R6HX-XL	KTIP2650HPM	KSEM PLUS
T631M330X350R6HX-XL	T651M330X350R6HX-XL	KSEM PLUS	KSEM PLUS
T631M360X400R6HX-XL	T651M360X400R6HX-XL	KSEM PLUS	KSEM PLUS
T631M420X450R6HX-XL	T651M420X450R6HX-XL	KSEM PLUS	KSEM PLUS

K HSS-E-PM Taps – Cast Iron		K Recommended Modular Drill	
			
blind hole with coolant T631_KP6525	blind hole with coolant T651_KP6525	KSEM PLUS™ insert KC7140	KSEM PLUS™ tool body 3 x D
T631M240X300R6HX-D6	T651M240X300R6HX-D6	KTIP2100HPM	KSEM PLUS
T631M300X350R6HX-D6	T651M300X350R6HX-D6	KTIP2650HPM	KSEM PLUS
T631M330X350R6HX-D6	T651M330X350R6HX-D6	KSEM PLUS	KSEM PLUS
T631M360X400R6HX-D6	T651M360X400R6HX-D6	KSEM PLUS	KSEM PLUS
T631M420X450R6HX-D6	T651M420X450R6HX-D6	KSEM PLUS	KSEM PLUS

K HSS-E-PM Taps – Cast Iron		K Recommended Modular Drill	
			
blind hole with coolant T631_KP6525	blind hole with coolant T651_KP6525	KSEM PLUS™ insert KC7140	KSEM PLUS™ tool body 3 x D
T631M240X300R6HX-XL	T651M240X300R6HX-XL	KTIP2100HPM	KSEM PLUS
T631M300X350R6HX-XL	T651M300X350R6HX-XL	KTIP2650HPM	KSEM PLUS
T631M330X350R6HX-XL	T651M330X350R6HX-XL	KSEM PLUS	KSEM PLUS
T631M360X400R6HX-XL	T651M360X400R6HX-XL	KSEM PLUS	KSEM PLUS
T631M420X450R6HX-XL	T651M420X450R6HX-XL	KSEM PLUS	KSEM PLUS





High-Performance Solid Carbide Thread Mills

Primary Application

Our solid thread mills are designed to deliver high-quality internal threading on 3-axis CNC machines. Because these mills are made of carbide, they are capable of easily cutting most difficult materials up to 63 HRC. Thread mills make interrupted cuts and short chips.

The combination of these design elements offers a range of benefits to improve overall thread quality and tool production. Short, easily evacuated chips generate less heat and friction, so there is a lower risk of damage to threading. Also, the superior carbide grades make threading easier and machining times shorter.

Features and Benefits

System Requirements

- 3-axis CNC machine.
- Good clamping for tool and workpiece.
- Internal coolant supply.

Features

- Interrupted cuts.
- Short chips.
- Optimised carbide grades.
- Drill, thread, countersink.





Advantages

- Versatile.
- Better surface quality.
- No chip problems.
- No need to reverse the spindle.
- More production safety.



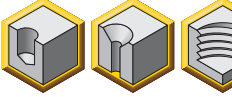

Through and Blind Holes (2 x D)

					
		Thread Mill	Thread Mill and Chamfer	Drill, Thread Mill, and Chamfer	Mill, Thread Mill, and Chamfer
P	<35 HRC	TM711	TM721	—	TM741_RHSF
	35–43 HRC	—	TM721	—	TM741_RHSF
M		TM711	TM721	—	TM741_RHSF
K		TM711	TM721	TM731	TM741_RHSF
N	Wrought	TM711	TM721	—	TM731
	Cast	TM711	TM721	TM731	TM741_RHSF
S		TM711	TM721	—	TM741_LHSF
H	44–63 HRC	—	—	—	TM741_RHSF TM741_LHSF

Taps



High-Performance Solid Carbide Thread Mills

Our solid thread mills are designed to deliver high-quality internal threading on 3-axis CNC machines. Because these mills are made of carbide, they are capable of easily cutting most difficult materials up to 63 HRC. Thread mills make interrupted cuts and short chips. The combination of these design elements offers a range of benefits to improve overall thread quality and tool production. Short, easily evacuated chips generate less heat and friction, so there is a lower risk of damage to threading. Also, the superior carbide grades make threading easier and machining times shorter.

Features:

- 3-axis CNC machine.
- Good clamping for tool and workpiece.
- Internal coolant supply.
- Interrupted cuts.
- Short chips.
- Optimised carbide grades.
- Drill, thread, countersink.
- Versatile.
- Better surface quality.
- No chip problems.
- No need to reverse the spindle.
- More production safety.

Visit www.kennametal.com or contact your local Authorised Kennametal Distributor.

www.kennametal.com



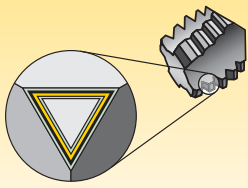

Coatings provide high-speed capability and are engineered for finishing to light roughing.

P	Steel
M	Stainless Steel
K	Cast Iron
N	Non-Ferrous Materials
S	High-Temp Alloys
H	Hardened Materials

wear resistance ← → toughness

NEW!
Grade

Coating	Grade Description	P	M	K	N	S	H
KCU32	Coated carbide. PVD — Fine-grain carbide substrate with high hardness TiCN coating. Universal grade for thread milling most materials.	05	10	15	20	25	30
KCU33	Coated carbide. PVD — Carbide substrate with heat-resistant TiAlN coating. Universal grade for thread milling most materials.	05	10	15	20	25	30
KCU36	Coated carbide. PVD — two-layer coating with heat-resistant TiAlN base layer and low-friction MoS ₂ top layer over carbide substrate. Use for thread milling most materials including high hardness materials.	05	10	15	20	25	30

Solid Thread Mills Identification System



TM721

Tap Design

MF

Type of Thread

120

Nominal Diameter of Thread

X

150

Pitch

R

Cutting Dimension

2D

Depth of Cut

HA

Shank

mm or inch
(depending on type)

mm or TPI
(depending on type)

M = Metric coarse-pitch thread (ISO form)

MF = Metric fine-pitch thread (ISO form)

NC = Unified coarse series thread

NF = Unified fine series thread

DIN 6535

HA = Plain Shank

HB = Weldon® Shank

HE = Whistle Notch™ Shank

Style

TM711 = Solid Thread Mill; through coolant

TM721 = Solid Thread Mill and Chamfer; through coolant

TM731 = Solid Thread Mill, Chamfer, and Drill; through coolant

TM741 = Solid Thread Mill, Chamfer, and Mill; through coolant



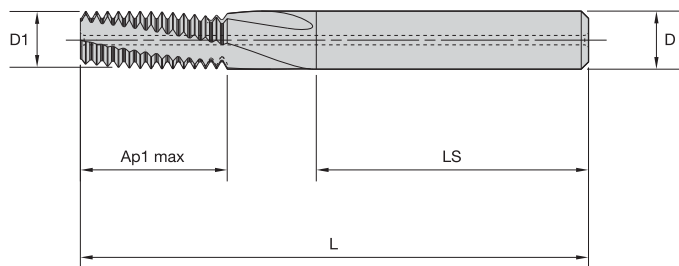
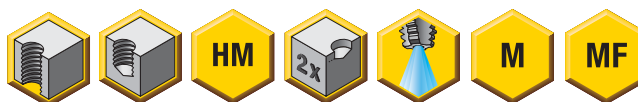

■ **TM711 • Through Coolant • Metric and Metric Fine**

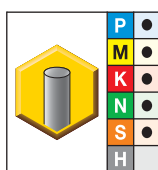

● first choice
○ alternate choice

Taps

	KCU32	D1 size	D1	Ap1 max	L	LS	D	cutting edges
	TM711M030X050R2DHA	M3X0.5	2,4	6,2	42	28	4,0	3
	TM711MF040X050R2DHA	M4X0.5	3,4	8,2	55	36	6,0	3
	TM711M040X070R2DHA	M4X0.7	3,2	8,7	55	36	6,0	3
	TM711MF050X050R2DHA	M5X0.5	4,3	10,2	55	36	6,0	3
	TM711M050X080R2DHA	M5X0.8	4,0	10,8	55	36	6,0	3
	TM711MF060X075R2DHA	M6X0.75	5,0	12,4	55	36	6,0	3
	TM711M060X100R2DHA	M6X1	4,8	12,5	55	36	6,0	3
	TM711MF080X075R2DHA	M8X0.75	5,9	16,8	63	36	6,0	3
	TM711MF080X100R2DHA	M8X1	5,9	16,4	63	36	6,0	3
	TM711M080X125R2DHA	M8X1.25	5,9	16,8	63	36	6,0	3
	TM711MF100X100R2DHA	M10X1	7,9	20,5	70	36	8,0	3
	TM711M100X150R2DHA	M10X1.5	7,9	20,2	70	36	8,0	3
	TM711MF120X100R2DHA	M12X1	9,9	24,5	80	40	10,0	4
	TM711MF120X150R2DHA	M12X1.5	9,9	24,7	80	40	10,0	4
	TM711M120X175R2DHA	M12X1.75	9,9	25,3	80	40	10,0	4
	TM711MF140X150R2DHA	M14X1.5	9,9	29,2	80	40	10,0	4
	TM711M140X200R2DHA	M14X2	11,6	29,0	90	45	12,0	4
	TM711MF160X150R2DHA	M16X1.5	11,9	32,2	90	45	12,0	4
	TM711M160X200R2DHA	M16X2	11,9	32,9	90	45	12,0	4
	TM711MF180X150R2DHA	M18X1.5	13,9	36,7	90	45	14,0	4
	TM711M180X250R2DHA	M18X2.5	13,9	38,7	90	45	14,0	4
	TM711MF200X150R2DHA	M20X1.5	13,9	41,2	90	45	14,0	4
	TM711M200X250R2DHA	M20X2.5	13,9	41,2	90	45	14,0	4

Shank Tolerance

D	tolerance h6
6	+0, -0,008
8-10	+0, -0,009
12-18	+0, -0,011
20-30	+0, -0,013

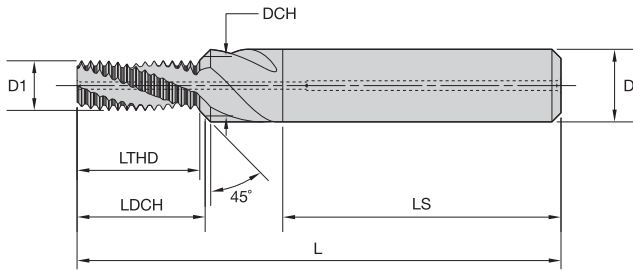

■ TM721 • Through Coolant • Metric and Metric Fine

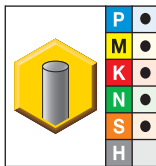

- first choice
- alternate choice

	D1 size	D1	DCH	LTHD	LDCH	L	LS	D	cutting edges
TM721M050X080R2DHA	M5X0.8	4,0	5,3	10,82	11,40	55	36	6,0	3
TM721MF060X075R2DHA	M6X0.75	5,0	6,3	12,40	12,97	62	36	8,0	3
TM721M060X100R2DHA	M6X1	4,8	6,3	12,52	13,19	62	36	8,0	3
TM721MF080X100R2DHA	M8X1	6,7	8,3	16,53	17,23	74	40	10,0	3
TM721M080X125R2DHA	M8X1.25	6,5	8,3	16,91	17,71	74	40	10,0	3
TM721MF100X100R2DHA	M10X1	8,7	10,3	20,55	21,23	80	45	12,0	3
TM721MF100X125R2DHA	M10X1.25	8,4	10,3	20,67	21,50	80	45	12,0	3
TM721M100X150R2DHA	M10X1.5	8,2	10,3	20,29	21,22	80	45	12,0	3
TM721MF120X100R2DHA	M12X1	10,6	12,3	24,56	25,27	90	45	14,0	4
TM721MF120X125R2DHA	M12X1.25	10,4	12,3	24,43	25,24	90	45	14,0	4
TM721MF120X150R2DHA	M12X1.5	10,1	12,3	24,80	25,76	90	45	14,0	4
TM721M120X175R2DHA	M12X1.75	9,9	12,3	25,42	26,48	90	45	14,0	4
TM721MF140X150R2DHA	M14X1.5	12,1	14,3	29,31	30,25	100	48	16,0	4
TM721M140X200R2DHA	M14X2	11,6	14,3	29,05	30,24	100	48	16,0	4
TM721MF160X150R2DHA	M16X1.5	14,0	16,3	32,31	33,30	102	48	18,0	4
TM721M160X200R2DHA	M16X2	13,6	16,3	33,05	34,24	102	48	18,0	4

Shank Tolerance

D	tolerance h6
6	+0, -0,008
8-10	+0, -0,009
12-18	+0, -0,011
20-30	+0, -0,013

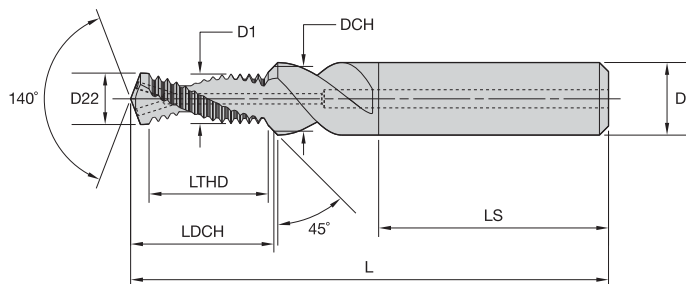

TM731 • Through Coolant • Metric and Metric Fine

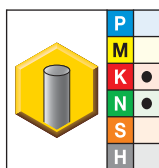

- first choice
- alternate choice

Taps

KCU32	D1 size	D22	D1	DCH	LTHD	LDCH	L	LS	D	cutting edges
TM731M040X070R2DHA	M4X0.7	3,3	3,2	4,3	7,74	9,59	49	36	6,0	2
TM731M050X080R2DHA	M5X0.8	4,2	4,0	5,3	9,65	11,82	55	36	6,0	2
TM731MF060X075R2DHA	M6X0.75	5,3	5,1	6,3	12,07	14,37	62	36	8,0	2
TM731M060X100R2DHA	M6X1	5,0	4,8	6,3	12,06	14,69	62	36	8,0	2
TM731MF080X100R2DHA	M8X1	7,0	6,8	8,3	16,09	19,10	74	40	10,0	2
TM731M080X125R2DHA	M8X1.25	6,8	6,5	8,3	15,08	18,42	74	40	10,0	2
TM731MF100X100R2DHA	M10X1	9,0	8,7	10,3	20,11	23,52	79	45	12,0	2
TM731MF100X125R2DHA	M10X1.25	8,8	8,4	10,3	20,11	23,87	79	45	12,0	2
TM731M100X150R2DHA	M10X1.5	8,5	8,2	10,3	19,59	23,65	79	45	12,0	2
TM731MF120X125R2DHA	M12X1.25	10,8	10,4	12,3	23,88	28,00	89	45	14,0	2
TM731MF120X150R2DHA	M12X1.5	10,5	10,2	12,3	24,12	28,57	89	45	14,0	2
TM731M120X175R2DHA	M12X1.75	10,3	9,9	12,3	22,86	27,63	89	45	14,0	2
TM731MF140X150R2DHA	M14X1.5	12,5	12,1	14,3	27,14	31,98	102	48	16,0	2
TM731M140X200R2DHA	M14X2	12,0	11,6	14,3	28,12	33,62	102	48	16,0	2
TM731MF160X150R2DHA	M16X1.5	14,5	14,1	16,3	31,65	36,87	102	48	18,0	2
TM731M160X200R2DHA	M16X2	14,0	13,6	16,3	32,13	38,00	102	48	18,0	2

Shank Tolerance

D	tolerance h6
6	+0, -0,008
8-10	+0, -0,009
12-18	+0, -0,011
20-30	+0, -0,013

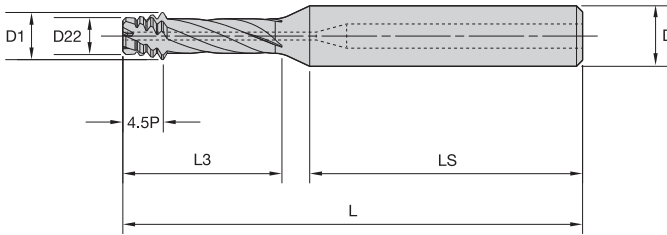

■ **TM741 • Through Coolant • Right Hand • Metric and Metric Fine**

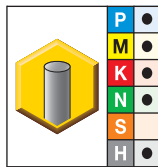

KCU36

- first choice
- alternate choice

	D1 size	D1	D22	L3	L	LS	D	cutting edges
TM741M060X100R2DHA	M6X1	4,51	3,41	16,5	60	36	8,0	3
TM741M070X100R2DHA	M7X1	4,51	3,41	16,5	60	36	8,0	3
TM741MF080X100R2DHA	M8X1	6,23	5,13	21,9	71	40	10,0	4
TM741M080X125R2DHA	M8X1.25	6,23	4,91	21,9	71	40	10,0	4
TM741MF090X100R2DHA	M9X1	6,23	5,13	21,9	71	40	10,0	4
TM741M090X125R2DHA	M9X1.25	6,23	4,91	21,9	71	40	10,0	4
TM741MF100X100R2DHA	M10X1	6,23	5,13	21,9	71	40	10,0	4
TM741MF100X125R2DHA	M10X1.25	6,23	4,91	21,9	71	40	10,0	4
TM741M100X150R2DHA	M10X1.5	7,75	6,11	26,3	76	40	10,0	4
TM741M110X150R2DHA	M11X1.5	7,75	6,11	26,3	76	40	10,0	4
TM741MF120X100R2DHA	M12X1	9,15	8,06	30,0	86	45	12,0	4
TM741MF120X150R2DHA	M12X1.5	7,75	6,11	26,3	76	40	10,0	4
TM741M120X175R2DHA	M12X1.75	9,16	7,21	32,4	86	45	12,0	4
TM741MF140X100R2DHA	M14X1	9,15	8,06	30,0	86	45	12,0	4
TM741MF140X150R2DHA	M14X1.5	10,83	9,15	37,4	98	48	16,0	4
TM741M140X200R2DHA	M14X2	11,08	8,91	41,0	98	48	16,0	4
TM741MF160X150R2DHA	M16X1.5	10,83	9,15	37,4	98	48	16,0	4
TM741M160X200R2DHA	M16X2	11,08	8,91	41,0	98	48	16,0	4
TM741MF180X150R2DHA	M18X1.5	14,83	13,15	47,0	98	48	16,0	4
TM741M180X250R2DHA	M18X2.5	14,38	11,71	51,3	111	50	20,0	5
TM741MF200X150R2DHA	M20X1.5	14,83	13,15	47,0	98	48	16,0	4
TM741M200X250R2DHA	M20X2.5	14,38	11,71	51,3	111	50	20,0	5
TM741MF220X150R2DHA	M22X1.5	18,23	16,55	56,0	111	50	20,0	5
TM741MF240X150R2DHA	M24X1.5	18,23	16,55	56,0	111	50	20,0	5

Shank Tolerance

D	tolerance h6
6	+0, -0,008
8-10	+0, -0,009
12-18	+0, -0,011
20-30	+0, -0,013

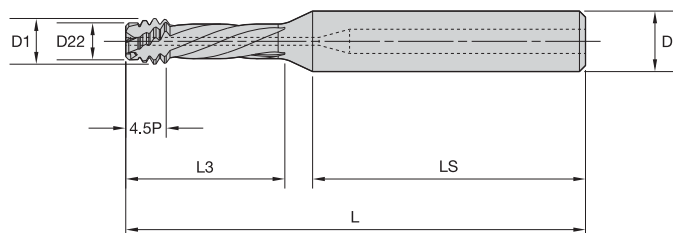

■ **TM741 • Through Coolant • Left Hand • Metric and Metric Fine**

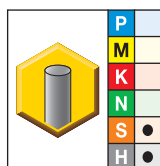

● first choice
○ alternate choice

Taps

	D1 size	D1	D22	L3	L	LS	D	cutting edges
KCU36								
TM741M060X100L2DHA	M6X1	4,51	3,41	16,5	60	36	8,0	3
TM741M070X100L2DHA	M7X1	4,51	3,41	16,5	60	36	8,0	3
TM741M080X125L2DHA	M8X1.25	6,23	4,91	21,9	71	40	10,0	4
TM741M090X125L2DHA	M9X1.25	6,23	4,91	21,9	71	40	10,0	4
TM741M100X150L2DHA	M10X1.5	7,75	6,11	26,3	76	40	10,0	4
TM741M110X150L2DHA	M11X1.5	7,75	6,11	26,3	76	40	10,0	4
TM741MF120X150L2DHA	M12X1.5	9,17	7,21	32,4	86	45	12,0	4

Shank Tolerance

D	tolerance h6
6	+0, -0,008
8-10	+0, -0,009
12-18	+0, -0,011
20-30	+0, -0,013

		Thread Mill TM711						Thread Mill and Chamfer TM721					
Material Group		Cutting Speed – vc Range – m/min			Feed/Tooth by Diameter			Cutting Speed – vc Range – m/min			Feed/Tooth by Diameter		
		min	Starting Value	max		<10mm	>10mm	min	Starting Value	max		<10mm	>10mm
		P	1	90	115	150	mm/r	0,05	0,08	140	185	240	mm/r
2	90		115	150	mm/r	0,05	0,08	140	185	240	mm/r	0,06	0,10
3	40		50	70	mm/r	0,02	0,03	70	90	120	mm/r	0,03	0,04
4	–		–	–	–	–	–	70	90	120	mm/r	0,03	0,04
5	60		80	100	mm/r	0,04	0,06	70	90	120	mm/r	0,05	0,08
6	–		–	–	–	–	–	–	–	–	–	–	–
M	1	60	80	100	mm/r	0,04	0,06	70	90	120	mm/r	0,05	0,08
	2	60	80	100	mm/r	0,04	0,06	70	90	120	mm/r	0,05	0,08
	3	–	–	–	–	–	–	–	–	–	–	–	–
K	1	120	150	200	mm/r	0,06	0,10	130	170	220	mm/r	0,06	0,11
	2	120	150	200	mm/r	0,06	0,10	130	170	220	mm/r	0,06	0,11
	3	90	115	150	mm/r	0,05	0,07	110	140	180	mm/r	0,05	0,07
N	1	250	275	300	mm/r	0,07	0,09	270	300	330	mm/r	0,08	0,16
	2	200	225	250	mm/r	0,05	0,06	270	300	330	mm/r	0,08	0,16
	3	170	190	210	mm/r	0,04	0,05	160	175	190	mm/r	0,08	0,16
	4	250	275	300	mm/r	0,07	0,09	270	300	330	mm/r	0,08	0,16
	5	270	300	330	mm/r	0,12	0,13	250	275	300	mm/r	0,11	0,20
	6	170	190	210	mm/r	0,05	0,06	90	100	110	mm/r	0,11	0,20
S	1	60	80	100	mm/r	0,04	0,06	70	90	120	mm/r	0,05	0,08
	2	50	65	80	mm/r	0,03	0,04	50	60	80	mm/r	0,03	0,05
	3	50	65	80	mm/r	0,03	0,04	50	60	80	mm/r	0,03	0,05
	4	50	65	80	mm/r	0,03	0,04	50	60	80	mm/r	0,03	0,05



		Drill, Chamfer, and Thread Mill TM731										
Material Group		Cutting Speed – vc Range – m/min			Drilling Recommended Feed by Diameter			Milling Feed/Tooth by Diameter				
		min	Starting Value	max		<6mm	6–10mm	10–16mm		<6mm	6–10mm	10–16mm
		K	1	130	175	230	mm/r	0,10	0,16	0,30	mm/r	0,05
2	270		300	330	mm/r	0,15	0,25	0,34	mm/r	0,06	0,08	0,12
N	3	140	150	170	mm/r	0,15	0,25	0,34	mm/r	0,06	0,08	0,12
	4	270	300	330	mm/r	0,15	0,25	0,34	mm/r	0,06	0,08	0,12
	5	110	120	130	mm/r	0,12	0,20	0,32	mm/r	0,06	0,08	0,12



Mill, Chamfer, and Thread Mill TM741

Material Group				Cutting Speed — vc Range — m/min			Feed/Tooth by Diameter		
	TM Style	Grade	min	Starting Value			<10mm	>10mm	
					max				
P	1	TM741 R	KCU36	170	225	290	mm/r	0,05	0,08
	2	TM741 R	KCU36	170	225	290	mm/r	0,05	0,08
	3	TM741 R	KCU36	120	150	200	mm/r	0,03	0,05
	4	TM741 R	KCU36	100	125	160	mm/r	0,03	0,05
	5	TM741 R	KCU36	120	150	200	mm/r	0,03	0,04
	6	TM741 R	KCU36	60	80	100	mm/r	0,03	0,04
M	1	TM741 R	KCU36	120	150	200	mm/r	0,03	0,04
	2	TM741 R	KCU36	120	150	200	mm/r	0,03	0,04
	3	TM741 R	KCU36	120	150	200	mm/r	0,03	0,04
K	1	TM741 R	KCU36	190	250	330	mm/r	0,06	0,10
	2	TM741 R	KCU36	190	250	330	mm/r	0,06	0,10
	3	TM741 R	KCU36	140	185	240	mm/r	0,04	0,07
N	1	—	—	—	—	—	—	—	—
	2	—	—	—	—	—	—	—	—
	3	TM741 R	KCU36	180	230	300	mm/r	0,06	0,07
	4	TM741 R	KCU36	210	275	360	mm/r	0,06	0,07
	5	—	—	—	—	—	—	—	—
	6	TM741 R	KCU36	210	275	360	mm/r	0,06	0,07
S	1	TM741 L	KCU36	120	150	200	mm/r	0,025	0,045
	2	TM741 L	KCU36	50	60	80	mm/r	0,015	0,025
	3	TM741 L	KCU36	50	60	80	mm/r	0,015	0,025
	4	TM741 L	KCU36	70	90	120	mm/r	0,025	0,035
H	1	TM741	KCU36	80	100	130	mm/r	0,030	0,050
	2	TM741	KCU36	80	100	130	mm/r	0,030	0,050
	3	TM741	KCU36	50	65	80	mm/r	0,020	0,030
	4	TM741	KCU36	50	65	80	mm/r	0,020	0,030

Taps

Milling Methods

Climb Milling

Properties:

Tool rotation direction clockwise

Tool moves anti-clockwise

Pitch "upwards"

Right-hand thread

Climb milling is always when the cutting edge goes out of the material with a chip thickness $h = 0$

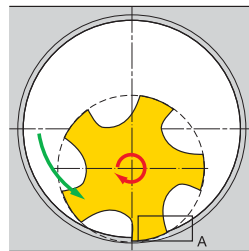
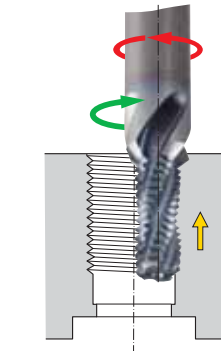
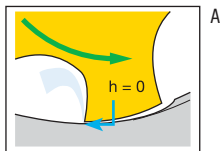

Conventional Milling

Properties:

Tool rotation direction clockwise

Tool moves clockwise

Pitch "downwards"

Right-hand thread

Conventional milling is always when the cutting edge goes out of the material with a chip thickness $h = \max$

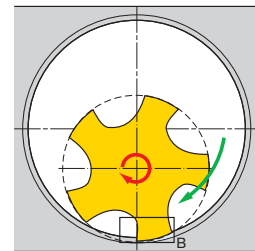
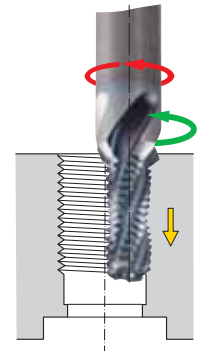
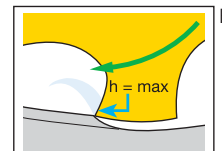

Counter Feed F_k

$$F_k = n \cdot f_z \cdot Z \text{ [mm/min]}$$

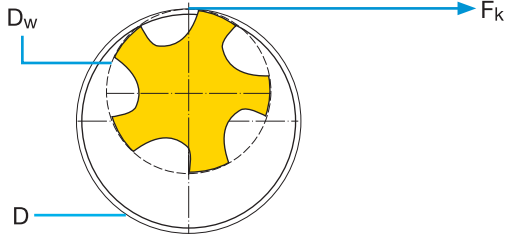

Centre Point Feed F_m

$$F_m = \frac{F_k \cdot (D - D_w)}{D} \text{ [mm/min]}$$

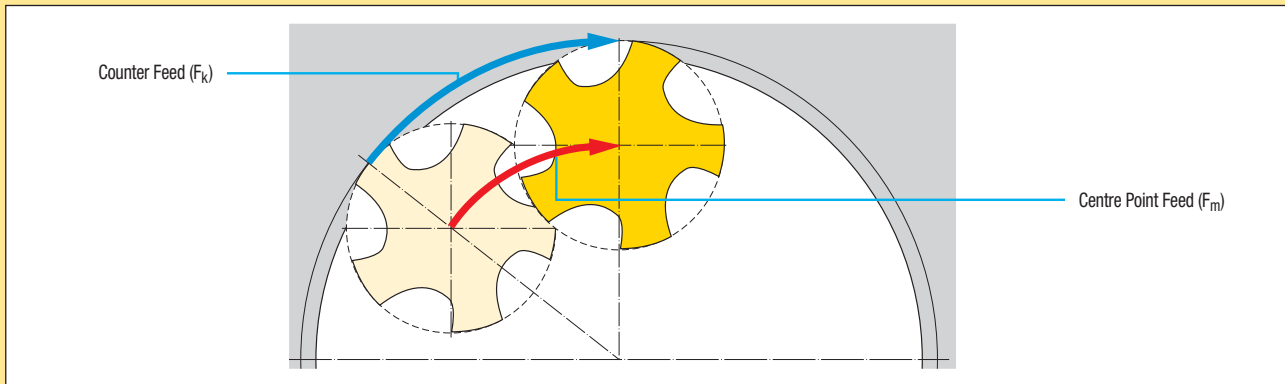
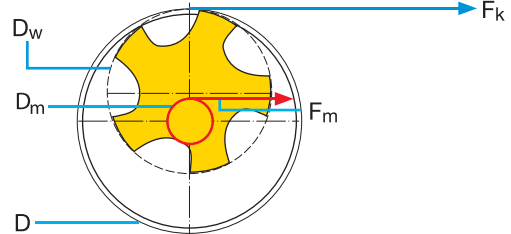

- D_w = Tool diameter [mm]
- n = RPM [min^{-1}]
- f_z = Feed per tooth [mm]
- Z = Number of teeth on tool (radial)
- D = Nominal diameter of thread = Diameter of external contour [mm]
- D_m = Diameter of the centre point ($D - D_w$) [mm]



Drill Thread Mill TM741 • Right Hand

Preparation

None

Process Principle

Milling thread and core hole, countersinking (conventional milling)

Cycle

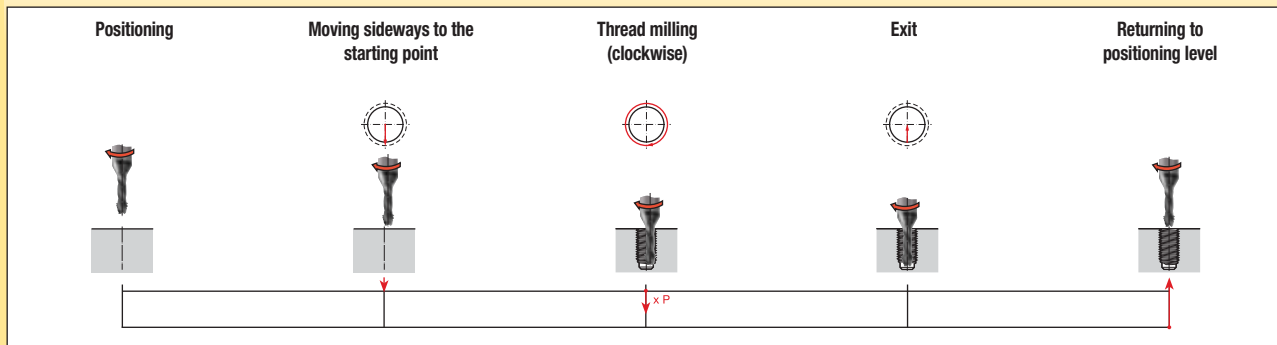

Required Specification Values

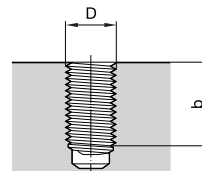
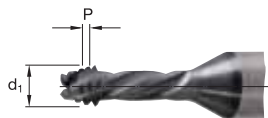

Taps

Example

Size — M10-6H
Thread diameter D10mm
Pitch P1,5mm
Core hole diameter D₁8,5mm
Material — Hard steel, 50 HRC
Grade — KCU36

Tool — TM741 Right Hand
Catalogue numberTM741M100X150R2DHA
Number of teeth Z4
Tool diameter d₁7,75mm*
Tool radius compensation k¹0,08mm**
Tool radius to be programmed²3,795mm***
Thread depth b20mm
Cutting speed v_c100 m/min
Feed (milling) f_z0,04 mm/tooth
Number of turns⁵17

$$N = \frac{v_c \cdot 1000}{d_1 \cdot \pi} \quad S = 4109$$

$$v_f = f_z \cdot Z \cdot n \quad F = 657 \text{ (contour)}$$

$$N = \frac{v_f \text{ contour} \cdot (D - d_1)}{D} \quad F = 148 \text{ (centre point)}$$

*(measured on the cutting part)

**0,01 x D; adjust to application

*** $(1/2 d_1 - k)$

Program to DIN 66025 (conventional milling, on the contour, incremental)

Positioning the tool	N 10	G 54	G 90	G 00	X...	Y...	Z 1.500	S 4109	T01 ²	M03 ⁶
Incremental programming	N 20	G 91								
Moving sideways to the starting point	N 30	G 42	G 01	X 0	Y-5	F 657 (contour)	[F 148] ⁴ (centre point)			
Thread milling	N 40	G 02		X 0	Y 0	Z-1.500	I 0	J 5.000		
Repeat thread milling	...	⁵								
Exit	N 50	G 40	G 01	X 0	Y 5					
Retracting tool to positioning level	N 70	G 90	G 00	Z 2						

Cutting time t₁

51,6 seconds

NOTES:

¹ The cutter radius measured over the tooth crests of the threaded part must be reduced by the amount of the cutter radius compensation. This is necessary to achieve a depth of cut to the middle of the 6H/ISO2 nut tolerance. Please note, however, that this also depends on the radial deflection of the tool (tensile strength of the material, projecting length of the tool).

² The cutter radius to be programmed is normally included in the tool memory.

³ The thread depth b must be divisible by the thread pitch P.

⁴ The feed values in brackets must be used for controllers, which do not calculate the centre point feed themselves.

⁵ Set N40 must be repeated with the number of threads. Repetitions N = thread depth b/pitch P (rounded up to the nearest integer).

Drill Thread Mill TM741 • Left Hand

Preparation

None

Process Principle

Milling thread and core hole, countersinking (climb milling)

Cycle

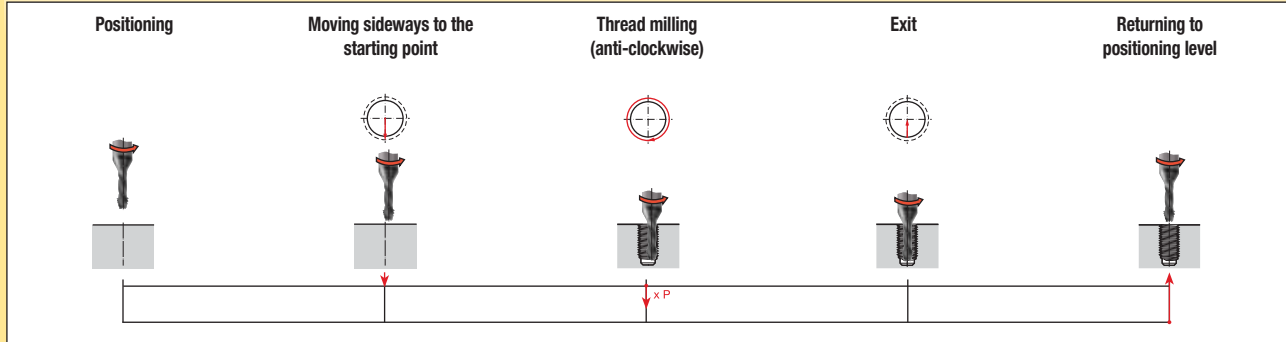

Required Specification Values

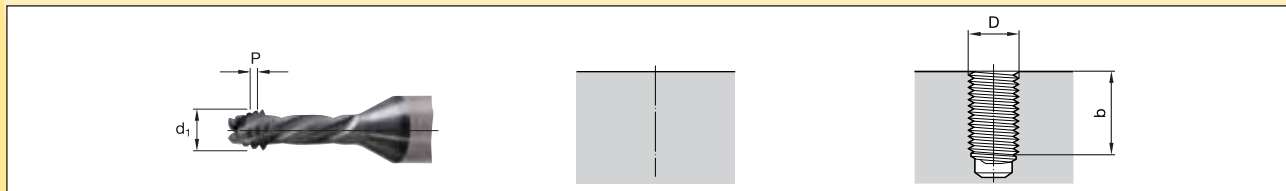

Example

Size — M10-6H
 Thread diameter D10mm
 Pitch P1,5mm
 Core hole diameter D₁8,5mm

Material — TiAl6V4 titanium

Grade — KCU36

Tool — TM741 Left Hand
 Catalogue numberTM741M100X150L2DHA
 Number of teeth Z4
 Tool diameter d₁7,75mm*
 Tool radius compensation k¹0,08mm**
 Tool radius to be programmed²3,795mm***
 Drilling/countersink depth l_E20mm
 Cutting speed v_c100 m/min
 Feed (milling) f_z0,03 mm/tooth
 Number of turns⁵17

*(measured on the cutting part)

** (0,01 x D)

*** (1/2 d₁ - k)

$$N = \frac{v_c \cdot 1000}{d_1 \cdot \pi} \quad S = 4109$$

$$v_f = f_z \cdot Z \cdot n \quad F = 493 \text{ (contour)}$$

$$v_f = \frac{v_f \text{ contour} \cdot (D - d_1)}{D} \quad F = 111 \text{ (centre point)}$$

Program to DIN 66025 (climb milling, on the contour, incremental)

Positioning the tool	N 10	G 54	G 90	G 00	X...	Y...	Z 1.500	S 4109	T01 ²	M04
Incremental programming	N 20	G 91								
Moving sideways to the starting point	N 30	G 42	G 01	X 0	Y -5	F 493 (contour)	[F 111] ⁴			(centre point)
Thread milling	N 40	G 02		X 0	Y 0	Z -1.500	I 0	J 5.000		
Repeat thread milling	...	⁵								
Exit	N 50	G 40	G 01	X 0	Y 5					
Retracting tool to positioning level	N 70	G 90	G 00	Z 2						

Cutting time t_h

68,8 seconds

NOTES:

¹ The cutter radius measured over the tooth crests of the threaded part must be reduced by the amount of the cutter radius compensation. This is necessary to achieve a depth of cut to the middle of the 6H/ISO2 nut tolerance. Please note, however, that this also depends on the radial deflection of the tool (tensile strength of the material, projecting length of the tool).

² The cutter radius to be programmed is normally included in the tool memory.

³ The thread depth b must be divisible by the thread pitch P.

⁴ The feed values in brackets must be used for controllers, which do not calculate the centre point feed themselves.

⁵ Set N40 must be repeated with the number of threads. Repetitions N = thread depth b/pitch P (rounded up to the nearest integer).



Drill Thread Mill TM731

Preparation

None

Process Principle

Drilling, countersinking, thread milling (climb milling)

Cycle

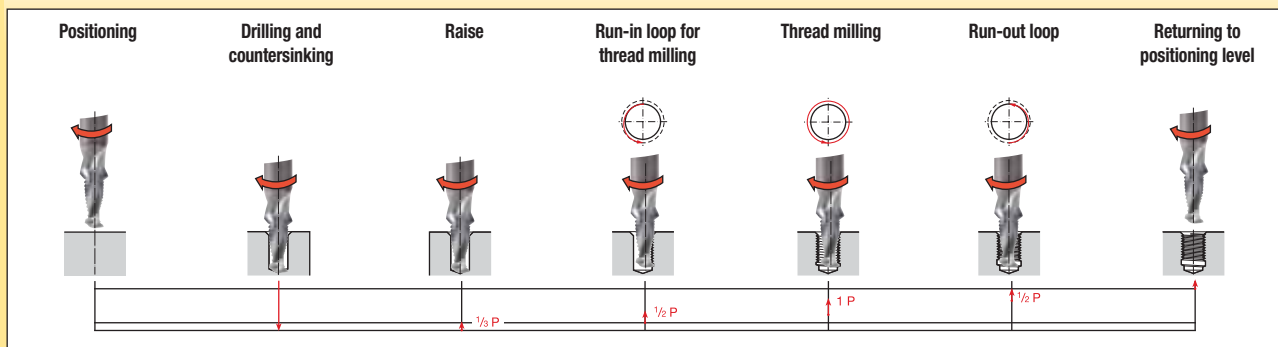

Required Specification Values

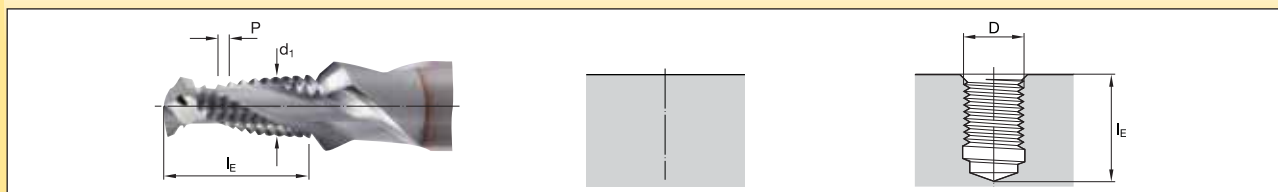

Example

Size — M10-6H
Thread diameter D10mm
Pitch P1,5mm
Core hole diameter D₁8,5mm
Material — Grey cast iron
Grade — KCU32

Tool — TM731
Catalogue numberTM731M100X150R2DHA
Number of teeth Z2
Tool diameter d₁8,2mm*
Tool radius compensation k¹0,1mm**
Tool radius to be programmed²4mm***
Drilling/countersink depth l_E19,11mm
Cutting speed v_c250 m/min
Feed (drilling, countersinking) f_b0,25 mm/U
Feed (milling) f_z0,1 mm/tooth

$$N = \frac{v_c \cdot 1000}{d_1 \cdot \pi} \quad S = 9709$$

$$v_b = f_b \cdot n \quad F = 2427 \text{ (drilling, countersinking)}$$

$$v_f = f_z \cdot Z \cdot n \quad F = 1942 \text{ (contour)}$$

$$v_f = \frac{v_f \text{ contour} \cdot (D - d_1)}{D} \quad F = 350 \text{ (centre point)}$$

*(measured on the cutting part)

** (0,01 x D)

*** (1/2 d₁ - k)

Program to DIN 66025 (climb milling, on the contour, incremental)

Positioning the tool	N 10	G 54	G 90	G 00	X...	Y...	Z 2	S 9709	T01 ²	M03
Drilling and countersinking	N 20	G 91	G 01	Z-21.110	F 2427	(drill, countersink)				
Raise	N 30	G 01	Z 0.500							
Moving sideways to the starting point	N 40	G 41	Y-4.250	F 971	(milling, 1/2 contour)			[F 175] ³ (1/2 centre point)		
Run-in loop in arc	N 50	G 03	X 0	Y 9.250	Z 0.750	I 0	J 4.625			
Thread milling	N 60	G 03	X 0	Y 0	Z 1.500	I 0	J -5.000	F 1942	[F 350] ³ (centre point)	
Run-out loop in arc	N 70	G 03	X 0	Y -9.250	Z 0.750	I 0	J -4.625			
Exit	N 80	G 00	G 40	X 0	Y 4.250					
Retracting tool to positioning level	N 90	G 90	Z 2							

Cutting time t_h

2,3 seconds

NOTES:

¹ The cutter radius measured over the tooth crests of the threaded part must be reduced by the amount of the cutter radius compensation. This is necessary to achieve a depth of cut to the middle of the 6H/ISO2 nut tolerance. Please note, however, that this also depends on the radial deflection of the tool (tensile strength of the material, projecting length of the tool).

² The cutter radius to be programmed is normally included in the tool memory.

³ The feed values in brackets must be used for controllers, which do not calculate the centre point feed themselves.

Thread Mill TM721

Preparation

Drilling of thread hole

Process Principle

Countersinking, thread milling (conventional milling)

Cycle

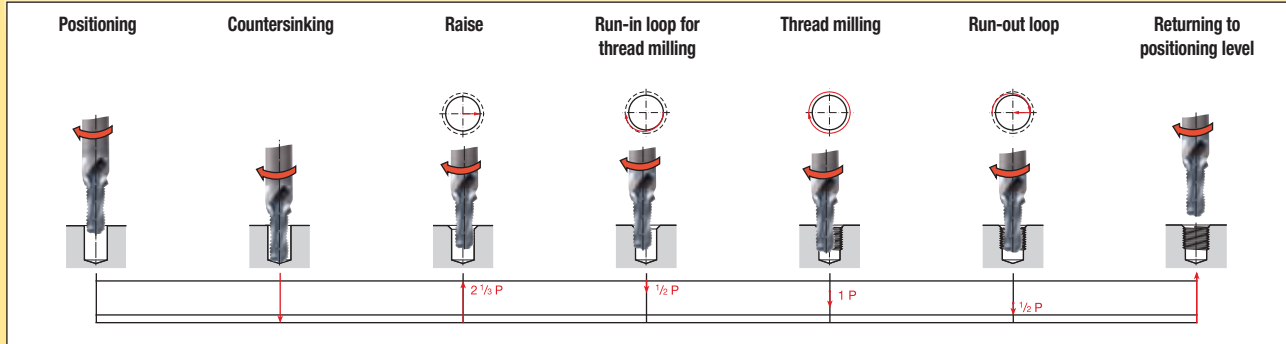

Required Specification Values

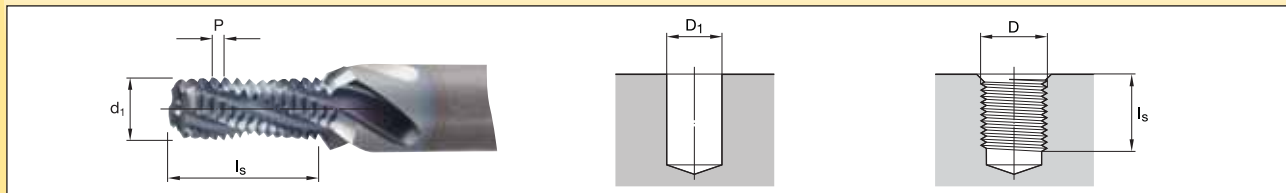

Example

Size — M10-6H
 Thread diameter D10mm
 Pitch P1,5mm
 Core hole diameter D₁8,5mm
Material — Cast aluminium
Grade — KCU32

Tool — TM721
 Catalogue numberTM721M100X150R2DHA
 Number of teeth Z3
 Tool diameter d₁8,2mm*
 Tool radius compensation k¹0,1mm**
 Tool radius to be programmed²4mm***
 Countersink depth l_s21,2mm
 Cutting speed v_c250 m/min
 Feed (countersinking) f_s0,3 mm/U
 Feed (milling) f_z0,09 mm/tooth

$N = \frac{v_c \cdot 1000}{d_1 \cdot \pi}$	S = 9709
$v_s = f_s \cdot n$	F = 2913 (countersinking)
$v_f = f_z \cdot Z \cdot n$	F = 2622 (contour)
$v_f = \frac{v_f \text{ contour} \cdot (D - d_1)}{D}$	F = 472 (centre point)

* (measured on the cutting part)

** (0,01 x D)

*** (1/2 d₁ - k)

Program to DIN 66025 (conventional milling, on the contour, incremental)

Positioning the tool	N 10	G 54	G 90	G 00	X...	Y...	Z 2	S 9709	T01 ²	M03
Advancing tool to full thread depth	N 20	G 91	Z-21.200							
Countersinking	N 30	G 01	Z-2	F 2913	(countersink)					
Raise	N 40	G 00	Z 3.450							
Moving sideways to the starting point	N 50	G 42	G01	X 4.250	F 1311 (milling, 1/2 contour)	[F 236] ³ (milling, 1/2 centre point)				
Run-in loop in arc	N 60	G 02	X-9.25	Y 0.000	Z-0.750	I-4.625	J 0			
Thread milling	N 70	G 02	X 0	Y 0	Z-1.500	I 5	J 0.000	F2622 [F 472] ³ (centre point)		
Run-out loop in arc	N 80	G 02	X 9.25	Y 0.000	Z-0.750	I 4.625	J 0			
Exit	N 90	G 40	G 01	X-4.25						
Retracting tool to positioning level	N 100	G 90	G 00	Z 2						

Cutting time t_h

1,4 seconds

NOTES:

¹ The cutter radius measured over the tooth crests of the threaded part must be reduced by the amount of the cutter radius compensation. This is necessary to achieve a depth of cut to the middle of the 6H/ISD2 nut tolerance. Please note, however, that this also depends on the radial deflection of the tool (tensile strength of the material, projecting length of the tool).

² The cutter radius to be programmed is normally included in the tool memory.

³ The feed values in brackets must be used for controllers, which do not calculate the centre point feed themselves.





Taps and Thread Milling Technical Information

The technical information in the following section can be used to assist you with your tapping and thread milling operations. Whether you are simply searching for information about tap dimensions and recommendations, or you're trying to solve basic tapping and thread milling problems, you will find the relevant data here.

This Section Includes the Following Information:

- Illustrations of tap terms.
- Explanations of tap chamfers.
- Dimensional information for various tap styles and lengths.
- Tap limitation data.
- Chip handling methods for different tap styles.
- Tap recommendations.
- Descriptions of screw thread tolerance and tolerance information.
- Information regarding surface treatments and coatings.
- Guidelines and tables for determining tapping speeds.
- Troubleshooting charts.
- Hardness conversion table.
- A guide to Kennametal tapping application icons.
- Taps custom order worksheet.
- Thread Milling application sheet.

This section will further your knowledge of tapping and thread milling operations enabling you to maximise the value of your tools.

How to Apply This Technical Information

Below is an example of where the technical information in this catalogue can be useful:

Problem

- Thread holes are oversized and taps are experiencing low life when working with stainless steel materials.

Solution

- Consult the troubleshooting portion of the Technical Information section to discover ways to correct the issue.

Definitions and Angles, Centres and Flute Forms

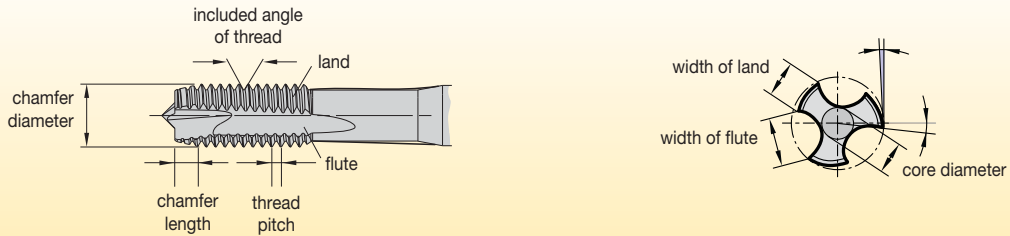
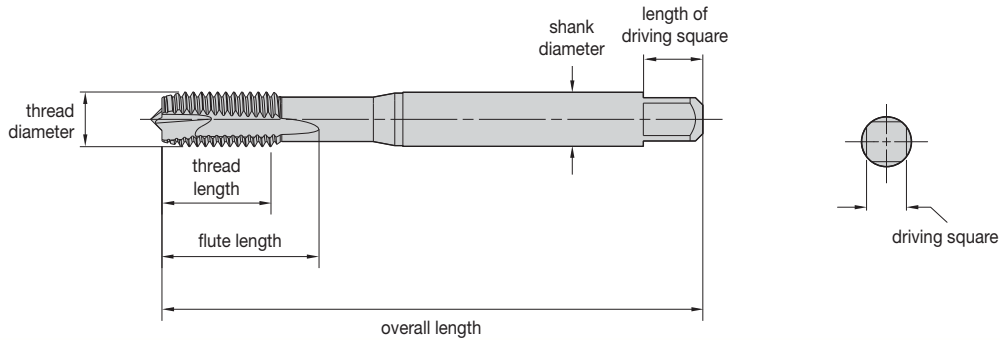

Taps

Flute Forms



Straight flute, form C plug chamfer **without spiral point**



Right-hand spiral flute



Straight flute, form B plug chamfer **with spiral point**



Left-hand spiral flute

Types of Centres (Standard to DIN 2197/DIN 2175)

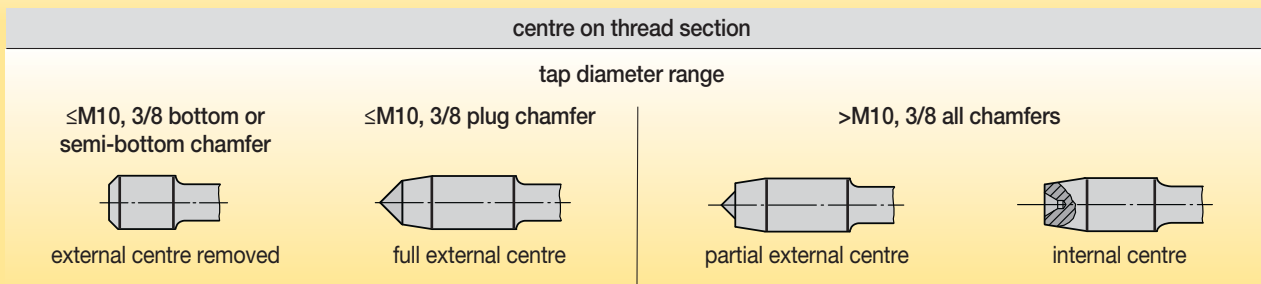

Coolant Hole Types



Axial coolant delivery with axial coolant exit hole



Axial coolant delivery with radial coolant hole exiting in the flutes

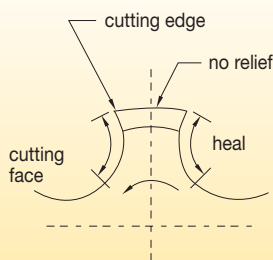
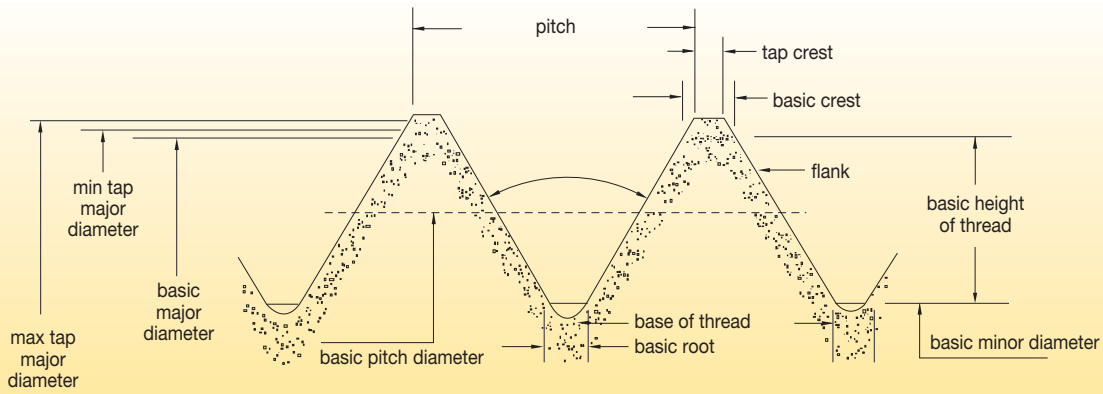

Concentric

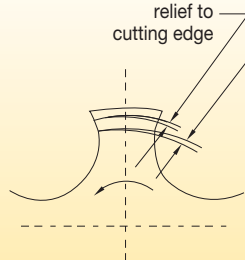

Eccentric Relief

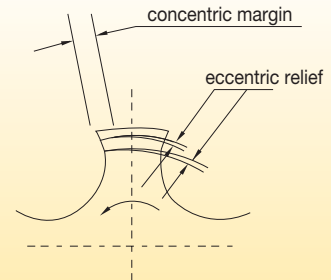

Con-Eccentric Relief

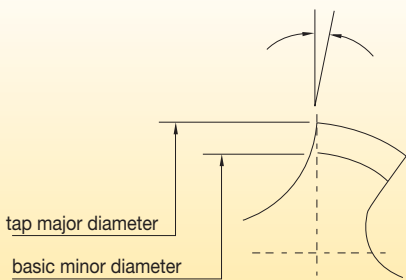

Negative Hook

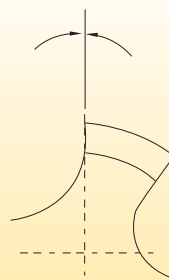

0° Hook

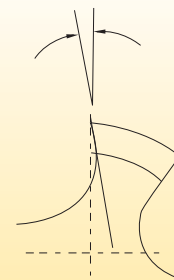

Positive Hook

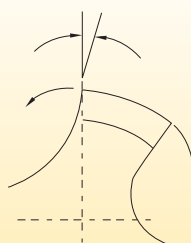

Negative Rake

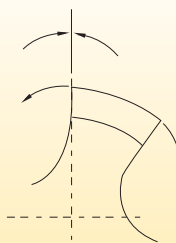

Radial Rake

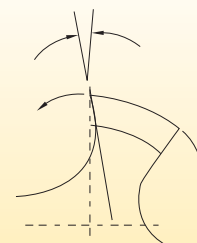

Positive Rake

Reprinted with permission from United States Cutting Tool Institute (USCTI).

Taps

■ Tap Chamfers • DIN Taps

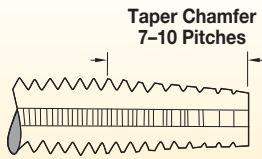

Form A (6–8 pitches)
The Form A chamfer has the longest standard chamfer ensuring easier starting. It provides the longest life because of more working teeth.

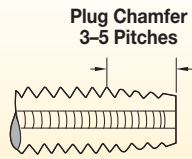

Form B/D (3,5–5 pitches)
The most common chamfers for use by hand or machine in through hole. Form B applies to spiral-point taps, and Form D applies to straight-flute and spiral-flute taps. This chamfer is more efficient than a Form E or Form C chamfers.

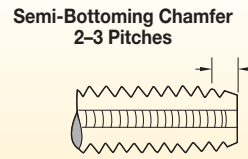

Form C (2–3 pitches)
This short chamfer enables threading close to the bottom of blind holes. Due to the slightly longer chamfer and more working teeth, this chamfer is more efficient than a Form E chamfer.

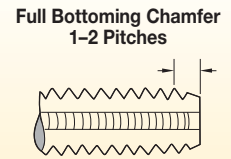

Form E (2–3 pitches)
For threading close to the bottom of blind holes, the Form E chamfer is the least efficient chamfer available.

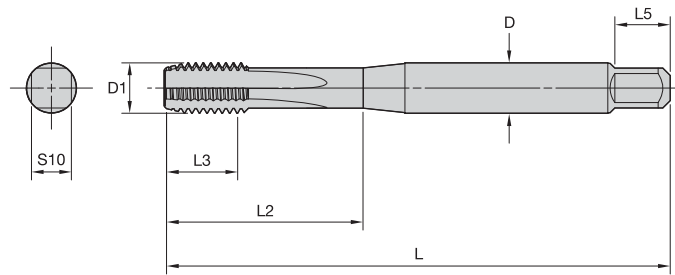

■ DIN 371

D1	pitch	D	L	L3*	L2	L5	S10
M3	0,5	3,5	56	11	18	6	2,7
M3,5	0,6	4	56	12	20	6	3
M4	0,7	4,5	63	13	21	6	3,4
M4,5	0,75	6	70	16	25	8	4,9
M5	0,8	6	70	16	25	8	4,9
M6	1	6	80	19	30	8	4,9
M7	1	7	80	19	30	8	5,5
M8	0,75	8	80	18	30	9	6,2
M8	1,25	8	90	22	35	9	6,2
M9	0,75	9	80	18	30	10	7
M9	1,25	9	90	22	35	10	7
M10	1	10	90	20	35	11	8
M10	1,5	10	100	24	39	11	8

*Maximum

Taps

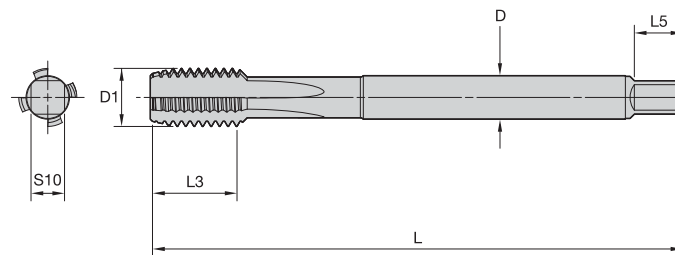

■ DIN 376

D1	pitch	D	L	L3*	L5	S10
M8	1,25	6	90	22	8	4,9
M9	1,25	7	90	22	8	5,5
M10	1,5	7	100	24	8	5,5
M11	1,5	8	100	24	9	6,2
M12	1,75	9	110	28	10	7
M14	2	11	110	30	12	9
M16	2	12	110	32	12	9
M18	2,5	14	125	34	14	11
M20	2,5	16	140	34	15	12
M22	2,5	18	140	34	17	14,5
M24	3	18	160	38	17	14,5
M27	3	20	160	38	19	16
M30	3,5	22	180	45	21	18
M33	3,5	25	180	50	23	20
M36	4	28	200	56	25	22
M39	4	32	200	60	27	24
M42	4,5	32	200	60	27	24
M45	4,5	36	220	65	32	29

*Maximum

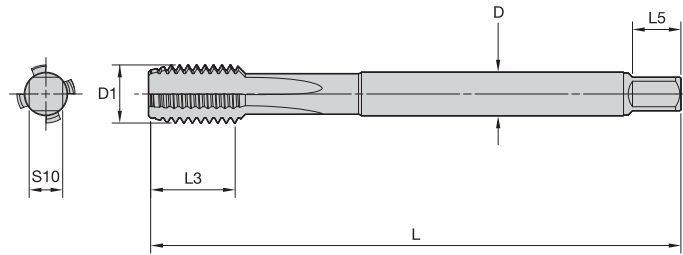

■ DIN 374

D1	pitch		D	L	L3*	L5	S10
	minimum	maximum					
M8	0,2	0,75	6	80	18	8	4,9
M8	—	1	6	90	22	8	4,9
M9	0,2	0,75	7	80	18	8	5,5
M9	—	1	7	90	22	8	5,5
M10	0,2	1	7	90	20	8	5,5
M10	—	1,25	7	100	24	8	5,5
M11	0,35	1	8	90	20	9	6,2
M12	0,35	1,5	9	100	22	10	7
M14	0,35	1,5	11	100	22	12	9
M16	0,35	1,5	12	100	22	12	9
M16	—	2	12	110	32	12	9
M18	0,35	1,5	14	110	25	14	11
M18	—	2	14	125	34	14	11
M20	0,35	1,5	16	125	25	15	12
M20	—	2	16	140	34	15	12
M22	0,35	1,5	18	125	25	17	14,5
M22	—	2	18	140	34	17	14,5
M24	0,35	2	18	140	28	17	14,5
M27	0,35	2	20	140	28	19	16
M30	0,35	2	22	150	28	21	18
M30	—	3	22	180	45	21	18

*Maximum



Taps

Through Holes
Push Chips

- Spiral point or LHSF (Left-Hand Spiral Flute).
- Ideal for materials with long chips.

Spiral Point LHSF

Blind Holes
Pull Chips

- RHSF (Right-Hand Spiral Flute).
- Ideal for materials with long chips.

RHSF

Blind or Through Holes
Store Chips

- STFL (Straight Flute).
- Ideal for materials with short chips.

STFL

Blind or Through Holes
No Chips

- Forming.
- Ideal for ductile materials <32 HRC.

Forming

Internal Unified Thread

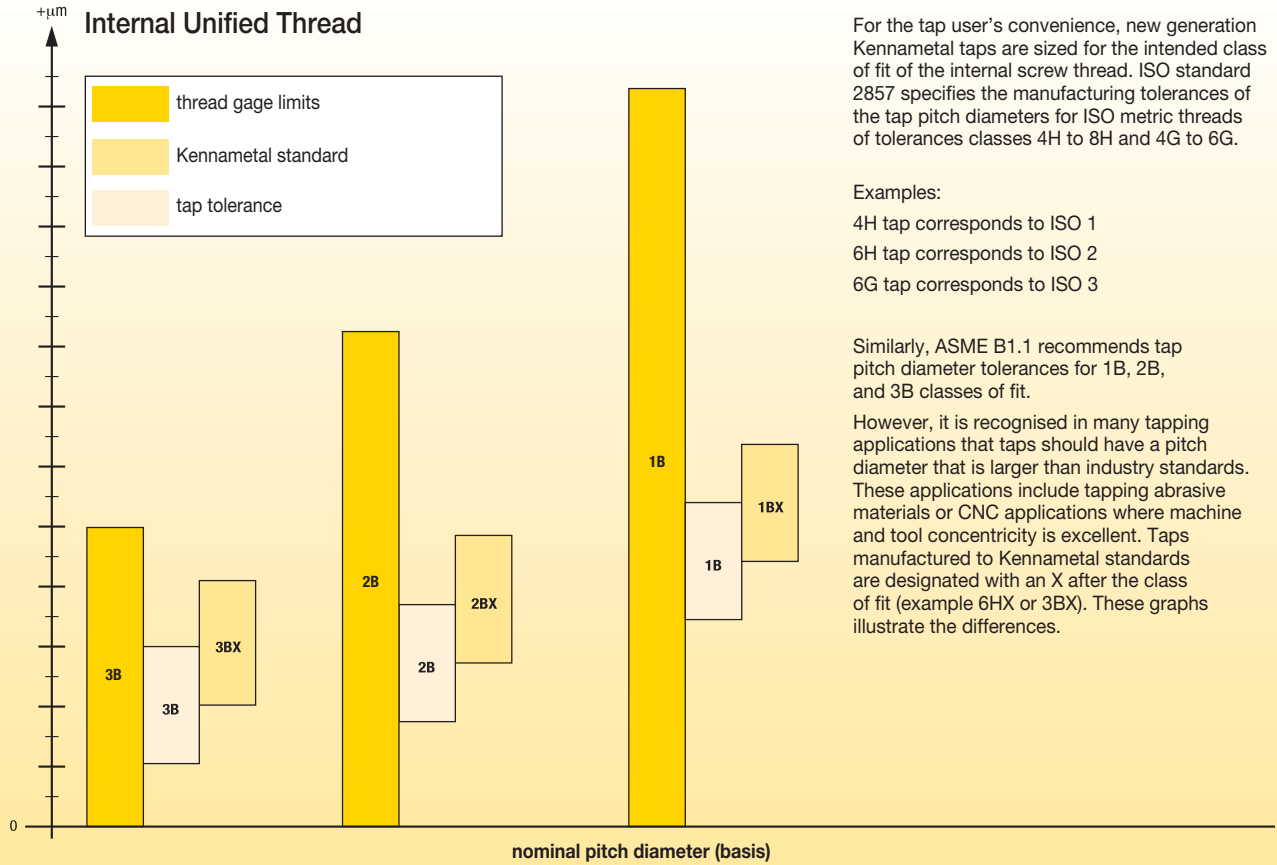

Taps

Internal Metric Thread

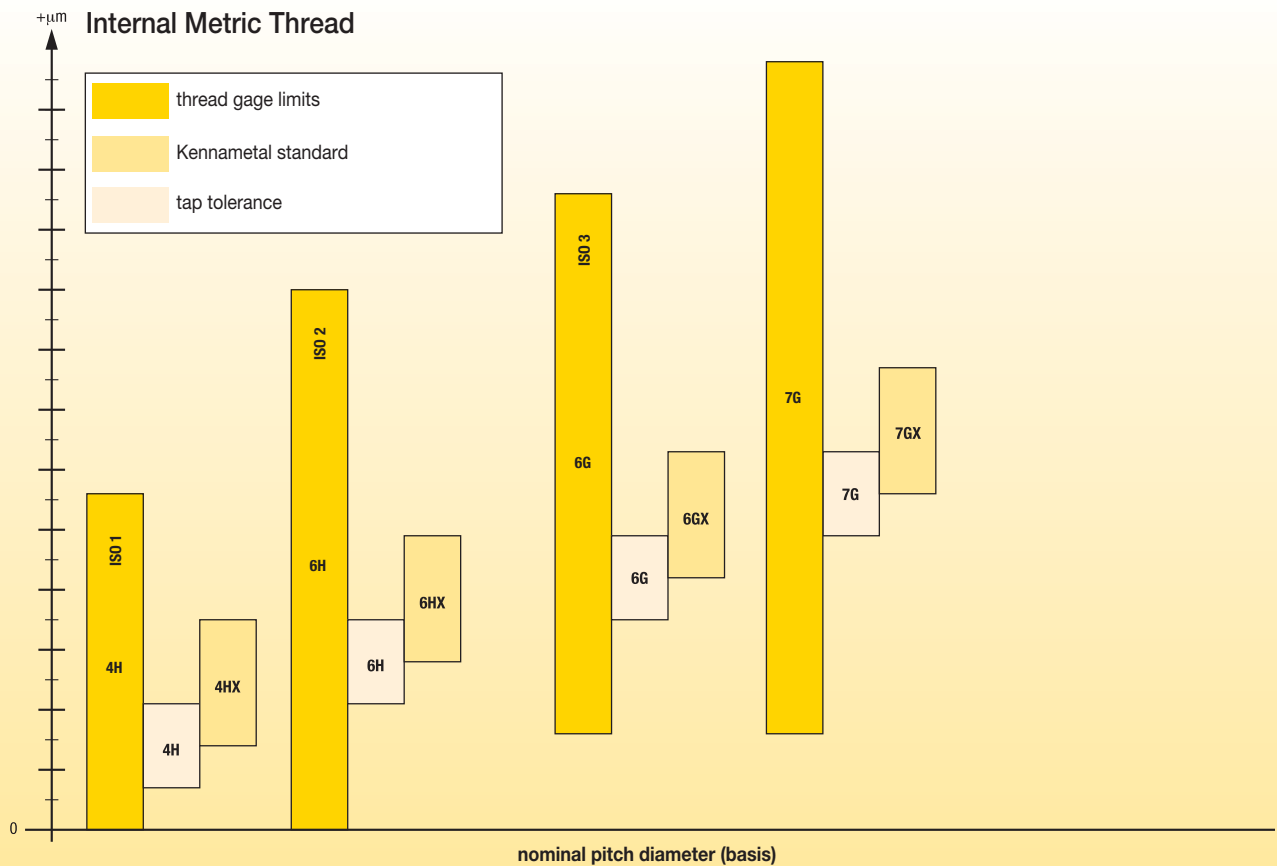

It is generally recognised that, in mass production, it is impossible to reproduce in exact detail the theoretically perfect product as laid out on the drawing board. The allowed slight variation between the theoretically perfect product drawing and each unit of the actual product is called the tolerance.

Allowance

An intentional difference in correlated dimensions of mating parts. It is the minimum clearance or maximum interference between such parts.

Angle of Thread

The angle included between the flanks of the thread measured in an axial plane

Half Angle of Thread

The angle included between a flank of the thread and the normal (90°) to the axis, measured in an axial plane.

Lead of Thread

The distance a screw thread advances axially in one turn. On a single-thread screw, the lead and pitch are identical. On a double thread, the lead is 2x pitch; on a triple thread, the lead is 3x pitch, etc.

Major Diameter

The largest diameter of a straight-screw thread.

Minor Diameter

The smallest diameter of a straight-screw thread.

Pitch

The distance from a point on a screw thread to a corresponding point on the next thread measured parallel to the axis.

The pitch in inches = $\frac{1}{\text{number of threads per inch}}$

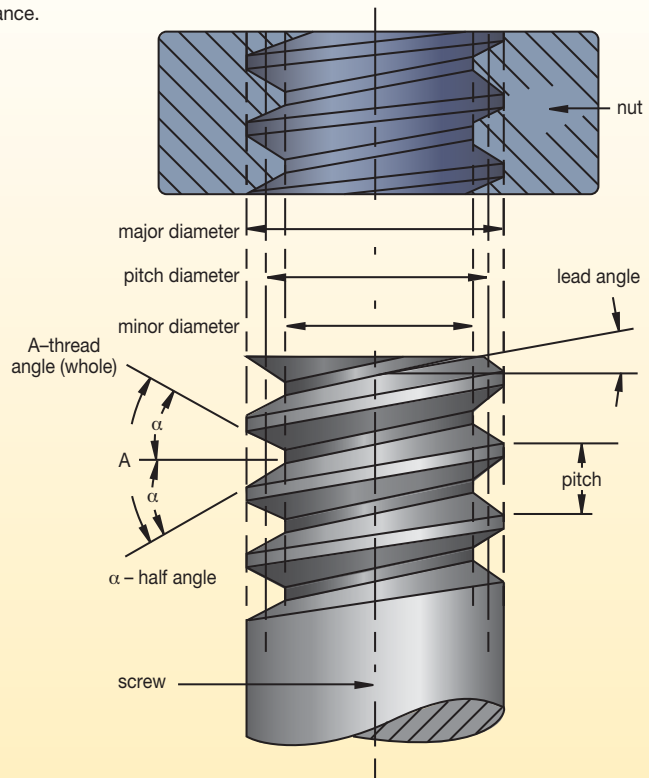

Taps

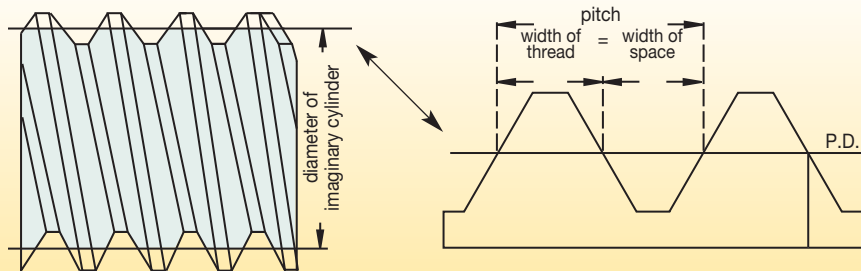

Pitch Diameter

On a straight-screw thread, the diameter of an imaginary cylinder that would pass through the threads at such points as to make equal the width of the threads and the width of the spaces cut by the surface of the cylinder.



More than just the right tool • the ultimate solution.

That's **Beyond BLAST™**



That's **Different Thinking.**

At Kennametal, innovation follows vision. Our revolutionary products and services are inspired by asking “what if?” The solutions that follow — like our Beyond BLAST through-coolant inserts — deliver remarkable results in the world’s most demanding machining environments.

A cutting-edge insert that delivers coolant precisely at the cutting edge. Now that’s Different Thinking. That’s Kennametal.

To learn more about your productivity gains using Beyond BLAST technology, visit www.kennametal.com.

Milling

- Beyond BLAST technology uses low-pressure conditions to offer many of the high-pressure performance benefits.
- Delivers superior performance on titanium, using either high- or low-pressure coolant systems.
- Effective thermal management results in reduced cutting temperatures, improved lubricity, superior chip control, and longer tool life.
- Beyond BLAST for milling increases tool life by up to 100% compared with conventional coolant delivery systems.

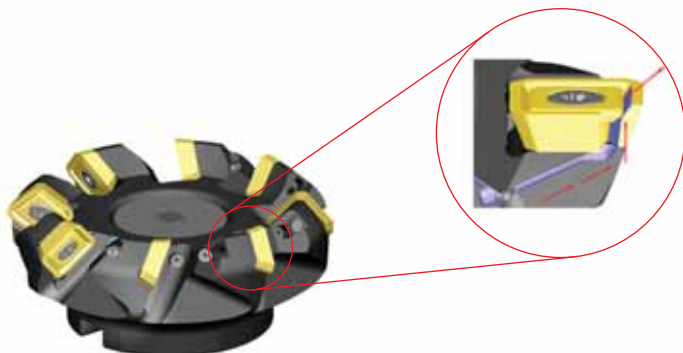

beyond™ BLAST™

Factors when trying to determine the best tapping speeds:

- Material to be tapped
- Length of chamfer on tap
- Percentage of full thread to be cut
- Length of hole (depth of thread)
- Pitch of thread
- Cutting fluids
- Machine equipment
- Horizontal or vertical tapping

The best and most efficient operating speeds for taps cannot be calculated with the same certainty, as for many other metalcutting tools.

With other tools, the feed per revolution can be set at any desired point and can be varied as conditions demand. Taps, on the other hand, must always be advanced at a rate equal to one pitch for every revolution, or one lead in the case of multistart threads.

The style of tap may vary the conditions. For example, with a bottoming tap, the chamfer cuts a heavy chip, while with a taper tap, the chamfer cuts a very thin chip.

The depth of thread also varies, depending on the pitch. The coarser the thread, the greater the advance of the tap per revolution and the greater the amount of material removed.

The method of feeding the tap, and the type of equipment for driving, also influences the permissible speeds. If taps are mechanically fed at the proper rate of advance, they can be operated at higher speeds than if used with flexible tapping holders on machines with poor feed control.

Speeds may be modified to take into account any or all of these factors:

- Speeds must be lowered as length of thread increases because, in deep thread holes, the accumulated chips increase friction and interfere with lubrication.
- Bottoming taps must be run slower than plug taps.
- Tapping full height of thread calls for slower speed than if the commercial 75% height only is required.
- Coarse-thread taps in the larger diameters should be run more slowly than fine-thread taps of the same diameters.
- The quantity and quality of cutting fluid may affect the permissible speeds as much as 100%.
- Taper threaded taps, such as pipe taps, should be operated from 1/2–3/4 the speed of a straight thread tap of comparable major diameter.
- Increase the speed of coolant taps up to 25%.

RPM Formulas

SFM = Surface Feet per Minute

RPM = Revolutions per Minute

IPM = Inches per Minute

TPI = Threads per Inch

S m/min = Surface Metres per Minute

$\Pi = 3.1416$

mm/min = millimetres per minute

P = Pitch (1/number of threads per inch)

Inch Sizes

$$\text{SFM} = \frac{\text{RPM} \times \text{tool diameter}}{3.82} \quad \text{or} \quad 0.26 \times \text{RPM} \times \text{tool diameter}$$

$$\text{RPM} = \frac{3.82 \times \text{SFM}}{\text{tool diameter}}$$

$$\text{IPM} = \frac{\text{RPM}}{\text{TPI}^*} \quad \text{or} \quad *P \times \text{RPM}$$

Metric Sizes

$$\text{S m/min} = \frac{\Pi \times \text{tool diameter} \times \text{RPM}}{1000}$$

$$\text{RPM} = \frac{\text{mm/min} \times 1000}{\Pi \times \text{tool diameter}}$$

$$\text{mm/min} = \text{mm P} \times \text{RPM}$$

■ Metric

metric taps	Vc = metres per minute (m/min)																	
	1,5	3	4,5	6	7,5	10	12	15	18	21	24	27	30	33	36	39	42	45
	revolutions per minute (RPM)																	
M1	490	979	1469	1959	2449	2938	3918	4897	5877	6856	7836	8815	9795	10774	11754	12733	13713	14692
M2	242	484	725	967	1209	1451	1934	2418	2901	3385	3868	4352	4835	5319	5803	6286	6770	7253
M3	162	324	486	347	809	971	1295	1619	1942	2266	2590	2914	3237	3561	3885	4208	4532	4856
M3.5	138	277	415	554	692	830	1107	1384	1661	1938	2214	1491	2768	3045	3322	3599	3875	4152
M4	122	243	365	487	608	730	973	1217	1460	1703	1946	2190	2433	2676	2920	3163	3406	3650
M5	97	194	291	388	485	582	776	970	1163	1357	1551	1745	1939	2133	2327	2521	2715	2905
M6	81	162	243	324	405	486	647	809	971	1133	1295	1457	1619	1781	1942	2104	2266	2428
M7	69	138	208	277	346	415	554	692	830	969	1107	1246	1384	1522	1661	1799	1938	2076
M8	61	121	182	243	303	364	485	606	728	849	970	1091	1213	1334	1455	1577	1698	1819
M10	48	97	145	194	242	291	388	485	582	679	776	873	970	1067	1163	1260	1357	1454
M12	40	81	121	162	202	243	324	405	486	567	647	728	809	890	971	1052	1133	1214
M14	35	69	104	139	173	208	277	347	416	485	555	624	693	763	832	901	971	1040
M16	30	61	91	121	152	182	243	303	364	424	485	546	606	667	728	788	849	910
M18	27	54	81	108	135	162	216	269	323	377	431	485	539	593	647	700	754	808
M20	24	49	73	97	121	146	194	243	291	340	388	437	485	534	582	631	680	728
M22	22	44	66	88	110	132	176	221	265	309	353	397	441	485	529	573	618	662
M24	20	40	61	81	101	121	162	202	243	283	323	364	404	445	485	526	566	606
M27	18	36	54	72	90	108	144	180	216	252	287	323	359	395	431	467	503	539
M30	16	32	49	65	81	97	129	162	194	226	259	291	323	356	388	420	453	485



Partial List of Solutions to Tapping Problems

application	symptom	common cause	remedy
general	gage out of limits	tap size and gage mismatch	select tap size for gage
	oversize thread	alignment, spindle feed	correct
	oversize at top	runout or alignment	correct
	go gage binds part way	worn tool, tap cuts off lead	replace tap, synchronous holder
	thread shaving	feed error, high axial force	program, synchronous holder
	chipping	high cutting force, worn tap	tap geometry, replace tap
	breakage	chip jamming flutes	tap geometry, tapping depth
	—	worn tool, high torque	replace tap with new tool
	short life, low speed	excessive wear	SC or HSS-E-PM HP taps
steel	birdnest blind hole	long, ductile chips	GT30 GP6505 (oxide), peck feed
	chipping	high material hardness	GT00, GT02 WP31MG (TiN)
	breakage in blind holes	hole depth >2D, chip jamming	GT04 WH36MG (TiN/MoS ₂)
stainless steel	oversize thread, low life	galling	GT20, GT30 GM6515 (TiN-CrC/C)
	short life	work hardened core hole	replace drill
cast iron	excessive wear	abrasion	GT40 GP6520 (TiCN)
aluminium, cast	excessive wear	high silicon	GT40 GP6520 (TiCN)
aluminium, wrought	oversize thread	galling	GT70, GT80 WN48EG (DLC)
nickel, cobalt alloys	short life	high cutting temperature	GT10, GT12 WS32MG (TiCN)
titanium	short life	high cutting temperature	GT14, GT16 WN35MG (TiN-DLC)

Taps

Thread Mills

	vibration marks	major crest wear	edge chipping	cone shaped thread	entry marks
cutting speed	check	reduce	–	–	–
feed per tooth	check	increase	reduce	–	–
workpiece clamping	improve	improve	improve	–	improve
machine tool stability	improve	improve	improve	–	improve
cantilever arm	shorten	shorten	–	–	shorten
helix angle	increase	reduce	–	–	–
radial runout	check	check	–	–	–
coating	–	improve	improve	–	–
milling operation	–	climb mill	climb mill	climb mill	–
line feed/ entry ramp	check	check	–	–	improve
coolant pressure	–	check (>20 bar, 290 psi)	check (>20 bar, 290 psi)	–	–



Tap Custom-Order Worksheet

Use this Custom-Order Worksheet to modify an existing product to meet your specifications. If your custom requirements do not fall into these categories, simply contact your Kennametal Distributor.

Trust our experienced distributors and Kennametal engineering team to design the best solution for you.

1. Start with the standard product most similar to your specifications:

catalogue number

grade/coating

2. Type of tap needed:

- solid carbide high performance HSS general purpose spiral point
 hand forming spiral flute
 _____ pipe (and style) _____ other

3. Direction of cut (circle one):

left hand

right hand

4. Material overview:

- ANSI DIN JIS other

5. Desired dimension:

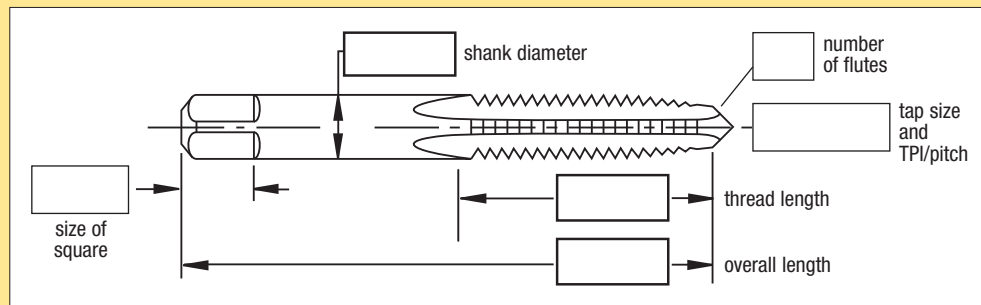

6. Choose one:

through hole:

hole diameter _____
hole depth _____

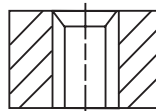

blind hole:

hole diameter _____
hole depth _____

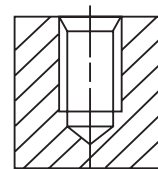

7. Chamfer:

- taper: 7-10 pitch plug: 3-5 pitch semi-bottom: 2-3 pitch bottom: 1-2 pitch



8. Class of fit:

H limit

metric D limit

diameter pitch limit

9. Workpiece material:

10. Hardness:

11. Number of taps required:

12. Price

Contact your Authorised Kennametal Distributor partners.

13. Other comments or special characteristics:

customer company name	date
address	phone number
city, state, zip	fax number
customer contact	customer email address
sales representative	

Taps

Application Sheet for Thread Milling

Test form thread data:		Date:			
Customer Data					
Company:		Department:			
Street:		Position:			
Postal code:		Telephone:			
City:		Fax:			
Country:		E-mail:			
Tool Data					
Engaged Kennametal tool:		Tool life:			
Competitive tool:					
Workpiece Data					
Thread size:		Name of workpiece:			
Class of fit:		Picture, sketch...			
Thread depth: mm					
Thread type: <input type="checkbox"/> Through hole <input type="checkbox"/> Blind hole					
Drill hole ϕ : mm					
Depth of drill hole: mm					
Type of drilled hole: <input type="checkbox"/> Drilled <input type="checkbox"/> No hole					
Material:					
Hardness:					
Machine Data					
Manufacturer:				Description:	
CNC-machine type: <input type="checkbox"/> Turning machine <input type="checkbox"/> Milling machine		Working direction: <input type="checkbox"/> Horizontal <input type="checkbox"/> Vertical			
Control type: <input type="checkbox"/> DIN <input type="checkbox"/> Heidenhain		Coolant: <input type="checkbox"/> Emulsion <input type="checkbox"/> MQL <input type="checkbox"/> Compressed air <input type="checkbox"/> Dry			
Coolant supply type: <input type="checkbox"/> Internal <input type="checkbox"/> External		Coolant pressure: <input type="checkbox"/> Bar			
Revolutions max: <input type="checkbox"/> 1/min		Spindle power: kW			
Clamping device: <input type="checkbox"/> Weldon® <input type="checkbox"/> Collet <input type="checkbox"/> Shrinking <input type="checkbox"/> Hydraulic expansion					
Cutting Conditions					
Cutting speed v_c : m/min		Revolutions: 1/min			
Feed f_z : mm/tooth		Programmed feed: mm/min			
Milling direction <input type="checkbox"/> Climb milling <input type="checkbox"/> Down milling		Type of feed: <input type="checkbox"/> Feed on contour <input type="checkbox"/> Feed on center			
Allocated cut over depth of thread: <input type="checkbox"/> Yes <input type="checkbox"/> No		Allocated cut over profile: <input type="checkbox"/> By depth of profile <input type="checkbox"/> By thread depth			
Number of cuts:		Number of cuts:			



Knowing the hardness of the work material to be tapped is essential in selecting the best tap for the job.

10 mm/min ball 3000 kg	120° cone 150 kg	1/16" ball 100 kg	model C	1000 lb per sq. in.	10 mm/min ball 3000 kg	120° cone 150 kg	1/16" ball 100 kg	model C	1000 lb per sq. in.
Brinell	Rockwell C	Rockwell B	Shore Scleroscope	tensile strength	Brinell	Rockwell C	Rockwell B	Shore Scleroscope	tensile strength
800	72	—	100	—	276	30	105	42	136
780	71	—	99	—	269	29	104	41	132
760	70	—	98	—	261	28	103	40	129
745	68	—	97	367	258	27	102	39	127
725	67	—	96	357	255	26	102	39	125
712	66	—	95	350	249	25	101	38	123
682	65	—	93	337	245	24	100	37	119
668	64	—	91	326	240	23	99	36	117
652	63	—	89	318	237	23	99	35	115
626	62	—	87	306	229	22	98	34	113
614	61	—	85	299	224	21	97	33	110
601	60	—	83	292	217	20	96	33	107
590	59	—	81	290	211	19	95	32	104
576	57	—	79	281	206	18	94	32	102
552	56	—	76	270	203	17	94	31	100
545	55	—	75	268	200	16	93	31	98
529	54	—	74	259	196	15	92	30	96
514	53	120	72	254	191	14	92	30	94
502	52	119	70	247	187	13	91	29	92
495	51	119	69	244	185	12	91	29	91
477	49	118	67	233	183	11	90	28	90
461	48	117	66	227	180	10	89	28	89
451	47	117	65	223	175	9	88	27	86
444	46	116	64	219	170	7	87	27	84
427	46	115	62	209	167	6	87	27	82
415	44	115	60	204	165	5	86	26	81
401	43	114	58	196	163	4	85	26	80
388	42	114	57	191	160	3	84	25	78
375	41	113	55	184	156	2	83	25	76
370	40	112	54	182	154	1	82	25	75
362	39	111	53	179	152	—	82	24	74
351	38	111	51	173	150	—	81	24	74
346	37	110	50	170	147	—	80	24	72
341	37	110	49	168	145	—	79	23	71
331	36	109	47	163	143	—	79	23	70
323	35	109	46	158	141	—	78	23	69
311	34	108	46	153	140	—	77	22	69
301	33	107	45	148	135	—	75	22	67
293	32	106	44	144	130	—	72	22	65
285	31	105	43	140	—	—	—	—	—

Taps

Application Icons

Countersinking/ Stroke Chamfering	Drilling: Flat Bottom	Drilling: Blind	Tapping: Through Hole	Tapping: Blind Hole
Tapping: Pipe Thread	HSS: High-Speed Steel	HSS-E: High-Speed Steel with Cobalt Alloy for Materials with Higher Hardness	HSS-E-PM: High-Speed Steel with Cobalt Alloy for Materials with Higher Hardness (PM = Powder Metal Steel)	HM: (Carbide)
Drilling Depth: 2x	Threading: Through Hole	Threading: Blind Hole		

Geometry Icons

Corner Style: Ball Nose	Shank: Cylindrical Plain	Shank: Cylindrical with Square	Square Shank: L = 4"	Square Shank: L = 6"
Square Shank: L = 8"	Square Shank: L = 10"	Chamfer Form A (6-8)	Chamfer Form B (3-5)	Chamfer Form: (3-4)
Chamfer Form C (2-3)	Chamfer Form D (3,5-5)	Chamfer Form E (1,5-2)	Chamfer Form: (2,5-3,5)	Chamfer Form: (4-6)
Chamfer Form: (1-2)	Tapping Helix Angle: 0°	Tapping Helix Angle: 8°	Tapping Helix Angle: 10°	Tapping Helix Angle: 15°
Tapping Helix Angle: 15°	Tapping Helix Angle: 25°	Tapping Helix Angle: 30°	Tapping Helix Angle: 42°	Tapping Helix Angle: 45°
Tapping Helix Angle: 49°				



Feature Icons

DIN Number 371	DIN Number 374	DIN Number 376	DIN Number 2174	Tapping: Through Coolant
Flood Coolant: Tapping	Coolant: Through Coolant	Through Coolant: Axial: Tapping	Class of Fit: 2B	Class of Fit: 3B
Class of Fit: 6H	Class of Fit: 6HX	Class of Fit: 2BX	Class of Fit: 3BX	American Tapered Pipe Thread for Threads with Dryseal Material
American Tapered Pipe Thread for Threads without Dryseal Material	American National Standards Institute	American Standard Straight Pipe Threads	American Standard Straight Pipe Threads Dryseal	British Standard Pipe Fitting Thread
British Standard Pipe Taper Thread	Whitworth Pipe Thread	Cylindrical Whitworth Pipe Thread	Tapered Whitworth Pipe Thread	Unified Fine Thread
Unified Coarse Thread	ISO Metric Coarse Thread	ISO Metric Fine Thread		

Taps

DIN – German Institute
for Standardisation

ANSI – American National
Standards Institute

Looking for a product that's not shown in this catalogue?
Check the Kennametal website!



Holemaking

Online product catalogue available 24/7

Visit <http://www.kennametal.com/holemaking/> to browse our electronic catalogue any time you're looking for Kennametal's best tooling solutions. It's fast, free, and always available. The online e-catalogue is updated weekly with products and solutions for milling, turning, holemaking, and tooling systems applications.