

Technical Guide For  
**Bow, Bay  
& Corner  
Windows**



## Product Features

### Styles

Double Hung, Single Hung and Cottage options.

### Standard Features

- Natural, clear Douglas Fir interior (no visible finger joints)
- 4 9/16" (116 mm) jamb construction
- LowE insulated glazing with 1/2" (13 mm) airspace
- Roto gear operator and concealed sash locks
- Extruded aluminum cladding in a variety of standard colors, primed wood or clear fir exterior
- Flexible continuous weatherstrip system
- Insect screens
- Metal handle, cover and locks

### Hardware

Multiple hardware type and finish choices are available. See the Hardware in section A for more information.

### Glazing

LowE Double, LowE Triple and StormForce™. StormForce is not available on all products.

### Simulated Divided Lites (SDL)

Ogee Profile – 3/4" (19 mm), 1 1/8" (30 mm), 2" (51 mm)

Putty Profile – 5/8" (16 mm), 7/8" (22 mm), 1 1/8" (30 mm), 2" (51 mm)

Square Profile (interior only) – 3/4" (19 mm), 7/8" (22 mm), 1 1/8" (30 mm), 2" (51 mm)

### Casing

Wood: 2" (51 mm) Brickmould, 3 1/2" (89 mm) Flat, 5 1/2" (139 mm) Flat, Adams and Williamsburg.

Metal Clad: 2" (51 mm) Brickmould, 3 1/2" (89 mm) Flat, 2" clad frame extension, Nose & Cove, Adams, Williamsburg and Kerf.

### Metal Clad Color Spectrum

All Palette colors, including anodized finishes.

## Specifications

### Standards

Most units have been tested by an independent laboratory for air and water infiltration, structural performance, and thermal performance requirements.

### Frame & Sash

Manufactured from Coastal Douglas Fir kiln-dried lumber with frame construction designed for 4 9/16" (116 mm) jamb. All wood exterior components are factory primed unless specified as clear exterior. Minor scratches or abrasions in the wood surface or primer are not considered defects.

### Alternate Species

The entire Loewen product line is also available in optional Mahogany.

### Preservative Treated

All wood parts are dipped in approved preservative.

### Glazing

With countless glazing configurations and LowE coating options, we ensure that you can choose the perfect blend of protection and comfort.

### Insulating Glass

Double or triple glass configurations with 1/2" (13 mm) airspace.

### LowE Systems

LowE best describes the benefits of the product that incorporates glazing coatings and Argon gas. LowE systems help reduce heating and cooling costs, providing superior energy efficiency.

### Simulated Divided Lites (SDL)

Standard SDL complete with airspace grilles, where available. Grille bars are permanently applied to the interior and exterior.

### Hardware Option

Operator and sash locks are available in a variety of finishes. See section A.

### Metal Cladding

Heavy duty exterior metal cladding comprised of extruded aluminum is available in a variety of Palette colors, including anodized and Cyprium (copper and bronze cladding). Interior of window can be natural wood (unfinished) or primed. Metal clad units are supplied ready-to-install complete with integral metal nailing flange.

### Hardware

Standard awning operator detaches at the sash allowing it to open out to 90 degrees for ease of cleaning. The roto gear operator will hold the sash at any position in its operating radius. The sash is supported by concealed heavy-duty hinges. All awning units are supplied with dual sash locks for added security and tighter seal. All steel components are coated for superior corrosion protection.

### Double Weatherstrip

The combination of a continuous, flexible foam weatherstrip and a flexible automotive type bulb weatherstrip ensures maximum energy efficiency and protection against air and water infiltration.

### Screen

Screens available in bronze, linen, Tuscany brown, brushed aluminum or black aluminum frame, screened with anti-glare fiberglass cloth. Wood-framed screens and High Transparency mesh available. Optional Retractable Screen and Swinging Screen available. Swinging Screen available on Push Out models only.

### Egress

Consult local building codes for confirmation of size requirements for your area. Special egress hardware is available for Casement windows, which enables some sizes to meet egress codes, eliminating the need to go to the next larger size window. Consult your Authorized Loewen Dealer for more details.



Bow



Bay

Visit the Loewen Photo Gallery online at [www.loewen.com](http://www.loewen.com) for a large collection of Loewen product and elevation photography. Numerous custom window configuration opportunities exist – please contact your Authorized Loewen Dealer. Specifications and technical information are subject to change without notice. Imperial and metric measurements are converted accurately. However, in some cases, industry standards cause a 1 mm variance. (Example: 3/4" is shown as 19 mm for all glass measurements.) Cad Download: [www.loewen.com/architect](http://www.loewen.com/architect) | Installation Instructions: [www.loewen.com](http://www.loewen.com)

## Bow & Bay (Framed Wall) Window Sizes

			Width							
			34' Kitchen Bay			34' Bay				
Rough Opening			57 3/8 [1458]	65 1/4 [1658]	73 1/8 [1858]	94 1/8 [2390]	101 15/16 [2590]	109 13/16 [2790]	117 11/16 [2990]	
			Frame							
			54 13/16 [1393]	62 11/16 [1593]	70 9/16 [1793]	92 1/2 [2325]	99 3/8 [2525]	107 1/4 [2725]	115 1/8 [2925]	
			Projections: Framed Wall 2 X 4 = 10 9/16" (268mm) 2 X 6 = 10 9/16" (268mm)			Projections: Framed Wall 2 x 4 = 14 15/16" (380mm) 2 x 6 = 14 15/16" (380mm)				
			15 3/4 - 23 5/8 - 15 3/4 [400 - 600 - 400]	12 1/2 - 31 1/2 - 12 1/2 [400 - 800 - 400]	15 3/4 - 39 3/8 - 15 3/4 [400 - 1000 - 400]	23 5/8 - 47 1/4 - 23 5/8 [600 - 1200 - 600]	23 5/8 - 55 1/8 - 23 5/8 [600 - 1400 - 600]	23 5/8 - 63 - 23 5/8 [600 - 1600 - 600]	23 5/8 - 70 7/8 - 23 5/8 [600 - 1800 - 600]	
Wood Exterior	Metal Clad		Product Code							
36 7/8 [936]	36 3/16 [919]	35 7/16 [900]	BY3 1409	BY3 1609	BY3 1809					
40 13/16 [1036]	40 1/8 [1019]	39 3/8 [1000]	BY3 1410	BY3 1610	BY3 1810					
48 11/16 [1236]	48 [1219]	47 1/4 [1200]				BY3 2412	BY3 2612	BY3 2812	BY3 3012	
56 9/16 [1436]	55 7/8 [1419]	55 1/8 [1400]				BY3 2414	BY3 2614	BY3 2814	BY3 3014	
60 1/2 [1536]	59 13/16 [1519]	59 1/16 [1500]				BY3 2415	BY3 2615	BY3 2815	BY3 3015	
64 7/16 [1636]	63 3/4 [1619]	63 [1600]				BY3 2416	BY3 2616	BY3 2816	BY3 3016	
72 5/16 [1836]	71 5/8 [1819]	70 7/8 [1800]				BY3 2418	BY3 2618	BY3 2818	BY3 3018	

<sup>1</sup> Wood Exterior:  
Requires additional 3/4" (19mm) for optional head

Glass Size = Visible Glass + 15/16" (24 mm)

<sup>2</sup> Metal Clad:  
Requires additional 3/4" (19mm) for optional head  
Requires additional 3/4" (19mm) for optional seat

Standard sizes Shown. Additional sizes may be available. Custom sizes can be ordered.

Note: • For glass sizes, see Casement section.  
• For Masonry opening information see section A.

## Bow & Bay (Framed Wall) Window Sizes

			Width							
			45' Kitchen Bay			45' Bay				
Rough Opening			54 5/16 [1380]	62 3/16 [1580]	70 1/16 [1780]	89 1/8 [2263]	96 15/16 [2463]	104 13/16 [2663]	112 11/16 [2863]	
			Frame							
			52 3/8 [1330]	60 1/4 [1530]	68 1/8 [1730]	87 1/8 [2213]	95 [2413]	102 7/8 [2613]	110 3/4 [2813]	
			Projections: Framed Wall 2 X 4 = 10 9/16" (268mm) 2 X 6 = 10 9/16" (268mm)			Projections: Framed Wall 2 x 4 = 14 15/16" (380mm) 2 x 6 = 14 15/16" (380mm)				
			15 3/4 - 23 5/8 - 15 3/4 [400 - 600 - 400]	12 1/2 - 31 1/2 - 12 1/2 [400 - 800 - 400]	15 3/4 - 39 3/8 - 15 3/4 [400 - 1000 - 400]	23 5/8 - 47 1/4 - 23 5/8 [600 - 1200 - 600]	23 5/8 - 55 1/8 - 23 5/8 [600 - 1400 - 600]	23 5/8 - 63 - 23 5/8 [600 - 1600 - 600]	23 5/8 - 70 7/8 - 23 5/8 [600 - 1800 - 600]	
Wood Exterior	Metal Clad		Product Code							
36 7/8 [936]	36 3/16 [919]	35 7/16 [900]	BY3 1409	BY3 1609	BY3 1809					
40 13/16 [1036]	40 1/8 [1019]	39 3/8 [1000]	BY3 1410	BY3 1610	BY3 1810					
48 11/16 [1236]	48 [1219]	47 1/4 [1200]				BY3 2412	BY3 2612	BY3 2812	BY3 3012	
56 9/16 [1436]	55 7/8 [1419]	55 1/8 [1400]				BY3 2414	BY3 2614	BY3 2814	BY3 3014	
60 1/2 [1536]	59 13/16 [1519]	59 1/16 [1500]				BY3 2415	BY3 2615	BY3 2815	BY3 3015	
64 7/16 [1636]	63 3/4 [1619]	63 [1600]				BY3 2416	BY3 2616	BY3 2816	BY3 3016	
72 5/16 [1836]	71 5/8 [1819]	70 7/8 [1800]				BY3 2418	BY3 2618	BY3 2818	BY3 3018	

<sup>1</sup> Wood Exterior:  
Requires additional 3/4" (19mm) for optional head

Glass Size = Visible Glass + 15/16" (24 mm)

<sup>2</sup> Metal Clad:  
Requires additional 3/4" (19mm) for optional head  
Requires additional 3/4" (19mm) for optional seat

Standard sizes Shown. Additional sizes may be available. Custom sizes can be ordered.

Note: • For glass sizes, see Casement section.  
• For Masonry opening information see section A.

## Bow & Bay (Framed Wall) Window Sizes

			Width	
			10' Bow	
Rough Opening			98 7/16 [2501]	120 7/8 [3071]
			Frame	
			Projections: Framed Wall 2 x 4 = 8 13/16" (223mm) 2 x 6 = 8 13/16" (223mm)	Projections: Framed Wall 2 x 4 = 13 1/16" (332mm) 2 x 6 = 13 1/16" (332mm)
			23 5/8 - 23 5/8 - 23 5/8 - 23 5/8 [600 - 600 - 600 - 600]	23 5/8 - 23 5/8 - 23 5/8 - 23 5/8 [600 - 600 - 600 - 600]
Wood Exterior	Metal Clad		Product Code	
36 7/8 [936]	36 3/16 [919]	35 7/16 [900]	BY4 2409	BY5 3009
40 13/16 [1036]	40 1/8 [1019]	39 3/8 [1000]	BY4 2410	BY5 3010
48 11/16 [1236]	48 [1219]	47 1/4 [1200]	BY4 2412	BY5 3012
56 9/16 [1436]	55 7/8 [1419]	55 1/8 [1400]	BY4 2414	BY5 3014
60 1/2 [1536]	59 13/16 [1519]	59 1/16 [1500]	BY4 2415	BY5 3015
64 7/16 [1636]	63 3/4 [1619]	63 [1600]	BY4 2416	BY5 3016
72 5/16 [1836]	71 5/8 [1819]	70 7/8 [1800]	BY4 2418	BY5 3018

<sup>1</sup> Wood Exterior:  
Requires additional 3/4" (19mm) for optional head

<sup>2</sup> Metal Clad:  
Requires additional 3/4" (19mm) for optional head  
Requires additional 3/4" (19mm) for optional seat

Glass Size = Visible Glass + 15/16" (24 mm)

Standard sizes shown. Additional sizes may be available. Custom sizes can be ordered.

Note: • For glass sizes, see Casement section.  
• For Masonry opening information see section A.

## Bow & Bay (Framed Wall) Window Detail

### Framed Wall Bay Construction Detail

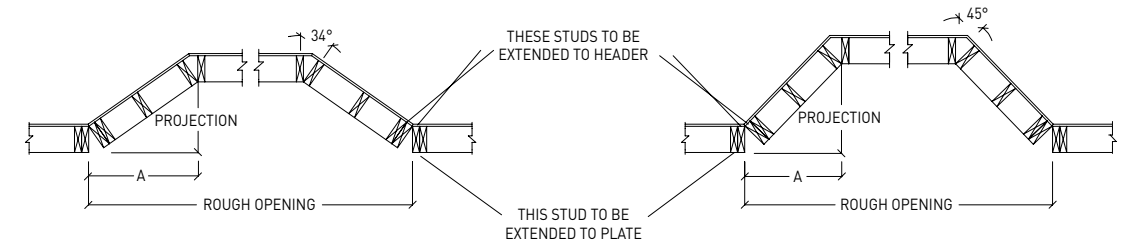

#### 34° Framing Measurements – 23 5/8" (600 mm) Flankers

DESCRIPTION	4 9/16" (116 mm) JAMB		6 9/16" (166 mm) JAMB	
	in.	mm	in.	mm
A MEASUREMENT	23 1/4"	591	23 7/8"	606
PROJECTION	14 15/16"	380	14 15/16"	380

#### 45° Framing Measurements – 23 5/8" (600 mm) Flankers

DESCRIPTION	4 9/16" (116 mm) JAMB		6 9/16" (166 mm) JAMB	
	in.	mm	in.	mm
A MEASUREMENT	20 11/16"	526	21 9/16"	547
PROJECTION	19 3/16"	488	19 3/16"	488

Note: • Framed Wall Bay windows are supplied without head and seat.

### Framed Wall Bow Construction Detail

#### Four Section Bow Window

##### Framing Measurements for Standard 23 5/8" (600 mm) Units

DESCRIPTION	4 9/16" (116 mm) JAMB		6 9/16" (166 mm) JAMB	
	in.	mm	in.	mm
ROUGH OPENING WIDTH	98 7/16"	2500	98 7/16"	2500
HEADER LENGTH	101 7/16"	2576	101 7/16"	2576
A MEASUREMENT	25 5/8"	651	25 15/16"	659
B MEASUREMENT	6 3/4"	171	6 3/4"	172
C MEASUREMENT	49 3/16"	1250	49 3/16"	1250
D MEASUREMENT	8 13/16"	224	8 3/4"	223

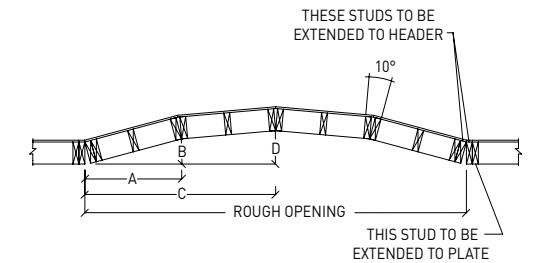

#### Five Section Bow Window

##### Framing Measurements for Standard 23 5/8" (600 mm) Units

DESCRIPTION	4 9/16" (116 mm) JAMB		6 9/16" (166 mm) JAMB	
	in.	mm	in.	mm
ROUGH OPENING WIDTH	120 13/16"	3069	120 13/16"	3069
HEADER LENGTH	123 13/16"	3145	123 13/16"	3145
A MEASUREMENT	25 1/4"	641	25 3/4"	654
B MEASUREMENT	8 15/16"	227	9"	229
C MEASUREMENT	48 9/16"	1234	48 3/4"	1238
D MEASUREMENT	13 1/16"	332	13 1/16"	332

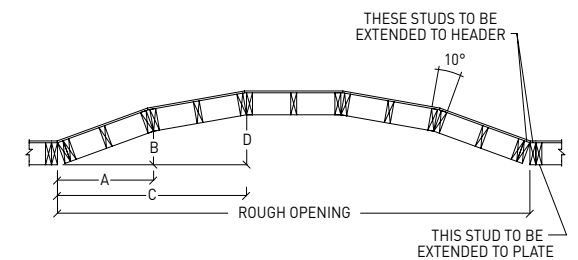

Note: • Other jamb widths available.  
• All dimensions to have +/- 1/16" (2mm) tolerance.

# 34° Framed Wall Bay Window Detail

## Plan View

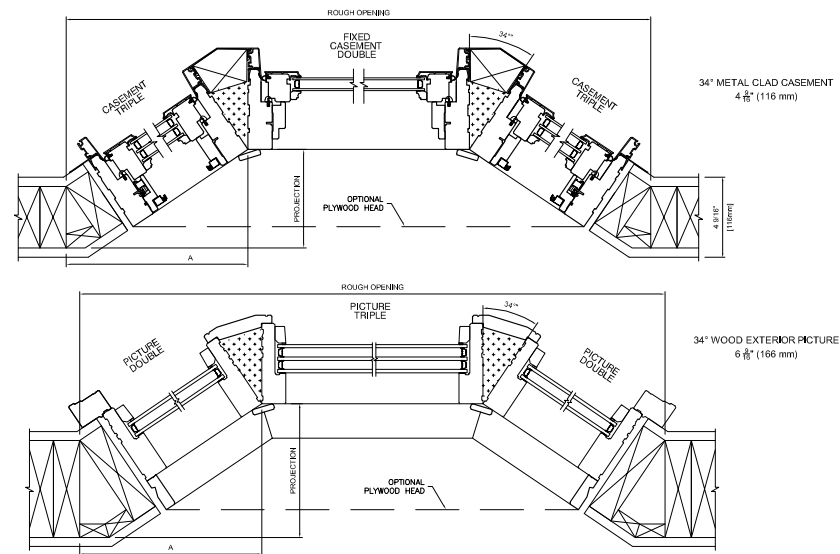

Note: • For projection dimensions, refer to Framed Wall Bow elevations.

# 45° Framed Wall Bay Window Detail

## Plan View

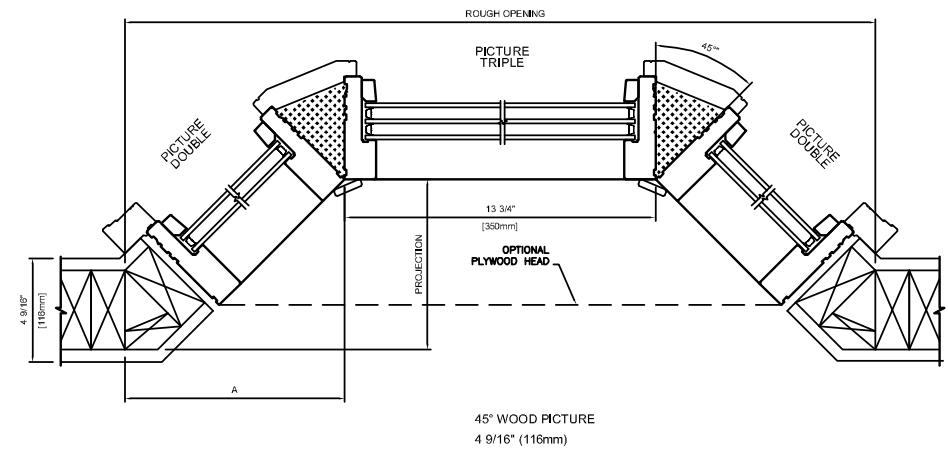
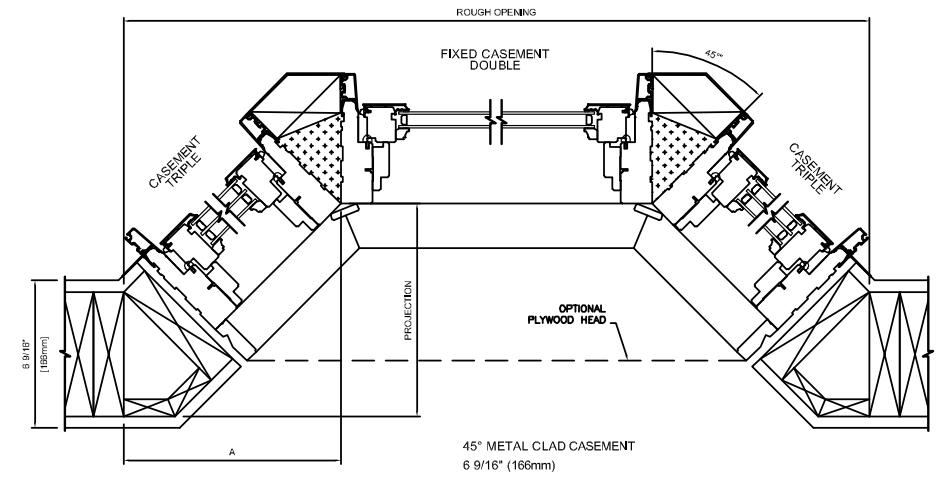

## Plan View

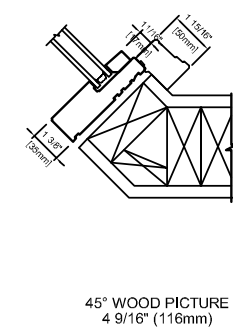
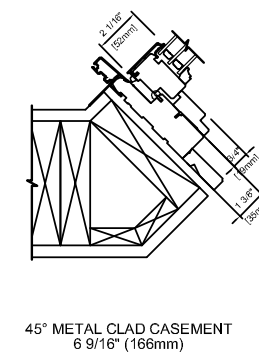

Note: • Other jamb widths available.  
• All dimensions to have +/- 1/16" (2mm) tolerance.

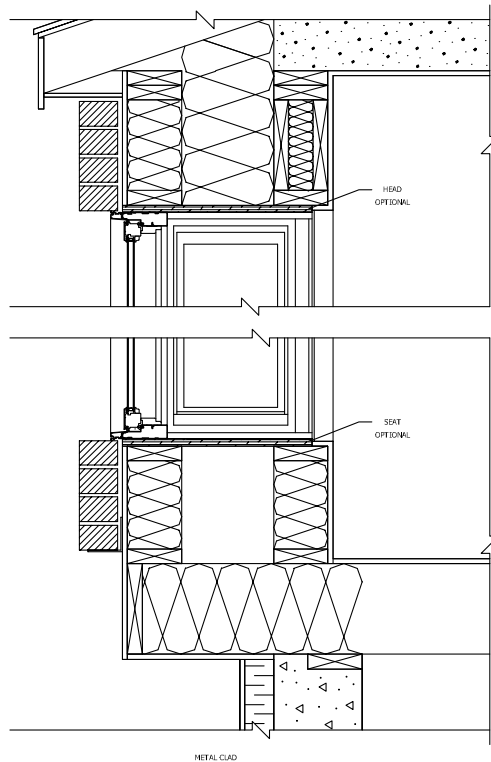

## Plan View

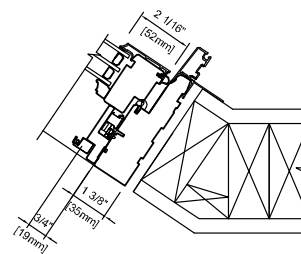

FRAMED WALL METAL CLAD CASEMENT  
4 9/16" (116 mm) JAMB

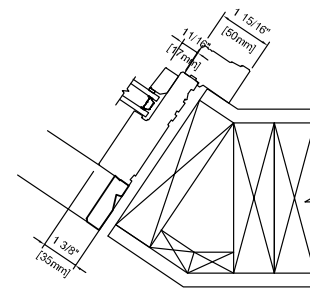

FRAMED WALL WOOD PICTURE  
6 9/16" (166 mm) JAMB

Note: • Other jamb widths available.  
• All dimensions to have +/- 1/16" (2mm) tolerance.

# 10° Framed Wall Bow Window Detail

## Plan View

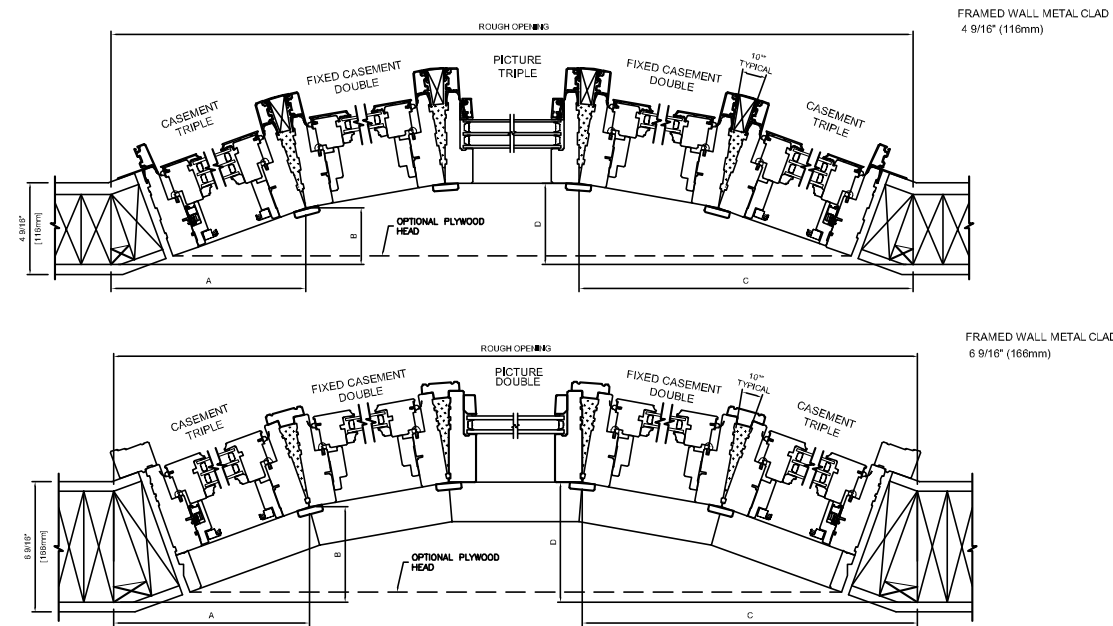

**Note:**

- Also available in a four-wide unit.
- For projection dimensions, refer to Framed Wall Bow elevation

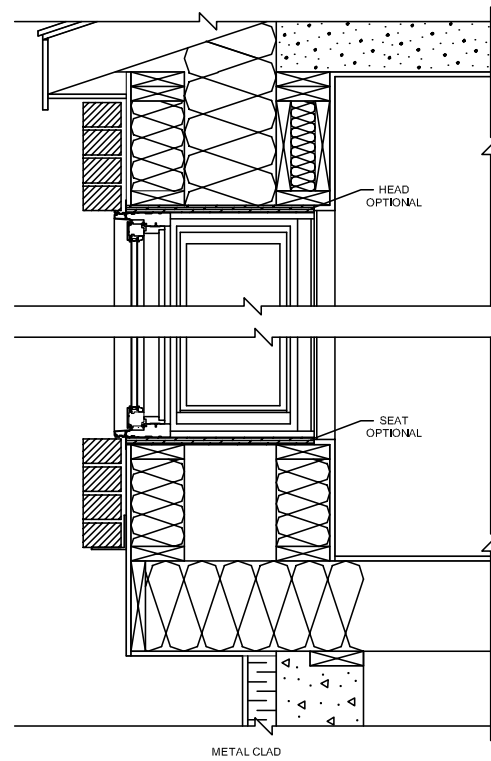

## Plan View

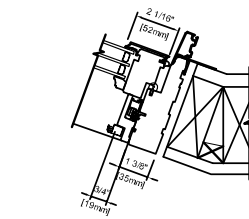

FRAMED WALL METAL CLAD CASEMENT  
4 9/16" (116 mm) JAMB

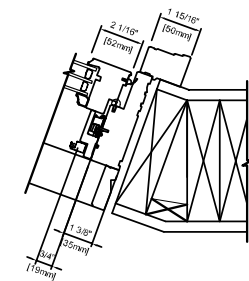

FRAMED WALL WOOD CASEMENT  
6 9/16" (166 mm) JAMB

**Note:**

- Other jamb widths available.
- All dimensions to have +/- 1/16" (2mm) tolerance.

# Bow & Bay (Straight Wall) Window Sizes

			Width						
			34' Kitchen Bay		34' Bay				
<b>Rough Opening</b>			54 1/2 [1384]	62 3/8 [1589]	70 1/4 [1784]	91 3/16 [2316]	99 1/16 [2516]	106 15/16 [2716]	114 13/16 [2916]
	<b>Frame</b>		54 13/16 [1393]	62 11/16 [1593]	70 9/16 [1793]	91 1/2 [2325]	99 3/8 [2525]	107 1/4 [2725]	115 1/8 [2925]
		Projections: Straight Wall 2 x 4 = 9 13/16" (250mm) 2 x 6 = 11 13/16" (300mm)			Projections: Straight Wall 2 x 4 = 14 1/4" (362mm) 2 x 6 = 16 1/4" (412mm)				
<b>Wood Exterior</b>	<b>Metal Clad</b>		15 3/4 - 23 5/8 - 15 3/4 [400 - 600 - 400]	12 1/2 - 31 1/2 - 12 1/2 [400 - 800 - 400]	15 3/4 - 39 3/8 - 15 3/4 [400 - 1000 - 400]	23 5/8 - 47 1/4 - 23 5/8 [600 - 1200 - 600]	23 5/8 - 55 1/8 - 23 5/8 [600 - 1400 - 600]	23 5/8 - 63 - 23 5/8 [600 - 1600 - 600]	23 5/8 - 70 7/8 - 23 5/8 [600 - 1800 - 600]
36 7/8 [936]	36 3/16 [919]	35 7/16 [900]	BY3 1409	BY3 1609	BY3 1809				
40 13/16 [1036]	40 1/8 [1019]	39 3/8 [1000]	BY3 1410	BY3 1610	BY3 1810				
48 11/16 [1236]	48 [1219]	47 1/4 [1200]				BY3 2412	BY3 2612	BY3 2812	BY3 3012
56 9/16 [1436]	55 7/8 [1419]	55 1/8 [1400]				BY3 2414	BY3 2614	BY3 2814	BY3 3014
60 1/2 [1536]	59 13/16 [1519]	59 1/16 [1500]				BY3 2415	BY3 2615	BY3 2815	BY3 3015
64 7/16 [1636]	63 3/4 [1619]	63 [1600]				BY3 2416	BY3 2616	BY3 2816	BY3 3016
72 5/16 [1836]	71 5/8 [1819]	70 7/8 [1800]				BY3 2418	BY3 2618	BY3 2818	BY3 3018

Height

**Product Code**

<sup>1</sup> Wood Exterior:  
Requires additional 3/4" (19mm) for optional head

Glass Size = Visible Glass + 15/16" (24 mm)

<sup>2</sup> Metal Clad:  
Requires additional 3/4" (19mm) for optional head  
Requires additional 3/4" (19mm) for optional seat

**Standard sizes Shown. Additional sizes may be available. Custom sizes can be ordered.**

**Note:** • For glass sizes, see Casement section.

## Bow & Bay (Straight Wall) Window Sizes

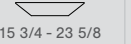
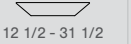
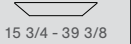
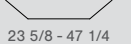
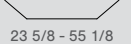
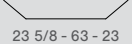
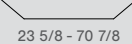
			Width							
			45° Kitchen Bay			45° Bay				
Rough Opening			51 1/8 [1298]	59 [1498]	66 7/8 [1698]	85 7/8 [2181]	93 3/4 [2381]	101 5/8 [2581]	109 1/2 [2781]	
	Frame		52 3/8 [1330]	60 1/4 [1530]	68 1/8 [1730]	87 1/8 [2213]	95 [2413]	102 7/8 [2613]	110 3/4 [2813]	
			Projections: Straight Wall 2 x 4 = 12 15/16" (329mm) 2 x 6 = 14 15/16" (379mm)			Projections: Straight Wall 2 x 4 = 18 1/2" (470mm) 2 x 6 = 20 1/2" (520mm)				
										
Wood Exterior	Metal Clad	15 3/4 - 23 5/8 - 15 3/4 [400 - 600 - 400]	12 1/2 - 31 1/2 - 12 1/2 [400 - 800 - 400]	15 3/4 - 39 3/8 - 15 3/4 [400 - 1000 - 400]	23 5/8 - 47 1/4 - 23 5/8 [600 - 1200 - 600]	23 5/8 - 55 1/8 - 23 5/8 [600 - 1400 - 600]	23 5/8 - 63 - 23 5/8 [600 - 1600 - 600]	23 5/8 - 70 7/8 - 23 5/8 [600 - 1800 - 600]		
			Product Code							
36 7/8 [936]	36 3/16 [919]	35 7/16 [900]	BY3 1409	BY3 1609	BY3 1809					
40 13/16 [1036]	40 1/8 [1019]	39 3/8 [1000]	BY3 1410	BY3 1610	BY3 1810					
48 11/16 [1236]	48 [1219]	47 1/4 [1200]				BY3 2412	BY3 2612	BY3 2812	BY3 3012	
56 9/16 [1436]	55 7/8 [1419]	55 1/8 [1400]				BY3 2414	BY3 2614	BY3 2814	BY3 3014	
60 1/2 [1536]	59 13/16 [1519]	59 1/16 [1500]				BY3 2415	BY3 2615	BY3 2815	BY3 3015	
64 7/16 [1636]	63 3/4 [1619]	63 [1600]				BY3 2416	BY3 2616	BY3 2816	BY3 3016	
72 5/16 [1836]	71 5/8 [1819]	70 7/8 [1800]				BY3 2418	BY3 2618	BY3 2818	BY3 3018	

<sup>1</sup> Wood Exterior:  
Requires additional 3/4" (19mm) for optional head



Glass Size = Visible Glass + 15/16" (24 mm)

<sup>2</sup> Metal Clad:  
Requires additional 3/4" (19mm) for optional head  
Requires additional 3/4" (19mm) for optional seat

Standard sizes Shown. Additional sizes may be available. Custom sizes can be ordered.

Note: • For glass sizes, see Casement section.  
• For Masonry opening information see section A.

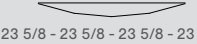
## Bow & Bay (Straight Wall) Window Sizes

			Width				
			10° Bow				
Rough Opening			95 [2414]	118 [2997]			
	Frame		94 1/2 [2401]	117 11/16 [2989]			
			Projections: Straight Wall 2 x 4 = 8 3/16" (208mm) 2 x 6 = 10 33/16" (258mm)		Projections: Straight Wall 2 x 4 = 12 7/16" (316mm) 2 x 6 = 14 7/16" (366mm)		
							
Wood Exterior	Metal Clad	23 5/8 - 23 5/8 - 23 5/8 - 23 5/8 [600 - 600 - 600 - 600]	23 5/8 - 23 5/8 - 23 5/8 - 23 5/8 [600 - 600 - 600 - 600]				
			Product Code				
36 7/8 [936]	36 3/16 [919]	35 7/16 [900]	BY4 2409		BY5 3009		
40 13/16 [1036]	40 1/8 [1019]	39 3/8 [1000]	BY4 2410		BY5 3010		
48 11/16 [1236]	48 [1219]	47 1/4 [1200]	BY4 2412		BY5 3012		
56 9/16 [1436]	55 7/8 [1419]	55 1/8 [1400]	BY4 2414		BY5 3014		
60 1/2 [1536]	59 13/16 [1519]	59 1/16 [1500]	BY4 2415		BY5 3015		
64 7/16 [1636]	63 3/4 [1619]	63 [1600]	BY4 2416		BY5 3016		
72 5/16 [1836]	71 5/8 [1819]	70 7/8 [1800]	BY4 2418		BY5 3018		

<sup>1</sup> Wood Exterior:  
Requires additional 3/4" (19mm) for optional head

Glass Size = Visible Glass + 15/16" (24 mm)

<sup>2</sup> Metal Clad:  
Requires additional 3/4" (19mm) for optional head  
Requires additional 3/4" (19mm) for optional seat

Standard sizes Shown. Additional sizes may be available. Custom sizes can be ordered.

Note: • For glass sizes, see Casement section.  
• For Masonry opening information see section A.

# Bow & Bay (Straight Wall) Window Detail

## Straight Wall Bay Construction Details

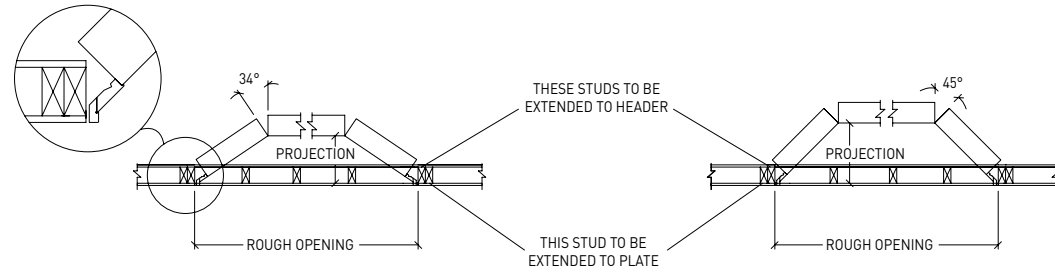

34° Framing Measurements – 15 3/4" (400 mm) Flankers				
DESCRIPTION	4 9/16" (116 mm) JAMB		6 9/16" (166 mm) JAMB	
	in.	mm	in.	mm
PROJECTION	9 13/16"	250	11 13/16"	300

45° Framing Measurements – 15 3/4" (400 mm) Flankers				
DESCRIPTION	4 9/16" (116 mm) JAMB		6 9/16" (166 mm) JAMB	
	in.	mm	in.	mm
PROJECTION	12 15/16"	329	14 15/16"	379

34° Framing Measurements – 23 5/8" (600 mm) Flankers				
DESCRIPTION	in.	mm	in.	mm
PROJECTION	14 1/4"	326	16 1/4"	412

45° Framing Measurements – 23 5/8" (600 mm) Flankers				
DESCRIPTION	in.	mm	in.	mm
PROJECTION	18 1/2"	470	20 1/2"	520

Note: • Kitchen and straight wall Bay windows are supplied with a 3/4" (19 mm) head and seat.

## Straight Wall Bow Construction Details

### Four Section Bow Window

Framing Measurements For Standard 23 5/8" (600 mm) Units				
DESCRIPTION	4 9/16" (116 mm) JAMB		6 9/16" (166 mm) JAMB	
	in.	mm	in.	mm
ROUGH OPENING WIDTH	95 9/16"	2428	95 9/16"	2428
HEADER LENGTH	98 9/16"	2504	98 9/16"	2504
A MEASUREMENT	24 1/4"	616	24 1/4"	616
B MEASUREMENT	6 1/8"	155	8 1/16"	205
C MEASUREMENT	47 3/4"	1214	47 3/4"	1214
D MEASUREMENT	8 3/16"	208	10 3/16"	258

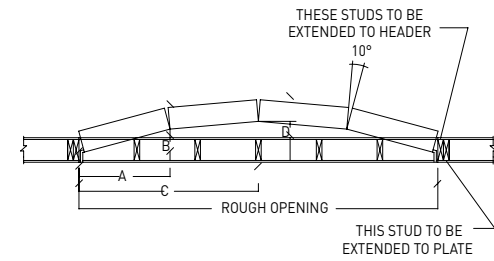

### Five Section Bow Window

Framing Measurements For Standard 23 5/8" (600 mm) Units				
DESCRIPTION	4 9/16" (116 mm) JAMB		6 9/16" (166 mm) JAMB	
	in.	mm	in.	mm
ROUGH OPENING WIDTH	118"	2997	118"	2997
HEADER LENGTH	121"	3073	121"	3073
A MEASUREMENT	23 15/16"	607	23 15/16"	607
B MEASUREMENT	8 5/16"	212	10 5/16"	262
C MEASUREMENT	47 3/16"	1198	47 3/16"	1198
D MEASUREMENT	12 7/16"	316	14 7/16"	366

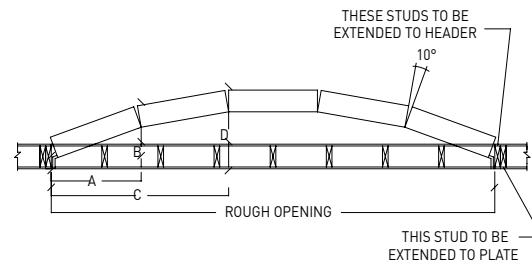

Note: • Other jamb widths available.

# 34° Straight Wall Bay Window Detail

## Plan View

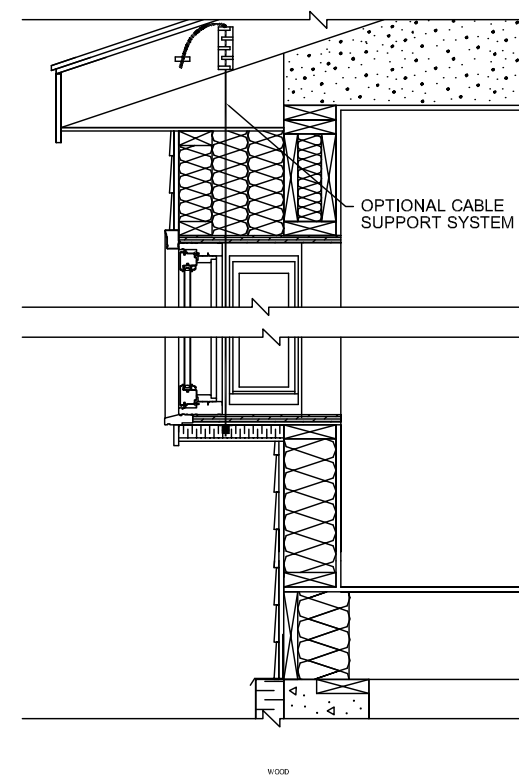
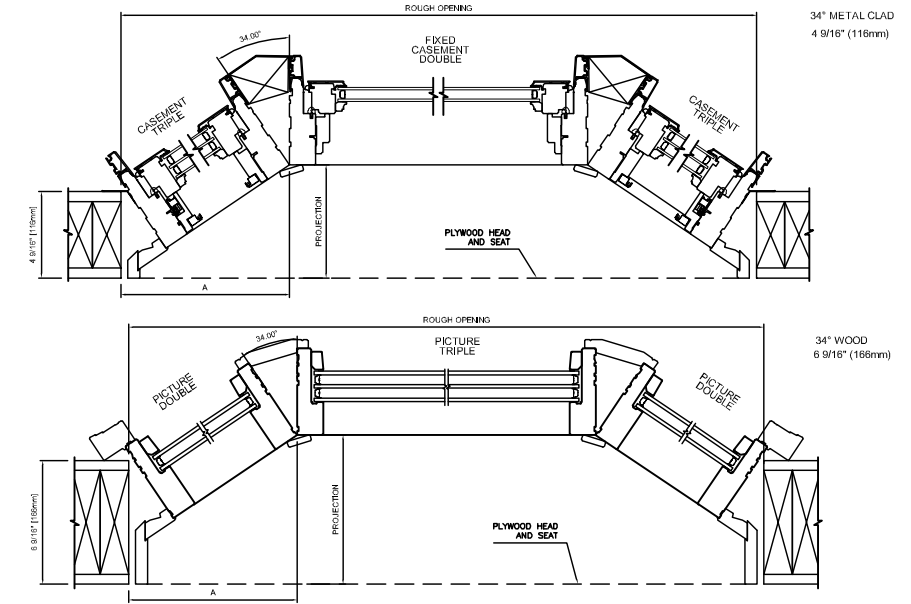

## Plan View

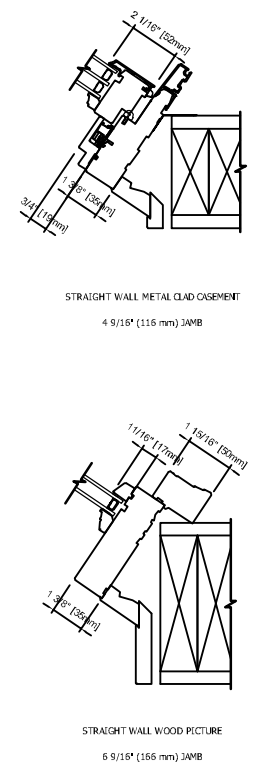

Note: • Other jamb widths available.  
• All dimensions to have +/- 1/16" (2mm) tolerance.



# 45° Straight Wall Bay Window Detail

## Plan View

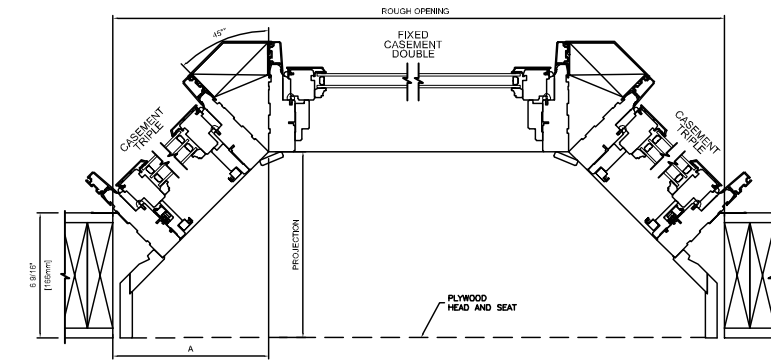

45° METAL CLAD CASEMENT  
6 9/16" (166mm)

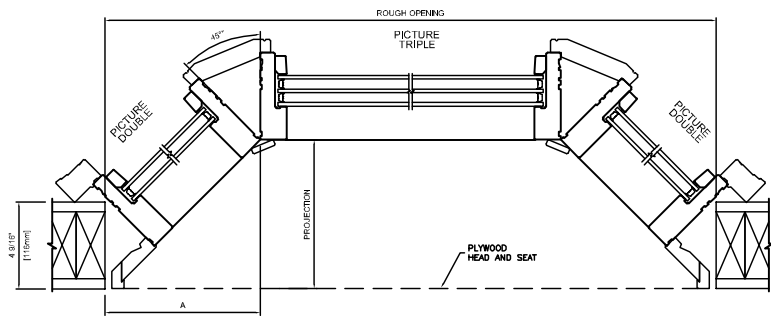

45° WOOD PICTURE  
4 9/16" (116mm)

## Plan View

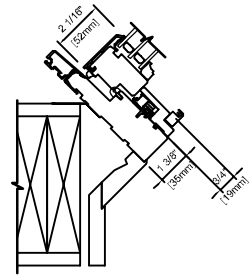

45° METAL CLAD CASEMENT  
6 9/16" (166mm)

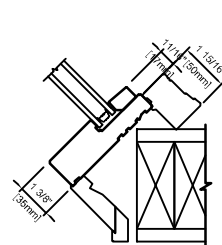

45° WOOD PICTURE  
4 9/16" (116mm)

Note: • Other jamb widths available.  
• All dimensions to have +/- 1/16" (2mm) tolerance.

# 10° Straight Wall Bow Window Detail

## Plan View

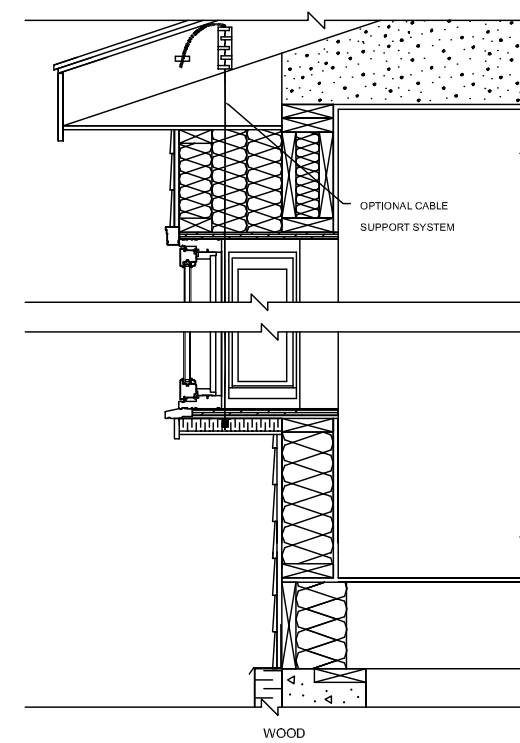
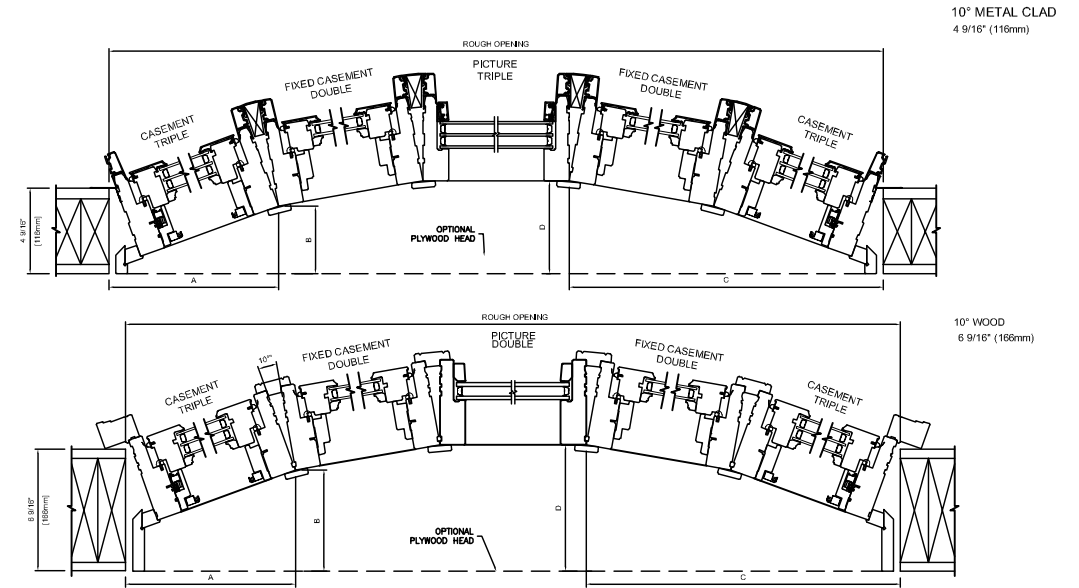

## Plan View

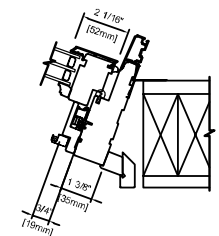

STRAIGHT WALL METAL CLAD CASEMENT  
4 9/16" (116 mm) JAMB

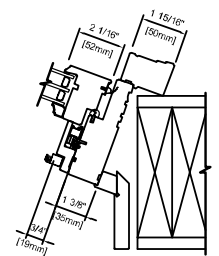

STRAIGHT WALL WOOD CASEMENT  
6 9/16" (166 mm) JAMB

Note: • Other jamb widths available.  
• All dimensions to have +/- 1/16" (2mm) tolerance.

## Picture/Direct Set Corner Window Detail

### Head & Sill Detail

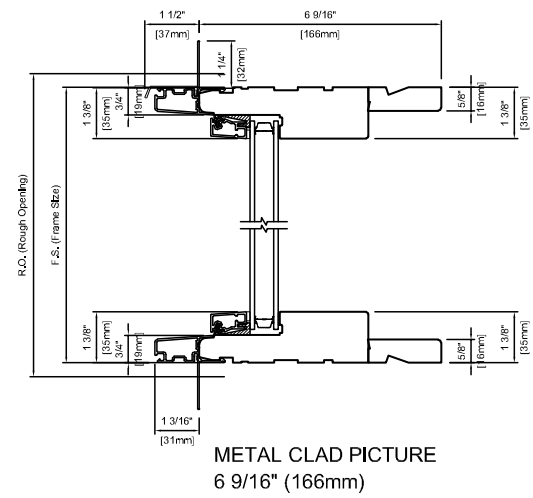

Note: • CUDSP = Corner Unit Direct Set Post

### Plan View

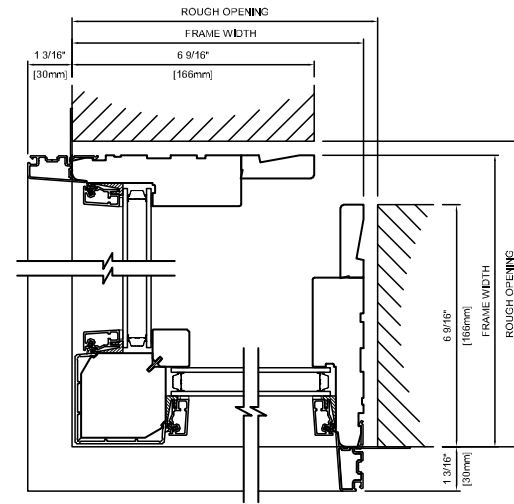

## Casement Corner Window Detail

### Head & Sill Detail

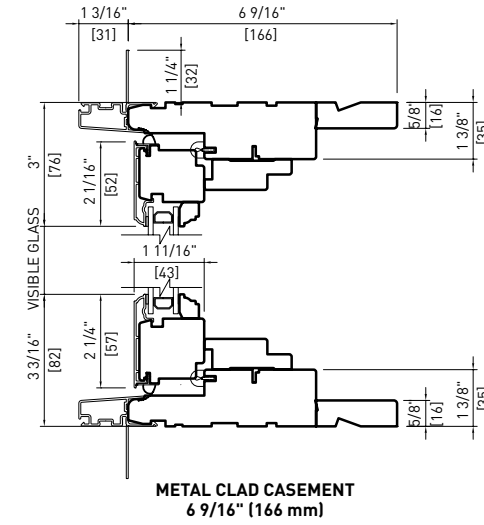

Note: • CUMCS = Corner Unit Mitred Casement Sash.

### Plan View

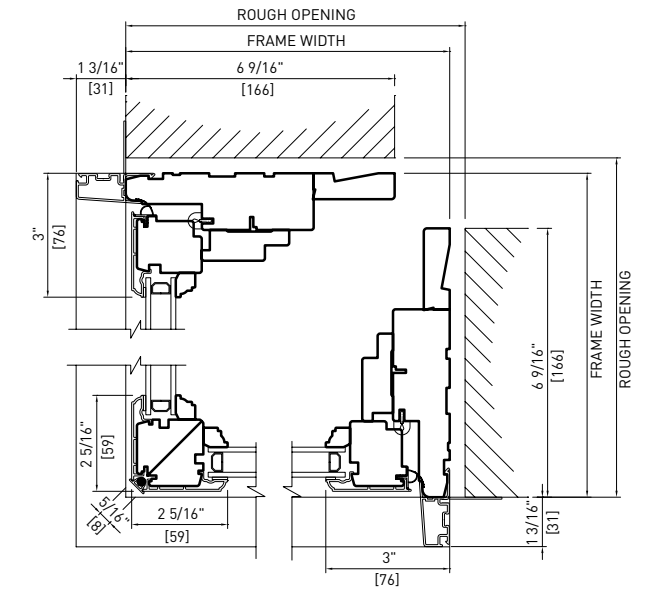

### Head & Sill Detail

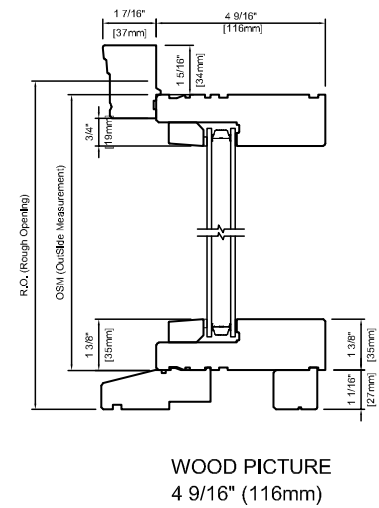

Note: • Other jamb widths available.  
• All dimensions to have +/- 1/16" (2mm) tolerance.

### Plan View

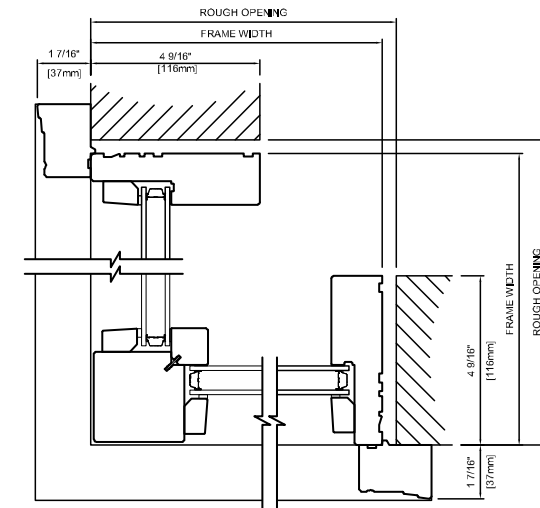

### Head & Sill Detail

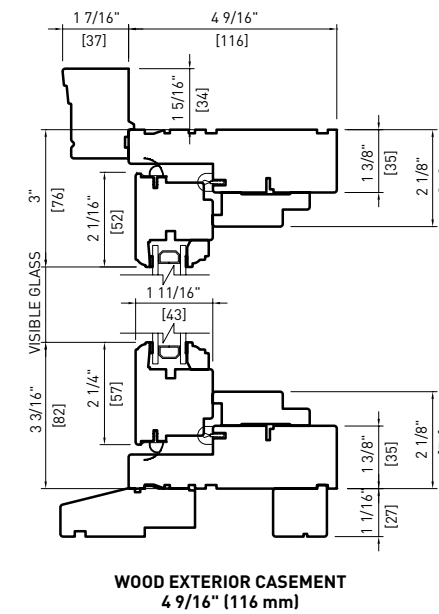

Note: • Other jamb widths available.  
• All dimensions to have +/- 1/16" (2mm) tolerance.

### Plan View

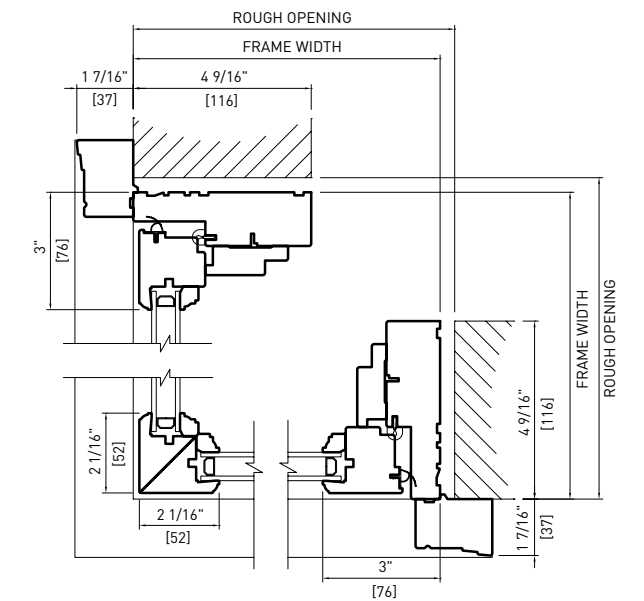

## Picture/Direct Set Corner (Butt Glazed) Window Detail

### Head & Sill Detail

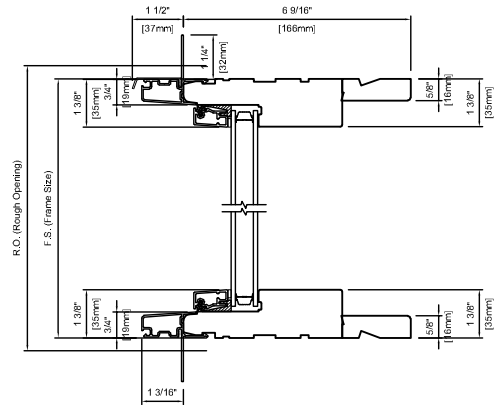

METAL CLAD PICTURE  
6 9/16" (166mm)

### Plan View

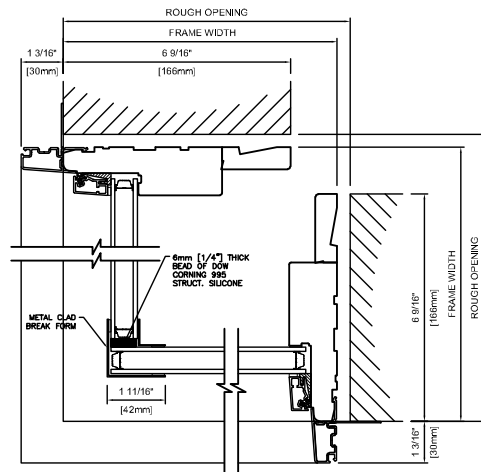

Note: • CUDSBG = Corner Unit Direct Set Butt Glazed.

## Casement Corner (Butt Glazed) Window Detail

### Head & Sill Detail

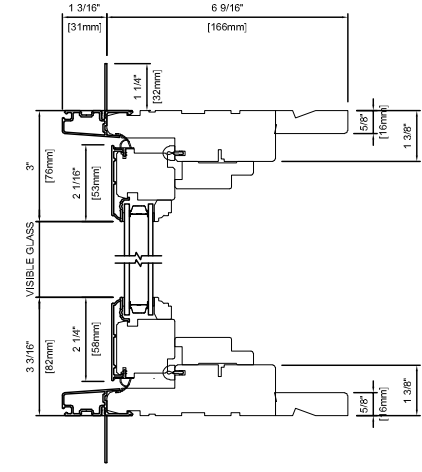

METAL CLAD CASEMENT  
6 9/16" (166mm)

Note: • CUSBG = Corner Unit Sashed Butt Glazed.

### Plan View

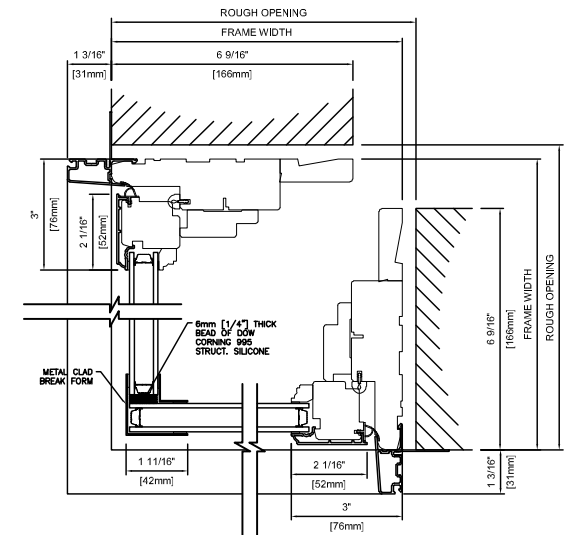

### Head & Sill Detail

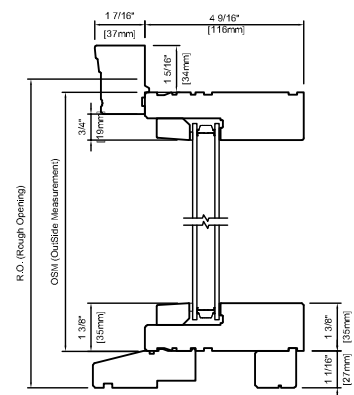

WOOD PICTURE  
4 9/16" (116mm)

### Plan View

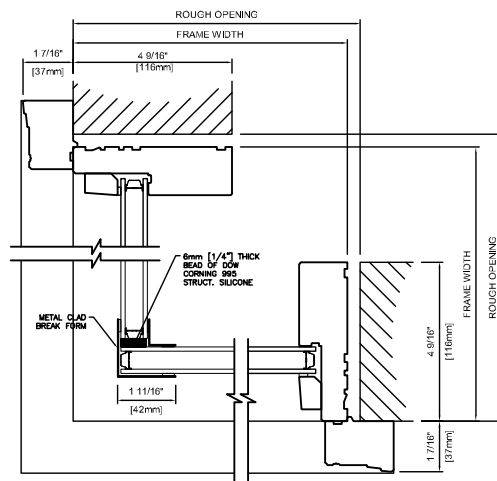

Note: • Other jamb widths available.  
• All dimensions to have +/- 1/16" (2mm) tolerance.

### Head & Sill Detail

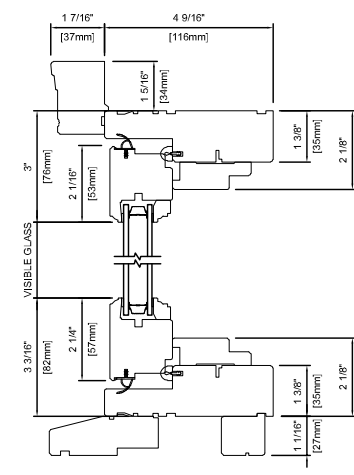

WOOD CASEMENT  
4 9/16" (116mm)

Note: • Other jamb widths available.  
• All dimensions to have +/- 1/16" (2mm) tolerance.

### Plan View

