

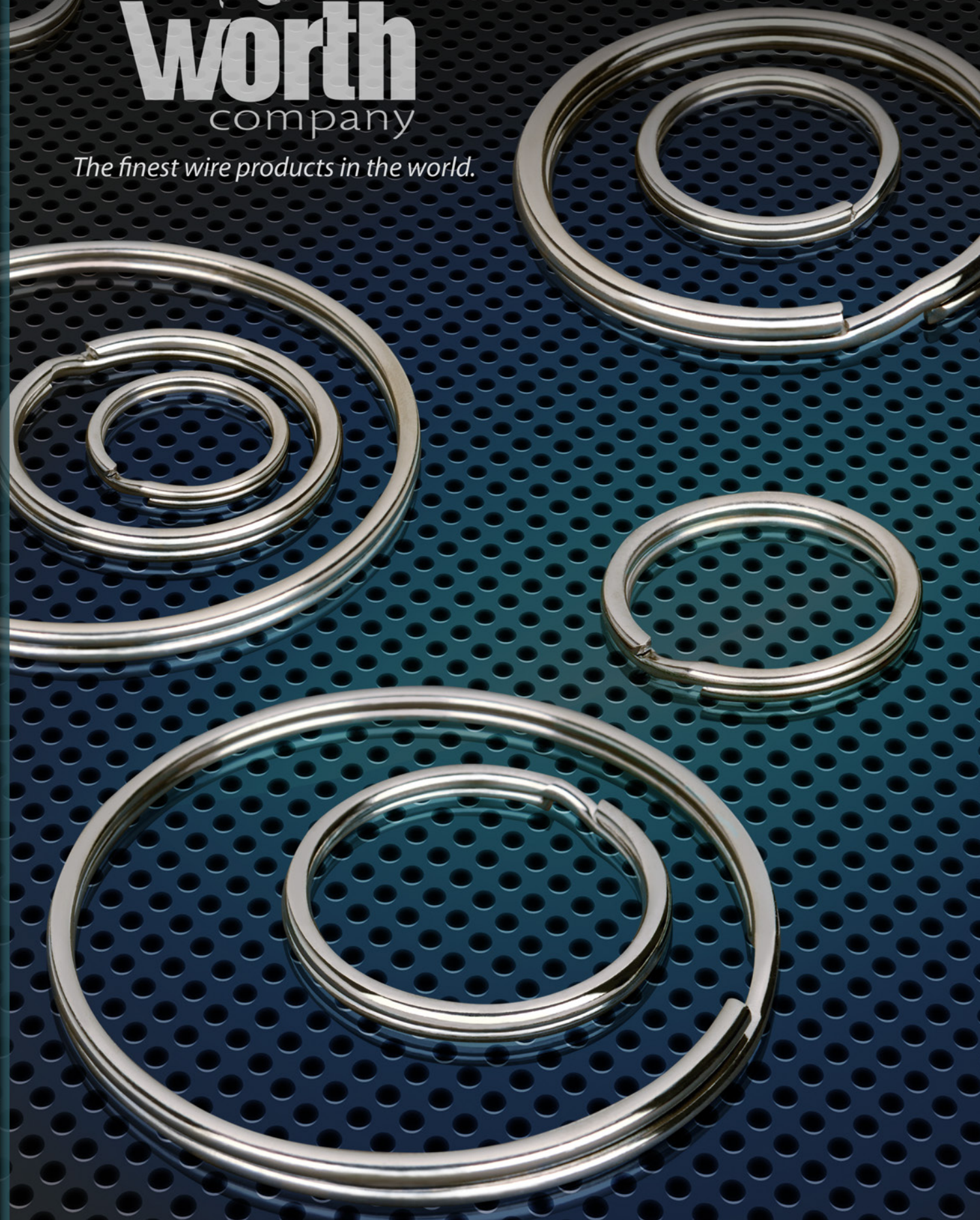

The finest wire products in the world.

KEY RINGS 2018



Standard Key Rings

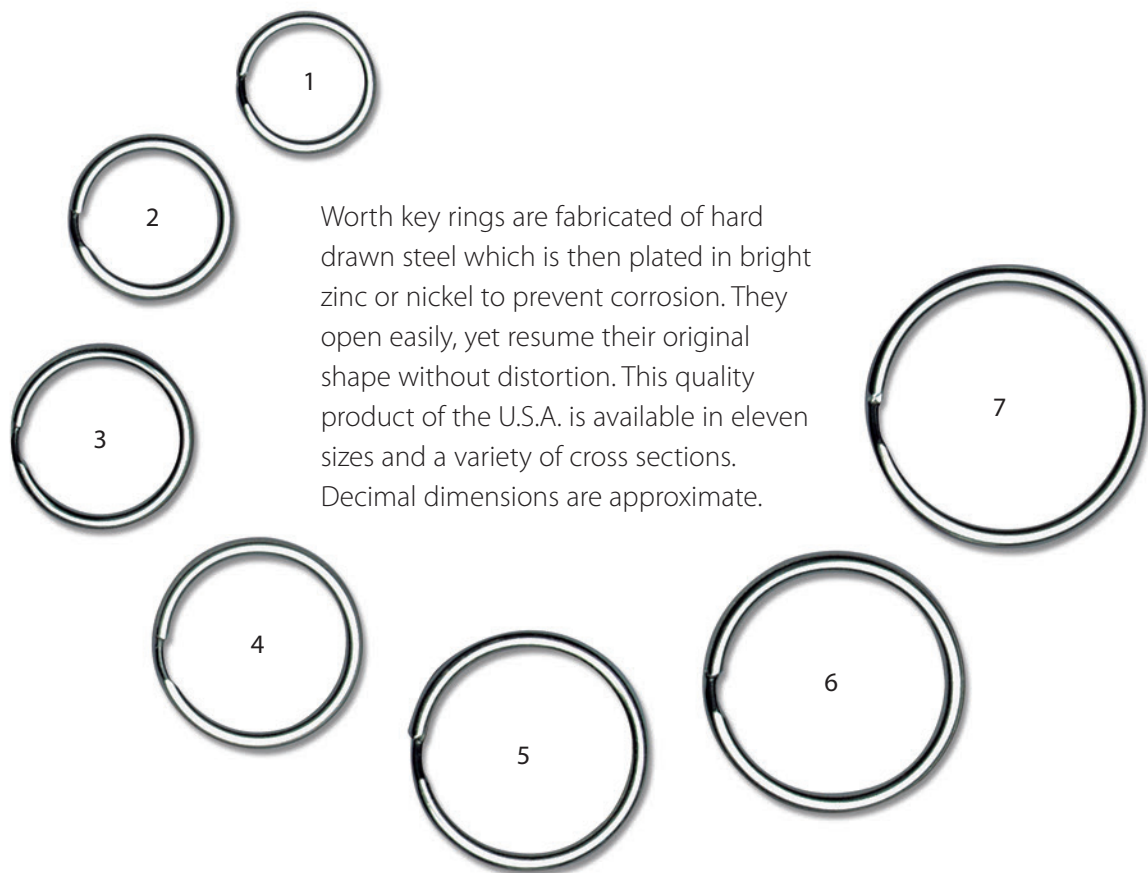

Worth key rings are fabricated of hard drawn steel which is then plated in bright zinc or nickel to prevent corrosion. They open easily, yet resume their original shape without distortion. This quality product of the U.S.A. is available in eleven sizes and a variety of cross sections. Decimal dimensions are approximate.

Standard Key Rings

Size	1	2	3	4	5	6
Outside Diameter	.740 in. 18.80 mm	.875 in. 22.23 mm	.970 in. 24.64 mm	1.100 in. 27.94 mm	1.250 in. 31.75 mm	1.375 in. 34.93 mm
Approx. Inside Diameter	.596 in. 15.14 mm	.707 in. 17.96 mm	.802 in. 20.37 mm	.932 in. 23.67 mm	1.062 in. 26.98 mm	1.159 in. 29.44 mm
Approx. "A" Dimension	.072 in. 1.83 mm	.084 in. 2.13 mm	.084 in. 2.13 mm	.084 in. 2.13 mm	.094 in. 2.39 mm	.108 in. 2.74 mm
At "B" +/- .005in./1.3mm	.112 in. 2.84 mm	.120 in. 3.05 mm	.120 in. 3.05 mm	.120 in. 3.05 mm	.138 in. 3.51 mm	.163 in. 4.14 mm
Wire Diameter	.064	.072	.072	.072	.082	.092
Weight Per Thousand (lbs.)	3.75 lb. 1.70 kg.	5.75 lb. 2.61 kg.	6.25 lb. 2.84 kg.	7.25 lb. 3.29 kg.	10.75 lb. 4.88 kg.	14.75 lb. 6.69 kg.
Stainless Steel	90191	90192	90193	90194	--	--
Cost Per Thousand	\$98.20	\$126.30	\$134.40	\$150.20	--	--
Nickel-Plated Steel	90101	90102	90103	90104	90105	90106
Cost Per Thousand	\$54.75	\$68.00	\$70.00	\$77.25	\$97.75	\$125.00
Zinc-Plated Steel	90201	90202	90203	90204	90205	90206
Cost Per Thousand	\$54.75	\$68.00	\$70.00	\$77.25	\$97.75	\$125.00

Packaging: Bulk

Quantity Discounts (per size & finish): 5M-9M less 5%, 10M-24M less 10%, 25M-49M less 15%, 50M-99M less 20%
100M-499M less 25%, 500M-999M less 30%, 1MM-Over less 35%



WARNING: This product can expose you to chemicals including nickel and lead, which are known to the State of California to cause cancer and birth defects or other reproductive harm. For more information, visit www.P65Warnings.ca.gov

Standard Key Rings

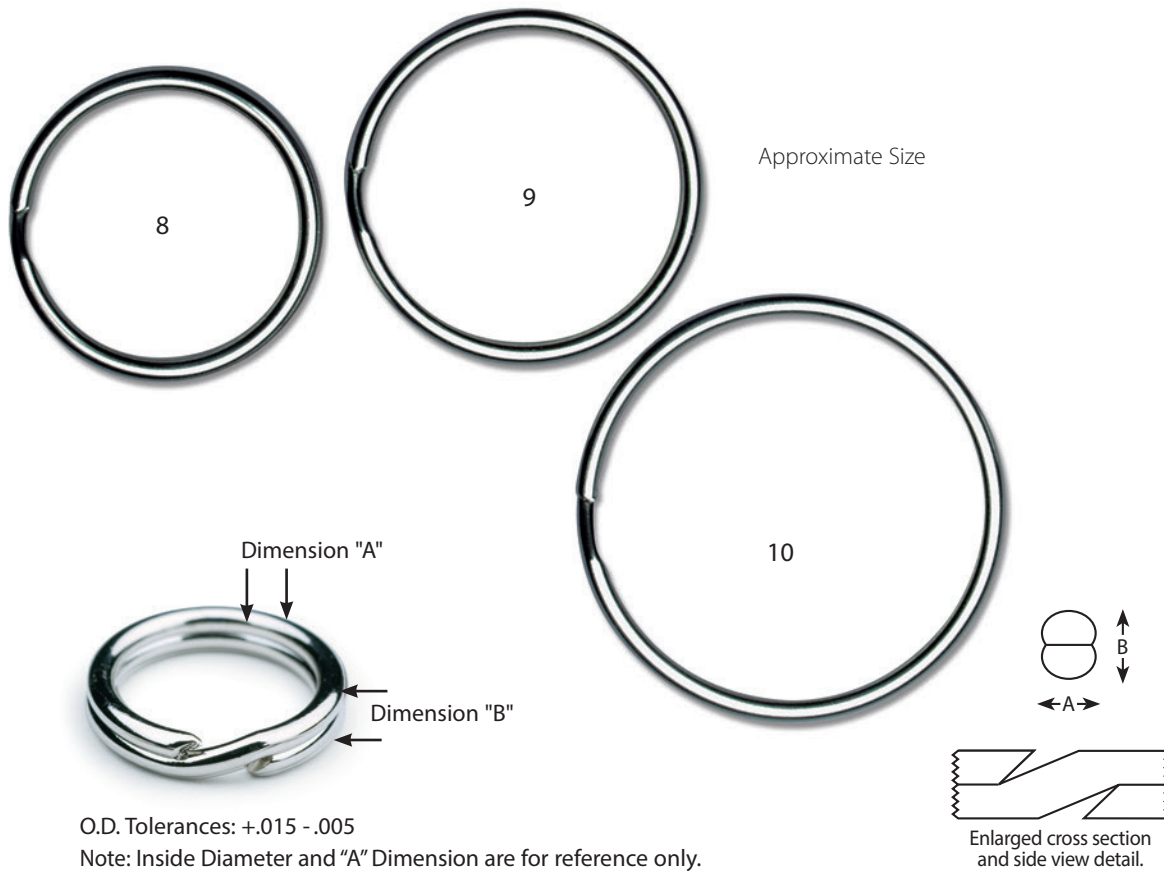

Standard Key Rings

Size	7	8	9	10
Outside Diameter	1.480 in. 37.59 mm	1.640 in. 41.66 mm	1.865 in. 47.37 mm	2.240 in. 56.90 mm
Approx. Inside Diameter	1.264 in. 32.11 mm	1.396 in. 35.46 mm	1.635 in. 41.53 mm	2.016 in. 51.21 mm
Approx. "A" Dimension	.108 in. 2.74 mm	.122 in. 3.10 mm	.115 in. 2.92 mm	.112 in. 2.85 mm
At "B" +/- .005in./ .13mm	.163 in. 4.14 mm	.185 in. 4.70 mm	.185 in. 4.70 mm	.185 in. 4.70 mm
Wire Diameter	.092	.105	.105	.105
Weight Per Thousand (lbs.)	16 lb. 7.26 kg.	23 lb. 10.43 kg.	26.5 lb. 12.02 kg.	32 lb. 14.52 kg.
Stainless Steel	--	--	--	--
Cost Per Thousand	--	--	--	--
Nickel-Plated Steel	90107	90108	90109	90110
Cost Per Thousand	\$135.25	\$190.00	\$216.75	\$301.75
Zinc-Plated Steel	90207	90208	90209	90210
Cost Per Thousand	\$135.25	\$190.00	\$216.75	\$301.75

Packaging: Bulk

Quantity Discounts (per size & finish): 5M-9M less 5%, 10M-24M less 10%, 25M-49M less 15%, 50M-99M less 20%
100M-499M less 25%, 500M-999M less 30%, 1MM-Over less 35%



WARNING: This product can expose you to chemicals including nickel and lead, which are known to the State of California to cause cancer and birth defects or other reproductive harm. For more information, visit www.P65Warnings.ca.gov

KEY RINGS

www.worthco.com
sales@worthco.com

Lightweight Key Rings

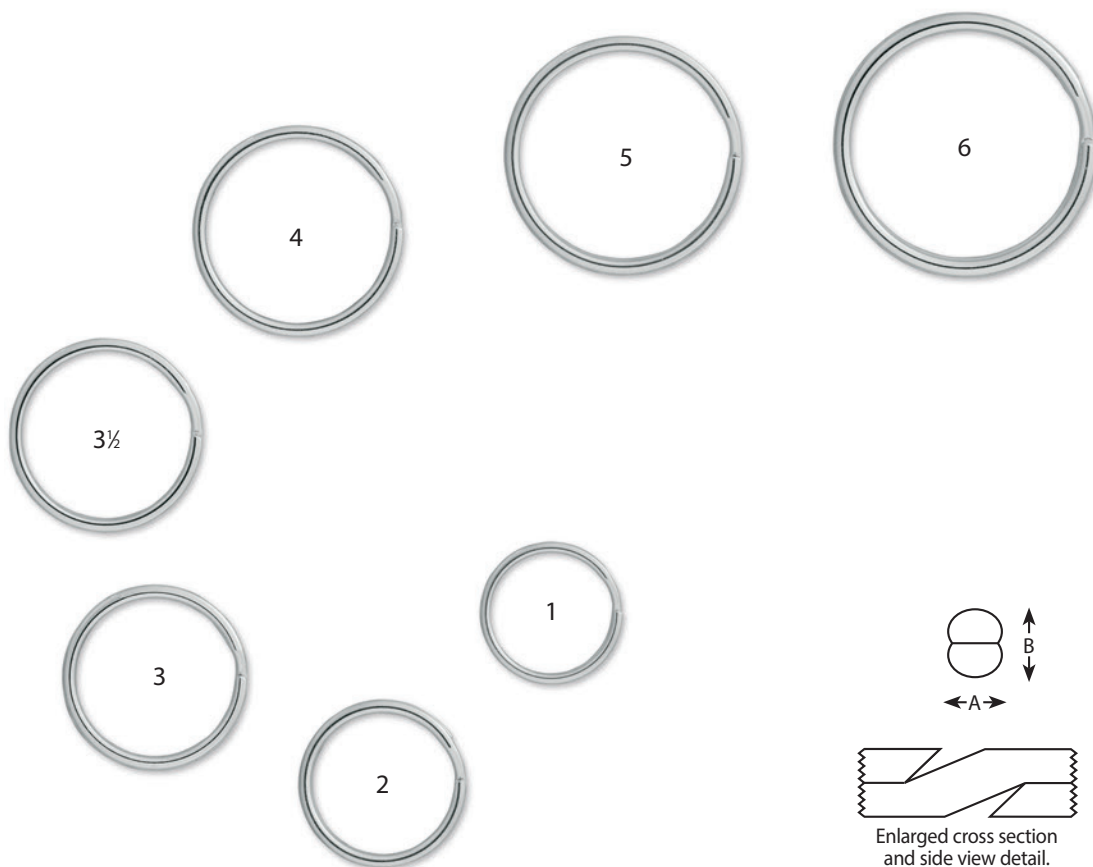

Lightweight Key Rings

Size	1	2	3	3 ½	4	5
Outside Diameter	.740 in. 18.80 mm	.875 in. 22.23 mm	.970 in. 24.64 mm	1.010 in. 25.76 mm	1.100 in. 27.94 mm	1.250 in. 31.75 mm
Approx. Inside Diameter	.626 in. 15.90 mm	.731 in. 18.57 mm	.826 in. 20.98 mm	.866 in. 22.00 mm	.956 in. 24.28 mm	1.082 in. 27.48 mm
Approx. "A" Dimension	.057 in. 1.45 mm	.072 in. 1.83 mm	.072 in. 1.83 mm	.072 in. 1.83 mm	.072 in. 1.83 mm	.084 in. 2.13 mm
At "B" +/- .005in./ .13mm	.087 in. 2.21 mm	.112 in. 2.84 mm	.112 in. 2.84 mm	.112 2.84 mm	.112 in. 2.84 mm	.120 in. 3.05 mm
Wire Diameter	.051	.064	.064	.064	.064	.072
Weight Per Thousand (lbs.)	2.5 lb. 1.13 kg.	4.5 lb. 2.04 kg.	5 lb. 2.27 kg.	5.25 lb. 2.38 kg.	5.25 lb. 2.38 kg.	8.25 lb. 3.74 kg.
Stainless Steel	90491	90492	90493	--	90494	90495
Cost Per Thousand	\$81.40	\$109.20	\$117.10	--	\$121.80	\$159.10
Nickel-Plated Steel	90401	90402	90403	90803	90404	90405
Cost Per Thousand	\$47.75	\$59.75	\$61.50	\$64.50	\$66.25	\$85.00
Zinc-Plated Steel	90501	90502	90503	--	90504	90505
Cost Per Thousand	\$47.75	\$59.75	\$61.50	--	\$66.25	\$85.00

Packaging: Bulk

Quantity Discounts (per size & finish): 5M-9M less 5%, 10M-24M less 10%, 25M-49M less 15%, 50M-99M less 20%, 100M-499M less 25%, 500M-999M less 30%, 1MM-Over less 35%



WARNING: This product can expose you to chemicals including nickel and lead, which are known to the State of California to cause cancer and birth defects or other reproductive harm. For more information, visit www.P65Warnings.ca.gov

Lightweight Key Rings

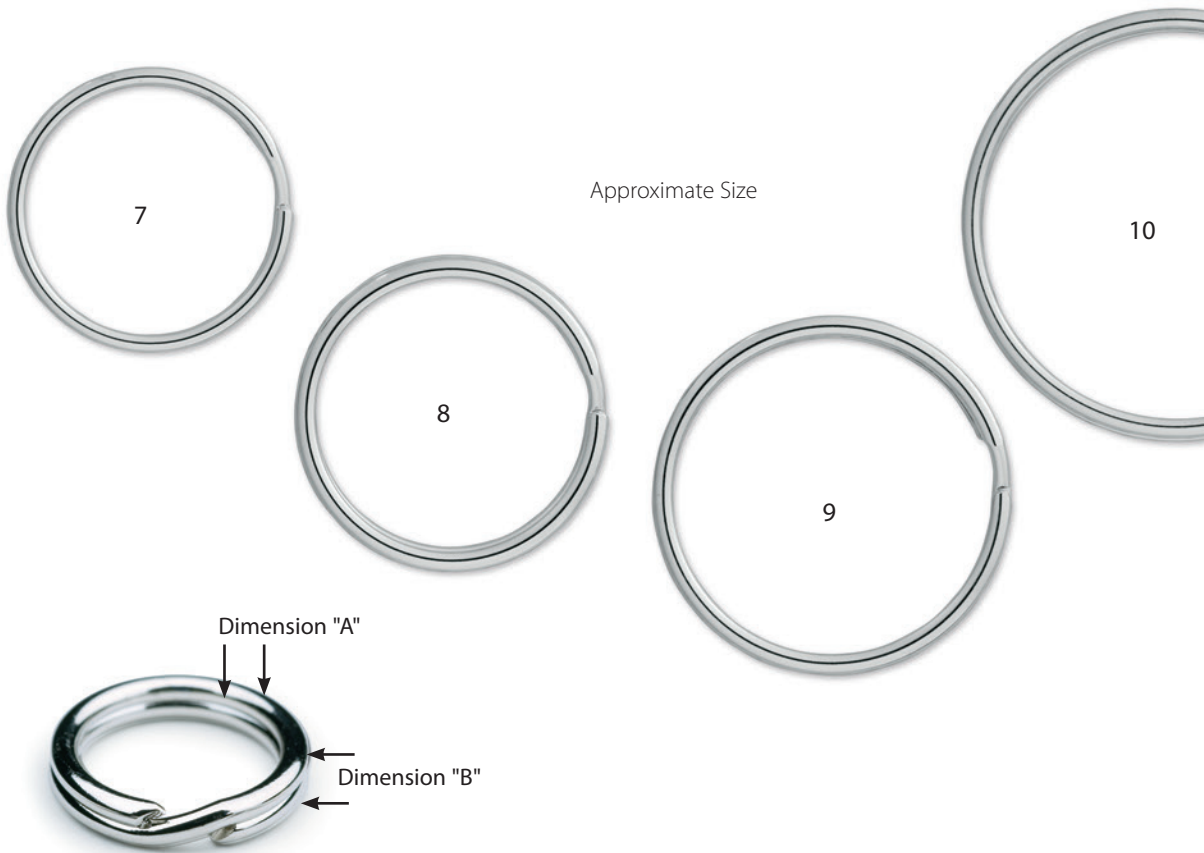

O.D. Tolerances: +.015 - .005

Note: Inside Diameter and "A" Dimension are for reference only.

Lightweight Key Rings

Size	6	7	8	9	10
Outside Diameter	1.375 in. 34.93 mm	1.480 in. 37.59 mm	1.640 in. 41.66 mm	1.865 in. 47.37 mm	2.240 in. 56.90 mm
Approx. Inside Diameter	1.187 in. 30.15 mm	1.292 in. 32.82 mm	1.424 in. 36.17 mm	1.649 in. 41.89 mm	2.024 in. 51.41 mm
Approx. "A" Dimension	.094 in. 2.39 mm	.094 in. 2.39 mm	.108 in. 2.74 mm	.108 in. 2.74 mm	.108 in. 2.74 mm
At "B" +/- .005in./ .13mm	.138 in. 3.51 mm	.138 in. 3.51 mm	.163 in. 4.14 mm	.163 in. 4.14 mm	.163 in. 4.14 mm
Wire Diameter	.082	.082	.092	.092	.092
Weight Per Thousand (lbs.)	11.75 lb. 5.33 kg.	12.75 lb. 5.78 kg.	17.75 lb. 8.05 kg.	20.5 lb. 9.30 kg.	24.75 lb. 11.23 kg.
Nickel-Plated Steel	90406	90407	90408	90409	90410
Cost Per Thousand	\$104.50	\$116.75	\$152.75	\$176.25	\$235.25
Zinc-Plated Steel	90506	90507	90508	90509	90510
Cost Per Thousand	\$104.50	\$116.75	\$152.75	\$176.25	\$235.25

Packaging: Bulk

Quantity Discounts (per size & finish): 5M-9M less 5%, 10M-24M less 10%, 25M-49M less 15%, 50M-99M less 20%

100M-499M less 25%, 500M-999M less 30%, 1MM-Over less 35%



WARNING: This product can expose you to chemicals including nickel and lead, which are known to the State of California to cause cancer and birth defects or other reproductive harm. For more information, visit www.P65Warnings.ca.gov

WORTHCO'S

www.worthco.com

sales@worthco.com

Specialty Rings

KEY RINGS



Approximate Size

Worth offers several specialty rings for demanding applications. Listed below are solid brass key rings available either polished or nickel plated for corrosive applications.

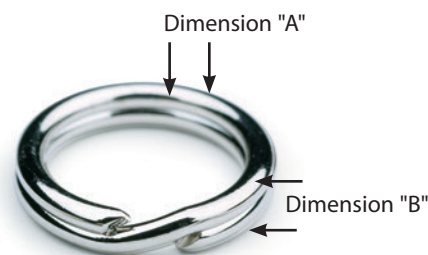

O.D. Tolerances: $+0.015 - 0.005$
 Note: Inside Diameter and "A" Dimension are for reference only.

Specialty Rings - Solid Brass

Size	1	2	3	4
Outside Diameter	.740 in. 18.80 mm	.875 in. 22.23 mm	.970 in. 24.64 mm	1.100 in. 27.94 mm
Approx. Inside Diameter	.596 in. 15.14 mm	.707 in. 17.96 mm	.802 in. 20.37 mm	.932 in. 23.67 mm
Approx. "A" Dimension	.072 in. 1.83 mm	.084 in. 2.13 mm	.084 in. 2.13 mm	.084 in. 2.13 mm
At "B" +/- .005in./ .13mm	.105 in. 2.67 mm	.110 in. 2.79 mm	.110 in. 2.79 mm	.110 in. 2.79 mm
Wire Diameter	.064	.072	.072	.072
Weight Per Thousand (lbs.)	3.88 lb. 1.76 kg.	5.75 lb. 2.61 kg.	6.60 lb. 2.99 kg.	7.80 lb. 3.54 kg.
Nickel-Plated Brass	91201	91202	91203	91204
Cost Per Thousand	\$99.80	\$136.30	\$147.00	\$169.40
Polished Brass	90301	90302	90303	90304
Cost Per Thousand	\$91.90	\$127.40	\$136.80	\$156.80

Packaging: Bulk

Quantity Discounts (per size & finish): 5M-9M less 5%, 10M-24M less 10%, 25M-49M less 15%, 50M-99M less 20%
 100M-499M less 25%, 500M-999M less 30%, 1MM-Over less 35%



WARNING: This product can expose you to chemicals including nickel and lead, which are known to the State of California to cause cancer and birth defects or other reproductive harm. For more information, visit www.P65Warnings.ca.gov

Specialty Rings

Also available in our specialty rings are a one-inch heavy-duty ring made of .105" wire for extreme high strength requirements.



Approximate Size

Specialty Rings Heavyweight

Size	3
Outside Diameter	.990 in. 25.15 mm
Approx. Inside Diameter	.740 in. 18.80 mm
Approx. "A" Dimension	.125 in. 3.18 mm
At "B" +/- .005in./ .13mm	.170 in. 4.32 mm
Wire Diameter	.105
Weight Per Thousand (lbs.)	13.63 lb. 6.18 kg.
Nickel Plated Steel	90123
Cost Per Thousand	\$169.00
Zinc Plated Steel	90153
Cost Per Thousand	\$169.00

Packaging: Bulk

Quantity Discounts (per size & finish): 5M-9M less 5%, 10M-24M less 10%, 25M-49M less 15%, 50M-99M less 20%
100M-499M less 25%, 500M-999M less 30%, 1MM-Over less 35%



WARNING: This product can expose you to chemicals including nickel and lead, which are known to the State of California to cause cancer and birth defects or other reproductive harm. For more information, visit www.P65Warnings.ca.gov

KEY
RINGS

www.worthco.com

sales@worthco.com

High Tolerance Key Rings

Striving for perfection? These tempered steel High Tolerance key rings and split rings are built to the highest quality and dimensional standards possible. These rings are designed for use in automated assembly equipment such as the automotive and medical industries where concentricity and dimensional demands are critical. If your ring size is not listed and you need it built to these standards, please let us know and we will quote you.

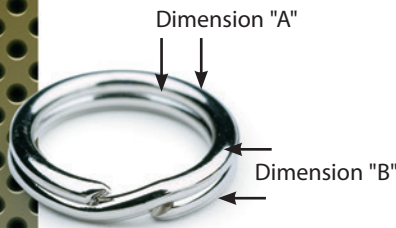
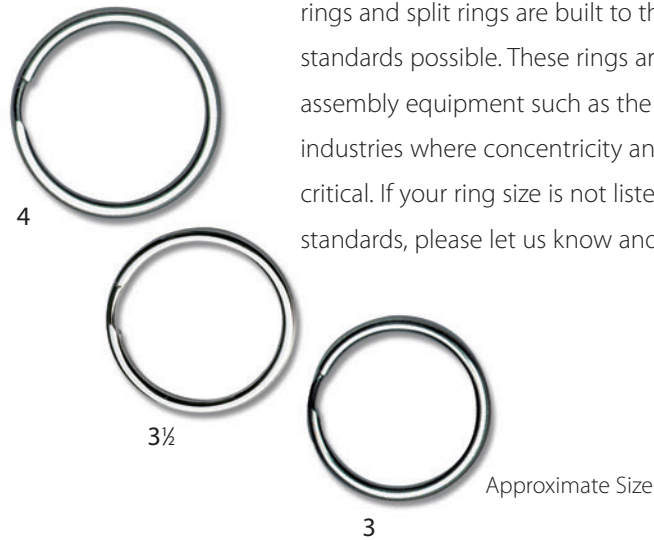

O.D. Tolerances: +.015 - .005
 Note: Inside Diameter and "A" Dimension are for reference only.

High Tolerance Key Rings

Size	3	3 1/2	4
Outside Diameter	.970 in. 24.64 mm	1.010 in. 25.76 mm	1.100 in. 27.94 mm
Approx. Inside Diameter	.826 in. 20.98 mm	.866 in. 22.00 mm	.956 in. 24.28 mm
Approx. "A" Dimension	.072 in. 1.83 mm	.072 in. 1.83 mm	.072 in. 1.83 mm
At "B" +/- .005in./ .13mm	.112 in. 2.67 mm	.112 in. 2.67 mm	.112 in. 2.67 mm
Wire Diameter	.064	.064	.064
Weight Per Thousand (lbs.)	5 lb. 2.27 kg.	5.25 lb. 2.38 kg.	5.25 lb. 2.38 kg.
Nickel-Plated Steel	90853	90813	90704
Cost Per Thousand	\$76.50	\$79.25	\$81.00

Packaging: Bulk

Quantity Discounts (per size & finish): 5M-9M less 5%, 10M-24M less 10%, 25M-49M less 15%, 50M-99M less 20%
 100M-499M less 25%, 500M-999M less 30%, 1MM-Over less 35%



WARNING: This product can expose you to chemicals including nickel and lead, which are known to the State of California to cause cancer and birth defects or other reproductive harm. For more information, visit www.P65Warnings.ca.gov

High Tolerance Split Rings

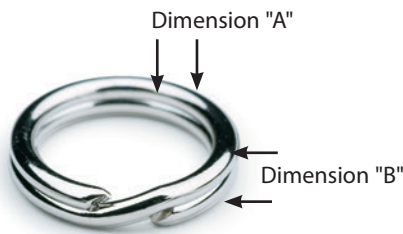
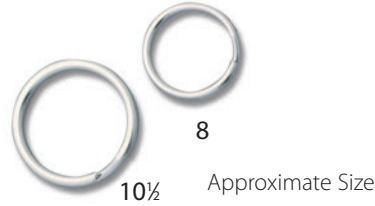

O.D. Tolerances: +.015 - .005

Note: Inside Diameter and "A" Dimension are for reference only.

High Tolerance Split Rings

Size	8 Fine	10½ Fine	10½ Ultra Fine
Outside Diameter	.484 in. 12.29 mm	.630 in. 16.00 mm	.630 in. 16.00 mm
Approx. Inside Diameter	.392 in. 9.96 mm	.516 in. 13.11 mm	.528 in. 13.41 mm
Approx. "A" Dimension	.046 in. 1.17 mm	.057 in. 1.45 mm	.051 in. 1.30 mm
At "B" +/- .005in./1.3mm	.068 in. 1.73 mm	.083 in. 2.11 mm	.074 in. 1.88 mm
Wire Diameter	.040	.051	.045
Weight Per Thousand (lbs.)	.97 lb. .440 kg.	2.01 lb. .910 kg.	1.45 lb. .658 kg.
Nickel-Plated Steel	90708	90710	90735
Cost Per Thousand	\$47.00	\$59.75	\$49.50

Packaging: Bulk

Quantity Discounts (per size & finish): 5M-9M less 5%, 10M-24M less 10%, 25M-49M less 15%, 50M-99M less 20%
100M-499M less 25%, 500M-999M less 30%, 1MM-Over less 35%



WARNING: This product can expose you to chemicals including nickel and lead, which are known to the State of California to cause cancer and birth defects or other reproductive harm. For more information, visit www.P65Warnings.ca.gov

High Tolerance Rings

www.worthco.com

sales@worthco.com

Standard Gauge Split Rings

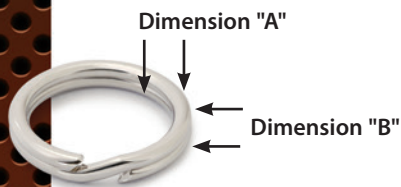
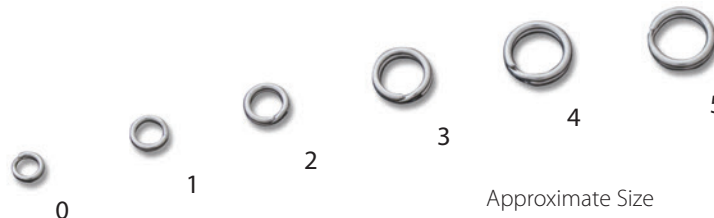

O.D. Tolerances:
 Steel and Stainless Steel +.015 -.005
 Brass +.025 -.005

Worth standard gauge split rings are made in the USA and are the standard of the American industry. The rings shown here for any connecting application are the same rings used in aerospace, automotive, and defense equipment.

Standard Gauge Split Rings

Size	0	1	2	3	4	5
Outside Diameter	.165 in / 4.19 mm	.190 in / 4.83 mm	.220 in / 5.59 mm	.254 in / 6.45 mm	.292 in / 7.42 mm	.334 in / 8.48 mm
Approx. Inside Dia.	.107 in / 2.72 mm	.128 in / 3.25 mm	.150 in / 3.81 mm	.174 in / 4.42 mm	.212 in / 5.39 mm	.242 in / 6.15 mm
Approx. "A" Dim.	.029 in / .74 mm	.031 in / .79 mm	.035 in / .89 mm	.040 in / 1.02 mm	.040 in / 1.02 mm	.046 in / 1.17 mm
At "B" +/- .005 in./1.3mm	.040 in / 1.02 mm	.046 in / 1.17 mm	.054 in / 1.37 mm	.062 in / 1.58 mm	.062 in / 1.58 mm	.068 in / 1.73 mm
Wire Diameter	.025	.028	.032	.036	.036	.040
Weight Per Thousand	.12 lb / .054 kg	.17 lb / .077 kg	.26 lb / .118 kg	.38 lb / .172 kg	.45 lb / .204 kg	.64 lb / .290 kg
Nickel-Plated Brass	92100	92101	92102	92103	92104	92105
Cost Per Thousand	\$28.20	\$28.40	\$27.10	\$26.30	\$27.40	\$35.60
Polished Brass	92400	92401	92402	92403	92404	92405
Cost Per Thousand	\$28.20	\$28.20	\$27.40	\$24.90	\$26.30	\$33.60
Stainless Steel	--	--	94212	94213	94214	94215
Cost Per Thousand	--	--	\$21.00	\$21.80	\$22.90	\$25.80
Nickel-Plated Steel	92000	92001	92002	92003	92004	92005
Cost Per Thousand	\$27.50	\$27.50	\$26.00	\$22.50	\$22.50	\$25.00
Zinc Plated Steel	92200	92201	92202	92203	92204	92205
Cost Per Thousand	\$27.50	\$27.50	\$26.00	\$22.50	\$22.50	\$25.00

Packaging: Bulk

Quantity Discounts (per size & finish): 5M-9M less 5%, 10M-24M less 10%, 25M-49M less 15%, 50M-99M less 20%
 100M-499M less 25%, 500M-999M less 30%, 1MM-Over less 35%



WARNING: This product can expose you to chemicals including nickel and lead, which are known to the State of California to cause cancer and birth defects or other reproductive harm. For more information, visit www.P65Warnings.ca.gov

Standard Gauge Split Rings

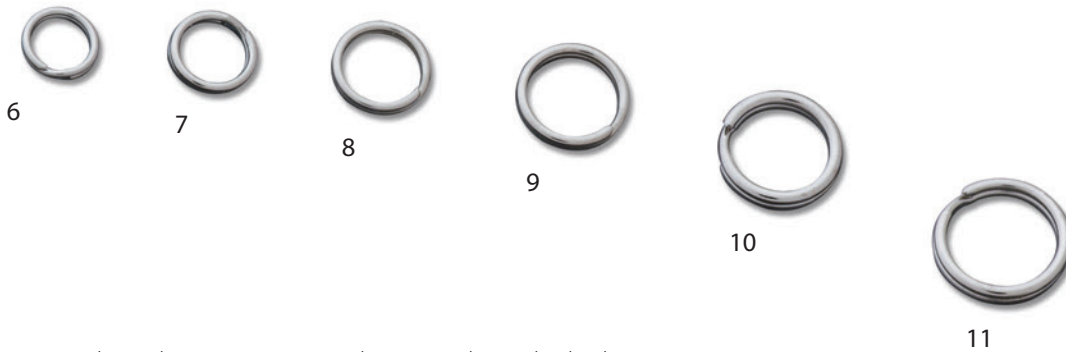

Made under our intense quality control standards, these rings are available in brass, stainless steel, and spring-tempered steel. Our spring-tempered rings are fabricated from a unique steel and magnesium alloy which is 25% stronger than stainless steel. These are the finest quality rings available anywhere.

Standard Gauge Split Rings

Size	6	7	8	9	10	11
Outside Diameter	.380 in / 9.65 mm	.430 in / 10.92 mm	.484 in / 12.29 mm	.542 in / 13.77 mm	.604 in / 15.34 mm	.670 in / 17.02 mm
Approx. Inside Dia.	.288 in / 7.32 mm	.328 in / 8.33 mm	.382 in / 9.70 mm	.428 in / 10.87 mm	.460 in / 11.68 mm	.526 in / 13.36 mm
Approx. "A" Dim.	.046 in / 1.17 mm	.051 in / 1.30 mm	.051 in / 1.30 mm	.057 in / 1.45 mm	.072 in / 1.83 mm	.072 in / 1.83 mm
At "B" +/- .005in./13mm	.068 in / 1.73 mm	.074 in / 1.88 mm	.074 in / 1.88 mm	.083 in / 2.11 mm	.105 in / 2.67 mm	.105 in / 2.67 mm
Wire Diameter	.040	.045	.045	.051	.064	.064
Weight Per Thousand	.74 lb / .336 kg	1.06 lb / .481 kg	1.21 lb / .549 kg	1.74 lb / .789 kg	3.01 lb / 1.365 kg	3.38 lb / 1.533 kg
Nickel-Plated Brass	92106	92107	92108	92109	92110	92111
Cost Per Thousand	\$40.00	\$49.20	\$52.30	\$64.20	\$80.30	\$90.40
Polished Brass	92406	92407	92408	92409	92410	92411
Cost Per Thousand	\$37.40	\$45.90	\$48.40	\$58.30	\$74.30	\$80.90
Stainless Steel	94216	94217	94218	94219	94220	94221
Cost Per Thousand	\$27.60	\$32.90	\$36.80	\$48.60	\$68.00	\$73.50
Nickel-Plated Steel	92006	92007	92008	92009	92010	92011
Cost Per Thousand	\$26.25	\$31.25	\$32.25	\$35.50	\$43.25	\$46.50
Zinc Plated Steel	92206	92207	92208	92209	92210	92211
Cost Per Thousand	\$26.25	\$31.25	\$32.25	\$35.50	\$43.25	\$46.50

Packaging: Bulk

Quantity Discounts (per size & finish): 5M-9M less 5%, 10M-24M less 10%, 25M-49M less 15%, 50M-99M less 20%
100M-499M less 25%, 500M-999M less 30%, 1MM-Over less 35%



WARNING: This product can expose you to chemicals including nickel and lead, which are known to the State of California to cause cancer and birth defects or other reproductive harm. For more information, visit www.P65Warnings.ca.gov

Split Rings

Fine Gauge Split Rings

Choose the "Right" Ring

	Good	Better	Best
Stainless Steel	Strength	X	
	Price		X
	Memory	X	
	Corrosion Resistance		X
Nickel	Strength		X
	Price	X	
	Memory		X
	Corrosion Resistance	X	
Zinc	Strength		X
	Price	X	
	Memory		X
	Corrosion Resistance	X	

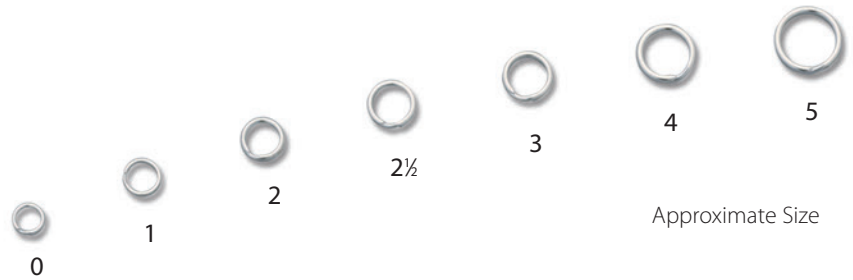

Approximate Size

Worth fine gauge split rings are made to the same intense quality standards as all other Worth split rings. The only difference is they are made from finer gauge wire for lighter applications or where ease of assembly is critical. They are available in brass, stainless steel, and spring-tempered steel. Brass rings are available polished or nickel-plated, and tempered steel rings are available nickel or zinc plated. Like all other Worth products, these are proudly made in America.

Fine Gauge Split Rings

* = Brass & Steel "B" Dimension is .034 in.

** = Brass & Steel Wire is .020

Size	0	1	2	2½	3	4	5
Outside Diameter	.165 in / 4.19 mm	.190 in / 4.83 mm	.220 in / 5.59 mm	.237 in / 6.02 mm	.254 in / 6.45 mm	.292 in / 7.42 mm	.334 in / 8.48 mm
Approx. Inside Dia.	.117 in / 2.97 mm	.142 in / 3.61 mm	.162 in / 4.12 mm	.179 in / 4.55 mm	.192 in / 4.88 mm	.222 in / 5.64 mm	.264 in / 6.71 mm
Approx. "A" Dim.	.024 in / .61 mm	.024 in / .61 mm	.029 in / .74 mm	.029 in / .74 mm	.031 in / .79 mm	.035 in / .89 mm	.035 in / .89 mm
At "B" +/- .005in/.13mm	.034 in / .86 mm	.036 in / .91 mm*	.040 in / 1.02 mm	.036 in / .91 mm	.046 in / 1.17 mm	.054 in / 1.37 mm	.054 in / 1.37 mm
Wire Diameter	.020	.022**	.025	.022	.028	.032	.032
Weight Per Thousand	.08 lb / .036 kg	.09 lb / .041 kg	.17 lb / .077 kg	.14 lb / .064 kg	.24 lb / .109 kg	.36 lb / .163 kg	.42 lb / .191 kg
Nickel-Plated Brass	92600	92601	92602	--	92603	92604	92605
Cost Per Thousand	\$28.20	\$28.40	\$27.10		\$26.30	\$27.40	\$35.60
Polished Brass	92900	92901	92902	--	92903	92904	92905
Cost Per Thousand	\$28.20	\$28.20	\$27.40		\$24.90	\$26.30	\$33.60
Stainless Steel	94550	94551	94552	94563	94553	94554	94555
Cost Per Thousand	\$19.70	\$20.80	\$19.50	\$19.20	\$20.50	\$21.60	\$22.60
Nickel-Plated Steel	92500	92501	92502	92513	92503	92504	92505
Cost Per Thousand	\$27.50	\$27.50	\$26.00	\$22.50	\$22.50	\$22.50	\$25.00
Zinc Plated Steel	92700	92701	92702	--	92703	92704	92705
Cost Per Thousand	\$27.50	\$27.50	\$26.00		\$22.50	\$22.50	\$25.00

Packaging: Bulk

Quantity Discounts (per size & finish): 5M-9M less 5%, 10M-24M less 10%, 25M-49M less 15%, 50M-99M less 20%

100M-499M less 25%, 500M-999M less 30%, 1MM-Over less 35%



WARNING: This product can expose you to chemicals including nickel and lead, which are known to the State of California to cause cancer and birth defects or other reproductive harm. For more information, visit www.P65Warnings.ca.gov

Fine Gauge Split Rings

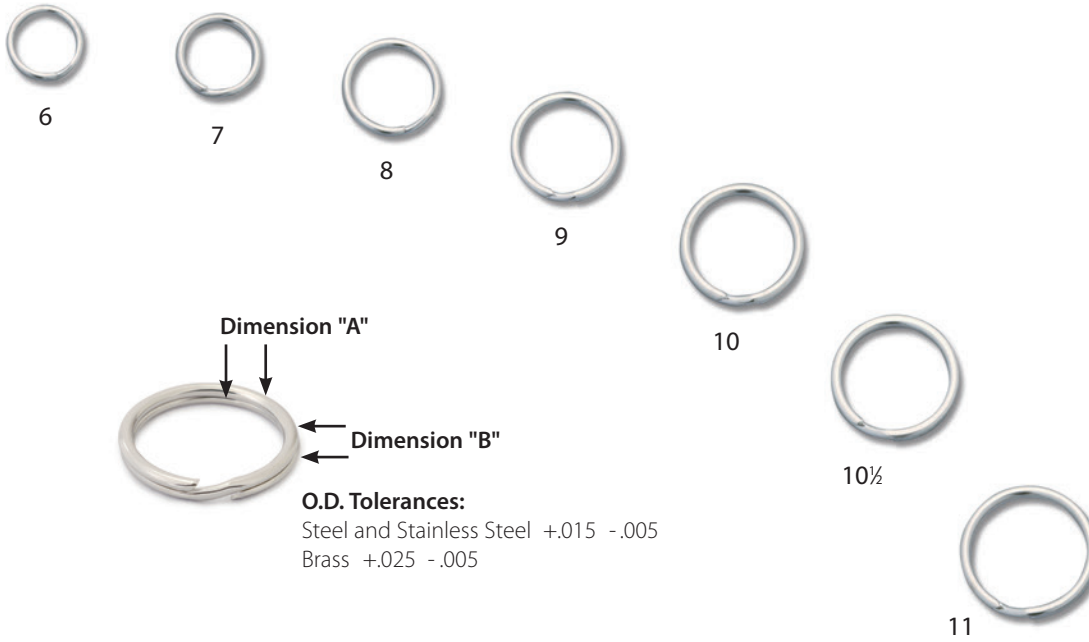

Split Rings

Fine Gauge Split Rings

Size	6	7	8	9	10	10½	11
Outside Diameter	.380 in / 9.65 mm	.430 in / 10.92 mm	.484 in / 12.29 mm	.542 in / 13.77 mm	.604 in / 15.34 mm	.630 in / 16.00 mm	.670 in / 17.02 mm
Approx. Inside Dia.	.300 in / 7.62 mm	.338 in / 8.59 mm	.392 in / 9.96 mm	.440 in / 11.18 mm	.490 in / 12.45 mm	.516 in / 13.11 mm	.556 in / 14.12 mm
Approx. "A" Dim.	.040 in / 1.02 mm	.046 in / 1.17 mm	.046 in / 1.17 mm	.051 in / 1.30 mm	.057 in / 1.45 mm	.057 in / 1.45 mm	.057 in / 1.45 mm
At "B" +/- .005in./13mm	.062 in / 1.58 mm	.068 in / 1.73 mm	.068 in / 1.73 mm	.074 in / 1.88 mm	.083 in / 2.11 mm	.083 in / 2.11 mm	.083 in / 2.11 mm
Wire Diameter	.036	.040	.040	.045	.051	.051	.051
Weight Per Thousand	.61 lb / .277 kg	.85 lb / .386 kg	.97 lb / .440 kg	1.37 lb / .621 kg	1.96 lb / .889 kg	2.01 lb / .910 kg	2.19 lb / .993 kg
Nickel-Plated Brass	92606	92607	92608	92609	92610	--	92611
Cost Per Thousand	\$40.00	\$49.20	\$52.30	\$64.20	\$80.30		\$90.40
Polished Brass	92906	92907	92908	92909	92910	--	92911
Cost Per Thousand	\$37.40	\$45.90	\$48.40	\$58.30	\$74.30		\$80.90
Stainless Steel	94556	94557	94558	94559	94560	--	94561
Cost Per Thousand	\$25.50	\$30.20	\$32.60	\$42.80	\$52.00		\$59.40
Nickel-Plated Steel	92506	92507	92508	92509	92510	92525	92511
Cost Per Thousand	\$26.25	\$31.25	\$32.25	\$35.50	\$43.25	\$43.75	\$46.50
Zinc Plated Steel	92706	92707	92708	92709	92710	--	92711
Cost Per Thousand	\$26.25	\$31.25	\$32.25	\$35.50	\$43.25		\$46.50

Packaging: Bulk

Quantity Discounts (per size & finish): 5M-9M less 5%, 10M-24M less 10%, 25M-49M less 15%, 50M-99M less 20%
 100M-499M less 25%, 500M-999M less 30%, 1MM-Over less 35%



WARNING: This product can expose you to chemicals including nickel and lead, which are known to the State of California to cause cancer and birth defects or other reproductive harm. For more information, visit www.P65Warnings.ca.gov

X² Oval Rings

X² Oval Power Rings are 50% stronger than similar fine sized round split rings, making them the strongest ring available anywhere. Their unique oval design is also self-centering to keep the “split” at the side. These rings are made from a unique magnesium alloy, which is stronger than stainless steel, and are finished with a military-grade zinc plating.

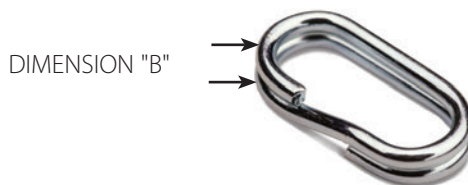
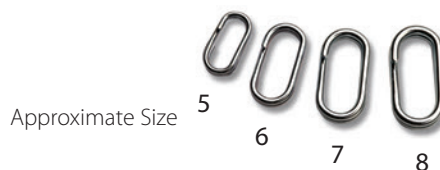

X² Fine Oval Split Rings

Size	5	6	7	8
Length	.315 in / 8 mm	.394 in / 10 mm	.433 in / 11 mm	.472 in / 12 mm
Width	.158 in / 4 mm	.197 in / 5 mm	.217 in / 5.5 mm	.236 in / 6 mm
"B" Dimension	.059 in / 1.50 mm	.065 in / 1.65 mm	.073 in / 1.85 mm	.080 in / 2.03 mm
Wire Diameter	.028	.032	.036	.040
Weight Per Thousand	.23 lb / .104 kg	.37 lb / .168 kg	.54 lb / .245 kg	.72 lb / .327 kg
Zinc Plated Steel	82105	82106	82107	82108
Cost Per Thousand	\$30.00	\$32.25	\$37.50	\$38.75

Packaging: Bulk

Quantity Discounts (per size & finish): 5M-9M less 5%, 10M-24M less 10%, 25M-49M less 15%, 50M-99M less 20%
100M-499M less 25%, 500M-999M less 30%, 1MM-Over less 35%



WARNING: This product can expose you to chemicals including nickel and lead, which are known to the State of California to cause cancer and birth defects or other reproductive harm. For more information, visit www.P65Warnings.ca.gov

Heavyweight Split Rings

Worth heavy weight split rings are used in applications where strength is the most important requirement. They are made from heavier gauges of spring-tempered steel wire, making them extremely strong for their size. These rings are ideal for large game fish such as musky and northern pike. They are available in four popular sizes, and finished in either nickel plate, bright zinc plate, and stainless steel.

Need the right tool for the job? Check out our split ring pliers on page 20.

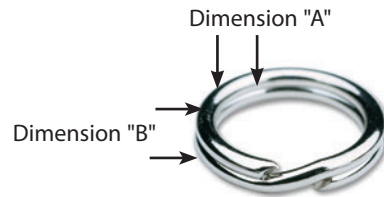
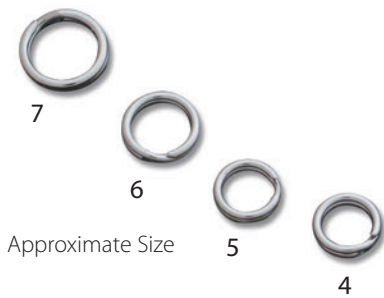

O.D. Tolerances:
Steel and Stainless Steel +.015 -.005

Heavy Weight Split Rings

Size	4	5	6	7
Outside Diameter	.292 in / 7.42 mm	.334 in / 8.48 mm	.380 in / 9.65 mm	.430 in / 10.92 mm
Approx. Inside Dia.	.200 in / 5.08 mm	.232 in / 5.89 mm	.278 in / 7.06 mm	.316 in / 8.03 mm
Approx. "A" Dim.	.046 in / 1.17 mm	.051 in / 1.30 mm	.051 in / 1.30 mm	.057 in / 1.45 mm
At "B" +/- .005in/.13mm	.068 in / 1.73 mm	.074 in / 1.88 mm	.074 in / 1.88 mm	.083 in / 2.11 mm
Wire Diameter	.040	.045	.045	.051
Weight Per Thousand	.517 lb / .24 kg	.737 lb / .37 kg	.947 lb / .43 kg	1.38 lb / .63 kg
Nickel-Plated Steel	94244	94245	94246	94247
Cost Per Thousand	\$23.50	\$25.25	\$27.50	\$29.75
Stainless Steel	91604	91605	91606	91607
Cost Per Thousand	\$46.20	\$46.20	\$49.40	\$53.10
Zinc Plated Steel	94274	94275	94276	94277
Cost Per Thousand	\$23.50	\$25.25	\$27.50	\$29.75

Packaging: Bulk

Quantity Discounts (per size & finish): 5M-9M less 5%, 10M-24M less 10%, 25M-49M less 15%, 50M-99M less 20%
100M-499M less 25%, 500M-999M less 30%, 1MM-Over less 35%



WARNING: This product can expose you to chemicals including nickel and lead, which are known to the State of California to cause cancer and birth defects or other reproductive harm. For more information, visit www.P65Warnings.ca.gov

Split Rings

www.worthco.com

sales@worthco.com

Triangle Rings

Triangle Rings

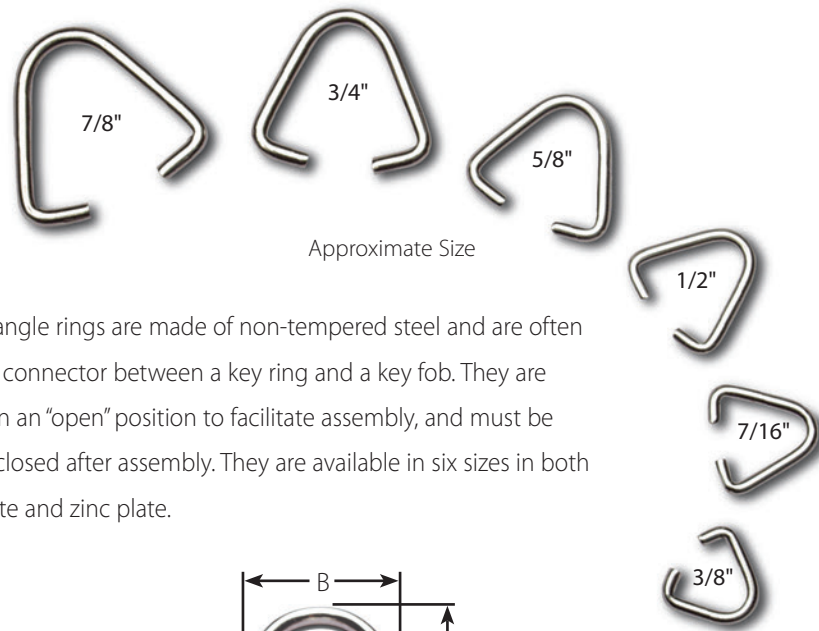

Approximate Size

Worth triangle rings are made of non-tempered steel and are often used as a connector between a key ring and a key fob. They are shipped in an "open" position to facilitate assembly, and must be crimped closed after assembly. They are available in six sizes in both nickel plate and zinc plate.

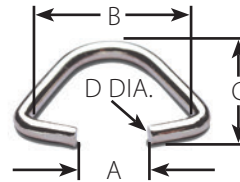

OPEN TRIANGLE RINGS
(NON-TEMPERED STEEL)

Triangle Rings

Size	3/8"	7/16"	1/2"	5/8"	3/4"	7/8"
"A" Dimension	.170 in. 4.32 mm	.197 in. 5.00 mm	.230 in. 5.84 mm	.260 in. 6.60 mm	.321 in. 8.15 mm	.375 in. 9.53 mm
"B" Dimension Open	.375 in. 9.53 mm	.418 in. 10.62 mm	.491 in. 12.47 mm	.625 in. 15.88 mm	.750 in. 19.05 mm	.875 in. 22.23 mm
"B" Dimension Closed	.248 in. 6.30 mm	.290 in. 7.37 mm	.358 in. 9.09 mm	.450 in. 11.43 mm	.500 in. 12.70 mm	.575 in. 14.61 mm
"C" Dimension	.467 in. 11.86 mm	.550 in. 13.97 mm	.610 in. 15.49 mm	.700 in. 17.78 mm	.846 in. 21.49 mm	.956 in. 24.28 mm
"D" Diameter	.072	.072	.072	.082	.092	.092
Weight Per Thousand (lbs.)	1.28 lb. .58 kg.	1.54 lb. .70 kg.	1.94 lb. .88 kg.	2.71 lb. 1.23 kg.	4.07 lb. 1.85 kg.	4.66 lb. 2.11 kg.
Nickel-Plated Steel	94293	94290	94294	94295	94296	94297
Cost Per Thousand	\$15.50	\$16.50	\$18.50	\$22.50	\$30.00	\$33.00
Zinc-Plated Steel	94263	94260	94264	94265	94266	94267
Cost Per Thousand	\$15.50	\$16.50	\$18.50	\$22.50	\$30.00	\$33.00

Packaging: Bulk

Quantity Discounts (per size & finish): 5M-9M less 5%, 10M-24M less 10%, 25M-49M less 15%, 50M-99M less 20%
100M-499M less 25%, 500M-999M less 30%, 1MM-Over less 35%



WARNING: This product can expose you to chemicals including nickel and lead, which are known to the State of California to cause cancer and birth defects or other reproductive harm. For more information, visit www.P65Warnings.ca.gov

Gift Rings

Worth gift rings are 1½ revolution light wire rings used where low cost is the primary requirement and strength is not an issue. These rings are not pressed flat. Gift rings are available in either stainless steel or zinc plated steel in three popular sizes.

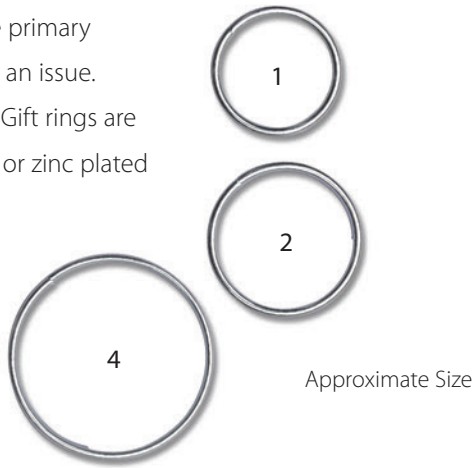

Gift Rings - Stainless Steel

Size	1	2	4
Outside Diameter	.672 in. 17.07 mm	.797 in. 20.24 mm	1.047 in. 26.59 mm
Approx. Inside Diameter	.578 in. 14.68 mm	.703 in. 17.86 mm	.953 in. 24.21 mm
Gauge Wire	.045 in.	.045 in.	.045 in.
Weight Per Thousand (lbs.)	1.20 lb. .54 kg.	1.41 lb. .64 kg.	1.95 lb. .88 kg.
Stainless Steel	91401	91402	91404
Cost Per Thousand	\$33.60	\$37.10	\$46.00

Gift Rings - Zinc-Plated Steel

Size	1	2	4
Outside Diameter	.672 in. 17.07 mm	.797 in. 20.24 mm	1.047 in. 26.59 mm
Approx. Inside Diameter	.578 in. 14.68 mm	.703 in. 17.86 mm	.953 in. 24.21 mm
Gauge Wire	.047 in.	.047 in.	.047 in.
Weight Per Thousand (lbs.)	1.42 lb. .64 kg.	1.56 lb. .71 kg.	2.15 lb. .98 kg.
Zinc-Plated Steel	91517	91518	91516
Cost Per Thousand	\$12.50	\$13.25	\$17.75

Packaging: Bulk

Quantity Discounts (per size & finish): 5M-9M less 5%, 10M-24M less 10%, 25M-49M less 15%, 50M-99M less 20%
100M-499M less 25%, 500M-999M less 30%, 1MM-Over less 35%



WARNING: This product can expose you to chemicals including nickel and lead, which are known to the State of California to cause cancer and birth defects or other reproductive harm. For more information, visit www.P65Warnings.ca.gov

Gift Rings

www.worthco.com

sales@worthco.com

Split Ring Pliers & Jump Rings

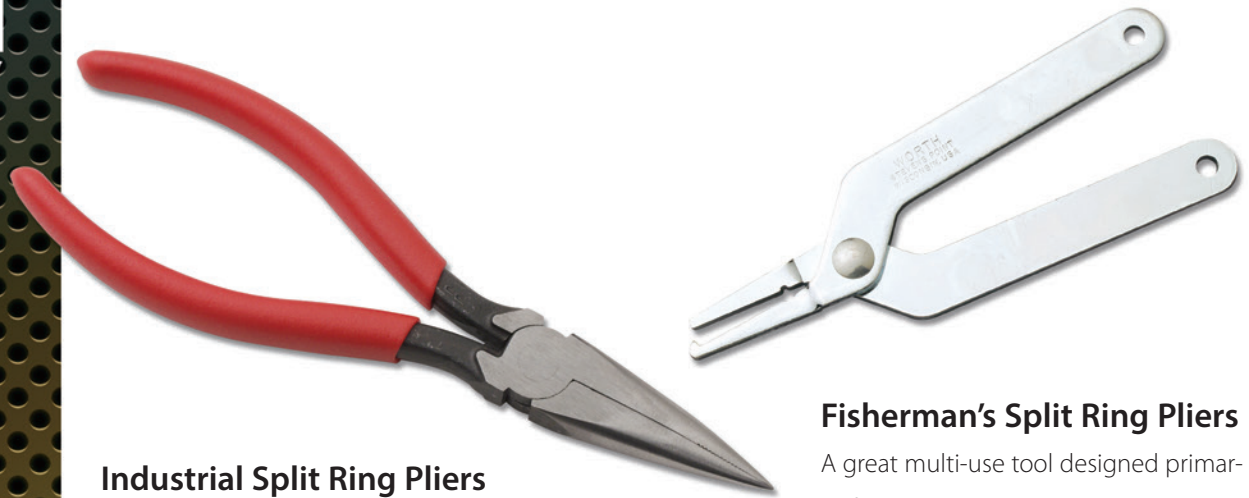

Industrial Split Ring Pliers

These high-quality pliers are designed to make short and effortless work of attaching split rings to articles and fasteners of all types. Constructed from strong forged steel with comfortable non-slip handle. Includes instruction sheet.

Catalog No. 91500

Cost: \$36.80

Weight/Thousand: .35 lbs.

No Quantity Discounts

Fisherman's Split Ring Pliers

A great multi-use tool designed primarily for assembling small split rings, but may also be used for crimping leader sleeves or small sinkers. Attractively priced and perfect for light assembly operations or consumer resale. Made from bright zinc - plated steel.

Catalog No.: 91501

Weight/Thousand: .13 lbs.

Cost: \$2.50

Quantity Discounts:

100 less 5%, 1000 less 10%



Made from stainless steel. Used as a connector where a single coil ring is desired. Ring is left open at ends for assembly then squeezed together.

Jump Rings

Size	2	3	4	5	6	7	8	9	10	11
Outside Diameter	.220 in. 5.59 mm	.254 in. 6.45 mm	.292 in. 7.42 mm	.334 in. 8.48 mm	.380 in. 9.65 mm	.430 in. 10.92 mm	.484 in. 12.29 mm	.542 in. 13.77 mm	.604 in. 15.34 mm	.670 in. 17.02 mm
Approx. Inside Diameter	.156 in. 3.96 mm	.182 in. 4.62 mm	.220 in. 5.59 mm	.254 in. 6.45 mm	.300 in. 7.62 mm	.340 in. 8.64 mm	.394 in. 10.00 mm	.440 in. 11.18 mm	.476 in. 12.09 mm	.542 in. 13.77 mm
Wire Diameter	.032	.036	.036	.040	.040	.045	.045	.051	.064	.064
Weight Per Thousand (lbs.)	.133 lb. .06 kg.	.190 lb. .09 kg.	.218 lb. .10 kg.	.322 lb. .15 kg.	.379 lb. .17 kg.	.528 lb. .24 kg.	.620 lb. .28 kg.	.890 lb. .40 kg.	1.54 lb. .70 kg.	1.725 lb. .78 kg.
Stainless Steel	98872	98873	98874	98875	98876	98877	98878	98879	98870	98871
Cost Per Thousand	\$11.10	\$11.60	\$12.40	\$13.70	\$15.00	\$17.60	\$21.30	\$25.20	\$35.00	\$37.80

Packaging: Bulk

Quantity Discounts (per size & finish): 5M-9M less 5%, 10M-24M less 10%, 25M-49M less 15%, 50M-99M less 20%
100M-499M less 25%, 500M-999M less 30%, 1MM-Over less 35%



WARNING: This product can expose you to chemicals including nickel and lead, which are known to the State of California to cause cancer and birth defects or other reproductive harm. For more information, visit www.P65Warnings.ca.gov

S Hooks

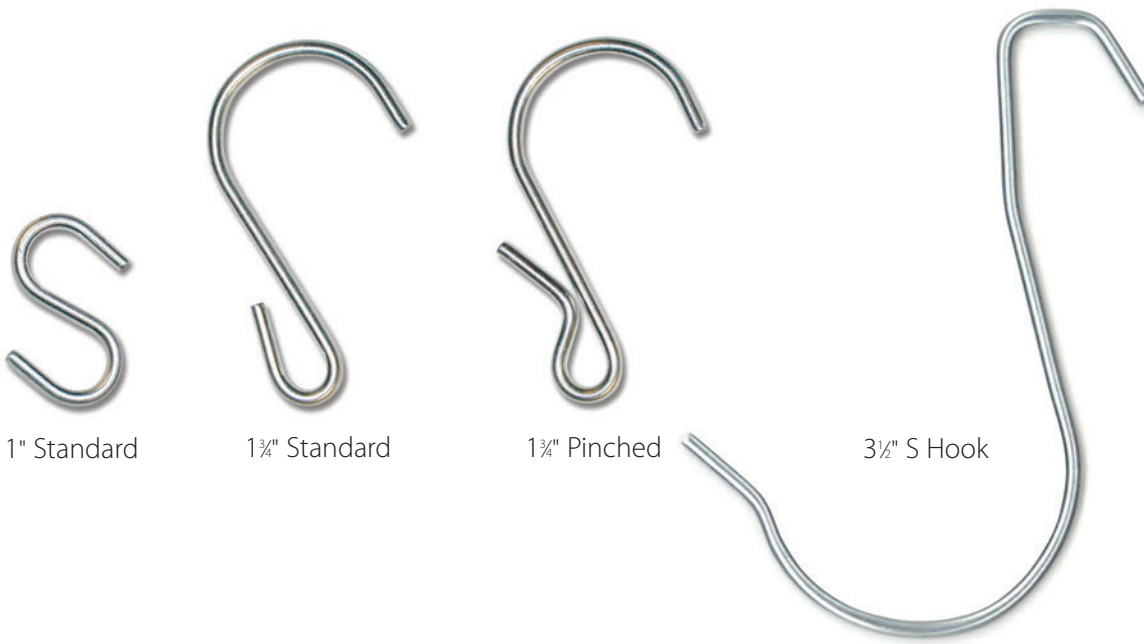

1" Standard

1 3/4" Standard

1 3/4" Pinched

3 1/2" S Hook

Worth S-Hooks are crafted from durable .080 galvanized steel and are available in 3 styles: 1" Standard, 1 3/4" Standard, and 1 3/4" Pinched. These high-quality hooks lend themselves to many display and hanging applications.

The 3.5" S hook is manufactured from .090 galvanized steel and is the choice for trade show applications where signs need to be hung from either the back wall or sides of booth.

S Hooks

Description	1" Standard	1 3/4" Standard	1 3/4" Pinched	3 1/2" S Hook
Overall Length	1.01 in.	1.64 in.	1.64 in.	3.50 in.
Weight Per Thousand (lbs.)	3.31 lb.	5.10 lb.	5.60 lb.	11.80 lb.
Catalog Number	86000	86010	86020	86030
Cost Per Thousand	\$16.25	\$21.25	\$23.50	\$35.50

Custom sizes or packaging options are also available.

Packaging: Bulk

Quantity Discounts (per size & finish): 5M-9M less 5%, 10M-24M less 10%, 25M-49M less 15%, 50M-99M less 20%
100M-499M less 25%, 500M-999M less 30%, 1MM-Over less 35%

www.worthco.com

sales@worthco.com



WARNING: This product can expose you to chemicals including nickel and lead, which are known to the State of California to cause cancer and birth defects or other reproductive harm. For more information, visit www.P65Warnings.ca.gov

Terms and General Information

Terms: Net 30 days to all pre-approved accounts. Shipments made F.O.B. Stevens Point, WI. Payment must accompany orders from unrated firms or shipments will be made C.O.D. MasterCard, VISA and Discover credit cards are also accepted. C.O.D. shipments must be remitted with check or money order. No account will be shipped merchandise unless account is current. Accounts payable in U.S. Funds.

Prices: All prices contained within are NET. Prices are effective February 18, 2018 and are subject to change without notice.

Quantity Discounts: Quantity discounts are allowed as specified for each individual product. No combination or further discounts are available.

Scheduled Shipments: Orders with split shipping dates will be invoiced at the discount applicable for the quantity ordered. No scheduled orders will be accepted for shipping dates spread over more than six months.

Samples: Samples are available to qualified manufacturers upon request.

Returned Goods: A minimum restocking charge of 10% will be made on any goods returned in their original condition. No returns are allowed on special or custom orders of products which are not regularly cataloged by us. No returns will be accepted without prior approval. Returns will not be accepted after 60 days from invoice date.

Special Orders: Products of special design will require a 100% tooling and product deposit with a formal purchase order, unless otherwise approved by Worth Company management. An order is considered complete when quantities shipped are over or under 10% of the original purchase order.

Packaging: All items contained within are shipped in bulk. Items are counted by weight and guaranteed accurate within $\pm 2\%$.

Handling Charge: For orders less than \$10, there is a \$2 handling charge.

Insured Packages: All US Priority Mail & Express Mail packages are insured if the value is over \$50. All Foreign/Canada shipments with the Post Office are insured, regardless of their value.

UPS Ground/Residential are insured if the value is \$500 or more. UPS Collect shipments are always insured. All Foreign/Canada shipments are insured regardless of their value.

Certificates: There is a \$5 charge for each certificate.

Prices Effective September 17, 2018

Office Hours

Monday - Thursday:
7 a.m. to 4:15 p.m. (CST)

Friday:
7 a.m. to 12 p.m. (CST)

Contact Information

Phone Numbers: 800-944-1899 or 715-344-6081

Fax Numbers: 800-374-3021 or 715-344-3021

Shipping Address:
The Worth Company
214 Sherman Ave.
Stevens Point, WI 54481 USA



WIRE PRODUCTS DIVISION

P.O. BOX 88 • STEVENS POINT, WI 54481

(715) 344-6081 • FAX (715) 344-3021

SHIPPING ADDRESS: 214 SHERMAN AVE., STEVENS POINT, WI, USA 54481

Email: sales@worthco.com • Website: www.worthco.com

© 2018 Worth Company