











AIR CONDITIONING

Managing condensate



Pump selection chart

		Equipment						Location					
		Wall mounted	Cassette	Multi cassette	Conditioning cabinet	Floor standing	Ducted unit	Suspended ceiling unit	Inside the unit	Inside ducting	Wall mounted	Floor mounted	False ceiling
p.3	 OMEGA PACK	x									x		
p.3	 Si-20	x						x	x				
p.4	 DELTA PACK	x								x			
p.4	 Si-10 UNIVERS'L		x			x		x	x				x
p.5	 Si-30 Si-33	x				x		x					x
p.6	 Si-60				x	x	x		x				x
p.7	 Si-82			x	x			x				x	x
p.8	 SI 1805				x			x				x	x
p.8	 SI 1830			x	x		x	x	x			x	x
p.9	 SI 2052		x				x	x	x				
p.10	 PE5000 PE5100 PE5200	x	x										x

Actual flow rates

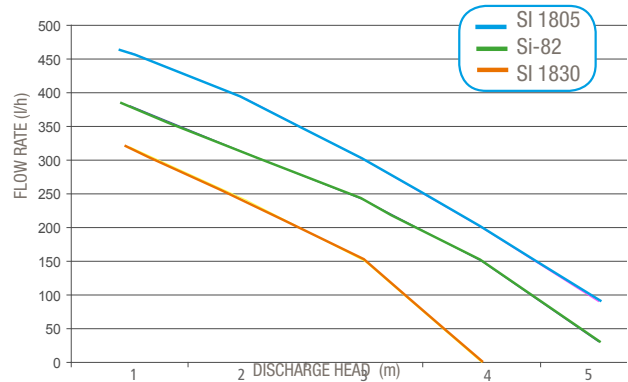
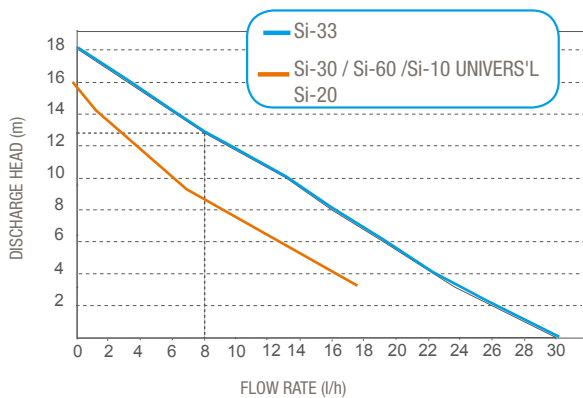

NEW

OMEGA PACK

The under the unit pack

For mini-split air conditioning

Ref : OP20CE01UN23



Easy installation

Complete installation kit with pre-mounted pieces.



Reliability

The Drain Safe Device included to prolong the life of the pump.



Operation level

Anti-vibration rubber dampers.



Installation video

Kit contents

Si-20 piston pump with detection unit (0.63 m cable), 2 anti-vibration rubber dampers, clear pvc tubing int. Ø 6 mm fitted with a drain safe device - Power cable 1.5m (2 power wires, 2 safety wires)- Shell (2-part: backplate & cover) - Screws & plugs for affixing backplate 90° rubber elbow Ø int.15 mm x L 152 mm - Vent tube - 3 Double Wire Clamps - 3 Tie Wraps.

Si-20

Piston pump

For wall mounted and floor standing units

Ref : SI20CE01UN23

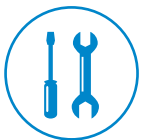

Easy installation

Slim design. Rubber damper : allows the pump to be put directly inside the unit.

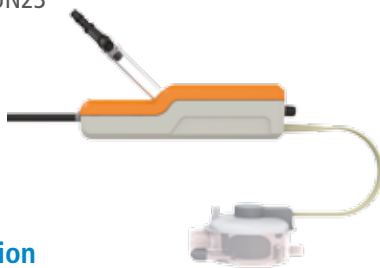

Installation video



NEW

Technical specifications

	Si-20
Maximum flow-rate	20 l/h
Maximum discharge head	10 m (flow rate= 4 l/h)
Pump sound level @ 1 m	22 dBA
Detection levels (mm)	ON : 16, OFF: 11, Safety : 19
Mains supply	230 V ~ 50 Hz 14 W
Thermal protection	115°C (auto-reset)
Protection	IP20

*To EN ISO 3744. LNE measurement, on pump running with water, out of application.

DELTA PACK

Piston pump and trunking system

For wall-mounted air-conditioning units

Ref : 80X50 mm white RAL 9010 : DP10CE01UN23
 80x60 mm cream RAL 9001 : DP10CE02UN23
 80x60 mm white RAL 9003 : DP10CE04UN23 NEW



Complete system

Pump and trunking kit for a quick and easy solution.



Multiple choice

80x50mm or 80x60mm, white or cream. Can be mounted to either side of the air conditioning unit.



Operation level

High energy absorbing foam inside the elbow, anti-vibration insulation.



Installation video

Kit contents : Si-10 UNIVERS'L pump – 1 m long discharge pipe with foam insulation and "Drain-Safe Device" connector - Lockable, plug-in 1.5 m cable with NC safety contact wire – 2-part elbow (base and cover) – 750 mm duct with Elbow/Duct and Elbow/Split joiners - Ceiling fitting - 0.5 m long flexible hose for connection to split - Vent pipe - 6 fixing plugs and screws - 2 hose clips.

SI-10 UNIVERS'L

Replacement pump for trunking corner pieces

For wall-mounted air-conditioning units

Ref : SI10CE03UN23



Universal

Replacement pump for the majority of pump in trunking systems.



Technical specifications

	SI- 10 UNIVERS'L
Maximum flow-rate	20 l/h
Maximum discharge head	10 m (flow rate= 4 l/h)
Pump sound level @ 1 m	22 dBA
Detection levels (mm)	ON: 16, OFF: 11, Safety : 19
Mains supply	230 V ~ 50 Hz 14 W
Thermal protection	115°C (auto-reset)
Protection	IPX4

*at 1m according to EN ISO3744

Si-30 / Si-33

Mini pumps with float detection

For air conditioning systems

Ref : SI30 : SI30CE01UN23 / Si-33 : SI33CE01UN23



Manufactured for purpose

Patented pump technology designed for discharging contaminated condensates produced by air-conditioning systems. 100% operating cycle.



Reliable

No risk of siphoning, due to the pre-installed Drain-Safe Device.



Versatile installation

Mounting bracket gives the installer flexibility when siting the pump and can be fixed to the wall, pipework or ceiling suspended



Installation video

Kit contents : Pump - Transparent PVC tube int. Ø 6 mm L 1 m, fitted with "Drain-Safe Device" connector - Anti-vibration mounting bracket - Lockable, plug-in 1.5 m cable with NC safety contact wire - 6 cable ties - **For Si-30 / Si-33 :** Detection block with floats - 90° connector int. Ø 15 mm x L 60 mm, vent pipe, mounting rail, adhesive. **For Si-30 Detect+ :** mounting bracket - straight connector - 1,5 m extension cable - rubber elbow 90° Øint.15 x L 152mm - vent tube Ø int 6 x L 75 mm - 2 self drilling screws + 2 anchors

Si-30 Detect+

Condensate removal pump with electronic detection unit

For air conditioning systems

Ref : SI30CE04UN23



Patented detection unit with probes : low maintenance and high reliability



Easy installation



Technical specifications

	Si-30	Si-33
Maximum flow-rate	20 l/h	30 l/h
Maximum suction height	3 m	4 m
Maximum discharge head	10 m (flow rate = 4 l/h)	> 13 m (flow rate = 8 l/h)
Pump sound level @ 1 m	20 dBA	34 dBA
Detection levels (mm)	ON : 16, OFF: 11, Safety : 19	
Mains supply	230 V ~ 50 Hz 14 W	230 V ~ 50 Hz 21 W
Protection	IP20	

*To EN ISO 3744. LNE measurement, on pump running with water, out of application.

Si-30 : can replace SI3080, SI3100, SI3200

Si-33 : can replace SI1730

Si-60

Piston pump with 0.5 L tank

For ducted air conditioning systems

Ref : SI60CE01UN23



Lockable cable

Twist lock power cable for a secure connection



Innovative detection

Intergrated float detection system reliable in all types of environment.



Multi Purpose

Top and bottom inlet. Can be semi-submersed in a condensate drain pan.



Kit contents

Pump - Lockable, plug-in 1.5 m cable with NC safety contact wire - Installation kit: adapter int. Ø 15-20-24-32-40 mm, rubber 90° connector int. Ø 15 mm × L 60 mm, plastic 90° connector for 6 mm int. Ø flexible tube, 1 off 2.5 × 100 mm cable tie.

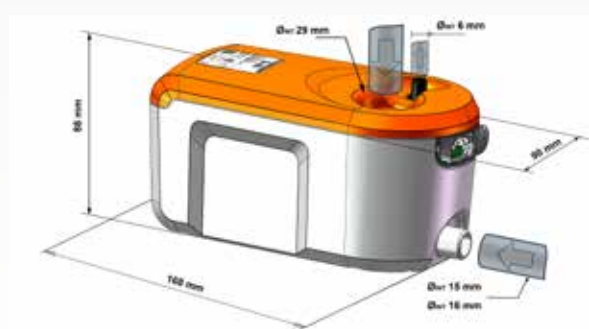

Technical specifications

	Si-60
Maximum flow-rate	20 l/h
Maximum discharge head	10 m (flow rate = 4 l/h)
Pump sound level @ 1 m	< 38 dBA
Detection levels (mm)	ON : 28, OFF : 24, Safety : 35
Mains supply	230 V ~ 50 Hz 14 W
Protection	IPX4

* To EN ISO 3744. LNE measurement, on pump running with water, out of application.

Si-82

Centrifugal pump with 2 l tank

For cassette and fan coil air-conditioning systems.

Ref : SI82CE01UN23



Plug in power cable

Easy to maintain and replace.



Versatile installation

Provides installer flexibility when fitting the pump. Can be fixed to the wall, flat surface or ceiling suspended.



Easy hydraulic connection

4 inlet holes Ø 30 mm. Reversible tank.



Kit contents

One-piece centrifugal pump - Tank (2 l) - Built-in 10 mm ext. Ø non-return valve - Plug-in cable: power (2 m, European IEC socket) and safety contact (1.5 m, bared wires) – Straight connector ext. Ø 10 mm / ext. Ø 6 mm; 2 plugs + 2 screws.

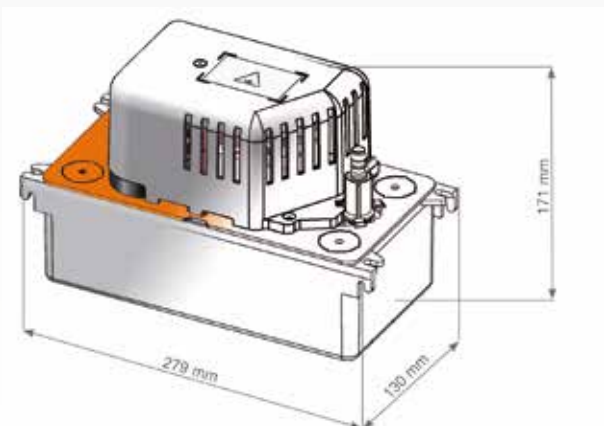

Technical specifications

	Si-82
Maximum flow-rate	500 l/h
Maximum discharge head	5 m (flow rate 50l/h)
Pump sound level @ 1 m	< 45 dBA
Detection levels (mm)	ON : 53, OFF : 42, Safety: 64
Mains supply	230 V ~ 50/60 Hz - 70 W
Protection	IP20

* To EN ISO 3744. LNE measurement, on pump running with water, out of application.

SI 1805 / SI 1830

Centrifugal pumps with 0.5 l tank

For cassette and fan coil air-conditioning systems

Ref : SI 1805 : SI1805SIUN23
SI 1830 : SI1830SCUN23

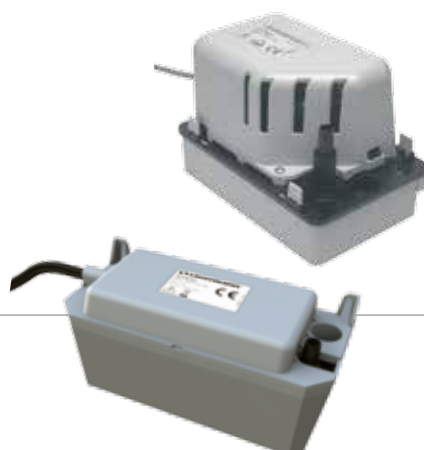

High performance

Capable of discharging high volume of condensates evacuated per hour.

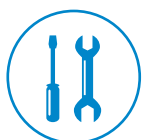

Compact

Compact design that can be sited in confined spaces.



Installation in any location

SI 1805 : compact design
SI 1830 : can be installed without the tank.



Kit contents

SI 1805 : Pump - 2 screws - 2 plugs – Power cable: 2 m, European IEC plug; safety contact cable: 1 m, 2 wires (NC contact).

SI 1830 : Pump with 0.5 l tank – Power cable: 1.5 m, European IEC plug; safety contact cable: 1 m, 2 wires (NC contact) - Installation kit: 2 screws + 2 plugs, 5 m of transparent PVC hose 10 mm int. Ø, flexible adapter 15-24-32-40 mm Ø.

Dimensions

SI 1805 : L 195 x W 130 x H 132 mm
SI 1830 : L 190 x W 80 x H 100 mm

Technical specifications

	SI 1805	SI 1830
Maximum flow-rate	500 l/h	400 l/h
Maximum discharge head	5,4m	3,7 m
Pump sound level @ 1 m	≤ 47 dBA	≤ 43 dBA
Detection levels (mm)	ON : 27, OFF : 21, Safety : 32	ON : 32, OFF : 25, Safety : 39
Mains supply	230 V~ 50/60 Hz -90 W	230 V~ 50/60 Hz -75 W
Protection	IP20	IPX4

* To EN ISO 3744. LNE measurement, on pump running with water, out of application.

SI-2052

Centrifugal lift pump

For cassette air conditioning systems

Ref : SI2052SIUN23

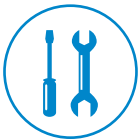

Replacement

Can be used as a replacement pump for most cassette systems.



Kit contents

Centrifugal pump – 250 mm overmoulded cable – 850 mm cable with hard-wired connector - Detector (DET01550, 900 mm cable) + stainless-steel fixing screw.

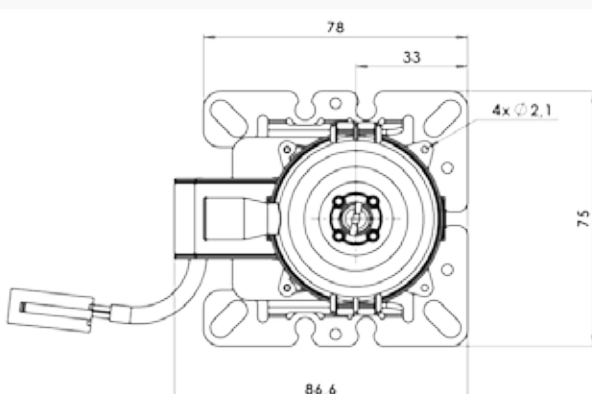

Technical specifications

	SI 2052
Maximum flow-rate	100 l/h at 200mm
Maximum discharge head	0.9 m (24l/h)
Pump sound level @ 1 m	≤ 30 dBA
Detection levels (mm)	Safety : 18
Mains supply	230 V ~ 50/60 Hz - 14 W

* To EN ISO 3744. LNE measurement, on pump running with water, out of application.

PE 5000 / PE 5100 PE 5200

Peristaltic pumps

For air conditioning applications up to 8 kW

Ref : PE5000 : PE5000SIUN23

PE5100 : PE5100SIUN23

PE5200 : PE5200SIUN23



PE 5000



PE 5100



PE 5200



Easy maintenance

Quick fit replacement head and tubes.



3 detection systems

PE 5000 : compressor signal

PE 5100 : temperature differential sensors

PE 5200 : float detection unit

Kit contents

Pump - Cable: 1.7 m, including 2 wires for power supply (P &N), 1 wire for compressor signal - Easy «1 screw» sliding plastic bracket - Ø 15 mm to Ø 6 mm adaptor + pale yellow rubber Ø 15 x 35mm (PE5003)

Additional kit for PE 5100 : 2 thermal probes with 3.5m cable: Red cap for ambient air. Blue cap for fresh air.

Additional kit for PE 5200 : detection unit (SI2958, 1.5m cable) - Detection unit installation kit : Pale yellow rubber (Ø 15 x 35mm). Vent tube Øint 4 x L 75 mm. Mounting rail. Adhesive.

Technical specifications

	PE 5000 / PE 5100 / PE 5200
Maximum flow-rate	6 l/h
Maximum discharge head	2 m
Pump sound level @ 1 m	≤ 30 dBA
Detection levels (mm)	ON : 16, OFF: 11, Safety: 19
Mains supply	230 V~ 50/60 Hz -75 W
Protection	IPX4

* To EN ISO 3744. LNE measurement, on pump running with water, out of application.

ACCESSORIES

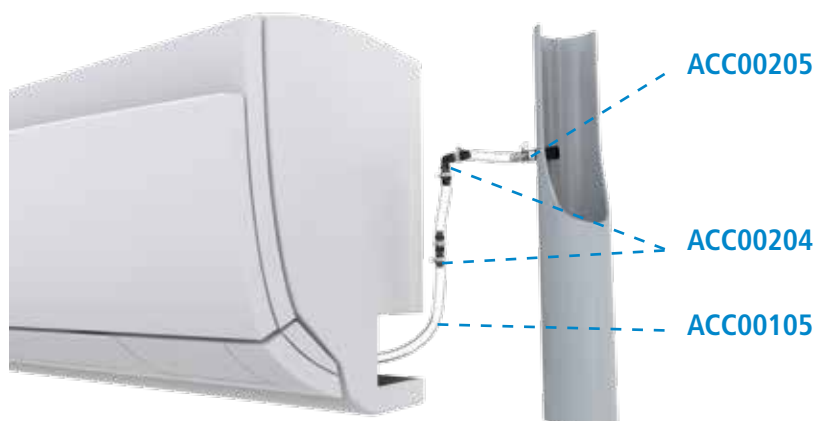

Pump Discharge Hoses



Pump Discharge Hose Ø 6 mm

ACC00105 : 5 m - ACC00150 : 50 m - ACC00151 : reinforced, 50 m
Clear PVC tubing for connecting the pump to the discharge outlet i.d. 6 mm (1/4")



Pump Discharge Hose Ø 10 mm

ACC00125 : 25 m - ACC00126 : reinforced, 25 m
Clear PVC tubing for connecting the pump to the discharge outlet i.d. 10 mm (3/8")

Connectors



Straight and elbow connectors

ACC00204 : for Ø 6 mm hose - ACC00213 : for Ø 10 mm hose

Straight and elbow connectors for connecting hoses together. 5 straight, and 5 elbow connector pieces per package. 10 pieces (ACC00204, 5 x elbow , 5 x straight connectors) - 5 pieces (ACC00213, straight)



«T» Connector

ACC00211 : Ø 6 mm

To make the connection between 3 tubes. For tubes Ø 6 mm int. (1/4 ")
5 pieces



Self Sealing Fittings

ACC00205 : for use with Ø 6 mm tubing. - ACC00215 : for use with Ø 10 mm tubing.

Self sealing fittings for condensate discharge tubing.

6 pieces (ACC00205) - 3 pieces (ACC00215)

Spare Parts



Detection unit

SI2958-003

For replacing the detection unit when necessary

Inlet : Ø 15mm int. Outlet : Ø 6 mm int. (1/4"). For pumps with detection unit.



Non-return valve

ACC00801

For replacing the non-return valve when necessary in Si-82, SI 1805, SI 1830.



Replacement tube

PE5002

Replacement tube of the peristaltic pumps.

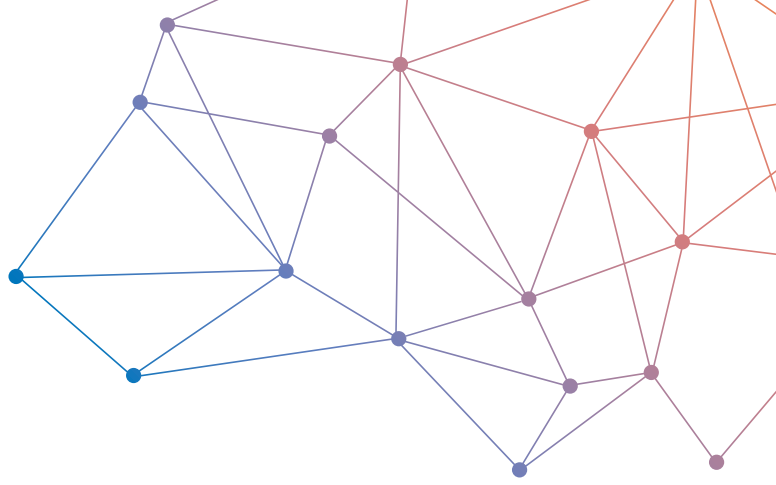

DOCEN000



For any further information:
www.sauermann.co.uk



Sauermann UK Ltd.
Trident Business Park
7-9 Amy Johnson Way,
Blackpool : England / FY4 2RP

Tel : (+44)1253 340170
Fax : (+44) 1253 340179
E. info.uk@sauermanngroup.com