

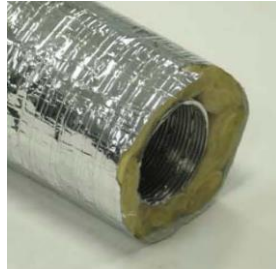

Supply and Sound Attenuator Duct



UPC-26C



UPC-25

IL009048.002

Model Key

Unico Part Code	Type	Rev.	Insulation	-	Qty
UPC-	26	C	R4	-	6

Available Models

Size	Description	Model Number	R-Factor
2-inch (50 mm)	Aluminum Duct (supply tubing)	UPC-25	R-3.3
		UPC-25R4	R-4.2
		UPC-25R6	R-6.0
		UPC-25R8	R-8.0
	Sound Attenuator -single vapor barrier	UPC-26C	R-3.3
		UPC-26CR4	R-4.2
	Sound Attenuator, -double vapor barrier	UPC-26DR4	R-4.2
		UPC-26CR6	R-6.0
2.5-inch (63 mm)	Aluminum Duct (supply tubing)	UPC-225	R-3.3
		UPC-225R4	R-4.2
		UPC-225R6	R-6.0
		UPC-225R8	R-8.0
	Sound Attenuator -single vapor barrier	UPC-226C	R-3.3
		UPC-226CR4	R-4.2
	Sound Attenuator, -double vapor barrier	UPC-226DR4	R-4.2
		UPC-226CR6	R-6.0
UPC-226CR8	R-8.0		

APPLICATION

The Unico sound attenuator significantly reduces sound from the outlets. The aluminum supply tubing does not. Therefore, for proper noise control, it is recommended to use at least 3 feet (1 m) of the sound attenuator at the end of every supply branch run. Optionally, the entire branch duct can be made of one or more lengths of the sound attenuator. For long duct runs, the aluminum core tubing is stronger than the sound attenuator core and is best to construct the branch duct using almost all aluminum supply tubing with a 3-foot (0.9 m) length of sound attenuator at the end (See Figure 1).

Where runs are required to be installed in unconditioned spaces every attempt should be made to limit the length of the duct run to 12-feet or less using the proper R-factor for the application. However, as an air duct, there is no limit to the length used other than its ability to deliver the air.

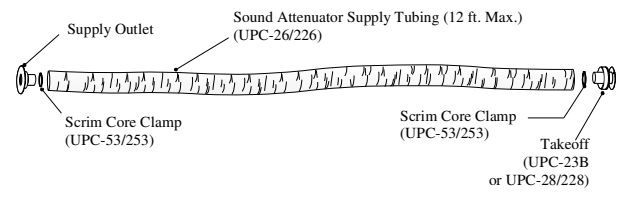

Method A (for 6 to 12 ft. runs)

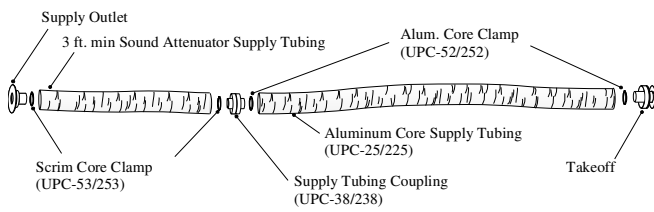

Method B (for 6 to 50 ft. runs)

IL00111a.ev

GENERAL

The aluminum supply tubing and sound attenuator are insulated flexible air ducts. It comes in two sizes and four different insulation thicknesses.

If the duct is located inside the conditioned building envelope, use the standard insulation which is designed to prevent condensation due to the cold air during cooling. For locations outside the conditioned envelope use a higher R-factor appropriate to meet the local codes.

Note: The sound attenuator has a porous liner. Some local codes such as Florida and California, require that the duct has a double vapor barrier.

Figure 1. Connection methods

CONSTRUCTION

The aluminum supply tubing is supplied in 25-foot (7.7-m) lengths while the sound attenuator tubing is supplied in 12-foot lengths. Both the aluminum and sound attenuator tubing can be cut as needed. As shown in Figure 2, both the standard and R-4 models have 3 components.

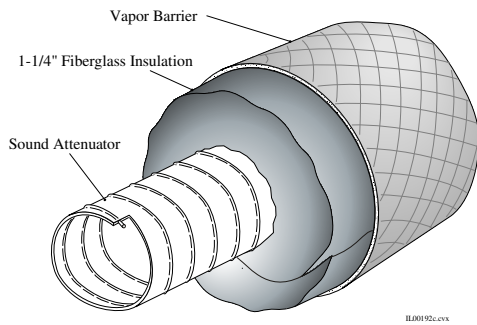

Figure 2. Typical tubing construction

The inner layer/core is made of two-ply corrugated aluminum for the supply tubing or spun bound nylon for the sound attenuator. The outer jacket for both models are made of two-ply reinforced reflective Mylar™; providing a vapor seal to prevent leakage and moisture migration, and increases the insulation factor by reducing the radiant heat transfer. The fiberglass blanket insulation fills the void between the jacket and core of the tube.

The standard and the R-4 duct have one insulation layer and vapor barrier on the UPC-26/226C and the UPC-25/225. The R6 and R8 ducts as well as the UPC-26/226D ducts have two layers of insulation and two double vapor barrier seals for both supply and sound attenuator tubing. The Fiberglass insulation for the R4, R6, and R8 ducts are 1-1/4" thick.

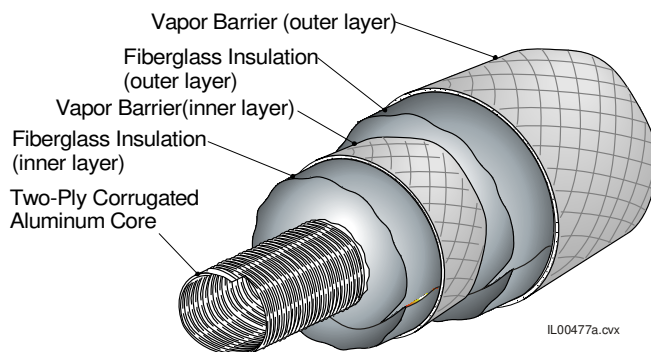

Figure 3. Typical tubing construction with double vapor barrier

DUCT HEAT GAIN/LOSS

Whenever a duct is installed in an unconditioned space, the heat gain and loss calculations must include duct loss. These are based on both thermal losses and losses due to leakage for a typical installation.

The R-factor is calculated per the Air Diffusion Council (ADC) Flexible Duct Standard. This code assumes that the duct wall is flat. This assumption works well for conventional ducts because the duct radius is usually quite large. However, for small ducts, assuming the duct wall is flat overestimates the thermal losses. Therefore, the R-factor specified for a small duct may be less than the value required for a conventional duct. This is described as an equivalent R-factor in Table 1 and is further explained in the International Code Council evaluation report (PMG-1002) http://www.icc-es-pmg.org/Listing_Directory/pdf/PMG-1002.pdf.

NOISE LEVEL

Noise level is directly related to outlet air velocity. In general, lower velocity means lower noise levels; therefore, it is easy to reduce noise by adding more outlets. Refer to Table 4 as a guide in designing a duct layout that will meet your specific sound level requirements.

MODEL SPECIFICATIONS

Certifications:	UL Standard 181 Flexible Air Ducts Canadian Standard CAN/ULC-S110 UK Standard BS-476-6 & 7
Classification:	Air Duct per UL Standard 181 Air Duct per CAN/ULC-S110
Smoke Developed Rating:	less than 50
Flame Spread Index:	less than 25
Inside Diameter:	Model UPC-25/26: 2.0 inch (50 mm) Model UPC-225/226: 2.5 inch (63 mm)
Outside Diameter:	See Tables 2 and 3
Duct Material:	Two-ply corrugated aluminum Spun Bound Nylon
Filter Particle Size:	5 microns
Insulation:	Fiberglass
Vapor Barrier:	Reinforced Aluminized Mylar
Min. Pressure:	negative 0.5-inch w.c. (125 Pa)
Max. Pressure:	4.0 inches w.c. (1000 Pa)
Max. Velocity:	5000 ft/min (25 m/s)
Min. Length:	3 ft (1 m) <i>sound attenuator</i>
Max Length:	see figures 5, 6, 7
Support Distance:	every 6-ft (2 m)
Min. Inside Bend Radius:	6 inch (150 mm)
R-Factor:	See Tables 2 and 3

Table 2. Duct R-Factor (Imperial)

Model	Outside Dia., Inch	R-factor ft ² ·°F·hr/Btu	
		Rated*	Effective**
UPC-26C	3.5	3.3	4.0
UPC-26C-R4	4.0	4.2	5.8
UPC-26D-R4	4.0	4.2	5.8
UPC-26C-R6	5.0	6.0	9.5
UPC-26C-R8	6.0	8.0	13.7
UPC-226	4.0	3.3	3.9
UPC-226-R4	4.5	4.2	5.5
UPC-226D-R4	4.5	4.2	5.5
UPC-226-R6	5.5	6.0	9.0
UPC-226-R8	6.5	8.0	12.9

* per ADC Flexible Duct Standard, based on flat thickness, k=24 Btu-in/h·ft²·°F
 ** per ASHARE 2001 Fundamentals Handbook p. 23.21, based on curved thickness
 Note: Data at 15 ft duct length at 120°F

Table 3. Duct R-Factor (Metric)

Model	Outside Dia, mm	R-factor m ² ·K/W	
		Rated*	Effective**
UPC-26C	89	0.58	0.70
UPC-26CR4	102	0.74	1.02
UPC-26DR4	102	0.74	1.02
UPC-26CR6	127	1.06	1.67
UPC-26CR8	152	1.41	2.41
UPC-226	102	0.58	0.68
UPC-226-R4	114	0.74	0.97
UPC-226D-R4	114	0.74	0.97
UPC-226-R6	140	1.06	1.59
UPC-226-R8	165	1.41	2.27

* per ADC Flexible Duct Standard, based on flat thickness, k=24 Btu-in/h·ft²·°F
 ** per ASHARE 2001 Fundamentals Handbook p. 23.21, based on curved thickness
 Note: Data at 15 ft duct length at 120°F

Table 4. Unico System Sound Level Recommendations

Sound Level	Approx. dB(A)	2-inch Outlet		2 ½ inch Outlet		Recommended Application
		CFM	Outlet/Ton*	CFM	Outlet/Ton*	
Ultra Low	25	14	14	17	12	Multimedia Rooms
Very Low	27	19	11	23	9	Rooms with Hard Surfaces (wood or concrete floors and walls)
Low**	29	30	7	36	6	Rooms with Carpet, Drapes, Furniture
Normal	32	40	5	50	4	Large Rooms or Where Sound is not Critical (min. number of outlets)
Excessive	35	50+	4	60+	3	Industrial Environments

* The number of outlets presume that the total airflow meets the minimum required by the air handler
 ** Recommended
 - Outlets/Ton is based on minimum rated airflow of 200 CFM per nominal ton
 - dB(A) is A-weighted Sound Pressure level measured 3ft (1m) from outlet in a reverberant room 20 x 30 ft.

NOTE: The actual sound levels measured in a room will vary depending on how the duct was installed (bends, wrinkles, outlet design) and the room environment (carpeted, draperies, etc.). Also, the overall sound in the room depends on the number of outlets in that room.

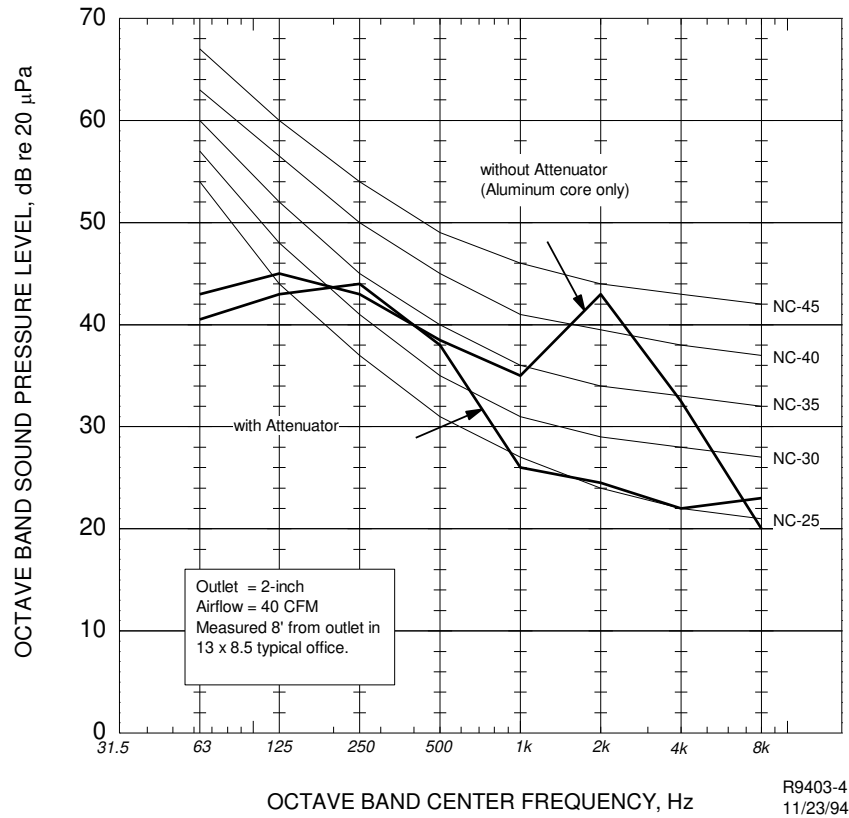

Figure 4. Sound pressure level of aluminum ducting with and without attenuation

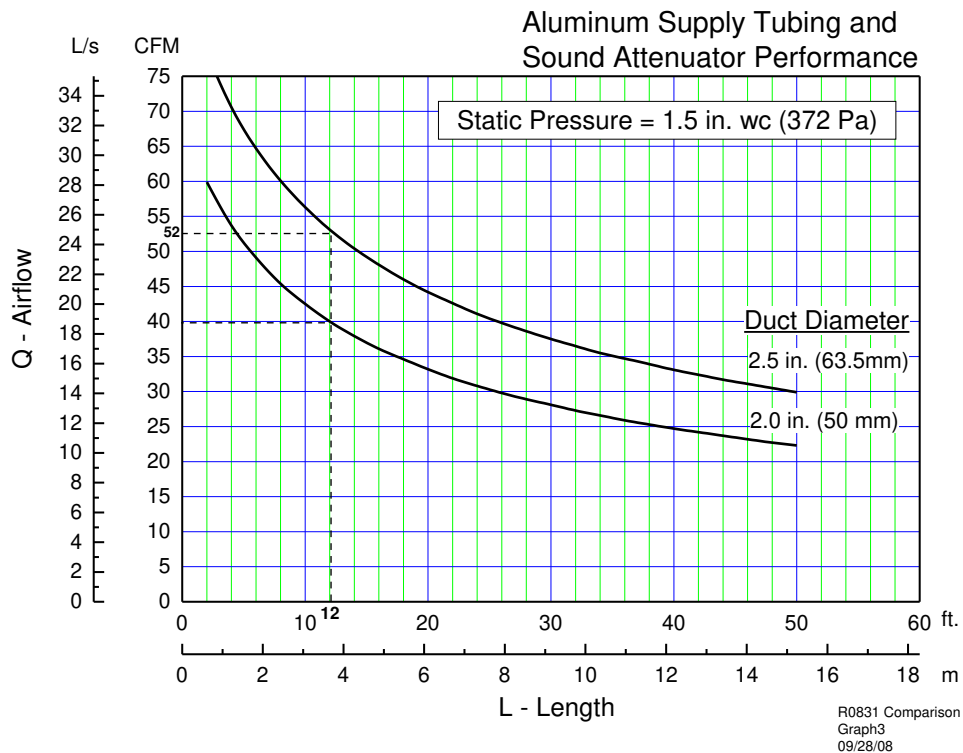

Figure 5. Comparison of airflow along length of 2-inch and 2.5-inch ducts

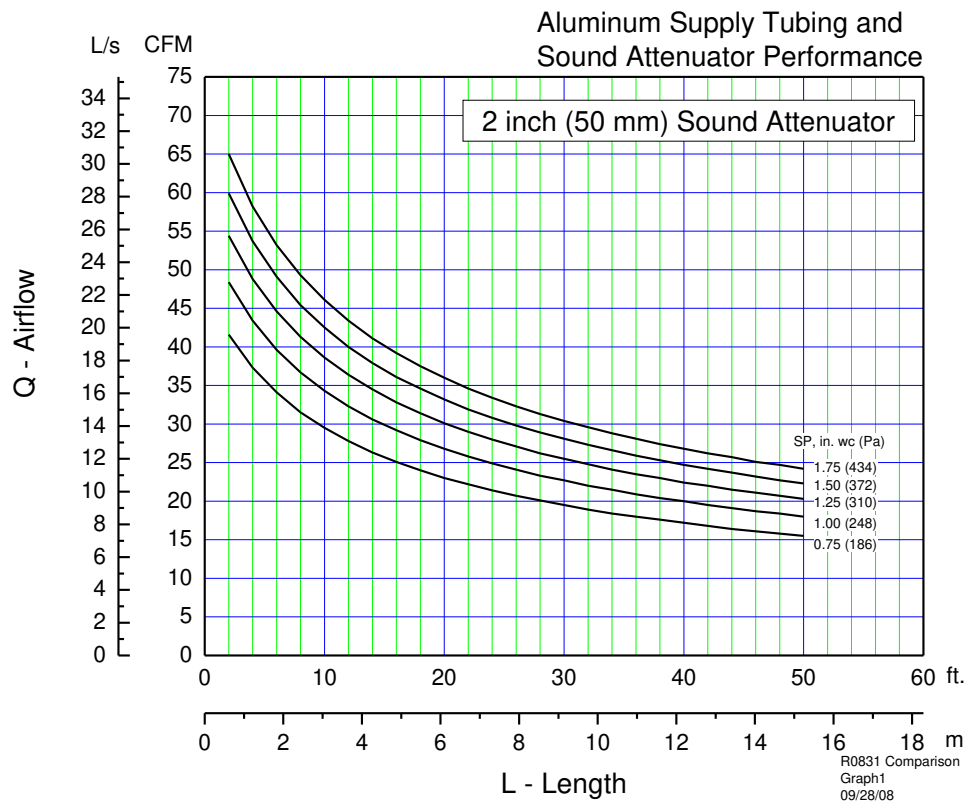

Figure 6. Variation in airflow along length of 2-inch duct at multiple static pressures

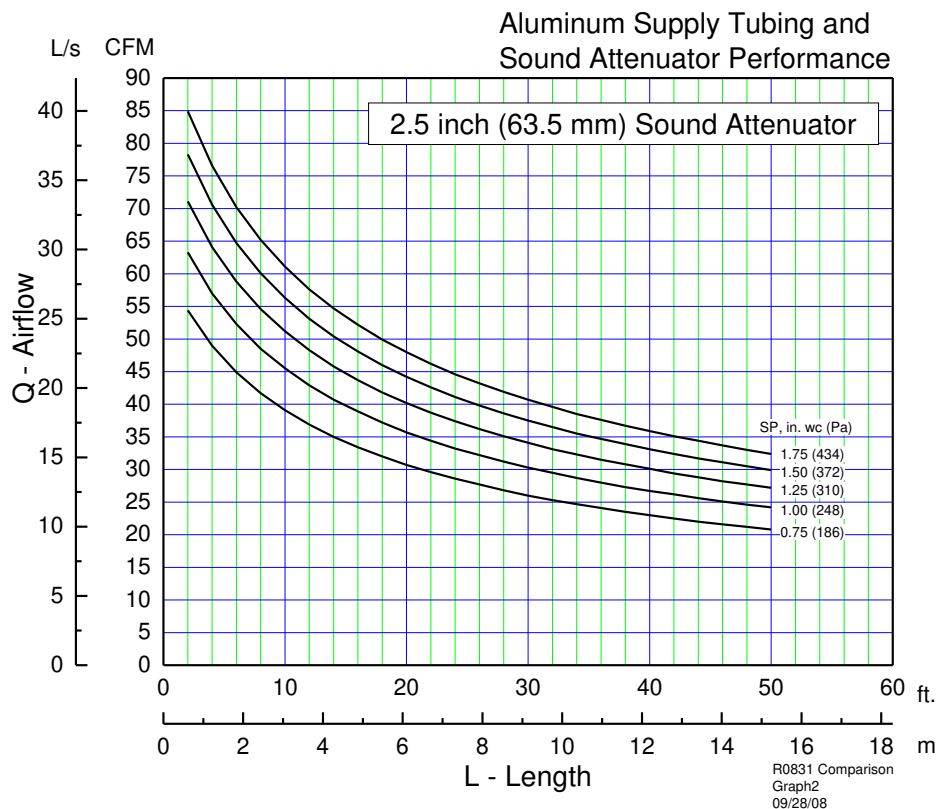

Figure 7. Variation in airflow along length of 2.5-inch duct at multiple static pressures