

LIFE INSTRUMENTS®



**ORTHOPEDIC
INSTRUMENTS**



Life Instruments are handcrafted from the highest quality materials. They are perfectly balanced for excellent feel and ease of use. They are an extension of the surgeon's hand.

We have the ability to customize and modify instruments to fit the surgeon's individual needs. We provide an ongoing development of new products in cooperation with surgeons and healthcare professionals.

With over 45 years in orthopedic surgical instruments, we welcome inquiries for products not found in this catalog. We are proud to continue the Life Instrument tradition of quality and service.

TABLE OF CONTENTS

CURETTES	1
ELEVATORS	3
RONGEURS	6
RETRACTORS	12
SELF-RETAINING RETRACTORS	19
RETRACTORS	21
OSTEOTOMES, GOUGES & CHISELS	23
MALLETS & TAMPS	28
RADIOLUCENT INSTRUMENTS	30
SUCTION TUBES	32
OTHER	33



LONG HANDLE CURETTES

STRAIGHT

15" overall length 9" handle 380mm 230mm handle

SIZE	STRAIGHT	ANGLED	REV. ANGLED
3/0	710-1530-0	710-1530-1	710-1530-2
2/0	710-1520-0	710-1520-1	710-1520-2
0	710-1500-0	710-1500-1	710-1500-2
1	710-1501-0	710-1501-1	710-1501-2
2	710-1502-0	710-1502-1	710-1502-2
3	710-1503-0	710-1503-1	710-1503-2
4	710-1504-0	710-1504-1	710-1504-2
5	710-1505-0	710-1505-1	710-1505-2
6	710-1506-0	710-1506-1	710-1506-2
7	710-1507-0	710-1507-1	710-1507-2

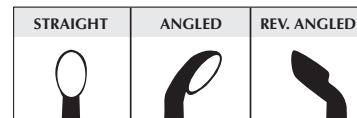

Also available in 13" length 7" handle and 15" length 7" handle. See www.lifeinstruments.com for details.

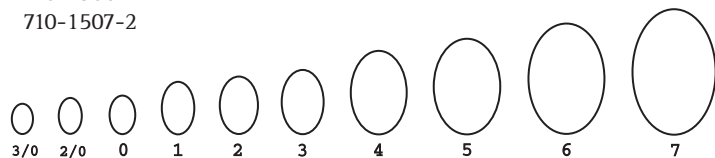

O'BRIEN CURETTE

15" overall length 9" handle 380mm 230mm handle

8mm	719-1508-0
11mm	719-1511-0



CHARNLEY CURETTE

15" overall length 9" handle 380mm 230mm handle

Small	719-1501-0
Large	719-1502-0

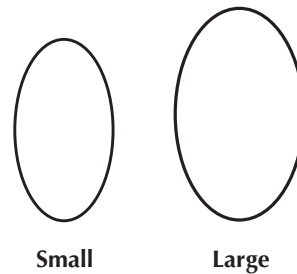

COUTTS SCOOP

15" overall length 380mm

716-1504-1	Angled Right #4
716-1504-2	Angled Left #4

CURETTES



TOOTHED LONG HANDLE CURETTE
 15" overall length 9" handle 380mm

SIZE

4	710-1504-0T
5	710-1505-0T
6	710-1506-0T
7	710-1507-0T



REVISION CURETTE
 21.5" overall length 545mm

SIZE

3	715-2153-1	ANGLED
4	715-2154-1	ANGLED
5	715-2155-1	ANGLED
6	715-2156-1	ANGLED



COBB CURETTES
 11" overall length 280mm

SIZE	STRAIGHT	ANGLED
4/0	811-1140-0	811-1140-1
3/0	811-1130-0	811-1130-1
2/0	811-1120-0	811-1120-1
0	811-1100-0	811-1100-1
1	811-1101-0	811-1101-1
2	811-1102-0	811-1102-1
3	811-1103-0	811-1103-1
4	811-1104-0	811-1104-1
5	811-1105-0	811-1105-1
6	811-1106-0	811-1106-1



LONG HANDLE COBB ELEVATORS

15" overall length 9" handle 380mm

SIZE	15" LENGTH	13" LENGTH
1/2"	720-1512-0	720-1312-0
5/8"	720-1558-0	720-1358-0
3/4"	720-1534-0	720-1334-0
1"	720-1510-0	720-1310-0
30mm	720-1530-0	720-1330-0

Custom lengths and widths available upon request.



SUCTION LONG HANDLE COBB ELEVATOR

15" overall length 9" handle

3/4"	720-1534-0-1L	Suction Left
3/4"	720-1534-0-1R	Suction Right



SMALL ELEVATOR

10" overall length 5" handle 250mm

1/4"	721-1025-0
3/8"	721-1038-0
1/2"	721-1012-0



Serrations

AUFRANC ELEVATOR

10" overall length 250mm

724-1012-0

ELEVATORS



JACK ELEVATOR
11" overall length Blunt 1" width

723-1101-0



LONG PENFIELD #2

PENFIELD DISSECTORS
8.5" overall length 215mm

SIZE	
#2	725-8028-0
#3	725-8038-0
#4	725-8044-0
3mm #4	725-8043-0

10.5" overall length 265mm

SIZE	
#2	725-1028-0
#3	725-1038-0
#4	725-1054-0

All penfields have black knurled handle for better feel and control.



7.5 mm

MICRO COBB ELEVATORS
8.5" overall length 215mm

SIZE	
3mm	722-8030-0
4mm	722-8040-0
7.5mm	722-8075-0
<i>Available upon request</i>	
2mm	722-8020-0

Excellent for dissecting the ligamentum flavum.



CURVED CHISEL & ELEVATOR
7 3/4" overall length 195mm

726-7345-1

Excellent for removing tissue on bone grafts.



FREER ELEVATOR
7.5" double ended 190mm

4mm 726-7514-0



COBB ELEVATOR
11" overall length 280mm 9" overall length 230mm

SIZE	11" LENGTH
1/4"	821-1114-0
3/8"	821-1138-0
1/2"	821-1112-0
3/4"	821-1134-0
1"	821-1101-0

SIZE	9" LENGTH
1/4"	821-9114-0
1/2"	821-9112-0
3/4"	821-9134-0



KEY PERIOSTEAL ELEVATOR

SIZE	LENGTH	
1/8"	6.34"	822-6718-0
1/4"	6.34"	822-6714-0
3/8"	7.5"	822-7538-0
1/2"	7.5"	822-7512-0
5/8"	7.5"	822-7558-0
3/4"	8"	822-0834-0
1"	8"	822-0801-0



LANGENBECK ELEVATOR
9" overall length 230mm

728-9016-0

RONGEURS

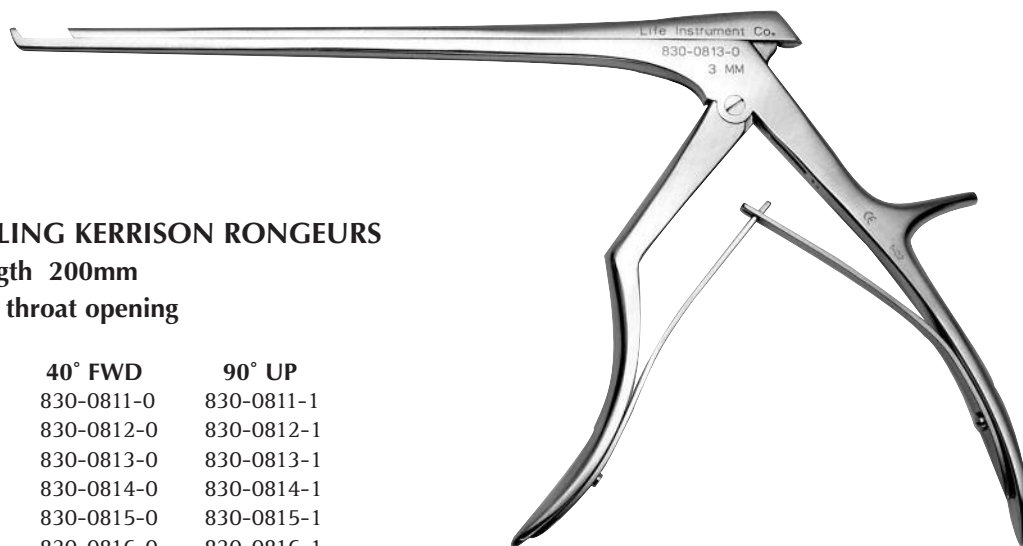

SPURLING KERRISON RONGEURS

8" length 200mm

15mm throat opening

SIZE	40° FWD	90° UP
1mm	830-0811-0	830-0811-1
2mm	830-0812-0	830-0812-1
3mm	830-0813-0	830-0813-1
4mm	830-0814-0	830-0814-1
5mm	830-0815-0	830-0815-1
6mm	830-0816-0	830-0816-1

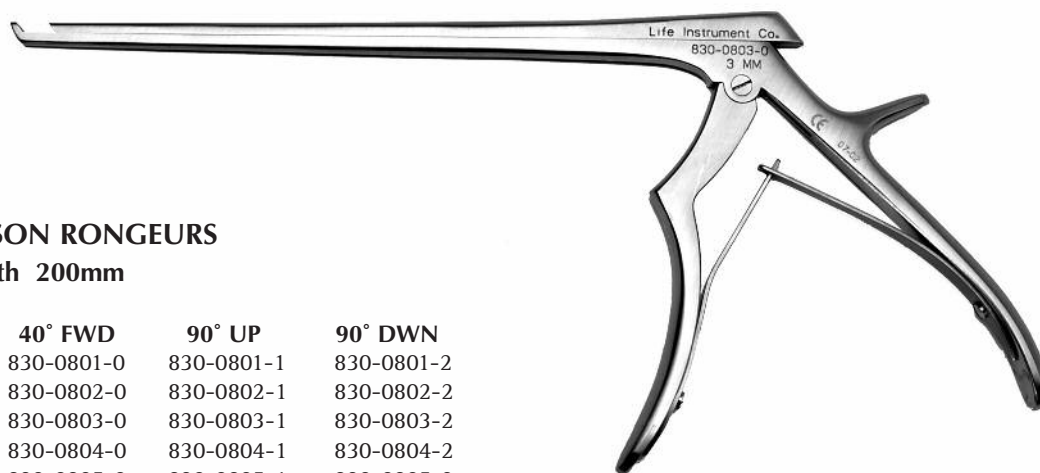

KERRISON RONGEURS

8" length 200mm

SIZE	40° FWD	90° UP	90° DWN
1mm	830-0801-0	830-0801-1	830-0801-2
2mm	830-0802-0	830-0802-1	830-0802-2
3mm	830-0803-0	830-0803-1	830-0803-2
4mm	830-0804-0	830-0804-1	830-0804-2
5mm	830-0805-0	830-0805-1	830-0805-2
6mm	830-0806-0	830-0806-1	830-0806-2

10" length 250mm

SIZE	40° FWD	90° UP	90° DWN
1mm	830-1001-0	830-1001-1	830-1001-2
2mm	830-1002-0	830-1002-1	830-1002-2
3mm	830-1003-0	830-1003-1	830-1003-2
4mm	830-1004-0	830-1004-1	830-1004-2
5mm	830-1005-0	830-1005-1	830-1005-2
6mm	830-1006-0	830-1006-1	830-1006-2

12" length 300mm

SIZE	40° FWD	90° UP	90° DWN
2mm	830-1202-0	830-1202-1	830-1202-2
3mm	830-1203-0	830-1203-1	830-1203-2
4mm	830-1204-0	830-1204-1	830-1204-2
5mm	830-1205-0	830-1205-1	830-1205-2
6mm	830-1206-0	830-1206-1	830-1206-2

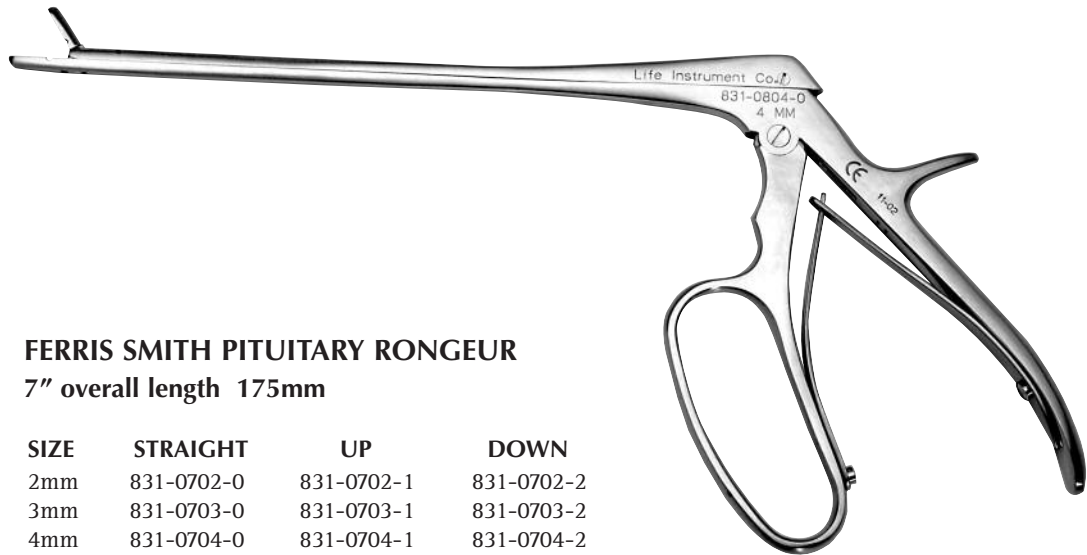

FERRIS SMITH PITUITARY RONGEUR

7" overall length 175mm

SIZE	STRAIGHT	UP	DOWN
2mm	831-0702-0	831-0702-1	831-0702-2
3mm	831-0703-0	831-0703-1	831-0703-2
4mm	831-0704-0	831-0704-1	831-0704-2
5mm	831-0705-0	831-0705-1	831-0705-2

8" overall length 200mm

SIZE	STRAIGHT	UP	DOWN
2mm	831-0802-0	831-0802-1	831-0802-2
3mm	831-0803-0	831-0803-1	831-0803-2
4mm	831-0804-0	831-0804-1	831-0804-2
5mm	831-0805-0	831-0805-1	831-0805-2

10" overall length 250mm

SIZE	STRAIGHT	UP	DOWN
2mm	831-1002-0	831-1002-1	831-1002-2
3mm	831-1003-0	831-1003-1	831-1003-2
4mm	831-1004-0	831-1004-1	831-1004-2
5mm	831-1005-0	831-1005-1	831-1005-2
6mm	831-1006-0	831-1006-1	831-1006-2

12" overall length 300mm

SIZE	STRAIGHT	UP	DOWN
2mm	831-1202-0	831-1202-1	831-1202-2
3mm	831-1203-0	831-1203-1	831-1203-2
4mm	831-1204-0	831-1204-1	831-1204-2
5mm	831-1205-0	831-1205-1	831-1205-2
6mm	831-1206-0	831-1206-1	831-1206-2

RONGEURS

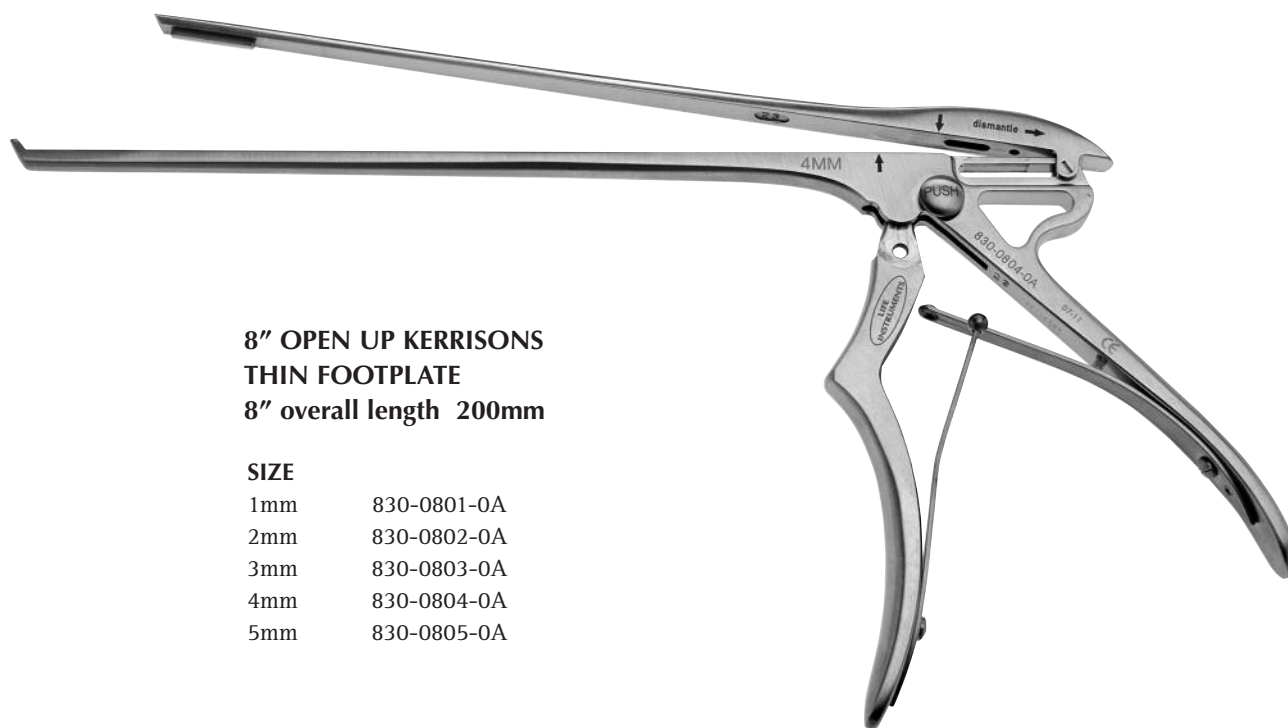

**8" OPEN UP KERRISONS
THIN FOOTPLATE
8" overall length 200mm**

SIZE

1mm	830-0801-0A
2mm	830-0802-0A
3mm	830-0803-0A
4mm	830-0804-0A
5mm	830-0805-0A

Easy to Disassemble • Great for Cleaning

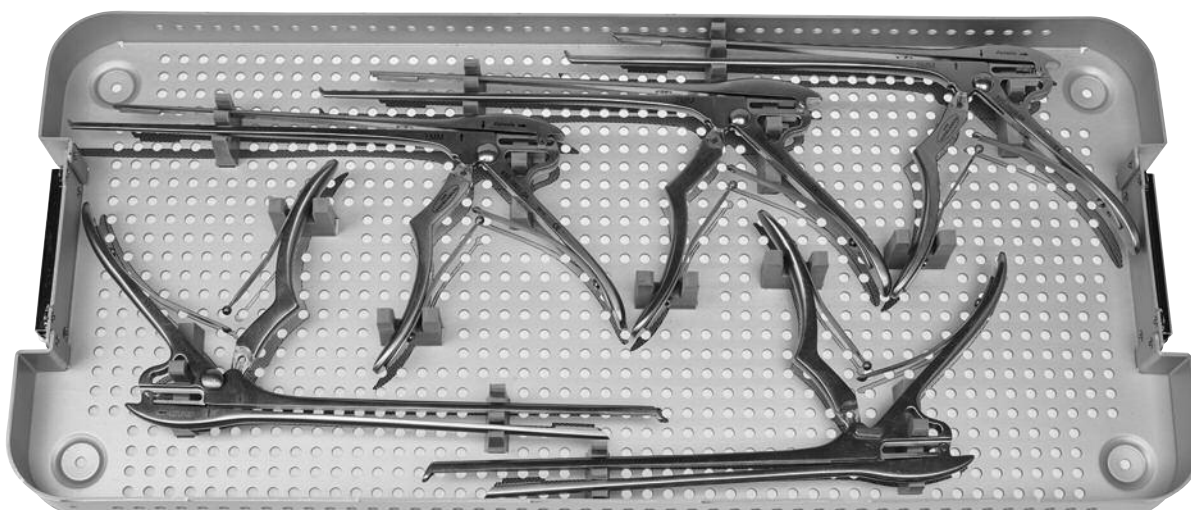

8" OPEN UP KERRISON STERILIZATION TRAY WITH COVER

Holds 5 Take-Apart Kerrisons
Outer Dimensions: 10" x 21.5" x 1.5"

702-2110-1

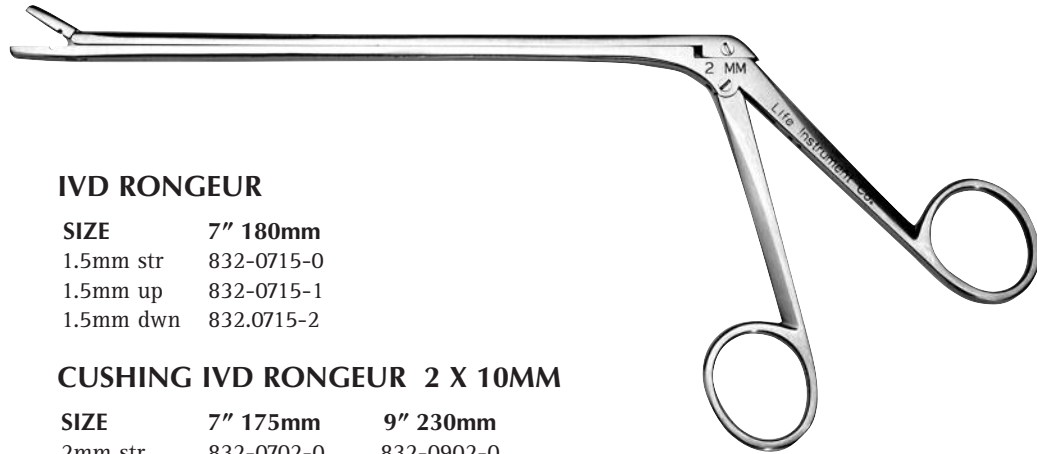

IVD RONGEUR

SIZE	7" 180mm
1.5mm str	832-0715-0
1.5mm up	832-0715-1
1.5mm dwn	832.0715-2

CUSHING IVD RONGEUR 2 X 10MM

SIZE	7" 175mm	9" 230mm
2mm str	832-0702-0	832-0902-0
2mm up	832-0702-1	832-0902-1
2mm dwn	832-0702-2	832-0902-2

LOVE IVD RONGEUR 3 X 10MM

SIZE	7" 175mm	9" 230mm
3mm str	832-0703-0	832-0903-0
3mm up	832-0703-1	832-0903-1
3mm dwn	832-0703-2	832-0903-2

SPURLING IVD RONGEUR 4 X 10MM

SIZE	7" 175mm	9" 230mm
4mm str	832-0704-0	832-0904-0
4mm up	832-0704-1	832-0904-1
4mm dwn	832-0704-2	832-0904-2

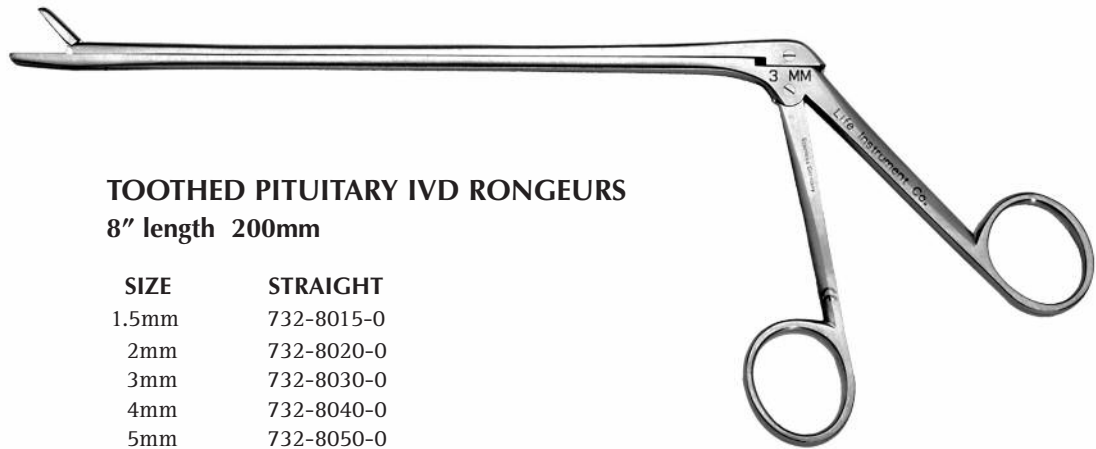

TOOTHED PITUITARY IVD RONGEURS
8" length 200mm

SIZE	STRAIGHT
1.5mm	732-8015-0
2mm	732-8020-0
3mm	732-8030-0
4mm	732-8040-0
5mm	732-8050-0

TOOTHED PITUITARY RONGEUR

SIZE	10" 250mm	12" 300mm
2mm	732-1020-0	732-1220-0
3mm	732-1030-0	732-1230-0
4mm	732-1040-0	732-1240-0
5mm	732-1050-0	732-1250-0

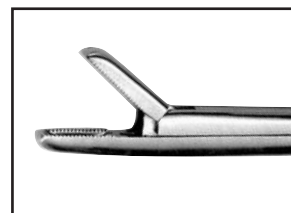

RONGEURS

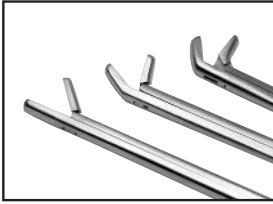
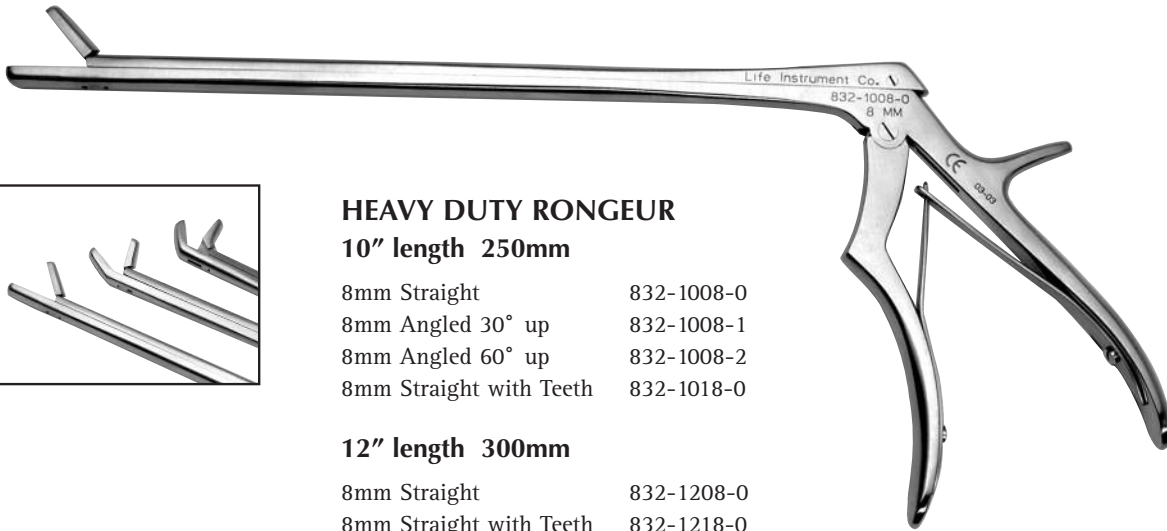

HEAVY DUTY RONGEUR

10" length 250mm

8mm Straight	832-1008-0
8mm Angled 30° up	832-1008-1
8mm Angled 60° up	832-1008-2
8mm Straight with Teeth	832-1018-0

12" length 300mm

8mm Straight	832-1208-0
8mm Straight with Teeth	832-1218-0



LESKELL RONGEUR

9" length 230mm

SIZE	SLIGHT CURVE	FULL CURVE
4mm	834-0914-0	834-0914-1
8mm	834-0918-0	834-0918-1

TOOTHED LEKSELL RONGEUR

9" length 230mm

SIZE	
4mm	834-0904-0
8mm	834-0908-0

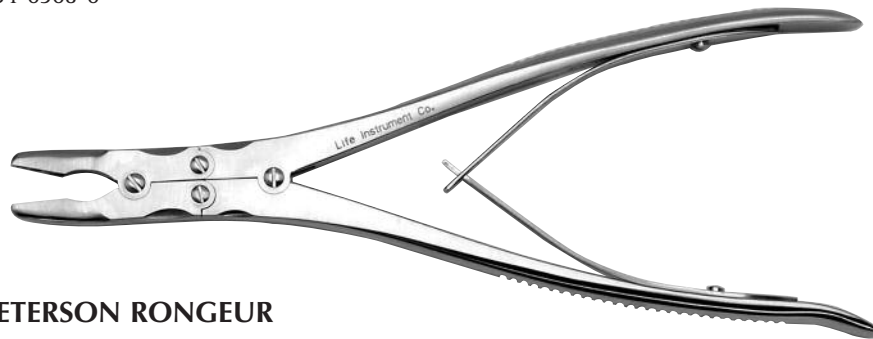

SMITH PETERSON RONGEUR

9" length 230mm

SIZE	STRAIGHT	ANGLED
2mm	836-9502-0	836-9502-1
4mm	836-9504-0	836-9504-1
6mm	836-9506-0	836-9506-1
7mm	836-9507-0	836-9507-1



ADSON RONGEUR
8" length 200mm

8mm smooth 834-0818-0
8mm teeth 834-0808-0



BEYER RONGEUR
7" length 175mm

3mm 834-0703-1 Slight curve

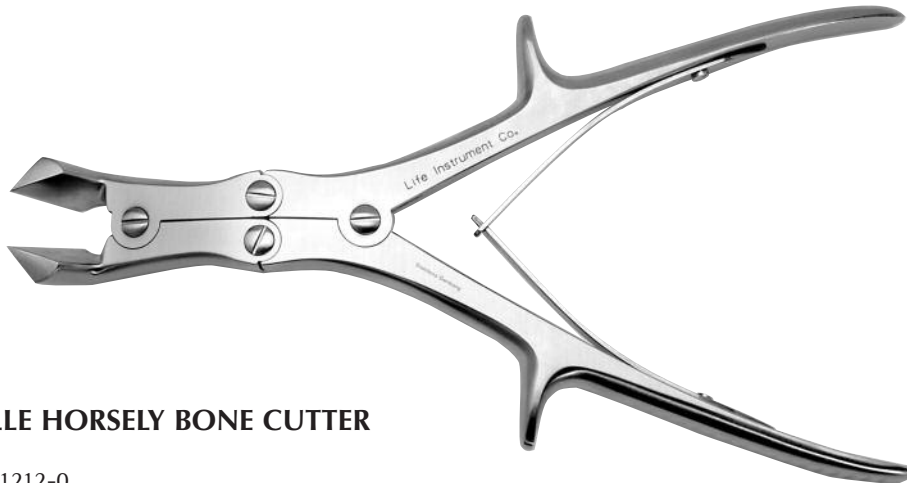

STILLE HORSELY BONE CUTTER

836-1212-0



EXTRA LONG DOUBLE ACTION RONGEUR
14" length 355mm

		With teeth	
5mm	873-1405-0	5mm	873-1405-0T
8mm	873-1408-0	8mm	873-1408-0T
12mm	873-1412-0	12mm	873-1412-0T

RETRACTORS



AUFRANC COBRA RETRACTOR WITH LIFE HANDLE

742-1215-1



COBRA RETRACTOR

742-1215-0



WIDE COBRA RETRACTOR

742-1225-1



BELLY COBRA RETRACTOR

742-1240-1



COBRA RETRACTOR EXTRA DEEP

742-1210-0



HIP RETRACTORS

3" Short Hip Retractor	745-1303-0
4" Long Hip Retractor	745-1304-0
6" Extra Long Hip Retractor	745-1306-0

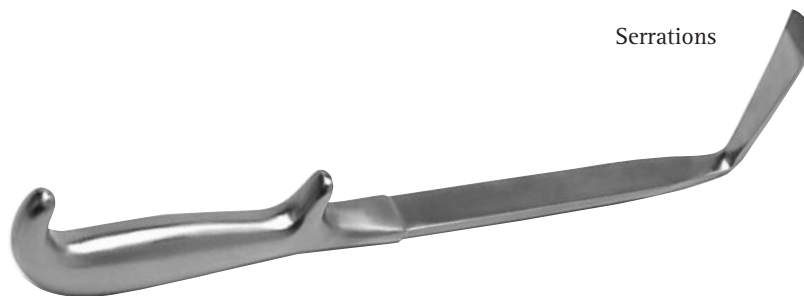

AUFRANC ELEVATOR & SHORT HIP RETRACTOR

745-1238-0

RETRACTORS



RIGHT ANGLE RETRACTORS

4" 748-0804-0

6" 748-0806-0

8" 748-0808-0

Handle can be 90° reversed upon request.



MCELROY RETRACTOR

5" depth 125mm

9" 740-0901-0

11" 740-1101-0

13" Extra Long 740-1301-0



BONE HOOK

10" overall length 748-1020-1 5" Handle

12" overall length 748-1220-1 7" Handle



FEMORAL SHAFT RETRACTOR

742-1302-0



PROXIMAL FEMORAL SHAFT RETRACTOR

742-1415-1



BENNETT RETRACTOR

10" length 260mm

1.75"	45mm	745-1045-0
2.25"	60mm	745-1060-0
3.25"	80mm	745-1080-0

RETRACTORS



REVERSE HOHMANN KNEE RETRACTOR

744-0818-0



Z-RETRACTOR

744-0899-0



HIBBS RETRACTORS

9.5" length 240mm

3" 840-9503-0

4" 840-9504-0



HOHMANN RETRACTOR

9.25" length 235mm

10mm 743-9510-0

18mm 743-9518-0

25mm 743-9525-0

43mm 743-9543-0

9.75" length 250mm

70mm 743-9570-0

MINI HOHMANN RETRACTOR

6.5" length 166mm

6mm 743-6506-0

8mm 743-6508-0

RETRACTORS

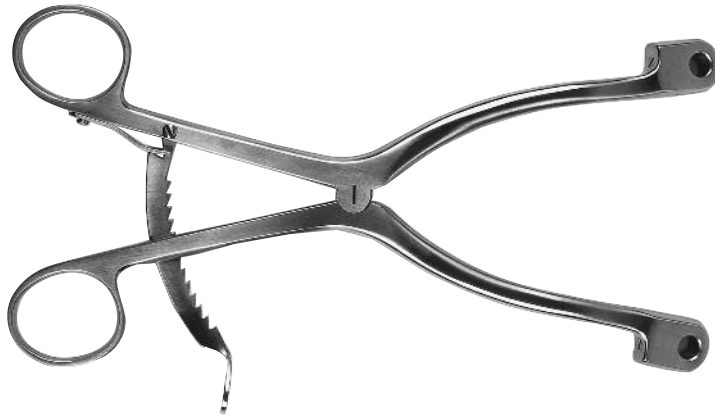

KOLBEL RETRACTOR FRAME

745-0001-0



KOLBEL BLADES

SIZE

width x length	Set of 2
20 x 36	745-2036-0
36 x 36	745-3636-0
20 x 53	745-2053-0
36 x 53	745-3653-0
20 x 68	745-2068-0
36 x 68	745-3668-0



FAKUDA RETRACTOR

Small 29mm 745-0029-0
Large 36mm 745-0036-0

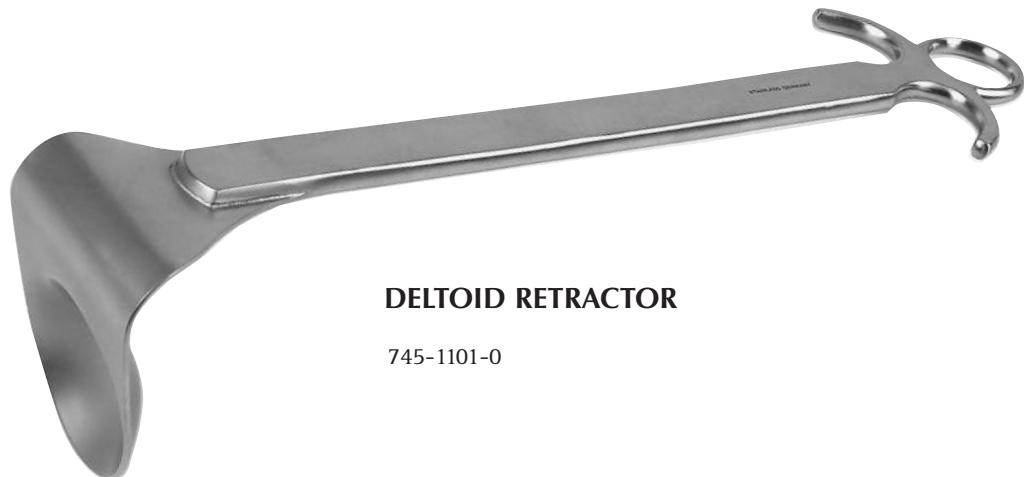

DELTOID RETRACTOR

745-1101-0

RETRACTORS



NERVE ROOT RETRACTOR

10.5" length 265mm

Regular 8.5"	215mm	746-8520-0
Fine 10.5"	265mm	746-1020-1
Regular 10.5"	265mm	746-1020-0



SENN RETRACTOR

6" length 150mm

Sharp	744-0603-0
Blunt	744-0613-0



BABY BENNETT RETRACTOR

6" length 150mm

743-0638-1



MULTI-USE RETRACTOR

6.75" length 170mm

743-6753-0



HERNIA RETRACTOR

6" length 150mm

7mm	744-0607-0
10mm	744-0610-0
14mm	744-0614-0

SELF-RETAINING RETRACTORS



ZELPI® RETRACTOR 90°

5" Exposure

3"	741-1230-2
4"	741-1240-2
5"	741-1250-2

Also available

1.5"	741-1215-2
2"	741-1220-2



ZELPI® WITH CEREBELLAR TIPS

3.5" Length

90°	741-1244-2
45°	741-1244-3

Different lengths available upon request



ZELPI® CEREBELLAR 90° GELPI STYLE RATCHET

3" 741-1234-2-1

SELF-RETAINING RETRACTORS

DEEP GELPI RETRACTOR 3"

90° 741-1030-0



WILTSE GELPI RETRACTOR 4"

741-1240-0

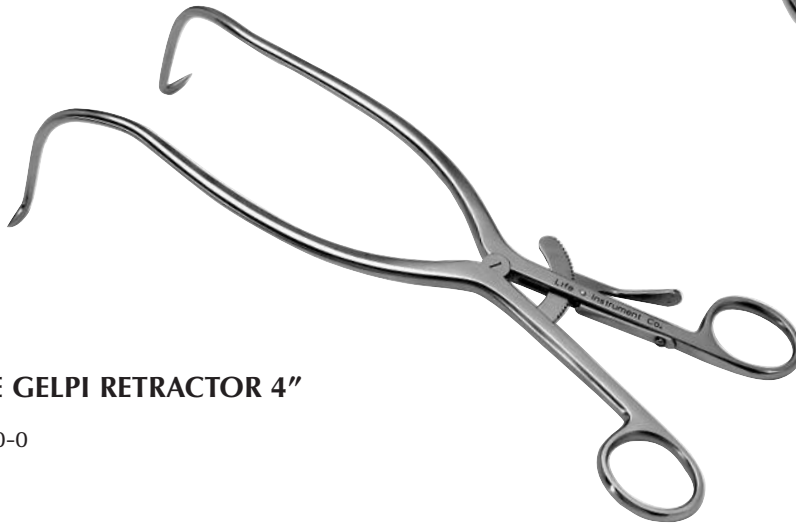

WEITLANDER RETRACTOR

3 x 4 prongs

SIZE

5 1/2"	741-5501-0
6 1/2"	741-6500-0
7 3/4"	741-7750-0
9"	741-0900-0

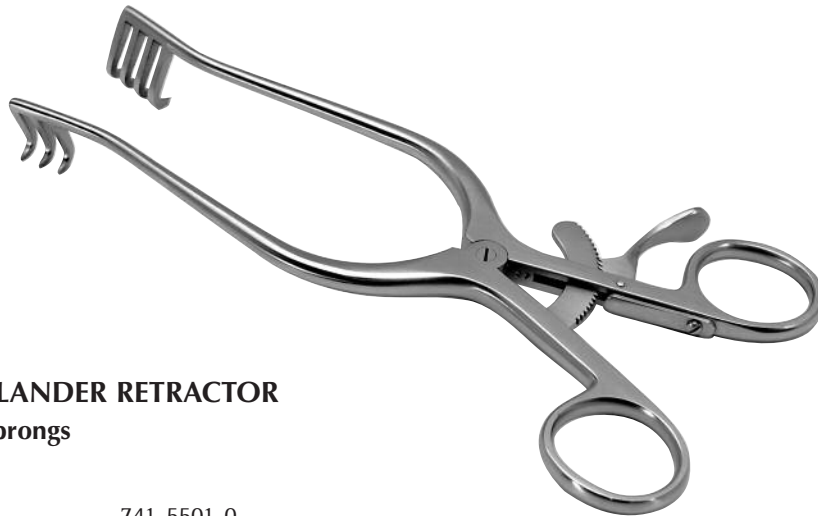

Please indicate blunt tips by adding "B" to the end of the part number.



SMALL



LARGE

INGE LAMINA SPREADER

- Small 6.5" 741-6506-0
- Small 6.5" 741-6506-0S with Spindle
- Large 10" 741-9503-0



LAMINA SPREADER WITH LOCKING SPINDLE

- 3" Deep 741-9503-0S
- 5" Deep 741-9505-0S

RETRACTORS



ILIAC CREST RETRACTORS

Adult	740-9030-0
Pediatric	740-8015-0



MICRO TAYLOR RETRACTORS

Blade width 3/4" 19mm

SIZE

2"	50mm	748-9512-0
3"	75mm	748-9513-0
4"	100mm	748-9514-0
5"	125mm	748-9515-0
6"	150mm	748-9516-0

TAYLOR RETRACTOR

Blade width 1 1/4" 30mm

3"	75mm	748-9503-0
4"	100mm	748-9504-0
6"	150mm	748-9506-0

MEYERDING RETRACTORS

SIZE

17mm x 55mm	748-0917-0
25mm x 80mm	748-0925-0
25mm x 125mm	748-0925-L
25mm x 150mm	748-0925-LC
50mm x 94mm	748-0950-0

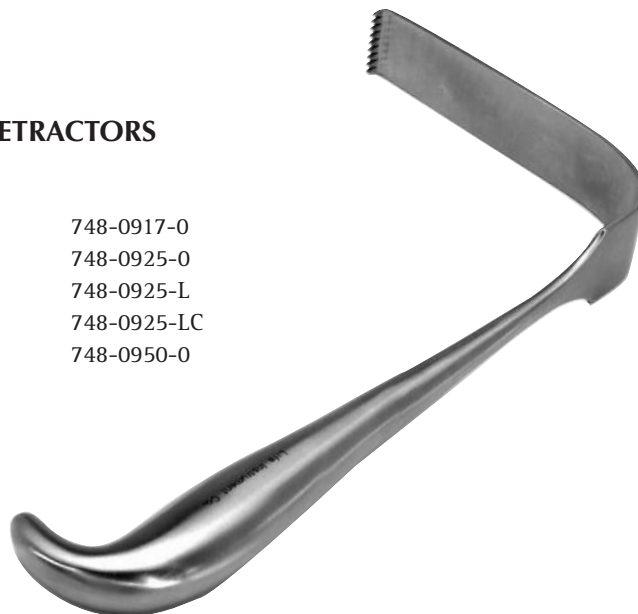

OSTEOTOMES, GOUGES & CHISELS



OSTEOTOMES

10.75" overall length 5" handle 270mm

SIZE	MM	STRAIGHT	CURVED
1/4"	6mm	750-1025-0	750-1025-1
3/8"	9mm	750-1038-0	750-1038-1
1/2"	13mm	750-1012-0	750-1012-1
5/8"	16mm	750-1058-0	750-1058-1
3/4"	19mm	750-1034-0	750-1034-1
1"	25mm	750-1010-0	750-1010-1



CHISELS

10.75" overall length 5" handle 270mm

SIZE	MM	STRAIGHT	CURVED
1/4"	6mm	751-1025-0	751-1025-1
3/8"	9mm	751-1038-0	751-1038-1
1/2"	13mm	751-1012-0	751-1012-1
5/8"	16mm	751-1058-0	751-1058-1
3/4"	19mm	751-1034-0	751-1034-1
1"	25mm	751-1010-0	751-1010-1



GOUGES

10.75" overall length 5" handle 270mm

SIZE	MM	STRAIGHT	CURVED	REVERSE CURVE
1/4"	6mm	753-1014-0	753-1014-1	753-1014-2
3/8"	9mm	753-1038-0	753-1038-1	753-1038-2
1/2"	13mm	753-1012-0	753-1012-1	753-1012-2
5/8"	16mm	753-1058-0	753-1058-1	753-1058-2
3/4"	19mm	753-1034-0	753-1034-1	753-1034-2
1"	25mm	753-1010-0	753-1010-1	753-1010-2

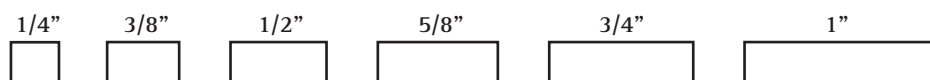

OSTEOTOMES, GOUGES & CHISELS

MILLIS OSTEOTOMES

30° angle

14mm 759-1314-1
 19mm 759-1319-1
 25mm 759-1325-1

45° angle

14mm 759-1314-2
 19mm 759-1319-2
 25mm 759-1325-2

For Pelvic osteotomy procedure.

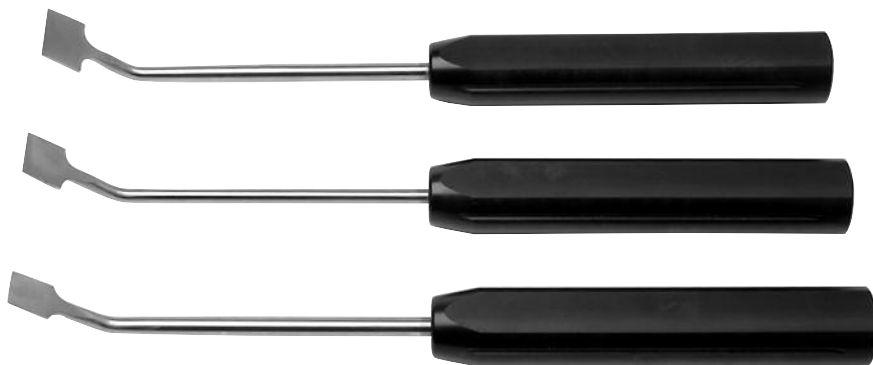

MILLIS CRESCENT OSTEOTOMES

Straight

14mm 759-1314-0
 19mm 759-1319-0

30° angle

14mm 759-1314-3
 19mm 759-1319-3
 25mm 759-1325-3

45° angle

14mm 759-1314-4
 19mm 759-1319-4
 25mm 759-1325-4

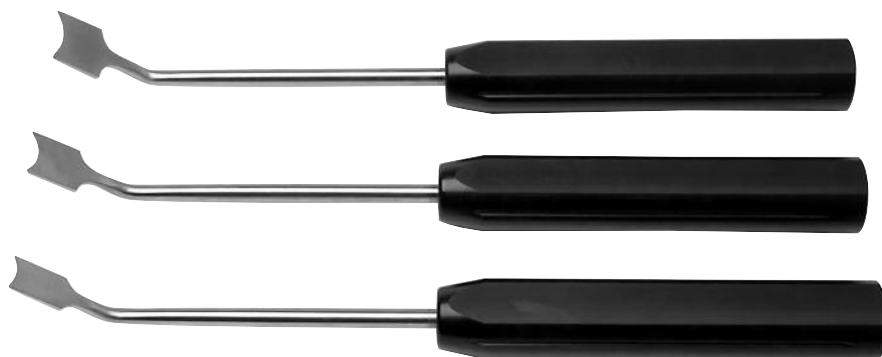

LONG OSTEOTOMES

15" overall length 5" handle 380mm

SIZE	STRAIGHT
1/4" 6mm	750-1514-0
3/8" 9mm	750-1538-0
1/2" 13mm	750-1512-0



LANE ELEVATOR WITH RING HANDLE

10.5" overall length 265mm

820-6196-05

OSTEOTOMES, GOUGES & CHISELS



ILIAC WING RETRACTOR

15" 740-1501-0
18" 740-1801-0



LOTKE OSTEOTOME

750-9512-0

For removing posterior Osteophytes.



MOTTA CHISELS

SIZE

1	22mm	756-9501-0
2	33mm	756-9502-0
3	39mm	756-9503-0
4	47mm	756-9504-0

For Chiari osteotomy procedure.



GOATS FOOT RETRACTOR

756-1053-0



AUFRANC ACETABULAR GOUGE

756-1128-1

OSTEOTOMES, GOUGES & CHISELS



HARVESTING GOUGE

10" overall length 5" handle 250mm

5/16" 8mm 753-0516-0

Available with 9" handle upon request



MINI OSTEOTOMES

7.5" overall length 190mm

2mm 750-7502-0

4mm 750-7504-0

6mm 750-7506-0

8mm 750-7508-0

9" handle available upon request

Curved Mini Osteotomes available upon request



NAVICULAR GOUGE

8.5" length 215mm

755-0803-0

OSTEOTOMES, GOUGES & CHISELS



SMITH PETERSON OSTEOTOME

8" length 200mm

SIZE	MM	STRAIGHT	CURVED
1/4"	6mm	750-0825-0	750-0825-1
3/8"	9mm	750-0838-0	750-0838-1
1/2"	13mm	750-0812-0	750-0812-1
5/8"	16mm	750-0858-0	750-0858-1
3/4"	19mm	750-0834-0	750-0834-1
1"	25mm	750-0810-0	750-0810-1



SMITH PETERSON GOUGE

8" length 200mm

SIZE	MM	STRAIGHT	CURVED
1/4"	6mm	753-0814-0	753-0814-1
3/8"	9mm	753-0838-0	753-0838-1
1/2"	13mm	753-0812-0	753-0812-1
5/8"	16mm	753-0858-0	753-0858-1
3/4"	19mm	753-0834-0	753-0834-1
1"	25mm	753-0810-0	753-0810-1



HIBBS GOUGE

9.5" length 240mm

SIZE	MM	STRAIGHT	CURVED
1/4"	6mm	753-0914-0	753-0914-1
3/8"	9mm	753-0938-0	753-0938-1
1/2"	13mm	753-0912-0	753-0912-1
5/8"	16mm	753-0958-0	753-0958-1
3/4"	19mm	753-0934-0	753-0934-1
1"	25mm	753-0910-0	753-0910-1

MALLETS & TAMPS

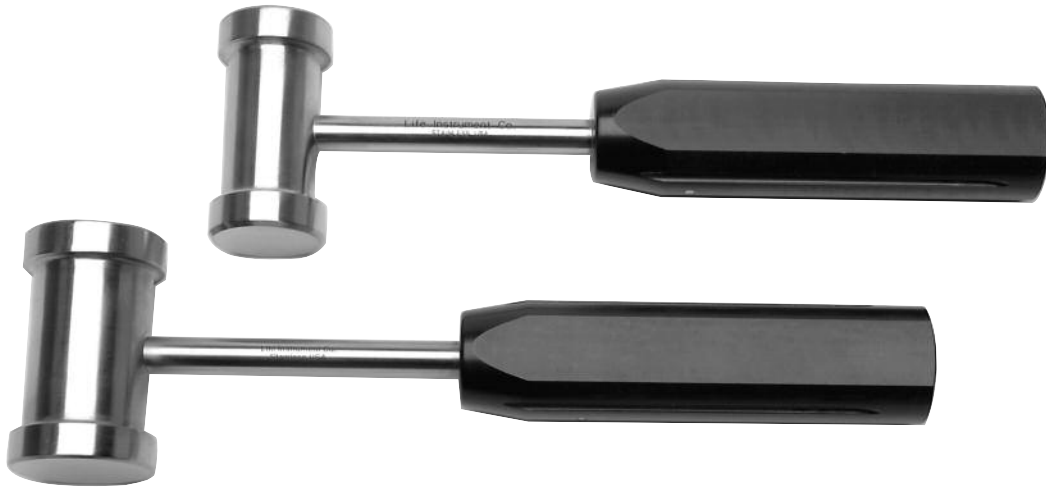

SMITH PETERSON MALLETS 9" overall length 230mm

Small	761-9017-0
Large	761-9028-0



TORONTO MALLETS 9" overall length 230mm

Metal 32 oz.	760-9032-0
Plastic 24 oz.	760-9024-0



MALLET Nylon one side 30mm diameter 10" overall length 250mm

761-1030-0

MALLETS & TAMPS



763-9505-0



763-9513-0



763-9510-0



763-1212-0

BONE TAMPS

9.5" length 240mm

Rectangular Tamp	5mm	763-9505-0
Round Bone Tamp	13mm	763-9513-0
Offset Bone Tamp	10mm	763-9510-0

BONE IMPACTOR

12" length 300mm

12mm x 6mm	763-1212-0
------------	------------



TAMP

12" length 300mm

9mm x 9mm	763-1209-0
-----------	------------

RADIOLUCENT INSTRUMENTS



PINION
Included with Frame

644-0001-K

RADIOLUCENT CARBON FIBER PEEK RETRACTOR FRAME

644-0001-0

CARBON FIBER PEEK BLADES



SIZE	20mm width	25mm width
50mm	649-2050-0	649-2550-0
70mm	649-2070-0	649-2570-0
90mm	649-2090-0	649-2590-0
110mm	649-2011-0	649-2511-0

Additional blade sizes available upon request. Please visit our website at www.lifeinstruments.com.

RADIOLUCENT INSTRUMENTS CARBON FIBER RETRACTORS



HOHMANN STYLE RETRACTOR
9.5" overall length

10mm 643-9510-0
18mm 643-9518-0
25mm 643-9525-0



CLOWARD RETRACTOR
100mm blade

20mm 648-7520-0



EXTRA LONG HOHMANN RETRACTOR
12" overall length

25mm 643-1225-0



ILIAC WING RETRACTOR
15" overall length

640-1501-0



FEMORAL RETRACTOR
16" overall length

640-1630-0

SUCTION TUBES



FRAZIER SUCTION TUBES

7" from bend

6FR	791-0006-1
8FR	791-0008-1
10FR	791-0010-1
12FR	791-0012-1
14FR	791-0014-1

8" from bend

10FR	791-0010-1-8
12FR	791-0012-1-8

10" from bend

10FR	791-0010-1-10
12FR	791-0012-1-10

Custom lengths available upon request.

*** Large Aluminum Handle for Excellent Control ***



ASDOURIAN SUCTION TUBES

20 FR

5" from the bend	791-1005-0
9" from the bend	791-1010-0



JEFFERSON FORCEPS

7" length 175mm

1 x 2 Teeth	780-7012-0
Serrated	780-7013-0



"WHITE" RUSSIAN FORCEP

New forcep designed to facilitate collection, delivery and packing of bone graft. Very useful for bone grafting adjacent to instrumentation, under rods and crosslinks.

Designed by Andrew White, M.D.

8"	780-8005-0
10"	780-1005-0

Tamp End

*** NEW ***



WIRE TWISTER

781-1000-1

OTHER

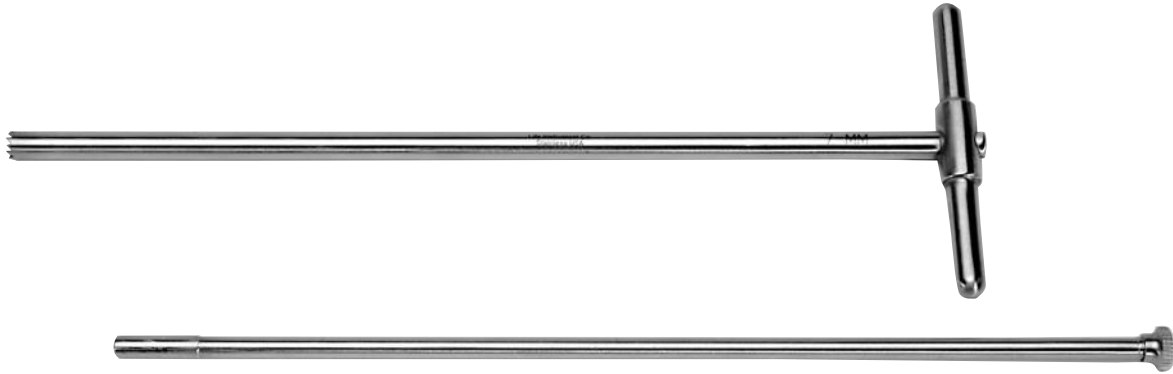

TREPHINES

6" length 150mm

6mm	756-0606-0
Plunger	756-0606-1

12" length 300mm

7mm	756-1207-0
8mm	756-1208-0
9mm	756-1209-0

9" length 230mm

7mm	756-0907-0
8mm	756-0908-0
9mm	756-0909-0

Plungers

7mm	756-1207-1
8mm	756-1208-1
9mm	756-1209-1

Plungers:

7mm	756-0907-1
8mm	756-0908-1
9mm	756-0909-1



FUNNEL

Stainless Steel

Bone Funnel Cup	706-0302-0
8.5" Tube	706-8508-1
6.5" Tube	706-6508-1

Cup disassembles from tube for easy cleaning.

* Sold Separately *



PLUNGER

706-8508-2	for 8.5" Tube
706-6508-2	for 6.5" Tube



HIP ALIGNMENT GUIDE

704-0001-0



CARBIDE TIP PUNCH

706-1000-0



CUP POSITIONERS

792-1206-0

REPLACEMENT PARTS

- 792-1206-B 28mm Ball
- 792-1206-B32 32mm Ball

OTHER



**LIFE INSTRUMENT ARM WITH
UNIVERSAL ATTACHMENT**
Table Clamp Included

400mm column 703-1601-0

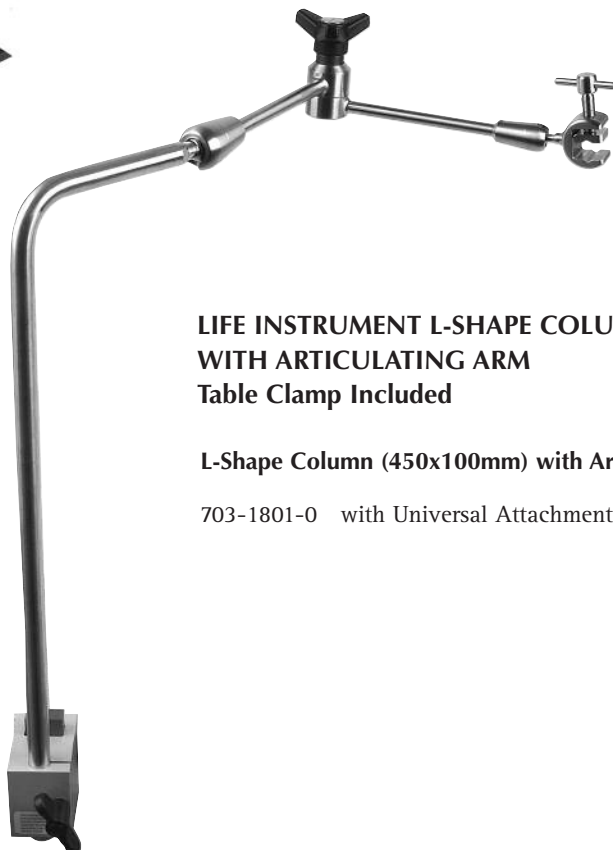

**LIFE INSTRUMENT L-SHAPE COLUMN
WITH ARTICULATING ARM**
Table Clamp Included

L-Shape Column (450x100mm) with Articulating Arm (400mm extension)

703-1801-0 with Universal Attachment

LIFE INSTRUMENTS®

INSTRUMENT CARE

Life Instruments have a “Life” guarantee. We will replace or repair any instrument that has manufacturer defects in workmanship and/or materials. The warranty does not apply to normal wear and tear on the instrument.

Improper care of hand held instruments may result in unsatisfactory performance. Instruments should be used for their intended purpose exclusively. Misuse of instruments may result in damage that is not repairable. Failure of intended use will void the “Life” warranty.

Life Instruments are made from the highest quality stainless steels and plastics. However, certain chemicals can be corrosive to stainless steel. In order to prevent corrosion, staining or rusting, instruments must be treated and cleaned properly. Instruments should be thoroughly dried prior to storage.^{1, 2}

INSTRUMENT REPAIR

Sharpening and reconditioning of instruments is available.

The “Life” warranty does not apply to instruments that have been repaired by other instrument manufacturers or repair facilities.

Please ship instruments to:

Life Instrument Corporation
91 French Avenue
Braintree, MA 02184
Attn: Repairs

ORDERING INFORMATION

To place an order, please phone or fax:

(781) 849-0109
(781) 849-0128 fax
800-925-2995 toll-free
www.lifeinstruments.com

¹ ASTM Standard F 1744-96, Standard Guide for Care and Handling of Stainless Steel Surgical Instruments

² Proper Maintenance of Instruments, Working Group Instrument Preparation, 7th Edition



**LIFE
INSTRUMENTS®**

LIFE INSTRUMENT CORPORATION

91 FRENCH AVENUE

BRAINTREE, MA 02184

(781) 849-0109

FAX (781) 849-0128

800-925-2995

WWW.LIFEINSTRUMENTS.COM