

**MASPEN**  
ahşap pencere

wood window

Pencerelerinizde  
doğal ahşap sıcaklığı  
*Natural warmth  
of wood to your  
windows*



Certificated by  
**ISO 9001**

[www.maspen.com](http://www.maspen.com)

Kırk yılı aşkın bir süredir ahşap kapı ve pencere üretimini sürdüren Birmob Mobilya İnşaat San. ve Tic. Ltd. Şti. birikimini ve tecrübesini yatırımlarına aktararak istikrarlı bir şekilde büyümesini sürdürmektedir.

Kalite, estetik ve uygun fiyat parolasıyla ülke içi ve ülke dışı pazarları kendine hedef seçerek hizmet vermektedir. Ülkemizde yıllardır konvansiyonel sistemde ahşap doğrama üretimi yapılmaktadır. Küçük atölyelerde hiçbir kalite standardı dikkate alınmadan yapılan üretimlerle bir sektör oluşmuştur. Bina kalitesinin en önemli faktörlerinden biri olan doğrama sistemleri içerisinde "Ahşap", 70'li yılların ortalarından itibaren alüminyuma, 90'lı yılların başından itibaren PVC'ye yenik düştü. Bu dönemlerde ahşap doğrama kalitesizliğin sembolü haline geldi. Sektörün bu durumu karşısında Birmob Mobilya İnşaat San. ve Tic. Ltd. Şti. hiçbir zaman kalitesinden ödün vermeden aşağıda belirtilen standartları benimsemiştir.

1- Kapı-pencere yapımına uygun ağaç seçilir,

a) Seçilen malzemelerin elastikiyet modülünün, kapı ve pencerenin hareketli kısımlarının dikliğini korumak için düşük olma özelliği dikkate alınır,

b) Kapı-pencere elemanlarının, kenarlarının çarpmaya karşı direncinin yüksek olması gerekmektedir,

c) Ağaç malzemenin birleşme yerlerinin dayanıklılığı, sızdırmazlığı ve yüzey işlemlerinin sağlamlığı açısından uygun ağaç seçimi yapılır,

d) Böcek ve mantar etkisine karşı empenye edilebilir özellikte ağaç seçilir. Emprenye tekniği ile kimyasal işlemlere tabi tutulan ahşap malzemede mantarlaşma, küflenme ve kurtlanmaya bağlı çürümeler görülmez. Bu sayede üzerine tatbik edilen boya ve cilalarla çok sağlam bir zemin oluşturulur. Ön koruma işleminden geçen ahşap; PVC, alüminyum, beton ve çelikten daha uzun ömürlü hale gelir. Bu sayede çok dayanıklı ürünler elde eden şirketimiz, çürümeye karşı hizmet ömrü sağlar.

e) İşlenme, iyi tutkallama, iyi çivi ve vida tutma özelliğine sahip ağacın seçimine dikkat edilir,

2- Üç parça laminasyon tekniğine uygun tekniğine uygun üretim ile çarpılma ve dönme riski minimuma indirilir.

3- Ahşabın dış yüzeyindeki çatlak, çürük ve düşer budaklı kısımlar titizlikle ayıklanır.

4- Detaylarımız her türlü cam sistemine uyumludur. Cam arası karolaj ve cam arası jaluzi yapılabilir. Tek açılı, çift açılı, sürgülü, katlanır giyotin sistemlerinde aksesuarlarla uyumludur. Alüminyum damlalık, conta ve ısı kanalı sayesinde; ısı, ses, rüzgar, su ve toz izolasyonu maksimum düzeyde sağlanmıştır.

5- Kullanılan özel boyalar esnektir. Çatlamaz, pullanıp dökülmez. Güneşe ve hava şartlarına karşı dayanıklıdır. Gerekğinde fırça ile kolayca yenilenebilir. Bu ürün suyu geçirmez, buna karşılık havayı geçirerek ahşabın -dolayısıyla mekanın- nefes almasını sağlar.

*Our Company titled as Birmob Mobilya San. Ve Tic. Ltd. Şti. That has continued its production of wooden windows and doors for over forty years reflected its available sources and experience into the investments and keeps on its stable development.*

*The production of woodwork continues in our country for years within the scope of the conventional system. Then, a sector was formed up by the productions carried out in small workshops without taking any quality standards into consideration. The "wood" that is one of the most important factors of the building quality within the woodwork systems had a serious set back against aluminum from the mid-1979s and a second set back, against PVC from the beginning of 1990s. During these periods, the woodwork in general turned out to be a kind of non-quality symbol. Even under such circumstances of the sector, Birmob Mobilya San. Ve Tic. Ltd. Şti. has never concession from its quality and adopted the standards as per mentioned below:*

*1- Firstly, the wood that is convenient for door and window production is selected.*

*a) The lowness characteristic of the elasticity module of the selected materials in order to protect the uprightness of the moving parts of doors and window is taken into consideration;*

*b) The resistance of the side parts of the components of the doors and Windows must be high against strokes of collisions.*

*c) A suitable selection of wood is made from the point of view of the soundness of the surface procedures, solidity (resistance) of the conjunction points of wooden material as well as the impermeability of the same.*

*d) In this selection procedure, especially the impregnable wood against the effect of insects and fungus, (no decaying is seen in the wooden materials that have been made subject to chemical processes by the impregnation technique with relation to any fungus, molding and worm infesting. By this means, a really strong basis is formed up by the paints and varnishes applied to the surface of the material. The wood that has gone through a prior-protection process will turn out to be a material that has longer life than PVC, aluminum, concrete and steel. Our company that obtains much more resistible products by this means, gives a guarantee of 30 years against decaying.*

*e) Again special attention is paid to the selection of wood that has the feature of good processing, good gluing, and holding good nail and screw.*

*2- The twisting and distortion risk is minimized by a production process in conformity with the three piece-lamination technique.*

*3- The cracked, decayed and gnarled parts on the outer faces of the wood is cleaned up fastidiously.*

*4- Our details are in conformity with all kinds of glass systems. It is possible to make inter-glass carrolage and inter-glass window blind. All accessories such as single-opening, double-opening sliding foldable guillotine, show conformance. By means of the aluminum sound, wind, water and dust insulation has been provided at maximum level.*

*5- The special water-based paints are flexible. They are not cracked and scaled off, and resist against the sunlight and weather conditions, and not faded off, and do not require maintenance for years, and when needed, they could easily be renewed by a brush. This product has a feature of water impermeability, however, it is of air permeability feature, as a consequence, ensures the ventilation of the area.*

# Üstün Teknoloji, Kaliteli Üretim...

## High Technology, Quality Production...



### RAW MATERIALS

MASPEN meets its raw material requirements either from domestic market or abroad by holding the quality as a precondition and making them go through a various number of tests with utmost care. The purchased raw materials are those conforming to the first class standard indicated by the TSE (Turkish Standard Institute) such as Pinus Silverstris, Castanea, Oak, Meranti, Limada and so on. The humidity of the mentioned woodwork timber is selected in a way that such procedures are strictly carried out by experienced teams and equipment.

### DRYING UP PROCESS

After the timbers at the storage area are selected, they are dried up at the vacuumed drying oven in various programs according to the tree types for dimension stabilization, in the drying up process, storage system, lathe thickness, drying up conditions is strictly applied by a trained operator with necessary care.

### LAMINATION

The material, after having been taken from the drying oven by a humidity percentage of 12% air-dry is brought into a necessary dimension, is made subject to a laminating process. This procedure is realized at the fully automated press machines under high pressures. The pieces due to be laminated are lined up in a way so that the fiber tensions be upright to each other. The glue used for this process contains formaldehyde in order to increase the resistance of the material against the water.

### UNIFICATION DETAIL

MASPEN, is unified by the use of double lamb mortise in order to prevent the defects arising from load tensions due to occur at corners and bring the works of the material to a minimum level.

### IMPREGNATION

The laminated semi-finished product is cut off at dimensions suitable for woodworks. And the lamb takes the final shape by passing through the profile machine after the mortise, after having opened the handle and mechanism holes, it is made subject to impregnation process while it is in an unprocessed state. The organisms that damage the structure of wood are fungus, bacteria, insects and termites. In order to eliminate the harmful effects of biological enemies, the wood material is made to be penetrated an average amount of 20 liters of impregnation material corresponding to 1 cubic meter of wood materials (depending on wood types) for a period of 1 hour under 1 atmospheric pressure with a pre-protective material containing organic solvent. By this means, the wood material gains a service period of 60 years.

### WATER COLLECTION CHANNEL

The aluminum drainpipe is used in order to collect and discharge the water. The place between the plastic corks fixed on both sides of the channel and wood is filled up with silicon mastic.

### IMPERMEABILITY SEALINGS

Specially designed EPDM sealings are used on the MASPEN woodworks. The sealing is made of double EPDM and has a close porous structure. The hard part ensures the resistance of the sealing and soft part, however, water proof. It does not lose such feature for a period of 15 years. The corners turn around in such unique that does not create any level difference.

## Dünya standartlarında pencere üretimi...

Maspen, mimari proje bazında gerekli sistem ve malzeme ihtiyacına cevap verebilecek geniş bir yelpazeye sahiptir.

## *Window production at international standards...*

*Maspen, has a wide range of systems and products to fulfill the needs of an architectural project.*



## İçindekiler *Contents*



### Uygulamalar *Applications*

**Tek Kanatlı Standart Pencere**  
*Single Casement Standard Window*

**Çift Kanatlı Standart Pencere**  
*Double Casement Window*

**Pivot Pencere**  
*Pivot Window*

**Rustik Pencere**  
*Rustic Window*

**Paralel Çekme Sürme Pencere**  
*Parallel Drawing Sliding Window*

**Katlanır Pencere**  
*Foldable Window*

**Kaldırmalı Sürme Pencere**  
*Lifting Slide Window*

**Giyotin Pencere**  
*Guillotine Window*

**Panjur**  
*Shutter*

**Renk Skalası**  
*Colour Scale*

**Üretim Parkı**  
*Production Line*

## Sayfa Page

06 13

14 15

16 17

18 19

20 21

22 23

24 25

26 27

28 29

30 31

32 33

34 35





Polka Otel - Polonezköy

Pencerelerinizde  
dođal ahşap sıcaklığı...

*Feel the warmth of solid  
wood on your windows...*





Meymenet Han - Beyoğlu

## Kalite Detayda Gizlidir...

Ahşap pencere seçmeniz için 4 önemli detay:  
Kalite, şık dizayn, farklı fonksiyonel  
çözümler, uygun fiyat.

## Quality is in Details...

*Four important criteria in selecting  
a wooden window: quality,  
fashionable design, different  
functional solutions,  
reasonable price...*



Çamlıca Konakları

## Fonksiyonel Çözümler...

Tüm Uygulamalarda  
mükemmel sonuç!

## Functional Solutions...

*Excellent results in all  
applications!*



Türkiye Futbol Federasyonu - Levent / İstanbul

Tüm Sistemlerle Uyumlu...

*Compatible With All  
Systems...*

## Kesitler Cross Sections

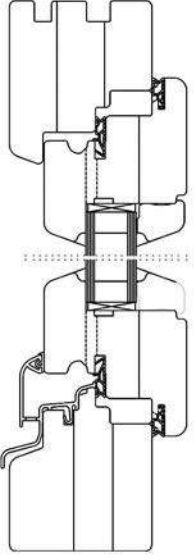

Dikey Kesit *Perpendicular Cross Section*

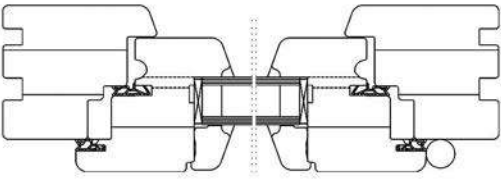

Yatay Kesit *Horizontal Cross Section*



### Özellikleri

- o Temizliği kolay profiller
- o 24 mm'lik ısıcam boşluğu
- o 45° köşe birleşmeli cam çitası
- o Solmayan ve UV ışınlarından etkilenmeyen su bazlı boyalar
- o Isı, ses ve toz yalıtımı sağlayan EPDM çift fitil
- o Avrupa standartlarında zengin aksesuar seçenekleri
- o Orjinal alüminyum damlalık

### Characteristics

- o Easy to clean profiles
- o Double glazing profile clearance of 24 mm
- o 45° conner-unified glass lathe
- o Non-fading paint that is not affected by UV lights
- o EPDM wick that provides heat, sound and dust insulation
- o Wide range of accessory alternatives as European Standards
- o Original aluminum dripping channel.



Soğuk  
Cold



Sıcak  
Hot



Yağmur  
Rain



Servis  
Service

Tek Kanatlı Standart Pencere *Single Casement Standard Window*

## Sadelik ve Kullanış Ön Planda

### Tek Kanatlı Standart Pencere

Tek kanat pencereler tek açılım veya çift açılım sistemlerinde olup her türlü mimari beklentinize hitap eder.

*Simplicity and use is  
in the Foreground...  
Single Casement Standard Window*

*The casement windows have  
single or dual-opening  
systems and satisfy any  
kind of your architectural  
expectations.*





## Kesitler Cross Sections

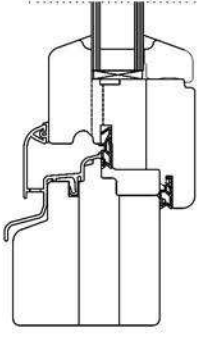

Dikey Alt Kesit *Vertical sub-section*

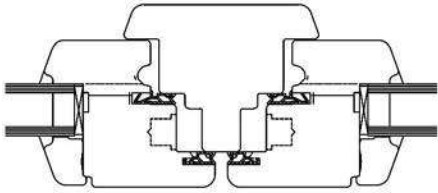

Yatay / Orta Kayıtlı *Horizontal / Central Register*

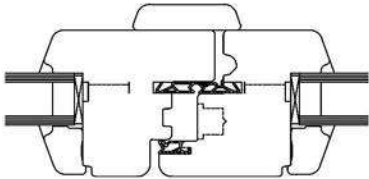

Yatay / Orta Kayıtsız *Horizontal / Middle indifferent*



### Özellikleri

- o Temizliği kolay profiller
- o 24 mm'lik ısıcam boşluğu
- o 45° köşe birleşmeli cam çitası
- o Solmayan ve UV ışınlarından etkilenmeyen su bazlı boyalar
- o Isı, ses ve toz yalıtımı sağlayan EPDM çift fitil
- o Avrupa standartlarında zengin aksesuar seçenekleri.
- o Orjinal alüminyum damlalık

### Characteristics

- o Easy to clean profiles
- o Double glazing profile clearance of 24 mm
- o 45° conner-unified glass lathe
- o Non-fading paint that is not affected by UV lights
- o EPDM wick that provides heat, sound and dust insulation
- o Wide range of accessory alternatives as European Standards
- o Original aluminum dripping channel.



Soğuk  
Cold



Sıcak  
Hot



Yağmur  
Rain



Servis  
Service

## Çift Kanatlı Standart Pencere *Double-Leafed Standard Window*

### **Detaylı Kullanım ve Sadelik** Çift Kanatlı Orta Kayıtsız Pencere

Çift lamba zivana birleşen köşeleri, damlalık profilleri ile dış cephelerde estetik ve mekanlarınızda ferahlık yaratır.

### ***Detailed Usage and Simplicity*** *Double-Leaves of a Window Without Middle Frame*

*With the double tongue and groove edges and aluminium drip profiles bring our windows aesthetic and confort to the facades and interiors.*

## Kesitler Cross Sections

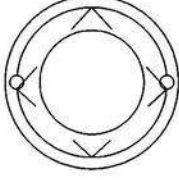

60

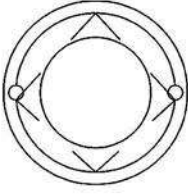

70

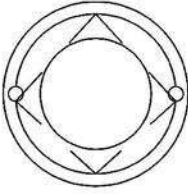

80

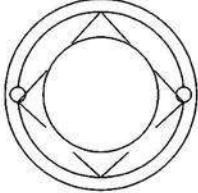

90

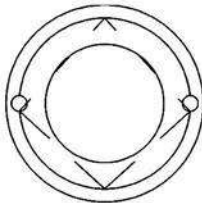

100

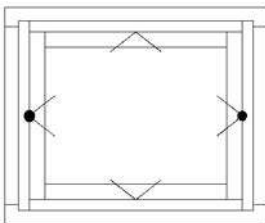

### Özellikleri

- o Temizliği kolay profiller
- o 24 mm'lik cam boşluğu
- o Solmayan ve UV ışınlarından etkilenmeyen su bazlı boya
- o Isı, ses ve toz yalıtımı sağlayan EPDM çift fitil
- o Avrupa standartlarında zengin aksesuar seçenekleri.

### Characteristics

- o Easy to clean profiles
- o Double glazing profile clearance of 24 mm
- o Non-fading paint that is not affected by UV lights
- o EPDM wick that provides heat, sound and dust insulation
- o Wide range of accessory alternatives as European Standards



Soğuk  
Cold



Sıcak  
Hot



Yağmur  
Rain



Servis  
Service

## Pivot Pencere *Pivot Window*

Pivot pencereler de dairesel, kare ve dikdörtgen açılım sistemleri farklı mekanlarda uygulanmaktadır. Mimari açıdan estetik, kullanım açısından da kolaylık sağlamaktadır.

*Pivot windows in the circular, square and rectangular opening systems are applied in different places. Architecturally aesthetic, in terms of ease of use provides.*

## Kesitler Cross Sections

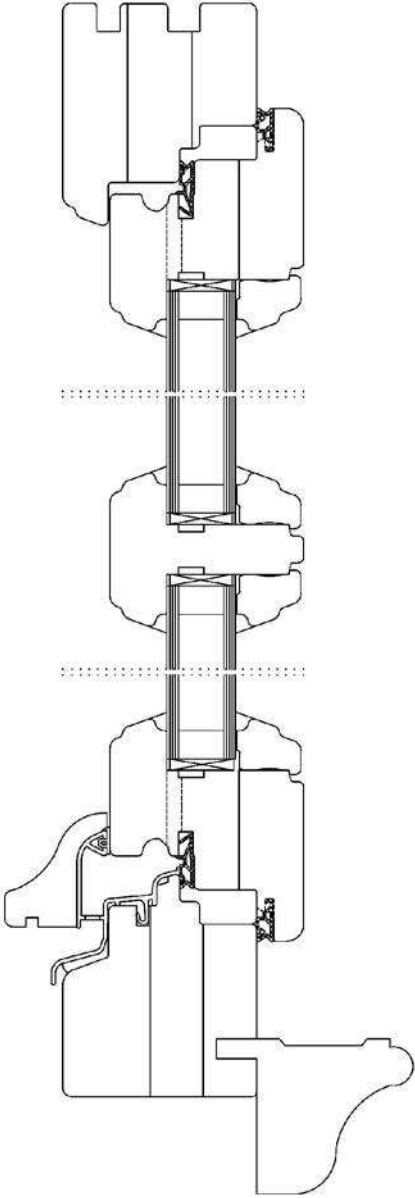

Dikey Kesit Perpendicular Cross Section



### Özellikleri

- o Temizliği kolay profiller
- o 24 mm'lik cam boşluğu
- o Solmayan ve UV ışınlarından etkilenmeyen su bazlı boya
- o Isı, ses ve toz yalıtımı sağlayan EPDM çift fitil
- o Avrupa standartlarında zengin aksesuar seçenekleri.
- o Orjinal alüminyum damlalık

### Characteristics

- o Easy to clean profiles
- o Double glazing profile clearance of 24 mm
- o Non-fading paint that is not affected by UV lights
- o EPDM wick that provides heat, sound and dust insulation
- o Wide range of accessory alternatives as European Standards
- o Original aluminum dripping channel.



Soğuk  
Cold



Sıcak  
Hot



Yağmur  
Rain



Servis  
Service

## Rustik Pencere *Rustic Window*

Rustik pencereler özellikle tarihi binaların mimarisine uyum sağlamaktadır.

*Rustic architecture integrates with windows, especially by the historical buildings.*

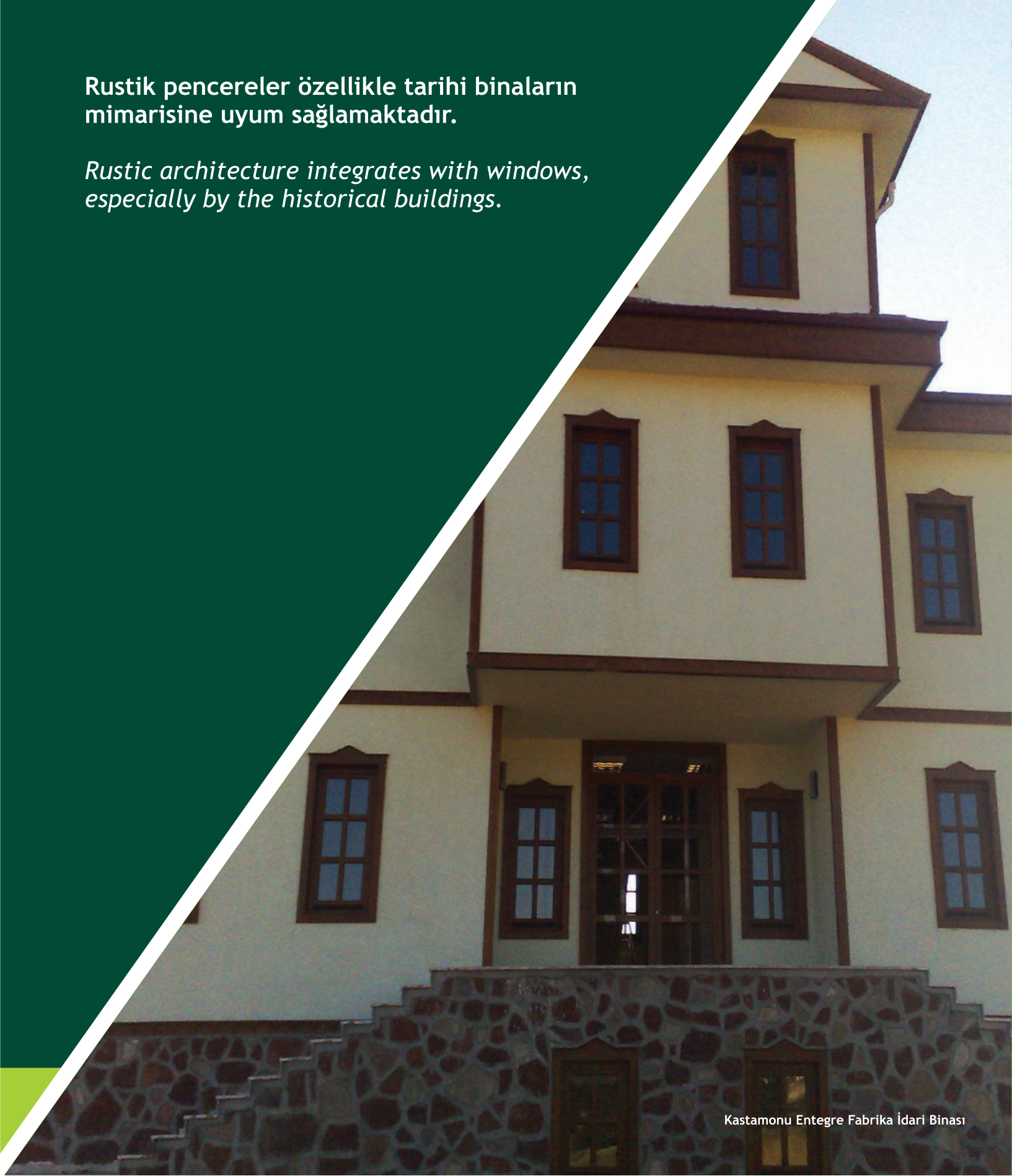

## Kesitler Cross Sections



Dikey Kesit *Perpendicular Cross Section*

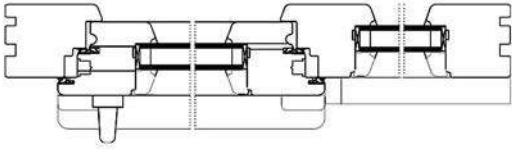

Yatay Kesit *Horizontal Cross Section*



### Özellikleri

- o Temizliği kolay profiller
- o 24 mm'lik cam boşluğu
- o 45° köşe birleşmeli cam çitası
- o Solmayan ve UV ışınlarından etkilenmeyen su bazlı boya
- o Isı, ses ve toz yalıtımı sağlayan EPDM çift fitil
- o Avrupa standartlarında zengin aksesuar seçenekleri.
- o Orjinal alüminyum damlalık

### Characteristics

- o Easy to clean profiles
- o Double glazing profile clearance of 24 mm
- o 45° conner-unified glass lathe
- o Non-fading paint that is not affected by UV lights
- o EPDM wick that provides heat, sound and dust insulation
- o Wide range of accessory alternatives as European Standards
- o Original aluminum dripping channel.



Soğuk  
Cold



Sıcak  
Hot



Yağmur  
Rain



Servis  
Service

## Paralel ekme Sürme Pencere *Parallel Drawing Sliding Window*

### **Şık ve İşlevsel** Paralel ekme Sürme Pencere

Orijinal 68x90 mm profil 2 ila 4 kanada kadar bölünebilme özelliđi ile geniş açıklıklarda ideal çözüm.

### ***Elegant and Functional*** *Parallel Drawing Sliding Window*

*Original 68x90 mm profile; ideal solution in wide clearances with its separability characteristic up 2 or 4 leaves.*



## Kesitler Cross Sections



**Dikey Kesit**  
Perpendicular Cross  
Section

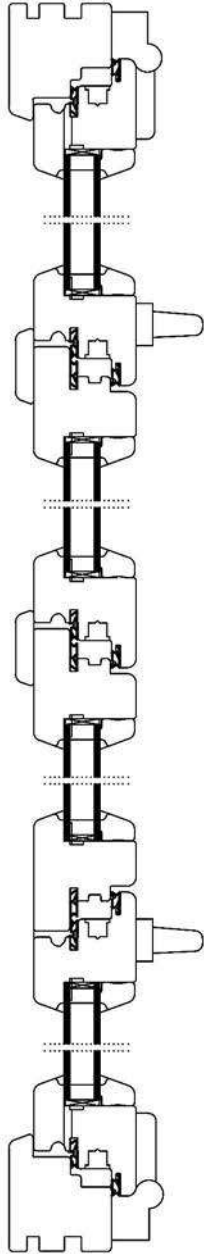

**Yatay Kesit** Horizontal Cross Section



### Özellikleri

- o Temizliği kolay profiller
- o 24 mm'lik cam boşluğu
- o 45° köşe birleşmeli cam çıtası
- o Solmayan ve UV ışınlarından etkilenmeyen su bazlı boya
- o Isı, ses ve toz yalıtımı sağlayan EPDM çift fitil
- o Avrupa standartlarında zengin aksesuar seçenekleri.
- o Orjinal alüminyum damlalık

### Characteristics

- o Easy to clean profiles
- o Double glazing profile clearance of 24 mm
- o 45° conner-unified glass lathe
- o Non-fading paint that is not affected by UV lights
- o EPDM wick that provides heat, sound and dust insulation
- o Wide range of accessory alternatives as European Standards
- o Original aluminum dripping channel.



Soğuk  
Cold



Sıcak  
Hot



Yağmur  
Rain



Servis  
Service

Katlanır Pencere *Foldable Window*

## Farklı Fonksiyonel Özellik

### Katlanır Pencere

3'lü ve 4'lü katlanım sistemi, 3 kanattan başlayıp 7 kanada kadar katlanım sistemi ve işlevsel detay aksesuarlarıyla binalarınıza daha geniş bir bakış açısı getirir.

## Different Functional Feature

### Foldable Window

3 to 7 foldable casements with functional hardware supply a wider perspective to the buildings.

## Kesitler Cross Sections

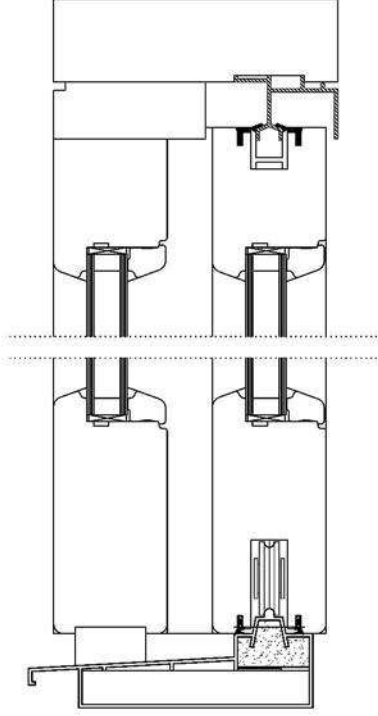

**Dikey Kesit**  
*Perpendicular Cross Section*

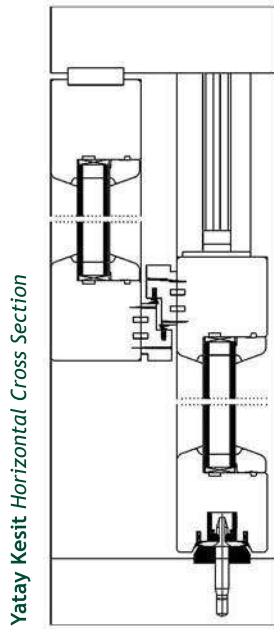

**Yatay Kesit** *Horizontal Cross Section*



### Özellikleri

- o Temizliği kolay profiller
- o 24 mm'lik cam boşluğu
- o 45° köşe birleşmeli cam çitası
- o Solmayan ve UV ışınlarından etkilenmeyen su bazlı boya
- o Isı, ses ve toz yalıtımı sağlayan EPDM fitil
- o Avrupa standartlarında zengin aksesuar seçenekleri
- o Orjinal alüminyum damlalık

### Characteristics

- o Easy to clean profiles
- o Double glazing profile clearance of 24 mm
- o 45° conner-unified glass lathe
- o Non-fading paint that is not affected by UV lights
- o EPDM wick that provides heat, sound and dust insulation
- o Wide range of accessory alternatives as European Standards
- o Original aluminum dripping channel.



Soğuk  
Cold



Sıcak  
Hot



Yağmur  
Rain



Servis  
Service

Kaldırmalı Sürme Pencere *Lifting Slide Window*

## Küçük Mekanlarda Büyük Fark

### Kaldırmalı Sürme Pencere

Mekanlarda yer kayıplarını en aza indiren ikili, üçlü kombinasyonlarda uygulanan yatay sürme pencere sistemleri ferah görüş açısı imkanı veren sistemdir.

## *Great Distinction in Small Residences*

### *Lifting Slide Window*

*Horizontal sliding windows  
up to three sashes minimize  
loss of space in the  
interiors.*

## Kesitler Cross Sections

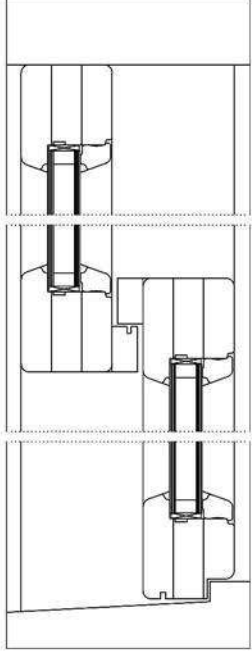

Dikey Kesit Perpendicular Cross Section

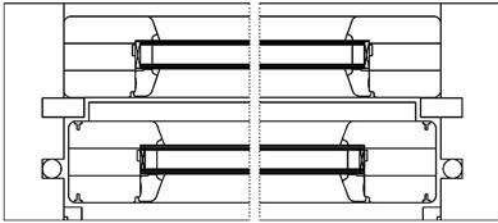

Yatay Kesit Horizontal Cross Section



### Özellikleri

- o Temizliği kolay profiller
- o 24 mm'lik cam boşluğu
- o 45° köşe birleşmeli cam çitası
- o Solmayan ve UV ışınlarından etkilenmeyen su bazlı boya
- o Isı, ses ve toz yalıtımı sağlayan özellikli fitiller
- o Tek yada çift kanadın açılabilme özelliği
- o Açılabilir kanatların vasistas olma özelliği
- o Avrupa standartlarında zengin aksesuar seçenekleri

### Characteristics

- o Easy to clean profiles
- o Double glazing profile clearance of 24 mm
- o 45° conner-unified glass lathe
- o Non- fading paint that is not affected by UV lights
- o Heat, which featured the sound and dust insulation gaskets.
- o Openability feature of a single or double leat.
- o Feature of the wings that open transom
- o Wide range of accessory alternatives as European Standards



Soğuk  
Cold



Sıcak  
Hot



Yağmur  
Rain



Servis  
Service

Giyotin Pencere *Guillotine Window*

## Üstün Konforlu, Özgün Tasarım Giyotin Pencere

Sanat eseri niteliğinde tarihi stil ve güzelliği taşıyan sistemdir. En önemli özelliği temizlik kolaylığı için iç tarafa yatırılır olmasıdır.

*Superior, Comfort,  
Specific Desing  
Guillotine Window*

*The system with a historical  
stil and beauty. It can be folded  
inside for easy cleaning.*

## Kesitler Cross Sections

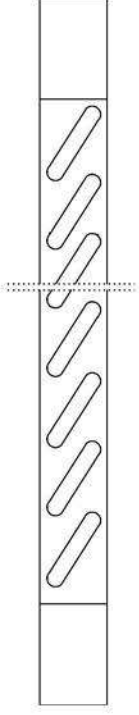

**Dikey Kesit**  
*Perpendicular Cross Section*

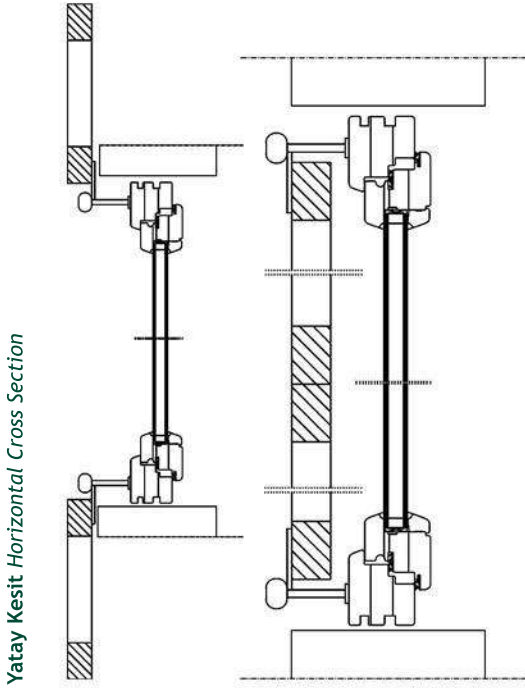

**Yatay Kesit** *Horizontal Cross Section*



### Özellikleri

- o Pencere üstüne veya duvar üzerine uygulanan aksesuar seçeneği
- o Montaj ve temizlik kolaylığı
- o Solmayan ve UV ışınlarından etkilenmeyen su bazlı boya
- o Değişik görünüş seçenekleri

### Characteristics

- o Applied on top of the window or wall accessory option
- o Installation and ease of cleaning
- o Affected by the water-based paint does not fade, and UV rays
- o Different display options.



Soğuk  
Cold



Sıcak  
Hot



Yağmur  
Rain



Servis  
Service

Panjur Shutter

## Fark Yaratan Sistem Panjur

Standart ve sürgülü pencerelere uyumlu panjur sistemleri her türlü mimariye cevap vermektedir.

## *A Distinguished System Shutter*

*The window shutter systems conforming to the standards and sliding windows satisfy all sorts of architectures.*



## Renk Skalası *Colour Scale*



## Zengin Renk Seenekleri...

### *The Rich Color Selection...*

MASPEN, Kullandığı boya su bazlı UV ışınlarına karşı koruyucu özellikte, nefes alan, su geçirmeyen ve ahşabın içindeki nemi dışarı vermeyi sağlar. Boyalar esnek yapıda olduğundan ahşabın doğal hareketliliğine direnmez böylece yüzeyde pullanma ve çatlaklara imkan vermez. Uygulaması yapılmış boyaların 3-5 yıl arasında bakım yapılması gerekmektedir.

*MASPEN, it uses water-based paint protective properties against UV light, breathable, water-tight and moisture in the wood provides to give out. Paints are flexible so that the wood surface, flaking or cracking direnmez does not allow natural mobility. Application of coatings made of 3-5 years needs maintenance.*

## Opak ve Yarı Şeffaf Renk Alternatifleri...

*Opaque and  
semi-transparent  
color alternatives...*



## Üretim Parkı *Production Line*

### HAMMADDE

MASPEN, üretim için gerek duyduğu hammadde ihtiyacını gerek yurt içinden gerekse yurt dışından, kalite ön planda tutularak özenle bir dizi testten geçirerek karşılar. Alımı yapılan hammadde TSE birinci sınıfına uygun Sarı Çam (Pinus Silverstris) Kestane (Castanea), Meşe (Oak), Meranti, Firamira vb'dir. Söz konusu doğramalık kerestenin nemi en fazla %14 olacak şekilde seçilir. Tüm bu işlemler deneyimli ekipler ve ekipmanlar tarafından titizlikle uygulanır.

### KURUTMA

İstif alanında bulunan keresteler seçildikten sonra boyut stabilizasyonu için mevcut olan vakumlu kurutma fırından ağaç türlerine göre değişik programlarda kurutulur. Kurutmada; istif düzeni, çıta kalınlıkları, kurutma şartları eğitimli operatör tarafından özenle uygulanmaktadır.

### LAMİNASYON

Kurutma fırından %12 hava kurusu nem oranıyla alınan malzeme gerekli boyuta getirildikten sonra lamine işlemine tabi tutulur. Bu işlem tam otomatik preslerde yüksek basınç ile gerçekleştirilir. Bu işlem sırasında lamine edilecek parçalar lif gerilmeleri birbirine dik olacak şekilde dizilirler. Kullanılan tutkal malzemenin suya karşı direncini arttırması için formaldehit ihtiva eder.

### BİRLEŞİM DETAYI

MASPEN, köşelerde oluşan yük gerilmeleriden ortaya çıkan kusurları önlemek ve çalışmayı minimuma indirmek için çift lamba zıvana kullanılarak birleştirilir.



### EMPRENYE

Lamine edilmiş yarı mamül doğrama boyutlarında kesilir ve lamba, zıvana ardından profil makinesinden geçerek son halini alır. Kol ve mekanizma delikleri açıldıktan sonra ham halde iken emprenye işlemine tabi tutulur. Ahşabın yapısına zarar veren organizmalar mantarlar, bakteriler, böcek ve termitlerdir... Biyolojik düşmanların zararlı etkilerini ortadan kaldırmak için organik solvent çözücü ön koruma maddesi ile otomatik tesiste 1 atm basınçta yaklaşık 1 saat süre ile (ağaç türüne göre değişir) 1m<sup>3</sup> ahşap malzemeye ortalama 20 lt. emprenye maddesi nüfuz ettirilir. Bu sayede ahşap malzeme 60 yıl hizmet ömrü kazanır.

### SU TOPLAMA KANALI

Suyu toplamak ve tahliye etmek amacıyla alüminyum damlalık kullanılır. Alüminyum kanalın her iki ucuna geçirilen plastik tıpa ile ahşabın arası silikon ile doldurulur.

### SIZDIRMAZLIK FİTİLİ

MASPEN doğramalarında özel alıştırılmış EPDM fitil kullanılmaktadır. Fitil çift EPDM'den mamül olup kapalı gözenekli yapıdadır. Sert kısım fitilin direncini yumuşak kısım sızdırmazlığı sağlar. Bu özelliğini 15 yıl kaybetmez. Köşeler seviye fatkı yaratamayacak şekilde yekpare döner.





Kartal Fabrika Factory in Kartal



BirMob

**Birmob Mobilya İnşaat Sanayi ve Ticaret Limited Şirketi**

**Fabrika / Showroom:**

Çavuşoğlu Mahallesi Yalnız Selvi Cad. No: 18 Kartal - İstanbul / Türkiye  
Tel: +90 216 517 62 77 Tel: +90 216 517 62 84 Fax: +90 216 306 59 35

maspen@maspen.com www.maspen.com  
info@birmob.com www.birmob.com