

Meet some of the new products for 2019:



Chair To Go!
page 34



CalStor Art
Storage
page 85



Transport Trolleys
page 86



Active Balance
Stool page 34



Open Unit
page 63



STEM Trolley
page 91



Chester Mesh
pages 247, 270



Role Play Panels
page 108



Helsingborg
page 224



Louis Seating
page 260



Peak
page 261



Vogue Seating
page 264



Dormitories
pages 340-343



Retreat
page 236

contents

classroom furniture	2-47
classroom storage	48-99
early years	100-127
cloakrooms & lockers	128-141
IT suites	142-155
dining furniture	156-179
libraries & learning zones	180-197
staging & auditorium seating	198-207
seating	208-279
receptions	280-293
conference & meeting tables	294-307
office desking & storage	308-365
presentation & display	366-397
acoustic surfaces	398-403
outdoor furniture	404-421
design & refurbishment	422-443
index	444-448

New
Product

Recycled

Express
Delivery

5 Year
Warranty

Best
Seller

We want to help you get the right products and the best deals, so please look out for products with these highlights.



See Pages 8-9

Cluster tables have unlimited possibilities for arranging into different shapes for flexible room layouts



See Page 76

Use room dividers to define areas without compromising space



See Pages 128-137

See Pages 126-139

Don't forget personal storage to keep the space tidy and organised

RETHINKING THE CLASSROOM

ARE FLEXIBLE SCHOOL ENVIRONMENTS THE FUTURE OF EDUCATION?

Latest research shows that activity based furniture will enable the best education experience.



See Pages 182-184

Create a learning hub within your school to encourage pupils to explore different ways of learning and take charge of their own education experience. Excellent for assisting students with different learning styles and also prepares them for lifelong learning.



See Page 194

Modular seating is adaptable and easy to incorporate into any space



See Page 34

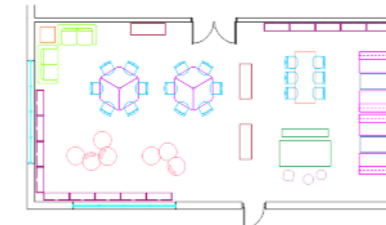

See Page 34



See Page 232

Use booth seating for quiet working



See Pages 238-239

Use landscape furniture such as building block style seating to encourage students to create their own space



See Page 299



See Page 178

Breakout style furniture provides a creative environment away from the classroom

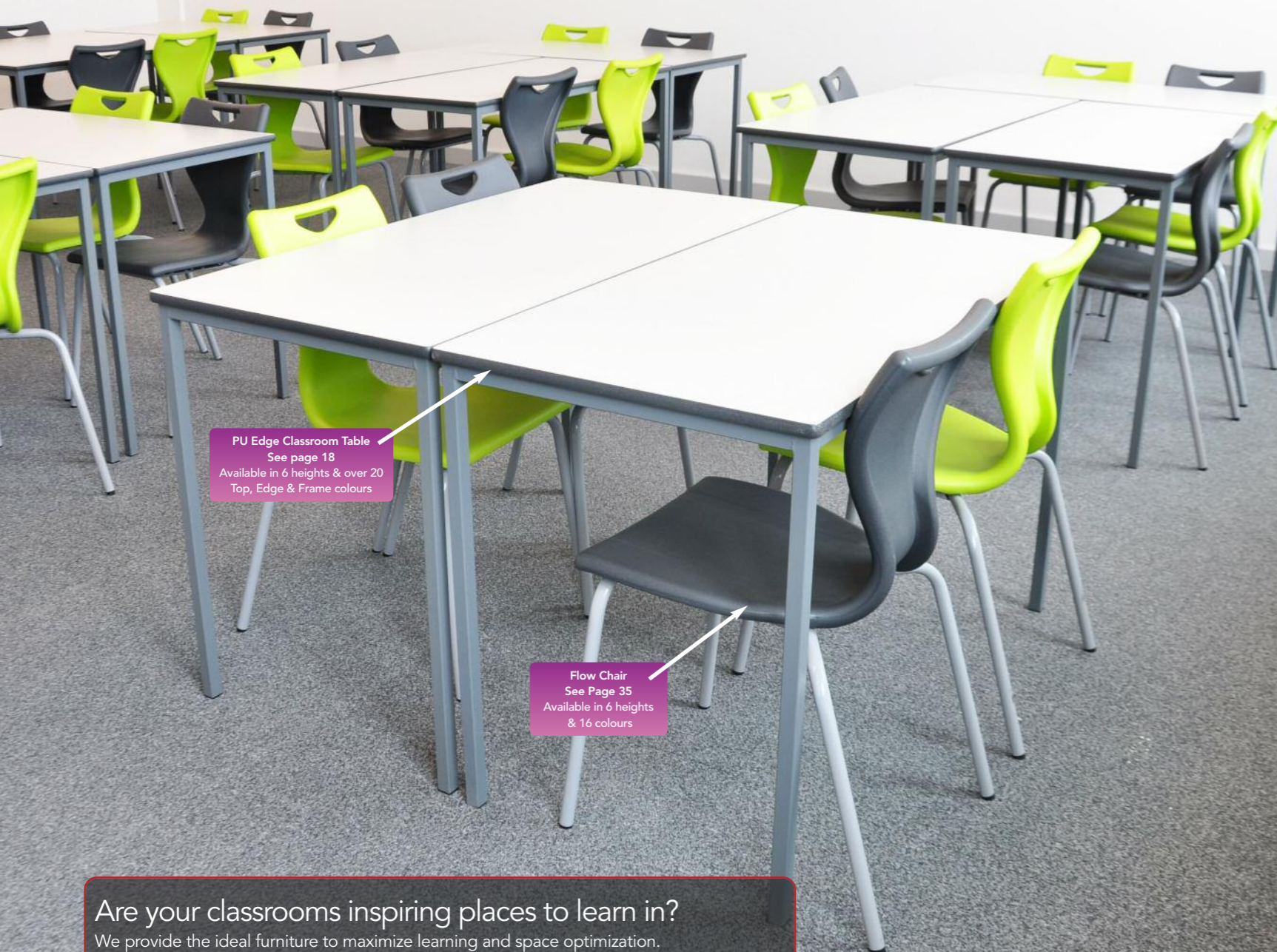

PU Edge Classroom Table
See page 18
Available in 6 heights & over 20
Top, Edge & Frame colours

Flow Chair
See Page 35
Available in 6 heights
& 16 colours

Are your classrooms inspiring places to learn in?

We provide the ideal furniture to maximize learning and space optimization.

Classroom Furniture

Creative Cluster Tables	8-9	Poly Superior	31
Calypso	10	Atlas Chair	32
Fast Track	11	Forum Chair	32
Premium Range	12-13	Contour Chair	33
Classroom Tables	14-21	Flow Chair	35
Craft Tables	22	Mono Posture Chair	36,37
Work Benches	23	Chevron Chair	38
Height Adjustable Desks	24	Positive Posture	39
Wooden Locker Desks	25	Perennial Upholstered Chair	40
Teacher's Desks	26-27	Folding Chairs & Trolleys	41
Poly Chairs	28-33	Stools	42-45
Planet Chair	29	Exam Desks & Chairs	46-47
Classic Chair	30		

Classroom Furniture

Ordering school furniture can be a daunting task, especially when spending so much of your school budget. If you are kitting out a new classroom or replacing a number of tables and chairs then simply selecting from a catalogue may not be the best option.

We can advise on the best table and chair heights, surfaces and edge options and the best classroom layouts for your needs. We have years of experience and will take all your needs into account - your budget, the age of the pupils, and the type of uses and environment that the furniture will be used in. Whether it is DT benches and stools, IT

seating, or standard classroom furniture you require, we will be happy to advise on health and safety considerations, British Standards, lighting and ergonomics.

There is no obligation to buy from us, but we would welcome the opportunity to provide you with a quote and to prepare layout drawings for you to consider.

We have the expertise to protect you from potentially costly mistakes, so please call us today to discuss your requirements.

Express delivery on 7 - 10 days on a range of fast moving products in the most popular colours.

Look out for the Express icon:

Express Delivery



Express products marked with *

Note: this service may not always be available in the summer months
- Please Order Early

Table & Chair Heights Choosing Tables and Chairs Recommended BS EN1729

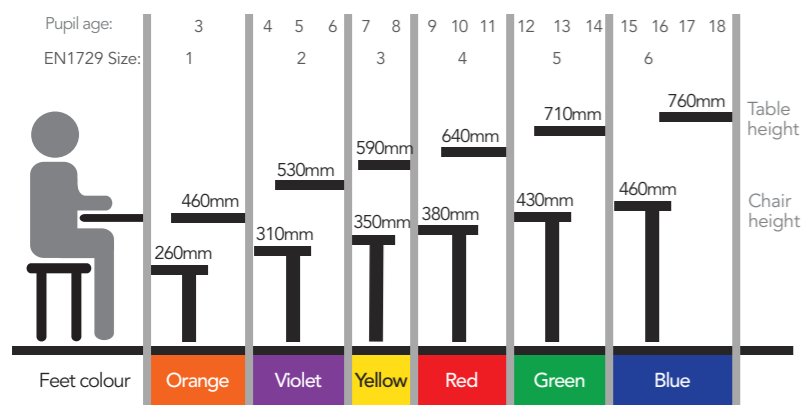

Not sure? Please ask for a sample chair or for a consultant to call and check your heights.

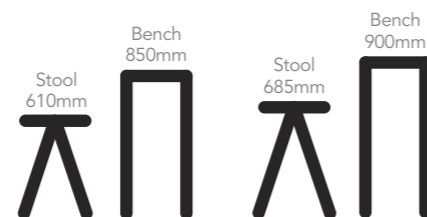

Choosing Your Tables

3 Table Styles

Crushbent frame - the best option if the tables need to be stacked frequently, the tables can be slide stacked easily.



Fully welded frame - the most popular choice, strong and durable, the tables will stack in a spiral fashion.



Premium frame - Round leg frame gives an extremely strong and modern, attractive look to the classroom, can be spiral stacked.



3 Edge Styles

MDF edge - Lacquered natural wood edge gives a low cost tamperproof solution.

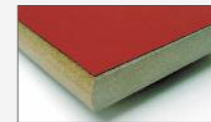

PVC edge - Introduce colour by having a matching or contrasting edge in a wide range of colours, impact resistant.



PU (polyurethane) edge - The ultimate choice, spray applied polyurethane gives a seamless, water resistant, textured durable edge to the table.



3 Top Styles

Standard Laminate



10 Colours

Premium Laminate



9 Colours

Whiteboard Laminate



Accepts drywipe pens

New Product

See page 13

Deliveries for the start of the Autumn term

- **Order in May to avoid delay!**
- Please include a site contact & phone number
- Please ensure all details are included on your order to avoid delays in starting production
- Please check our order confirmation carefully, as classroom furniture is made to order
- Please do not dispose of your old furniture until the new arrives!
- Please could you help us by ordering classroom furniture required for the start of the Autumn term as soon as possible, ideally by May or early June.
- Please advise us of your school opening times during the summer holiday.

Phone For Bulk Prices

10 Year Warranty

A



Segment Table (4 Tables create a 1750mm Diameter layout - sold individually)



Creative Cluster Tables

A. Segment tables

- Truly unique shape offers endless creativity
- Can be used individually as an ergonomic workstation
- Size: 1220mm x 875mm
- 10 Year guarantee
- 25mm top in either premium or standard laminates
- 710mm high as standard, other heights available on request



YCCTL158 Please ring for best price

B



B. Diamond tables

- New stylish Diamond Tables for classroom flexibility
- Extremely versatile with various shape combinations
- 3 together create a hexagonal shape of 1730mm diameter
- Each individual table is 1440mm x 866mm
- 25mm top in either premium or standard laminates
- 10 year guarantee
- 710mm high as standard other heights are available on request



Y15601 £181.85



Colour Options

PU Edge colours:



Frame colours

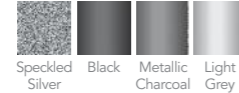

Frame colours: textured silver grey, light grey, metallic charcoal or black. Silver grey will be supplied unless otherwise stated

Top colours Standard

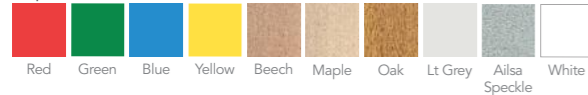

Top colours Premium: +10%



Drywipe See page xx

Phone For Bulk Prices

5 Year Warranty

A



Creative Cluster Tables

A. Clover table

- Flexible and dynamic classroom solution
- Ideal for breakout areas
- 18mm top in either premium or standard laminates
- Size: 940 x 600 x H710mm
- 5 Year guarantee
- Other heights available on request
- Castors available POA



YCCTC126 Please ring for best price

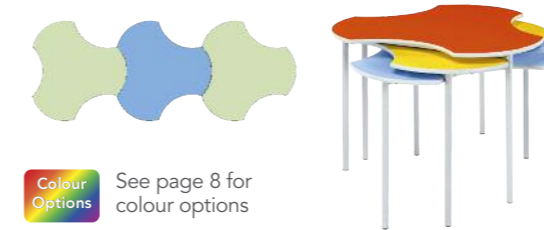

Colour Options See page 8 for colour options

B. Pie table

- Mobile, individual workstation
- Triangular shape offers ultimate flexibility
- 5 year guarantee
- Optional power pole available
- Table size: 750 x 600 x h710mm
- Other heights are available on request
- 6 pie tables form a circular shape of 1635mm
- Mobile table has a castor on one leg



YCCP76 Table Please ring for best price

YCCP76C Mobile Table Please ring for best price

Colour Options See page 8 for colour options



5 Year Warranty

B

Pie tables forming a circle allowing cable management in the centre.



Optional power pole

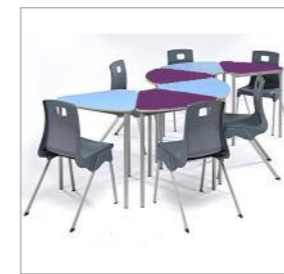

Bespoke sizes available. Please contact us for details.



These tables have slimline 32mm legs allowing more spacing for chairs.
Note: premium colours incur a 10% extra charge on this range.



5 Year Warranty



Square

Trapezoidal

Arc



Semi Circular

Rectangle

Circular



Please specify:
1. height 2. frame colour
3. top colour 4. edge colour

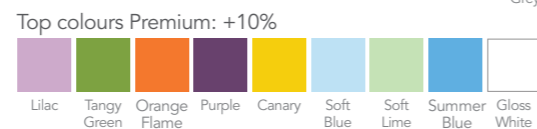
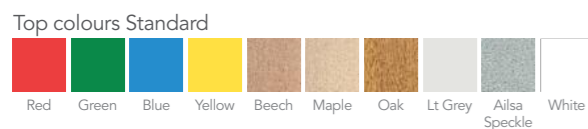

Calypso Heavy Duty Furniture

Some educational environments demand furniture that will withstand greater wear and tear, these products are manufactured to last and last together with eye-catching style

Heavy duty tables

- 32mm welded tubular frame
- 18mm thick top with a balancing laminate and PU textured edge
- Tamperproof screws
- Choice of laminate colours and Trespa Tops (POA)
- Heavy duty castors can be fitted on 2 legs for mobility at additional cost
- 710mm height as standard, other heights available to order
- Frame colours: DURAFORM scratch resistant textured silver grey, light grey, metallic charcoal or black. Silver grey will be supplied unless otherwise stated
- Orders of less than 5 tables may carry a delivery charge

Textured PU Edge, standard laminate

Y16435	1200 x 600mm Rectangular	£78.90
Y16438	600 x 600mm Square	£61.40
Y16441	1200mm Trapezoidal	£75.20
Y16444	1200mm Semi Circular	£86.70
Y16447	1200mm Circular	£137.10
Y15602A	1490 x 600mm Arc	£161.60
Y16449	Set of Heavy Duty Castors (2)	£41.90

Premium laminates - above price plus 10%

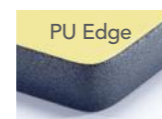

PU Edge colours:



Lt Grey Blue Charcoal Red Green

Frame colours



Light Grey Black Metallic Charcoal Silver Grey

Fast Track Tables & Chairs

A. Graduate chairs

- Stocked with Silver-Grey Frame in 2 senior heights
- Natural wood colour
- Solid Beech edge
- Orders of less than 10 chairs may carry a delivery charge

		1-29	30+
Y16532	460mm High Chair	£45.80	POA
Y16533	430mm High Chair	£45.80	POA

Express Delivery

15 Year Warranty

Fast Track - Express Delivery

B. Graduate tables

- Stocked in Beech with Silver-Grey Frame in 2 senior heights
- Solid Beech Edging
- 25mm premium top
- 15 Year Frame Guarantee
- Orders of less than 8 tables may carry a delivery charge

		1-29	30+
Y16528	600 x 600 x 710mm Desk	£69.50	POA
Y16529	600 x 600 x 760mm Desk	£69.50	POA
Y16530	1200 x 600 x 710mm Desk	£95.90	POA
Y16531	1200 x 600 x 760mm Desk	£95.90	POA

C. Premium express tables

- Stocked in Beech and Grey with Silver-Grey Frame in 2 senior heights
- 18mm thick tops with Charcoal PU rounded edge
- 32mm Round Leg
- 10 Year Frame Guarantee
- Orders of less than 10 tables may carry a delivery charge

		1-29	30+
Y16536	600 x 600 x 710H	£49.90	POA
Y16537	600 x 600 x 760H	£49.90	POA
Y16538	1200 x 600 x 710H	£65.50	POA
Y16539	1200 x 600 x 760H	£65.50	POA



Top Colours

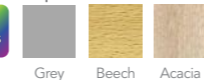

Grey Beech Acacia

Frame Colours

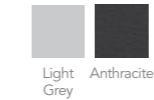

Light Grey Anthracite Grey



New Colours 2019



Premium primary range



- Modern design and bright colours, ideal for nursery and primary classrooms
- Highest quality fully welded tables with stylish, chunky 32mm tubular legs
- Standard 18mm tops in MDF Bullnose edge with a hard wearing laminate - polished and laquered
- Exceptional strength and style vastly superior to bolt-on and screw on leg systems
- Top choice for Early Years classrooms
- Orders of less than 3 tables may carry a delivery charge
- Primary colours will be supplied with a matching frame unless otherwise stated
- Premium colours - please add 10%



FULLY EN1729 COMPLIANT

5 Year Warranty

Phone For Bulk Prices

Rectangular	1-5	6+
Y15773 1100 x 550 x H460mm	£68.90	POA
Y15774P 1100 x 550 x H530mm	£68.90	POA
Y15775 1100 x 550 x H590mm	£68.90	POA
Y15788A 1100 x 550 x H640mm	£68.90	POA

Trapezoidal	1-5	6+
Y15776P 1100 x 550 x H460mm	£68.90	POA
Y15777 1100 x 550 x H530mm	£68.90	POA
Y15778P 1100 x 550 x H590mm	£68.90	POA
Y100120 1100 x 550 x H640mm	£68.90	POA

Circular	1-5	6+
Y15779 1100 Diameter x H460mm	£119.00	POA
Y15780P 1100 Diameter x H530mm	£119.00	POA
Y15781 1100 Diameter x H590mm	£119.00	POA
Y100121 1100 Diameter x H640mm	£119.00	POA

Semi Circular	1-5	6+
Y16724 1200 Semi Circle x H460mm	£84.30	POA
Y16725 1200 Semi Circle x H530mm	£84.30	POA
Y16726 1200 Semi Circle x H590mm	£84.30	POA
Y15794A 1200 Semi Circle x H640mm	£84.30	POA

- Textured PU edge is available at additional cost

Colour Options Please specify: 1. frame colour 2. top colour

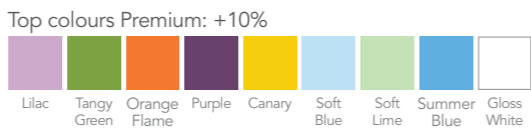
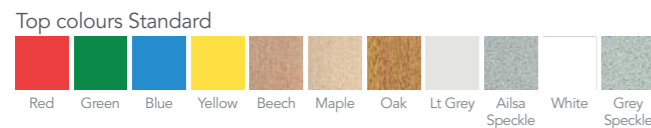
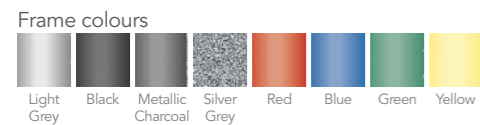

Premium senior range



- Highest quality fully welded tables with stylish, chunky 32mm tubular legs
- Standard 18mm tops in MDF Bullnose edge with a hard wearing laminate - polished and laquered
- Also available with Duraform spray PU edge - POA
- Also available in 16mm Trespa top - which is a solid grade material with a black core and crystal matt surface texture, with smooth and sealed edges. It is particularly suitable for laboratory and food preparation areas. (POA)
- Exceptional strength and style vastly superior to bolt-on and screw on leg systems
- Orders of less than 3 tables may carry a delivery charge
- Colours as shown on page 12

Square	1-5	6+
Y15783 600 x 600 x H710mm	£59.30	POA
Y15784A 600 x 600 x H760mm	£59.30	POA

Rectangular	1-5	6+
Y15789 1200 x 600 x H710mm	£69.90	POA
Y15790A 1200 x 600 x H760mm	£69.90	POA

Semi Circle	1-5	6+
Y15792A 1200 Semi Circle H710mm	£84.30	POA
Y15793 1200 Semi Circle H760mm	£84.30	POA

Colour Options See page 12 for colour options



5 Year Warranty

Phone For Bulk Prices



Whiteboard drywipe tables

Drywipe whiteboard tops are available on all sizes of tables - please contact us for details.



New Product

Best Seller



Classroom Tables - Crushbent Frame

- The following range of crushbent framed tables is one of the largest in the UK
- All our products have been proved suitable for severe educational use
- This fast selling table is very popular as it can be easily stacked due to the frame design
- The top has a MDF core with a hard wearing laminate finish
- Frame colours: black, light grey or metallic charcoal (other frame colours available as specials POA), black will be supplied unless specified
- Choice of rounded MDF or square PVC edge, a rounded PVC edge is also available POA
- Orders of less than 5 tables may incur a carriage charge

A



MDF edge

5 Year Warranty

On All These Products

Phone For Bulk Prices

Express Delivery on Items Marked*

*Outside summer period

B



Colour Options

- Choose
1. frame colour
 2. top colour
 3. edge colour (if PVC)

Classroom Tables - Crushbent Frame



A. 1100 x 550mm trapezoidal

- Crushbent for easier stacking

Rounded MDF Edge		1-29	30+
Y15742	H460mm	£55.90	POA
Y15746	H530mm	£55.90	POA
Y15750	H590mm	£55.90	POA
Y15754	H640mm	£55.90	POA
Y15758	H710mm	£55.90	POA
Y15762	H760mm	£55.90	POA

Square PVC Edge		1-29	30+
Y15744	H460mm	£57.60	POA
Y15748	H530mm	£57.60	POA
Y15752	H590mm	£57.60	POA
Y15756	H640mm	£57.60	POA
Y15760	H710mm	£57.60	POA
Y15764	H760mm	£57.60	POA

Also available in 1200 x 600mm POA

B. 600 x 600mm square

- Crushbent for easier stacking

Rounded MDF Edge		1-29	30+
Y15766	H460mm	£42.90	POA
Y15770	H530mm	£42.90	POA
Y15774	H590mm	£42.90	POA
Y15778	H640mm	£42.90	POA
Y15782*	H710mm	£42.90	POA
Y15786*	H760mm	£42.90	POA

Square PVC Edge		1-29	30+
Y15768	H460mm	£46.60	POA
Y15772	H530mm	£46.60	POA
Y15776	H590mm	£46.60	POA
Y15780	H640mm	£46.60	POA
Y15784	H710mm	£46.60	POA
Y15788	H760mm	£46.60	POA

Delivery

All classroom tables and chairs are delivered fully assembled. Delivery approximately 4 weeks although this will extend over the summer ordering period. We recommend you do not dispose of your old furniture until you have taken delivery of your new.

Colour Options

PVC Edge Colours



Edge Options

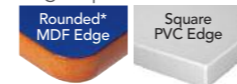

Top colours Standard

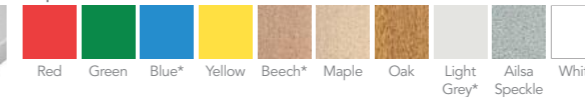

* Available on express delivery outside summer holiday period

Frame colours

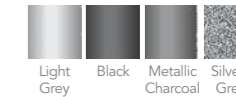

FULLY EN1729 COMPLIANT

Express Delivery on Items Marked*

Phone For Bulk Prices

*Outside summer period



A

Gloss White 'Dry Wipe' option at extra cost on standard tables

Order code: Y100102 £10.95



B

Page Link - see pages

For more poly chairs

28-36



Phone For Bulk Prices

Express Delivery on Items Marked*

*Outside summer period

5 Year Warranty

On All These Products

FULLY EN1729 COMPLIANT

Delivery

All classroom tables and chairs are delivered fully assembled. Delivery approximately 4 weeks although this will extend over the summer ordering period. We recommend you do not dispose of your old furniture until you have taken delivery of your new.

A



Spray PU Edge

B



C



Also available in 1200 x 600mm POA

D



Colour Options

Please specify:
1. frame colour
2. top colour
3. edge colour

Express Delivery on Items Marked*

*Outside summer period

Phone For Bulk Prices

5 Year Warranty

On All These Products

Gloss White 'Dry Wipe' option at extra cost on standard tables

Order code: Y100102 £10.95

A



B



C



D



Also available in 1200 x 600mm POA

E



Frame colours

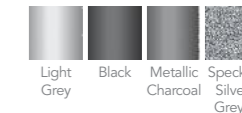

PU Edge colours:



PU Edged Tables



- Impact Resistant - Waterproof Edge Guarantee
- This new technology in table manufacturing is extremely popular as the textured coloured edging is moulded onto the edge of the table, meaning that it cannot be prised or picked away
- Give your classroom an unfading, long lasting, colourful feel with these bright, cheerful and popular classroom tables
- Available with crushbent (stacking) or fully welded frames
- Frame colours: black, light grey or metallic charcoal (other frame colours available as specials POA), black will be supplied unless specified
- Orders of less than 5 tables may incur a carriage charge

A. 1200 x 600mm rectangular

- Crushbent frame

PU Edged		1-29	30+
Y15496	H460mm	£59.90	POA
Y15498	H530mm	£59.90	POA
Y15500	H590mm	£59.90	POA
Y15502*	H640mm	£59.90	POA
Y15504*	H710mm	£59.90	POA
Y15506*	H760mm	£59.90	POA

B. 1100 x 550mm rectangular

- Crushbent frame

PU Edged		1-29	30+
Y15507	H460mm	£58.90	POA
Y15508	H530mm	£58.90	POA
Y15510	H590mm	£58.90	POA
Y15512*	H640mm	£58.90	POA
Y15514*	H710mm	£58.90	POA
Y15516*	H760mm	£58.90	POA

C. 1100 x 550mm trapezoidal

- Crushbent frame

PU Edged		1-29	30+
Y15530	H460mm	£63.10	POA
Y15532	H530mm	£63.10	POA
Y15534	H590mm	£63.10	POA
Y15536	H640mm	£63.10	POA
Y15538	H710mm	£63.10	POA
Y15540	H760mm	£63.10	POA

D. 600 x 600mm square

- Crushbent frame

PU Edged		1-29	30+
Y15518	H460mm	£51.20	POA
Y15520	H530mm	£51.20	POA
Y15522	H590mm	£51.20	POA
Y15524	H640mm	£51.20	POA
Y15526*	H710mm	£51.20	POA
Y15528*	H760mm	£51.20	POA

A. 1200 x 600mm rectangular

- Welded frame

PU Edged		1-29	30+
Y15554	H460mm	£59.90	POA
Y15556	H530mm	£59.90	POA
Y15558	H590mm	£59.90	POA
Y15560*	H640mm	£59.90	POA
Y15562*	H710mm	£59.90	POA
Y15564*	H760mm	£59.90	POA

B. 1100 x 550mm rectangular

- Welded frame

PU Edged		1-29	30+
Y15566	H460mm	£58.90	POA
Y15568	H530mm	£58.90	POA
Y15570	H590mm	£58.90	POA
Y15572*	H640mm	£58.90	POA
Y15574*	H710mm	£58.90	POA
Y15576*	H760mm	£58.90	POA

C. 600 x 600mm square

- Welded frame

PU Edged		1-29	30+
Y15578	H460mm	£51.20	POA
Y15580	H530mm	£51.20	POA
Y15582	H590mm	£51.20	POA
Y15584	H640mm	£51.20	POA
Y15586*	H710mm	£51.20	POA
Y15588*	H760mm	£51.20	POA

D. 1100 x 550mm trapezoidal

- Welded frame

PU Edged		1-29	30+
Y15590	H460mm	£63.10	POA
Y15592	H530mm	£63.10	POA
Y15594	H590mm	£63.10	POA
Y15596	H640mm	£63.10	POA
Y15598	H710mm	£63.10	POA
Y15600	H760mm	£63.10	POA

E. 1000mm diameter circular

- Welded frame

PU Edged		1-29	30+
Y15602	H460mm	£101.20	POA
Y15604A	H530mm	£101.20	POA
Y15606A	H590mm	£101.20	POA
Y15608A	H640mm	£101.20	POA
Y15610A	H710mm	£101.20	POA
Y15612	H760mm	£101.20	POA

Top colours Standard

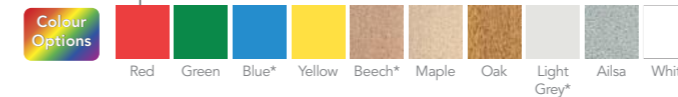

* Available on express delivery outside summer holiday period



Rounded PU Edge



Phone For Bulk Prices

5 Year Warranty

Tray Tables



- Provide some individual storage for the students with these standard classroom tables with special tray packs fitted
- The tables will take all standard trays and some very attractive colour schemes can be worked in the classrooms through use of the trays and table tops
- Frame colours: black, light grey, silver grey or metallic charcoal (other frame colours available as specials POA), black will be supplied unless specified
- Please check that pupils will have sufficient leg room under tray tables; you may wish to move up a size
- Orders of less than 5 tables may incur a carriage charge

A. 1200 x 600mm rectangular

- Welded frame tables

MDF Edge		1-29	30+
Y15614A	H460mm	£76.60	POA
Y15618A	H530mm	£76.60	POA
Y15622A	H590mm	£76.60	POA
Y15626A	H640mm	£76.60	POA
Y15630A	H710mm	£76.60	POA
Y15634A	H760mm	£76.60	POA

Square PVC Edge		1-29	30+
Y15616	H460mm	£81.80	POA
Y15620A	H530mm	£81.80	POA
Y15624A	H590mm	£81.80	POA
Y15628A	H640mm	£81.80	POA
Y15632A	H710mm	£81.80	POA
Y15636A	H760mm	£81.80	POA

Tray tables can also be supplied with a Polyurethane edge instead of PVC- ring for details

Edge Options

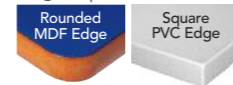

PVC Edge Colours



Frame colours

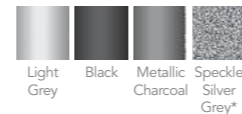

Colour Options

- Please specify:
1. frame colour
 2. top colour
 3. edge colour (if PVC)
 4. tray colour (see page 50, stock colours only)

Top Colours Standard * Express delivery available outside summer holiday period

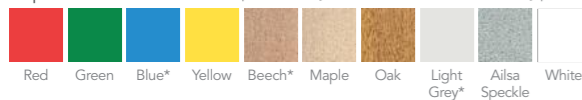

A. 1100 x 550mm rectangular

- Welded frame tables

MDF Edge		1-29	30+
Y15638A	H460mm	£76.60	POA
Y15642	H530mm	£76.60	POA
Y15646	H590mm	£76.60	POA
Y15650	H640mm	£76.60	POA
Y15654B	H710mm	£76.60	POA
Y15658A	H760mm	£76.60	POA

Square PVC Edge		1-29	30+
Y15640	H460mm	£81.80	POA
Y15644	H530mm	£81.80	POA
Y15648	H590mm	£81.80	POA
Y15652A	H640mm	£81.80	POA
Y15656A	H710mm	£81.80	POA
Y15660	H760mm	£81.80	POA



Phone For Bulk Prices

5 Year Warranty

B. 600 x 600mm square

- Welded frame tables • Single tray

MDF Edge		1-29	30+
Y15662	H460mm	£61.70	POA
Y15666	H530mm	£61.70	POA
Y15670	H590mm	£61.70	POA
Y15674	H640mm	£61.70	POA
Y15678	H710mm	£61.70	POA
Y15682	H760mm	£61.70	POA

Square PVC Edge		1-29	30+
Y15664	H460mm	£66.90	POA
Y15668	H530mm	£66.90	POA
Y15672	H590mm	£66.90	POA
Y15676	H640mm	£66.90	POA
Y15680	H710mm	£66.90	POA
Y15684	H760mm	£66.90	POA

Tray tables can also be supplied with a Polyurethane edge instead of PVC- ring for details

Colour Options

- Please specify:
1. frame colour
 2. top colour
 3. edge colour (if PVC)
 4. tray colour (see page 50, stock colours only)

Top Colours Standard * Express delivery available outside summer holiday period

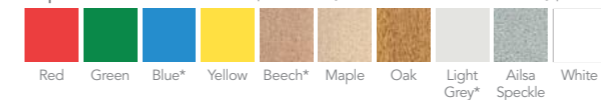

Edge Options



PVC Edge Colours



Frame colours

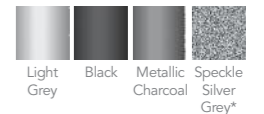

A

Express
DeliveryPhone
For Bulk
Prices

Craft Tables



A. Project table

- Sturdy tables for all types of projects
- Light grey laminated tops for durability
- All 800mm high for ease of use
- Frame colours: Grey, Apple Green, Cool Blue, Cyan, Lime, Red & Tangerine

Y15986	W1200 x D1200mm	£359.30
Y15988	W1800 x D1200mm	£465.40
Y15990	W2400 x D1200mm	£558.50

B. Heavy duty craft tables

- Extremely strong H frame table, square heavy duty frame
- Laminate or Trespa tops available
- Heights available are 760, 800, 850, 900, 1000mm
- MDF edge, PU also available POA

Laminate Top

Y15604	1200mm x 600mm	POA
Y15605	1200mm x 750mm	POA
Y15606	1500mm x 750mm	POA

Trespa Top

Y15607	1200mm x 600mm	POA
Y15608	1200mm x 750mm	POA
Y15609	1500mm x 750mm	POA

C. Premium 'H' frame craft table

- Extremely strong H frame table, round heavy duty 45mm frame
- Laminate or Trespa tops available
- Heights available are 760, 800, 850, 900, 1000mm
- MDF edge, PU also available POA

Laminate top

YPREM126LAM	1200mm x 600mm	POA
YPREM127LAM	1200mm x 750mm	POA
YPREM157LAM	1500mm x 750mm	POA

Trespa top

YPREM126TRES	1200mm x 600mm	POA
YPREM127TRES	1200mm x 750mm	POA
YPREM157TRES	1500mm x 750mm	POA

When ordering, please specify:
1. height 2. frame colour 3. top colour - Laminate or Trespa

Other colours available. For critical colour matching please ask for a sample

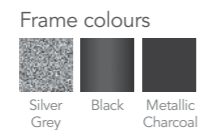
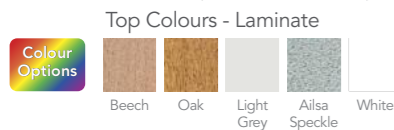

Page Link - see page

For
stools...

42-45



Work Benches

A. Heavy duty steel frame workbench suitable for
woodwork and metalwork

- 1200 x 1200mm choice of 810 or 860mm height
- Available with or without cupboards
- Choice of tops (metal, phenolic etc)
- Choice of frame colours
- Choice of flip over tool well (as illustrated) or solid beech flush tops
- Orders of less than 5 benches may incur a carriage charge

Solid Beech Top

155011	Workbench with Cupboard	£1115.00
155012	Workbench without Cupboard	£665.00

MDF Top with Solid Beech Edgings

155013	Workbench with Cupboard	£930.00
155014	Workbench without Cupboard	£478.00

Vice for Benches

155015	175mm Plain Screw Woodwork Vice	£87.50
--------	---------------------------------	--------

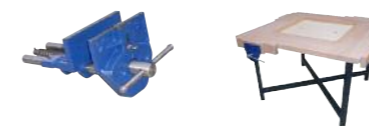

Frame Colours



B. Multipurpose technology bench

- 1200 x 1200 x 860mm height (other heights available)
- Choice of frame colours
- Choice of tops
- Orders of less than 5 benches may incur a carriage charge

155018	Bench with MDF Top	£363.00
155019	Bench with Zinctec Metal Top	£496.00
155020	Heavy Duty Castors for Bench set of 4	£69.50

New
ProductNew
Product

Bespoke Work Benches And Tables Available- Please Ask For Details
Quantity Discounts Available



Can be accessed from either side



Portholes can be added on request for additional cost



Removable Handle - Top or Side Operated



Phone For Bulk Prices

A full range of other sizes are available

Colour Options

Please specify:
1. frame colour 2. edge colour if PVC

Top colours Standard



PU Edge colours: Additional cost



Edge Options



Access height adjustable table

- Modern silver frame, strong construction
- Infinitely adjustable by handle between 512 and 805mm
- Suitable for wheelchair use
- MDF or PU edge (POA)
- Available with Trespa tops for science or food tech use - poa

1200 x 600mm Double Desk

Y15802 Access Desk - MDF Edge POA

750 x 600mm Single Desk

Y15803 Access Desk - MDF Edge POA

Heavy Duty Top 25mm

Y16727 Additional Cost POA



Straight Top Locker Desks



- These traditional desks are still popular throughout education and with good reason as they provide a sturdy, quality, long-lasting solution
- The desk frame is solid beech with mortice and tenon joints, glued and screwed for extra strength
- The desk lid is a beech melamine MDF top providing a matching finish
- The straight top locker desks have a pen groove on the back edge and are available as single or double desks
- The width between the legs is suitable for most chair types, internal width is shown below
- Orders of less than 6 tables may carry a delivery charge

A. Double locker desks

	h x w x d mm	Internal width	6-19	20+
Y16406	650 x 1100 x 456	1004mm	£214.00	POA
Y16408	700 x 1100 x 456	1004mm	£214.00	POA
Y16410	750 x 1100 x 456	1004mm	£214.00	POA

Did you know?

- Beech melamine MDF tops increase the lifespan by three times compared to solid beech tops
- Coloured tops are also available to order. Please call for details

B. Single locker desks

	Internal h x w x d mm	width	6-19	20+
Y16400	650 x 600 x 456	500mm	£146.00	POA
Y16402	700 x 600 x 456	500mm	£146.00	POA
Y16404	750 x 600 x 456	500mm	£146.00	POA

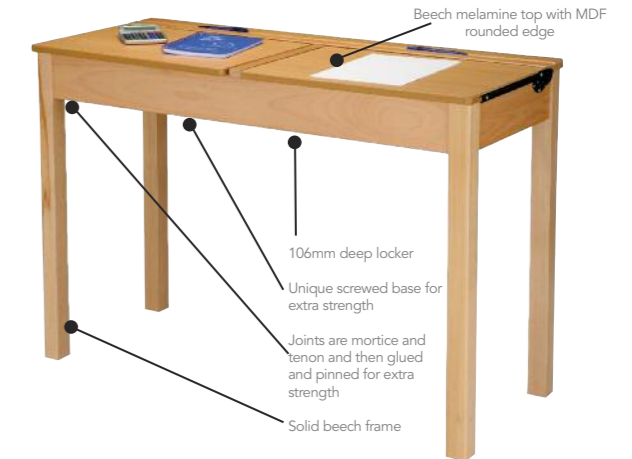

A



B



Also available...
...sloping top and stepped locker desks. Please ask for details

Express Delivery 7 Year Warranty

A



Teacher's Desks



A. Single pedestal desk

- This popular range of teacher's desks is available in a choice of wood finishes
- Drawers are mounted with metal runners and are fully lockable
- 3 drawer on right side supplied as standard, a 2 drawer pedestal including a filing drawer is also available at the same cost. Pedestals can be fitted on either side, please specify
- 5 year guarantee
- Quantity discounts available

Y15490	1200 x 745 x 725mm High	£199.75
Y15492	1500 x 745 x 725mm High	£227.70

Please specify melamine wood finish as shown below

Express Delivery 5 Year Warranty

B



B. Double pedestal desk

- The double pedestal desk is a long-standing favourite with teachers, providing extra storage and a filing drawer
- Drawers are mounted with metal runners and are lockable
- 5 year guarantee
- Quantity discounts available

Y15494	1500 x 745 x 725mm High	£281.00
--------	-------------------------	---------

Please specify melamine wood finish as shown below

Colour Options

Frame Options

Beech Grey	Lt Oak Brown	Maple (3-4 Week Delivery)

Page Link - see page

For teacher's cupboards **56**



Page Link - see page

For teacher's chairs **242-244**



Express Delivery 5 Year Warranty

A



Teacher's Desks



A. Alpine panel leg teacher's desk

- 25mm thick MFC top with 3mm abs edging
- Choice of 6 colours
- Locking drawers
- Complete with 2 cable ports
- 5 year warranty
- Matches Alpine furniture on page 310

Y100100	Single Pedestal Desk	1200 x 800 x H725mm	£269.00
---------	----------------------	---------------------	---------

Y100101	Double Pedestal Desk	1600 x 800 x H725mm	£399.90
---------	----------------------	---------------------	---------

Colour Options

Group 1 Colours

Lt Beech (T)*	Birch (P)	White Oak (D1)	White (M1)	Amber Oak

Group 2 Colours (+7.5%)

Walnut (U)	Lt Grey (N)

For critical colour matching please ask for a sample

*Express delivery on Light Beech

B. Colorado compact desk

- Compact teacher's desk with lockable 3 drawer pedestal
- 1200 x 600mm
- 12 finishes are available
- Complete with 2 cable ports
- 5 year warranty

Y100103	Colorado Compact Desk	£275.00
---------	-----------------------	---------

Colour Options

Wood Finish Options

Walnut	Verade Oak	Autumn Cherry	Beech	Ash	White	Nebraska Oak
Barley	Light Oak	Maple	Grey	Anthra-cite	Concrete	Grey Cedar

Express Delivery 5 Year Warranty

B



Page Link - see page

For teacher's cabinets **397**



Page Link - see page

More teachers' desks... **310-312**

Best Seller

Phone For Bulk Prices

Express Delivery

5 Year Warranty

Try before you buy!
Sample chairs available

Orders for less than 10 chairs may carry a carriage charge

Options for all Poly Chairs

Wire Link
Y16339 POAWriting Tablet
Y16340 POA
(460mm high only)Upholstered Seat Pad
Y16344 POAUpholstered Seat & Back
Y16346 POA

5 Year Warranty

Phone For Bulk Prices



Poly Chairs

A. The poly chair



- The traditional poly chair has been proven through years of use in schools and colleges
- Complies to new EN1729 height requirements
- Meets BS4875 level 5 for strength and stability
- Stacks 20 high

	Seat Height	Overall Width	1-29	30+
Y15420	260mm	365mm	£13.60	POA
Y15424	310mm	395mm	£14.10	POA
Y15428	350mm	445mm	£14.50	POA
Y15432	380mm	465mm	£14.90	POA
Y15436	430mm	475mm	£15.60	POA
Y15440	460mm	495mm	£16.10	POA

Orders of less than 10 chairs may carry a carriage charge

Colour Options
Other colours available - please enquire

Top colours

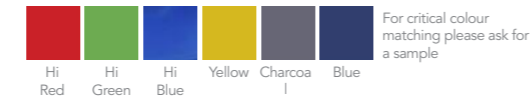

Frame colours



B. Poly skid base chairs



- The same structure as the poly chair shown above, these chairs stack as well as the four legged chair and are extremely popular in classrooms due to the extra stability
- Often specified by local Councils and in Design and Build projects
- Primary sizes available
- Many of the options above can also be used on this chair
- Chair width is 600mm, wider than a 4 leg chair, please ensure that you have room between table legs
- Colours as above

	Seat Height	Overall Width	5-29	30+
Y15444	430mm	600mm	£19.30	POA
Y15448	460mm	600mm	£19.30	POA

Orders of less than 10 chairs may carry a carriage charge

A. Planet chair



The Planet chair range is perfect for schools looking for a durable attractive product at an affordable price. The Planet chair features a high quality steel frame and a high grade polypropylene shell and has been tested to EN1729 part 2.

- Frames are finished in a high quality scratch resistant powdercoated black paint
- The products are covered by a six year warranty for peace of mind
- Can be stacked up to 8 units high for storage space efficiency
- 430mm height, 460mm available POA
- Chair manufactured from 99% recycled material
- Orders of less than 10 chairs may carry a carriage charge

	Seat Height	Overall Width	1-29	30+
Y15657	Black 430mm	518mm	£11.30	POA
Y15658	Blue 430mm	518mm	£11.30	POA

Colour Options

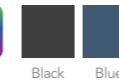
ONLY £11.30
Ask for a sample chair today

Express Delivery

A

B. Chiltern chair



The Chiltern range represents excellent value for money, a strong classroom chair at a very reasonable price.

- High quality powder coated steel frame
- Stacks 10 high
- 6 year warranty
- Meets EN1729 part 2
- Orders of less than 10 chairs may carry a carriage charge

	Seat Height	Overall Width	1-29	30+
Y100104	260mm	425mm	£12.10	POA
Y100105	310mm	425mm	£12.50	POA
Y100106	350mm	425mm	£12.90	POA
Y100107	380mm	518mm	£13.60	POA
Y100108	430mm	518mm	£14.25	POA
Y100109	460mm	518mm	£15.35	POA

Colour Options



Frame colours



6 Year Warranty

B



Classic Poly Chair



Express Delivery (Blue Only) 10 Year Warranty

A. Classic poly chair

The original school polypropylene chair design, still one of the most popular. Tested to EN1729 for strength and stability in addition to general dimensions and seat heights.

- Stacks 6 high

Options available (at extra cost):

- Flame retardancy
- Chair linking (430mm height only)
- Seat upholstery
- Back upholstery
- Writing tablets (chairs with writing tablets will only stack 2 high). Only available on 460mm, 430mm & 380mm high
- Orders of less than 10 chairs may carry a carriage charge

	Seat Height	Overall Width	1-29	30+
Y16700	270mm	350mm	£12.30	POA
Y16701	320mm	350mm	£13.10	POA
Y16702	350mm	360mm	£14.90	POA
Y16703	380mm	400mm	£15.90	POA
Y16704	430mm	470mm	£16.30	POA
Y16705	460mm	470mm	£16.70	POA



A



Optional Linking Mechanism

Optional Upholstery



Optional Writing Tablet



B

Frame Colours

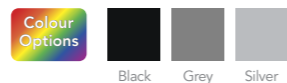

Shell Colours

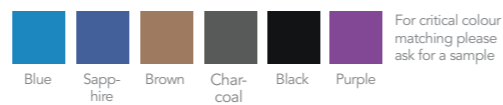

B. Chair trolley

- Fits most chairs
- Nylon covered wheels



Y16389A	Chair Trolley	£59.50
---------	---------------	--------

The Poly Superior - Tamperproof



5 Year Warranty Phone For Bulk Prices Express Delivery

A. The poly superior

- The Poly Superior is one of the most popular brands in the UK
- Ergonomic design with lumbar support
- Extra strong construction with tamperproof fixings
- Heights comply with EN1729 part 1
- Black frame as standard, can also be supplied in light grey, charcoal or silver POA
- Orders of less than 10 chairs may carry a carriage charge

	Seat Height	Overall Width	1-29	30+
Y16350	260mm	410mm	£18.10	POA
Y16354	310mm	410mm	£18.20	POA
Y16358	350mm	410mm	£18.30	POA
Y16362	380mm	480mm	£18.40	POA
Y16366	430mm	480mm	£18.50	POA
Y16370	460mm	480mm	£18.60	POA

For critical colour matching please ask for a sample



Stacks 15 High



Strong sub frame with four anti-tamper rivet fixings.

B. Standfast poly chair

- Comfortable and durable traditional poly chair
- Space saving design-narrower than most poly chairs
- Ideal for school hall use where space must be maximised
- Stackable 8 high
- Options- seat and back pads, writing tablets, skid frames version, IT version, please contact us for details
- 10 year warranty, complies with EN1729
- Orders of less than 10 chairs may incur a carriage charge

Code	Seat height	Overall width	1-29	30+
Y100150	260	365	£12.90	POA
Y100152	310	365	£13.30	POA
Y100154	350	365	£13.90	POA
Y100156	380	400	£14.60	POA
Y100158	430	450	£16.20	POA
Y100160	460	450	£16.20	POA

Shell colours



10 Year Warranty

New Product



Please ask for details of other options - Skid Base, Tablet, Upholstered and linking options.



A. Forum chair



- Ergonomically designed for correct posture
- Fully Compliant to BS EN1729
- Smooth lines give a clean shape which is both comfortable and supportive
- Extra strong under carriage with no separate under-frame
- Outstanding 15 Year Guarantee
- Available in heights for all age ranges
- Can be stacked up to 10 high
- Silver grey frame colour as standard
- Orders of less than 6 chairs may incur a carriage charge

	Seat Height	Overall Width	1-29	30+
Y15617	260mm	370mm	POA	POA*
Y15618	310mm	370mm	POA	POA*
Y15619	350mm	426mm	POA	POA*
Y15620	380mm	426mm	POA	POA*
Y15621	430mm	474mm	POA	POA*
Y15622	460mm	474mm	POA	POA*
Y15624	Linking Device**		POA	POA*
Y15625	Upholstered Factory** Fitted Seat Pad		POA	POA*

* Please ring for best prices

** Only available on 430 & 460mm high chairs



Shell options For critical colour matching please ask for a sample

Colour Options: Blue, Charcoal, Green, Lilac, Orange, Purple, Red, Soft Blue, Tany Lime, Yellow

Fabric options

Carnation, Tangerine, Mustard, Lupin, Deep Blue, Mineral, Riviera, Moss, Soot, Slate



B. Atlas skid base chair



- An extremely strong yet compact chair
- Ideal for use in school halls or where space is limited
- Linking attachment available
- Orders of less than 10 chairs may incur a carriage charge

Code	Seat Height	Overall Width	
Y16500	260mm	370mm	POA
Y16501	310mm	370mm	POA
Y16502	350mm	410mm	POA
Y16503	380mm	460mm	POA
Y16504	430mm	460mm	POA
Y16505	460mm	460mm	POA
Y16506	Dolly for Atlas Skid Base Chair		POA
Y16507	Linking Attachment		POA

For critical colour matching please ask for a sample

Colour Options: Blue, Red, Green, Yellow, Violet, *Black, *Grey, Dk Grey

Frame Options

Black, Grey

* Colours depicted are only a guide. For an exact swatch sample or alternative colour please call us to discuss your requirements.
* Black seat shell only available in sizes 380, 430 & 460mm.

A. The contour poly chair



- Modern contoured style
- Meets EN1729 Parts 1 & 2
- Can be stacked 8 high with great stability
- Flame retardant option (POA)
- Orders of less than 10 chairs may carry a carriage charge

Code	Seat Height	Overall Width	1-29	30+
Y16720	350mm	440mm	£20.30	POA
Y16721	380mm	440mm	£20.70	POA
Y16722	430mm	500mm	£21.10	POA
Y16723	460mm	500mm	£21.50	POA



6 Year Warranty

Meet the family!



Frame colours

Colour Options: Black, Dark Grey, Light Grey, Smooth Silver, Textured Black, Textured Dk Grey

Shell colours:

Yellow (YW), Lime (LM), Ocean (ON), Flame (FL), Mulberry (MB), Red (RD), Sky (SK), Slate (ST), Onyx (OX)

Page Link - see page
For the IT Swivel version... 144



New Product



Active Seating

Active balance stool

- Promotes Ergo-Dynamic learning
- Engages and strengthens the core muscles
- Encourages continual adjustment to balance which keeps you focussed and alert
- Provides particular benefit to SEN pupils
- Active Balance stool with non-slip foot
- Colours:
320mm available in Black, Orange, Blue, Lime, Petrol Blue, Sand, Granite
400mm available in Black, Orange, Blue, Lime
480mm and 540mm black only

		1-4	5+
Y155021	320mm High	£43.40	POA
Y155022	400mm High	£48.60	POA
Y155023	480mm High	£55.95	POA
Y155024	540mm High	£56.95	POA

- Optional seat cover for balance stool
- Available in black, lime, sand or petrol

Y155025	Seat Cover	£12.95
---------	------------	--------

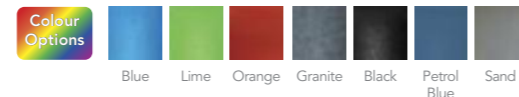

New Product



B. Chair to go!

- Innovative new seating tablet
- Promotes outdoor learning
- Can be used on the floor or on a seat
- Can be used left, right or front facing
- Suitable for multi-purpose rooms and halls
- Staff training or student use

		1-29	30+
Y155028	Tablet Red	£29.95	POA
Y155029	Tablet Grey	£29.95	POA
Y155030	Tablet Green	£29.95	POA
Y155031	Trolley to hold up to 40 Tablets	£375.00	



Flow classroom chair



- Modern design
- Ergonomic style
- Angled legs to discourage tilting
- Waterfall seat front
- Light grey frame
- Stacks 5 high
- Chair linking available POA
- Orders of less than 10 chairs may carry a carriage charge

	Seat Height	Overall Width	1-29	30+
Y16540	260mm	350mm	£27.90	POA
Y16541	310mm	350mm	£27.90	POA
Y16542	350mm	400mm	£29.20	POA
Y16543	380mm	400mm	£29.20	POA
Y16544	430mm	460mm	£29.95	POA
Y16545	460mm	460mm	£29.95	POA

Y100122	Cantilever	460mm	£49.90	POA
Y100123	Skid Base	460mm	£36.40	POA

"This chair clearly considers all ergonomic factors for a modern classroom chair. In addition, the chair's aesthetics are design led whilst maintaining exceptional value for money. FIRA have recommended that the chair is put forward for the schools certification scheme - for products going beyond the standard BS EN1729."

- Levent Caglar, Senior Ergonomist & Head of Ergonomics Unit, FIRA.

Meet the family



Cantilever



Skid Base



High (see page 41)



Swivel (see page 133)

5 Year Warranty on Swivel Chair



Flow tablet chair available, code Y100124 Please ring for details.

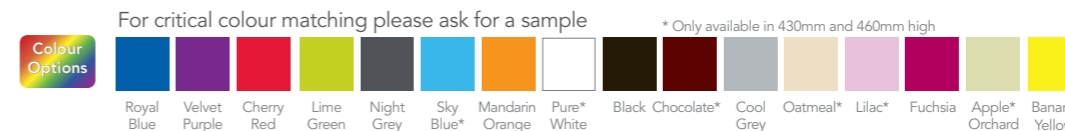

* Only available in 430mm and 460mm high



15 Year Warranty

Express Delivery

New Lower Price





**20 Year Warranty



Upholstered seat pad



Black is manufactured from recycled material



Linking mechanism for 430 & 460mm heights



Stacks up to 15 high

Colour Options

Sizes 310, 350 and 380 are not available in Black

260mm only available in Poppy Red, Ink Blue, Forest Green and Sun Yellow

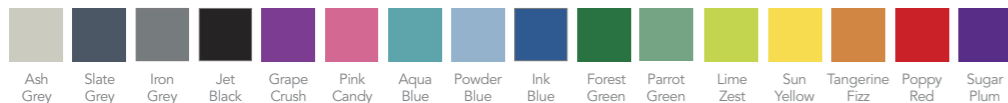

Posture Chairs

A. Mono posture chair

- Postura Mono chair is the UK's most popular classroom chair
- Ergonomically designed to promote good posture and provide exceptional comfort
- Angled back legs discourage leaning back
- Certified to FIRA to meet BS EN1729 Parts 1 & 2 for dimensions, strength and stability
- Orders of less than 10 chairs may carry a carriage charge

	Seat Height	Overall Width	1-29	30+
Y16514	260mm	280mm	£15.95	POA
Y16515	310mm	280mm	£16.40	POA
Y16516	350mm	340mm	£17.20	POA
Y16517	380mm	380mm	£17.60	POA
Y16518	430mm	380mm	£19.50	POA
Y16519	460mm	400mm	£21.10	POA
Y16520	Seat Pad			POA
Y16521	Linking Device (430 & 460mm Heights)			£9.25

Posture Chairs

A. Mono posture IT chair

- Perfect ergonomics with unique waterfall seat edge and lower back lumbar design
- Flame retardant to CRIB 5, compliant to BS5852 2006
- Available in 15 colours
- Size: H395-485 x W415 x D450 x overall H760-850mm
- Available with castors or glides (please specify)
- Small order charge applies

Y32011	Mono Posture IT Chair	£59.70
--------	-----------------------	--------

Colour Options



Glides Castors



5 Year Warranty

B. Roma chair

Roma is a contemporary and comfortable stacking chair. Stacking up to 38 chairs on a dolly, Roma really comes into its own when seating is required on a large scale. They are a popular choice for halls, meeting areas and classrooms.

- Orders of less than 10 chairs may carry a carriage charge

		1-29	30+
Y16716	Roma Chair	£69.00	POA
Y16728	Transport Dolly	£217.00	POA

Express Delivery

*Express delivery on indicated colours 10-15 days



Colour Options

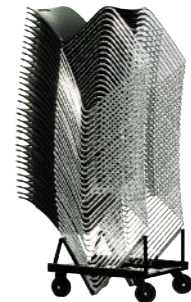

Stacks up to 38 high



Upholstered seat pad



Removable left or right handed tablet arm



21 Year Warranty

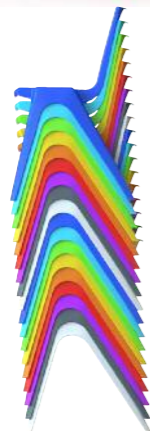

Stacks 21 High



Ideal dining and hall chair - 30 fit on a trolley

Posture Chairs

A. Chevron chair



- One Piece Polypropylene Chair
- Streamline Design for exceptional ergonomics, comfort and a modern look
- Stronger and Lightweight - glass filled polypropylene ensures greater strength and durability, yet lighter weight
- Space Saving Stack-ability - the chair stacks easily for efficient storage, up to 21 chairs within a 2 metre height
- Slim line curved legs for pleasing aesthetics
- Sustainable Materials - uses less materials than any other chair in its class. Made from fully recyclable materials
- Stacks 21 high
- 10 Colours available
- Orders of less than 10 chairs may carry a carriage charge

	Seat Height	Overall Width	1-29	30+
Y100142	260mm	400mm	£14.25	POA
Y100143	310mm	400mm	£14.70	POA
Y100144	350mm	460mm	£15.50	POA
Y100145	380mm	460mm	£15.95	POA
Y16717	430mm	500mm	£18.80	POA
Y16718	460mm	500mm	£19.95	POA
Y100116	Linking Device		£4.50	POA

Colour Options

For critical colour matching please ask for a sample



B. Trolley to take 30 chevron chairs

- Supplied flat packed for easy assembly
- Complete with ratchet strap

Y100118	each	£110.00
---------	------	---------

Posture Chairs

A. Positive Posture chairs

- The Titan chair is the first one-piece polypropylene chair that has attained EN1729 certification
- The benefit of one-piece polypropylene chairs is well documented in terms of their longevity (20 year guarantee), comfort and safety in the classroom
- With no screws or rivets, no sharp edges and no metal work to rust, the Posture chair offers all the benefits of a one-piece chair with the added EN1729 certification
- The Titan chair complies fully with EN1729 height regulations, but is also one of the few chairs that meets its posture and sitting position requirements
- The Titan chair is stackable 15 high and offers excellent value for money
- Orders of less than 10 chairs may carry a carriage charge

	Seat Height	Width	5-29	30+
Y15400	310mm	360mm	POA	POA
Y15402	350mm	430mm	POA	POA
Y15404	380mm	430mm	POA	POA
Y15406	430mm	480mm	POA	POA
Y15408	460mm	480mm	POA	POA
Y15409	Linking Attachment		each	£2.65

Orders for less than 10 chairs may carry a carriage charge

B. Positive posture steel leg chair

Combining the comfort of the plastic seat with strong steel legs and protective feet, stacks up to 8 high.

Code	Seat Height	Overall Width	1-29	30+
Y15630	350	440	POA	POA
Y15629	380	440	POA	POA
Y15628	430	500	POA	POA
Y15627	460	500	POA	POA

Colour Options

Please specify:
1. size
2. colour

For critical colour matching please ask for a sample

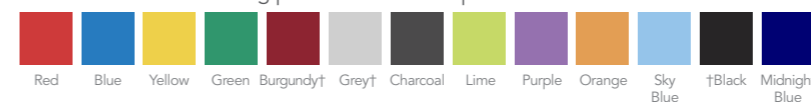

†Sizes 310, 350 and 380 are not available in Burgundy, Grey, Black or Midnight Blue

Best Seller
20 Year Maker's Guarantee



- Hand hold
- Integral lumbar support
- Flat seat and waterfall front removes pressure points
- Leg rake to prevent tilting



Linking clip



Stackable 15 high



Midnight Blue
New for 2019

10 Year
Warranty

A. Pennine posture chair

- Innovative design for perfect postural support
- Pelvic support back relieves pressure
- 10 year warranty
- Orders of less than 10 chairs may carry a carriage charge

	Seat Height	Overall Width	1-29	30+
Y100110	260mm	360mm	£18.60	POA
Y100111	310mm	360mm	£18.90	POA
Y100112	350mm	410mm	£20.40	POA
Y100113	380mm	410mm	£20.75	POA
Y100114	430mm	470mm	£22.50	POA
Y100115	460mm	470mm	£22.80	POA



Frame colours

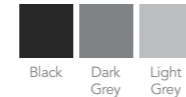

Shell colours

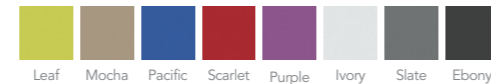

B. Perennial chair

- Strong, fully upholstered chair
- Ideal for 6th Form and college use
- Stackable (with fitted tablet)
- 5 year warranty
- Optional tablet can be fitted left or right
- 530mm x 570mm x 470mm seat height
- Choose from Phoenix fabrics (page 270). Other fabrics available - please ask
- Orders of less than 10 chairs may carry a carriage charge

		1-29	30+
Y100149	Without Tablet	£60.00	POA
Y100161	Tablet Fitted to Left Arm	£103.00	POA
Y100151	Tablet Fitted to Right Arm	£103.00	POA

Ideal for 6th Form &
College use5 Year
WarrantyNew
ProductBest
SellerPhone
For Bulk
Prices

A. Folding event chairs - linking

- Integral linking feature, complies with fire regulations for performances, a much stronger solution than plastic linking clips
- These light weight folding chairs are extremely durable with a metal frame and the curved, supportive back provides additional comfort
- These chairs quickly fold and can be stored on the standard storage trolleys
- Weighs only 3.5kg
- Designed for occasional use, weight limit 100kg
- 1 year warranty
- Packed in 8's

		8-96	97+
Y15483	Blue Linking Chair	£12.95	POA
Y15484	Burgundy Linking Chair	£12.95	POA
Y15485	Grey Linking Chair	£12.95	POA

Integral
Linking

A

B. Standard exam chairs

- Lightweight, folding exam chairs
- Tough, compact, versatile, suitable for indoor and outdoor event use
- The chairs fold flat in seconds and can be stored on trolleys with up to 60 chairs
- Fire retardant chairs (POA) and linking clips available
- Weight limit 100kg, designed for occasional use
- 1 year warranty
- Packed in 8's

		8-48	49+
Y16523	Blue Exam Chair	£12.20	POA
Y16524	Burgundy Exam Chair	£12.20	POA
Y16525	Grey Exam Chair	£12.20	POA

Please specify the colour you require.

Express
DeliveryBest
Seller

B

Chair Trolleys



C. 40 chair flat trolley

- Suitable for most types of folding chairs
- 40 chair storage trolley with heavy duty castors
- L1780 x W780 x H1340mm
- Will fit through a standard doorway
- 5m ratchet strap included
- Requires simple self assembly

Y1548640	£129.50
----------	---------



C

D. 60 chair trolley

- 60 chair trolley with heavy duty castors and black frame
- L1750mm x W790mm x H1100mm (fully loaded)
- Will fit through normal doorway
- Requires simple self assembly

Y16527	£215.00
--------	---------



D

Larger trolleys also available -
please enquire



Express Delivery

Ring for details

A. Graduate cantilever stool

- Waterfall seat front
- Scuff resistant & anti-tilt feet buffers
- Complies to EN1729
- 50 x 30mm oval frame
- Stacking 6 high
- Anthracite fully welded grey frame
- Natural wood colour
- Height 610mm

	1-29	30+
Y19105	£38.75	POA



Page Link - see page

Craft tables

22



10 Year Warranty

B



Optional Saddle Foot



B. Olympic stool

- New innovative design
- Aerated, angled seat
- Heavy Duty frame with stable design
- Long lasting Duragrip feet
- Choose from 7 bright, modern seat colours and 3 frame colours
- Complies with EN1729
- 10 year warranty
- Please contact us for advice if these stools are to be used on abrasive safety flooring



	Seat Height	1-29	30+
Y19100	430mm	£25.95	POA
Y19101	525mm	£25.95	POA
Y19102	610mm	£25.95	POA
Y19103	685mm	£25.95	POA
Y19104	760mm	£25.95	POA
Y155026	Saddle Foot Set of 4	£6.50	POA

Colour Options

Frame Colours: Black, Grey, Silver

Shell Colours: Red, Orange, Green, Blue, Pink, Charcoal, Black, Purple

For critical colour matching please ask for a sample

A. Solid beech stools

- These traditional stools are still extremely popular, especially in laboratories and art rooms
- Manufactured from solid beech, these stools will provide a solution that will last for many years
- Choose from 4 heights
- Orders of under 8 stools may incur a carriage charge

	Seat Height	5-29	30+
Y15000	510mm	£69.90	POA
Y15002	560mm	£69.90	POA
Y15004	610mm	£69.90	POA
Y15006	685mm	£69.90	POA

FULLY EN1729 COMPLIANT

Express Delivery

5 Year Warranty

On All These Products



A

B. Student lipped stool



- This stool is without a doubt the UK's best selling and most popular stool
- These stools are specified for major projects countrywide because of their unique seat shape and integral lumbar support
- The stools have a robust frame, unique lumbar support and a well positioned footrest
- The stools come in 10 shell colours with an option for steel feet and have a 5 year guarantee
- Please contact us for advice if these stools are to be used on abrasive safety flooring as steel feet may be necessary

	Seat Height	5-29	30+
Y15007A	395mm	£26.90	POA
Y15008	445mm	£26.90	POA
Y15010	560mm	£26.90	POA
Y15012*	610mm	£26.90	POA
Y15014*	685mm	£26.90	POA
Y15016	Steel Feet - Set of 4	£3.95	POA



B

C. Skid base stool

- Extremely strong and stable
- Same popular seat design
- Not suitable for abrasive floors

	Seat Height	5-29	30+
Y16729	395mm	£29.90	POA
Y16730	445mm	£29.90	POA
Y16731	560mm	£29.90	POA
Y15015A*	610mm	£29.90	POA
Y15017A*	685mm	£29.90	POA

Choose 1. shell colour 2. frame colour

Colour Options

Seat Colours for Stools

Blue*, Charcoal, Green, Lilac, Orange, Purple, Red, Soft Blue, Tangy Lime, Yellow

For critical colour matching please ask for a sample

Frame colours

Silver Grey*, Black, Metallic Charcoal

Phone For Bulk Prices

Express Delivery on Items Marked*

Best Seller



C

A



Phone For Bulk Prices

Colour Options

Frame Colours

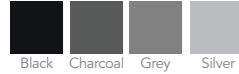

Shell Colours For critical colour matching please ask for a sample



B



Optional Steel Foot



Colour Options

Frame colours

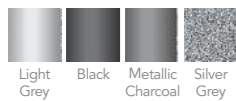

Rectangular Stools



- This highly popular stool has a 19mm sturdy tubular frame with a poly seat. Available in 4 heights
- Black, grey, charcoal or silver frame. Black will be supplied unless otherwise indicated
- Steel feet necessary for use on abrasive safety flooring
- Fire retardant
- Please contact us for advice if these stools are to be used on abrasive safety flooring

A. Rectangular stool

- Fire retardant
- Orders of less than 6 stools may incur a carriage charge

	Seat Height	5-29	30+
Y16712	430mm	£21.95	POA*
Y16713	525mm	£21.95	POA*
Y16714	610mm	£21.95	POA*
Y16715	685mm	£21.95	POA*
Y15016	Steel Feet - Set of 4	£3.95	POA*

*Please ring for best price

Page Link - see page
Craft tables 22



B. MDF stacking stool

- Based on the same design as the poly stacking stool, this stool has an MDF seat supplied with a handhold
- Black, grey, charcoal or silver frame. Black will be supplied unless otherwise indicated
- Steel feet necessary for use on abrasive safety flooring
- Orders of less than 6 stools may incur a carriage charge
- Please contact us for advice if these stools are to be used on abrasive safety flooring

	Seat Height	5-29	30+
Y15039	470mm	£24.90	POA
Y15041	520mm	£24.90	POA
Y15042	570mm	£24.90	POA
Y15046	620mm	£24.90	POA
Y15050	670mm	£24.90	POA
Y15016	Steel Feet - Set of 4	£3.95	POA

Stools

A. Round top stool



- Economical stool for use in classrooms, IT rooms of science rooms
- Orders of less than 6 stools may incur a carriage charge
- Please contact us for advice if these stools are to be used on abrasive safety flooring

	Stool Height	5-29	30+
Y100145A	430mm	£15.30	POA
Y100146	525mm	£15.30	POA
Y100147	610mm	£15.30	POA
Y100148	683mm	£15.30	POA
Y155027	Tilting Steel foot Set of 4	£3.95	-



A

B. Mono stools & high chairs

- Available in 3 heights
- Integrated bag hook
- Ergonomically designed to promote good posture and provide exceptional comfort
- Certified to FIRA to meet BS EN1729 Parts 1 & 2 for dimensions, strength and stability
- Orders of less than 10 chairs may carry a carriage charge

		Seat Height	1-29	30+
Y100127	Stool	560	£36.80	POA
Y100128	Stool	610	£37.40	POA
Y100129	Stool	685	£38.60	POA

Y100130	High Chair	560	£44.80	POA
Y100131	High Chair	610	£46.30	POA
Y100132	High Chair	685	£49.20	POA

All dimension shown in mm

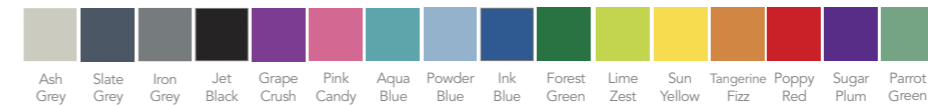

C. Flow high chair

- Heavy duty construction
- 125kg weight limit
- Orders of less than 6 stools may incur a carriage charge

		Seat Height	1-29	30+
Y100125	4 Leg	610mm	£47.20	POA
Y100126	4 Leg	660mm	£47.20	POA
Y100133	Skid Frame	610mm	£59.50	POA
Y100134	Skid Frame	685mm	£59.50	POA



B

C





Best Seller

Express Delivery

Exam Package

25 Exam Desks
1 Trolley (Y15474)

only

£555.00

CODE: Y15476

Table & chair
hire available
- please ask for details

Exam Desks & Trolleys

A. Exam package

- Great value package with 25 exam desks and a trolley

Y15476 Package £555.00

B. Folding exam desks

- These popular exam tables have been designed to ensure they last longer and are better quality than others on the market
- The clips for the folding frame are metal and the tables have an 16mm beech laminate top with a pencil groove
- These tables provide a strong and affordable solution for all types of examination and with fold flat frames and easy to handle storage trolleys, exam preparation has never been easier
- 700mm high. Please order in multiples of 2.
- Other colours available to order
- Also available with blue or grey polypropylene tops for a lighter option. Please ask for details
- Premium desk has a thicker desk top and a safety bar for easier and safer assembly

		10-49	50+
Y15472	Standard Exam Desk 600 x 600mm	£19.00	POA
Y16554	Premium Exam Desk 600 x 600mm	£21.00	POA



Standard

Premium
with safety bar
and thicker topHolds 25 exam desks
upright for safe and
easy storageHolds 40 exam
desks lying flat

C. Exam desk trolleys

- Hold either 25 exam desks upright for safe and easy storage or 40 exam desks lying flat

Y15474	Exam Desk Trolley Holds 25 Desks Upright	£152.95
Y15475	Exam Desk Trolley Holds 40 Desks Flat	£167.95

Exam Desks



A. Tamperproof folding exam desk

- Formica top resists graffiti
- Seamless, PU, impact-resistant edging
- Size: 600 x 600 x H700mm
- Pen groove included
- Speckled grey as standard, other colours available

		1-29	30+
Y100117	Tamperproof Folding Desk	£36.70	POA

Phone
For Bulk
Prices

A

B. Stacking exam tables

- These popular exam tables have a strong, black 'zimmer' frame and are FIRA tested to the highest level available, proving they are suitable for severe educational use
- Beech laminate top with MDF edge
- With pen groove
- 700mm high



		10-29	30+
Y16719	Stacking Exam Desk 600 x 500mm	£34.80	POA

Express
Delivery

B



Education resources come in all shapes and sizes
Are you storing yours in the most efficient way that makes the best use of space?

Classroom Storage

Gratnells Trays	50	Curved Bookcases	78
Best Selling Storage Units	52-53	Colourstore	80-83
Tray Storage	54,58,60-64	Art Storage	84-85
Bookcases & Cupboards	55-57, 59	Bag Storage	79,87
Contract Storage	65	Storage Trolleys	86
Allsorts	66-67	CalStor Storage	88-89
Cubby Storage	68	STEM Trolley	91
Premium Storage	70-71	Metal Storage	90,92-94
White Storage	69, 72-73	Fitted Storage	95-99
Candy Colours	74-77		

Classroom Storage

When it comes to updating classroom storage units, there are so many diverse requirements that it takes something beyond the average range to meet your needs. That's where we can help!

The following pages showcase our unique collection of storage products, from plastic tray storage units through to bespoke fitted systems. In most cases we trust you can find the ideal solution for your needs, but if not, or to discuss your requirements, please call our sales team. We have a wealth of experience and advice, available at absolutely no cost to you.



Gratnell's tray range for supply with storage units

- Gratnell's Trays are included in the price of our tray storage units in the following pages
- Trays are available in shallow, deep, extra deep and jumbo sizes.
- Some colours are not available in all sizes, see below for availability.
- You can specify the tray colours you want for any tray storage unit shown in this section, even mix and match depths from the range



Tray colours available when purchasing shelving units:

Solid Colours



Clear Jelly Colours



Gratnell's trays and lids for separate purchase

- Trays can also be purchased separately from units
- Flame Red, Yellow, Royal Blue, Green, Purple and Clear - available in all depths
- Orange, Pink, Cyan Blue and Lime - available in shallow and deep only
- Over 15 additional special colours available to order - ask for details



Stock Colours

YSTRAY	Shallow Tray	W312 x D427 x H75mm	each	POA
YDTRAY	Deep Tray	W312 x D427 x H150mm	each	POA
YEDTRAY	Extra Deep Tray	W312 x D427 x H225mm	each	POA
YJTRAY	Jumbo Tray	W312 x D427 x H300mm	each	POA
YTLID	Clear Tray Lid		each	POA

Stock Colours

All depths

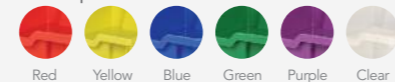

Shallow & Deep Only

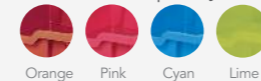

Special Colours - Please call for prices

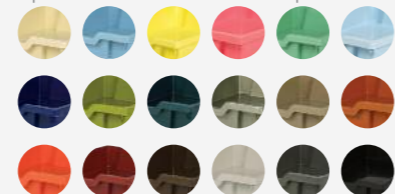

Phone For Bulk Prices

Tray Storage Units Overview

Checklist for Choosing and Specifying Your Unit

1. How many trays do you need?
2. And of what depth? Note that within the price you can specify any mix of depths which will physically fit the unit. 1 x Deep tray = 2 x Shallow, 1 x Extra Deep = 3 x Shallow and 1 x Jumbo = 4 x Shallow.
3. Is there a preferred, uniform, top surface height? Look for the height icon h1, h2 etc which gives the height in mm.
4. How many bays wide for best fit into your workspaces? Units are available in 1, 2, 3 or even 4 columns of trays wide.
5. Carcass design - trays sliding on runners or sitting directly onto a shelf?
6. Castors or Fixed Plinth? Smaller units are fitted with castors as standard but some items can be specified with a static plinth at no extra cost. Note: heights quoted include height of castors.
7. Doors – locking doors can be fitted to most units as an optional extra.
8. Wood finish / Metal Frame Colours – Our standard MFC wood finishes are Beech (BE) or Maple (MP) but please ask for details of production order quantities and lead times for manufacturing in Ash, White, or other special finishes. Standard Metal Frame colour options are Silver, Powder Blue & Yellow. See page 90 for colour icons.
9. Select your mix of tray colours (and depths) from the extensive range available – see chart on page 50.
10. For fitted installations see Classtore system on pages 98-99.

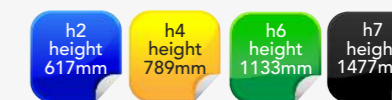
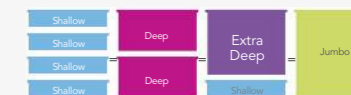

65mm Castors

Plinth

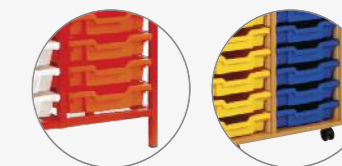

Best Selling Storage Units



- All units supplied complete with Gratnell's trays within the price. See page 50 for colours and size options
- Choice of Beech or Maple finish. Ask our sales office for details on other finishes available
- Colour and size options: you can fill your unit with any combination of tray depth and colour which will fit into the space



h2
height
617mm



A. 6 tray unit

- W360 x D453 x H617mm

Y15116	Beech, Open Front	£78.50
Y15118	Beech with Locking Door	£118.00
Y203000	Maple, Open Front	£78.50
Y203002	Maple with Locking Door	£118.00

h2
height
617mm



B. 12 tray unit

- W700 x D453 x H617mm

Y15120	Beech, Open Front	£128.60
Y15122	Beech with Locking Door	£175.40
Y203004	Maple, Open Front	£128.60
Y203006	Maple with Locking Door	£175.40

h2
height
617mm



C. 18 tray unit

- W1030 x D453 x H617mm

Y15124	Beech, Open Front	£157.40
Y15126	Beech with Locking Door	£204.20
Y203008	Maple, Open Front	£157.40
Y203010	Maple with Locking Door	£204.20

h4
height
789mm



D. 24 tray unit

- W1030 x D453 x H789mm

Y15128	Beech, Open Front	£198.50
Y15130	Beech with Locking Door	£246.80
Y203012	Maple, Open Front	£198.50
Y203014	Maple with Locking Door	£246.80

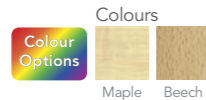

Page Link - see pages
For
bookcases
& cupboards
55-57



Best Selling Storage Units



- All units supplied complete with Gratnell's trays within the price. See page 50 for colours and size options
- Choice of Beech or Maple finish. Ask our sales office for details on other finishes available
- Colour and size options: you can fill your unit with any combination of tray depth and colour which will fit



h5
height
961mm



A. 30 tray unit

- W1030 x D453 x H961mm

Y17005	Beech, Open Front	£278.00
Y17007	Beech with Locking Door	£328.50
Y203016	Maple, Open Front	£278.00
Y203018	Maple with Locking Door	£328.50

h3
height
703mm



B. 21 tray units

- W1030 x D453 x H703mm

Y15125	Beech, Open Front	£199.60
Y15127	Beech with Locking Door	£248.20
Y203020	Maple, Open Front	£199.60
Y203022	Maple with Locking Door	£248.20

h2
height
617mm



C. 18 tray unit

- W1030 x D453 x H617mm

Y15124	Beech, Open Front	£157.40
Y15126	Beech with Locking Door	£204.20
Y203008	Maple, Open Front	£157.40
Y203010	Maple with Locking Door	£204.20

h4
height
789mm



D. 24 tray unit

- W1030 x D453 x H789mm

Y15128	Beech, Open Front	£198.50
Y15130	Beech with Locking Door	£246.80
Y203012	Maple, Open Front	£198.50
Y203014	Maple with Locking Door	£246.80

h4
height
789mm



C. 8 & 16 tray units

- D453 x H789mm

Y15119	Beech 8 Tray Unit W360mm	£99.80
Y15123	Beech 16 Tray Unit W700mm	£162.00
Y203024	Maple 8 Tray Unit W360mm	£99.80
Y203026	Maple 16 Tray Unit W700mm	£162.00

h4
height
789mm



D. 6 & 8 tray shelving units

- W1030 x D453mm
- 2 adjustable shelves

Y15129	Beech 6 Tray H617mm	£174.80
Y15131	Beech 8 Tray H789mm	£185.60
Y203028	Maple 6 Tray s H617mm	£174.80
Y203030	Maple 8 Tray H789mm	£185.60

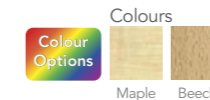

Four Column Tray Units



- All units supplied complete with Gratnell's trays within the price. See page 50 for colours and size options
- Choice of Beech or Maple finish. Ask our sales office for details on other finishes available
- Colour and size options: you can fill your unit with any combination of tray depth and colour which will fit into the space



h7 height 1477mm



A. 64 shallow tray unit

- W1358 x D462 x H1477mm

Y15716	Beech Open Front	£499.60
Y203032	Maple Open Front	£499.60

h6 height 1133mm



B. 48 shallow tray unit

- W1358 x D462 x H1133mm

Y15133	Beech Open Front	£399.80
Y203034	Maple Open Front	£399.80

h5 height 961mm



C. 40 shallow tray unit

- W1358 x D462 x H961mm

Y15713	Beech Open Front	£368.70
Y203036	Maple Open Front	£368.70

h4 height 789mm



D. 32 shallow tray unit

- W1358 x D462 x H789mm

Y15705	Beech Open Front	£309.50
Y15707	Beech, with Locking Doors	£368.00
Y203038	Maple Open Front	£309.50
Y203040	Maple, with Locking Doors	£368.00

h3 height 703mm



E. 28 shallow tray unit

- W1358 x D462 x H703mm

Y15710	Beech Open Front	£289.40
Y15711	Beech, with Locking Doors	£338.60
Y203042	Maple Open Front	£289.40
Y203044	Maple, with Locking Doors	£338.60

h2 height 617mm



F. 24 shallow tray unit

- W1358 x D462 x H617mm

Y15733	Beech Open Front	£262.70
Y15737	Beech, with Locking Doors	£314.50
Y203046	Maple Open Front	£262.70
Y203048	Maple, with Locking Doors	£314.50

h1 height 531mm



G. 20 shallow tray unit

- W1358 x D462 x H531mm

Y15719	Beech Open Front	£242.50
Y203050	Maple Open Front	£242.50

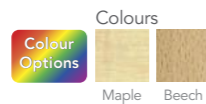

Tray Storage Cupboards



- All cupboards supplied with trays included in the price. Specify any combination of sizes and colours which will fit into the tray compartment
- Choice of Beech or Maple finish. Ask our sales office for details on other finishes available



Can also be supplied with different tray sizes



A. 21 tray cupboard unit

- Tray storage for 21 trays and 3 additional shelves
- W1030 x D477 x H1810mm

Y15172	Beech with Locking Doors	£399.50
Y203052	Maple with Locking Doors	£399.50



B. 24 tray cupboard unit

- Storage for 24 trays and 2 additional shelves
- Full or half doors available
- W1030 x D477 x H1468mm

Y15728	Beech, Locking Top Doors	£372.40
Y15738C	Beech, Locking Full Doors	£409.20
Y203054	Maple, Locking Top Doors	£372.40
Y203056	Maple, Locking Full Doors	£409.20



C. 48 tray cupboard unit

- W1030 x D477 x H1468mm

Y17081	Beech Open Front	£419.80
Y17083	Beech, with Locking Doors	£488.70
Y203058	Maple Open Front	£419.80
Y203060	Maple, with Locking Doors	£488.70

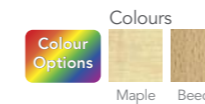

D. 60 tray cupboard unit

- W1030 x D477 x H1810mm

Y15178	Beech Open Front	£458.00
Y15176	Beech, with Locking Doors	£528.60
Y203062	Maple Open Front	£458.00
Y203064	Maple, with Locking Doors	£528.60

Open Bookcases



- This popular range of open bookcases has been specifically designed for severe classroom environments
- All now available in Beech, Maple or White finish
- Strong, 25mm bend-resistant shelves



A. Bookcase 750

- 2 adjustable shelves
- W900 x D320 x H750mm

Y15183	Beech	£147.60
Y200050	Maple	£147.60
Y200051	White	£169.50



B. Bookcase 1000

- 2 adjustable shelves
- W900 x D320 x H1000mm

Y15182	Beech	£152.20
Y200052	Maple	£152.20
Y200053	White	£176.80

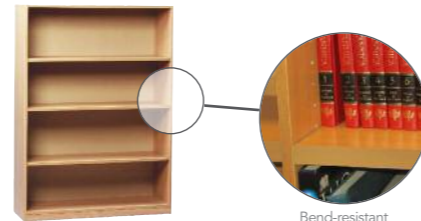

Bend-resistant 25mm shelves

C. Bookcase 1250

- 1 fixed and 2 adjustable shelves
- W900 x D320 x H1250mm

Y15193	Beech	£165.10
Y200054	Maple	£165.10
Y200055	White	£189.50



D. Bookcase 1500

- 1 fixed and 2 adjustable shelves
- W900 x D320 x H1500mm

Y15731	Beech	£179.00
Y200056	Maple	£179.00
Y200057	White	£203.40



E. Bookcase 1800

- 1 fixed and 4 adjustable shelves
- W900 x D320 x H1800mm

Y15186	Beech	£193.60
Y200058	Maple	£193.60
Y200059	White	£220.00

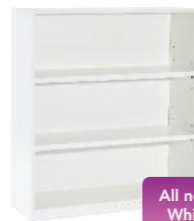

All now available in White MFC finish

Lockable Storage Cupboards



- This popular range of storage cupboards has been specifically designed for severe classroom environments
- All now available in Beech, Maple or White finish
- Strong, 25mm bend-resistant shelves



A. Cupboard 750

- 2 adjustable shelves
- W1030 x D477 x H768mm

Y15181	Beech	£217.50
Y200070	Maple	£217.50
Y200071	White	£257.80



B. Cupboard 1000

- 1 fixed and 2 adjustable shelves
- W1030 x D477 x H1018mm

Y15180	Beech	£236.70
Y200072	Maple	£236.70
Y200073	White	£276.50



C. Cupboard 1250

- 1 fixed and 2 adjustable shelves
- W1030 x D477 x H1268mm

Y15191	Beech	£259.80
Y200074	Maple	£259.80
Y200075	White	£299.40



D. Cupboard 1500

- 1 fixed and 2 adjustable shelves
- W1030 x D477 x H1518mm

Y15730C	Beech	£284.00
Y200076	Maple	£284.00
Y200077	White	£328.40



Bend-resistant 25mm shelves

E. Cupboard 1800

- 1 fixed and 4 adjustable shelves
- W1030 x D477 x H1818mm

Y15184	Beech	£299.80
Y200078	Maple	£299.80
Y200079	White	£344.00



All now available in White MFC finish



Page Link - see pages
For library units... 182-191

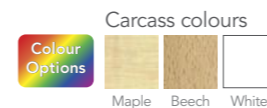

Coloured Edge Storage



- All units supplied complete with Grattnell's trays within the price. See page 50 for colours and size options
- Please specify Beech (BE) or Japanese Ash (JA) carcass



For Ash finish, please add 'JA' to the end of the code



h4 height 789mm

A. 12 jumbo tray unit

- W1358 x D453 x H1067mm

Y15200	With Red Edge	£358.50
Y15202	With Blue Edge	£358.50
Y15204	With Green Edge	£358.50

B. 8 jumbo tray unit

- W1358 x D453 x H739mm

Y15231	With Red Edge	£299.60
Y15233	With Blue Edge	£299.60
Y15235	With Green Edge	£299.60

C. 24 shallow tray unit

- W1030 x D453 x H789mm

Y15194	With Red Edge	£237.80
Y15196	With Blue Edge	£237.80
Y15198	With Green Edge	£237.80

h2 height 617mm



h2 height 617mm



h2 height 617mm



D. 18 shallow tray unit

- W1030 x D453 x H617mm

Y15188	With Red Edge	£206.50
Y15190	With Blue Edge	£206.50
Y15192	With Green Edge	£206.50

E. 12 shallow tray unit

- W700 x D453 x H617mm

Y17100	With Red Edge	£185.40
Y17102	With Blue Edge	£185.40
Y17104	With Green Edge	£185.40

F. 6 shallow tray unit

- W360 x D453 x H617mm

Y17106	With Red Edge	£108.50
Y17108	With Blue Edge	£108.50
Y17110	With Green Edge	£108.50



Also Available in Ash Finish

Page Link - see pages 116-117
For early years units...



Coloured Edge Bookcases & Cupboards



- Popular range of open shelf or cupboard storage with the enhancement of colour edging trims
- Strong 25mm bend-resistant shelves
- Please specify Beech (BE) or Japanese Ash (JA) finish



Bend-resistant 25mm shelves



A. High bookcase unit

- 1 fixed and 4 adjustable shelves
- Open Bookcases W900 x D320 x H1800mm

Y15223	Bookcase - Red Edge	£179.50
Y15227	Bookcase - Blue Edge	£179.50
Y15229	Bookcase - Green Edge	£179.50

B. Medium bookcase unit

- 1 fixed and 2 adjustable shelves
- Open Bookcases W900 x D320 x H1250mm

Y15212	Bookcase - Red Edge	£159.40
Y15214	Bookcase - Blue Edge	£159.40
Y15216	Bookcase - Green Edge	£159.40

C. Low bookcase unit

- 2 adjustable shelves
- Open Bookcases W900 x D320 x H750mm

Y15211	Bookcase - Red Edge	£139.20
Y15213	Bookcase - Blue Edge	£139.20
Y15215	Bookcase - Green Edge	£139.20



D. Low cupboard unit

- 2 adjustable shelves
- Cupboards with doors W1030 x D477 x H768mm

Y15201	Cupboard - Red Edge	£219.60
Y15203	Cupboard - Blue Edge	£219.60
Y15205	Cupboard - Green Edge	£219.60

E. Medium cupboard unit

- 1 fixed and 2 adjustable shelves
- Cupboards w/doors W1030 x D477 x H1268mm

Y15206	Cupboard - Red Edge	£279.60
Y15208	Cupboard - Blue Edge	£279.60
Y15210	Cupboard - Green Edge	£279.60

F. High cupboard unit

- 1 fixed and 4 adjustable shelves
- Cupboards w/doors W1030 x D477 x H1818mm

Y15217	Cupboard - Red Edge	£299.80
Y15219	Cupboard - Blue Edge	£299.80
Y15221	Cupboard - Green Edge	£299.80



Also Available in Ash Finish

Locking Doors

Jumbo Storage Units



- These units are extremely popular, offering organised storage capacity for large, messy and heavy items
- All units supplied complete with Grannell's trays within the price. See page 50 for colours and size options
- Choice of Beech or Maple finish. Ask our sales office for details on other finishes available



Deep & Extra Deep Storage Units



- These units are extremely popular, offering organised storage capacity for large, messy and heavy items
- All units supplied complete with Grannell's trays within the price. See page 50 for colours and size options
- Choice of Beech or Maple finish. Ask our sales office for details on other finishes available



Extra Value



Extra Value



A. 12 jumbo tray unit

- W1358 x D453 x H1067mm

Y15148	Beech, Open Front	£292.00
Y15150	Beech with Locking Doors	£348.60
Y203065	Maple, Open Front	£292.00
Y203066	Maple with Locking Doors	£348.60

B. 8 jumbo tray unit

- W1358 x D453 x H739mm

Y151798	Beech, Open Front	£248.00
Y1517208	Beech with Locking Doors	£299.20
Y203068	Maple, Open Front	£248.00
Y203070	Maple with Locking Doors	£299.20

C. 9 jumbo tray unit

- W1030 x D453 x H1067mm

Y15137	Beech, Open Front	£258.50
Y15143	Beech with Locking Doors	£312.60
Y203072	Maple, Open Front	£258.50
Y203074	Maple with Locking Doors	£312.60



D. 6 jumbo tall tray unit

- W700 x D453 x H1067mm

Y17045	Beech, Open Front	£224.80
Y17047	Beech with Locking Doors	£276.20
Y203076	Maple, Open Front	£224.80
Y203078	Maple with Locking Doors	£276.20

E. 6 jumbo wide tray unit

- W1030 x D453 x H739mm

Y17049	Beech, Open Front	£299.60
Y17051	Beech with Locking Doors	£348.80
Y203080	Maple, Open Front	£299.60
Y203082	Maple with Locking Doors	£348.80

F. 4 jumbo tray unit

- W700 x D453 x H739mm

Y17053	Beech, Open Front	£216.50
Y17055	Beech with Locking Doors	£265.10
Y203084	Maple, Open Front	£216.50
Y203086	Maple with Locking Doors	£265.10



A. 12 deep tray unit vertical

- W1030 x D453 x H835mm

Y200210	Beech Open Front	£278.80
Y203088	Maple Open Front	£278.80

B. 12 deep tray horizontal

- W1358 x D453 x H707mm

Y200212	Beech Open Front	£279.30
Y203090	Maple Open Front	£279.30

C. 16 deep tray unit

- W1348x D453x H835mm

Y200214	Beech Open Front	£348.50
Y203092	Maple Open Front	£348.50

D. 18 deep tray unit

- W1030 x D453 x H1210mm

Y200216	Beech Open Front	£369.40
Y203094	Maple Open Front	£369.40



E. 6 extra deep tray unit

- W700 x D453 x H857mm

Y17061	Beech, Open Front	£185.70
Y17063	Beech with Locking Doors	£242.00
Y203096	Maple, Open Front	£185.70
Y203098	Maple with Locking Doors	£242.00

F. 12 extra deep tray unit

- W1358 x D453 x H857mm

Y1571912	Beech, Open Front	£320.00
Y1572012	Beech with Locking Doors	£375.40
Y203100	Maple, Open Front	£320.00
Y203102	Maple with Locking Doors	£375.40

G. 16 extra deep tray unit

- W1358 x D453 x H1115mm

Y1572516	Beech, Open Front	£399.80
Y1572616	Beech with Locking Doors	£449.60
Y203104	Maple, Open Front	£399.80
Y203106	Maple with Locking Doors	£449.60

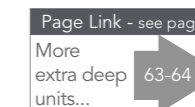
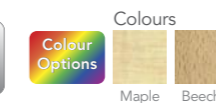
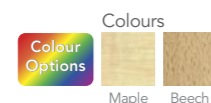

Combination Storage Units



- Choice of Beech or Maple finish
- All units can also be made as static unit, fitted with plinth at no extra cost - specify if required
- All units supplied complete with Grattnells trays within the price - see page 50 for colour options
- Units can be combined with the open shelf unit on the following page to make tall units



A. 10 tray open front variety unit

- Unit holds 4 extra deep trays on the left and 12 shallow or 6 deep trays on the right
- W1358 x D453 x H617mm

Y15729	Beech Mobile - Open Front	£298.70
Y1573610	Beech, Static - Open Front	£298.70
Y203108	Maple Mobile - Open Front	£298.70
Y203110	Maple, Static - Open Front	£298.70



C. 32 shallow or 16 deep tray unit

- Allows a mixture of shallow and deep trays
- W1358 x D453 x H835mm

Y15132	Beech, Open Front	£346.50
Y15134	Beech with Locking Doors	£396.70
Y203116	Maple, Open Front	£346.50
Y203118	Maple with Locking Doors	£396.70

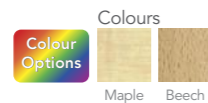

B. 24 shallow or 12 deep tray unit

- Allows a mixture of shallow and deep trays
- W1358 x D453 x H707mm

Y17057	Beech, Open Front	£286.60
Y17059	Beech with Locking Doors	£340.00
Y203112	Maple, Open Front	£286.60
Y203114	Maple with Locking Doors	£340.00



D. 36 shallow or 18 deep tray unit

- A popular, large capacity unit with 36 shallow or 18 deep trays, or a combination of both
- W1030 x D453 x H1210mm

Y15140	Beech, Open Front	£378.20
Y15142	Beech with Locking Doors	£428.50
Y203120	Maple, Open Front	£378.20
Y203122	Maple with Locking Doors	£428.50

Combination & Sliding Door Tray Units



- Choice of Beech or Maple finish
- All units can also be made as static unit, fitted with plinth at no extra cost - specify if required
- All units supplied complete with Grattnells trays within the price - See page 50 for colour option
- Tray units can be combined with the open shelf unit below to make tall units
- Sliding doors are lockable



A. 16 shallow, 4 deep and 3 extra deep tray unit

- Dimensions: w1358 x h842mm
- Units without doors have depth 453mm
- Units with sliding doors have depth 510mm

Y15145	Beech, 23 Tray, Open Front	£348.60
Y15741	Beech, 23 Tray, Sliding Doors	£399.50
Y203124	Maple, 23 Tray, Open Front	£348.60
Y203126	Maple, 23 Tray, Sliding Doors	£399.50



C. 16 shallow and 6 extra deep tray unit

- Dimensions: w1358 x h842mm
- Units without doors have depth 453mm
- Units with sliding doors have depth 510mm

Y17067	Beech, 22 Tray, Open Front	£344.20
Y15745	Beech, 22 Tray, Sliding Doors	£395.80
Y203132	Maple, 22 Tray, Open Front	£344.20
Y203134	Maple, 22 Tray, Sliding Doors	£395.80

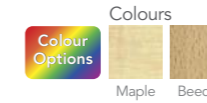

Pick & mix your trays

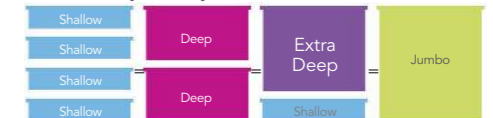

B. 8 deep and 6 extra deep tray unit

- Dimensions: w1358 x h842mm
- Units without doors have depth 453mm
- Units with sliding doors have depth 510mm

Y17065	Beech, 14 Tray, Open Front	£348.00
Y15743	Beech, 14 Tray, Sliding Doors	£399.00
Y203128	Maple, 14 Tray, Open Front	£348.00
Y203130	Maple, 14 Tray, Sliding Doors	£399.00



D. Open shelf unit with 4 compartments

- Sits on top of base units
- Can be securely fixed with locking pins

Y203136	Beech Finish	£228.60
Y203138	Maple Finish	£228.60

Variety Storage Units

- Choice of Beech or Maple finish
- All units can also be made as static unit, fitted with plinth at no extra cost - specify if required
- All units supplied complete with Grattells trays within the price - see page 50 for colour options

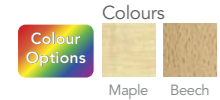

A. 12 tray variety

- Takes 4 jumbo trays, 4 deep trays and 4 shallow trays, mix and match colours as you wish
- W1358 x D453 x H707mm

Y15156	Beech, Mobile, Open Front	£296.50
Y15158	Beech, Mobile, Locking Doors	£346.80
Y15162	Beech, Static, Locking Doors	£346.80
Y203140	Maple, Mobile, Open Front	£296.50
Y203142	Maple, Mobile, Locking Doors	£346.80
Y203144	Maple, Static, Locking Doors	£346.80



B. 12 tray vertical variety

- Contains 3 of each tray size: shallow, deep, extra deep & jumbo
- W1030 x D453 x H967mm

Y202000	Beech, Mobile, Open Front	£298.60
Y203146	Maple, Mobile, Open Front	£298.60



C. 16 tray variety

- A bigger version of the unit above, this variety tray storage unit holds 4 shallow trays, 4 deep trays, 4 extra deep trays, and 4 jumbo trays
- W1358 x D453 x H967mm

Y15164	Beech, Mobile, Open Front	£371.80
Y15166	Beech, Mobile, Locking Doors	£422.60
Y15170	Beech, Static, Locking Doors	£422.60
Y203148	Maple, Mobile, Open Front	£371.80
Y203150	Maple, Mobile, Locking Doors	£422.60
Y203152	Maple, Static, Locking Doors	£422.60



D. 7 tray narrow variety unit

- Takes 4 deep & 3 extra deep trays
- W700 x D453 x H842mm

Y155010	Beech, Mobile, Open Front	£225.40
Y203154	Maple, Mobile, Open Front	£225.40



E. 8 tray narrow variety unit

- Takes 2 x shallow, 2 x deep, 2 x extra deep, 2 x jumbo
- W700 x D453 x H967mm

Y151108	Beech, Mobile, Open Front	£246.90
Y203156	Maple, Mobile, Open Front	£246.90



F. 11 tray narrow variety unit

- Takes 8 shallow & 3 extra deep trays
- W700 x D453 x H842mm

Y155000	Beech, Mobile, Open Front	£224.80
Y203158	Maple, Mobile, Open Front	£224.80

Contract Storage Range



- All units supplied in Beech finish MFC.
- All units delivered fully assembled c/w Strata trays
- Specify any mix of colours: Blue, Red or Clear
- Strata tray dimensions: shallow W270 x D360 x H130mm deep W270 x D360 x H190mm

Phone For Bulk Prices

Extra Value



h4 height 789mm

A. 9 deep tray unit

- W922 x D453 x H789mm

Y15159	£195.40
--------	---------



h4 height 789mm

B. 6 deep tray unit

- W622 x D453 x H789mm

Y15160	£154.20
--------	---------



h4 height 789mm

C. 4 shallow and 3 deep tray unit

- W622 x D453 x H789mm

Y15153	£159.80
--------	---------



h4 height 789mm

D. 12 deep tray unit

- W1222 x D453 x H789mm

Y15157	£236.60
--------	---------



h4 height 789mm

E. 8 shallow and 6 deep tray unit

- W1222 x D453 x H789mm

Y15155	£258.00
--------	---------



F. 8 deep tray unit

- W622 x D453 x H1026mm

Y15151	£168.30
--------	---------



G. 16 deep tray unit

- W1222 x D453 x H1026mm

Y15152	£298.60
--------	---------



Colour Options

Carcass Colour
Beech

Tray Colours - please specify when ordering
Red Blue Clear

Allsorts Storage Range



- The Allsorts Storage Units are a versatile stackable storage solution that can be customised to suit every classroom
- Each unit comes complete with castors and locating pins which are used when stacking
- All Allsorts units can be stacked with each other to make a whole combination of different storage requirements
- All units come fully assembled in either Beech or Maple carcass - please specify. Ask our sales office for details on other finishes available
- All units supplied complete with Grannell's trays within the price. See page 50 for colour and size options
- Height includes 65mm castors

Stackable



A. Allsorts 24 shallow tray unit
• W1030 x D453 x H810mm

Y15128AS	Beech	£248.40
Y203160	Maple	£248.40



B. Allsorts 12 deep tray unit
• W1030 x D453 x H810mm

Y1524512	Beech	£248.40
Y203162	Maple	£248.40



C. Allsorts 6 jumbo tray unit
• W1030 x D453 x H810mm

Y152476	Beech	£248.40
Y203164	Maple	£248.40



D. Allsorts 16 shallow tray unit
• W700 x D453 x H810mm

Y15249	Beech	£221.80
Y203166	Maple	£221.80



E. Allsorts 8 deep tray unit
• W700 x D453 x H810mm

Y15245	Beech	£221.80
Y203168	Maple	£221.80



F. Allsorts 4 jumbo tray unit
• W700 x D453 x H810mm

Y15247	Beech	£221.80
Y203170	Maple	£221.80

Allsorts Storage Range



A. Allsorts unit with 1 shelf
• W700 x D453 x H810mm

Y15241	Beech	£184.50
Y203172	Maple	£184.50



B. Allsorts unit with 4 compartments
• W700 x D453 x H810mm

Y15243	Beech	£184.50
Y203174	Maple	£184.50



C. Allsorts big book holder
• Supplied complete with 4 shallow trays
• W700 x D453 x H810mm

Y15248B	Beech	£221.80
Y203176	Maple	£221.80



D. Allsorts beech storage cupboard
• Static, stackable storage unit c/w 1 shelf
• Locking doors
• W700 x D475 x H745mm

Y200010	Beech	£242.50
Y203178	Maple	£242.50

These items are Stackable



Page Link - see page 51
For buying guide...



Colours

Colour Options: Maple, Beech

Unwrapped & Checked, Ready Assembled, Rapid Delivery, Eco Priority Construction, Trays Included

Cubby Range



- Smaller sizes than our regular tray storage range, so ideal for younger years, or where space is limited
- Units supplied fully assembled
- Beech-BE finish only
- Units supplied with Cubby trays included in the price



The Gratnell's Cubby Trays are **smaller** than the standard Gratnell's Trays: **W260 x D312 x H150mm**



A. 6 tray unit

- W588 x D343 x H647mm

YEY8006 £118.00

B. 12 tray unit

- W1158 x D343 x H647mm

YEY8012 £236.90

C. 18 tray unit

- W873 x D343 x H1211mm

YEY8018 £269.50



D. 24 tray unit

- W1158 x D343 x H1211mm

YEY8024 £339.20

E. 12 deep and 4 extra deep tray unit

- W1158 x D343 x H1194mm
- Includes 4 extra deep Gratnell's trays & 12 Cubby trays

YEY8013 £325.40

F. 30 tray unit

- W1443 x D343 x H1211mm

YEY8030 £412.00

Trays available in:

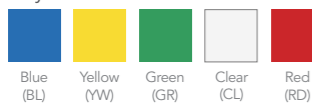

Stackable White Storage Units

- New range of stacking modular storage units
- By using just 4 component modules many different storage combinations can be built
- Supplied fully assembled

Units stacked over 2 metres tall will require wall fixing



A. 4 squares unit

- W700 x D453 x H745mm

Y200020 £233.00



B. 4 jumbo tray unit

- W700 x D453 x H745mm

Y200022 £267.60



C. Unit with 1 shelf

- Open unit: W700x D453 x H745mm
- Cupboard unit: W700 x D475 x H745mm

Y200024 Open Unit £233.00
Y200026 Lockable Cupboard £271.80

White Display Shelving



- Value range of open display units in white MFC finish
- Supplied fully assembled

Page Link - see page
More white furniture [72-73](#)



D. Small display unit

Y300500 W1300 x D450 x H660mm £253.60



E. Medium display unit

Y300502 W1030 x D450 x H1004mm £281.50



F. Tall display unit

Y300504 W1030 x D450 x H1330mm £360.00

Premium Storage Range



- New range of premium storage units in a choice of White or Grey finish
- Add a choice of brightly coloured trays for a clean, modern look
- All tray units contain clear Gratnells plastic tray runners
- Units are supplied with plinths as standard, but most are also available fitted with castors at no additional charge - please ask for details
- All units supplied complete with Gratnells trays as shown, within the price
- See page 50 for colour & size options.



A.6 tray unit
• W363 x D475 x H617mm



B. 8 tray unit
• W363 x D475 x H789mm



C. 12 tray unit
• W704 x D475 x H617mm

Y203182	White, No Doors	£115.40
Y203184	White, with Locking Doors	£138.50
Y203186	Grey, No Doors	£115.40
Y203188	Grey, with Locking Doors	£138.50

Y203190	White, No Doors	£123.10
Y203192	White, with Locking Doors	£146.20
Y203194	Grey, No Doors	£123.10
Y203196	Grey, with Locking Doors	£146.20

Y203198	White, No Doors	£169.40
Y203200	White, with Locking Doors	£198.60
Y203202	Grey, No Doors	£169.40
Y203204	Grey, with Locking Doors	£198.60



D. 16 tray unit
• W704 x D475 x H789mm



E. 18 tray unit
• W1045 x D475 x H617mm



F. 24 tray unit
• W1045 x D475 x H789mm

Y203206	White, No Doors	£185.00
Y203208	White, with Locking Doors	£215.40
Y203210	Grey, No Doors	£185.00
Y203212	Grey, with Locking Doors	£215.40

Y203214	White, No Doors	£230.80
Y203216	White, with Locking Doors	£269.40
Y203218	Grey, No Doors	£230.80
Y203220	Grey, with Locking Doors	£269.40

Y203222	White, No Doors	£269.60
Y203224	White, with Locking Doors	£315.50
Y203226	Grey, No Doors	£269.60
Y203228	Grey, with Locking Doors	£315.50

Premium Storage Range



- New range of premium storage units in a choice of White or Grey finish
- Add a choice of brightly coloured trays for a clean, modern look
- All tray units contain clear Gratnells plastic tray runners
- Units are supplied with plinths as standard, but most are also available fitted with castors at no additional charge - please ask for details
- All units supplied complete with Gratnells trays as shown, within the price
- See page 50 for colour & size options



A. 6 tray shelving unit
• 2 shelf compartment & 6 shallow trays
• W1045 x D475 x H617mm



B. 8 tray shelving unit
• 2 shelf compartment & 8 shallow trays
• W1045 x D475 x H789mm



C. 21 tray cupboard
• W1045 x D475 x H1818mm
• Supplied c/w 21 trays

Y203230	White, No Doors	£215.60
Y203232	White, with Locking Doors	£254.00
Y203234	Grey, No Doors	£215.60
Y203236	Grey, with Locking Doors	£254.00

Y203238	White, No Doors	£246.20
Y203240	White, with Locking Doors	£292.40
Y203242	Grey, No Doors	£246.20
Y203244	Grey, with Locking Doors	£292.40

Y203246	White, with Locking Doors	£499.60
Y203248	Grey, with Locking Doors	£499.60



D. Low cupboard
• W1045 x D465 x H617mm



E. Medium cupboard
• W1045 x D475 x H789mm



F. Tall cupboard
• W1045 x D475 x H1818mm

Y203250	White, No Doors	£198.50
Y203252	White, with Locking Doors	£235.40
Y203254	Grey, No Doors	£198.50
Y203256	Grey, with Locking Doors	£235.40

Y203258	White, No Doors	£226.50
Y203260	White, with Locking Doors	£257.80
Y203262	Grey, No Doors	£226.50
Y203264	Grey, with Locking Doors	£257.80

Y203266	White, No Doors	£265.00
Y203268	White, with Locking Doors	£322.60
Y203270	Grey, No Doors	£265.00
Y203272	Grey, with Locking Doors	£322.60

White Range

- 12 popular tray units available in white finish
- Supplied complete with trays
- Remember to state your choice of tray colours
- See page 50 for tray colours



Phone
For Bulk
Prices



A. 4 jumbo tray unit
• W700 x D453 x H810mm

Y17053W £236.50



B. 8 jumbo tray unit
• W1358 x D453 x H739mm

Y157198W £299.50



C. 12 jumbo tray unit
• W1358 x D453 x H1067mm

Y15148W £381.50



D. 6 jumbo wide tray unit
• W1030 x D453 x H739mm

Y203180 £375.40

New
Product



White Range



Page Link - see page
For
buying
guide... **51**



A. 12 variety tray unit
• W1358 x D453 x H707mm

Y15156W £378.60



B. 16 variety tray unit
• W1358 x D453 x H967mm

Y15164W Mobile £398.50



C. 12 extra deep tray unit
• W1358 x D453 x H857mm

Y1571912W £388.00



D. 16 extra deep tray unit
• W1358 x D453 x H1115mm

Y1572516W £429.50



E. 12 deep tray unit
• W1358 x D453 x H707mm

Y17057W £339.40



F. 16 deep tray unit
• W1358 x D453 x H835mm

Y15132W £398.20



G. 18 deep tray unit
• W1030 x D453 x H1210mm

Y17080W £410.00



H. 12 deep tray unit
• W1030 x D453 x H835mm

Y17084W £339.80



I. 8 deep & 6 extra deep tray unit
• W1358 x D453 x H843mm

Y17065W 14 Tray Unit £388.60

The Candy Colours Range



- All units supplied complete with Gragnell's trays within the price. See page 50 for colours and size options
- Stylish Japanese Ash carcass with coloured top rails
- Please specify top rail theme colour - Lime Green, Cyan Blue, Tangerine or White



A. 12 shallow tray unit
• W700 x D473 x H667mm

Y17015	12 Shallow Tray Unit	£215.80
--------	----------------------	---------



B. 24 shallow tray unit
• W1030 x D473 x H839mm

Y17017	24 Shallow Tray Unit	£358.40
--------	----------------------	---------



C. 8 jumbo tray unit
• W1358 x D473 x H790mm

Y17019	8 Jumbo Tray Unit	£326.00
--------	-------------------	---------



D. 12 variety tray unit
• W1358 x D473 x H752mm

Y17021	12 Variety Tray Unit	£342.00
--------	----------------------	---------



E. Candy book house
• Made from 18mm Japanese Ash MFC with ply effect edging
• Choose from Lime, Tangerine and Cyan
• Dimensions: W910 x D568 x H1101mm

YBH9000	Book House with Trays	£231.70
YBH9005	Big Book Holder	£257.20



F. Mobile art storage cupboard
• Made in Japanese Ash MFC with bright coloured interior door panels
• W1085 x D600 x H1503mm
• Supplied with 16 x shallow Gragnell's trays (or equivalent in larger trays)
• Other contents not included

Y17038	Art Storage Cupboard	£698.00
--------	----------------------	---------

Please specify top rail colour

Colour Options

- Lime
- Tangerine
- Cyan Blue
- White

Carcass

- Japanese Ash

The Candy Colours Range



A. 6 bay kinderbox with 12 shallow or 6 deep trays
• W1022 x D473 x H600mm

Y17023	6 Bay Kinderbox	£279.50
--------	-----------------	---------



B. 6 shallow tray unit
• W360 x D473 x H667mm

Y17027	6 Shallow Tray Unit	£139.40
--------	---------------------	---------



C. 18 shallow tray unit
• W1030 x D473 x H667mm

Y17029	18 Shallow Tray Unit	£287.70
--------	----------------------	---------

Extra Value



D. 12 jumbo tray unit
• W1358 x D473 x H1115mm

Y17031	12 Jumbo Tray Unit	£439.00
--------	--------------------	---------



E. 6 bay kinderbox (coloured inner panels)

Y17033	With Wheels W886 x D600 x H273mm	£172.60
Y17035	With Legs W886 x D600 x H430mm	£171.80



F. Angled tray unit c/w 6 deep trays
• W1030 x D481 x H877mm

Y200190	Angled Shelf Unit	£239.50
---------	-------------------	---------

Page Link - see pages
Early years & Candy Colours cloakroom range → 130



Page Link - see pages
Book shelves & library furniture → 74, 190-191



Candy Colours Room Dividers

- Backless storage units which can be used free standing or stacked on top of co-ordinating cupboards for additional storage space
- Stylish Japanese Ash carcass with coloured panels
- Please specify panel colour – Lime Green, Cyan Blue, Tangerine, White or Japanese Ash
- Each compartment will hold 1 jumbo Gratnell's tray if required (priced separately, see page 50) – inner dimensions W316 x D450 x H310mm
- Supplied with a set of plastic feet & connecting pins
- Maximum recommended stacking height 2 metres

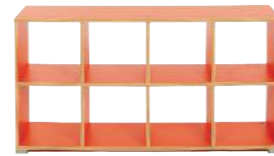

A. 4 cube (2 x 2)

- W700 x D453 x H774mm

B. 6 cube (2 x 3)

- W1030 x D453 x H774mm

C. 8 cube (2 x 4)

- W1358 x D453 x H774mm

Y17200	£179.10	Y17202	£218.30	Y17204	£218.30
--------	---------	--------	---------	--------	---------



D. 6 cube (3 x 2)

- W700 x D453 x H1002mm

E. 9 cube (3 x 3)

- W1030 x D453 x H1002mm

F. 12 cube (3 x 4)

- W1358 x D453 x H1002mm

Y17206	£257.50	Y17208	£267.80	Y17210	£322.00
--------	---------	--------	---------	--------	---------



Combine room dividers with complementary storage cupboards (see next page)

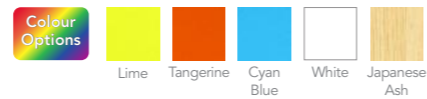

Storage Cupboards

- Low level cupboards with stylish Japanese Ash MFC carcass
- Vertical divider creates 2 compartments with 1 adjustable shelf each side
- Solid back, doors with silver handles
- Supplied with a set of plastic feet & connecting pins
- Use with room dividers to give extra height & storage space
- Maximum recommended stacking height 2 metres
- Can be used as base units for the room dividers on page 76



Y17212	W700 x D453 x H500mm	£248.00
	use with A & D	



Y17214	W1030 x D453 x H500mm	£298.50
	use with B & E	



Y17216	W1358 x D453 x H500mm	£332.60
	use with C & F	



Candy colours stacking storage

- Range of stackable storage boxes that connect to make different storage combinations
- Will hold 2 x jumbo Gratnell's trays per compartment (priced separately – see page 50)
- Choose from 4 bright colours: Lime Green, Cyan Blue, Tangerine or White, with ply effect edgings
- Maximum recommended stacking height 2 metres
- Dimensions W700 x D453 x H380mm

Y17218	£152.00
--------	---------

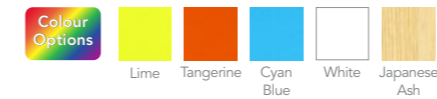

Candy colours swivel storage

- Storage unit which will spin 360 degrees
- Choose from 4 bright colours: Lime Green, Cyan Blue, Tangerine or White with ply effect edgings
- Dimensions : W400 x D400 x H1175mm

Y17220	£236.00
--------	---------

*Please specify colour



Page Link - see pages
For waterfall units... 190



Please ask for pricing on special colours

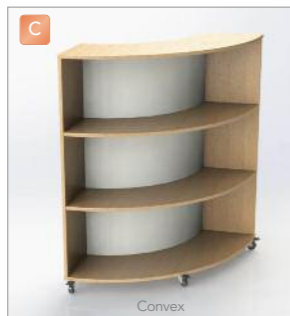
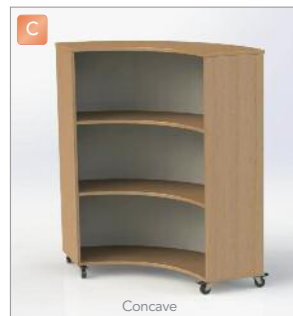

Wood & colour finishes may not be representative of actual colours - please ask for a sample

Colour Options

Beech	Oak	Maple	Grey	Red	Yellow	Green	Blue	White
-------	-----	-------	------	-----	--------	-------	------	-------

Grasmere Curve Book Storage System

- Premium range made from high quality 18mm MFC in a choice of board finishes with cream back boards
- Choice of either single sided bookcases in 2 heights, or double sided mobile units in 3 different heights
- Other board finishes available - please ask for pricing and details

A. Grasmere straight bookcase

- Single sided
- Depth 320mm

Y200600	H900 x W1000mm	each	£266.80
Y200604	H900 x W600mm	each	£238.50

B. Grasmere straight bookcase

- Double sided
- Depth 600mm

Y200610	H900 x W1000mm	each	£372.60
Y200612	H1200 x W1000mm	each	£481.40
Y200614	H1500 x W1000mm	each	£569.00
Y200616	H900 x W600mm	each	£310.00
Y200618	H1200 x W600mm	each	£426.20
Y200620	H1500 x W600mm	each	£478.00

C. Grasmere curved bookcase

- Single sided
- Choice of concave (curves inwards) or convex (curves outwards)
- Maximum depth 835mm, width 1180mm

Y200630	Convex H900	each	£400.00
Y200632	Concave H900	each	£400.00
Y200634	Convex H1200	each	£474.50
Y200636	Concave H1200mm	each	£474.50

D. Grasmere curved bookcase

- Double sided
- Maximum depth 1115mm x width 1575mm

Y200640	Convex H900mm	each	£518.60
Y200642	Convex H1200mm	each	£675.20
Y200644	Convex H1500mm	each	£898.00
Y200646	Concave H900mm	each	£518.60
Y200648	Concave H1200mm	each	£675.20
Y200650	Concave H1500mm	each	£898.00



Colorstore Bag Storage

- New range of bag storage units in a wide range of board colours
- Supplied fully assembled, ready for use



A. Tall static bag storage unit

- 6 x 3 compartment
- Dimensions: W940 x D450 x H1530mm

Y200704	Open Front	£288.40
Y200710	With Locking Doors	£358.00

B. Low bag storage unit

- 3 x 4 compartment
- Dimensions: H810 x W1220 x D450mm

Y200708	Mobile - Open Front	£185.60
Y200711	Mobile - With Locking Doors	£294.50

Other sizes available, please ask for details.

Page Link - see pages
Matching cloakroom items 130



Carcass colours



Bag Storage

- New range of static classroom bag storage units in choice of Beech-BE, Maple-MP or White-WH finish
- Supplied fully assembled, ready for use



C. 8 & 16 compartment units

- 8 compartment: W1222 x D475 x H1018mm
- 16 compartment: W1222 x D475 x H1818mm

Y200700	8 Compartment	£235.40
Y200702	16 Compartment	£298.60

D. 8 & 16 compartment benches

- Choice of 9 frame colours as above
- 8 compartment D350 x H515 x W1200mm
- 16 compartment D350 x H515 x W1500mm

Y320350	8 Compartment	£142.80
Y320352	16 Compartment	£179.40

Carcass Colours

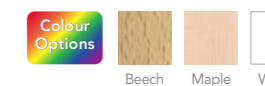

Frame Colours for item D

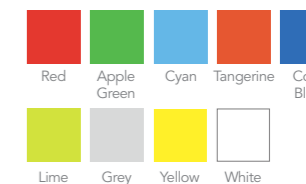

Colorstore™ Premium Tray Storage Furniture

- The ColorStore range brings a choice of 11 vibrant coloured storage units in addition to the Beech & Maple MFC finishes
- Made in the UK to a high standard with a 10 year guarantee
- Units are manufactured using 18mm MFC board throughout (includes a faced structural back) and have colour matched ABS edging
- All products have been tested by FIRA and have been spread load tested to take 100kgs
- Units are delivered fully assembled ready to use
- Fitted with lockable heavy duty swivel wheels with rubber tyres for added strength and ease of movement
- Supplied complete with Gratnells trays (see page 50 for colours) - just specify your choice of colours



Carcass colours



Specify mix of trays
See page 50 for colours

Spread load tested to 100kg

Lockable door options supplied with set of 2 keys

Quality safety hinges to prevent sagging

Heavy duty wheels with rubber tyres



A. 6 tray single column unit

• W370 x D480 x H670mm	
Y200200 6 Shallow Tray, Open Front	£139.40
Y200201 6 Shallow Tray, Locking Doors	£175.60
Y200204 3 Deep Tray, Open Front	£129.60
Y200205 3 Deep Tray, Locking Doors	£169.40

B. 12 tray double column unit

• W710 x D480 x H670mm	
Y200220 12 Shallow Tray, Open Front	£192.00
Y200221 12 Shallow Tray, Locking Doors	£260.80
Y200224 6 Deep Tray, Open Front	£172.40
Y200225 6 Deep Tray, Locking Doors	£248.30

C. 18 tray three column unit

• W1050 x D480 x H670mm	
Y200240 18 Shallow Tray, Open Front	£248.50
Y200241 18 Shallow Tray, Locking Doors	£299.20
Y200244 9 Deep Tray, Open Front	£209.20
Y200245 9 Deep Tray, Locking Doors	£278.90

Colorstore™ Premium Tray Storage Furniture

Specify mix of trays
See page 50 for colours



A. 24 tray four column unit

- 24 shallow tray
- W1390 x D480 x H670mm

Y200260 Open Front	£298.70
Y200261 Locking Doors	£387.00



B. 12 tray four column unit

- 12 deep tray
- W1390 x D480 x H670mm

Y200264 Open Front	£272.00
Y200265 Locking Doors	£359.60



C. 24 tray three column unit

- 24 shallow tray
- W1050 x D480 x H870mm

Y200280 Open Front	£298.40
Y200281 Locking Doors	£356.60



D. 12 tray three column unit

- 12 deep tray
- W1050 x D480 x H870mm

Y200284 Open Front	£258.80
Y200285 Locking Doors	£318.00

Quadrant tub storage range

- Supplied complete with Gratnells Quadrant (1/4 circle) translucent tubs
- Choice of corner, semi circle or revolving circular unit



E. Corner unit

- W440 x D440 x H588mm

Y200400 Open Front	£149.80
--------------------	---------



F. Semi-circle

- W860 x D440 x H588mm

Y200404 Open Front	£225.20
--------------------	---------



G. Mobile revolving unit

- 860mm diameter x H640mm

Y200408 Open Front	£418.50
--------------------	---------



Carcass colours

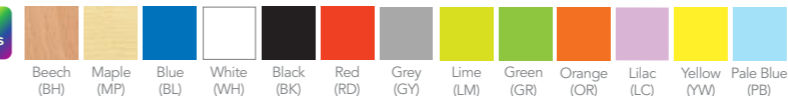

Colorstore™ Premium Storage Furniture



A. Low height tray & shelf cabinet with single locking door

- W1050 x D480 x H670mm

B. Twin column tray & shelf cabinet with double locking doors

- W710 x D490 x H1020mm
- 6 shallow & 2 deep trays, plus 3 shelves

C. Mobile combination cabinet with double locking top doors

- W1050 x D490 x H1250mm

Y200300	6 Shallow Tray/Shelf	£239.50
Y200304	3 Deep Tray/Shelf	£227.60

Y200320		£298.40
---------	--	---------

Y200340	18 Shallow Tray/Shelf	£389.40
Y200344	9 Deep Tray/Shelf	£354.40



D. Tall static cabinet with full height locking doors

- W1050 x D490 x H1800mm

E. Tub & shelf cupboard

- W1222 x D450 x H1050mm

Y200360	18 Shallow Tray/2 Shelf	£478.00
Y200364	9 Deep Tray/2 Shelf	£448.40

Y200368	8 Compartments	£295.60
Y200370	With 8 Tubs	£308.40
Y200372	With 8 Baskets	£380.00



Carcass colours



Colorstore™ Premium Cubby Hole Tub Storage Range

- High quality storage range with compartments filled with deep Strata Trays
- Specify any mix of tray colours – blue, red, yellow & clear
- Wicker baskets can be supplied at extra cost instead of trays – please ask for pricing
- All units are mobile except (F) which is supplied as static with plinth



A. 3 column low tub storage unit

- W940 x D450 x H580mm

B. 2 column mid height tub storage unit

- W620 x D450 x H810mm

C. 3 column mid height tub storage unit

- W940 x D450 x H810mm

Y200500	6 Tub Unit, Open Front	£155.80
Y200501	6 Tub Unit, Locking Doors	£199.50

Y200520	6 Tub Unit, Open Front	£149.20
Y200521	6 Tub Unit, Locking Doors	£198.40

Y200540	9 Tub Unit, Open Front	£187.00
Y200541	9 Tub Unit, Locking Doors	£245.30



D. 4 column mid height tub storage unit

- W1220 x D450 x H810mm

E. 2 column tall tub storage unit

- W620 x D450 x H1220mm

F. 3 column tall tub storage unit

- W940 x D450 x H1530mm

Y200560	12 Tub Unit, Open Front	£224.90
Y200561	12 Tub Unit, Locking Doors	£285.90

Y200580	10 Tub Unit, Open Front	£209.50
Y200581	10 Tub Unit, Locking Doors	£264.20

Y200590	18 Tub Unit, Open Front	£334.00
Y200591	18 Tub Unit, Locking Doors	£385.40



Carcass colours



Uses smaller Strata trays



Art Room Storage



- Gratnell's trays supplied FOC with all units, see page 50 for colour and size options
- Please specify Beech (BE) or Maple (MP) carcass. Ask our sales office for details on other finishes available

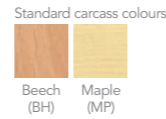

A. 6 bay kinderbox art unit

- With 12 shallow or 6 deep trays
- W1022 x D453 x H600mm

Y15258	Beech	£249.60
Y203280	Maple	£249.60

B. 4 bay kinderbox art unit

- With 8 shallow or 4 deep trays
- W690 x D453 x H600mm

Y15256	Beech	£178.50
Y203282	Maple	£178.50

C. Combination shelf unit

- With 8 shallow or 4 deep trays
- W700 x D453 x H789mm

Y16014	Beech	£174.60
Y203284	Maple	£174.60

D. Combination shelf unit

- With 12 shallow or 6 deep trays
- W1030 x D453 x H789mm

Y16012	Beech	£228.20
Y203286	Maple	£228.20

Kinderbox Open Book Storage Units

- Mobile book & tray storage units available in all carcass colours to match in with the rest of the range



E. Tub storage kinderbox

- Supplied without doors as standard
- Dimensions H750 x W710 x D490mm
- Tub colours: Red, Blue, Yellow or Clear

Y200380	Cubby Hole Unit	£159.80
Y200386	Cubby Hole W/Doors	£220.80
Y200382	With 4 Tubs	£176.40
Y200384	With 4 Baskets	£259.50

*Please specify carcass and tub colour

F. Tray storage kinderbox

- Dimensions H710 x W1050 x D480mm
- Choice of 12 shallow trays or 6 deep trays

Y200390	Shallow Tray Unit	£248.00
Y200392	Deep Tray Unit	£227.60

*Please specify carcass and tray colour

G. Slimline kinderbox

- Narrow 300mm width is ideal for corridor use
- Dimensions: H630 x W1200 x D300mm
- 4 compartments to display books on top and 4 open storage compartments below

Y200394	Mobile Kinderbox	£149.70
---------	------------------	---------

*Please specify carcass colour

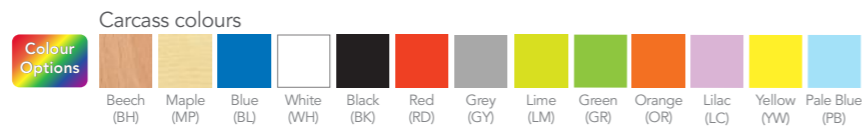

Art Room Storage



- Please specify Beech (BE) or Maple (MP) carcass. Ask our sales office for details on other finishes available



Also Available in Maple Finish



A. Static plan chest

- With beech or coloured drawers
- 6 drawers designed to hold A1 paper
- W1015 x D750 x H780mm

Y16016	Beech/Maple Drawers	£399.50
Y17069	Coloured Drawers	£416.00



B. Mobile paper storage

- 4 sliding drawers designed to hold A1 paper
- Open front: W1015 x D750 x H780mm
- With Doors: W1015 x D770 x H780mm

Y16018	Open Front	£299.20
Y16020	With Locking Doors	£386.00



Please note: these 2 items do not use regular Gratnell's trays.

C. A3 paper storage units

- 8 tray size: W495 x D493 x H789mm
- 16 tray size: W970 x D493 x H789mm
- Specify tray colours: any mix of blue, green, red & yellow

Y16010	8 Tray	£178.00
Y16008	16 Tray	£285.00



CalStor Art Storage

- Strong, metal framed art trolleys ideal for storing large sheets of paper & other art supplies
- Available with a choice of deep or shallow art trays, art tray / drying rack combination, or drying frame trolley
- Fitted with braked castors
- Dimensions of all units: H947x W500 x D500mm
- Choice of tray colours: Red, Blue, Green or Yellow

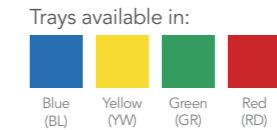
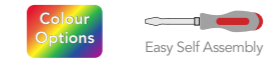

D. A3 deep tray trolley

- 6 trays included

Y203400	Cyan	£124.20
Y203402	Silver	£124.20



E. Shallow tray art trolley

- Includes 10 trays

Y203404	Cyan	£174.00
Y203406	Silver	£174.00



F. Combo trolley

- Includes 5 trays & 10 wire drying racks

Y203408	Cyan	£187.50
Y203410	Silver	£187.50



G. Drying trolley

- Includes 20 wire drying racks

Y203412	Cyan	£196.40
Y203414	Silver	£196.40

Storage Trolleys

- Mobile metal frame trolleys supplied complete with plastic trays
- Choice of frame colours - please specify

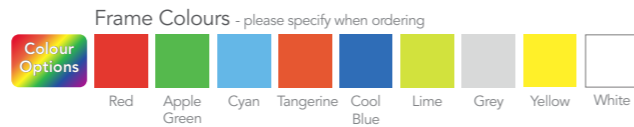

A. Sports trolley

- Perfect for storing PE equipment
- 6 Jumbo Trays
- W1050 x D430 x H1480mm

B. Art trolley/snack trolley

- Ideal for storing art & craft resources or breaktime snacks or fresh fruit.
- 8 deep trays and lids
- W708 x D430 x H943mm

C. Lunchbox trolley

- Large: W1025 x D500 x H900mm
- Small: W610 x D500 x H900mm

Y15147 £429.50

YEYEF1800 £274.80

YEF8113 Small £199.80
YEF8110 Large £258.20

Mobile Music Trolleys

- Sturdy attractive units with flexible storage
- Tops have various sized beater holes and a fixed shelf for instrument storage
- Frame colour as shown

Charging Trolley

- Robust locking doors open 270 degrees to fold out of the way
- H790mm to top of unit, total height 957mm
- Specify tray colour: White-WH or Silver-SV

Transporting Trolley

- Metal trolley with large rubber wheels ideal for transporting round the school
- Can hold a range of Gratnells tray combinations including the SmartCase & Power Tray

Page Link - see page
For power trays... 153



New Product

5 Year Warranty



F. Charging trolley

- Height is 790mm to top and 957mm including handle

YP2L102 Power Trolley with 2 x ED Trays £689.40
YP2L103 Power Trolley with 3 x Deep Trays £836.00

YEYEF6004B £236.00



New Product

5 Year Warranty



G. Transporting trolley

- Strap holds trays in place
- Trolley will hold 2 Jumbo trays, or equivalent
- Dimensions H1170 x W560 x D760mm
- Please state tray option & colour required

Y203398 £172.50

Storage Trolleys

Best Seller

- High quality, heavy duty mobile storage trolleys
- All have robust, laminate MDF panels supported by a strong EPC scratch resistant coated metal frame
- Lockable heavy duty castors for easy mobility
- Tested to BS5873 for strength & stability standards
- Supplied flat-packed for easy self-assembly



Page Link - see pages
More metal trolleys... 89



A. 30 lunchbox trolley

- Holds 30 Lunchboxes
- Single unit W1215 x D600 x H1035mm

YFN0603 £289.50



B. 60 lunchbox trolley

- Holds 60 lunchboxes
- Double unit W1215 x D740 x H1160mm

YFN0604 £328.20



C. Tech2 cloakroom trolley

- 15 double coat/bag hooks per side to hold 30 coats
- Perspex name card-holders for easy location and identification hooks
- Large storage base ideal for shoes & bags with centre divide & lip
- Shelf depth each side 260mm
- Label holder on end panel to identify class etc.
- W1610 x D740 x H1140mm

YFN0602 £315.00

Metal Storage Trolleys

- Robust steel frame trolleys designed to withstand the daily rigours of a busy school environment
- Meet BS5873 safety tests for strength, stability and safety
- Heavy duty castors, 2 lockable
- Blue & silver powder coated (EPC) scratch resistant finish for superior strength
- Supplied flat-packed for easy self assembly



D. Cloakroom trolley

- Large base storage shelf, ideal for shoes & bags with a centre divide
- 15 double coat/bag hooks per side store 30 coats
- Dimensions W1200 x D604 x H1115mm

Y200800 £255.90



E. Lunchbox trolley

- High capacity trolley with 3 large shelves
- Holds up to 60 lunchboxes
- Dimensions W1003 x D610 x H1115mm

Y200802 £295.40



F. Art storage trolley

- Multiple storage options
- Comes c/w gratnells storage trays, spring loaded paper dryer for up to 30 x A2 sheets
- Dimensions W1020 x D680 x H1100mm

Y200806 £279.50

CalStor Flexible Storage

- Premium range of tray storage & shelving units
- Robust steel frame with modern styling
- Choice of Silver or Cyan Blue livery
- Fill with any selection of Gratralls tray colours (see page 50 for choice)
- Units can either sit on static feet, or mobile braked castors – supplied with both options
- StopSafe © tray runners prevent trays falling out
- Sizes: Double column units H1025 x W690 x D430mm; Triple column units H1025 x W1020 x D430mm



A. 16 shallow tray unit

- Includes 16 shallow trays

Y203420	Cyan Frame	£193.80
Y203422	Silver Frame	£193.80



B. 8 deep tray unit

- Includes 8 deep trays

Y203424	Cyan Frame	£184.00
Y203426	Silver Frame	£184.00



C. Combination tray unit

- Includes 2 x deep & 4 x ex deep trays

Y203428	Cyan Frame	£193.80
Y203430	Silver Frame	£193.80



D. Jumbo tray unit

- Includes 4 jumbo trays

Y203432	Cyan Frame	£173.60
Y203434	Silver Frame	£173.60



E. 24 shallow tray unit

- Includes 24 shallow trays

Y203436	Cyan Frame	£246.50
Y203438	Silver Frame	£246.50



F. 12 deep tray unit

- Includes 12 deep trays

Y203440	Cyan Frame	£224.00
Y203442	Silver Frame	£224.00



G. Triple combi tray unit

- Includes 3x deep & 6 x ex deep trays

Y203444	Cyan Frame	£203.70
Y203446	Silver Frame	£203.70



H. 6 jumbo tray unit

- Includes 6 jumbo trays

Y203448	Cyan Frame	£193.80
Y203450	Silver Frame	£193.80

CalStor Library Storage

- Premium range of tray storage & shelving units
- Robust steel frame with modern styling
- Choice of Silver or Cyan Blue livery
- Tray versions can be filled with any selection of Gratralls tray colours (see page 50 for choice)
- Units can either sit on static feet, or mobile braked castors – supplied with both options
- StopSafe © tray runners prevent trays falling out
- Dimensions: H1025 x W1020 x D430mm



A. 6 deep tray unit

- Stop feature means trays can be pulled forward for browsing
- Includes 6 deep trays

Y203460	Cyan Frame	£193.80
Y203462	Silver Frame	£193.80



B. 9 angled deep tray unit

- Trays supported on tilt-position crossbars for open storage
- Includes 9 deep trays

Y203464	Cyan Frame	£178.50
Y203466	Silver Frame	£178.50



C. Flat shelf unit

- 3 wide shelves supported on flat crossbars

Y203468	Cyan Frame	£218.60
Y203470	Silver Frame	£218.60



D. Angled shelf unit

- 3 angled display shelves supported on tilted crossbars

Y203472	Cyan Frame	£173.60
Y203474	Silver Frame	£173.60

CalStor Classroom Trolleys

- Ergonomic tubular steel frame trolleys with loop handles, 75mm castors and foot activated brake
- Strong wire storage baskets
- Suitable for indoor & outdoor use
- Supplied flat-packed for easy self-assembly. Please ask for details of our assembly service if needed



E. Lunchbox trolley

- Can accommodate up to 30 x lunchboxes

Y203480	Cyan Frame	£247.50
Y203482	Silver Frame	£247.50



F. Cloakroom trolley

- 32 x double coat hooks
- Bottom wire basket for wellies or lunchboxes

Y203484	Cyan Frame	£272.40
Y203486	Silver Frame	£272.40



HandiStor Mobile & Static Metal Storage

- The HandiStor tray storage range is supplied with both wheels and feet and so can be used either as a mobile trolley, or static frames
- Manufactured with powder coated steel frame with MFC tops
- Supplied c/w Gratnells trays as shown. Select your colours from the range shown on page 50
- Choice of single column, double column or triple column widths
- Supplied flat packed for easy self-assembly.

New Product

MFC Tops

5 Year Warranty



Easy Self Assembly



A. Shallow tray, treble width
• 24 shallow trays

Y203500 £283.50



B. Deep tray, treble width
• 12 deep trays

Y203502 £184.20



C. Mixed tray, treble width
• 3 deep & 6 extra deep trays

Y203504 £164.50



D. Jumbo tray, treble width
• 6 jumbo trays

Y203506 £159.60



E. Shallow tray, double width
• 16 shallow trays

Y203508 £158.40



F. Deep tray, double width
• 8 deep trays

Y203510 £153.80



G. Mixed tray, double width
• 2 deep & 4 extra deep trays

Y203512 £154.30



H. Jumbo tray, double width
• 4 jumbo trays

Y203514 £144.00



I. Low shallow tray, single width
• 6 shallow trays

Y203516 £108.00



J. Low shallow tray, double width
• 12 shallow trays

Y203518 £145.20



K. Low shallow tray, treble width
• 18 shallow trays

Y203520 £180.00

Dimensions:

- Depth: All units 420mm
- Width: Treble 1054mm, Double 710mm, Single 370mm
- Height: with feet 850mm, with castors 925mm
- Low units height: with feet 640mm, with castors 715mm

Frame Colours

Colour Options

Silver Powder Blue Yellow

STEM Trolley

- Specialist, silver coloured, steel mobile trolley designed to house plastic trays, tool holders & small part storage bins
- Ideal for STEM and STEAM projects
- Trolley comes c/w 12 shallow trays, 3 deep trays, 12 green small parts bins, roll holder (for tape / ribbon / paper)
- Supplied with 5 single hooks and 5 double hooks
- Cabinet panels are designed to take industrial accessories using the "BOTT" type fixing method
- Supplied flat-packed for easy self-assembly. Please ask for details of our assembly service if needed
- Robust steel frame and heavy duty lockable castors
- Sliding trays, on Stop Safe runners, allow easy access to components

New Product



Easy Self Assembly

- Please select shallow & deep tray colours from range on page 50
- Dimensions: H1565 x D1020 x W435mm

Y203550 STEM Trolley each £485.40

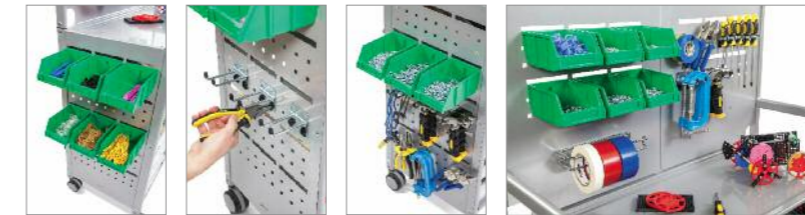

Science Tray Storage Installations

Please call for a free consultation for your larger projects – full Science Technician store rooms, integrated bench storage etc.

Using the wide range of accessories & fittings will enable you to customise your installation for the maximum benefit.

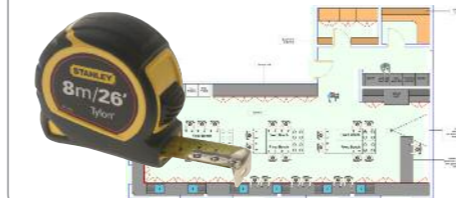

TecniStor Static Metal Tray Storage

- Static storage systems ideally suited for Science Technician or D&T storage, Print Rooms, Food Tech, or any other areas needing the flexibility of multiple sized compartments, easy retrieval of products or parts, along with the maximising of storage height
- Accommodates all depths of Gratnell's trays – mix available colours to fill the unit as shown
- Options of all tray storage, or a mix of plastic trays & open steel shelves
- Static construction with adjustable feet for stability
- Supplied flat-packed for easy self-assembly
- Full installation service available – please ask for a free site assessment and complete service package quotation
- Dimensions: All units 420mm deep. Single W370, Double w710, Treble W1055mm



New Product

5 Year Warranty



Frame Colours

Please specify when ordering



A. 51 shallow trays
• H1850

Y203600 £495.00



B. 9 deep & 18 shallow trays
• H1850
• Includes 6 single shelves

Y203602 £442.50



C. 3 jumbo, 3 deep & 18 shallow trays
• H1850
• Includes 12 single shelves

Y203604 £425.40



D. 30 shallow trays
• H1850
• Includes 6 single shelves

Y203606 £439.60



E. 27 deep Trays
• H1850mm

Y203607 £412.00



F. Open 4 shelf unit
• H1850mm

Y203608 £276.80



G. Open 6 shelf unit
• H1850mm

Y203610 £328.40



H. Shelf/drawer unit
• H1850mm
• 2 wide shelves & 6 wooden drawers

Y203612 £570.00

TecniStor Static Metal Tray Storage

5 Year Warranty

Metal Tops

New Product



A. 34 shallow trays
• H1850mm

Y203614 £362.00



B. 2 deep & 18 shallow tray
• H1850mm

Y203616 £330.00



C. Open 4 shelf unit
• H1850mm

Y203618 £226.50



D. 39 shallow trays
• H1500mm

Y203620 £412.40



E. 36 shallow tray
• H1500mm

Y203622 £395.00



F. 3 x jumbo, 6 x deep, 15 x shallow
• H1500mm

Y203624 £349.60



G. Shallow tray cupboard
• Includes 51 shallow trays
• Select any mix of tray colours
• H1830 x W1120mm 3 point locking doors

Y203626 £608.50



H. Deep tray cupboard
• Includes 27 deep trays
• Select any mix of tray colours
• H1830 x W1120. 3 point locking doors

Y203628 £529.00

Grey Paint

Frame Colours
Please specify when ordering.
Storage cupboards are only available in Grey

Grey Silver

Page Link - see page
More Metal Tray Cupboards 359



Page Link - see page
For Gratnell's trays 50



TecniStor Mobile Metal Trolleys

- Complete trolley sets with metal top built for demanding Science & Technical Environments
- Robust design with industrial style castors and steel top
- Choose bench height 850mm or under bench size 725mm
- Supplied complete with plastic Gragnells Trays – select from the range on page 50
- Optional steel shelf trolleys suit larger items
- Range of accessories available to fit – please ask for details
- Static frames also available - please enquire for details

New Product 5 Year Warranty



Durable Metal Tops

Colour Options

Frame Colours

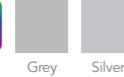

Please specify when ordering



A. 3 column tray unit
• W1055 x D420mm

B. 2 column tray unit
• W710 x D420mm

C. 1 column tray unit
• W370 x D420mm

Y203640	H850mm, 18 Tray	£278.60
Y203642	H725mm, 15 Tray	£264.00

Y203644	H850mm, 12 Tray	£218.50
Y203646	H725mm, 10 Tray	£208.00

Y203648	H850mm, 6 Tray	£129.80
Y203650	H710mm ,A3 Art Trolley	£125.00

TecniStor Static Low Storage Units

- Static units ideal for use under existing benching
- Sold without metal top – this can be ordered separately.
- Supplied c/w Gragnells trays – select any mix from page 50
- Also available as steel shelf units – ideal for larger items



D. 3 column static tray unit
• W1055 x D420mm

E. 2 column static tray unit
• W710 x D420mm

F. 1 column static tray unit
• W370 x D420mm

Y203652	H825mm, 21 Tray	£248.50
Y203654	H725mm, 18 Tray	£232.90

Y203656	H825mm, 14 Tray	£196.00
Y203658	H725 mm, 12 Tray	£184.50

Y203660	H825mm, 7 Tray	£101.00
Y203662	H725mm, 6 Tray	£95.60

Multiwall



- MultiWall creates extensive space-efficient resource storage situated at the front of the classroom to ensure that teaching staff have resources available whenever they teach
- MultiWall includes a variety of lower storage options, and upper units can include interactive whiteboards or projection screens, sliding drywipe panels or pinboards with adjustable shelving behind
- Modular system allows for bespoke configurations to your specific needs
- Large range of colour finish options and sizes to suit the available space
- Suits and facilitates multiple use classrooms



Colour Options

Units available in:

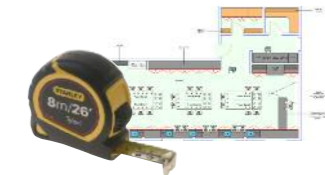

Please phone for details and prices

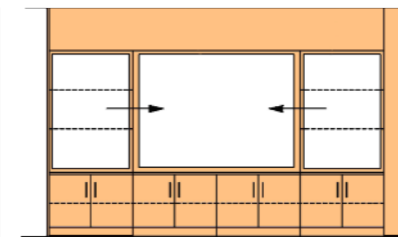

Teaching Wall

The perfect answer to your classroom storage needs, Teaching Wall extends the StorageWall concept to a classroom situation to combine a space-efficient resource storage front teaching area. As well as empowering the teacher by having all their resources right at hand, the compact floor footprint can even increase the available teaching and student area. The adaptability of Teaching Wall can transform even the most difficult spaces into a cutting edge learning environment.

Please phone for free consultation



Tailored Fit for Difficult Spaces



Choice of Colours See Options



Floor To Ceiling



Locking Doors



Whiteboard Doors



Integrated Trays



Page Link - see pages 350-353 For details on Teaching Wall's storage partner - Storagewall



Sink Units



Add-on Hubs



Science Lab Application



Student or Staff Lockers

Teaching Wall



Transforming teaching environments and maximising your spaces!

Colour Options

Wood and colour finishes may not be representative of actual colours - please ask for a sample



Laminate finishes





3 work surface heights available to suit all age ranges

classtor™

the modular classroom storage system

- This modular system offers a range of storage solutions for the classroom - making the most of your space
- 3 work surface heights - infant, junior and senior
- A wide range of units enable suitable storage of books, art paper, art supplies and national curriculum materials to keep your classroom organised, neat and tidy
- Available in an easy to clean, modern look with a wide range of wood finishes and worktop designs
- We offer a space planning service to work with you to get the most from your classroom and storage

classtor™

the modular classroom storage system

Classtore offers a wide range of materials and finishes in all its configurations. Whether you want solid wood, laminate or even trespa finishes, we can help.

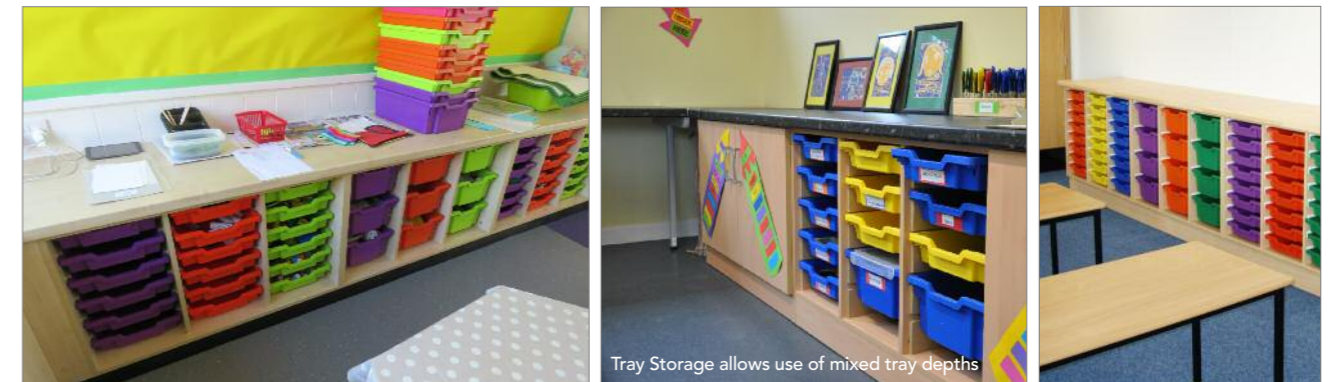

Tray Storage allows use of mixed tray depths

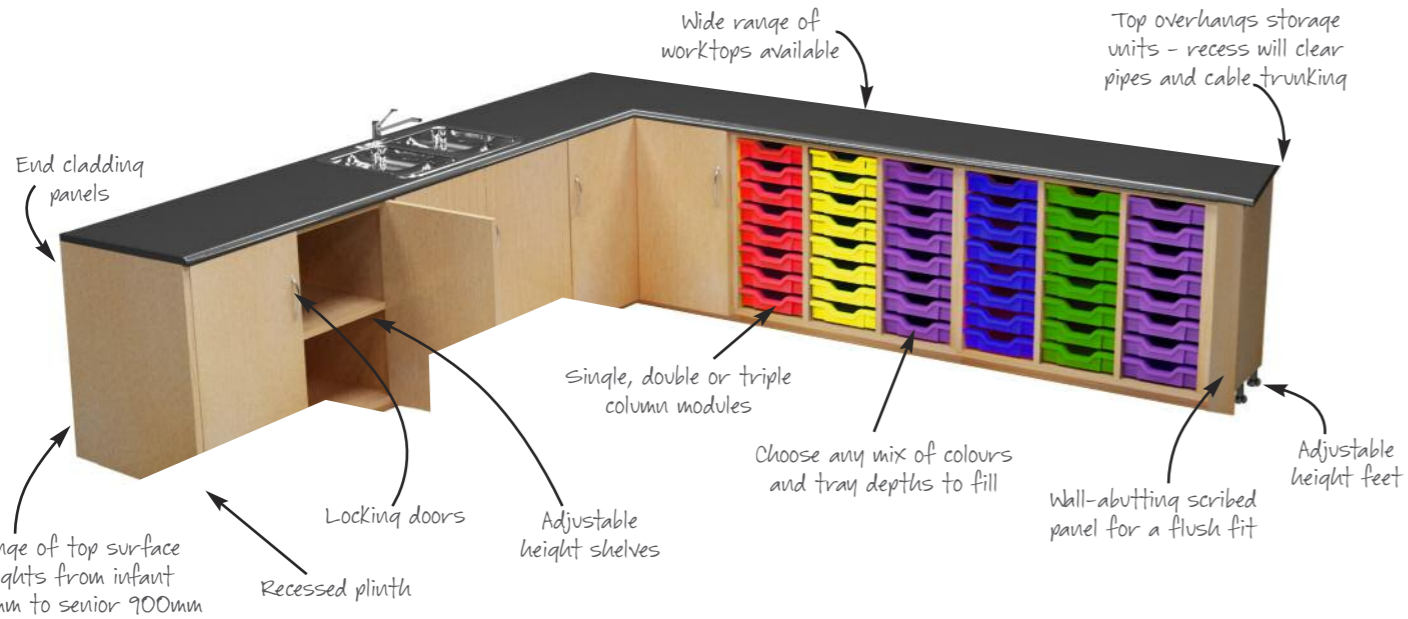

Survey & Space Planning Service

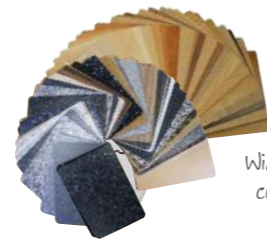
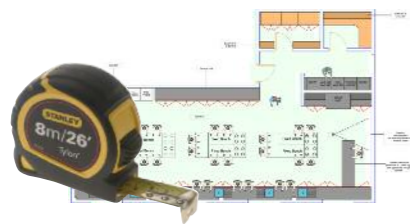

Wide range of worktop colours and finishes





Are you stimulating those young minds?

Strong, attractive furniture with a friendly & fulfilling approach promotes creativity from day one!

Early Years

Cushions & Mats	102-105
Sand & Water Play	106
Easels	107
Role Play Panels	108-109
Play Furniture	110-114,118
Storage Solutions	115-117
Tables & Chairs	119-122
Soft Seating	123-126
Outdoor Play	127

Early Years

Here we present a range of products that provide a safe, comfortable and colourful environment, where children enjoy a world they recognise and where their imaginations are inspired.

There is somewhere to sit and learn alone, or to be taught in groups in which children will find friendship and fulfilment.

Our products provide children stimulation through use and display. Our storage facilities ensure that their daily world is left neat and tidy.

Cloakroom and lunch storage facilities teach young minds to guard and value their personal space and possessions.



Floor Cushions & Trolleys

- Ideal for group reading & teaching activities
- Wipe clean cushions made from high quality vinyl
- Items C & E, cushion colours may vary



Supports group discussion



Y330006

Y330008



Best Seller

A. Emotion floor cushions

- Pack of six cushions with multi curricular applications
- Useable as stepping stones or wipe clean story cushions

Size each Dia x H

Y330006	350 x 60mm	£68.40
Y330008	350 x 60mm	£68.40

B. Emotion cushion trolley

- Trolley supplied with 12 donut style cushions
- One side shows facial expression, reverse has key discussion word for group activity
- Trolley size W700 x D360 x H430mm

Y330003	Emotion Cushions & Trolley	£169.50
---------	----------------------------	---------

C. Plain coloured donut cushions trolleys

- Multi-cushion trolleys c/w 12 or 24 assorted coloured 350mm diameter floor cushions
- Trolley size W700 x D360mm
- 12 seat H430mm, 24 seat H730mm

YFN0080	12 Seat Trolley	£159.60
YFN0079	24 Seat Trolley	£248.50

Also suitable for outdoor play.



D. Square cushion trolley

- Brightly coloured 350mm square cushions for classrooms & reading areas
- Cushions are washable at 30C
- Trolley size W800 x D380 x H400mm c/w 32 assorted coloured cushions 350 x 350 x 20mm

Y330001		£236.00
---------	--	---------

Trolleys available separately - please ask for pricing

E. Story cushions

- Durable waterproof, wipe clean cushions
- Ideal for group reading time
- Made to exacting quality standards and finished in soft touch vinyl
- Meets all relevant safety & fire standards
- Dimensions 500mm diameter x 75mm

Y330010	Pastel Assorted	pk 10	£149.60
Y330012	Vivid Assorted	pk 10	£140.00



F. Ladybird counting cushions

- Encourages numeracy skills
- Great for group activities & quiet reading times
- Pack of 13 includes 12 small ladybird cushions (390 x 40mm) numbering from 1 to 12, and 1 larger (480 x 40mm) teacher cushion
- Removable washable covers
- Includes free holdall

Y330014		pk 13	£135.60
---------	--	-------	---------

Carpets & Playmats

Carpets on this page have a compact, flatter pile than the heavy duty pile carpets on the following pages.



A. Multi-cultural welcome carpet

- This highly visual carpet has a children around the world theme showing children from different cultures and the word "welcome" in multiple languages
- A durable carpet with an anti slip backing ideal for both the school entrance or the classroom
- Size: W2000 x D1300mm

Y330308		£78.20
---------	--	--------



B. Town & country road carpets set

- A set of 4 road map carpets to cover the town, a village, country, farm and airport
- Place in any combination next to each other
- Scaled for most model vehicles, the roads line up to make one large network
- Tightly woven Durable Loop Pile enables easy movement of model vehicles
- Size: W1000 x D1000mm, 4 x squares

YMAT049	set 4	£79.60
---------	-------	--------



C. Rainbow numbers carpets

- 2 sizes of brightly coloured number carpet
- Ideal for teaching basic numeracy skills
- Choose from 1-100, size: W2 x D1.5m, or smaller 1-24, size: W1.5m x D1m
- Durable tuf-loop

Y330300	1-100 Carpet	£68.40
Y330302	1-24 Carpet	£43.50

Outdoor Carpets

- Great for teaching children about the natural world around them, or for outdoor play
- These carpets have a lighter weight pile making them easier to move
- Include hardwearing, waterproof backing for outdoor use
- For outdoor playgrounds or grass areas



D. Outdoor hopscotch mat

- Ideal for group activities and outdoor play
- Size 3 x 1m
- Outdoor tuf loop

Y330304		£98.40
---------	--	--------



E. Garden outdoor mat

- 3m x 2m

Y330306		£186.50
---------	--	---------



F. Minibeasts outdoor mat

- 2.4m x 2m

Y330312		£148.00
---------	--	---------

Please ask for details on our range of outdoor mats

Activity Rugs

- High quality and heavy duty tufted pile, soft texture rugs
- Non crease with a non-slip back
- Stain-resistant coating and washable
- Distinctive and brightly coloured classroom relevant designs
- Stitch binding on all edges to prevent fraying
- Heavy duty pile for comfort

Large range of mats available. Please ask if you cannot find the design you need.

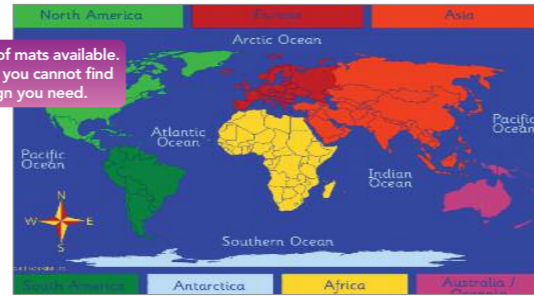

Best Seller



A. Primary world multi-cultural rug

- Brightly coloured, circular rug accurately depicting children from around the world
- Designed to engage discussion into ethnicity and develop cultural and religious awareness
- Ideal group learning aid to introductory multicultural studies
- Size 2m x 2m, circular
- Heavy duty pile

Y330314 £169.80

B. World carpet

- 3m x 2m brightly coloured rectangular carpet
- Each continent colour coded and labelled
- Ideal group learning aid to introductory Geography
- Heavy duty tufted pile with anti-skid backing

YMAT021 £179.60

C. Rainbow abc rectangle carpet

- A bright addition to the classroom or nursery environment
- Features 20 brightly coloured ovals surrounded by the alphabet in upper and lower case
- Size: 3m x 2m

YMAT1014 £215.80



New Product



D. Emotions interactive carpet

- Distinctive rectangular carpet W3m x D2m
- Encourages group discussion about feelings & interaction
- Children can choose an expression to sit on during reading or group lessons
- Features 24 x placement spots

Y330318 £198.40

E. Ladybird numeracy & literacy carpet

- Large 3m x 2m rectangular indoor mat with heavy duty soft pile
- Ideal for cross-curricular use, providing opportunities for developing both numeracy & literacy skills
- Can also be used with the ladybird counting cushions on page 98

Y330320 £218.50

F. Weather carpet

- Colourful carpet covering the weather, seasons, months and days
- A functional, hard-wearing carpet ideal for group floor reading activities and floor play
- Size: 2m x 2m square
- Heavy duty pile

YMAT030 £133.20

Activity Rugs

- Heavy duty pile for comfort



A. Alphabet mini placement rugs

- 26 square alphabet rugs ideal for temporary classroom floor soft seating activities like reading and group play
- With FREE holdall
- Each rug: W400 x D400mm

YBN0102 set 26 £159.80



B. Rainbow semi-circle carpet

- Extra large carpet for large groups
- Size W2m x D4m
- Features 24 placement spots and 1 teacher spot

Y300308 £295.00



C. A to Z carpet

- Large colourful visually stimulating carpet. Designed with KS1, Literacy relevance in mind
- Perfect for children to sit and enhance learning word and letter recognition/ association
- Lowercase and uppercase
- Size: W3m x D2m, rectangular
- Heavy duty pile

YMAT092 £199.60



D. Oval pencils alphabet carpet

- This highly visual oval carpet depicts pencils and the alphabet
- Excellent for group use & word recognition
- Size W3m x D2m, oval
- Heavy duty pile

YMAT1007 £215.60



E. Fruit placement carpet

- Large square 3m x 3m carpet with soft, heavy duty pile for comfort
- Colourful fruit icons
- To seat 30 children
- Ideal for healthy eating topics

Y330312 £288.00



F. Life cycle carpet

- Ideal for learning about life cycles
- Encourages group discussion about the natural world
- Size: 2m x 2m

Y330316 £174.80



Sand & Water Play



- Encourages outdoor play
- All sand & water trays have robust, blue powder coated metal frames with castors for easy moving



A. Sand & water tray

- Blue plastic tray
- Lids also available
- Tray dimensions: W56cm x L82cm x H19cm
- Overall frame height 55cm

YSWTR24	Sand & Water Tray	£129.80
YSWLID42	Covering Lid	£38.90

B. Extra large sand & water tray

- Several children can play together in comfort
- Drainage tap fitted to bottom of tray
- Tray size: W67cm x L131cm x H26cm
- Overall frame height 59cm

YSWTR72	Giant Sand & Water Tray	£198.50
YWS7273	Giant Sand & Water Tray C/with Red Covering Lid	£248.20

Page Link - see page

For wooden sand & water play

127



C. Adjustable height water tray

- Clear sand & water tray with handy drainage tap
- Use the frame without the removable legs for low level play
- Tub size: W52cm x L73cm x H16cm
- Overall frame height 58cm (with legs)

YSWTR85	Clear Sand & Water Tray	£135.80
YSWLID75	Covering Lid	£38.20

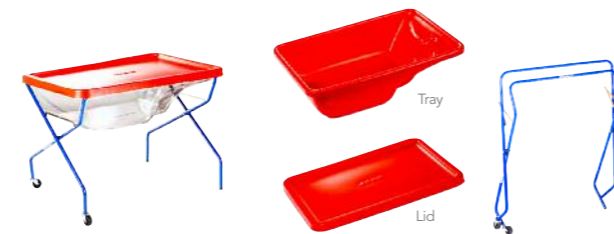

D. Waterfall sand & water tray

- Fun sand and water tray with a rock wall feature moulded into one end of the tub
- Also creates waterfalls
- Frame can be folded up for storage

YSWTR77	Clear Water Tray & Stand	£129.60
YSWTR78	Red Water Tray & Stand	£129.60
YSWLID81	Red Covering Lid	£38.60

Height Adjustable Mobile Classroom Easels

- These mobile easels with magnetic whiteboards are a perfect teaching aid for front of class
- Sturdy A frame construction guarantees safety & stability at all heights
- Each easel has quick & easy height adjustments to accommodate all age groups - simply click on and off at the height required
- Full length integral pen & book tray and adjustable flipchart fittings
- Castors are fully locking
- Choice of Red-RD or Blue-BL high gloss powder coated metal frame



A. Large a-frame mobile easel

- 4 height adjustments from 1110mm up to 1790mm
- 900 x 900mm magnetic whiteboard
- Two plastic storage trays

Y300400*	£254.80
----------	---------

*Please specify frame colour Red-RD, or Blue-BL



B. Small a-frame mobile easel

- Smaller version of the large easel for younger years
- Height adjustable from 820 - 1190mm
- Magnetic whiteboard size is 600 x 600mm
- Supplied with 1 x storage tray

Y300402*	£227.60
----------	---------

*Please specify frame colour Red-RD, or Blue-BL



C. Landscape style easel

- Adjusts from 785 - 1460mm in 5 increments
- Single boarded easel comes c/w 3 storage trays, double boarded with 2 storage trays
- Board size: 900 x 900mm

Y300404*	Single Boarded Easel	£248.00
----------	----------------------	---------

Y300406*	Double Boarded Easel	£285.60
----------	----------------------	---------

*Please specify frame colour Red-RD, or Blue-BL

Table Easels

- Solid beech table frames with holes for paint pots etc.
- Magnetic easel sections can be removed & used as floor easels for younger children
- Add paper for drawing & painting by loosening the wheels at the top
- Supplied flat pack for easy self-assembly



Easy Self Assembly



A. 2-person table easel

- Dimensions H1180 x W900 x D600mm

YEAS6592	£234.80
----------	---------



B. 4-person table easel

- Allows 2 children to work side by side
- Dimensions H1180 x W1480 x D600mm

YEAS6542	£318.00
----------	---------



C. 4-sided table easel

- 4 easel faces in a square making a more compact easel
- Dimensions H1180 x W900 x D600mm

YEAS6552	£292.60
----------	---------

Role Play Panels

- Ideal for dividing spaces, creating role play areas or simply for display
- Made from Birch plywood in light Maple finish with a hardwood frame and colourful uprights
- Connecting mechanism has a locking feature at the top for additional safety
- For stability, please ensure that a minimum of 3 panels are connected together at top and bottom of the panel
- Available as 3 different cost-saving kits, or choose any combination of single panels from the following page



New Product



A. Role play panels kit 1

- Consists of 1 x door panel, 1 x plain maple panel & 1 x window panel

Y320200 £368.50



B. Role play panels kit 2

- Consists of 1 x whiteboard panel, 1 x loop nylon display panel, 1 x chalkboard panel

Y320202 £378.60



C. Role play panels kit 3

- Consists of 1 x double door panel, 1 x counter panel, 1 x chalkboard panel

Y320204 £388.40



D. Accessory kit

- Set of 8 acrylic signs designed for use with the window panels. Ideal for using to create various role play scenarios

Y320206 £35.80



Role Play Panels



New Product



A. Plain panel

- Plain Maple panel for display or use as a space divider in play scenarios
- Dimensions: H1200 x W800mm

Y320308 £132.50



B. Chalkboard

- Double sided chalkboard surface
- Dimensions: H1200 x W800mm

Y320310 £133.40



C. Whiteboard

- Double sided panel with plain whiteboard one side, gridded reverse
- Dimensions: H1200 x W800mm

Y320312 £133.40



D. Mirror

- Panel features safety mirror. Ideal for dressing up areas
- Dimensions: H1200 x W800mm

Y320314 £144.60



E. Single door

- Door panel with safety hinge
- Features letter box, peep hole & door bell
- Dimensions: H1200 x W800mm

Y320316 £145.20



F. Double door

- Panel features double door with safety hinges
- Space above door for header accessory panel
- Dimensions: H1200 x W800mm

Y320318 £145.90



G. Display board

- Display board panel with grey loop nylon surface
- Suitable for use with Velcro fixings
- Dimensions: H1200 x W800mm

Y320324 £132.80



H. Counter top

- Counter panel with removable shelf
- Whiteboard base panel
- Space above for a header
- Dimensions: H1200 x W800mm

Y320326 £145.50



I. Window panel

- Open ended design allows for a variety of different play scenarios
- Can be used to create houses or shops
- Dimensions: H1200 x W800mm

Y320328 £133.60



J. Wide window

- An extra wide panel to allow for creation of larger structures such as houses
- Dimensions h1200 x W1000mm

Y320330 £144.30

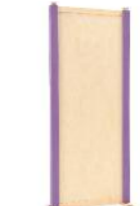

K. Narrow plain panel

- Maple coloured panel with purple uprights
- Narrower width than the other panels
- Dimensions: H1200 x W480mm

Y320332 £109.70



Play Corners

- Extensive range of solid beech modular furniture with scratch resistant clear lacquered finish
- Designed to bring storage units and creative play areas together
- Modules fix together with solid beech connecting posts
- Ideal for creating "areas" from larger rooms and establishing boundaries
- Supplied flat packed for easy self-assembly, please ask for pricing for assembly if required
- Accessories and soft furnishings shown are for photographic purposes only and are not included



Easy Self Assembly

Some items are available separately as single units – please ask for prices & details



A. Reading corner

- 2 x 1200mm wide shelf units
- 2 x Curved shelf units
- 1 x Corner seating unit with lime cushions
- 1 x 600mm entrance arch
- 2 x Pk2 90 degree posts

Y320101

£1725.00



B. Art & craft corner

- 1 x Art & craft unit c/w plastic pots
- 1 x Half bookcase unit
- 2 x Curved shelves with back
- 1 x 3-bay 18 shallow tray unit c/w trays
- 1 x Drying rack (racks included)
- 1 x Double sided easel c/w pots
- 5 x Pk2 90 degree posts

Y320102

£1892.00



Many components are available separately if required - please ask for pricing

C. Storytime corner

- 1 x High "throne" seating unit
- 1 x High "throne" single seat
- 2 x 1200mm wide shelf unit
- 1 x Tall 960mm entrance arch

Y320103

£1275.00



D. Library corner

- 1 x Reading corner seating unit c/w lime cushions
- 2 x 1200mm wide shelf unit
- 1 x Tall 960mm entrance arch

Y320104

£1280.00

Play Corners



Easy Self Assembly

Accessories Not Included



A. Role play corner

- 1 x Cloakroom unit
- 1 x Open bookcase with solid back
- 2 x Curved shelves with back
- 1 x Angled tidy
- 1 x Shop theatre
- 1 x Pk2 90 degree post
- 1 x Pk2 90 degree double post
- 1 x Tall 960mm entrance arch

Y320105

£1598.00



B. Art corner

- 2 x Corner Shelf Unit
- 1 x Room Fence Gate
- 1 x Entrance Frame
- 1 x Perspex Room Divider
- 1 x Art Craft Unit with 12 pots
- 1 x Multi Purpose Storage Unit
- 1 x Classroom Tidy with Baskets
- 3 x (2 x 90 Degree) Posts

Y320108

set

£1570.00



Many components are available separately if required - please ask for pricing

C. Construction corner

- 2 x Curved shelves with back
- 2 x 1200mm wide shelf unit
- 3 x Pk2 90 degree posts

Y320106

£1028.00



Accessories, tray, mats & building bricks are not included

D. Starter corner unit

- Starter kit – archway fixes to each unit. Allows addition of extra units at a later date.
- 2 x 1200mm wide shelf units
 - 1 x Tall entrance arch 960mm

Y320107

£675.50

Play Corners



Easy Self Assembly

Accessories Not Included
Please ask for pricing for
assembly if required



A. Shopping corner

- 2 x Curved Shelves
- 1 x Entrance Frame
- 1 x Shop Theatre
- 1 x Role Play Panel
- 1 x Angled Tidy Store
- 1 x (2 x 90) Degree Posts
- 1 x 2 x Wallplate
- Tables & chair not included,
see pages 119-120 for pricing

Y320109 set £1184.00



B. Multiplay corner

- 4 x Curved Shelves
- 1 x Open Bookcase/Shelf
- 1 x Storage Unit
- 1 x Doorway Entrance
- 1 x Shop Theatre
- 1 x Multi Purpose Storage Unit
- 1 x Room Divider Drywipe
- 1 x Angled Tidy Store
- 1 x 90 Degree Posts
- 1 x 90 Degree Double Posts
- 1 x Inset Panel for Bookcase

Y320112 set £2344.00



C. Work corner

- 2 x Curved Shelves
- 1 x Corner Shelf Unit
- 1 x Open Bookcase/Shelf
- 1 x Classroom Tidy with Baskets
- 2 x 90 Degree Posts x 4
- Tables and chairs not included

Y320111 set £1030.00



D. Book corner

- 2 x Curved Shelves
- 1 x Open Bookcase/Shelf
- 1 x Storage Unit
- 1 x Entrance Frame
- 2 x (2 x 90 Degree) Posts
- Seating and kinderbox with mirrors not included

Y320110 set £985.00

Play Corners



Easy Self Assembly

Accessories Not Included
Please ask for pricing for
assembly if required



A. Craft corner

- 2 x Curved Shelves
- 1 x Cork Room Divider
- 1 x Storage Unit
- 1 x Art & Craft Unit with 12 Pots
- 1 x Cork Room Divider
- 2 x 90 Degree Posts
- 1 x 90 Degree Double Posts
- Table & chairs not included, see pages 119-120
for pricing

Y320113 set £1138.00



B. Display/store unit

- 2 x Corner Shelf Unit
- 1 x Cork Room Divider
- 1 x Storage Unit with Baskets
- 1 x Room Divider Cork
- 2 x 90 Degree Posts
- 1 x 90 Degree Double Posts

Y320115 set £842.60



C. Play-run corner

- 2 x Corner Shelf Unit
- 1 x Cork Room Divider
- 1 x Room Fence Gate
- 1 x Perspex Room Divider
- 1 x 45 Degree Posts
- Sofa and accessories not included

Y320116 set £786.50



D. Crawl-through corner

- 1 x Crawl Through
- 2 x Multi Purpose Storage Unit
- 2 x 45 Degree Posts

Y320117 set £642.40

Wooden Play Furniture

Play modules

- Provides hours of fun for children in Nursery & Primary years
- Frame is free standing so easy to lift & move
- Also ideal for use on stage for school productions
- Arched frame & side panels 15mm beech plywood
- 25mm solid beech dowels form the frame
- Dimensions: W1800 x H1200 x D1200mm
- Supplied flatpacked for easy self assembly (or please ask for pricing for assembly)
- Canopy included in a choice of 3 colours: lime, orange & black
- Please specify colour when ordering



Available in:

Colour Options

Lime (L) Orange (OR) Black (BK)

Easy Self Assembly



A. Play module

Y320150 £259.00



B. Play module with 2 sets of curtains

Y320152 £316.30



C. Play module with 2 sets of curtains, 6 scatter cushions & large mat

Y320154 £525.00



D. Stage play module

- Useful module for stage productions
- Also provides hours of fun in nursery or early years classrooms for role play
- Solid beech frame with MDF panels
- Open back and half height sides
- Curtains & accessories not included
- Dimensions H1700 x W1800 x D1040mm
- Supplied flat packed for easy self assembly

Y320156 £715.20



E. Shop canopy with angled tidy

- Choice of wicker baskets or trays, other contents not included
- Supplied flat packed for easy self-assembly

Y1394402 With Trays £458.60
Y1394412 With Wicker Baskets £486.50



F. Shop canopy with open bookcase

- Contents not included
- Supplied flat packed for easy self-assembly

Y1394422 £425.40

Easy Self Assembly

Please ask for costings for assembly

Natural Beech Storage Units

Double sided beech units

- Uniquely designed double sided units
- Made from 18mm Beech Faced MFC with ABS Edging
- The top of the units can be used as a Play Table and the solid beech frames surrounding the tops prevent items from rolling off onto the floor
- One side has opening doors, or trays, reverse is open storage
- Supplied flat pack with trays as shown
- Dimensions W940 x D610mm. Accessories not included

Please ask for costings for assembly

Easy Self Assembly



Reverse of items A-D is open shelving



A. Resource unit with doors
• Doors / open shelving reverse

Y1392002 £306.40



B. Display unit with mirror/top shelves
• Please choose tray colour

Y1392292 With Trays £429.60
Y352282 With Baskets £482.50



C. Book display unit
• Please choose tray colour

Y1392422 With Trays £342.60
Y352412 With Baskets £390.00



D. Storage unit with easel
• Please choose tray colour

Y1392232 With Trays £386.50
Y352222 With Baskets £432.00

Trays available in:

Colour Options

Blue (BL) Yellow (YW) Red (RD) Clear (CL)

E. Mobile art trolley

- Double sided mobile Art Resource trolley made from beech faced MFC with ABS soft edging.
- Incorporates solid beech beadings & rails
- Built-in scissor block & sections for paper, paints, art resources & ribbon rail
- One side has 9 storage compartments to hold plastic trays or willow baskets (priced separately)
- 24 assorted pots & art trays included

Y1393102 H960 x W965 x D600mm £448.50
YBASKET Deep Wicker Basket £17.00
YARTRAY* Plastic Art Tray £5.60
* Please specify colour



Front View

With Trays



Wicker baskets

Choose from baskets or plastic trays

Single Sided Storage

- Large range of interesting storage units in beech faced MFC with solid beech beading & ABS lippings
- Supplied flat packed for easy-self assembly
- Please ask for costings for assembly if required
- Units supplied c/w baskets or trays as shown



Contents not include



A. Angled storage unit

- Integral whiteboard with mirror reverse
- Angled shelves c/w with either wicker baskets or plastic storage trays
- H1300 x W1050 x D430mm

Y1394542	With Wicker Baskets	£468.40
Y1394532	With Plastic Trays	£440.30

B. Tiered access unit with 6 trays

- Supplied c/w 6 trays - please specify colour
- Dimensions H870 x W1015 x D460mm
- Also available with wicker baskets - ask for pricing

Y1381492	Right Hand Tiered Unit	£259.60
Y1381502	Left Hand Tiered Unit	£259.60

C. Tray unit with cork display panel

- Dimensions H1080 x W1015 x D500mm

Y1360522	9 Deep Tray Unit	£269.80
Y350532	18 Shallow Tray Unit	£288.70

Trays available in:

Colour Options

Blue (BL) Yellow (YW) Red (RD) Clear (CL)



Please ask for costings for assembly

Page Link - see page

Lunchbox & Bag Storage

86-89



D. Tray & shelf unit

- Dimensions W1015 x D500mm

Y1360572	6 Shallow Tray Unit w/cork Panel	£236.90
Y350372	3 Deep Tray Unit w/flat Top	£162.50



E. Open display units

- H650mm x D425mm, curve unit W735mm, straight W960mm

Y354002	45 Degree Curve Unit	£168.80
Y354022	Straight	£212.60



F. Lockable storage cupboard

- Supplied c/w 1 shelf
- Size: H650 x W960 x D430mm

Y1397512		£356.50
----------	--	---------

Classroom Tidy Trolleys



- New range of high quality classroom tidy trolleys made from solid beech, finished in a clear natural lacquer
- All units supplied c/w castors for easy mobility
- Choose from plastic tubs (choice of Clear-CL, Red-RD, Blue-BL, or Yellow-YW), or wicker baskets for a more natural look
- Supplied flat packed for easy self-assembly - please ask for details of our assembly service if needed
- Single sided or double sided options



A. Single tidy trolley

- Dimensions W860 x D410 x H810mm
- Supplied c/w 9 baskets, or tubs (please specify colour)

Y350000	Single Tidy with 9 Tubs*	£145.20
Y350002	Single Tidy with 9 Baskets	£227.20



B. Single wide tidy trolley

- Dimensions W1150 x D410 x H810mm
- Supplied c/w 12 baskets, or tubs (please specify colour)

Y350004	Wide Tidy with Tubs	£172.00
Y350006	Wide Tidy with Baskets	£227.50



C. Double-sided tidy trolley

- Dimensions W860 x D740 x H810mm
- Supplied c/w 18 baskets or tubs (please specify colour)

Y350008	Double Tidy with Tubs	£218.40
Y350010	Double Tidy with Baskets	£359.80

Static Tub Tidies



- Made from durable Natural beech MFC with solid beech connecting struts
- Dimensions W960 x D425 x H650mm
- Supplied with a choice of 9 plastic tubs, or wicker baskets
- Supplied flat packed for easy self assembly

Y350020	Classroom Tidy with 9 Tubs	£157.40
Y350022	Classroom Tidy with 9 Baskets	£208.20



Tubs available in:

Colour Options

Blue (BL) Yellow (YW) Red (RD) Clear (CL)

Indoor Play Kitchen

- Robust, high quality play kitchen made from solid birch timber with a natural finish
- Soft close doors, turning knobs & beautiful detailing give real play value
- Ideal for role play, and suitable for early years use
- Encourages daily routines & skills and develops social interactions, sharing & dramatic play
- Available as separate units, or a full set at a bulk pack price
- Each piece: Dimensions W40cm x D33cm.



A. Refrigerator

- Contains 2 shelves and opening doors
- Height 73cm

Y320400 £179.00



B. Play oven & stove

- Opening door & internal shelf
- Height 54 cm

Y320402 £144.60



C. Play washing machine

- Features pull out drawer and opening front
- Height 54cm

Y320404 £178.50



D. Play sink

- 2 drawers and top has metal sink bowl.
- Height 54cm

Y320406 £143.20



E. Microwave

- Features opening door
- Height 19cm

Y320408 £85.60



F. Kitchen set

- Contains 1 each of Refrigerator, Oven & Stove, Washing Machine, Sink & Microwave

Y320410 £618.00

Nursery Chairs

A. Beech chairs

- Solid beech classic style chairs in ideal heights for nursery children
- Available with or without play/feeding tray
- Feeding tray can be stored on top of chair
- Supplied flat packed for easy self-assembly

Y300100	Infant Chair	H140mm	pk 2	£115.40
Y300102	Infant Chair	H200mm	pk 2	£123.60

Y300104	Feeding Chair	H140mm	each	£101.60
Y300106	Feeding Chair	H200mm	each	£102.80



Easy Self Assembly

B. Children's captain's chairs

- Nursery size wooden Captain's Chairs in natural beech finish
- Supplied in packs of 2 the same size

YCPT5642	H200mm	pk 2	£107.20
YCPT5672	H280mm	pk 2	£111.80
YCPT5702	H320mm	pk 2	£112.60



C. Nursery chairs

- These popular chairs are solid hardwood with either coloured seats & backs or a natural beech finish
- The chairs are stackable and available in a pack of four in a range of three heights
- Assorted chairs: 1 each of red, yellow, green and blue

YSTCHBL1	Blue Chair	pk 4	H260mm	£138.60
YSTCHBL2	Blue Chair	pk 4	H310mm	£145.80
YSTCHBL3	Blue Chair	pk 4	H350mm	£163.40

YSTCHRD1	Red Chair	pk 4	H260mm	£138.60
YSTCHRD2	Red Chair	pk 4	H310mm	£145.80
YSTCHRD3	Red Chair	pk 4	H350mm	£163.40

YSTCHBCH1	Beech Chair	pk 4	H260mm	£138.60
YSTCHBCH2	Beech Chair	pk 4	H310mm	£145.80
YSTCHBCH3	Beech Chair	pk 4	H350mm	£163.40

YSTCHMIX1	Assorted	pk 4	H260mm	£138.60
YSTCHMIX2	Assorted	pk 4	H310mm	£145.80
YSTCHMIX3	Assorted	pk 4	H350mm	£163.40



Page Link - see page
For our table & chair height guide

Solid Beech Nursery Tables

- Fixed height, solid beech tables with smooth rounded corners in H530mm (suitable for age 4-6) and chunky 45mm solid beech legs
- Stronger table construction with underframe
- Finished with clear lacquer
- Other heights available to order
- Also can be supplied with beech veneer tops at a lower cost POA.

Suitable for Ages 2-8



A. Circular



B. Rectangular



C. Square



D. Trapezoid

Y353032	1000mm dia	£198.60
Y352112	1200mm dia	£229.80

Y353012	960 x 690mm	£198.00
Y353022	1200 x 690mm	£226.90
Y352022	1500 x 690mm	£229.40

Y353002	690 x 690mm	£132.50
---------	-------------	---------

Y353062	1200mm	£211.86
---------	--------	---------

Adjustable Height Nursery Tables

- Height adjustable coloured top tables
- Height adjustable to 4 heights: 400mm, 460mm, 520mm & 580mm
- With solid beech frames, rounded corners and high quality coloured laminate tops with ABS edging, these tables are built to last!
- These tables coordinate with our nursery chairs (see page 119)
- Please specify colour: Blue-BL, Red-RD, Orange-OR, Green-GR, Yellow-YW, or Natural Beech - BE

Suitable for Ages 2-8

Beech finish New for 2019

Page Link - see page

For more chairs...

119



A. Rectangular tables

- Size W1200 x D800mm

YMRECTB*	£172.80
----------	---------



B. Square tables

- Size W800 x D800mm

YMSQTB*	£149.50
---------	---------



C. Round tables

- Size W1000 x D1000mm

YMROUTB*	£168.00
----------	---------



D. Hexagonal tables

- Size W1020 x D800mm

YMHXTB*	£216.00
---------	---------

Height Adjustable Themed Tables

- Height adjustable themed tables, perfect for group work & very popular in nurseries, primary schools & special schools
- Hardwearing, easy clean 25mm laminate tops with black PVC moulded edging and rounded corners
- 50mm black powder coated frame for scratch resistance and stability, with grey self-levelling feet
- All tables are height adjustable from 430 - 635mm in 25mm increments and suitable for wheelchair users
- The unique Tri-Lock™ leg strengthening system provides maximum leg strength in all heights and protects against multidirectional impacts



Please note that these tables are built to exacting standards and are tested to BS EN 1729-2:2006. Tested by FIRA, these tables are structurally suitable and sufficiently stable for heavy educational use.



Best Seller

A. Horseshoe table

- Top dimension of 1675 x 1520mm

YFN0013A	Red	£244.20
YFN0014A	Blue	£244.20
YFN0015A	Yellow	£244.20



Best Seller

B. Clover table

- Top dimension of 1026 x 1026mm
- Suits group work & student interaction. Seats 4

YFN0007A	Red	£133.50
YFN0008A	Blue	£133.50



C. Arc table

- Top dimension of 1600 x 800mm

YFN005A	Red	£159.60
YFN006A	Blue	£159.60
YFN0149	Yellow	£159.60



Best Seller

D. Flower table

- Top dimension of 1525 x 1525mm
- Suits group work & student interaction. Seats 6+ students

YFN0010A	Red	£208.50
YFN0011A	Blue	£208.50
YFN0012A	Yellow	£208.50



E. Rectangular table

- Premium quality rectangle table helping facilitate creative student teacher interaction
- Top dimension of 1500 x 750mm

YFN0156	Red	£144.20
YFN0157	Blue	£144.20



F. Teacher's flower table

- Designed for larger group teaching and is perfect for teacher student interaction
- Top dimension of 1525 x 1525mm

YFN0153	Red Table	£209.80
YFN0154	Blue Table	£209.80

Group Work Tables

- Softly curved edge table forming a flower shape
- Lightweight table with an aluminium frame & legs and hardwearing ABS edging
- Dimensions L1200 x W1200mm in a choice of heights: H460mm, H530mm, H590mm & H640mm
- Delivered flat packed for easy assembly
- Choice of 10 top colours and 4 PU edge colours



A. Flower shaped tables

- Please specify height, top & edge colours

Y19200D £175.90

Primary Height Adjustable Tables

- Oval shaped adjustable legs - one size fits all
- Height adjustable for all primary sizes - from 400-640mm
- Easy allen key adjustment
- Premium 25mm top available in a wide range of colours
- Durable spray PU edge
- All table colours available with speckled light grey frame
- Some colours available with matching outer leg paint colour - see table colour chips below



C. Rectangular

- 1200 x 600mm

YHAR126 POA



D. Semi circular

- 1200mm diameter

YHASC12 POA



E. Trapezoidal

- 1200 x 600mm

YHAT126 POA



F. Circle shape

- 1200mm diameter

YHARD12 POA

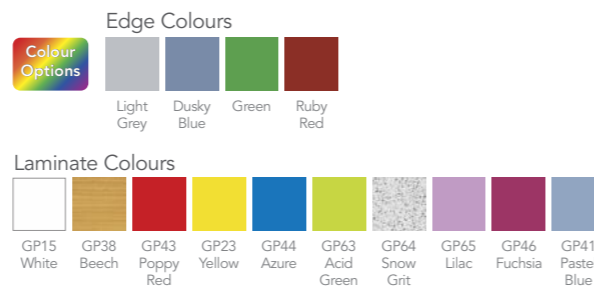

Colour Options Top Colours Laminate

Available in matching outer frame paint colour

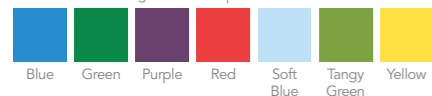

Available with speckled grey frame only

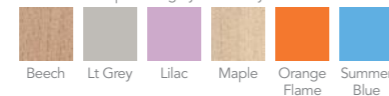

PU Edge colours:

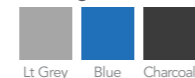

For critical colour matching please ask for a sample

Soft Seating

A. Children's tub chairs & sofas

- Eyecatching tub chairs and 2-seater sofas upholstered in wipe clean vinyl
- Available in 2 seat heights : Nursery H280mm and Junior H340mm
- Seat cushions can be easily removed and used as floor cushions
- Colours: Lime (LI), Pink (PK), Navy (NY), Yellow (YW), Red (RD), Tangerine (OR), Aqua (AA)
- Dimensions: Chair - W560 x D530mm
Sofa - W960 x D580mm

YTUB280	Chair H280mm	£109.60
YTUB340	Chair H340mm	£109.60
YTUB2280	Sofa H280mm	£159.80
YTUB2340	Sofa H340mm	£159.80

* Please specify colour



B. KomfiTub children's tub seats

- Smart child size tub chairs & sofas with chrome look feet.
- Seat height of 350mm to suit nursery & primary age children
- Priced upholstered in a wipe clean vinyl fabric, but can also be upholstered in fabric in a choice of colours
- Dimensions height 650mm, chair is W600mm, 2-seater W1000mm

Y310240	Tub Chair	£216.50
Y310242	Tub 2 Seater	£398.60

Page Link - see page

For Just Colour Vinyls **279**

C. Loose cover chairs

- Washable removable covers for easy maintenance
- Covers made from cotton drill fabric and can be washed at low temperature
- Manufactured with fire retardant liners
- Sized to suit young children so ideal for nurseries and early years. H600mm x D500mm, seat height 240mm
- Choice of 5 colours: Red-RD, Dk Blue-DB, Lime-LI, Royal Blue-RB or Light Blue-LB

Y310202*	Chair, W610mm	£149.80
Y310204*	Sofa, W980mm	£226.80

* Please specify colour



New Product

Wide choice of Just Vinyl or fabric options



Covers remove for washing

Bean Cushions & Seats

- Good value range of quilted cover, bean-filled seating suitable for younger years
- Wipe clean fabric so can be used both indoors or outdoors.
- All items meet the relevant flame retardancy standards.
- Component parts tested to BS 5852 Ignition source 5.



Best Seller



A. Quilted flop seat

- Comfortable seat for young children
- Soft quilted cover in a range of bright colours: Aqua(AA), Lime(LI), Orange(OR), Yellow(YW), Purple(PP) or Red(RD)
- Size: H520 x W500 x D660mm

YFLOP* £76.40

*Please specify colour

B. Small round quilted pouffees

- Ideal for foundation stage children
- Size H340 x W300 x D300mm
- Pack of 6 assorted colours

Y330200 pk 6 £139.60

C. Small square quilted pouffees

- Ideal for foundation stage children
- Size H340 x W300 x D300mm
- Pack of 6 assorted colours

Y330202 pk 6 £229.80



D. Large quilted bean cubes

- Suitable for children in Key Stage 1 or 2
- Size 450 x 450 x 450mm
- Assorted Colours

Y330204 pk 6 £278.50

E. Toddler beanbags

- Mini, toddler sized bean bags
- Size: H300 x W400 x D400mm
- Pack of 5 assorted colours

Y330206 Assorted pk 5 £198.70

F. Quilted outdoor cushions

- Small square cushions for individual child seats with carrying handle
- Pack 10 (2 each Red, Aqua, Lime, Orange & Yellow)
- Size: h180 x W400 x D400mm

Y330208 Assorted pk 10 £145.20

Smile Soft Seating

- Tough enough to take rough and tumble treatment, yet light enough for children to move around
- Mix colour schemes and other items from our range to create your own personal seating environment
- Choice of 3 seat heights to suit nursery & primary years - choose from 310mm, 350mm or 380mm
- Can be upholstered in any choice of vinyl colour (see page 279) or in a choice of fabrics
- Smaller orders may incur a carriage charge
- Please specify fabric colour & seat height



Now in 3 seat heights



Best Seller

A. Smile circular chair

- Overall height 510mm
- W400 x seat D350 O/D 400mm

YKCF001 £156.40



B. Smile circular pouffe

- W400 x seat D400

YKCF003 £108.20



C. Smile segment pouffe

- W310 x D400

YKCF004 £108.20

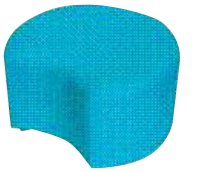

D. Smile outer curved pouffe

- W350 x D400

YKCF007 £108.20

Smile Shapes

- An extension to the range
- Choice of 3 seat heights - 310, 350 or 380mm & 3 shapes
- Configure into many different layouts
- Please specify fabric colour & seat height



E. Wedge stool

- W400/530 x D400mm

YKCF008 £149.50



F. Quadrant stool

- 4 together form a circle (as shown)
- W300/850 x D400mm

YKCF009 £179.60

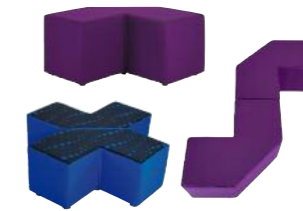

G. Tangent stool

- 2 together form a cross shape
- W560/1000 x D400mm

YKCF010 £199.50



H. Block stools

YKCS001 W400 x D400mm £148.00

YKCS002 W790 x D400mm £189.00



See page 279 for
Just Colour Vinyl



Rumble Tumble Seating

- An armchair and sofa just the right size for children
- Robust enough to withstand group environments
- These chairs look particularly striking when the arms and seats are finished in different colours
- Smaller orders may incur a carriage charge
- Available in either Just colour vinyl or any fabric from the Advantage range

A. Tumble 2 seater sofa

- Overall W920 x D500 x H545mm
Seat W780 x D380 x H315mm

YKCT002	2 Seater Fabric	each	£364.00
YKCT002V	2 Seater Vinyl	each	£378.00

B. Rumble armchair

- Overall W520 x D500 x H545mm
Seat W380 x D380 x H315mm

YKCT001	Armchair Fabric	each	£298.40
YKCT001V	Armchair Vinyl	each	£308.00

C. Easy junior seating

- New range of modular child size soft seating
- Can be ordered as single units, or why not combine to make a cosy reading corner?
- Available in Just colour vinyl or any fabric from the Advantage range
- Dimensions: D480mm, seat height 310mm

Y310206	Single Chair W405mm	each	£99.60
Y310208	2 Seater W810mm	each	£169.80
Y310210	3 Seater W1215mm	each	£212.50
Y310212	Corner Unit W770mm	each	£268.00
Y310214	Armchair	each	£178.50
Y310216	LH Arm Chair	each	£138.00
Y310218	RH Arm Chair	each	£138.00
Y310220	Square Coffee Table W395mm	each	£95.40

D. Modular Seating Set

- Set of shaped nursery height seats with solid wooden frames, upholstered in brightly coloured wipe-clean vinyl
- Round & oval seats are larger than the crescent shapes and designed for use as a central table
- Dimensions:-
crescents: H230x W420 x D350mm,
circle: H260mm x W450mm,
oval: H230 x W420 x D300mm

Y330220	Circular Seating	set 5	£258.00
Y330222	Oval Seating	set 6	£299.40

- Other vinyl colours available - please ask for details

Outdoor Learning

Solid wood outdoor play furniture to create a living classroom.

- Helps children to explore & develop their potential through role play learning
- Encourages healthy outdoor play
- Made from durable, weather-resistant solid eucalyptus timber: a sustainable product from FSC certified sources
- Naturally occurring oils contain insect repelling properties
- Furniture can be left outside



New
Product



A. Outdoor kitchen with water pump

- Excellent for exploratory & water play
- Features a stainless steel kitchen sink allowing children to play with water coming from the water pump that looks like a real water tap
- H1110 x W1200 x D420mm

Y300162		£372.40
---------	--	---------

B. Outdoor kitchen set

- Consists of 1 each outdoor sink, oven & stove, washing machine, refrigerator & microwave
- Dimensions 45 x 35cm x height 62 – 85cm
- Some items can be purchased separately

Y300150		£598.00
---------	--	---------

C. Mud mixing table

- Outdoor table c/w 4 x metal inset dishes for mixing
- Great for outdoor teaching or nature studies
- Dimensions 1100 x 1100 x H600mm

Y300152		£269.40
---------	--	---------

New
Product

C



D



D. Sorting table

- Outdoor wooden bench c/w lid and undershelf
- Ideal for nature studies, or curriculum activities
- Dimensions H600 x W1200 x D400mm
- Wooden sorting boxes available separately to fit into top of bench.

Y300154	Sorting Table		£208.00
Y300156	Wooden Sorting Boxes	pk 6	£98.40



E. Outdoor table with stacking benches

- Low table with 2 benches for outdoor use
- Table dimensions W570 x 1060mm
- Requires some assembly
- Parasol sold separately

Y300160	Bench Height 310mm	pk 2	£88.50
Y300164	Table Height 480mm	each	£239.00
Y300165	Parasol	each	£124.60



New
Product

F. Water & sand table with pump

- Encourages exploratory water play
- Teaches children about water and its effects
- Includes stainless steel sink with pump that looks like a real water tap
- Tables can be repositioned in different layouts
- H56-85cm x L104 x W34cm

Y300170	Set of 3 Tables		£1080.00
---------	-----------------	--	----------



Are your cloakroom and changing room areas kept tidy?
Everything to keep all your coats, bags and valuable items safe and secure around the building.

Cloakrooms & Lockers

Candy Colours Range	130
Coat Hooks & Rails	131
Lockers	132-135
DuraStore Interior Lockers	136
DuraStore Exterior Lockers	137
MyLockers	138-139
Bespoke Cloakrooms	140-141

Cloakrooms & Lockers

Keep your cloakrooms tidy with items from our high quality range of cloakroom furniture and lockers.

Secure storage options for changing rooms, staff rooms, receptions and other open areas where valuables are kept.

Many configurations of lockers and benching, including bespoke manufacturing, providing a solution for every requirement.



Candy Colours Cloakroom Range



- Mix & match the tops & bottoms of the cloakroom units
- Cloakroom tops come complete with two height-adjustable upright bars
- All units supplied complete with Gratnell's trays within the price. See page 50 for colour and size options
- Please specify colour at time of ordering
- Japanese Ash finish



Cloakroom Tops with Upright Bars



A. 8 compartments
 • Height adjustable
 • W1360 x D170 x H410mm
 YCLK001 £267.00



B. Hanging rail
 • Height adjustable
 • W1360 x D250 x H138mm
 YCLK003 £176.00



C. 4 compartments
 • Height adjustable
 • W1360 x D170 x H250mm
 YCLK005 £217.00



D. 8 hooks
 • Height adjustable
 • W1360 x D40 x H200mm
 YCLK007 £176.00

Cloakroom Bottoms



E. 4 deep trays
 • W1360 x D345 x H455mm
 YCLK002 £206.00



F. 8 shallow trays
 • W1360 x D345 x H455mm
 YCLK004 £207.00



G. 4 open compartments
 • W1360 x D345 x H455mm
 YCLK006 £188.00



H. Boot rack
 • W1360 x D345 x H455mm
 YCLK008 £282.00



Easy Self Assembly

I. Mobile cloakroom trolleys

- Manufactured from solid Beech with lockable castors
- Supplied flat pack for easy self-assembly
- Dimensions: H1095 x W1230 x D600mm
- Natural beech finish

Y1391432 Natural Beech £299.00

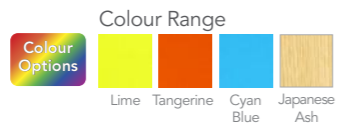

Page Link - see pages

For Candy Colours Units 74-75



Coat Hooks & Rails



A. Coat hook rails

- Straight coat hook rails with indented space above hooks for personalisation
- Rail size W1200mm x H195mm
- Comes with 10 assorted coloured hooks
- Natural beech finish

Y91412 Beech Coat Hook Rail £79.00

B. Cloakroom hooks & rails

- Colourfull metal coat hooks pre-mounted onto 180mm depth MFC boards
- Choice of 3 finishes: Beech-BE, Maple-MP or White-WH
- Hooks supplied as assorted colours, or specify single colour

320300	8 Hook Rail W1200mm	£67.00
320302	16 Hook Rail W1500mm	£78.00
320304	20 Hook Rail W1800mm	£97.00

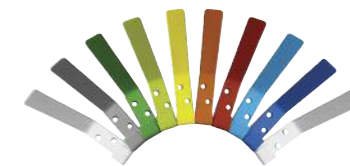

C. Metal hooks only

- Choose from assorted pack or single colours
- Please specify colour for single colour packs
- Packs of 10

320320	Assorted Coat Hooks	£29.00
320322	Single Colour Hooks	£29.00



D. 8/16 compartment cloakroom bench

- Cloakroom storage unit with 8 open compartments
- 3 finishes: Beech-BE, Maple-MP or White-WH
- Choice of 9 frame colours as below
- D350 x H515 x W1200mm (8 compartment)
- D350 x H515 x W1500mm (16 compartment)

320350	8 Compartment	£142.80
320352	16 Compartment	£179.40

Colour Range

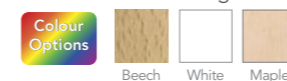

Hook & Frame Colours

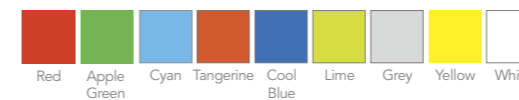

Page Link - see pages

For bag storage 79



E. Brighthooks

- Strong and colourful plastic hooks
- Packs of 10 single colour
- Please specify colour

320330 Brighthooks pk 10 £20.00

Brighthooks Colours

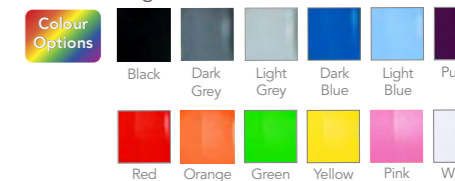



Lockers

ACTIVECOAT
anti-bacterial technology

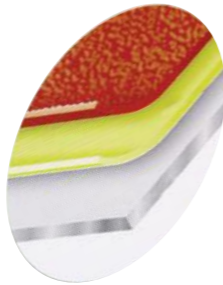

- The hard wearing anti-bacterial powder coating for the most stringent hygienic environment
- Iron Phosphate Key Coat This anti-rust, key coat bonds to the steel in readiness for the final active coating
- Prepared Steel Surface Chemical cleaning ensures an ideal surface for further coatings

A. Single compartment

- Including top shelf and double coat hook

Y16100*	H1780 x W305 x D305mm	POA
Y16106*	H1780 x W305 x D380mm	POA
Y16112*	H1780 x W305 x D460mm	POA
Y16118*	H1780 x W380 x D380mm	POA
Y16124*	H1780 x W460 x D460mm	POA

B. Two compartment

- Including double coat hook per compartment

Y16128*	H1780 x W305 x D305mm	POA
Y16134*	H1780 x W305 x D380mm	POA
Y16140*	H1780 x W305 x D460mm	POA
Y16146*	H1780 x W380 x D380mm	POA
Y16152*	H1780 x W460 x D460mm	POA

C. Three compartment

Y16156*	H1780 x W305 x D305mm	POA
Y16162*	H1780 x W305 x D380mm	POA
Y16168*	H1780 x W305 x D460mm	POA
Y16174*	H1780 x W460 x D460mm	POA

D. Four compartment

Y16178*	H1780 x W305 x D305mm	POA
Y16184*	H1780 x W305 x D380mm	POA
Y16190*	H1780 x W305 x D460mm	POA
Y16196*	H1780 x W380 x D380mm	POA
Y16202*	H1780 x W460 x D460mm	POA

E. Five compartment

Y16206*	H1780 x W305 x D305mm	POA
Y16212*	H1780 x W305 x D380mm	POA
Y16218*	H1780 x W305 x D460mm	POA

F. Six compartment

Y16224*	H1780 x W305 x D305mm	POA
Y16230*	H1780 x W305 x D380mm	POA
Y16236*	H1780 x W305 x D460mm	POA
Y16242*	H1780 x W380 x D380mm	POA

* Please specify colour

Lock options: Cam lock or Hasp & Staple supplied as standard

A. Cam lock with key



B. Hasp and Staple (accepts padlock)



Call us now for our best prices!

Colour Options

Door colours: Red, Blue, Yellow, Green, Silver, Smoke White

When ordering your lockers please specify: 1. nesting 2. carcass colour 3. door colour

Autumn door colours (305mm width only): Orange, Ocean, Jade, Lemon, Lilac

Carcass colours: Black, White, Silver Grey



Lockers

- All lockers come as standard with Activecoat anti-bacterial powder coating
- All plastic components used in the manufacturing incorporate a silver based anti-bacterial agent
- Activecoat developed in conjunction with Dupont

All lockers meet:



MEETS BS 4680:1996
excluding size specification

Lock options:



Combination Lock 4 Digit



Digital Combination Lock



Coin Return Lock

- Ergonomic Card Holder incorporating a lock cover which protects the lockers from key scratches



- Vent system allows each compartment to 'breathe'



- Between each compartment the locker has a welded plinth. This makes each compartment totally separate and increases structural rigidity



- High visibility key, making identification easy. Hasp and staple locks for padlocks are also available



- Even the standard lock has a micro sprung 10 lock featuring a massive 3000 key combinations



- Every locker has a full strengthener welded into each door to increase security



A. Low lockers single tier

- Including top shelf and double coat hook

Y16400L	H1220 x W305 x D305mm	POA
Y16406L	H1220 x W305 x D460mm	POA

B. Low lockers double tier

- Including top shelf and double coat hook

Y16412L	H1220 x W305 x D305mm	POA
Y16418	H1220 x W305 x D460mm	POA



B



A

C. Cube lockers

Y16248	H305 x W305 x D305mm	POA
Y16250	H380 x W380 x D380mm	POA
Y16252L	H460 x W460 x D460mm	POA

Nesting available - please ask for details



C



D

D. Janitors lockers

- Including double coat hook

Y16424L	H1780 x W460 x D460mm	POA
---------	-----------------------	-----

POA Price On Application



inset doors
optional Sloping top AVAILABLE



Numbering System
Available at additional cost.
Number plates will be recessed into door if ordered with lockers.



Lock Options

High Security
Welded Compartment divider incorporates internal door stop and sill

New 180° Opening
This strong hinge offers 180° wide opening.

Hinge Securing Plate
This strong hinge incorporates an integral securing plate which clamps the door to the hinge giving added security.

Activecoat
Anti-bacterial technology

Available in 1, 2, 3 and 4 tier
Single and two tier doors subject to minimum quantity.



overlay doors



New 180° Opening Hinge
This hinge offers unparalleled levels of access to each compartment making full use of clear entry.

Trespa Athlon Fire Classification
Type: Standard (Non-FR): Euroclass D-s2, d0EN 13501-1
Type: FR (Fire Resistant): Euroclass B-s2, d0EN 13501-1 (available at additional cost)



Stock Door Colours

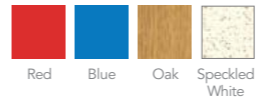

Single and two tier doors subject to minimum quantity.

Body Colour



Non stock colours subject to minimum quantity of 25 doors.



Woodgrain effect and patterned finishes

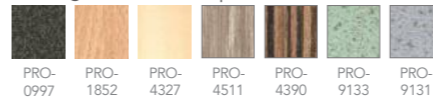

Laminate doors

10mm solid grade laminate inset doors.



DuraStore - interior plastic lockers

10 Year
Warranty

Call us now for
our best prices!

Locks



EDP015

EDP016 waterproof
haspEDP017 Cam
waterproof

EDP018

Interior Lockers



For use inside buildings, including near humid areas, near showers and swimming pools.

- Strong and dent resistant
- Cannot rust
- UV resistant
- Plastic contains additive to resist bacteria, moulds and yeasts
- Recyclable
- Locker floors slope to the door and drain channels
- Quick installation - one piece unit saves assembly time
- 10 year warranty under normal use
- Frame - speckled light grey

EDPI001	4 Doors H1800 x W325 x D450mm
EDPI002	3 Doors H1800 x W325 x D450mm
EDPI003	2 Doors H1800 x W325 x D450mm
EDPI005	1 Doors H450 x W325 x D450mm
EDPI006	2 Doors H900 x W325 x D450mm

Lock Options: Lockers supplied with water resistant cam lock or hasp lock. Other options listed below.

EDP015	Water Resistant Cam Lock Type 1
EDP016	Water Resistant Hasp & Staple Lock
EDP017	Full Waterproof Cam Lock Type 2
EDP018	Re-programming 4 Digit Number Finding Key
EDP019	Water Resistant Budget Combination Lock 4 Digit Override Key
EDP020	Waterproof Coin Return Lock ASSA
EDP021	Waterproof Coin Retain Lock ASSA
EDP022	Waterproof Digital Combination Lock
EDP023	Simple RFID Lock

- Doors available in Red, Yellow, Blue, Graphite Grey - please specify door colours and door colour order



DuraStore - exterior plastic lockers

10 Year
Warranty

Exterior Lockers



For exterior use. Fitted with neoprene interior door seals and IP waterproof cam locks or hasp.

- Site lockers outside - never run out of space again
- Strong and dent resistant
- Cannot rust
- UV resistant
- Plastic contains additive to resist bacteria, moulds & yeasts
- Recyclable
- Locker floors slope to the door and drain channels
- Quick installation - one piece unit saves assembly time
- 10 year warranty under normal use
- Frame - speckled light grey

EDPX007	4 Doors H1800 x W325 x D450mm
EDPX008	3 Doors H1800 x W325 x D450mm
EDPX009	2 Doors H1800 x W325 x D450mm
EDPX010	1 Doors H450 x W325 x D450mm
EDPX011	2 Doors H900 x W325 x D450mm

Lock Options: lockers are fitted with neoprene internal door seals and IP waterproof locks or hasp but other waterproof locks are available as follows:

EDP017	Full Waterproof Cam Lock Type 2
EDP020	Waterproof Coin Return Lock ASSA
EDP021	Waterproof Coin Retain Lock ASSA
EDP022	Waterproof Digital Combination Lock

- Doors available in Red, Yellow, Blue, Graphite Grey - please specify door colours and door colour order



DuraStore options

These options are available for both interior and exterior lockers

EDP011	Sloping Top W325 x D450mm
EDP012	Engraved Number Disc
EDP013	Nesting Nuts & Bolts with Rubber Washers
EDP014	Adjustable Feet - Set of 4
EDP024	Locker Stand - Nest 2
EDP025	Locker Stand - Nest 3
EDP026	Locker Stand - Nest 4



Anti-Bacterial Powder Coating 
An effective secondary support to existing cleaning practices

Options

- Sloping top option
- Lockerstands to raise off floor
- Numbered plate and key fob
- Masterkey
- Combination lock
- Electronic lock
- £1 coin Coin return lock



Sloping top option



Lockerstands

Lockers are supplied complete with key lock. Padlock fittings can be supplied (does not include actual padlock) at no extra charge - must be specified at time of order.

550mm deep lockers available - ask for details
Special requirements eg. - Non-standard sizes, internal fittings - ask for details

Door colour options All lockers supplied with grey carcass

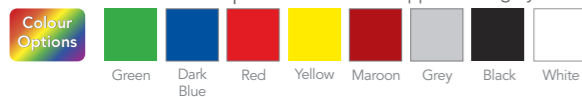

Mylockers

Single door locker

Code	Size (h x w x dmm)	Opening (h x w x dmm)	Single	Nest 2	Nest 3
YMY8331	1800 x 300 x 300	1410 x 235 x 275	✓	✓	✓
YMY8341	1800 x 300 x 450	1410 x 235 x 425	✓	✓	✓
YMY8441	1800 x 450 x 450	1410 x 385 x 425	✓		

Supplied with shelf and double coat hook

2 door locker

Code	Size (h x w x dmm)	Opening (h x w x dmm)	Single	Nest 2	Nest 3
YMY8332	1800 x 300 x 300	835 x 235 x 275	✓	✓	✓
YMY8342	1800 x 300 x 450	835 x 235 x 425	✓	✓	✓
YMY8442	1800 x 450 x 450	835 x 385 x 425	✓		

Supplied with double coat hook in each compartment

3 door locker

Code	Size (h x w x dmm)	Opening (h x w x dmm)	Single	Nest 2	Nest 3
YMY8333	1800 x 300 x 300	540 x 235 x 275	✓	✓	✓
YMY8343	1800 x 300 x 450	540 x 235 x 425	✓	✓	✓

Supplied with no internal fittings

4 door locker

Code	Size (h x w x dmm)	Opening (h x w x dmm)	Single	Nest 2	Nest 3
YMY8334	1800 x 300 x 300	400 x 235 x 275	✓	✓	✓
YMY8344	1800 x 300 x 450	400 x 235 x 425	✓	✓	✓
YMY8444	1800 x 450 x 450	400 x 385 x 425	✓		

Supplied with no internal fittings

5 door locker

Code	Size (h x w x dmm)	Opening (h x w x dmm)	Single	Nest 2	Nest 3
YMY8335	1800 x 300 x 300	310 x 235 x 275	✓	✓	✓
YMY8345	1800 x 300 x 450	310 x 235 x 425	✓	✓	✓

Supplied with no internal fittings

6 door locker

Code	Size (h x w x dmm)	Opening (h x w x dmm)	Single	Nest 2	Nest 3
YMY8336	1800 x 300 x 300	260 x 235 x 275	✓	✓	✓
YMY8346	1800 x 300 x 450	260 x 235 x 425	✓	✓	✓

Supplied with no internal fittings

8 door locker

Code	Size (h x w x dmm)	Opening (h x w x dmm)	Single	Nest 2	Nest 3
YMY8338	1800 x 300 x 300	185 x 235 x 275	✓	-	-
YMY8348	1800 x 300 x 450	185 x 235 x 425	✓	-	-

Supplied with no internal fittings

Mylockers

Single door low height lockers

Code	Size (h x w x dmm)	Opening (h x w x dmm)	Single	Nest 2	Nest 3
YMY13331	1370 x 300 x 300	1250 x 235 x 275	✓	✓	✓
YMY13341	1370 x 300 x 450	1250 x 235 x 425	✓	✓	✓

Supplied with a shelf and double coat hook

2 door low height lockers

Code	Size (h x w x dmm)	Opening (h x w x dmm)	Single	Nest 2	Nest 3
YMY13332	1370 x 300 x 300	610 x 235 x 275	✓	✓	✓
YMY13342	1370 x 300 x 450	610 x 235 x 425	✓	✓	✓

Supplied with double coat hook in each compartment

3 door low height lockers

Code	Size (h x w x dmm)	Opening (h x w x dmm)	Single	Nest 2	Nest 3
YMY13333	1370 x 300 x 300	400 x 235 x 275	✓	✓	✓
YMY13343	1370 x 300 x 450	400 x 235 x 425	✓	✓	✓

Supplied with no internal fittings

Bridge Lockers

Bridge units

Code	Size (h x w x dmm)	Number of Compartments
YMY811AR	1800 x 1500 x 450	11
YMY818AR	1800 x 2100 x 450	19

Call us now for our best prices!

Door colour options All lockers supplied with grey carcass



Special Low Height





Many configurations of frames and bespoke manufacturing are available to provide a solution for every requirement.

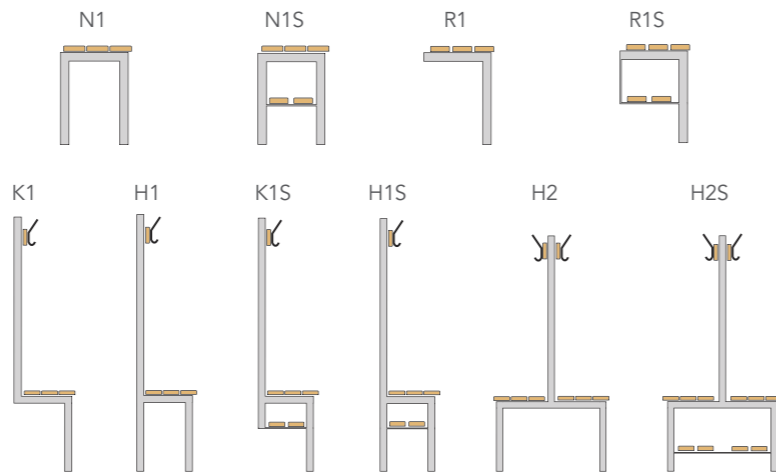

Cloakrooms & Changing Rooms

Page Link - see pages
For coat hooks
131



- Heavy duty steel frames
- Free standing or fixed to wall/floor
- Supplied assembled or fitted on site
- Optional shoe rack

- Optional bag rack
- Optional peg rail
- Unique fold down frame for narrow corridors
- Heavy duty ash slats or solid grade laminate



Is your IT suite smart?

With space optimization and intelligent design, we can help you achieve more in less space!

IT Suites

Table Leg Options	144-145
IT Poly Seating	146-147, 150
IT Upholstered Seating	148-149
Stools	149
Flip Pod Desks	151
Computer Trolleys	152
Charge Lockers	153
Laptop Storage	154-155

IT Suites

When it comes to creating your ideal IT suite we can design a unique solution for your requirements.

Whatever surface, size or colour, we have a range of standard units and bespoke solutions that will meet the most demanding needs and technical requirements for the most effective IT teaching space.

From built in lap top charging units down to individual chairs, we can tailor your IT suite to your own needs and we don't stop with the delivery, we can fit them, wire them and commission on site.



Due to limitations in the printing process, wood and colour finishes shown throughout the catalogue may not be representative of actual colour. Samples are available on request.

Flat Panel & Goal Post Legs



Panel Leg

Heavy duty Panel Leg for a solid timeless look that can be scribed to fit many room requirements. Options include a full range of popular frame finishes/colours with strong matching edging for a quality finish, and additional cable management. Available in any dimension to suit your space – please enquire!



Goal Post Style Leg

Very strong and stable leg option – an adjustable style for accurate lengths in any room, provides extra cable management options Available in a full range of popular frame finishes/colours, and any height or depth dimension to suit your space. Please enquire!



Adjustable Front Leg & Cantilever leg



Aluminium Adjustable Track Leg Benching

The ultimate benching system, with highly flexible features to suit most rooms. Incorporating clever rail systems that allow for accurate adjustment and easy reconfiguration options. Options include cable management and a range of popular frame finishes/colours. Available in range of depths and heights to suit your space. Please enquire!



Cantilever Leg

The Cantilever Leg is a strong and smart option. The desk-style leg provides good knee space and allows for modesty panel option. Other options include additional cable management as well as a full range of frame finishes/colours to match. Many height and depth options to offer – please enquire.



5 Year Warranty

A

Colour Options



A. Flow IT chair

- Virtually indestructible shell
- Tamperproof - all metal height adjustment lever
- Suitable for junior or adult use
- In stock for rapid delivery
- Seat height 390 - 520mm
- Available with glides or castors
- Small order charge applies

YENIT50	each	£69.30
---------	------	--------

B

Colour Options



Page Link - see page
For Full Contour Range 31



B. Contour swivel chair

Stylish, ergonomic swivel chair in 2 sizes:

- Small order charge applies

Junior

- 390-480mm seat height
- Overall width 520mm, overall depth 520mm

Senior

- 390-520mm seat height
- Overall width 600mm, overall depth 600mm

Y16723J	Junior Chair Black Base	£57.80
Y16723A	Senior Chair Black Base	£57.80
Y16723C	Senior Chair Chrome Base	£65.90

5 Year Warranty

C

Colour Options



C. Vogue IT chair

- Ergonomic and dynamic Swivel Chair that supports the user in all directions
- One Piece 100% Recyclable shell
- 5 Year guarantee
- Ergonomic and strength compliant to education standard
- 12 Vibrant Shell colours
- Available with castors or glides (please specify)

YVG3601		£58.70
---------	--	--------

A. Positive posture IT chair

- Stylish chair with chrome base, complements the positive posture 1 piece polypropylene chairs
- Junior colours: Green, Yellow, Red, Blue, Purple, Lime, Sky, Orange
- Additional adult colours: Grey, Charcoal, Black, Burgundy
- Fabric seat pads also available - POA
- Available with glides or castors (please specify)
- Small order charge applies



Page Link - see page
For more Positive Posture 37

A

YPP101J	Junior Height	seat height 405 - 460mm	£56.80
YPP102A	Adult Height	465 - 555mm	£59.50



B. Mono posture IT chair

- Perfect ergonomics with unique waterfall seat edge and lower back lumbar design
- Flame retardant to CRIB 5, compliant to BS5852 2006
- Available in 15 colours
- Size: H395-485 x W415 x D450 x overall H760-850mm
- Available with castors or glides (please specify)
- Small order charge applies



Y32011	Mono Posture IT Chair	£59.70
--------	-----------------------	--------

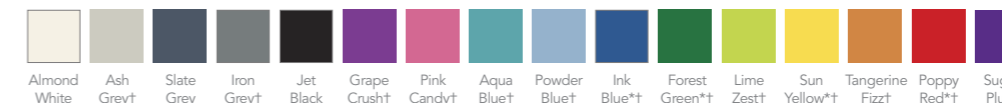

C. Poly IT swivel chair

- Popular Swivel chair with extremely strong one piece shell
- Well defined lumbar support
- Black 5 star base available with glides or castors
- Wide range of shell colours

Y15390J	Junior Swivel	£56.20
Y15390S	Senior Swivel	£58.70

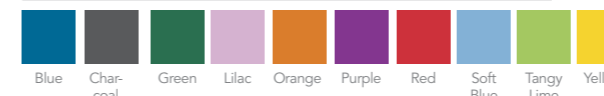

C

D. Pennine swivel chair

- Innovative design for perfect postural support
- Seat back with pelvic support relieves Pressure
- Black 5 star base with Gas lift
- Seat height range of 420-555mm
- Available with castors or glides (please specify)



5 Year Warranty

D

Y100166		£54.50
---------	--	--------

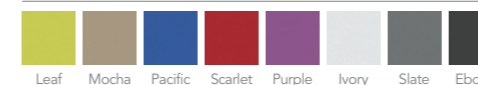

New Product

A



Glides Castors

A. IT mid back operator chair

- Medium Back Operator Chair
- Built in the UK for the educational market
- Non Marking wheels to protect floors
- Black 5 Star Base as Standard
- 5 Year Guarantee
- Dimensions: W500 x D550 x H860mm
- Seat Height Range: 475 - 605mm
- Available with Castors or Glides
- Available in 3 standard Fabric Colours: Charcoal, Royal Blue and Burgundy – for Other Fabrics POA

Y20106IT £69.00

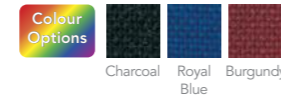

Charcoal Royal Blue Burgundy

Best Seller

5 Year Warranty

B

Colour Options

Choose
1. Colour see pages 270-271
2. Castors or glides



Phone For Bulk Prices

B. Student IT tamperproof

- This strong and comfortable chair is proven in education, and is one of the most popular IT chairs on the market
- The seat and back are joined with two robust metal struts either side, with a very strong underseat frame and just one tough height adjustment ring
- The chair is designed and built for this purpose and offers great value for money



Glides Castors

		Height Range	
Y15066	With Castors	400-600mm	£59.70
Y15068	With Glides	400-600mm	£59.70
YTWOT	Addn. Charge for 2-Tone Fabrics from Band 1		£10.50

Fabric ranges shown on page 276-279 or ask for a swatch

New Product

C



Glides Castors

C. IT tamperproof operator chair

- Medium Sized Back Operator Chair with Tamperproof Fixings
- Built in the UK for the educational market
- Available with Castors or Glides – Please State
- Black 5 Star Base
- 5 Year Guarantee
- Dimensions: W500 x D460 x H890mm
- Seat Height Range: 465 – 595mm
- Available in 3 Standard Fabric Colours – Charcoal, Royal Blue and Burgundy
- For other fabrics POA

Y32013TP £88.00

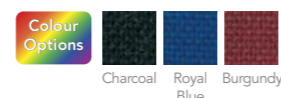

Charcoal Royal Blue Burgundy

New Product

A



Glides Castors

C. Junior small IT swivel chair

- Heavy Duty Junior Size Operator
- Built in the UK for the educational market
- Flame Retardent foam
- Black 5 Star Base as standard
- Available with castors or Glides
- Dimensions: W450 x D560 x H810mm
- Seat Height Range : 470-570mm
- Available in a wide range of fabrics

Y32013 £77.70

B. IT stool

- Available with black/chrome components
- Castors available: Standard Castors (As shown on Image), Rubber Castors, Brake Loaded Castors, Manual Locking Castors, or glides
- A choice of 90 Advantage and Phoenix colours



Colour Options

Choose
1. Colour see pages 270-271
2. Castors or glides



Glides Castors

Gas Lift

YITSB	Standard Stool Black Base	£53.00
YITSC	Chrome Frame	£59.60

Phoenix, Era and Rivet fabric ranges shown on pages 276-277 or ask for a swatch.



C. Mono posture low task stool

- Ideal for Teaching Assistants Use in Classrooms
- Perfect ergonomics with a unique waterfall seat edge
- 16 colour options
- Available with castors or glides (please specify)



Glides Castors

Y32022 £48.90



Almond White Ash Grey Slate Grey Iron Grey Jet Black Grape Crush Pink Candy Aqua Blue Powder Blue Ink Blue Forest Green Lime Zest Sun Yellow Tangerine Fizz Poppy Red Sugar Plum



C

15 Year
Warranty

A



A. Ruckus chair

- A mobile stacking chair that transforms learning space by its inspiring and innovative design
- Designed to encourage a unique sitting experience that inspires interaction with others
- Ideal for breakout and interactive learning spaces
- Large Seat Surface with a unique backrest/armrest that can be used as a worksurface or a perfectly balanced perch
- Lower wire bookrack as shown, for added functionality!
- Available in a range of colours to match the seat
- 24 seat colours and 31 frame finishes – the choice is yours!
- 15 year warranty
- Seat Height: 455mm

RSTK007

POA

Colour
Options5 Year
Warranty

B



B. Mobile+ chair

- A unique, adjustable multi-functional chair designed to offer maximum comfort & ergonomic support to the user
- Integrated rotating Writing tablet, Dashboard and storage facilities for a cooperative and agile learning experience
- Moulded one piece Flexible Seat Shell with a V-shaped Back offering superb lumbar support
- Integrated tilt mechanism and gas lift
- Black 5 star base with castors
- Available in 10 Shell colours
- 5 year warranty

YAC2W

POA

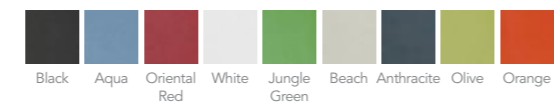
Colour
Options

SMART IT Flip Pod Desks

Workstations that quickly and securely conceal monitors and laptops beneath the desk surface.

An innovative and flexible IT solution for any classroom or training suite.

- These Flip Pod desks come with integrated modesty panels and a double cantilever metal frame for strength and stability
- 25mm MDF Top with a 18mm MFC Flip Pod lid
- Fully locking secure mechanism with a 2 year guarantee
- Recommended monitor size is between 16-19 inches
- Frame available in a white or silver finish
- Please note if no frame colour is specified then silver will be supplied as standard
- 3 Wood finishes available : Beech, Maple or White

A. Single SMART IT flip pod desk

- Available in LH or RH Configurations
- Dimensions: W900 x D600 x H725mm

YSMIT900R	Right Hand Configuration	£479.00
YSMIT900L	Left Hand Configuration	£479.00
YSMIT1200C	Single, Central Position W1200 x D600 x H725mm	£498.00

B. Double SMART IT flip pod desk

- Available in RH or LH Configurations
- Dimensions: (2 Width Options below)x D600 x H725mm

Width 1650mm

YSMIT1650R	RH Configuration	£869.00
YSMIT1650L	LH Configuration	£869.00

Width 1800mm

YSMIT1800R	RH Configuration	£898.00
YSMIT1800L	LH Configuration	£898.00

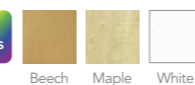
Colour
Options

Please specify wood finish. Colours shown may not be representative of actual colours - please ask for a sample

New
Product

A



B



A



Computer Trolleys

A. Teacher workstation

- Mobile workstation
- Fitted with castors
- Fixed printer and bottom shelf
- Available with beech top
- Frame available in red, blue, grey
- Delivered flat packed

YCF7038 W675 x D660 x H725mm £115.30

B



B. Mobile workstation

- Mobile height adjustable workstation
- Ideal for two computers side by side
- Height adjustable for commercial / educational use
- Height adjustable 540 x 790mm
- Heavy duty rubber wheels, front two braked
- Four way power unit and lower shelf
- Available with beech top
- Frame available in red, blue or grey
- Delivered flat packed

YCF7066 W1150 x D560mm £241.70

C



C. Fixed height trolley

- Two tier trolley
- Height available from 500 - 750mm, in 50mm increments from floor to main work surface - please specify height required
- Available with beech top
- Frame available in red, blue and grey

YEF8046 W1000 x D650mm each £271.80

D



D. Fixed height trolley

- Single tier trolley
- Height available from 500 - 750mm increments from floor to main work surface - please specify height required
- Available with beech top
- Frame available in red, blue and grey

YEF8049 W1000 x D650mm each £261.40

Charge Lockers

Charging and security solutions for laptops, netbooks, tablets, Apple devices and other IT equipment.

- All charging units are CE marked (Marking on a product is a manufacturer's declaration that the product complies with the essential requirements of the relevant European health, safety and environmental protection legislation)
- All doors are secured to a welded locker frame by a solid vertical rod acting as the hinge
- All the units are manufactured from 0.9 mm steel for the doors and frame and 0.7mm for the backs and sides.
- All compartments have a transparent lock cover incorporating the facility to number each door to help identification
- Each charging compartment has a rear perforated panel to allow excess heat to dissipate

A. YCH16M	16 Compartment Mobile Charge Locker 1200 x 760 x 525mm	£775.00
B. YCH15	15 Compartment Charge Locker 1780 x 380 x 525mm	£512.00
C. YCH04	4 Compartment Charge Locker 1780 x 380 x 460mm	£245.00



Single power socket located at the rear of each compartment

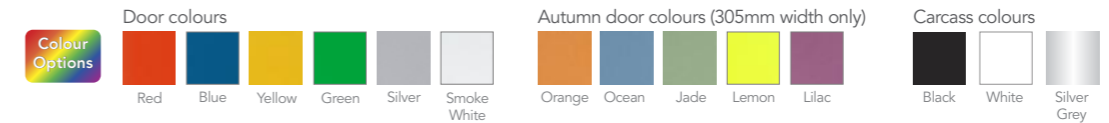

D. POWER 2 LEARN charging trolley & charging inserts

- This slim-line trolley has one of the smallest footprints in the market which makes this a perfect low cost and practical device charging option for smaller classrooms or learning areas
- The trolley can hold either 2 Extra Deep Power Trays or 3 Deep Power Trays (see ordering options below)
- Each Tray can charge a variety of USB Devices in Lightning fast speed using Dynamic Device Recognition
- Lockable trolley to securely store and charge tablets and small devices
- Trays available to order separately (not recommended for secure storage of devices)
- Each tray comes with a UK socket adaptor – simply plug in, switch on and connect up to 10 USB devices to charge
- Trays available only in Silver Grey or White
- Steel Trolley available in 5 modern bright colours: Silver, White, Power Blue, Power Pink and Power Yellow
- W423 x D454 x H957mm (inc. handle)

YP2L102	Trolley with 2 Extra Deep Charging Trays	£689.40
YP2L103	Trolley with 3 Deep Charging Trays	£836.00
YPTCF02	Deep Charging Tray ONLY	£197.40
YPTCF02.5	Extra Deep Charging Tray ONLY	£178.90





Laptop Storage

Lapcabby - vertical

- 10, 15 (includes projector and printer storage), 16 and 20 port laptop trolley
- Lockable unit to securely store and recharge laptops - sequential power supply included
- Specifically designed and tested air venting system maintains the security of the unit whilst increasing ventilation
- Soft rubber grips cushion and protect laptops when in storage and large L-shaped doors and sliding shelves provide easy, clear access to laptop storage compartment

a. YLAPC10V	LapCabby 10V W616 x D703 x H1115mm	£689.00
b. YLAPC15V	LapCabby 15V W1015 x D703 x H1115mm	£1053.00
c. YLAPC16V	LapCabby 16V W1015 x D703 x H1115mm	£852.80
d. YLAPC20V	LapCabby 20V W1015 x D703 x H1115mm	£975.00



Lapcabby Colours



Lapcabby - horizontal

- 16 and 32 laptop trolley
- Stored on an individual sliding tray for improved accessibility
- Lockable unit to securely store and recharge laptops - sequential power supply included
- Rear facing doors allows easy access to the individual AC adaptors supplied with laptops
- The Power7 timer allows schools to program which time each day they would prefer to charge their laptops according to the class schedule or Economy 7 to reduce energy bills
- An innovative cable storage system that keeps cables compact, neat and tidy

e. YLAPC16H	LapCabby 16H W857 x D703 x H1215mm	£1144.00
f. YLAPC32H	LapCabby 32H W1291 x D703 x H1215mm	£1722.50

Laptop Storage

Lapcabby mini

- 20 and 32 port mini laptop trolley
- Lockable unit to securely store and recharge laptops - sequential power supply included
- Storage boxes available for greater protection against knocks and scrapes
- The Power7 timer allows schools to program which time each day they would prefer to charge their laptops according to the class schedule or Economy 7, to reduce energy bills
- Unique energy saving dual cables which connect to the AC adaptors that are supplied with the laptops
- These cables will enable two mini laptops to charge using the same 3-pin plug
- Suitable for mini notebook laptops

a. YLAPCM20V	LapCabby 20V Mini W616 x D703 x H1115mm	£793.00
b. YLAPCM32V	LapCabby 32V W1015 x D703 x H1115mm	£998.00

Tabcabby

- 32 port tablet trolley
- Colourful easy-access sliding trays hold two tablets each
- Fitted with a Power7 energy management system as standard
- For added safety, AC adaptors and power supply are stored in a separate compartments - only accessible via a concealed door release
- Unique cable storage keeps cables compact, neat and tidy
- Heavy duty wheels
- Innovative air ventilation to cool tablets whilst charging
- TabCabby Store&Charge allows you to charge the majority of tablets and other USB powered devices. Using the Cambionix U16S technology you can also simultaneously synchronise all the devices whilst they are in the TabCabby

c. YTABC32H	TabCabby W840 x D437 x H1030mm	£773.90
d. YTABSYNC32	TabCabby Sync & Charge W840 x D437 x H1030mm	£1388.00

Media-avcabby

- Designed to hold your multi-media equipment with your projector, amplifier, DVD, VCR and speakers etc. at your fingertips
- The Media-AVCabby comes complete with many features including integrated power and lockable doors which fold back a complete 270 degrees and are held in place by strong magnetic catches
- This versatile unit is manufactured from MFC with soft corners to the top and bottom and is assembled around a fully welded, power coated steel frame, giving a sturdy unit capable of being moved easily on fully castored and braked rubber wheels

e. YMAVC200	Media-AVCabby W705 x D705 x H1105mm	£498.70
-------------	--	---------



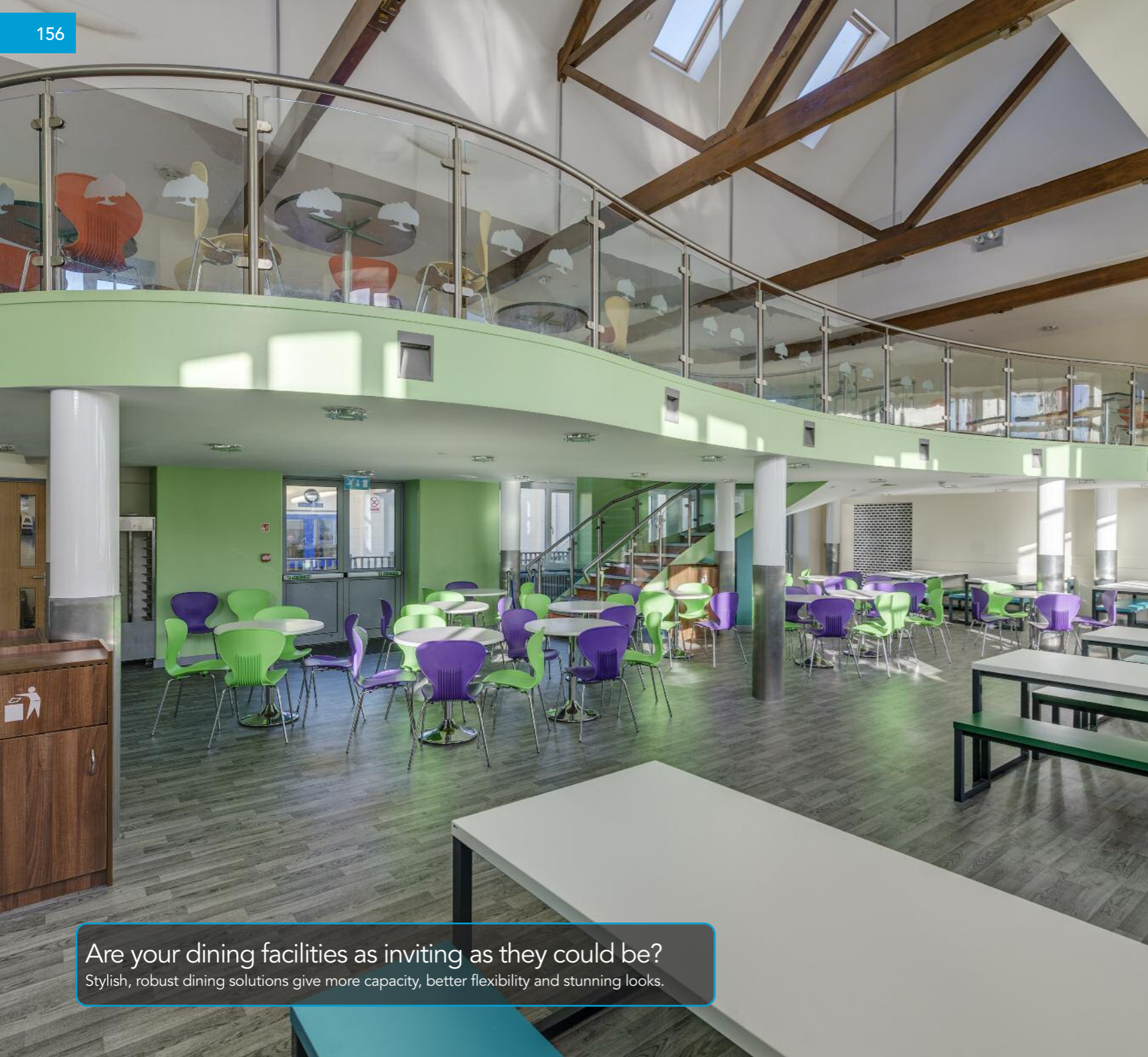

Are your dining facilities as inviting as they could be?

Stylish, robust dining solutions give more capacity, better flexibility and stunning looks.

Dining Furniture

Tilt Top Tables	158	Fresco Benches & Tables	167
Benchmark Folding Tables	159	Dining Chairs	168-175
Folding Tables with Stools	160	Stools	173
ConverTable	161	Cafe Table	176
Wall Pocket Tables	162-163	Carafe Table Tops & Bases	176
Ultimate Table/Bench	164	Espresso Tables	177
Concept Table/Bench	165	Statix Range	178
Dining Tables	166	Screens & Queue Barriers	179

Dining Furniture

Dining areas are much more than just places to feed students. They need to be welcoming and desirable places to eat and socialise, places that students feel comfortable in and spaces that attract them.

With our extensive experience we can help you create just the right ambience that will appeal to students and staff alike.

Whether it's a modern, sleek look for a new facility or a more traditional style to suit existing surroundings, we can help you achieve just the right effect that is hygienic, effective and inspiring. Whatever your requirements, we have a feast of ideas and valuable experience!



5 Year Warranty



Optimum tilt top dining tables

These premium quality tables are built to withstand years of busy daily use. They are easy to open and close and come with locking castors to ensure they stay in place in your hall.

Rectangular & circular tables

- Premium polyurethane edging for maximum hygiene and long life – resistant to bumps and knocks
- Available in 71 cm height as standard with other heights available to order – please ask

Rectangular		
Y360100	1200 x 600mm	£370.00
Y360102	1500 x 750mm	£440.00
Y360104	1600 x 800mm	£555.00
Y360106	1800 x 800mm	£560.00
Circular		
Y360108	1100mm dia.	£435.00
Y360110	1200mm dia.	£445.00

Colour Options When ordering, please specify:
1. top colour 2. height required
3. edge colour

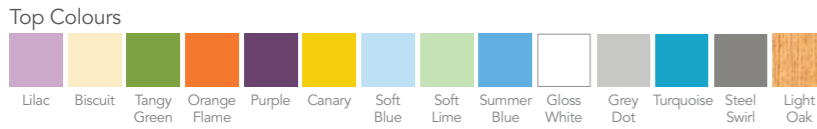

Octagonal tables

- Premium polyurethane edging for maximum hygiene and long life – resistant to bumps and knocks
- Available in 71 cm height as standard with other heights available to order – please ask

Y360220	1200mm	£270.00
Y360222	1380mm Irregular Octagon	£270.00

Colour Options When ordering, please specify:
1. top colour 2. height required
3. edge colour

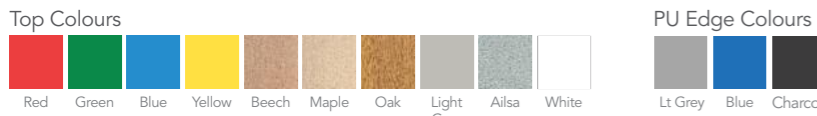

Benchmark folding table with benches

- Patented DoubleGuard® protects against tipping while table is being moved into storage position
- Tables nest compactly, requiring only 28cm of space centre-to-centre
- Tables feature compression spring Lift Assist for smooth, controlled operation
- Top design allows continuous end-to-end table placement
- Folded table easily clears standard door frames. Folded heights range from 1370 to 1982mm
- Edges are finished with EdgeGuard™, providing superior resistance to moisture and eliminating unsanitary food traps
- Width: Top 762mm; Bench 229mm; Total 1321mm
- 15 year warranty

	Table length cm	Seat capacity	Table & Bench height cm	Folded height cm
Y16074	257	10 - 12	69/43	137
Y16076	318	12 - 14	69/43	168
Y16078	379	16 - 20	69/43	198
Y16080	257	10 - 12	74/43	137
Y16082	318	12 - 14	74/43	168
Y16084	379	16 - 20	74/43	198



Image show Fusion Maple laminate tops – many colours available, please ask

15 Year Warranty

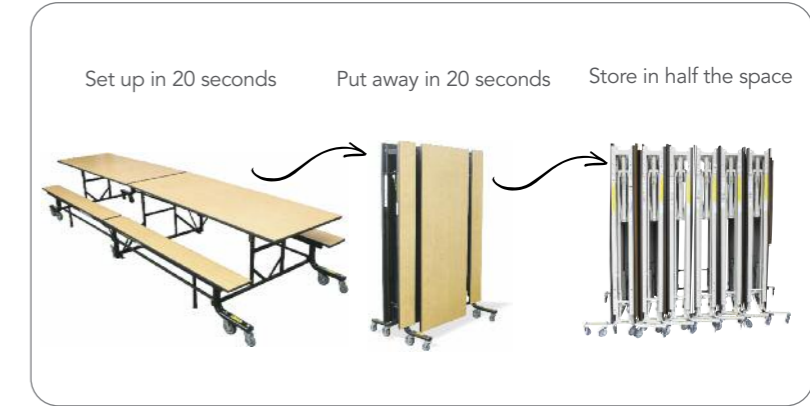

Stores in nearly half the space of standard folding dining furniture

- Stores in 44% less space
- Seats up to 20 students
- Reduces lunchtime set-up

Colour Options When ordering please specify:
1. frame colour
2. table colour

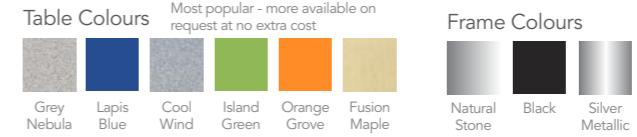



Folding dining tables with stools

- 18mm MDF core top with hard wearing high-pressure laminate surface for high endurance
- Tops have a seamless edging making them moisture resistant and resilient to damage
- All moving parts are secured with locking nuts and bolts to prevent detachment over time
- Units come with patented centre lock bar system which includes override mechanism for compact storage and transit position for safe handling and set-up
- 15 year warranty on the mechanisms and lifetime warranty on all welded parts

Folding rectangular tables

Y360600	With 8 Stools x H69cm	POA
Y360602	With 8 Stools x H74cm	POA
Y360604	With 12 Stools x H69cm	POA
Y360606	With 12 Stools x H74cm	POA
Y360608	With 16 Stools x H61cm	POA

Folding oval table

Y360610	With 8 Stools x H69cm	POA
Y360612	With 8 Stools x H74cm	POA
Y360614	With 12 Stools x H69cm	POA
Y360616	With 12 Stools x H74cm	POA

Folding octagonal table

Y360618	With 8 Stools x H69cm	POA
Y360620	With 8 Stools x H74cm	POA

Table height guide
 740mm 11 years to adult
 690mm 7 to 11 years
 660mm 4 to 11 years
 610mm 4 to 7 years

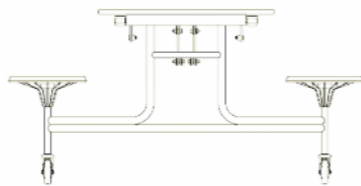

Colour Options When ordering please specify:
 1. table colour
 2. stool colour

Stool colours

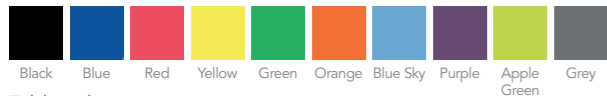
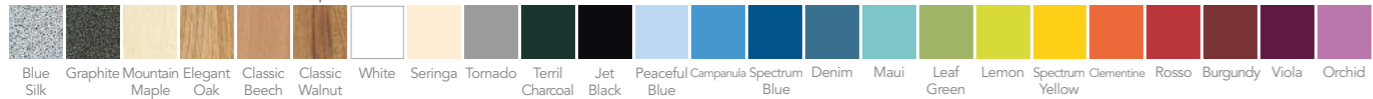

Table colours - more available on request



ConverTable bench table

- Converts easily from a single-sided table to a comfortable bench. Two tables together make a full size cafeteria table
- Ideal for auditorium, lunchroom and additional classroom seating
- New 64cm high model available for early childhood applications
- Optional linking mechanism connects tables together securely.
- Dimensions – Back / Top width 38cm / Seat width 31cm
- 15 year warranty

	Table length cm	Seat capacity children	Table & Bench adult	height cm
Y16050	122	3	2	64/38
Y16052	183	4	3	64/38
Y16054	213	5	4	64/38
Y16056	244	6	5	64/38

Y16058	122	3	2	69/38
Y16060	183	4	3	69/38
Y16062	213	5	4	69/38
Y16064	244	6	5	69/38

Y16066	122	3	2	74/43
Y16068	183	4	3	74/43
Y16070	213	5	4	74/43
Y16072	244	6	5	74/43

Approximate seat widths: 406mm per child, 483mm per adult



New space-saving frame style as shown



Auditorium Seating
 Arranged in rows, these units can convert a rarely used room to a useful auditorium.



Cafeteria Seating
 Two tables placed back-to-back become a standard sized table.

Picture shows two tables



Classroom Seating
 Reconfigure tables in rows for study or exams.



Folds up easily for storage

Ask For A Demo

Phone For Bulk Prices

Please ask for our full colour chart at no extra charge

Frame Colours

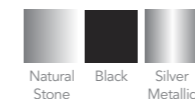
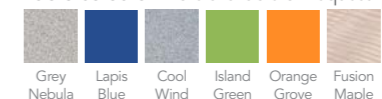

Table colours - more available on request



Colour Options When ordering please specify:
 1. frame colour
 2. table colour



Suitable for installation to existing as well as new build halls

Custom table design available



15 Year Maker's Guarantee

FREE Demo DVD on request

15 Year Maker's Guarantee



Wall pocket dining system

The perfect answer to dining furniture in multi-use school halls! The space-saver wall pocket tables are the best solution for schools that use their halls for PE, dining and assemblies as these tables simply fold away into the walls when not in use. Seating up to 20 children per table, the wall pocket table folds down when required and it takes just seconds to convert your hall into a full dining facility. When finished they fold away taking up less than 2½ square feet of floor space!

- Secure locks and counter-balance sprung for safety and control
- Benches and tables can be used independently for assemblies, community use, tabletop sales and lectures

- Pocket storage unit available as surface mounted or flush fitting for optimum space efficiency
- Optional filler panels between multiple units create a flat safe surface, facilitating multi-use activities
- Available as single, double, triple and quadruple pockets for up to 4 tables and 8 benches in one pocket!
- Special 'EdgeGuard' finish to table top for hygiene, strength and long life
- 15 year manufacturer's warranty
- Call for free survey, references and quote
- Customise your table tops with your school logo

Best Seller

A



Must be stacked vertically

B



We recommend using B on page 166 for safe and easy transportation

Bench & Table Heights
When ordering, please add the height code (A-I) e.g. code Y14014 would be Y14014B for the 698mm height.

Table heights and codes:		Bench heights and codes:	
A Buffet	760mm (30")	G Buffet	483mm (19")
B Adult	698mm (27.5")	H Adult	432mm (17")
C Junior	635mm (25")	I Junior	381mm (15")
D Infant	584mm (23")		
E PreSchool	546mm (21.5")		
F Nursery	508mm (20")		

Colour Options When ordering your tables and benches please specify:
1. length 2. height 3. laminate colour

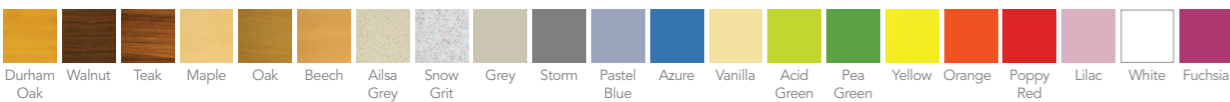

A. Ultimate tables with polyedge™

The Premier range of folding tables features the superb polyurethane edge. The table top surface is durable, hygienic and of the highest quality.

- Suitable for dining, social gatherings, and community use
- Folds flat for storage and is easily transported, enabling this product to be used in a multi-functional environment
- Strong in construction, all 760mm and 685mm high tables are supplied with aluminium clad steel legs for stability
- Select the height of table you require from 6 heights
- 4 table lengths available 92cm, 122cm, 152cm, 183cm
- 3 table widths available 61cm, 69cm 76cm
- 14 colours to choose from

Premier folding tables

	Length		Width		Approx weight kg	
	mm	Inches	mm	Inches		
Y14014*	915	36	610	24	9.00	£106.60
Y14016*	915	36	685	27	9.75	£109.20
Y14018	915	36	760	30	12.00	£113.40
Y14020	1220	48	610	24	11.25	£127.50
Y14022	1220	48	685	27	12.75	£130.60
Y14024	1220	48	760	30	13.00	£135.40
Y14026	1520	60	610	24	15.25	£140.70
Y14028	1520	60	685	27	16.50	£148.40
Y14030	1520	60	760	30	17.25	£154.50
Y14032	1830	72	610	24	17.50	£164.50
Y14034	1830	72	685	27	18.75	£167.80
Y14036	1830	72	760	30	19.50	£172.90
Y14038	FastFold Speedy Folding Tool					£10.00

* Not available in height size A

B. Ultimate stacking benches with polyedge™

- Stacking benches feature the superb polyurethane smooth sealed edge for ultimate hygiene and easy cleaning
- These benches are of the highest quality and when combined with a Premier table they transform any dining area or canteen
- A popular alternative to stacking chairs
- Available in 3 lengths 122cm, 152cm 183cm, and 3 heights 48cm, 43cm, 38cm
- Strong and robust, durable and hygienic
- Stacks for storage - use the Bench Skate Set comprising two ABS plastic moulded skates, to move your stack of benches with ease

Premier folding benches

	Length		Width		Approx weight kg	
	mm	Inches	mm	Inches		
Y14002	1220	48	254	10	6.25	£76.40
Y14004	1520	60	254	10	7.00	£91.20
Y14005	1830	72	254	10	8.80	£100.70
Y14008	Bench Skate Set				3.00	£70.90

A. Concept folding tables and stacking benches

- The Concept range of folding tables and stacking benches are recommended for Dining & Canteen Halls, Youth Organisations and Outdoor Catering
- Lightweight and versatile, with a wide range of sizes available

Concept folding tables

	Length		Width		Approx weight kg	
	mm	Inches	mm	Inches		
Y14040	915	36	610	24	6.75	£79.30
Y14042	915	36	690	27	7.25	£81.20
Y14044	915	36	760	30	7.25	£84.20
Y14046	1220	48	610	24	8.00	£90.70
Y14048	1220	48	690	27	8.25	£93.00
Y14050	1220	48	760	30	9.50	£96.60
Y14052	1520	60	610	24	9.75	£97.50
Y14054	1520	60	690	27	10.25	£103.60
Y14056	1520	60	760	30	11.25	£107.20
Y14058	1830	72	480	19	11.00	£102.80
Y14060	1830	72	610	24	11.50	£113.00
Y14062	1830	72	690	27	12.00	£115.40
Y14064	1830	72	760	30	13.00	£119.10

Y14038	FastFold Speedy Folding Tool	£10.00
--------	------------------------------	--------

Concept folding benches

	Length		Width		Approx weight kg	
	mm	Inches	mm	Inches		
Y14066	1220	48	254	10	5.00	£60.50
Y14068	1520	60	254	10	5.75	£68.30
Y14070	1830	72	254	10	6.75	£73.60
Y14008	Bench Skate Set				3.00	£70.90

Colour Options When ordering your tables and benches please specify:
1. length 2. height 3. laminate colour

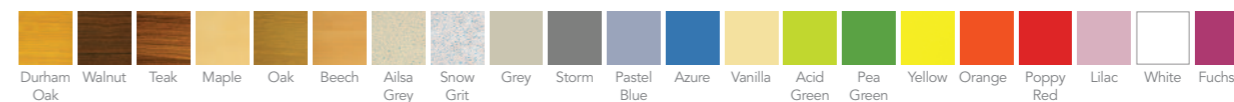

Best Seller

Must be stacked vertically



We recommend using product B on page 166 for safe and easy transportation

Bench & Table Heights
When ordering, please add the height code (A-I) e.g. code Y14014 would be Y14014B for the 698mm height.

Table heights and codes:		Bench heights and codes:	
A Buffet	760mm (30")	G Buffet	483mm (19")
B Adult	698mm (27.5")	H Adult	432mm (17")
C Junior	635mm (25")	I Junior	381mm (15")
D Infant	584mm (23")		
E PreSchool	546mm (21.5")		
F Nursery	508mm (20")		

Phone For Bulk Prices



A

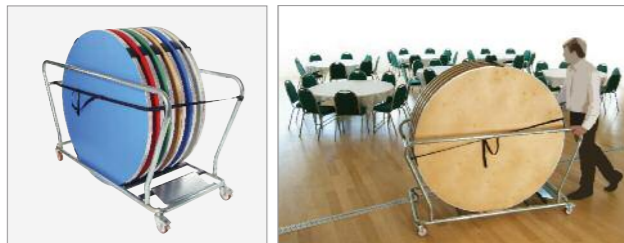

Storage Trolley

A. Round folding tables

- The Round folding tables and stacking benches are recommended for school dining, from pre-school up to adult use
- Easy to carry and open with a simple to fold clasp the tables are strong and robust, folding flat for storage
- A wide range of sizes available with 14 choices of laminate and sealed ply see page 164



Colour Options

- Choose
1. table diameter
 2. table height
 3. laminate colour see page 163

Round Folding Tables

	Table diameter	Table Finish	Approx weight	A Buffet 76cm (30")	B Adult 70cm (27.5")	C Junior 64cm (25")	D Infant 58cm (23")	E PreSchool 55cm (21.5")	F Nursery 51cm (20")	
Y14072	4ft Round	122cm	Laminate	20.00kg	•	•	•	•	•	£204.80
Y14074	5ft Round	152cm	Laminate	27.50kg	•	•				£238.80
Y14078	Storage Trolley									£336.10

B



B. Trolley

- Table trolleys in 2 sizes to suit all needs
- Takes up to 14 tables through a standard doorway for easy storage
- Locking castors for safety

Y14010	Up to 7 Tables	each	£203.20
Y14012	Up to 14 Tables	each	£290.30

Fresco

Fresco indoor tables and benches are revolutionary in their design and construction. The special design means they are strong, robust and stable yet incredibly light and durable making them perfect for canteens, cafés and dining areas. Fresco tables and benches are delivered flat packed and require simple assembly using an allen key.

A. Fresco dining benches & tables

- Available in 8 top colours and 6 edge colours
- Strong, stable and very durable
- Also available in 900 & 1200mm round
- Ideal for educational use
- 3 bench sizes and 6 heights
- Table heights: 71cm, 64cm, 59cm
- Bench heights: 46cm, 43cm, 38cm, 35cm, 31cm, 26cm
- Please specify height when ordering
- Powder coated black and grey frame available

Benches

Code	Size l x w	Weight Kg	
YDENAF35	160 x 33cm	12.00	£101.00
YDENC35	120 x 33cm	10.00	£86.30
YDENDF35	100 x 33cm	8.00	£77.70

Tables

YDENAA35	180 x 75cm	25.00	£159.00
YDENCA35	140 x 75cm	19.50	£142.20
YDENDA35	120 x 75cm	17.50	£125.30

Dining colour range



Edge colours



A

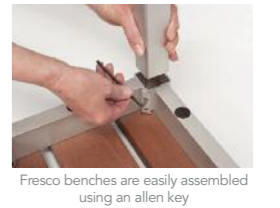

Fresco benches are easily assembled using an allen key



Anodised Silver Frame

B. Fresco outdoor benches & tables

- Perfect for playgrounds, dining or outdoor learning
- Mahogany look synthetic wood with silver anodised aluminium frames
- Benches fit neatly under the tables for storage
- Available in 3 heights: 43cm, 38cm or 35cm
- Please specify height when ordering

Benches

Code	Size l x w	Weight Kg	Price
YDENAF36OD	160 x 33cm	13	£148.70
YDENDF36OD	105 x 33cm	8.5	£125.80

Tables

YDENAE36OD	180 x 90cm	27.00	£343.20
YDENDE36OD	125 x 90cm	18.75	£274.50
YDENDD36OD	125 x 125cm	27.0	£343.20



B



A



New Product

2 Year Warranty

A. Tuscany polypropylene dining chair & stool

- The Tuscany brings a modern, lively look to dining and study areas, whilst the strong polypropylene seat and chrome frame are very wear resistant
- Available in 16 distinctive colours
- Stackable
- 2 year warranty

YD565	Chair	£55.00
YD566	Stool	£90.00

Colour Options

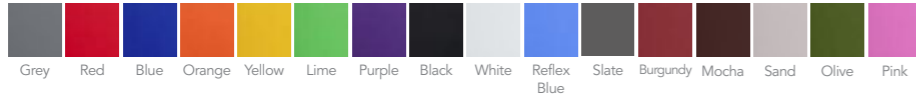

B



Dolly for Sochi Chair

B. Sochi dining chair

- Designed to be tough yet elegant, the Sochi chair is versatile, durable and easy to clean. Ideal for multifunctional spaces, cafes, dining areas and libraries, these chairs can be quickly rearranged to meet the users needs
- Single piece injection moulded polypropylene
- Available in 7 colours
- Stackable to 26 high on transport dolly
- BIFMA tested for strength & stability 5 year warranty

		1-29	30+
YD5677	Sochi Chair	£49.50	POA

* Please specify colour required

Colour Options

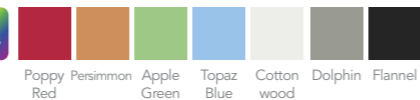

Page Link - see page

Dining tables

164

C



5 Year Warranty

C. Flex dining chair

- The Flex shell shape offers both fun flexibility and 360° sitting positions, supporting user's movements in every direction for optimum comfort and practicality
- Made from 12 % glass filled recyclable polypropylene (PP)
- Available in 10 colours
- Stackable
- Expected to last for 20 years and guaranteed for 5 years for structural defects

		1-29	30+
Y360200	Flex Chair	£44.00	POA

* Please specify colour required

Colour Options



A. Flow dining chair

A robust, durable and extremely popular chair which will work hard in your dining room giving years of dependable service. The iconic shape and chrome frame looks great and the angled rear legs discourage tilting.

- Available in 16 colours
- Stacks 6 high
- 15 year warranty for complete peace of mind
- Seat height 460mm

		1-29	30-99	100+
Y360124	Chrome Frame	£61.50	£59.50	POA
Y366326	Silver Frame	£40.00	£38.00	POA

For critical colour matching please ask for a sample



New Silver Frame Option

A

B. Polka dining chair

- Bring a vibrant pop of fun to your dining area with the Polka chair and give your students something to shout about!
- Amazingly strong, ergonomic design tested to EN1729 to give an improved dining experience for students
- Stackable, stable design, which is hard to tilt
- Available in 8 colours
- Frame colours are Black, Light Grey, Dark Grey, Silver, Chrome

	Seat Height	Width	1-29	30+
Y360128	430mm	490mm	£20.00	POA
Y360129	460mm	490mm	£21.00	POA

Shell Colours

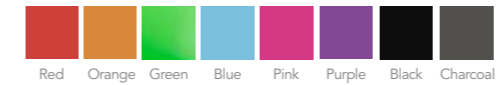

B

C. La Rocca dining chair

- The La Rocca chair is guaranteed to bring an urban look to your dining hall with its striking elegant design
- This affordable chair is one of the strongest polypropylene chairs on the market with a steel frame that extends up the back of the chair
- Available in 7 shell colours
- Frame colours are Flint or Silver (Silver at additional cost)
- UK made with a 10-year guarantee

	Seat Height	Width	1-29	30+
Y360130	460mm	463mm	£25.90	POA

Shell Colours



C



21 Year Warranty

A. Chevron chair



- One Piece Polypropylene Chair
- Streamline design for ergonomics & comfort
- Stronger and Lightweight - glass filled polypropylene ensures greater strength and durability, yet lighter weight
- Space Saving Stack-ability - the chair stacks easily for efficient storage, up to 21 chairs within a 2 metre height
- Slim line curved legs for pleasing aesthetics
- Sustainable Materials - uses less materials than any other chair in its class. Made from fully recyclable materials
- Stacks 21 high
- 10 Colours available
- Orders of less than 10 chairs may carry a carriage charge

	Seat Height	Overall Width	1-29	30+
Y100142	260mm	400mm	£14.25	POA
Y100143	310mm	400mm	£14.70	POA
Y100144	350mm	460mm	£15.50	POA
Y100145	380mm	460mm	£15.95	POA
Y16717	430mm	500mm	£18.80	POA
Y16718	460mm	500mm	£19.95	POA
Y100116	Linking Device		£4.50	POA

Trolley to take 30 chevron chairs

- Supplied flat packed for easy assembly
- Complete with ratchet strap

Y100118 each £110.00

For critical colour matching please ask for a sample

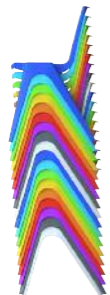
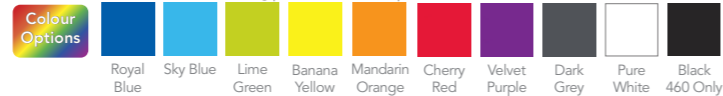

Stacks 21 High



10 Year Warranty



Stacks up to 25 high using dolly

B. Atlas skid base chair



- An extremely strong yet compact chair
- Ideal for use in school halls or where space is limited
- Linking attachment available

Code	Seat Height	Overall Width	
Y16500	260mm	370mm	POA
Y16501	310mm	370mm	POA
Y16502	350mm	410mm	POA
Y16503	380mm	460mm	POA
Y16504	430mm	460mm	POA
Y16505	460mm	460mm	POA
Y16506	Dolly for Atlas Skid Base Chair		POA
Y16507	Linking Attachment		POA

Frame Options



* Colours depicted are only a guide. For an exact swatch sample or alternative colour please call us to discuss your requirements.
* Black seat shell only available in sizes 380, 430 & 460mm.

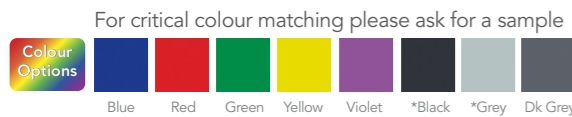

For critical colour matching please ask for a sample

A. The contour poly chair



- Modern contoured style
- Meets EN1729 Parts 1 & 2
- Can be stacked 8 high with great stability
- Flame retardant option (POA)
- Orders of less than 10 chairs may carry a carriage charge

Code	Seat Height	Overall Width	1-29	30+
Y16720	350mm	440mm	£20.30	POA
Y16721	380mm	440mm	£20.70	POA
Y16722	430mm	500mm	£21.10	POA
Y16723	460mm	500mm	£21.50	POA



6 Year Warranty

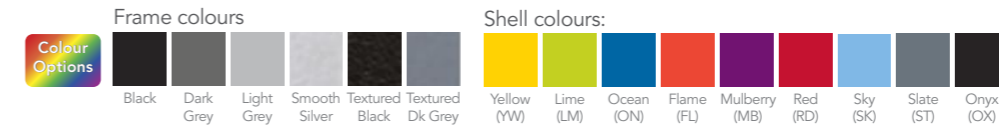

B. Mono posture chair

- Postura Mono chair is the UK's most popular classroom chair
- Ergonomically designed to promote good posture and provide exceptional comfort
- Angled back legs discourage leaning back
- Certified to FIRA to meet BS EN1729 Parts 1 & 2 for dimensions, strength and stability
- Orders of less than 10 chairs may carry a carriage charge

	Seat Height	Overall Width	1-29	30+
Y16514	260mm	280mm	£15.95	POA
Y16515	310mm	280mm	£16.40	POA
Y16516	350mm	340mm	£17.20	POA
Y16517	380mm	380mm	£17.60	POA
Y16518	430mm	380mm	£19.50	POA
Y16519	460mm	400mm	£21.10	POA
Y16520	Seat Pad			POA
Y16521	Linking Device (430 & 460mm Heights)		£9.25	



Stacks up to 15 high



Upholstered seat pad



Black is manufactured from recycled material

**20 Year Warranty

Colour Options Sizes 310, 350 and 380 are not available in Black. 260mm only available in Poppy Red, Ink Blue, Forest Green and Sun Yellow



Linking mechanism for 430 & 460mm heights



New Product



A

A. Skagen dining chair & stool

- With a nod towards Scandinavian style, the distinctive Skagen range combines wood and steel to create a robust and elegant addition to your dining area
- Shown in Black and Natural but also available in Raw Ash
- Available in 3 dining heights

		Seat Height mm	
Y366318	Dining Chair	480	£70.00
Y366319	Mid Stool	650	£84.00
Y366320	High Stool	750	£87.00

New Product



B

B. Ermington dining chair

- The Ermington adds a sophisticated look to any dining area with its one-piece shell and chrome frame
- 4-leg Chrome version stacks up to 6
- Frames in Steel or Chrome
- Maple Veneer

		1-29	30+
YD303	Dining Chair	£44.00	POA
Y366321	Chrome Spar Chair	£53.00	POA
Y366322	Black Spar Chair	£53.00	POA
Y366323	Wood Spar Chair	£47.00	POA

Please see page 268 for wooden frame options



C

C. Pescara dining chair

These classic chairs are particularly attractive with the back detail and the extra robust frame ensures long life and reliability in your dining hall.

- Also available in the dark wenge colour

		1-29	30+
YD1145	Pescara Dining Chair	£48.00	POA
YD1146	Pescara High Stool	£88.00	POA

New Product



A

A. Metallique side chair

- Wanting to create a 'Costa style' dining area? The vintage Metallique range provides just that!
- Shown in Gunmetal, also available in Silver and Copper
- Low stool and high stool (without back) also available

Y366328	Side Chair	£55.00
Y366329	High Chair	£65.00

B. Spar dining chair

- With its iconic retro style and strong polyurethane seat the Spar chair will bring style and character to your dining space
- Available in 10 modern colours
- New mid height stool for 2019

		1-29	30+
YD102	Spar Dining Chair	£59.50	POA
Y366324	Spar Mid Stool	£78.50	POA

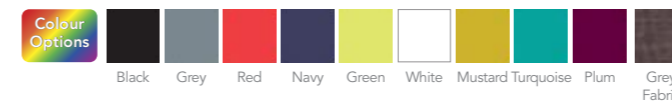

New Mid Stool Height for 2019



B

C. Strata dining chair

- These sleek and designer style dining chairs add a great element of style to your dining room and you have a choice of the minimalist 4 leg or the sophisticated spar design leg frame
- Made of tough polypropylene with chrome steel frames, these chairs are designed to last as well as looking good every day
- Available in 9 modern colours

		1-29	30+
Y360112	Four Leg	£57.50	POA
Y360114	Spar leg	£72.00	POA

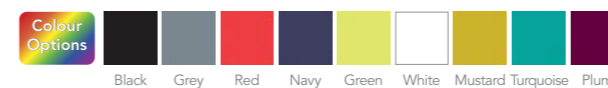

Other frame options available



C

A

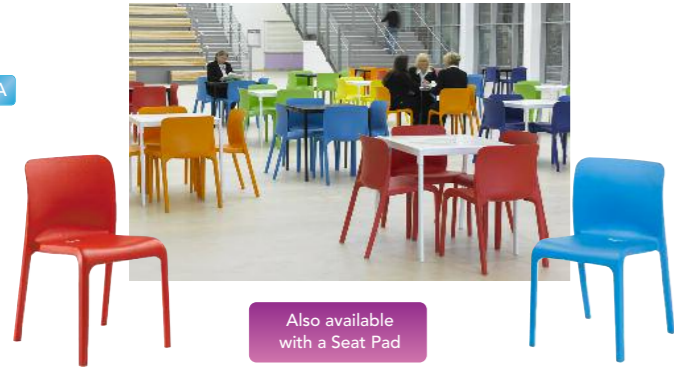

Colour Options



A. Stanza café chair

- Looking for a little chic? You've definitely got it with Stanza!
- No screws, joints or pressure points
 - Designed for maximum comfort & good lumbar support
 - Made from reinforced Polypropylene with a lightly textured polymer finish
 - Lightweight and easy to handle
 - Easy clean and resilient
 - Stacks up to 10 high
 - Interior and Exterior use - UV resistant
 - Available in 10 dynamic colours

		1-29	30+
YD995	Stanza Café Chair	£46.00	POA

New Product

B



B. Veneto dining chair

- Holiday culture? You've definitely got it in these sleek black chairs, sure to bring an Italian alfresco feel to your dining area
- Intended for outdoor use but also work well indoors
- Maintenance-free wood effect for all the looks & no hassle
- Strong aluminium welded frame
- Stackable to 6 chairs
- Shown in Black and Brown wood effect, also available in real teak

		1-29	30+
Y360140	Veneto	£58.00	POA
Y366327	Veneto Armchair	£65.00	POA

Also available in brown wood-effect

Matching tables available as shown

C



C. Seville cafe armchair

- The Seville Cafe black polypropylene and aluminium bistro chair is ideal for all eating, informal conferencing and sixth form areas providing a durable and cost effective solution
- Indoor and outdoor use
- Fully welded frame for maximum strength with no screws or bolts to come loose

		1-29	30+
YD624	Seville Cafe Armchair	£46.00	POA

New Product

A



A. Forma dining chair

- With its ergonomic and strong polypropylene construction, the Forma is an affordable yet stylish dining chair that is suitable for both indoor and outdoor use
- Made in Italy
- 3 year warranty
- Available in Black, White, Green, Grey, Blue and Red

		1-29	30+
Y366325	Forma Dining Chair	£43.00	POA

B. Malaga dining chair

- The Malaga chair is sure to add a touch of café culture to your dining hall with its sleek, contemporary design
- Single piece reinforced polypropylene means this chair is perfect for indoor and outdoor use
- Stackable up to 12
- 2-year guarantee

		1-29	30+
Y360135	Malaga Chair	£62.00	POA

Colour Options



B

C. Lingua dining chair

- This is what stackable elegance in your dining area looks like – stacks up to 8 chairs.
- Elegant design crafted from very strong reinforced polypropylene.
- Suitable for outdoor and indoor use.
- Available in 6 colours

		1-29	30+
Y360150	Lingua	£72.00	POA

Colour Options

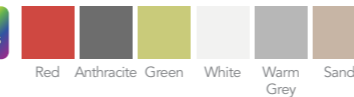

C

5 Year
Maker's
Guarantee

20 tables store easily on a single trolley!

Tables can be
bought individually

Page Link - see page

For
Roma
Chair
2662 Year
Maker's
GuaranteePhone
For Bulk
Prices

A. Espresso café table

- Stylish, durable and lightweight mobile cafeteria tables that add a touch of café culture to your dining room
- You want portability and versatility? Espresso will allow you to quickly change your school hall's identity. From indoor tennis court to food court in about the time it takes a barista to make a fresh cup of Italian coffee!
- Carts come with posuer height bases (1065mm) as standard when you buy a package and dining height bases (735mm) can also be used with the cart
- The Espresso cart holds up to 20 tabletops, 20 bases and 40 columns which can be set up in no time at all. And when you're done, they can be effortlessly stored away on the compact cart taking up just 82 x 144cm of space
- Lightweight - Espresso tabletops are effortless to lift and manoeuvre - up to 50% lighter than standard table tops
- Requires no tools - each Espresso component simply twists and locks into place
- Versatile - two column heights are available which means you can quickly change from café to poseur-height and back in no time at all
- SmartEdge - ultra-durable urethane edging provides a perfectly sealed seamless surface with antibacterial and antifungal properties
- Customisable - each table can be customised with a graphic of your choice
- Super tough durable and hygienic table surface, Three different diameters to suit every need, Available in a wide range of standard and custom table finishes and edge colours, Chrome or black base options, 5-year manufacturer's warranty

YD24RP10	H1065 x 610mm Dia. - 10 Table Cart
YD24RP20	H1065 x 610mm Dia. - 20 Table Cart
YD30RP10	H1065 x 760mm Dia. - 10 Table Cart
YD30RP20	H1065 x 760mm Dia. - 20 Table Cart
YD36RP10	H1065 x 915mm Dia. - 10 Table Cart
YD36RP20	H1065 x 915mm Dia. - 20 Table Cart

B. Café - table

- These cafe tables are suitable for either internal or external use matching our other aluminium furniture
- The tables are robust and strong for use in student areas
- The easy to clean tops and 2 year guarantee ensure these tables provide outstanding value for money
- Larger tables also available

		1-19	20+
Y16476	Cafe Round Table	£65.00	£61.00

A. Café dining tables

These robust tables look great in any dining setting and are sure to add a café feel

- Heavy bases ensure good stability in high footfall areas
- Tops priced on white or beech - lots of other colours available
- Many other base options also available

Chrome Square Dining Base

Y366366	720mm with 600mm Square Top	£110.00
Y366367	720mm with 800mm Square Top	£120.00

Black Square Dining Base

Y366368	730mm with 600mm Square Top	£100.00
Y366369	730mm with 800mm Square Top	£110.00

Spar 4-Leg Dining Base

Y366370	730mm with 600mm Square Top	£84.00
Y366371	730mm with 800mm Square Top	£94.00

New
Product

B. Carafe table

- These strong and elegant tables are sure to create a stylish café look in any dining area
- Heavy bases ensure good stability in high footfall areas
- Tops shown in white and grey - lots of other colours available
- Many other top and base options available - please ask

Chrome Trumpet Dining Base

Y366342	730mm with 600mm Top	£135.00
Y366343	730mm with 800mm Top	£150.00

Chrome Trumpet Large Dining Base

Y366344	730mm with 1000mm Top	£240.00
Y366345	730mm with 1200mm Top	£255.00

New
Product



Table & Bench Top & Frame Colour Options



Additional Top Options (not frames)

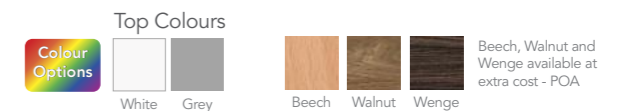
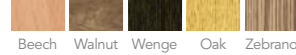
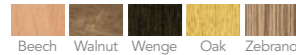
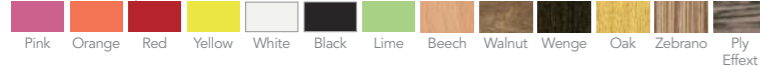

Table & Bench Options



Edge Colour Options (not frames)



A. Statix hoop dining range

- The Statix Hoop dining range is a contemporary yet practical solution for modern dining environments
- Fully welded frame construction with 40mm thick tops and high impact resistant edges
- Easy clean laminate surfaces
- Benches store neatly under the tables for compact storage
- Many colour options available - please ask

Benches

Y360500	H450mm x L1000mm	£230.00
Y360502	H450mm x L1600mm	£260.00
Y360504	H450mm x L2000mm	£307.00

Tables

Y360506	H730mm x L1200mm	£415.00
Y360508	H730mm x L1800mm	£453.00
Y360510	H730mm x L2200mm	£490.00
Y360512	Poseur Table H1050mm x L1900mm	£530.00

B. Statix bold dining range

- The Statix Bold range is a hard-wearing yet stylish choice for the modern dining room
- Heavy duty construction made with 40mm laminate and high impact resistant edges
- Easy clean laminate surfaces
- Benches store neatly under the tables for compact storage
- Many colour options available - please ask

Statix Bold Bench

Y360520	H400mm x L1000mm	£314.00
Y360522	H400mm x L1600mm	£334.00
Y360524	H400mm x L2000mm	£407.00

Statix Bold Table

Y360526	H750mm x L1200mm	£630.00
Y360528	H750mm x L1800mm	£740.00
Y360530	H750mm x L2200mm	£793.00

Statix Bold Poseur Table

Y360532	H1050mm x L1300mm	£862.00
Y360534	H1050mm x L1900mm	£938.00
Y360536	H1050mm x L2300mm	£1,015.00



Dining screens & queue barriers

Create the perfect setting in your dining hall using our wide range of smart screens. Robust and designed to last, these screens will help control student traffic flows and achieve the right ambience in any eating or reception area.

- Strong and stable for safety and durability
- Available in different sizes and colours for any application
- Wide, stable feet and linking strips for flexibility
- Re-configure your hall for a special event in seconds
- Free space plan service - just ask!





Needing to cater for everyone in your library?

We can beautifully display your books and store those resources - whilst creating areas for relaxed reading and inspiring learning areas.

Libraries & Learning Zones

Projects	182-184
Windermere Shelving	185
Dynamix Shelving	186
Cantilever Shelving	187
Coniston Shelving	188
Lundy Island Units	189
Book Storage Units	190
Book Spinner & Kinderboxes	191
Easy Seating	192-195
Bean Bags	195
Study Hubs	196-197

Libraries & Learning Zones

Libraries are fast becoming much more than just a place to display books. With the rise of self-directed learning and personalised study programmes, libraries and learning zones are often the central feature of the school.

From group activities right through to individual study we have a full range of furniture, shelving and seating to create the perfect environment for you.

Whether its bespoke or from stock, you'll be amazed at the ideas we'll come up with based on solid experience combined with creativity and design flair. Zones to take your breath away!





Stylish, comfortable and space efficient library seating solutions - please call for more information



Libraries & Learning Zones

Let our designers demonstrate what we could do with your Learning Zone. With increasing numbers of schools and academies creating dynamic and functional spaces for Self-Directed Learning the options for these areas have just exploded! Make your library a magnet for learners who want to be high achievers. Create an atmosphere conducive to serious study and let us design something that will stand out among other nearby schools.



Libraries & Learning Zones



Library Space Planning & Refurbishment

If you're struggling for ideas for your library let us help! We offer a FREE space-planning service so you can visualise how your new space will look. From loose furniture through to a full refurbishment, our teams of space planners, designers and installers will transform your library into a fun, inspiring and vibrant space for your students.

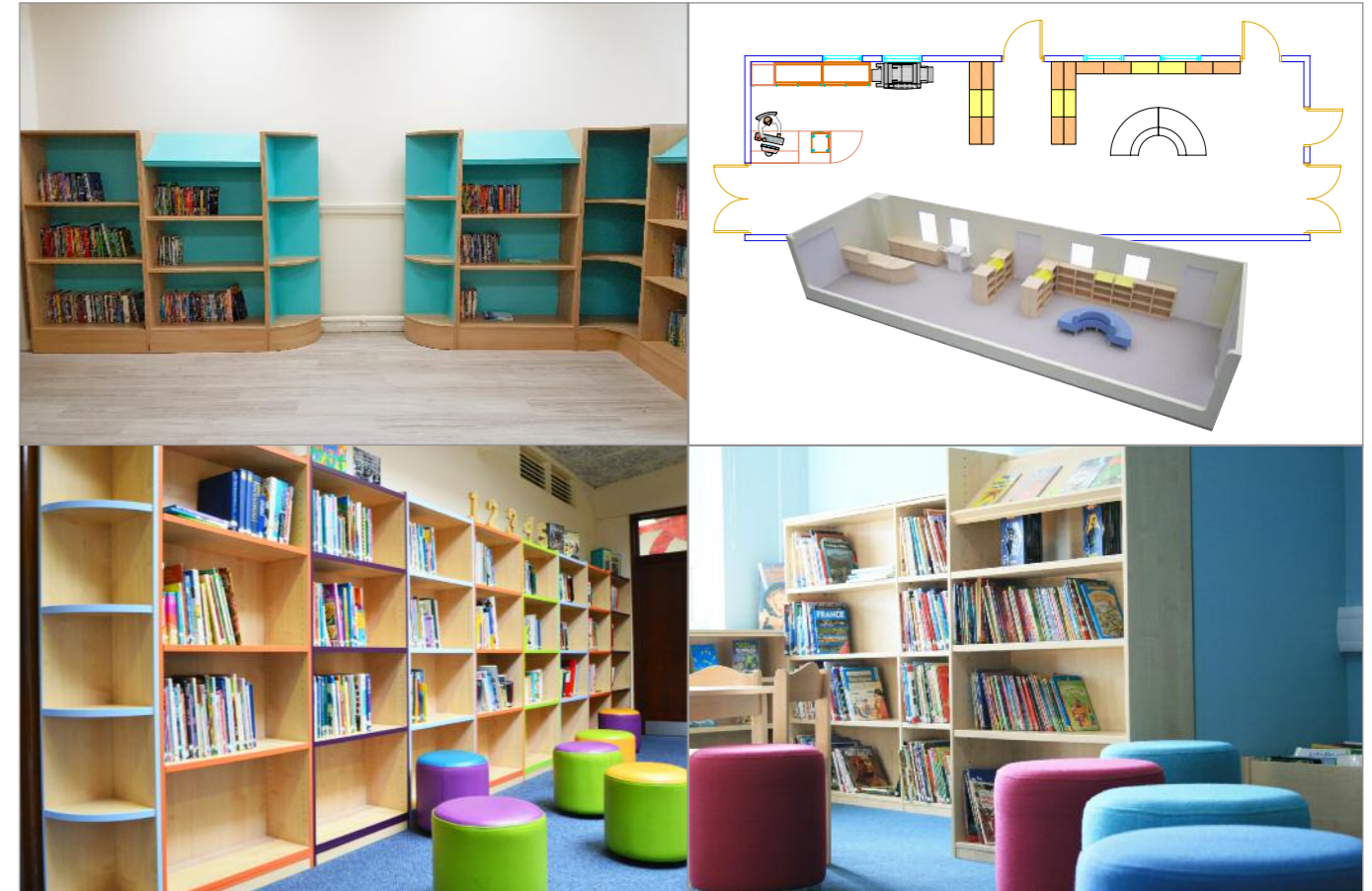

Windermere Shelving

- A great alternative to metal shelving with its soft colourful timber appeal
- An extremely robust and cost effective system that gives a fully fitted result from a product assembled by our experienced fitters
- On these pages three ready kits are shown as starter units or create your own shelving system
- A massive range of unit dimensions and a choice of shelf types means that with our expert space planners you can create a system that will meet your individual requirements
- Units can be double sided and a range of heights is available to allow you to use full height shelf or just some low island storage units

The possibilities are endless...
libraries, classrooms, reading
corners, offices...
...create an environment to
fulfil your needs.

Dynamix Library System



Stunning units with coloured edges and tops, the dynamix range creates an impressive and stimulating library and learning environment.

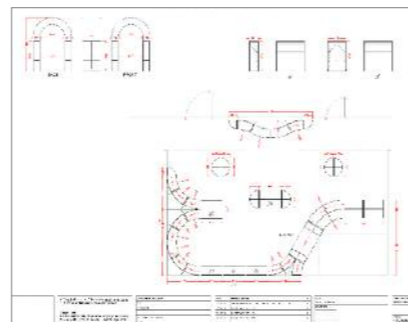
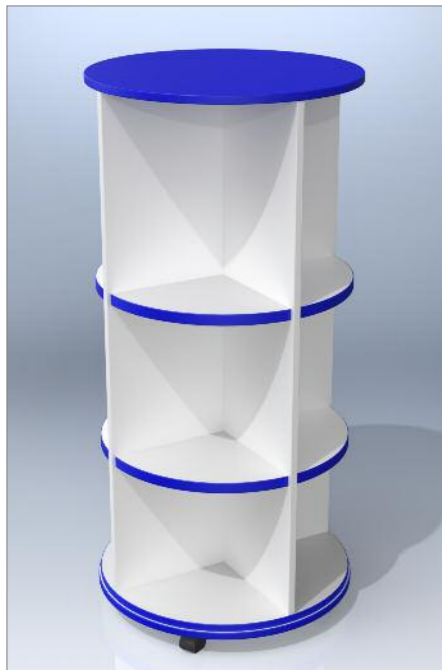
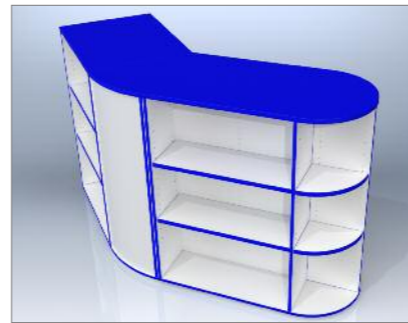

Cantilever Shelving

- This versatile shelving system offers a wide range of shelves and accessories - ideal for all library and office requirements
- Modern and stylish, this system can be quickly adapted to meet your changing needs
- Space planning and fitting also available
- The system is quick and easy to construct saving down time and minimising disturbance
- End bays and tops can be clad with timber facing, to match existing desking, or panelling to your specification



Coniston Library Shelving

Coniston is a high quality range of shelving units, available in a choice of 8 colours, specifically designed to create practical and aesthetically pleasing learning environments.

- All units can be supplied in one colour or a combination, as shown
- Units can also be supplied with castors
- Available as single or double sided units and also starter units and add-on units to create a neat and uniform library area
- Complete with 5 year guarantee

Wood & colour finishes may not be representative of actual colours - please ask for a sample



Lundy Library Units

This range of island book and tray storage is designed to be used with the quadrant storage tray.

Quadrant storage trays are available in red, blue, green or transparent and deep trays are available in a choice of colours – see page 50.

An optional cushion is available to maximise the uses of this range – cushions are available in red, blue, yellow or green fabric or vinyl.



Book/tray storage unit

Y300CT8	1 Tray High W372 x D431 x H660
Y400CT8	2 Trays High W372 x D431 x H840
Y550CT8	3 Trays High W372 x D431 x H1020



Island unit

- Optional cushion available

Y300CT9	1 Tray High W1252 x D1216 x H266
Y400CT9	2 Trays High W1252 x D1216 x H463
Y550CT9	3 Trays High W1252 x D1216 x H661



Book seat storage

- Optional cushion available

Y300CT10	1 Tray High W372 x D1217 x H266
Y400CT10	2 Trays High W372 x D1217 x H463
Y550CT10	3 Trays High W372 x D1217 x H661

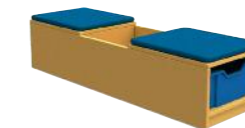

Book & seat storage island

- Optional cushion available

Y300CT11	1 Tray High W1217 x D862 x H660
Y400CT11	2 Trays High W1217 x D862 x H840
Y550CT11	3 Trays High W1217 x D862 x H1020





A



B



C



D



A. Tiered shelf library unit

- In a choice of Beech-BE, or Maple-MP MFC finish
- Dimensions: W760 x D380mm
- 4 tier H780mm, 5 tier H965mm

Y15092	4 Tier Unit	each	£174.40
Y15094	5 Tier Unit	each	£203.00

B. Straight shelf library unit

- In a choice of Beech-BE, or Maple-MP MFC finish
- Dimensions: W1040 x D502mm
- 3 tier H1000mm, 4 tier H1500mm

Y15096	3 Tier Unit	each	£153.00
Y15098	4 Tier Unit	each	£186.00

C. 2 & 3 shelf library units

- Popular double sided Beech units
- 2 shelf unit has 2 angled display shelves each side, and a flat storage shelf
- The 3 shelf unit has 3 flat storage shelves either side
- W1040 x D500 x H850mm

Y15106	2 Shelf Unit	£170.00
Y15114	3 Shelf Unit	£170.00

D. Hanging big book storage unit

- Ideal storage for big books and group readers
- Attractive beech wood finish
- Double hanging rail to accommodate all sizes

YTG01	Hanging Big Book Storage Unit	£333.00
-------	-------------------------------	---------

A. Book spinner

- This smaller version of an adult paperback tower holds 125 books or 60 videos
- The tower and base can be chosen in two different colours to create your own multi-coloured unit
- Please specify the base and tower colours when ordering the coloured book spinner
- Size: W400 x D400 x H1350mm
- Internal slot height: 220mm
- Dimensions for book space between dividers: 115 x 115mm

Y15110	Book Spinner Beech	£268.20
Y15112	Book Spinner Coloured	£291.50

B. Big book holder

- Beech melamine unit stores books vertically in six slots
- Available with castors or as pictured
- W695 x D504 x H600mm

Y15108	Big Book Holder Mobile	£170.00
Y15109	Big Book Holder Static	£170.00

C. 4 legged kinderbox

- Wooden or metal 4 legged frame 4 kinderbox unit
- Boxes available in beech, red, green, yellow or blue finish
- Wooden frame: D620 x W620 x H360mm
- Metal frame: D600 x W600 x H360mm
- Bespoke sizes and shapes available

YBX05W	Wooden Frame Kinderbox	£156.88
YBX05M	Metal Frame Kinderbox	£156.88



A



B



C

Best Seller

5 Year Warranty



Many more fabric options available



Motion

- Distinctly designed modular chair
- Multiple fabrics can be used - ask for prices



YMOT1*	Chair	£224.00
YMOTTS*	Square Table with Oak Top	£129.00
YMOTTG	Motion Square Table with Glass Top	£129.00
YTWOT	Addn. charge for Two Tone Fabrics from Band 1	£29.00

* Please specify fabric colour



Unlimited fabrics available
Prices shown are for Phoenix, Era and Rivet fabrics only - see pages 276-279. Please contact us for prices on other fabrics.

Page Link - see page

Aston Hut seating **237**



Aspect Modular Vinyl Range

- A flexible range of modular seating perfect for libraries and breakout areas
- Fully upholstered modular furniture with deep cushions for comfort
- Matching table with oak look or glass top
- Seat: H400 x W575mm
- Available in: Vinyl band 4

YREC25VV	Chair	£136.00
YREC26VV	Chair Left Arm	£170.00
YREC27VV	Chair Right Arm	£170.00
YREC28VV	Arm Chair	£221.00
YREC29VV	Two Seater Arm Chair	£366.00
YREC31VV	Corner Seat	£203.00
YREC32VV	30 Deg. Internal Link	£159.00
YREC33VV	60 Deg. External Link	£156.00
YREC32LWV	30 Deg. Internal Link With Left Arm	£202.00
YREC32RWV	30 Deg. Internal Link With Right Arm	£202.00
YREC33LWV	60 Deg. External Link With Left Arm	£200.00
YREC33RWV	60 Deg. External Link With Right Arm	£200.00
YREC04VV	Vinyl Oak Top Table	£107.00
YREC04GV	Vinyl Glass Top Table	£131.00

Please specify fabric colour

Oasis

- Comfortable modular seating
- Optional back 530mm extension
- Endless configurations

More from this range on pages 228-229

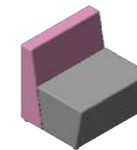

Single seater straight unit

Y600110	Single Seater	£498.00
Y600115	Single Seater Back Extension	£265.00



2 seater straight unit

Y600120	2 Seater	£599.00
Y600125	2 Seater Back Extension	£282.00



3 seater straight unit

Y600130	3 Seater	£710.00
Y600135	3 Seater Back Extension	£327.00



Corner unit

Y600140	Corner Unit	£578.00
Y600145	Corner Unit Back Extension	£447.00



T module unit

Y600150	T Module Unit	£761.00
Y600155	T Module Unit Back Extension	£516.00

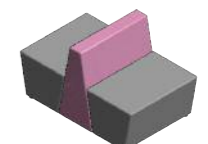

Back to back single seater

Y600160	Back to Back Single Seater	£713.00
Y600165	Back Extension	£344.00

Whisper



A. YWHIS1	Whisper Straight High Back Seat Unit	£745.00
B. YWHIS2	Whisper 45 Degree Concave High Back Seat Unit	£845.00
C. YWHIS3	Whisper 45 Degree Convex High Back Seat Unit	£775.00



Unlimited fabrics available
Prices shown are for Era, Phoenix, Rivet & X2 - see pages 276-279. Please contact us for prices on other fabrics.



5 Year Warranty

Best Seller

Readingzone



- Ideal for library areas, receptions, common rooms, in fact they fit anywhere!
- Seat height 440mm
- Please call for bulk discounts



Unlimited fabrics available
Prices shown are for Phoenix, Era and Rivet fabrics only - see pages 276-279. Please contact us for prices on other fabrics.



Round Stool

YSTYROF*	Fabric	£180.00
YSTYROV*	Vinyl	£191.00

Square Stool

YSTYSQF*	Fabric	£186.00
YSTYSQV*	Vinyl	£197.00

Two Seater Bench

YSTY2F*	Fabric	£244.00
YSTY2V*	Vinyl	£260.00

Three Seater Bench

YSTY3F*	Fabric	£290.00
YSTY3V*	Vinyl	£308.00

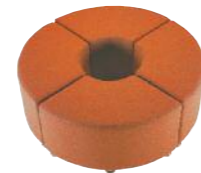

Oval Stool

YSTYOVF*	Fabric	£227.00
YSTYOVV*	Vinyl	£245.00

Wedge Stool

YSTYWGF*	Fabric	£192.00
YSTYWGV*	Vinyl	£204.00

Quadrant Stool

YSTYQUF*	Fabric	£241.00
YSTYQUV*	Vinyl	£260.00

Tangent Stool

YSTYTGF*	Fabric	£319.05
YSTYTGv*	Vinyl	£340.95

Page Link - see page
Early Years Versions 125



Page Link - see page
View more styles... 239



For seat dimensions see pages 266-269



Stone Stool

YSTYSSF*	Fabric	£660.00
YSTYSSV*	Vinyl	£640.00



Large Island Stool

YSTYISF*	Fabric	£1326.90
YSTYISV*	Vinyl	£1423.00

Causeway

- These irregular hexagonal form seats are available in two heights that serve as both sitting and backrest units
- Can be freely combined in infinite arrangements
- Ideal for chillout zones, waiting areas and entrance halls
- Connected with black, powder coated metal links

YCWAYHU	High Unit (750mm)	POA
YCWAYLU	Low Unit (450mm)	POA



Bean bags

- Perfect for indoor as well as outdoor use, this versatile bean bag is great for relaxed learning environments
- Tough wipe-clean waterproof fabric makes it perfect for outdoor reading
- Available in a range of bright colours
- Other fabric options available including pastel colours, quilted, fur and suede

Y400900	Mini Relax Pod H740 x W740 x L710mm	£59.99
Y400901	Mighty Relax Pod H800 x W990 x L940mm	£95.99
Y400902	Maxi Relax Pod H940 x W1160 x L800mm	£145.99



Made from waterproof material

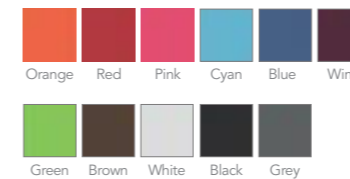

New Product



Retreat

Retreat is a range of acoustic work areas created to make open spaces private.

With numerous styles, configurations and a full range of accessories, Retreat can be used in many different environments.

Please contact us for more details and ask about our planning and design services.



Retreat - Booth



Retreat - Cube



Retreat - Honeycomb



Retreat - Curve



Retreat - Dining



Hive

The Hive range nestles and tessellates to optimise available space, allowing the creation of an agile and flexible work space. Perfect for encouraging self-directed learning amongst students, the Hive pods create a quiet space amongst the bustle ensuring optimum productivity.

Please call for more information



Raft high back

A highly versatile modular seating system, the Raft High Back range combines pleasing aesthetics with acoustic properties to create a practical and affordable learning environment solution.

See pricing and more of the range on page 231

See page 231 for the full Raft high back range

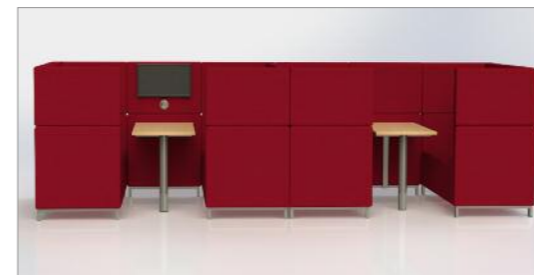



It's time for the curtain to go up....
 ...but is your staging & seating adequate for the performance?
 We can provide staging ideas that not only meet your drama & music requirements
 but also your hall storage issues.

Staging & Auditorium Seating

Easi-build	200-201
Alu Lite	202
Easi-fold	203
Alu Rapid	204-205
Auditorium Seating	207

Staging & Auditorium Seating

All children love being 'on stage' at some point in their life, whether it be for a school performance, a presentation, or just to receive a reward. It can give them a real sense of achievement and a boost to their morale, but being in an audience that can't see the action, can be very frustrating.

Is your staging adequate enough to give both performers and audience the satisfaction they deserve? Our range of staging and auditorium seating can help you achieve this by elevating the pupils or having tiered seating for the audience. Please contact us for the best solution for you.





Easi-Build Staging



Storage is very compact and totally mobile

Creating amazing performance spaces...

- The Easi-Build staging offers total versatility combined with an unparalleled speed of assembly
- A large stage can be set up in minutes and is light enough to be done by one person
- Storage is excellent with a stage 3m x 4.5m storing on a one metre square storage trolley
- The Easi-Build staging system is purposely designed to be modular allowing your stage to be set up in many different ways
- It is so hassle-free to adjust, you will find you will get the most out of the stage by trying different layouts and options
- Use it as a flat, split or multi-level stage, a tiered layout for audiences & choirs, podia, display units, the basis for creative play - the possibilities are endless
- No clips or fixings needed
- Deck panels are produced with an acrylic lacquered birch plywood
- Fascia & deck panels can be produced in a range of other finishes or carpeted to help acoustics



- Steps simply hook on to the frame rails
- Single or multiple treads are available to suit heights
- Handrails have either vertical or horizontal fill-in bars and simply slot into frames or steps
- Backdrapes and skirtings are available in 6 standard colours



We strongly recommend a site visit before you order your stage to ensure your requirements are met in the most flexible and cost effective way

Easi-Build Staging



Staging Package Kits – designed to make full use of your available space, each stage can be built in various configurations then stored away easily. Units are w750mm x d750mm.



Package kit A

- 8 x h500mm units
- 4 x 277.5mm units
- 4 x 277.5mm frames
- 1 x dolly
- 1 x twin tread steps
- Tie plates
- Size: 2.25m x 3m

Y32000 £2,317.00

2018
Prices held

15 Year
Warranty



Package kit B

- 12 x h500mm units
- 6 x 277.5mm units
- 6 x 277.5mm frames
- 1 x dolly
- 2 x twin tread steps
- Tie plates
- Size: 2.25m x 4.5m

Y32005 £3,295.00

2018
Prices held

15 Year
Warranty



Package kit C

- 18 x h500mm units
- 6 x 277.5mm units
- 6 x 277.5mm frames
- 2 x dollies
- 2 x twin tread steps
- Tie plates
- Size: 3m x 4.5m

Y32010 £4,469.00

2018
Prices held

15 Year
Warranty



Alu Lite Staging



- Alu-lite is an extremely lightweight staging solution that is particularly suited to primary schools. Specially designed to take up minimal space and with a rigid bracing system, this is a stage that will withstand heavy loading yet is still so light that even the children could assemble it!
- Fast and efficient to assemble, the base opens in seconds to provide a surface rated at 1000kg even load distribution, yet

folds to just 2% of the open size when closed!

- A wide range of sizes and formats are available to ensure you have just the right stage, and our experienced personnel will visit to discuss your needs and provide a free demonstration
- Various Storage Trolleys can be selected to suit the doorway size for easy storage, and a whole range of extras from handrails to curtains are available for quick delivery



Easi-Fold Staging

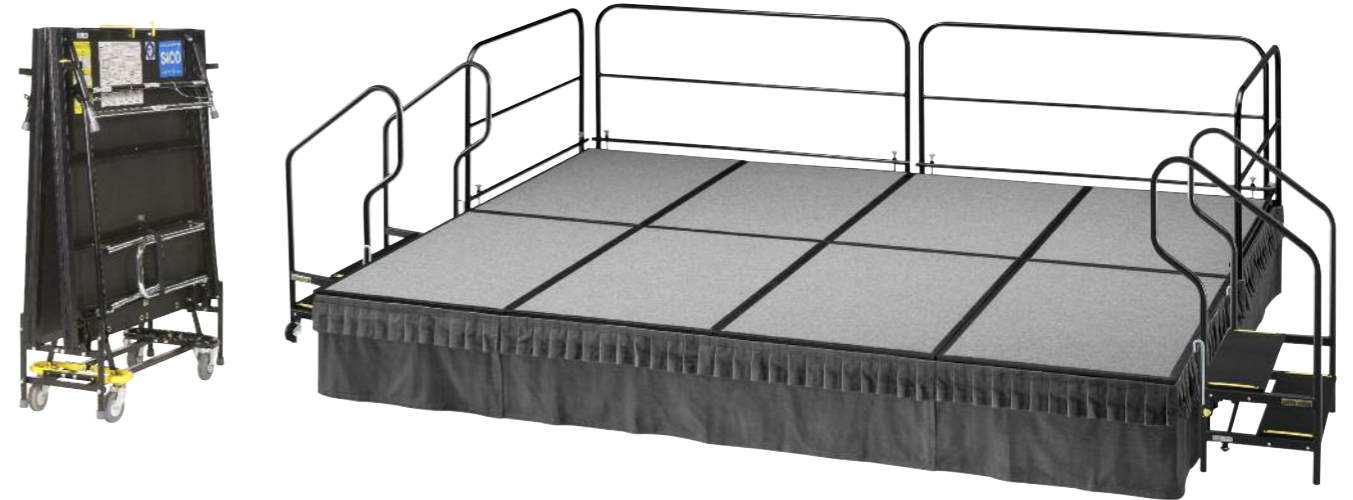

Please ask for site visit and demonstration

- The quickest stage to set out and pack away
- A self-storing unit requiring single set up - a great labour saver
- Single or dual height units available in 3 different deck sizes
- Each unit rolls freely on its own four wheels – the added advantage of being able to be used in different rooms
- When in use, it rests on 8 direct-to-floor load bearing legs that stabilise the stage
- Stage accessories available including steps, hand rails, stage skirting, ramps etc
- Various package options available which include stage decks and steps – please ask for details
- Direct delivery and onsite training within 4 weeks
- Available as standard in black tuff deck vinyl or grey cord carpet. Other colours available on request

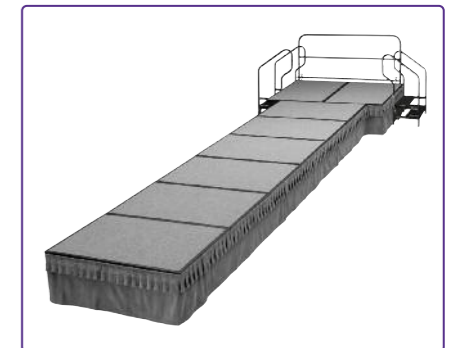



Alu Rapid Staging



- The Alu Rapid staging range is a professionally designed and developed system that has been tried and tested – worldwide
- Stage platforms are simple to set up and take down in a very short time. The modular



- platforms allow the stage to be reconfigured into different layouts and different heights using the detached leg options
- Adaptable to many applications
- Lightweight and easy to assemble



- Compact for ease of storage
- Designed to eliminate clatter and stage squeak
- High quality design for long-term investment
- Special shape decks made to order
- Lifetime warranty



Rapid

- Our most popular range for schools
- Easy to assemble, quiet in use
- Lightweight yet rigid and strong
- Compact for storage
- Virtually any shape, size, or height available



1 x 1 metre

- Ideal where ease of handling is the main priority or storage space is at a premium

2 x 1 metre

- The quickest and most cost effective way to assemble and store a stage



Combi

- 2 x 1m standard size
- Multi-level deck with integrated scissor action legs
- Standard heights of 200, 400, 600, 800 & 1000mm

Best Seller



Assembly stages



Alu Rapid Staging

LIFETIME
Warranty

Free design & demonstration service



We strongly recommend a site visit before you order your stage to be certain your requirements are met in the most flexible and cost effective way.

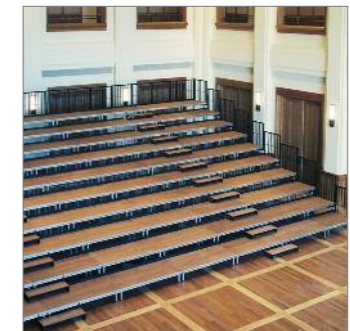

Tiering for audience applications

Stage accessories



Handrails Standard and Infilled



Chair holding border - Edge stop for tiered decks



Steps - Multi-height system steps with anti-slip surface



Transport Kit - You can store 40m² of staging in 2m² of floorspace

Stage surface finishes

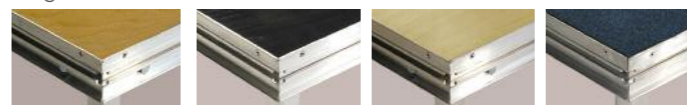

Standard brown

Standard black

Clear hardwood veneer

Inlaid carpet choice of colour

Stage edging

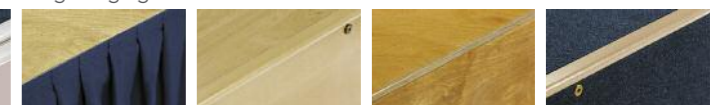

Valance - choice of colour

Hardwood fascias - Standard plywood lacquered as standard

Standard plywood

Carpeted - choice of colour

Alu rapid studio stage

The 'little' stage for your 'big' event.



LIFETIME
Warranty



Alu Rapid Studio Stage offers a complete package solution. It includes 4 x 4m Alu Rapid Stage and lightweight, easy to assemble theatre curtain system. Ideal for school halls and drama departments. Sizes and colours can be individually tailored to suit every situation.

Please call for more information.

Assembly as simple as 1, 2, 3



Auditorium Seating

A wide range of high quality seating systems offering solutions to suit every budget are available with an unrivalled Lifetime Warranty. Tried and tested to FIRA level 4 'severe category use', the systems are installed nationwide and further afield into universities, schools, courtrooms, theatres, town halls, sports centres and conference venues etc...

Product categories:-

- Auditorium Seating
- Lecture Theatre Seating
- Bench Seating
- Bench Seating
- Conference seating
- Demountable seating Systems
- Structural Steel & Timber Tiers Systems

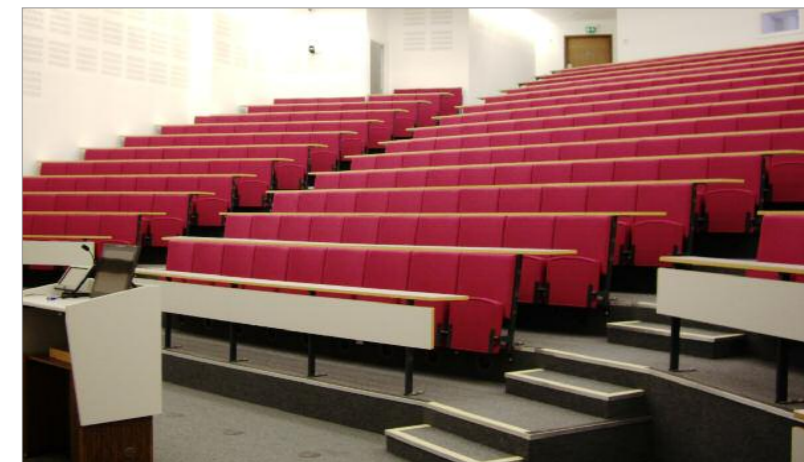

Please call
for more
information





Are you and your visitors sitting comfortably?

Whether it's Office and Reception chairs, Sixth Form and Breakout seating or Conference seating and IT chairs – they're all tried and tested, comfortable and robust.

Seating

Soft Seating For Libraries, Staffrooms, Receptions, 6th Forms, Breakout	212-239
Coffee Tables	240-241
Operator Seating	242-247
Task Seating	248-251
Executive Seating	252-253
Ergonomic Back Care Seating	254-255
Conference & Cafe Seating	256-269
Executive Conference Seating	270-271
Seating Size Guide	272-275
Fabric Swatches	276-279

Seating

When you buy seating, you are buying comfort.

We understand that work demands long hours of sitting and the chair sat on will make an impact not only on the quality of work delivered and students results, but also on users health.

All our seating ranges are selected for their excellent fit into learning environments, and our soft seating and reception ranges are designed to inspire and invigorate staff, visitors, and students alike.

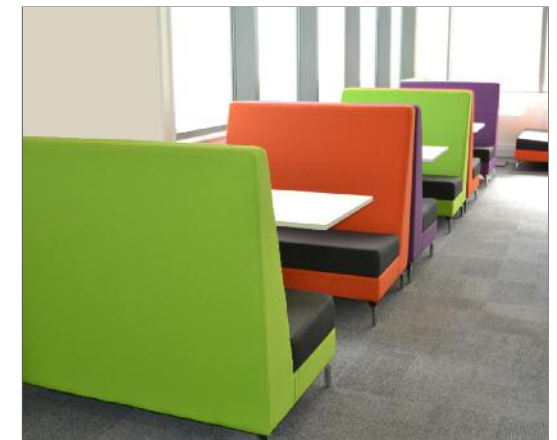

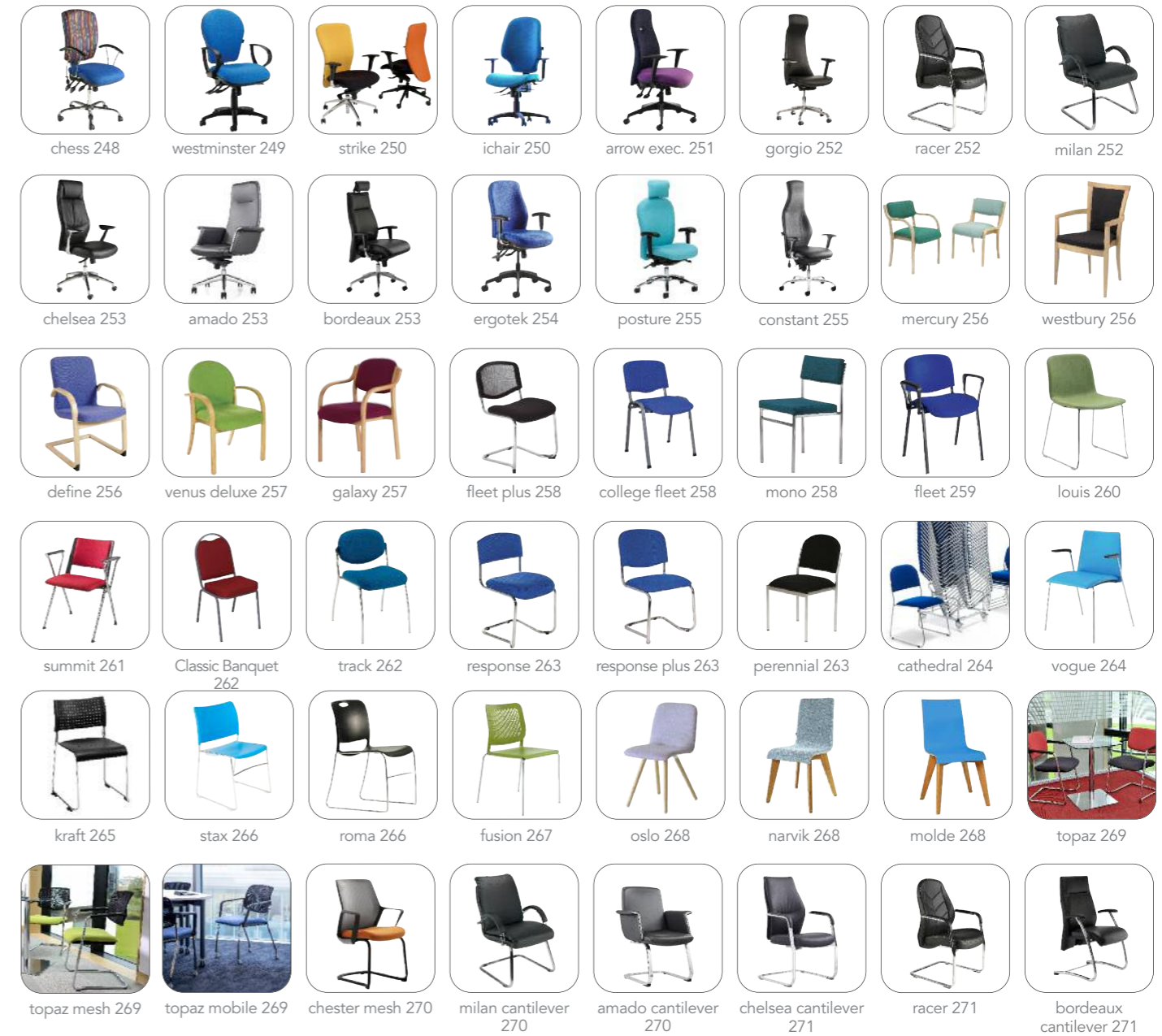
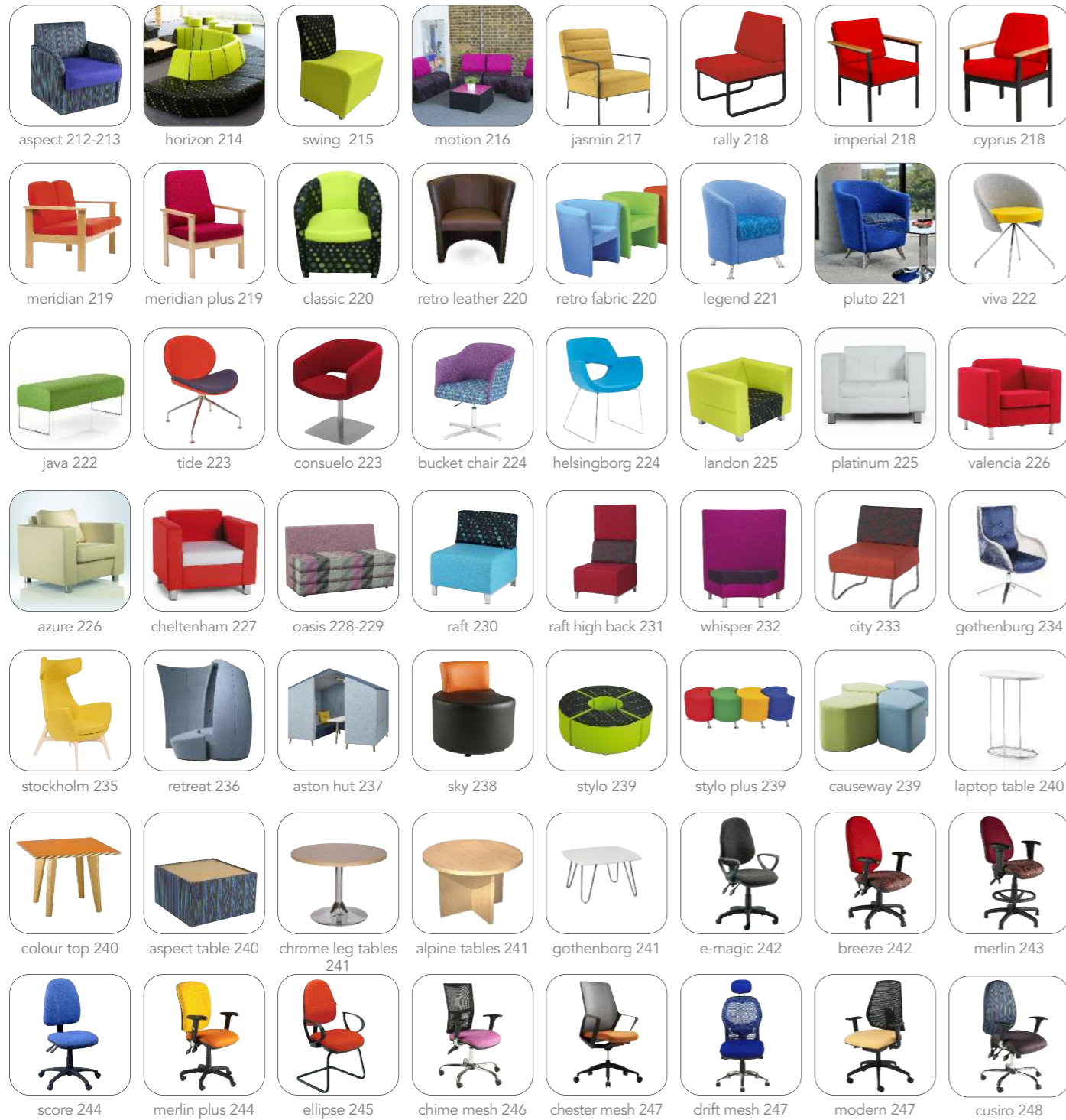

Quick search
product guide

Best Seller

Express Delivery

5 Year Warranty

Reception & Staffroom Seating

Aspect modular reception



- A flexible range of modular seating with wide range of arm choices
- Fully upholstered modular furniture with deep filled cushions for comfort
- Matching table with oak look or glass top



Note: This product is shown in non standard fabrics. Please call for prices.



A. Chair - No Arms



B. Chair - Left Arm



C. Chair - Right Arm



D. Armchair



E. 2 Seater Sofa



F. Corner Unit



G. 30° Internal Link



H. 60° External Link



I. Oak Top Table

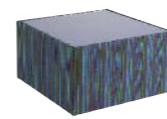

J. Glass Top Table

Reception & Staffroom Seating



Aspect Modular Reception

A. YREC25W*	Chair - No Arms	£129.00	YREC32RW*	30° Internal Link With Right Arm	£189.00
B. YREC26W*	Chair - Left Arm	£164.00	YREC33LW*	60° External Link With Left Arm	£187.00
C. YREC27W*	Chair - Right Arms	£164.00	YREC33RW*	60° External Link With Right Arm	£187.00
D. YREC28W*	Armchair	£206.00	I. YREC04W*	Oak Top Table	£105.00
E. YREC29W*	2 Seater Sofa with Arms	£359.00	J. YREC04G*	Glass Top Table	£115.00
F. YREC31W*	Corner Unit	£213.00	YTWOT	Extra Charge for 2-Tone Fabrics from Band 1	£29.00
G. YREC32W*	30° Internal Link	£159.00			
H. YREC33W*	60° External Link	£158.00			
YREC32LW*	30° Internal Link With Left Arm	£189.00			

* Please specify fabric colour

For seat dimensions see pages 272-275



Non standard fabric shown - please call for prices

For seat dimensions see pages 272-275



YHOR01 YHOR01LA YHOR01RA YHORA YHOR02 YHOR03 YHORCFB

Reception & Staffroom Seating

Horizon

- Comfortable angled seat



YHOR01	Horizon Modular Chair	£206.00
YHOR01LA	Horizon Modular Chair w/Left Arm	£289.00
YHOR01RA	Horizon Modular Chair w/Right Arm	£289.00
YHORA	Horizon Modular Armchair	£379.00
YHOR02	Horizon Modular 30 Degree Outer Corner Segment	£193.00
YHOR03	Horizon Modular 30 Degree Inner Corner Segment	£193.00
YHORCBE	Horizon Coffee Table, Beech Top	£182.00
YHORCMA	Horizon Coffee Table, Maple Top	£182.00
YHORCOA	Horizon Coffee Table, Oak Top	£182.00
YHORCFB	Horizon Coffee Table, Fabric Top	£182.00



Unlimited fabrics available
Prices shown are for Era, Phoenix, Rivet & X2 - see pages 276-278. Please contact us for prices on other fabrics.



Reception & Staffroom Seating



Image shows Aspect coffee table

Swing

- Modern yet cost effective modular chair
- Shapely back available in contrasting fabric to seat (at additional cost)
- Chrome feet
- Modular design for increased flexibility



YSWI1	Modular Chair	£217.00
YSWI1A	Swing Chair with Arms	£297.00
YSWIT	Modular Table with Oak Top	£196.00
YTWOT	Extra Charge for 2-Tone Fabrics from Band 1	£29.00

* Please specify fabric colour



Unlimited fabrics available
Prices shown are for Era, Phoenix, Rivet & X2 - see pages 276-278. Please contact us for prices on other fabrics.



Non standard fabric shown - please call for prices

For seat dimensions see pages 272-275

Best Seller

5 Year Warranty



Shown with optional extra arms
- please enquire for details

For seat dimensions
see pages 272-275

Reception & Staffroom Seating

Motion

- Distinctly designed modular chair
- Multiple fabrics can be used - ask for prices



YMOT1*	Chair	£224.00
YMOTTS*	Square Table with Oak Top	£129.00
YMOTTG	Motion Square Table with Glass Top	£129.00
YMOTTLA	Chair with Left Arm	£313.00
YMOTTRA	Chair with Right Arm	£313.00
YMOTTA	Armchair	£399.00
YTWOT	Extra Charge for Two Tone Fabrics from Band 1	£29.00

* Please specify fabric colour



Unlimited fabrics available

Prices shown are for Era, Phoenix, Rivet & X2 - see pages 276-278. Please contact us for prices on other fabrics.

Reception & Staffroom Seating

New Product



Jasmin

- Contemporary lounge chair with comfortable chunky seat
- In style frame
- Available in three fabric colours: - Mustard, Grey & Blue

YJASMU	Mustard	£171.00
YJASBL	Blue	£171.00
YJASGR	Grey	£171.00

For seat dimensions
see pages 272-275

15 Year
Maker's
GuaranteeBest
SellerFor seat dimensions
see pages 272-275

Reception & Staffroom Seating

A. Rally

- Excellent for staffrooms, common rooms & heavy use areas
- Extra heavy duty skid base reception chair
- Extra deep foam padding for extra comfort
- Black frame as standard, silver and grey available to order (price on request)



	1-9	10+
YRALI* Side Chair	£129.00	£115.00

* Please specify fabric colour

B. Imperial

- Extremely durable range of chairs
- Extra deep foam padding
- Black frame as standard, silver and grey available to order (price on request)



YIMP1* Side Chair	£113.00
YIMPA* Armchair	£155.00

* Please specify fabric colour

C. Cyprus

- Robust, rectangular steel frame
- Epoxy polyester frame coating
- Top grade, extra deep contour foam
- Highly polished, solid beech arms
- Complementary Beech laminate table tops
- Optional frame colours available (minimum order quantity of 10)



YCC50* Chair	£205.00
YCC55* Armchair	£243.00
YCC255* 2 Seater Armchair	£437.00

YCC20 Square Coffee Table	£169.00
YCC30 Rectangular Coffee Table	£204.00

YCRAL7 Optional Grey Frame (min 10 items)	+£12.00
YCRAL9 Optional Silver Frame (min 10 items)	+£12.00
YCRAPF Cyprus Optional Platinum Frame	+£13.00

* Please specify fabric colour



Unlimited fabrics available
Prices shown are for Era, Phoenix, Rivet & X2 - see pages 276-278.
Please contact us for prices on other fabrics.

Reception & Staffroom Seating

Meridian

- Low level beech framed seating
- 5 year guarantee
- No assembly required
- Flame retardant foam



YMER1A Low Back Beech Chair	£206.00
YMER1AA Low Back Beech Armchair	£219.00
YMER1RA Low Back Beech Chair with Right Arm	£209.00
YMER1LA Low Back Beech Chair with Left Arm	£209.00
YMER2AA Low Back Beech Two Seater Settee with Arms	£406.00
YMER1M Medium Back Beech Chair	£225.00
YMER1MA Medium Back Beech Armchair	£234.00
YMER1MRA Medium Back Beech Chair with Right Arm	£228.00
YMER1MLA Medium Back Beech Chair with Left Arm	£228.00
YMER2MA Medium Back Beech Two Seater Settee with Arms	£439.00
YMER1H High Back Beech Chair	£231.00
YMER1HA High Back Beech Armchair	£249.00
YMERSTA Beech Square Table	£149.00
YMERRTA Beech Rectangular Table	£219.00

* Please specify fabric colour



Unlimited fabrics available
Prices shown are for Era, Phoenix, Rivet & X2 - see pages 276-278.
Please contact us for prices on other fabrics.

Meridian plus

- Hardwood frames from sustainable sources
- Comfortable shaped back
- Mortice and tenon joints
- Flame retardant foam seats
- Modular design
- Manufactured in the UK
- 5 year guarantee



YMERPL Meridian Plus Low Back	£263.00
YMERPLA Meridian Plus Low Back with Arms	£292.00
YMERPH Meridian Plus High Back	£284.00
YMERPHA Meridian Plus High Back with Arms	£314.00

* Please specify fabric colour

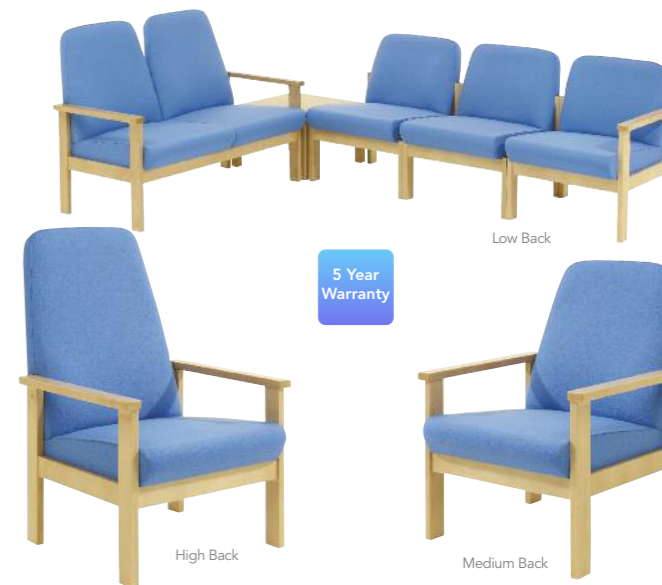

Unlimited fabrics available
Prices shown are for Era, Phoenix, Rivet & X2 - see pages 276-278.
Please contact us for prices on other fabrics.

5 Year
Warranty

Page Link - see pageS

For all
dimensions 272-275For seat dimensions
see pages 272-275

5 Year
Warranty

Non standard fabric shown - please call for prices

Best
Seller5 Year
Warranty

Reception & Staffroom Seating

Classic tub chair & table



- Ideal for informal meeting points

YREC11*	Tub Chair	£251.00
YREC20*	Tub Sofa	£399.00

YREC12W*	Tub Wood Top Table	£159.00
YREC12G*	Tub Glass Top Table	£157.00
YTWOT	Extra Charge for 2-Tone Fabrics from Band 1	£29.00

* Please specify fabric colour



Unlimited fabrics available

Prices shown are for Era, Phoenix, Rivet & X2 - see pages 276-278. Please contact us for prices on other fabrics.

Retro leather tub

- Ideal for head teachers office or reception
- Sturdy and comfortable
- Faced in split leather in Black or Chocolate
- Other colours available to order

YREC10BK	Retro Tub Chair Black	£224.00
YREC10CH	Retro Tub Chair Chocolate	£260.00
YREC102BK	Retro Tub 2 Seater Black	£342.00
YREC102CH	Retro Tub 2 Seater Chocolate	£342.00

For seat dimensions
see pages 272-275

Retro fabric tub chairs

- Ideal for reception or Break Out Areas
- Available in Single or Double Seater
- Black Feet Glides
- 5 year warranty
- Made in the UK



Y600100	Single Tub	£214.00
Y600102	Double Tub	£334.00

For seat dimensions
see pages 272-275

Reception & Staffroom Seating

Legend

- Sturdily built chair
- Attractive beech wood or chrome feet
- Deep, fibre-topped seat cushions



Beech Feet

YLEG1B*	Tub Chair	£394.00
YLEG2B*	2 Seater	£588.00

Chrome Feet

YLEG1C*	Tub Chair	£469.00
YLEG2C*	2 Seater	£663.00

* Please specify fabric colour



Unlimited fabrics available

Prices shown are for Era, Phoenix, Rivet & X2 - see pages 276-278. Please contact us for prices on other fabrics.

Non standard fabric shown
- please call for prices

Pluto

- Compact stylish tub chair
- Modern chrome feet
- 2-tone fabric at no extra cost
- Ideal for areas with limited space
- Seat height 440mm, width 650mm overall
- Combining a generously proportioned seat with a compact overall footprint.
- Two foot styles, comes as standard with ball foot, please specify if non standard option is preferred

YPSL1	Pluto Compact Tub Chair	£419.00
-------	-------------------------	---------

* Please specify fabric colour



Unlimited fabrics available

Prices shown are for Era, Phoenix, Rivet & X2 - see pages 276-278. Please contact us for prices on other fabrics.

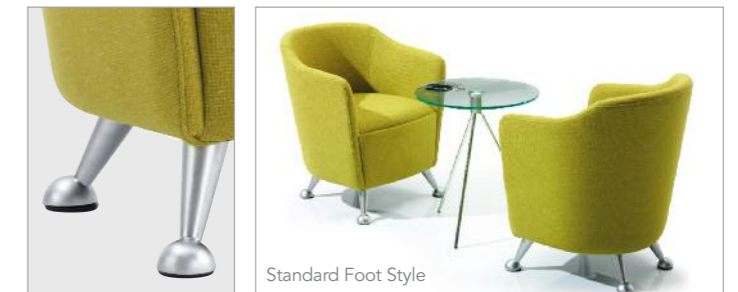

Standard Foot Style



Special Foot Style

5 Year Warranty



For seat dimensions see pages 272-275



Reception & Staffroom Seating

Viva



A. YVIV01	Viva Tub Chair with 4 Angled Chrome Legs	£297.00
B. YVIV02	Viva Tub Chair with 4 Curved Chrome Legs	£297.00

Colour Options Unlimited fabrics available
 Prices shown are for Era, Phoenix, Rivet & X2 - see pages 276-278. Please contact us for prices on other fabrics.



Java

- Beautifully simple
- Modular design means that Java looks good as a single bench or as a large configuration to dramatically fill an atrium
- Chrome legs

A. YJAVA01	1200 Bench Unit	£389.00
B. YJAVAST	Square Connecting Table	£149.00
C. YJAVA	Table	£277.00
YJAVLNK	Linking Device	£6.00

Colour Options Unlimited fabrics available
 Prices shown are for Era, Phoenix, Rivet & X2 - see pages 276-278. Please contact us for prices on other fabrics.

Reception & Staffroom Seating

Tide



- Modern visitor and reception chair
- Generously sized bucket seat

YTIG1*	Chair with 4 Legs	£378.00
YTIG2*	Chair with Skid Base	£378.00
YTIG3*	Chair with 4-Legged Return Swivel	£418.00
YTIG4	Chair with Cross Over Skid Base	£378.00
YTIG5	Coffee Table	£249.00

* Please specify fabric colour

Colour Options Unlimited fabrics available
 Prices shown are for Era, Phoenix, Rivet & X2 - see pages 276-278. Please contact us for prices on other fabrics.



5 Year Warranty

For seat dimensions see pages 272-275

Consuelo



- Stylish visitor chair
- 4 base styles with platinum finish

A. YCON1	Visitor Seat with Pedestal Base	£398.00
B. YCON2	Visitor Seat with Spider Base	£378.00
C. YCON3	Visitor Seat with 4 Leg Base	£338.00
D. YCON4	Visitor Seat with Skid Base	£338.00

* Please specify fabric colour

Colour Options Unlimited fabrics available
 Prices shown are for Era, Phoenix, Rivet & X2 - see pages 276-278. Please contact us for prices on other fabrics.



New Product

Non standard fabric shown
- please call for pricesFor seat dimensions
see pages 272-275

Reception & Staffroom Seating

Bucket chair

- Solid shell chair
- Comfortable, deep cushions
- Compact footprint

A. Y606300	Chair w/Platinum Cantilever Frame	£303.00
B. Y606301	Chair w/Wooden Black Legs	£328.00
Y606302	Chair w/Polished Beech Legs	£328.00
C. Y606303	Chair w/Star Base, Height Adjustable	£345.00



Unlimited fabrics available

Prices shown are for Era, Phoenix, Rivet & X2 - see pages 276-278.
Please contact us for prices on other fabrics.

New Product



Helsingborg

- Comfortable designer look chair, adding style to any environment
- Available in chrome skid base, wooden frame or metal swivel base

A. Y607200	Chrome Skid Base Chair	£478.00
B. Y607201	Wood Frame Chair	£536.00
C. Y607202	Swivel Chair	£544.00



Unlimited fabrics available

Prices shown are for Era, Phoenix, Rivet & X2 - see pages 276-278.
Please contact us for prices on other fabrics.

Reception & Staffroom Seating

Landon



- Contemporary design
- Stylish detailing
- Deep foam for added comfort

YML011*	Landon Armchair	£715.00
YML012*	Landon 2 Seater Sofa	£875.00

* Please specify fabric colour



Unlimited fabrics available

Prices shown are for Era, Phoenix, Rivet & X2 - see pages 276-278.
Please contact us for prices on other fabrics.Non standard fabric shown -
please call for prices10 Year
Structural
Warranty

Platinum

- A classic design with exceptional build quality
- Enhances any environment whether it is commercial or domestic

YPLA001	Platinum Armchair	£599.00
YPLA002	Platinum 2 Seater Sofa	£699.00



Unlimited fabrics available

Prices shown are for Era, Phoenix, Rivet & X2 - see pages 276-278.
Please contact us for prices on other fabrics.



Cushion pictured in non standard fabric - please call for prices



Reception & Staffroom Seating

Valencia

- Designed with striking square lines, deep fill cushions and a choice of legs
- Comes with chrome legs as standard, Beech and Walnut also available, please ask
- UK made



YVAL01	Valencia Armchair	each	£629.00
YVAL02	Valencia 2 Seat Sofa	each	£1039.00
YVAL03	Valencia 3 Seat Sofa	each	£1379.00
YVALC	Square Cushion, 400 x 400mm	each	£80.00

Colour Options Unlimited fabrics available
 Prices shown are for Era, Phoenix, Rivet & X2 - see pages 276-278.
 Please contact us for prices on other fabrics.

10 Year Warranty



Azure

- Contemporary sofa range
- Chrome feet as standard, wood available
- Please call for prices for this range in leather as shown
- Seat width 930mm, depth 920mm



YAZU001*	1 Seater	£629.00
YAZU002*	2 Seater	£829.00
YAZU003*	3 Seater	£1029.00

* Please specify fabric colour

Colour Options Unlimited fabrics available
 Prices shown are for Era, Phoenix, Rivet & X2 - see pages 276-278.
 Please contact us for prices on other fabrics.

For seat dimensions see pages 272-275

Reception & Staffroom Seating

Cheltenham

- Brilliant cost effective sofa range
- Modern aesthetic design
- Ideal for reception areas and common rooms
- Seat width 830mm, depth 730mm



Fabric

YSA001F*	Armchair Fabric	£440.00
YSA002F*	2 Seater Fabric	£580.00
YSA003F*	3 Seater Fabric	£730.00

Leather

YSA001L*	Armchair Leather	£1100.00
YSA002L*	2 Seater Leather	£1300.00
YSA003L*	3 Seater Leather	£1500.00

* Please specify fabric colour



5 Year Warranty

Attractive chrome feet



Robust build



Colour Options Unlimited fabrics available
 Prices shown are for Era, Phoenix, Rivet & X2 - see pages 276-278.
 Please contact us for prices on other fabrics.

For seat dimensions see pages 272-275

Reception & Staffroom Seating



Please note that back extensions cannot be retrospectively fitted

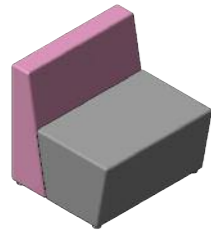

Single seater straight unit



2 seater straight unit



3 seater straight unit



Corner unit



T module unit

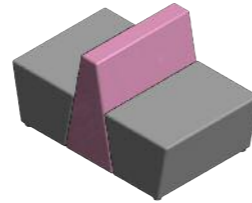

Back to back single seater

Y600110	Single Seater	£498.00
Y600115	Single Seater Back Extension	£265.00

Y600120	2 Seater	£599.00
Y600125	2 Seater Back Extension	£282.00

Y600130	3 Seater	£710.00
Y600135	3 Seater Back Extension	£327.00

Y600140	Corner Unit	£578.00
Y600145	Corner Unit Back Extension	£447.00

Y600150	T Module Unit	£761.00
Y600155	T Module Unit Back Extension	£516.00

Y600160	Back to Back Single Seater	£713.00
Y600165	Back Extension	£344.00

Reception & Staffroom Seating



Oasis

- Comfortable modular seating
- Optional back 530mm extension
- Endless configurations

Please note that back extensions cannot be retrospectively fitted



Back to back double seater

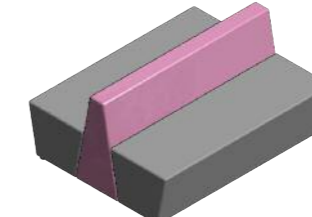

Back to back triple seater



45 degree concave

Y600170	Back to Back Double Seater	£872.00
Y600175	Back Extension	£388.00

Y600180	Back to Back Triple Seater	£1012.00
Y600185	Back Extension	£447.00

Y600190	45 Degree Concave Unit	£685.00
Y600195	Back Extension	£429.00

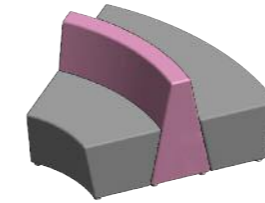

45 degree back to back curved unit



D end unit

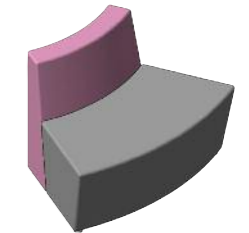

45 Degree convex unit

Y600200	Back to Back Curved Unit	£982.00
Y600205	Back Extension	£429.00

Y600210	D End Unit	£406.00
---------	------------	---------

Y600220	45 Degree Convex Unit	£672.00
Y600225	Back Extension	£407.00

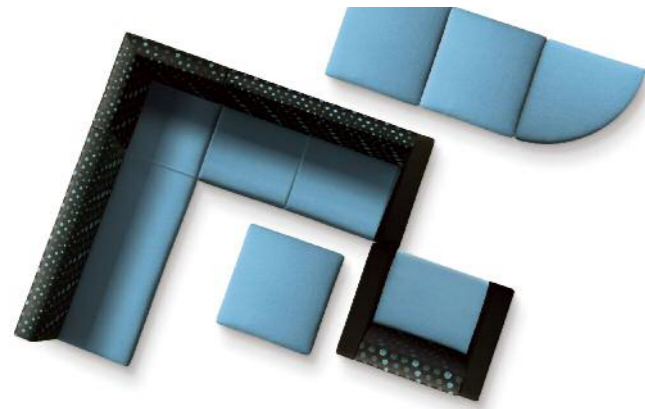

Reception & Staffroom Seating

Raft

- Highly versatile modular seating system
- Many configurations can be created
- Solid Beech wood frames
- Sprung seat

A.	YRAF1	Single Base Unit	£227.00
B.	YRAF1B	Single Base Unit w/Back	£311.00
C.	YRAF1BR	Single Unit w/Back & Right Arm	£421.00
D.	YRAF1BL	Single Unit w/Back & Left Arm	£421.00
E.	YRAF1BA	Single Unit w/Back & Two Arms	£530.00
F.	YRAF1CB	Single Unit w/Corner Back	£465.00
G.	YRAF2	Double Base Unit	£367.00
H.	YRAF2B	Double Unit w/Back	£493.00
I.	YRAF2BR	Double Unit w/Back & Right Arm	£602.00
J.	YRAF2BL	Double Unit w/Back & Left Arm	£602.00
K.	YRAF2BA	Double Unit w/Back & Two Arms	£711.00
L.	YRAF3	Quadrant Base Unit	£290.00
M.	YRAFT	Table with Beech Top	£254.00

Colour Options Unlimited fabrics available
 Prices shown are for Era, Phoenix, Rivet & X2 - see pages 276-278.
 Please contact us for prices on other fabrics.

For seat dimensions see pages 272-275



Reception & Staffroom Seating

Raft high back

- Highly versatile modular seating system
- Many configurations can be created
- Solid Beech wood frames
- Sprung seat

A.	YRAFH1	Single Unit, High Back	£538.00
B.	YRAFH1R	Single Unit, High Back & Right Side	£789.00
C.	YRAFH1L	Single Unit, High Back & Left Side	£789.00
D.	YRAFH1S	Single Unit, High Back & Sides	£1041.00
E.	YRAFH2	Double Unit, High Back	£827.00
F.	YRAFH2R	Double Unit, High Back & Right Side	£1079.00
G.	YRAFH2L	Double Unit, High Back & Left Side	£1079.00
H.	YRAFH2S	Double Unit, High Back & Sides	£1330.00
I.	YRAFHCV	Concave Unit, High Back	£966.00
J.	YRAFHCV	Convex Unit, High Back	£901.00
K.	YRAFHCV	High Back Unit, Corner Back	£799.00
L.	YRAFHV	Vertical Unit (includes Links)	£364.00
M.	YRAFHVT	Vertical Unit, Single Width Table	£619.00
N.	YRAFHDT	Vertical Unit, Double Width Table	£670.00

Options

O.	YRAFCL	Option - Chrome Legs	+£54.00
P.	YRAFBL	Option - Beech Legs	+£54.00
Q.	YRAFLNK	Option - Linking kit (one side)	+£26.00
R.	YRAFPM1	Option - Power Module 1, Power & Twin USB Fast Charge	+£255.00
S.	YRAFPM2	Option - Power Module 2, HDMI & Single USB Fast Charge	+£339.00

Colour Options Unlimited fabrics available
 Prices shown are for Era, Phoenix, Rivet & X2 - see pages 276-278.
 Please contact us for prices on other fabrics.



For seat dimensions see pages 272-275



Non standard fabric shown - please call for prices



Reception & Staffroom Seating



Whisper



A. YWHIS1	Whisper Straight High Back Seat Unit	£745.00
B. YWHIS2	Whisper 45 Degree Concave High Back Seat Unit	£845.00
C. YWHIS3	Whisper 45 Degree Convex High Back Seat Unit	£775.00



Unlimited fabrics available
Prices shown are for Era, Phoenix, Rivet & X2 - see pages 276-278.
Please contact us for prices on other fabrics.

Reception & Staffroom Seating

City sofas

- Versatile modular seating system
- Deep seat foam
- Heavy duty steel under frame
- Welded steel linking option meaning that units can be fixed together



A. YCITB1	City Single Seat With Back	£263.00
B. YCITDB1	City Double Seat With Back	£414.00
C. YCITTB1	City Three Seat With Back	£529.00
D. YCIT1	City Single Seat Without Back	£220.00
E. YCIT2	City Double Seat Without Back	£332.00
F. YCIT3	City Three Seat Without Back	£436.00
G. YCIT4	90 Deg External Corner Seat w/ Back	£384.00
H. YCITC1	90 Deg Internal Corner Seat w/ Back	£410.00
I. YCITCON1	City Corner Seat Without Back	£288.00
J. YCITAB2	City 4 Way Seat	£365.00

Table

- Beech or Walnut Laminate Table Top

K. YCITCTB	City Table With Beech Top	£281.00
L. YCITCTW	City Table With Walnut Top	£281.00

Optional Extras

- Arms available upholstered or in Beech or Walnut laminate

M. YCITA1	Extra Cost for Arm, Upholstered	+£90.00
N. YCITA2W	Extra Cost For Arm, Walnut	+£102.00
O. YCITA2B	Extra Cost For Arm, Beech	+£102.00
YCITLKL	Extra Cost For Link -Left Hand as Seated	+£11.00
YCITLKR	Extra Cost for link - Right Hand as Seated	+£11.00



Unlimited fabrics available

Prices shown are for Era, Phoenix, Rivet & X2 - see pages 276-278.
Please contact us for prices on other fabrics.





Non standard fabric shown - please call for prices

Reception & Staffroom Seating



Page Link - see page
For
coffee
tables

240-241



Gothenburg

- A statement piece chair with comfort as standard
- Gothenburg is available in both high and low back versions with a choice of 4 different leg option

Medium Back

A. Y608100	Solid Wood Spider Base Chair	£922.00
B. Y608101	Polished Aluminium Star Base Chair	£642.00
C. Y608102	Post-Industrial Tubular Steel Frame Chair	£543.00
D. Y608103	Solid Wood 4 Legged Base	£630.00

High Back

E. Y608104	Polished Aluminium Star Base Chair	£761.00
F. Y608105	Solid Wood Spider Base Chair	£1041.00
G. Y608106	Post-Industrial Tubular Steel Frame Chair	£662.00
Y608107	Solid Wood 4 Legged Base	£773.00



Unlimited fabrics available

Prices shown are for Era, Phoenix, Rivet & X2 - see pages 276-278. Please contact us for prices on other fabrics.

Reception & Staffroom Seating

Stockholm

- High winged back classic armchair
- Available with Swivel base or solid Oak Frame

New
Product

Y609100	Swivel Base	£1082.00
Y609101	Solid Oak Frame	£1082.00

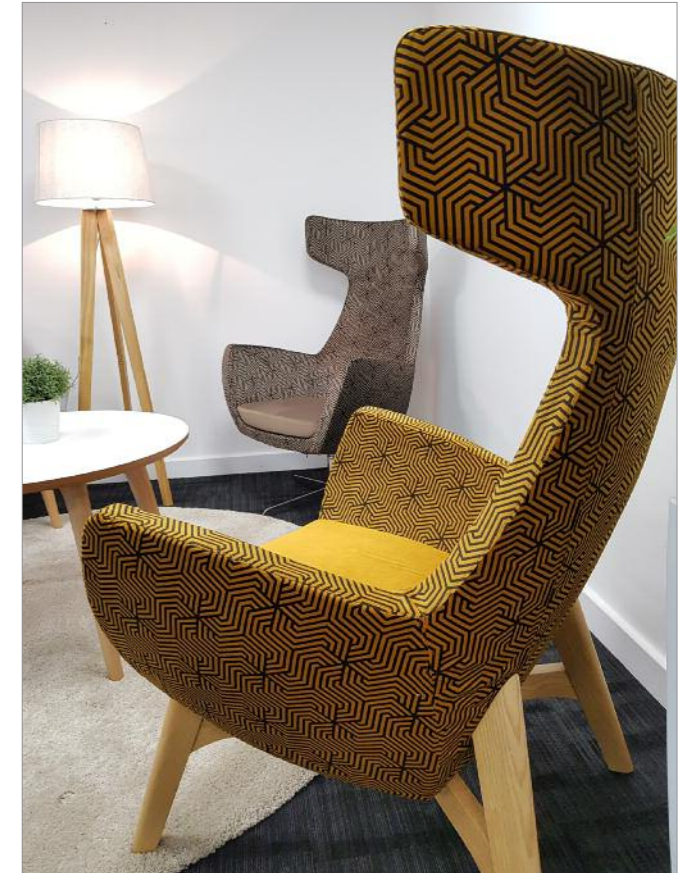

Non Standard fabrics - please call for prices

New Product



Reception & Staffroom Seating

Retreat

Retreat is a unique design in soft, futurist shapes: the break in the busy weekday.

Seated in the Retreat you are shielded against the noise and pulse around you – it is “a room inside the room” – a place where you can be undisturbed for a short while in a comfortable, peaceful environment. A place where a smartphone or iPad can be connected and recharged and where you can relax, work, read, listen, speak....

- Movable by means of 8 castors, braking when being loaded
- Equipped with 3 adjustable 1W LED lights
- 2 x 5W loudspeakers
- 12 V battery with charger for 220 V
- USB charger
- Bluetooth system and control panel.
- A fully assembled Retreat requires 92cm clear door width! For narrower passages the furniture can be delivered unassembled and be assembled on site!

Y609900	Retreat	POA
Y609901	Footstool	POA
Y609902	Screen	POA



Internal spotlights

Please ask for unique fabric swatch

New Product

Reception & Staffroom Seating

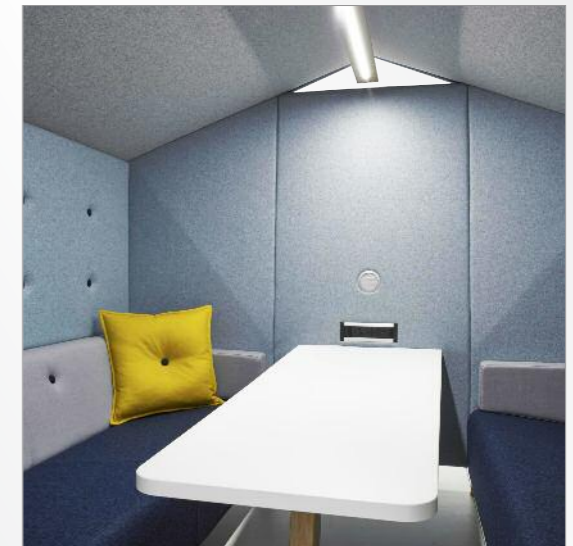

Aston Hut

- For a greater degree of privacy, the Aston Hut provides the answer. The Aston Hut features a high acoustic surround, with the addition of a complete upholstered roof create a fully upholstered seating solution for four or six persons
- Wherever you situate the Aston Hut, it will exude understated, restful confidence and create a genuine talking point

Options available: -

- Single or two tone fabrics
- Upholstered arm cushions
- Upholstered Rectangular loose cushions
- Upholstered Square loose cushions
- MFC Vase shaped table
- Power module – 2 x power
- Power module – 2 x power, 2 x USB
- Power module – 1 x power, 2 x USB, 1 x HDMI

Y609800	Aston 4 Seater Hut	POA
Y609801	Aston 6 Seater Hut	POA

10 Year
Warranty

Note: Shown in vinyl - prices are for fabric.



Reception & Staffroom Seating

Sky

- Finely styled yet robust range of reception or lounge seating
- Designed primarily for heavy traffic areas
- Ideal for student lounges, staff rooms and receptions
- Matching Coffee tables available



A. YSKYCP	Circular Seat	£216.00
B. YSKYSP	Seat with One Concave Side	£216.00
C. YSKYOCP	Seat with Double Concave Sides	£216.00
D. YSKYCC	Circular Chair with Back	£283.00
E. YSKYLS	Chair w/Left Concave Side & Back	£283.00
F. YSKYRS	Chair w/Right Concave Side & Back	£283.00
G. YSKYOC	Chair w/Two Concave Sides & Back	£283.00
H. YSKYGTC	Circular Glass Coffee Table	£294.00
I. YSKYGTS	Sky with One Concave Side Glass Coffee Table	£294.00
J. YSKYGTOC	Sky with Two Concave Sides Glass Coffee Table	£294.00
K. YSKYWTC	Circular Wood Coffee Table	£287.00
L. YSKYWOC	Single Concave Side Wood Coffee Table	£287.00
M. YSKYWTC	Double Concave Sides Wood Coffee Table	£287.00
YTWOT	Extra Charge for 2-Tone Fabrics from Band 1	£29.00

* Please specify fabric colour



Unlimited fabrics available

Prices shown are for Era, Phoenix, Rivet & X2 - see pages 276-278. Please contact us for prices on other fabrics.

Page Link - see page

For the Smile Range 125

For seat dimensions
see pages 272-2755 Year
Warranty

Stylo & Stylo Plus



- Singularly or in groups, this versatile range of soft seating with endless configurations, makes for an interesting seating solution, whether for reception or breakout areas
- Adult and junior sizes
- Stylish, multi functional design
- No assembly required
- Flame retardant foam

Stylo

YLU21	Circular Seat	£135.00
YLU22	Dogbone Seat	£145.00
YLU23	Kidney Shaped Seat	£145.00
YLU24	Square Seat	£140.00
YLU25	Apostrophe Seat	£190.00
YLU26	Double Seater	£156.00
YLU28	Quadrant	£168.00

For seat dimensions
see pages 272-275

Stylo plus

Like the Stylo but with chrome feet and adult sizes

- Eight stylish designs

YLP21	Circular Seat	£184.00
YLP22	Dogbone Seat	£193.00
YLP23	Kidney Shaped Seat	£187.00
YLP24	Square Seat	£184.00
YLP25	Apostrophe Seat	£250.00
YLP26	Double Seater	£213.00
YLP27	Circular Nibble	£184.00



Unlimited fabrics available

Prices shown are for Era, Phoenix, Rivet & X2 - see pages 276-278. Please contact us for prices on other fabrics.



Causeway

- These irregular hexagonal form seats are available in two heights that serve as both sitting and backrest units
- Can be freely combined in infinite arrangements
- Ideal for chillout zones, waiting areas and entrance halls
- Connected with black, powder coated metal links

YCWAYHU	High Unit (750mm)	POA
YCWAYLU	Low Unit (450mm)	POA

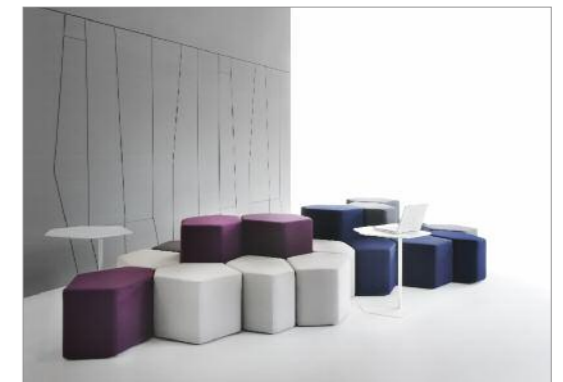

New Product



Coffee Tables

Laptop coffee table

- Chrome wire frame
- Unique design
- White top as standard

Y600380	Laptop Coffee Table	£195.00
---------	---------------------	---------



Colour top coffee tables

- A range of wooden coffee/childrens' tables
- The core material is birch ply with an exposed polished edge, and solid timber legs
- Tops are finished in laminate
- Size: H450 x W600 x D600mm

YCRT600	Round	£226.00
YCST600	Square	£226.00



Non standard fabric shown - please call for prices

Aspect coffee table

- Matches the aspect range of modular seating on page 213
- Table with oak look top

YREC04W*		£105.00
----------	--	---------

For seat dimensions see pages 272-275

Coffee Tables

Chrome column leg coffee tables

- Premium laminate top in a choice of colours - please specify when ordering
- Height 505mm
- 2mm ABS edge

A. YTRUCC	Circular 600mm Diameter	£254.00
B. Y600390	Square 600 x 600mm	£232.00
C. Y600400	Rectangular 1000 x 600mm	£228.00

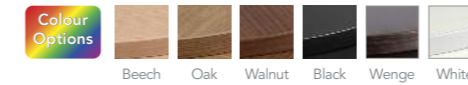

Page Link - see pages

For dining furniture

157-175



Alpine coffee tables

- Matches with office furniture on pages 296 to 297

Panel Base, MFC Tables H400mm

D. YZZN603	Square Table, H600 x D600	£91.00
E. YZZN100	Rectangular Table, W1000 x D600	£129.00
F. YZZN651	Round Coffee Table, Ø650	£97.00

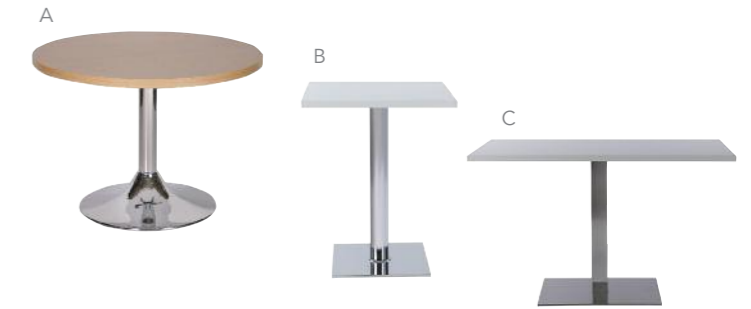

For seat dimensions see pages 272-275



New Product



Gothenburg coffee tables

- Matches Gothenburg on P234

Y608108	Square Coffee Table	£243.00
Y608109	Rectangular Coffee Table	£301.00

Express Delivery



Operator Seating

E-Magic

- Twin lever mechanism
- Back height and angle adjustment
- Styles may vary
- Supplied flat pack for self assembly
- Fixed arms available at additional cost



		1-9	10+
YEMAG01B	Operator Chair	£66.00	£60.00
YEMAGA	Fixed Arms	+£20.00	+£15.00

Fabric Options

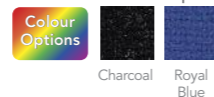

For seat dimensions see pages 272-275

Best Seller

5 Year Warranty

Breeze

- Luxury operator chair
- Advanced lumbar support - for extra back support
- Large back chair has pump up lumbar support
- 3 lever mechanism allows extra adjustment
- Heavy duty gas lift allows heavier use
- Deep padded foam seat for added comfort
- Larger back



A. YBRELB*	Large Back Pump up Lumbar	£155.00
B. YBRELBA*	Large Back with Fixed Arms	£175.00
C. YBRELAJ*	Large Back with Adjustable Arms	£187.00
YTWOT	Extra Charge for 2-Tone Fabrics from Band 1	£29.00

*Please specify fabric colour

Unlimited fabrics available
Prices shown are for Era, Phoenix, Rivet & Advantage – see pages P276 – P277. Please contact us for prices on other fabrics



5 Year Warranty

Best Seller

Operator Seating

Merlin

- Low price, high quality
- High back and medium back
- 5 year guarantee



A. Y20106*	Mid Back	£99.00
B. Y20111*	Mid Back - Fixed Arms	£119.00
C. Y20113*	Mid Back - Adjustable Arms	£132.00
D. Y20108*	High Back	£111.00
Y20110*	High Back - Fixed Arms	£122.00
Y20112*	High Back - Adjustable Arms	£134.00
G. Y20301*	High Back Draughtsman Chair	£126.00
H. Y20201*	H/Back Cantilever Conference Chair	£138.00
I. YCH	Chrome Base	+£31.00
J. YCFA	Chrome Fixed Arm	+£67.00
K. YFOLD	Folding Arms	+£36.00
YPULS	Pump up Lumbar Support	+£20.00
YTLM	Three Lever Mechanism (seat tilt)	+£10.00
YTWOT	Extra Charge for 2-Tone Fabrics from Band 1	£29.00

* Please specify colour fabric

Unlimited fabrics available
Prices shown are for Era, Phoenix, Rivet & Advantage – see pages P276 – P277. Please contact us for prices on other fabrics



Non standard fabric shown - please call for prices



High Back



Mid Back

Some chair options are not shown in the price list - please call for details

For seat dimensions see pages 272-275

5 Year Warranty



Operator Seating

Score

- Ergonomic operator chair
- Sculptured seat and back for greater comfort
- 2 lever mechanism
- Hand wheel back height adjustment



YGLSHB	High Back Operator Chair	£157.00
YGLSHMA	High Back Operator Chair with Fixed Arms	£173.00
YGLSHAT	High Back Operator Chair with Adjustable Arms	£197.00

* Please specify colour fabric



Unlimited fabrics available
Prices shown are for Era, Phoenix, Rivet & Advantage – see pages P276 – P277. Please contact us for prices on other fabrics

For seat dimensions see pages 272-275

5 Year Warranty



Merlin plus

- Modern, comfortable square back
- Twin lever mechanism
- Adjustable back height



A. YMPS66	Merlin Plus High Back	£122.00
B. YMPS66FA	Merlin Plus - Fixed Arms	£142.00
C. YMPS66ADJ	Merlin Plus - Adjustable Arms	£154.00
YTWOT	Extra Charge for 2-Tone Fabrics from Band 1	£29.00



Unlimited fabrics available
Prices shown are for Era, Phoenix, Rivet & Advantage – see pages P276 – P277. Please contact us for prices on other fabrics

Other options - please call for details



Operator Seating

Ellipse

- Superior operator chair range for the discerning buyer
- Optional aluminium base
- Matching visitor chairs
- Visitor chairs have 25mm steel cantilever frame



A. YE50622*	Ellipse Operator Chair	£125.00
B. YE50622FA*	Ellipse With Fixed Arms	£149.00
C. YE50622ADJ*	Ellipse With Adjustable Arms	£159.00
YE50622C*	Addnl Polished Aluminium Base	+£32.00

E. YE506622*	Ellipse Visitor Chair	£149.00
F. YE50622A*	Visitor Chair with Fixed Arms	£195.00
G. YEV50622C*	Visitor Chair Chrome Frame	+£13.00

* Please specify colour fabric



Unlimited fabrics available
Prices shown are for Era, Phoenix, Rivet & Advantage – see pages P276 – P277. Please contact us for prices on other fabrics



For seat dimensions see pages 272-275

Page Link - see pages 276-279
For fabric swatches



High chair with footrest for use at high worksurfaces



Operator Seating

Chime mesh



A. YCHI1B	Operator Chair	£130.00
B. YCHI1BFX	Operator Chair, Fixed Arms	£146.00
C. YCHI1BAD	Operator Chair, Adjustable Arms	£156.00
D. YCHI1BFA	Operator Chair, Folding Arms	£166.00

E. YCHI1C	Operator Chair, Chrome Base	£149.00
F. YCHI1CFX	Operator Chair, Chrome Base, Fixed Arms	£174.00

G. YCHI1CAD	Operator Chair, Chrome Base, Adjustable Arms	£175.00
-------------	--	---------

H. YCHI1CFA	Operator Chair, Chrome Base, Folding Arms	£185.00
-------------	---	---------

I. YCHI2B	Draughtsman Chair	£153.00
J. YCHI2BFX	Draughtsman Chair, Fixed Arms	£169.00
K. YCHI2BAD	Draughtsman Chair, Adjustable Arms	£179.00
L. YCHI2BFA	Draughtsman Chair, Folding Arms	£189.00

M. YCHI2C	Draughtsman Chair, Chrome Base	£172.00
N. YCHI2CFX	Draughtsman Chair, Chrome Base, Fixed Arms	£197.00

O. YCHI2CAD	Draughtsman Chair, Chrome Base, Adjust. Arms	£198.00
-------------	--	---------

P. YCHI2CFA	Draughtsman Chair, Chrome Base, Folding Arms	£208.00
-------------	--	---------

* Please specify fabric colour

Colour Options Unlimited fabrics available
Prices shown are for Era, Phoenix, Rivet & Advantage – see pages P276 – P277. Please contact us for prices on other fabrics

Page Link - see pages
For fabric swatches 270-273

For seat dimensions see pages 272-275

Operator Seating

Chester high back mesh chair

- Synchronised mechanism with side tension adjustment
- Seat depth adjustment
- Black or White nylon frame with deluxe active black mesh
- Black or White loop fixed arms

Y610801	Black Chair with Arms	£379.00
Y610802	Black Chair with Arms & Headrest	£469.00
Y610803	White Chair with Arms	£410.00
Y610804	White Chair with Arms & Headrest	£499.00

Colour Options Unlimited fabrics available
Prices shown are for Era, Phoenix, Rivet & Advantage – see pages P276 – P277. Please contact us for prices on other fabrics

Page Link - see page

For visitor chairs

270



Drift mesh

- Ergonomic stylish mesh back chair
- Height adjustable lumbar pad
- Seat slide
- Optional headrest and adjustable arms
- Mesh back available in 11 colours
- Chrome base available POA
- Matching visitor chair available

YDES52	Mesh Back Chair (No Arms)	£302.00
YDES52ADJ	Mesh Back Chair with Adjustable Arms	£349.00
YDES62	Mesh Back Chair with Headrest	£348.00
YDES62ADJ	Mesh Back Chair with Headrest & Adjustable Arms	£395.00
YDESC50	Mesh Back Visitor Chair (No Arms)	£267.00
YDESEX50	Mesh Back Visitor Chair with Arms	£321.00

Colour Options Unlimited fabrics available
Prices shown are for Era, Phoenix, Rivet & Advantage – see pages P276 – P277. Please contact us for prices on other fabrics

The modern chair

- Aerated Polypropylene back
- Integrated Seat Slide
- Synchro Mechanism
- White or Black base & back Options

Y600420	White Operator Chair	£290.00
Y600440	Black Operator Chair	£241.00
Y600430	White Chair with Adjustable Arms	£348.00
Y600450	Black Chair with Adjustable Arms	£285.00



New Product



5 Year Warranty



Y600450



Y600420



Y600430



Y600440

Best Seller **5 Year Warranty** **Express Delivery**



Non standard fabric shown - please call for prices



Non standard fabric shown - please call for prices

Task Seating

Cusiro task chair

- Ergonomic, permanent contact back with weight control



A. YTRA11	Black Components	£182.00
B. YTRA11FA	Black Components & Fixed Arms	£200.00
C. YTRA11A	Black Components & Adj Arms	£222.00
D. YTRA12	Chrome Components	£196.00
E. YTRA12FA	Chrome Components & Fixed Arms	£228.00
F. YTRA12A	Chrome & Adjustable Arms	£242.00
YTWOT	Extra Charge for 2-Tone Fabrics from Band 1	£29.00

* Please specify fabric colour

Colour Options Unlimited fabrics available
Prices shown are for Era, Phoenix, Rivet & Advantage – see pages P276 – P277. Please contact us for prices on other fabrics

For seat dimensions see pages 272-275

Chess



A. YCHE01	Task Chair with No Arms	£182.00
B. YCHE01F	Task Chair with Fixed Arms	£200.00
C. YCHE01AA	Task Chair with Adjustable Arms	£222.00
D. YCHE01D	Task Chair with Folding Arms	£222.00
E. YCHE02	Task Chair with Chrome Base and No Arms	£200.00
F. YCHE02F	Task Chair with Chrome Base and Fixed Arms	£228.00
G. YCHE01A	Task Chair with Chrome Base and Adjustable Arms	£242.00
H. YCHC01D	Task Chair with Chrome Base and Folding Arms	£240.00
YTWOT	Extra Charge for 2-Tone Fabrics from Band 1	£29.00

* Please specify fabric colour

Colour Options Unlimited fabrics available
Prices shown are for Era, Phoenix, Rivet & Advantage – see pages P276 – P277. Please contact us for prices on other fabrics

Task Seating

5 Year Warranty **Best Seller**

- Pump up lumbar support to a comfortable inflation and release with push button
- Lift levers to release back synchronised mechanism. Back and seat are now in free float. Push levers down to lock in position.
- Lift and hold lever to operate gas height adjustment. Set to desired height and release. (Front Lever)



- Lift back 7 increments to desired height, 8th position returns back to lowest setting
- Lift arm by lifting lever under the arm and adjusting to suit
- Lift lever to adjust sliding seat, release to lock in position (left lever)
- Turn to adjust tension depending upon operator's weight

For seat dimensions see pages 272-275

Westminster task chair



- Brilliant value for money task chair
- Highly ergonomic
- Contoured seat and back
- Heavy duty back
- Synchronised or independent mechanism - synchronised moves seat and back together, independent mechanism adjusts them separately

Colour Options Unlimited fabrics available
Prices shown are for Era, Phoenix, Rivet & Advantage – see pages P276 – P277. Please contact us for prices on other fabrics

A. YHYP1	Chair, Black Components	£234.00
B. YHYP1F	Chair, Black Components w/Fixed Arms	£259.00
C. YHYP1A	Chair, Black Components w/Adj Arms	£266.00
D. YHYP1V	Visitor/Conference Chair	£163.00
E. YHYP1VA	Visitor/Conference Chair w/Arms	£187.00
F. YHYP1VFA	Visitor/Conference Chair w/Frame Arms	£221.00
G. YHYP2	Task Chair With Chrome Components	£270.00
H. YHYP2F	Task Chair w/Chrome Components & Fixed Arms	£295.00
I. YHYP2A	Task Chair Chrome w/Adjustable Arms	£302.00
J. YHYP2V	Visitor/Conference Chair in Chrome	£177.00
K. YHYP2VA	Visitor/Conference Chair in Chrome w/Arms	£202.00
L. YHYP2VFA	Visitor/Conference Chair in Chrome w/Frame Arms	£250.00

*Please specify fabric colour Please choose synchronised or independent mechanism



5 Year
Warranty

Task Seating

Strike

- Stylish task chair
- Full back upholstered all round
- Stable star base with easy roll castors
- Synchronised mechanism

YTRA17*	Task Chair (No Arms)	£264.00
YTRA17A*	Task Chair with Adjustable Arms	£304.00
YTRA18*	Chrome Task Chair (No Arms)	£293.00
YTRA18A*	Chrome Task Chair with Adjustable Arms	£335.00
YTWOT	Extra Charge for 2-Tone Fabrics from Band 1	£29.00

* Please specify fabric colour



Unlimited fabrics available
Prices shown are for Era, Phoenix, Rivet & Advantage – see pages P276 – P277. Please contact us for prices on other fabrics

Bariatric Chair
150kg Capacity

B. iChair

- High back task chair in three sizes Petite, Standard and Tall
- Labelled easy to use controls
- Ratchet back height adjustment
- Optional extra seat slide, inflatable lumbar and Head rest
- Compliant with HSE seating at work directives
- Weight capacity 150kg, cantilever 110kg

Y600630	iChair Large	£368.00
Y600640	iChair Standard	£327.00
Y600650	iChair Petite	£305.00
Y600660	Optional Extra Adjustable Arms	£99.00
Y600670	Optional Extra Seat Slide	£37.00
Y600680	Optional Extra Pump Up Lumbar	£42.00
Y600690	Optional Extra Headrest	£87.00
	– Not Available for Petite Chair	

Petite (small seat and small back)	Standard (standard seat & high back)	Tall (large seat & high back)
5ft & under 152.4cm & under	5ft to 5ft 11" 152.4cm to 180.3cm	5ft 11 inches & above 180.3cm & above

For seat dimensions
see pages 272-275

Task Seating

Arrow executive chair

- High back executive style chair at incredible value
- Superb Back support
- Pump up Lumbar support
- Adjustable seat and back angle
- Height adjustable arms and headrest available
- Available with chrome base & arms POA
- 5 year guarantee

A. YAIF2	Visitor/Conference Chair, Black Frame	£250.00
B. YAIF2A	Visitor/Conference Chair w/Arms, Black Frame	£308.00
C. YAIF3	Visitor/Conference Chair with Chrome Frame	£264.00
D. YAIF3A	Visitor/Conference Chair with Chrome Frame and Arms	£337.00
E. YAIF81	Executive Chair - No Arms	£270.00
F. YAIF81ADJ	Executive Chair With Adjustable Arms	£321.00
G. YAIF91ADJHR	Executive Chair With Adjustable Arms & Headrest	£385.00

Options

YAIFAP	Polished Aluminium Base (Task Chairs Only)	+£57.00
YAIFCF	Additional Cost for Chrome Cantilever Frame	+£14.00
YAIFCFA	Additional Cost for Chrome (Conference Chair with Arms)	+£29.00
YAIFMF	Arrow Optional Memory Foam Seat	+£58.00
YAIFSS	Arrow Optional Seat Slider	+£26.00

Genuine Leather Options

YAIF2AL	Leather Conference Chair with Arms	£470.00
YAIF2L	Leather Conference Chair	£407.00
YAIF81ADJL	Leather Executive Chair With Adjustable Arms	£471.00
YAIF81L	Genuine Leather Executive Chair	£425.00
YAIF91ADJHRL	Leather Executive Chair, Adjustable Arms & Headrest	£566.00



Unlimited fabrics available
Prices shown are for Era, Phoenix, Rivet & Advantage – see pages P276 – P277. Please contact us for prices on other fabrics

5 Year
WarrantyPage Link - see pages
For fabric swatches
270-273For seat dimensions
see pages 272-275

New
Product

Manager & Executive Seating

Gorgio

- Sleek high back executive chair
- Height adjustable arms with sliding arm pads
- Four position synchronised mechanism
- Side tension control
- Polished aluminium base

Y610500	£339.00
---------	---------



Page Link - see page
Executive
conference
seating

264-265



Racer

- A stylish high back executive chair featuring a five locking position synchronized mechanism aluminium base, aluminium arms and PU arm pads

YRAC01	Black Managers Chair	£252.00
--------	----------------------	---------

5 Year
Warranty

Milan

- Dynamic seat and backrest
- Seat and backrest tilt lockable in upright position
- Adjustable seat height
- Wide comfortable seat and backrest
- Natural split leather faced
- Polished chrome base
- Black only

YNEO1BK	£269.00
---------	---------

For seat dimensions
see pages 272-275

Manager & Executive Seating

Chelsea

- A superb high back executive chair
- Five locking position synchronized mechanism
- Aluminium base and arms
- PU arm pads
- Matching cantilever available(see page 271)

YCHEL01	£252.00
---------	---------



Amado highback chair

- Stylish highback executive chair
- Tilt mechanism
- Matching cantilever available(see page 270)
- Black PU

YAMD1	£269.00
-------	---------



Bordeaux director's chair

- Inflatable lumbar support
- Synchro mechanism with tension adjustment & anti-kick safety feature
- Ratchet back
- Seat side
- Width & height adjustable chrome arms
- Multi-adjustable head rest
- Polished aluminum base
- Matching cantilever available(see page 271)

Y600230	Fabric	£640.00
Y600235	Black Leather	£814.00

New
ProductFor seat dimensions
see pages 272-275



Ergonomic &
Backcare
Range

For seat dimensions
see pages 272-275

A
Shown with
chrome base
option



B
Shown with fold
down arms & chrome
base option



C
Shown with
chrome disc
fixed arms



D
Shown with
chrome height
adjustable
arms



E
Shown with chrome
height adjustable
arms



F
Shown with
chrome disc fixed
arms



Ergonomic Backcare Seating

Ergotek task chair

- Physiotherapist approved ergonomic back care chair
- Ratchet back height adjustment
- Deep moulded foam for superior user comfort
- Compliant with HSE seating at work directives
- SATRA tested to BS 5459 level S severe use
- Weight capacity 150kg, cantilever 110 kg
- Seat Slide

Ergotek

A. YERGM	Mid Back Task Chair	£246.00
B. YERGH	High Back Task Chair	£271.00

Ergotek+ Larger, fully upholstered cut foam back

C. YERGMV	Mid Back Visitor Cantilever Chair	£186.00
D. YERGP	High Back Task Chair	£246.00
E. YERGPH	High Back Task Chair with Headrest	£396.00
F. YERGPV	High Back Visitor Cantilever Chair	£240.00

Arm Options

G. YERGAA	Black Height Adjustable Arms	+£65.00
H. YERGAC	Black Fixed Arms	+£27.00
I. YERGAD	Chrome Height Adjustable Arms	+£68.00
J. YERGAH	Chrome Disc Fixed Arms	+£40.00
K. YERGAM	Height adjustable Fold Down Arms	+£81.00

Base Options

L. YERGB2	Black Nylon Spider Base	+£33.00
M. YERGB3	Chrome Base	+£44.00
N. YERGB5	Polished Aluminium Base	+£62.00

Ergo Options

YERGCC	Coccyx Cut-Out (Ergotek+ Only)	+£17.00
YERGL	Inflatable Lumbar Support	+£34.00



Unlimited fabrics available
Prices shown are for Era, Phoenix, Rivet & Advantage – see pages P276 – P277. Please contact us for prices on other fabrics



Ergonomic Backcare Seating

Posture 150

- The Posture 150 back care chair has been tested to the rigorous strength and stability standard, BS5459 and is guaranteed structurally for 5 years whilst in 24 hour per day use by persons weighing up to 150kg
- The back and seat recline together in a fixed 2:1 ratio. The tension of the recline is adjusted by a rotating handwheel. The recline function can be left unlocked in dynamic freefloat mode. For added comfort the back angle is independently adjustable

A. YPP73	Posture Chair	£712.00
B. YPP73ADJ	Posture Chair with Arms	£791.00
C. YPP83	Posture Chair with Adjustable Headrest	£796.00
D. YPP83ADJ	Posture Chair with Adjustable Headrest and Arms	£876.00
YPPC	Chrome Base	+£60.00



Unlimited fabrics available
Prices shown are for Era, Phoenix, Rivet & Advantage – see pages P276 – P277. Please contact us for prices on other fabrics



For seat dimensions
see pages 272-275

Constant Chair

- Featuring a unique, anatomically designed cut foam seat
- Designed for 24/7 use
- Compliant with HSE seating at work directives
- Memory seat foam moulds to the user shape to promote correct posture
- Weight capacity 150kg
- Synchro mechanism seat slide and pump up lumbar as standard

Y600460	Chair	£667.00
Y600470	Chair with Adjustable Arms	£735.00





Conference Seating

Mercury wood frame visitor

- High quality moulded wood frame
- Light Oak effect frame
- 535mm wide
- Stacks 4 high

YVIS04*	Mercury Beech Side Chair	£101.00
YVIS04A*	Mercury Beech Armchair	£105.00
YTWOT	Extra Charge for 2-Tone Fabrics from Band 1	£29.00

* Please specify fabric colour



Unlimited fabrics available

Prices shown are for Era, Phoenix, Rivet & Advantage – see pages P276 – P277. Please contact us for prices on other fabrics



Westbury

- Stylish solid wood frame chair ideally suited for a variety of locations
- Stacks 4 high
- Coated in hygienilac anti-bacterial laquer
- 5 year guarantee (normal use)

YWES01	Westbury Wood Frame Side Chair	£237.00
YWES02	Westbury Wood Frame Armchair	£293.00

* Please specify fabric colour



Unlimited fabrics available

Prices shown are for Era, Phoenix, Rivet & Advantage – see pages P276 – P277. Please contact us for prices on other fabrics

5 Year
Warranty



Define

- Attractive boardroom chair
- One piece seat and back
- Clear lacquered frame
- 5 year guarantee

YDHAT01*	Define 4 Leg Chair	£162.00
YTWOT	Extra Charge for 2-Tone Fabrics from Band 1	29.00

* Please specify fabric colour



Unlimited fabrics available

Prices shown are for Era, Phoenix, Rivet & Advantage – see pages P276 – P277. Please contact us for prices on other fabrics

For seat dimensions
see pages 272-275

Conference Seating

Venus deluxe beech framed

- Suited for visitors or management suites
- Fully upholstered waterfall seat
- Stylish curved frame
- H480 x W580 x D580mm
- Stacks 4 high

YVIS06*	Venus Beech Chair	£162.00
YTWOT	Extra Charge for 2-Tone Fabrics from Band 1	£29.00

* Please specify fabric colour



Unlimited fabrics available

Prices shown are for Era, Phoenix, Rivet & Advantage – see pages P276 – P277. Please contact us for prices on other fabrics



For seat dimensions
see pages 272-275

Galaxy wood frame visitor

- Elegant stacking side or arm chairs
- Crafted hard wood frame
- 5 year guarantee
- H480 x W520 x D560mm
- Stacks 4 high

YVIS05*	Galaxy Stacking Side Chair	£127.00
YVIS05A*	Galaxy Armchair	£135.00
YTWOT	Extra Charge for 2-Tone Fabrics from Band 1	£29.00

* Please specify fabric colour



Unlimited fabrics available

Prices shown are for Era, Phoenix, Rivet & Advantage – see pages P276 – P277. Please contact us for prices on other fabrics



Best
Seller

5 Year
Warranty



5 Year Warranty



Narrower design allowing 2 chairs to fit under 1200mm wide classroom table



Best Seller



Conference Seating

Fleet plus

- Classic conference chair with added quality
- Mesh back chair with fabric upholstered seat
- Arm writing tablets available POA



		1-9	10+
YFP500MB*	Mesh Back Chair	£75.00	£65.00
Y600570*	Mesh Back Cantilever Chair	£89.00	£79.00

* Please specify fabric colour

Seat fabric options

Colour Options

511 Black	501 Cobalt	505 Burgundy

College fleet heavy duty chair

- Heavy duty chair designed for use in colleges and higher education
- Narrower design allowing 2 chairs to fit under 1200mm wide classroom table
- Stackable

		1-19	20+
YCOFL	Chair	£61.00	POA
YCOFLWT	Chair with Writing Tablet	£96.00	POA

Delivery charge for quantities of less than 10 chairs

For seat dimensions see pages 272-275

Mono stacking chair

- Black welded frame
- Excellent value for money
- Stack up to 5 high



		1-10	20+
YVIS01*	Mono Chair	£57.00	£40.00
Y600720*	Silver Frame Chair	£70.00	£50.00
YVIS01A*	Mono Armchair	£89.00	£69.00
Y600730*	Silver Frame Armchair	£101.00	£81.00

* Please specify fabric colour

Colour Options

Unlimited fabrics available
Prices shown are for Era, Phoenix, Rivet & Advantage – see pages P276 – P277. Please contact us for prices on other fabrics

Best Seller Express Delivery

Conference Seating

Fleet

- A collection of multipurpose stacking chairs suitable for conference, meeting and training rooms, public waiting areas, canteens and schools
- Features include comfortable deep foam, three dimensional waterfall seat, plastic feet to eliminate floor scratching with a choice of black or chrome steel frames
- Stackable up to eight high
- If using with classroom tables, please use the College Fleet chair shown opposite as it is narrower



		1-9	10+
YVIS13	Chair with Black Frame	£48.00	£40.00
A. YVIS15	Chair With Chrome Frame	£50.00	£42.00
YVISP1BK	Chair with Black Moulded Plastic Seat and Back	£40.00	£33.00
B. YVISP2R	Chair with Red Moulded Plastic Seat and Back	£40.00	£33.00
C. YVISP3BL	Chair with Blue Moulded Plastic Seat and Back	£40.00	£33.00
YVISP4G	Chair with Green Moulded Plastic Seat and Back	£40.00	£33.00
YVISP5P	Chair, Upholstered Seat and Perforated Plastic Back	£53.00	£45.00
D. YVIS16	Fleet Wood Chair	£70.00	£60.00

Options

YFLETA	Optional Arms	+£20.00	+£18.00
YVIS17	Optional Writing Tablet	+£27.00	+£25.00
YVISWFA	Writing Tablet & 1 Arm	+£41.00	+£34.00
YFLETLD	Fixed Linking Device (Pair)	+£4.00	+£3.00

Please specify fabric colour

Colour Options

Unlimited fabrics available
Prices shown are for Era, Phoenix, Rivet & Advantage – see pages P276 – P277. Please contact us for prices on other fabrics

For seat dimensions see pages 272-275

Fast Track Chair - in stock for faster delivery



Fleet fast track

- Stocked in Black BK, Royal Blue RB, Claret CL

		1-19	20+
YFLEFT		£35.00	£29.00



Fleet with Chrome Frame

Fleet with Coloured Moulded Seat & Back



Fleet Wood Chair



Fleet with Optional Arms



Fleet with Writing Tablet & 1 Arm



Optional Linking Device

Fleet Fast Track Chair Fabric Options

Colour Options

Black	Royal Blue	Claret





New Product

Conference Seating

Louis

- Stylish & comfortable chair available with 3 leg options
- Optional extra wire frame colours - please enquire

A. Y611700	Med. Back Skid Base Chair	£249.00
B. Y611701	Med. Back Skid Base Chair with Arms	£309.00
C. Y611702	Med. Back Wooden Frame Chair	£329.00
D. Y611703	High Stool with Wooden Frame Stool	£429.00



Conference Seating

Peak

- Multifunctional conference chair available with Black or Chrome frame
- Plastic Perforated back

Y612600	Chair with Black Back & Black Frame	£53.00
Y612602	Chair with White Back & Black Frame	£53.00
Y612604	Chair with Upholstered Seat & Black Back	£69.00
Y612606	Chair with Upholstered Seat & White Back	£69.00
Y612608	Chair with Upholstered Seat & Back in Black	£84.00
Y612610	Chair with Upholstered Seat & Back in White	£84.00
Y612612	3 Seater Bench with Upholstered Seat, Black Plastic Back & Black Frame	£267.00
Y612614	3 Seater Bench with Upholstered Seat & Back, Black Plastics & Black Frame	£313.00

Options

Y612616	Chrome Frame for Chair	+£11.00
Y612618	Black Swivel Base for Chair	+£38.00
Y612620	Chrome Swivel Base for Chair	+£64.00
Y612622	Set of Black Plastic Arms & Arm Pads – Cannot be Retro Fitted	+£22.00
Y612624	Left Hand Writing tablet	+£58.00
Y612626	Right Hand Writing tablet	+£58.00
Y612628	Chrome Fixed Arms with Black Arm Pads	+£58.00
Y612630	Chrome Fixed Arms with White Arm Pads	+£58.00
Y612632	Trolley for Chairs	£267.00



Unlimited fabrics available

Prices shown are for Era, Phoenix, Rivet & Advantage – see pages P276 – P277. Please contact us for prices on other fabrics



New Product



New Product



Conference Seating

Classic banquet chair

- Classic Banquet Chair with Rounded top
- Black frame

Y613500	£47.00
---------	--------



Unlimited fabrics available
Prices shown are for Era, Phoenix, Rivet & Advantage – see pages P276 – P277. Please contact us for prices on other fabrics

For seat dimensions
see pages 272-275

A



Note: with chrome
frame option

B



C



D



Track

- Stacking chair
- Writing tablet option

A. YTRAC1*	Track 4 Leg Chair	£107.00
B. YTRAC1PU*	Track 4 Leg Chair with PU Arms (Optional Writing Tablet)	£148.00
YTRACWT	Track Writing Tablet (Option for PU Arm Chair Only)	+£45.00
C. YTRACPP	Track 4 Leg Chair with Polypropylene Arms	£127.00
YTRAC4C	Track Chrome Frame for 4 Leg Chairs	+£19.00
D. YTRACCA*	Track Cantilever Chair with Arms	£167.00
YTRACCR	Track Chrome Frame for Cantilever Chair	+£21.00

* Please specify fabric colour

Conference Seating

Response cantilever

- Popular, chrome cantilever stacking visitor's chair
- Stacks 4 high

YVIS10*	Response Cantilever	£78.00
YVIS10A*	Response Cantilever With Arms	£105.00
YTWOT	Extra Charge for 2-Tone Fabrics from Band 1	£29.00

* Please specify fabric colour



Unlimited fabrics available
Prices shown are for Era, Phoenix, Rivet & X2 - see pages 276-278. Please contact us for prices on other fabrics.

Response plus

- Chrome frame cantilever chair, stacks up to 4 high
- Large back for extra comfort
- Cantilever frame gives better floor protection than a 4-leg chair
- Seat height 470mm, W460mm x D480mm
- Chrome EPS paint finish

YRESP01E*	each	£85.00
-----------	------	--------

* Please specify fabric colour



Unlimited fabrics available
Prices shown are for Era, Phoenix, Rivet & Advantage – see pages P276 – P277. Please contact us for prices on other fabrics

Page Link - see pages

For
fabric
swatches

276-279



For seat dimensions
see pages 272-275

Perennial chair

- Strong, fully upholstered chair
- Stackable (with fitted tablet)
- 5 year warranty
- Optional tablet can be fitted left or right
- 530mm x 570mm x 470mm seat height
- Choose from Phoenix fabrics (page 270). Other fabrics available - please ask

		1-29	30+
Y100149	Without Tablet	£60.00	POA
Y100161	Tablet Fitted to Left Arm	£103.00	POA
Y100151	Tablet Fitted to Right Arm	£103.00	POA



Best Seller

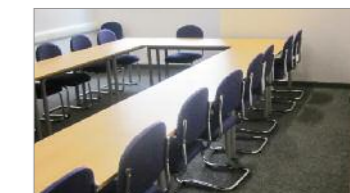

5 Year Warranty



Conference Seating

Cathedral chair

- The Cathedral chair combines comfort and stackability.
- Lightweight
- Stacks 10 high or 25 high on Cathedral trolley

		1-19	20+
YCATH	Chair	£59.00	£54.00
YCATHTR	Trolley	£185.00	n/a

* Please specify colour



New Product



Vogue

- Comfortable side chair with upholstered seat and back
- Chair or stool options
- 4 leg or skid base options

Y612700	4 Leg Chrome Chair	£160.00
Y612701	4 Leg Chrome Chair with Arms	£222.00
Y612702	Skid Base Chrome Chair	£156.00
Y612703	Skid Base Chrome Chair with Tablet	£250.00
Y612704	Skid Base Chrome Chair with Arms	£209.00
Y612705	4 Leg Chrome High Stool	£216.00
Y612706	Skid Base Chrome High Stool	£205.00



For seat dimensions see pages 272-275

Conference Seating

Kraft

- Sled frame training and conference chair
- Silver frame, chrome available POA

A. YKRA1	Black Plastic Sidechair	£80.00
B. YKRA1S	Upholstered Seat Sidechair	£112.00
C. YKRA1F	Fully Upholstered Sidechair	£131.00
D. YKRA2	Black Plastic Sidechair w/Arms	£115.00
E. YKRA2S	Upholstered Seat Sidechair w/Arms	£150.00
F. YKRA2F	Fully Upholstered Sidechair w/Arms	£165.00
G. YKRA3	Black Plastic Sidechair with Writing Tablet	£134.00
H. YKRA3S	Upholstered Seat Chair with Writing Tablet	£169.00
I. YKRA3F	Fully Upholstered Chair with Writing Tablet	£184.00
J. YKRATR	Kraft Trolley (Chairs not Included)	£205.00
YKRACF	Additional Cost for Chrome Frame	+£15.00



Unlimited fabrics available

Prices shown are for Era, Phoenix, Rivet & Advantage – see pages P276 – P277. Please contact us for prices on other fabrics



5 Year Warranty

For seat dimensions see pages 272-275



Linking device (chairs without arms only)



Conference Seating

Stax

High density stacking chair

- Chrome wire frame
- Stacks up to 40 high
- Integral linking on all chairs
- Weight capacity 200kg
- Available in Blue, Black, Grey or White
- Stacking trolley available

Y600530	Blue	£63.00
Y600540	Black	£63.00
Y600550	Grey	£63.00
Y600560	White	£63.00

Stax trolley

- Stacks 40 chairs high in 2 metres

Y600740	£210.00
---------	---------



Roma

- A contemporary and comfortable stacking chair
- Stacks up to 38 chairs on a dolly
- Ideal chair for when seating is required on a large scale
- A popular choice for halls, meeting areas and classrooms
- Available in Black, Flannel and Nordic as standard, all other colours available to order POA.

		1-29	30+
Y16716	Roma Chair	£69.00	POA
Y16728	Transport Dolly	£217.00	POA

Colour Options

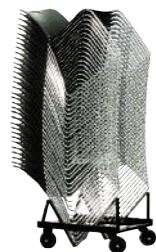

Removable left or right handed tablet arm



Upholstered seat pad

For seat dimensions see pages 272-275

Conference Seating



For seat dimensions see pages 272-275



Fusion

YFUS1	Chrome Frame 4 Leg Chair	£90.00
YFUS1A	Chrome Frame 4 Leg Chair with Arms	£123.00
YFUS2	Chrome Frame Sled Base	£90.00
YFUS2A	Chrome Frame Sled Base with Arms	£147.00

YFUSTR	Chair Trolley	£177.00
--------	---------------	---------

* Please specify colour



Conference Seating

Oslo

- Designer chair with solid beech legs
- Other wood finishes are available, please enquire for details

YOSLHPL	Oslo White Seat Shell	£255.00
YOSLBV	Oslo Beech Veneer Seat Shell	£205.00
YOSLUP	Oslo Fully Upholstered Chair	£245.00



Unlimited fabrics available

Prices shown are for Era, Phoenix, Rivet & Advantage – see pages P276 – P277. Please contact us for prices on other fabrics



Narvik upholstered

- Fully upholstered chair
- Deep foamed seat for extra comfort
- Hand-crafted from sustainable timber
- Robust construction, ideal for contract and retail locations
- Available in Natural Oak
- Choice of fabrics, vinyls and leathers

Y600580	Oak Frame Upholstered Chair	£256.00
Y600590	Oak Frame Upholstered Stool	£456.00



Unlimited fabrics available

Prices shown are for Era, Phoenix, Rivet & Advantage – see pages P276 – P277. Please contact us for prices on other fabrics

For seat dimensions
see pages 272-275



Molde wooden

- Comfortable contoured seat
- Extensive choice of fabrics, vinyls and leathers
- Available in Natural Oak
- Wooden Plyform seat
- Seat colours Black, White, Blue, Red, Orange, Yellow, Lime Green, Purple & anthracite

Y600610	Plyform Seat Chair	£198.00
Y600620	Plyform Seat Stool	£370.00

Conference Seating

Topaz

- Chrome frame chair with upholstered inner back and plastic back outer
- Weight capacity 110kg

YTOP1U	With 4 Legs	£141.00
YTOP1UA	With 4 Legs & Arms	£197.00
YTOP2UA	With Cantilever Frame & Arms	£209.00

* Please specify fabric colour



Unlimited fabrics available

Prices shown are for Era, Phoenix, Rivet & Advantage – see pages P276 – P277. Please contact us for prices on other fabrics



5 Year
Warranty

Topaz mesh

- Chrome frame chair with upholstered seat and mesh back
- Weight capacity 110kg

YTOP1M	With 4 Legs	£201.00
YTOP1MA	With 4 Legs and Arms	£257.00
YTOP2MA	With Cantilever Frame & Arms	£269.00
YTOPTR	Trolley (for 4 Leg Options Only)	£119.00

* Please specify fabric colour



Unlimited fabrics available

Prices shown are for Era, Phoenix, Rivet & Advantage – see pages P276 – P277. Please contact us for prices on other fabrics



5 Year
Warranty

For seat dimensions
see pages 272-275

Topaz mobile

- Chrome Frame chair on castors
- Available with Upholstered back or Mesh back

YTOPWM	Chair with Mesh Back	£245.00
YTOPWU	Chair with Upholstered Back	£185.00
YTOPWMA	Chair with Mesh Back & Arms	£298.00
YTOPWUA	Chair with Upholstered Back & Arms	£238.00



Unlimited fabrics available

Prices shown are for Era, Phoenix, Rivet & Advantage – see pages P276 – P277. Please contact us for prices on other fabrics



New
Product

New
Product

Executive Conference Seating

Chester mesh chair

- Black or White nylon frame with deluxe active black mesh

Y610800	Black Cantilever Chair with Arms	£259.00
Y610805	White Cantilever Chair with Arms	£289.00



Unlimited fabrics available

Prices shown are for Era, Phoenix, Rivet & Advantage – see pages P276 – P277. Please contact us for prices on other fabrics

Milan

- Wide comfortable seat and backrest
- Natural split leather faced
- Black only
- Polished chrome frame

YMILBK	Milan Cantilever Chair	£239.00
--------	------------------------	---------

Amado

- Stylish cantilever chair
- Black PU

YAMD2		£191.00
-------	--	---------

5 Year
WarrantyFor seat dimensions
see pages 272-2755 Year
Warranty

Executive Conference Seating

Chelsea

- A superb quality cantilever chair
- Aluminium base and arms
- PU arm pads

YCHEL02		£170.00
---------	--	---------



Racer

- Stylish cantilever chair
- Black PU

YRAC02		£155.00
--------	--	---------

For seat dimensions
see pages 272-275

Bordeaux cantilever chair

- Luxury cantilever conference chair
- Chrome frame
- Arm pads

Y600240	Fabric	£403.00
Y600245	Black Leather	£576.00



Code	o/a height	o/a width	o/a depth	seat height
Reception & Staffroom Seating				
Page 213				
YREC25W	740	575	710	400
YREC26W	740	625	710	400
YREC27W	740	625	710	400
YREC28W	740	675	710	400
YREC29W	740	1250	710	400
YREC31W	740	670	670	400
YREC32W	740	570	720	400
YREC33W	740	570	720	400
YREC32LW	740	620	720	400
YREC32RW	740	620	720	400
YREC33LW	740	620	720	400
YREC33RW	740	620	720	400
YREC04W	330	620	620	-
YREC04G	330	620	620	-
Page 214				
YHOR01	890	580	820	410
YHOR01LA	890	680	820	410
YHOR01RA	890	680	820	410
YHORA	890	780	820	410
YHOR02	890	490	820	410
YHOR03	890	660	820	410
YHORCBE	300	770	770	-
YHORCMA	300	770	770	-
YHORCOA	300	770	770	-
YHORCFB	300	770	770	-
Page 215				
YSWI1	800	580	660	440
YSWI1A	810	650	670	450
YSWIT	400	580	580	-



Page 216				
YMOT1	-	-	-	-
YMOTTS	-	-	-	-
YMOTTG	-	-	-	-
YMOTTLA	730	660	745	395
YMOTTRA	730	660	745	395
YMOTTA	730	740	745	395
Page 217				
YJASMU	760	580	550	-
YJASBL	760	580	550	-
YJASGR	760	580	550	-
Page 218				
YRALI	820	520	660	410
YIMP1	810	520	670	410
YIMPA	810	630	670	410
YCC50	890	570	660	440
YCC55	890	650	660	440
YCC255	890	1160	660	440
YCC20	350	550	550	-
YCC30	350	1100	550	-
Page 219				
YMER1A	745	590	690	420
YMER1AA	745	640	690	420
YMER1RA	745	620	690	420
YMER1LA	745	620	690	420
YMER2AA	745	1175	690	420
YMER1M	890	590	735	420
YMER1MA	890	640	735	420
YMER1MRA	890	620	735	420
YMER1MLA	890	620	735	420
YMER2MA	890	1320	735	420
YMER1H	1020	590	770	420
YMER1HA	1020	640	770	420
YMERSTA	335	566	566	-
YMERRTA	340	1132	565	-
YMERPL	890	570	640	430
YMERPLA	890	620	640	430
YMERPH	980	570	680	430
YMERPHA	980	620	680	430
Page 220				
YREC11	780	660	600	460
YREC20	780	1250	600	460
YREC12W	440	520	520	-
YREC12G	440	520	520	-
YREC10BK	770	700	630	455
YREC10CH	770	700	630	455
YREC102BK	770	1290	630	455
YREC102CH	770	1290	630	455
Y600100	770	680	490	490
Y600102	770	1100	610	490
Page 221				
YLEG1B	840	720	680	460
YLEG2B	840	1240	680	460
YLEG1C	840	720	680	460

YLEG2C	840	1240	680	460
YPSL1	790	640	630	440
Page 222				
YVIV01	840	460	460	510
YJAVAST	225	440	440	-
YJAVA	350	750	750	-
Page 223				
YTIG1	860	590	-	420
YTIG2	860	590	-	420
YTIG4	860	590	-	420
YTIG5	365	750	-	-
YCON1	810	570	560	430
YCON2	810	570	560	430
YCON3	810	570	560	430
YCON4	820	570	560	470
Page 224				
Y606300	780	600	580	440
Y606301	780	600	580	440
Y606302	780	600	580	440
Y606303	875	600	580	395-535
Y607200	830	620	600	480
Y607201	830	620	600	480
Y607202	830	620	600	480
Page 225				
YML011	670	860	770	410
YML012	670	1400	770	410
YPLA001	680	900	900	440
YPLA002	680	1450	900	440
Page 226				
YVAL01	830	785	810	440
YVAL02	830	1325	810	440
YVAL03	830	1870	810	440
YAZU001	900	930	920	460
YAZU002	900	1510	920	460
YAZU003	900	2090	920	460
Page 227				
YSA001F	730	830	730	440
YSA002F	730	1370	730	440
YSA003F	730	1900	730	440
YSA001L	730	830	730	440
YSA002L	730	1370	730	440
YSA003L	730	1900	730	440
Page 228				
Y600110	770	800	720	440
Y600115	530	800	130	440
Y600120	770	1200	720	440
Y600125	530	1200	130	440
Y600130	770	1600	720	440
Y600135	530	1600	130	440
Y600140	770	800	720	440
Y600145	530	800	130	440
Y600150	770	1500	800	440

Y600155	530	1500	130	440
Y600160	770	800	1320	440
Y600165	530	800	130	440
Page 229				
Y600170	770	1200	1320	440
Y600175	530	1200	130	440
Y600180	770	1600	1320	440
Y600185	530	1600	130	440
Y600190	770	1080	720	440
Y600195	530	1080	130	440
Y600200	770	1080	1320	440
Y600205	530	1080	130	440
Y600210	440	1320	660	440
Y600220	770	1080	720	440
Y600225	530	1080	130	440
Page 230				
YRAF1	460	670	715	450
YRAF1B	830	670	715	450
YRAF1BR	830	800	715	450
YRAF1BL	830	800	715	450
YRAF1BA	830	900	715	450
YRAF1CB	830	715	715	450
YRAF2	460	1340	715	450
YRAF2B	830	1340	715	450
YRAF2BR	830	1455	715	450
YRAF2BL	830	1455	715	450
YRAF2BA	830	1570	715	450
YRAF3	460	715	715	450
YRAFT	430	700	700	-
Page 231				
YRAFH1	1300	670	715	450
YRAFH1R	1300	800	715	450
YRAFH1L	1300	800	715	450
YRAFH1S	1300	900	715	450
YRAFH2	1300	1340	715	450
YRAFH2R	1300	1455	715	450
YRAFH2L	1300	1455	715	450
YRAFH2S	1300	1570	715	450
YRAFHCV	1300	1190	715	450
YRAFHCX	1300	1190	715	450
YRAFHC	1300	715	715	450
YRAFHV	1300	115	715	-
YRAFHVT	1300	665	715	-
YRAFHDT	1300	1215	715	-
Page 232				
YWHIS1	1200	1290	820	440
YWHIS2	1200	1150	820	440
YWHIS3	1200	1100	820	440
Page 233				
YCITB1	-	600	670	440
YCITDB1	-	1200	670	440
YCITTB1	-	1800	670	440
YCIT1	-	600	670	440
YCIT2	-	1200	670	440
YCIT3	-	1800	670	440

YCIT4	-	1090	670	440
YCITC1	-	770	770	440
YCITCON1	-	1090	670	440
YCITTAB2	-	880	880	440
YCITCTB	-	-	-	-
YCITCTW	-	-	-	-
YCITA1	-	170	470	170
YCITA2W	-	170	470	170
YCITA2B	-	170	470	170
Page 234				
Y608100	1060	670	765	500
Y608101	1060	670	765	500
Y608102	1040	670	765	480
Y608103	1040	670	765	480
Y608104	1320	670	765	480
Y608105	1320	670	765	480
Y608106	1300	670	765	480
Y608107	1300	670	765	480
Page 235				
Y609100	1160	770	740	430
Y609101	1160	770	740	430
Page 236				
Y609900	1760	1000	940	440
Y609901	430	730	670	-
Y609902	1650	1100	330	-
Page 237				
Y609800	2320	1500	1968	-
Y609801	2320	2110	1968	-
Page 238				
YSKYCP	470	725	725	470
YSKYSP	470	660	725	470
YSKYOCP	470	595	725	470
YSKYC	720	725	725	470
YSKYLS	720	650	725	470
YSKYRS	720	650	725	470
YSKYOC	720			

Code	o/a height	o/a width	o/a depth	seat height
Page 244				
YGLSHB	1170	-	-	450-580
YGLSHMA	1170	-	-	450-580
YGLSHAT	1170	-	-	450-580
YMPS66	1000	520	630	480-610
YMPS66FA	1000	640	630	480-610
YMPS66ADJ	1000	670	630	480-610
Page 245				
YE50622	1100	510	610	460-560
YE50622FA	1100	510	610	460-560
YE50622ADJ	1100	510	610	460-560
YEV50622	970	540	640	490
YEV50622A	970	590	640	490
Page 246				
YCHI1B	955	500	570	475-605
YCHI1BFX	955	620	570	475-605
YCHI1BAD	955	650	570	475-605
YCHI1BFA	955	640	570	475-605
YCHI1C	955	500	570	475-605
YCHI1CFX	955	620	570	475-605
YCHI1CAD	955	625	570	475-605
YCHI1CFA	955	640	570	475-605
YCHI2B	1095	500	570	620-870
YCHI2BFX	1095	620	570	620-870
YCHI2BAD	1095	650	570	620-870
YCHI2BFA	1095	640	570	620-870
YCHI2C	1095	500	570	620-870
YCHI2CFX	1095	620	570	620-870
YCHI2CAD	1095	625	570	620-870
YCHI2CFA	1095	640	570	620-870
Page 247				
Y610801	1078	617	617	485-533
Y610802	1258	617	617	485-533
Y610803	1078	617	617	485-533
Y610804	1078	617	617	485-533
YDES52	1150	510	-	490-600
YDES52ADJ	1150	670	-	490-601
YDES62	1330	510	-	490-602
YDES62ADJ	1330	670	-	490-603
YDESC50	990	540	620	490
YDESEX50	990	620	620	490
Y600420	990	490	500	440
Y600430	990	610	500	440
Y600440	990	490	500	490
Y600450	990	610	500	490
Task Seating				
Page 248				
YTRA11	1030	520	600	510-590
YTRA11FA	1030	640	600	510-590
YTRA11A	1030	640	600	510-590

Code	o/a height	o/a width	o/a depth	seat height
Page 249				
YHYP1	1120	510	-	500-600
YHYP1F	1120	590	-	500-600
YHYP1A	1120	670	-	500-600
YHYP1V	990	540	540	490
YHYP1VA	990	540	590	490
YHYP1VFA	990	540	620	490
YHYP2	1120	510	-	500-600
YHYP2F	1120	590	-	500-600
YHYP2A	1120	670	-	500-600
YHYP2V	990	540	540	490
YHYP2VA	990	540	590	490
YHYP2VFA	990	540	620	490
Page 250				
YTRA17	1070	535	570	510-630
YTRA17A	1070	690	570	510-630
YTRA18	1070	535	570	510-630
YTRA18A	1070	690	570	510-630
Y600630	1040	500	500	460
Y600640	1040	460	450	460
Y600650	890	460	400	420
Page 251				
YAI2	1040	540	630	490
YAI2A	1040	620	630	490
YAI2B	1105	530	-	450-550



Code	o/a height	o/a width	o/a depth	seat height
Page 252				
Y610500	1230	660	610	460-560
YRAC01	1210	650	620	480-560
Manager & Executive Seating				
Page 253				
YCHEL01	1170	690	650	460-545
YAMD1	1210	720	660	-
Y600230	1190	600	480	520
Y600235	1190	600	480	520
Page 254				
YERG1	1180	510	-	515-630
YERGH	1250	510	-	515-630
YERGMV	940	510	-	510
YERGP	1290	520	-	545-660
YERGPV	1290	520	-	545-660
Page 255				
YPP73	1160	505	-	480-610
YPP73ADJ	1160	505	-	480-610
YPP83	1370	505	-	480-610
YPP83ADJ	1370	505	-	480-611
Y600460	1410	510	480	500
Y600470	1410	510	480	500



Code	o/a height	o/a width	o/a depth	seat height
Conference Seating				
Page 256				
YVIS04	835	535	590	485
YVIS04A	835	535	590	485
YWES01	900	480	570	480
YWES02	900	550	570	480
YDHAT01	885	590	610	490
Page 257				
YVIS06	885	590	610	490
YVIS05	840	520	600	485
YVIS05A	840	530	635	485
Page 258				
YFP500MB	810	540	580	470
Y600570	810	505	500	460
YCOFL	810	470	510	470
YCOFLWT	810	470	510	470
YVIS01	800	470	530	470
Y600720	800	570	530	470
YVIS01A	800	570	530	470
Y600730	-	-	-	-
Page 259				
YVIS13	810	540	580	470
YVIS15	810	540	580	470
YVIS1BK	810	540	580	470
YVIS2R	810	540	580	470
YVIS3BL	810	540	580	470
YVIS4G	810	540	580	470
YVIS5P	810	540	580	470
YVIS16	810	540	580	470
YFLEFT	810	540	580	470
Page 260				
Y611700	800	530	540	450
Y611701	800	530	540	450
Y611702	800	530	540	450
Y611703	890	490	540	760



Code	o/a height	o/a width	o/a depth	seat height
Page 261				
Y612600	800	565	544	450
Y612602	800	565	544	450
Y612604	800	565	544	450
Y612606	800	565	544	450
Y612608	800	565	544	450
Y612610	800	565	544	450
Y612612	790	1750	544	470
Y612614	790	1750	544	470
Page 262				
Y613500	860	445	575	-
YTRAC1	840	515	560	480
YTRAC1PU	840	590	560	480
YTRACPP	840	590	560	480
YTRACCA	840	530	560	480
Page 263				
YVIS10	850	510	560	515
YVIS10A	850	610	560	515
YRESP01E	870	460	480	470
Y100149	830	530	570	470
Y100150	-	-	-	-
Y100151	-	-	-	-
Page 264				
YCATH	810	540	580	470
YCATHTR	-	-	-	-
Y612700	850	590	570	-
Y612701	850	600	570	-
Y612702	850	590	550	-
Y612703	850	600	710	-
Y612704	850	580	570	-
Y612705	1180	590	560	-
Y612706	1180	590	560	-
Page 265				
YKRA1	800	490	560	440
YKRA1S	800	490	560	480
YKRA1F	800	490	560	480
YKRA2	800	520	560	440
YKRA2S	800	520	560	480
YKRA2F	800	520	560	480
YKRA3	800	550	560	440
YKRA3S	800	550	560	480
YKRA3F	800	550	560	480
YKRATR	-	-	-	-
Page 266				
Y600530	840	490	525	450
Y600540	840	490	525	450
Y600550	840	490	525	450
Y600560	840	490	525	450
Y600740	600	700	380	-
Y16716	-	-	-	-
Page 267				
YFUS1	845	440	535	460
YFUS1A	845	490	535	460



All dimensions shown in mm. Please ask for assistance

Phoenix

- Phoenix is a simple crepe weave fabric
- Available in 21 top selling colours
- Made from 100% polyester
- This hardwearing fabric is rated at 100,000 Martindale abrasion cycles



Please phone for a free swatch

Due to limitations in the printing process when fabric is shown photographically, we recommend that you ask for actual fabric samples before ordering.

Standard Fabrics Range



Task seating



Cigarette & Match



Year Guarantee



Advantage

- Advantage is the UK's top selling Low Hazard seating fabric
- Its high performance durability comes from its blend of 30% wool and 70% gylmene - a synthetic fibre originally developed for use in broadloom carpets
- It is rated at 75,000 Martindale abrasion cycles



Task seating



Cigarette & Match



Year Guarantee



For a wider range of fabric options, please call us today.

Standard Fabrics Range

Era

- Era is a subtle, two tone polyester fabric containing stretch in both directions for ease of upholstery.
- The baby herringbone weave offers an understated contemporary texture while its colouring technique provides close up intrigue. The palette incorporates playful brights and sophisticated muted tones.



Task seating



Soft seating



Cigarette & Match



Washable



year guarantee

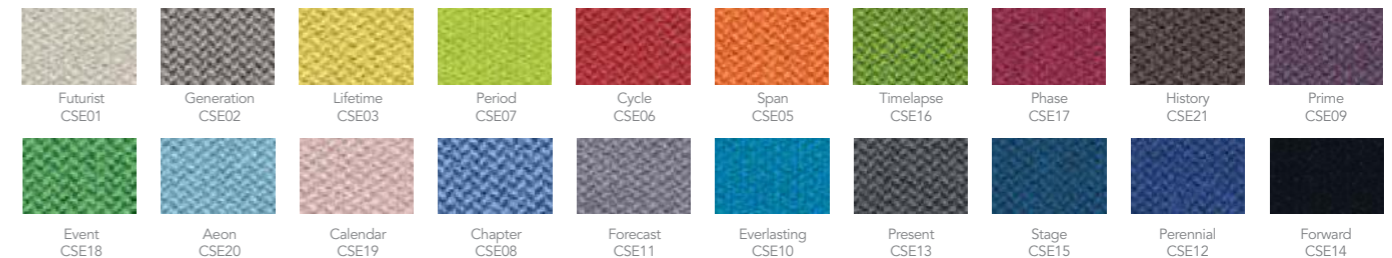

Rivet

- Rivet is a fixating fabric which connects with the modern collaborative workplace and forms a bridge between textile traditions and future innovation.
- Rivet is a lightly textured hopsack which emulates the swathe of suiting in a well-heeled synthetic. Made from 100% REPREVE®, a brand of recycled polyester made from used plastic bottles.



Task seating



Soft seating



Cigarette & Match



Washable



environmental



year guarantee



For a wider range of fabric options, please call us today.

Premium fabrics - ALL SEATING IN THESE FABRICS AVAILABLE POA

Special Fabrics Range

Intervene performance fabric



Intervene plain

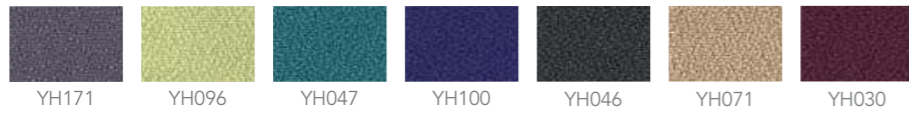

Intervene texture



Please phone with your choice of seating for prices in these fabrics

X2 plus fabric options



Due to limitations in the printing process when fabric is shown photographically, we recommend that you ask for actual fabric samples before ordering.

Premium fabrics - ALL SEATING IN THESE FABRICS AVAILABLE POA

Special Fabrics Range

Just colours vinyls

Just Colour harmonizes with both contemporary and traditional interiors. The broad palette encompasses modern neutrals, warm classics to vivid bright colours.

Designed to withstand the rigorous demands of both heavy domestic and contract upholstery, Just Colour is suitable for a wide variety of applications.

- Flame Retardancy: BS5852 Ignition Source 5, BS7176 Medium Hazard, S.I. 1988 No. 1324 schedule 4&5, EN1021-1&2, CS-25, FMVSS 302 and IMO A 652 (16)
- Abrasion: 100,000+



Exhilarate fabric options



Due to limitations in the printing process when fabric is shown photographically, we recommend that you ask for actual fabric samples before ordering.



Let us create a warm welcome to your school or office.

Clean, flowing lines give a confident, professional impression your visitors are sure to remember. Call us today to discuss your requirements.

Receptions

Colorado	282
Tromsø	283
Oval	284
Venice	285
Venice Ice	286
Abstract	287
Luna	288
Castello	289
Lunae	290
Bespoke	291
Plants	292-293

Receptions

First impressions count don't they? What do visitors see when they arrive at your school? It needs to be something that endorses the excellence that exists throughout the school, warmly welcomes and is pleasant for staff to work at.

We can help you achieve that in reception areas large and small from a simple one piece unit to a fully bespoke design unique to you.

Let us help you achieve the great result you want – why not call us now and we can begin the process at once.



Due to limitations in the printing process, wood and colour finishes shown throughout the catalogue may not be representative of actual colour. Samples are available on request.



Colorado

- Ideal for school receptions or libraries, Colorado counters are beautifully crafted in durable, wood effect melamine
- Traditional look with practical features please ask for specific quote
- Satin anodised kickplate option
- A range of matching pedestals and bookcases is also available

Wood & colour finishes may not be representative of actual colours - please ask for a sample. Other colours available - please enquire.

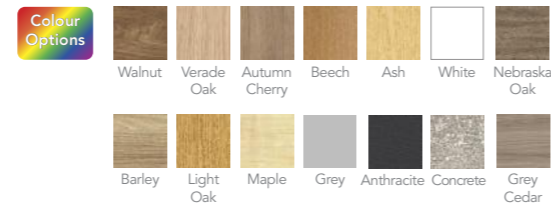

Page Link - see page
Matching office desking 326-330



Tromsø

Timeless design in a modern office.

- A flexible modular system available in different shapes, straight and curved, also, in several height combinations for different-sized offices
- Choose from different textures and colours to create your desired style reception: secretive and minimalist or cosy and harmonious



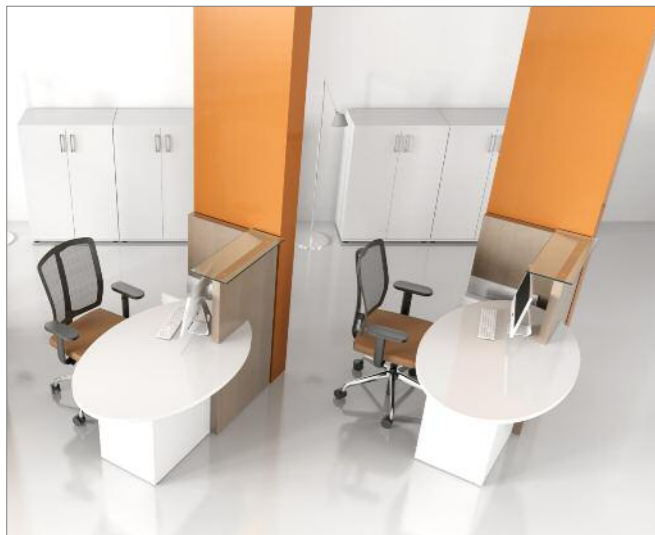

Oval

The Oval is a multifunctional reception desk dedicated to small rooms or entrances where there is minimal space.

- The lowered desk top makes it easy to communicate with persons in a sitting position
- The common part of the desk top is tempered frosted glass, which allows the user to deal with documents easily and provides trouble-free communication
- The lifted part includes a hidden computer stand and a vertical shelf for files and documents
- Available in Cocoa or Chestnut finish panels with white body
- Available left or right handed
- 5 year warranty

Y500100	Oval Right Handed	£885.00
Y500105	Oval Left Handed	£885.00

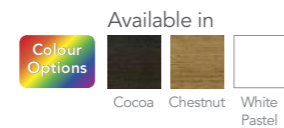

Venice

- Stylish and sleek yet practical, Venice counters are the choice for the discerning school desiring to make a statement
- The option of a glass top and chrome strip detailing enhances the contemporary appeal, showcasing the brilliant white laminate to maximum effect
- Modular construction enables countless configuration options
- Subtle LED lighting adds a sophisticated style and gives the impression the room is bigger





Venice ice

- A range of cool white reception furniture that makes a stunning visual impact and can be enhanced further by the use of low level mood lighting
- Due to a wide range of available elements, the shape of the Venice Ice range can be configured in various forms. From a circle through an arch, to angular or simple blocks
- The body of the counter includes hidden handy shelves and a wide working table with enough space for a computer or printer
- Subtle LED lighting adds a sophisticated style and gives the impression the room is bigger

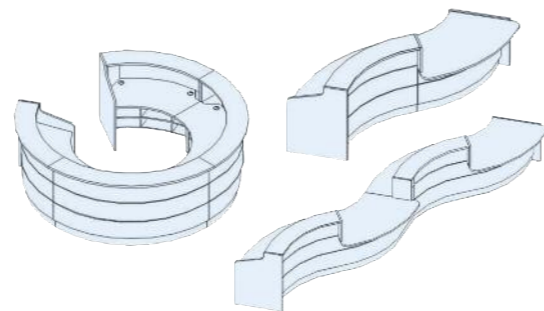

Abstract

A range of contemporary modular reception furniture that uses bold, abstract lines for dramatic effect.

This desk with its original form should be enough to arrange every reception hall. The white, metal openwork wreathing subtly round the body and contrasting with the highlighted interior is a very characteristic element of the reception counter.

Very effective in dark rooms, the LED lighting can be changed to different colours to create different moods.





Luna

- Using three rectangular elements, these can be joined side by side to create a longer unit
- The modules equipped with LED-lighting add delicacy and improve working conditions in darker rooms
- Brushed aluminium used in the kickplate perfectly matches the white colour of the reception counter

Y500110	Luna Reception Counter	£1,719.00
Y500111	Luna Drawer with Lock	£121.00

Available in:

Colour Options

Aluminium White Pastel

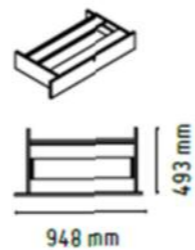

Castello

- A refreshing reception system combining high gloss HPL with MFC in a choice of six finishes
- It is a modular solution that allows the creation of compact or large reception counters depending on requirements
- It comes with an optional top highlighted with LED lighting

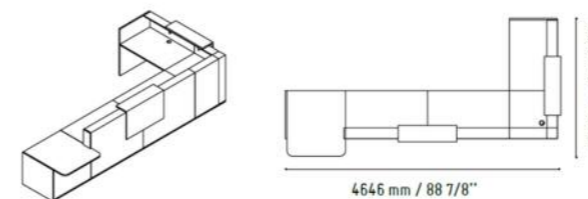

Available in:

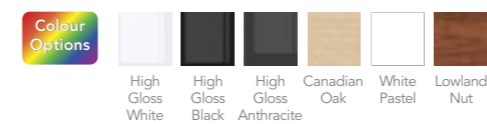

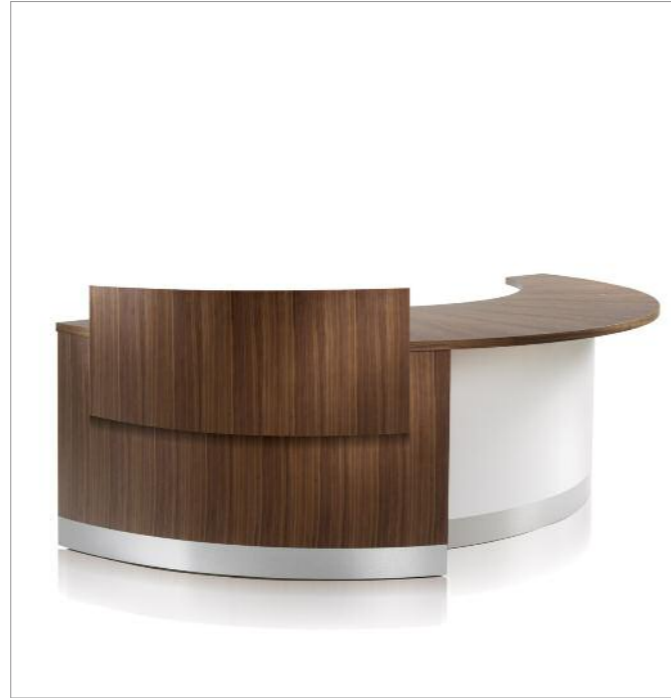

Lunae

Inspired by the demand for compact reception furniture, this crescent shaped desk is ideal. Featuring a genuine wood veneer counter top which tapers from 800mm to 240mm, Crescent desks are able to neatly fit into corners and tight spaces with a small footprint.

For Dramatic visual effect, the veneered top of the Lunae reception furniture can be teamed with a recessed counter front in a contrasting laminate instead of a matching veneer.

Colour adjustable 'mood lighting' fitted under the desk top, looks particularly effective in reception areas with low ambient light.

Finishes available:

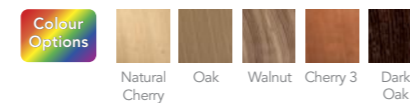

Bespoke Reception Furniture

- We are able to work to your exact requirements or architect's specifications, produced in either real wood veneers or laminated MFC
- At an early stage of planning we cover all aspects including DDA, lighting, induction loop facilities, and then tailor specific finishes, to enhance and create the stunning impression you want to portray
- A huge range of colours and wood finishes are available

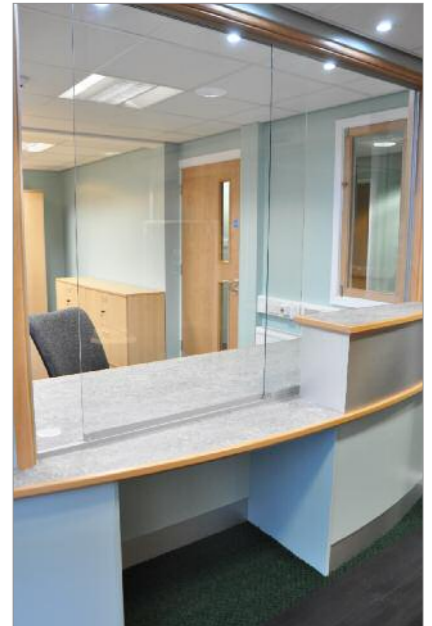



All dimensions shown as height x width x depth

A. YPLPC	Cycus Palm in Black Maxi Pot Internal Use	£75.00	D. YPLGFL	Natural Stemmed Green Ficus Liana Tapered Square Metal	1600 x 250 x 250mm	£87.00
B. YPLOO	Oriental Orchid Vase Silver Foil Pot, Desk Top Use	450 x 450 x 180mm £44.00	E. YPLRA*	Red Anthurium, Internal Use, 1100 x 300 x 300mm		£198.00
C. YPLVO	Vanda Orchid Vase Silver Foil Pot, Desk Top Use	400 x 180 x 180mm £44.00	F. YPLSV	Sansevieria in White Maxi Pot Internal Use		£69.00



Office Plants

Office plants and interior landscaping are an important element in workspace design. This offers huge benefits to staff engagement and well-being whilst simultaneously enhancing your image to prospective parents, clients and visitors.

This selection of replica plants offers an opportunity to gain all the aesthetic benefits. Replica plants are virtually zero maintenance, made with the finest materials and manufactured with expertise so that most would struggle to tell the difference from the real thing.

There are many benefits to furnishing your office or workspace environment with plants. The introduction of natural forms has been proven to create a calming influence which in turn improves concentration – and ultimately productivity.

If you would prefer the real thing, please get in contact with us.



All dimensions shown as height x width x depth

G. YPLBP*	Bird of Paradise, Internal Use, 1300 x 300 x 300mm	£234.00	J. YPGASV	Green Aloe in Silver Pot, Internal Use	£185.00
H. YPLGAS*	Green Aloe in Tapered Circle, Internal Use 1250 x 300 x 300mm	£234.00	K. YPLSBE*	Spiral Buxus, External Use, 1600 x 350 x 350mm	£288.00
I. YPLPBE*	Pyramid Buxus, External Use, 1200 x 300 x 300mm	£298.00	L. YPLPP*	Phoenix Palm, Internal Use, 2200 x 350 x 350mm	£390.00
		£234.00			

* Any RAL Colour for Pot



Is your meeting room giving the right impression?

Talk to us about the best solutions for your meeting rooms, board room and conference facilities.

Conference & Meeting Tables

Alpine	296-297, 304
Nova	298
Galway	299
Wexford	299
Colorado	300-302, 305
Orbit	303, 306
Bespoke	307

Conference & Meeting Tables

In the following pages you will find a beautiful and practical choice of tables of every size and type.

Folding and flip-top for multi-use areas, boardroom tables for where it gets serious and much more – let's not forget coffee tables and staff room needs.

Need help planning? – ring us today, we are always delighted to help.



Due to limitations in the printing process, wood and colour finishes shown throughout the catalogue may not be representative of actual colour. Samples are available on request.



Alpine Meeting & Conference Tables

Smart and business like, Alpine Conference tables are perfect for when you need a touch of class on a modest budget.

All our Alpine conference tables come with 25mm tops, 3mm lippings, a sturdy timber panel base or pole legs with a metal underframe. For an added touch of class why not have a pedestal column base?

A. Round tables - pole leg

- H720mm

YCZM100	Pole Legs, Ø1000mm	£168.00
YCZM120	Pole Legs, Ø1200mm	£206.00

B. Round tables - panel leg

- H720mm

YCOM101	Panel Leg, Ø1000mm	£218.00
YCOM121	Panel Leg, Ø1200mm	£239.00

C. Round tables - pedestal base

- H720mm

YCOM090	Metal Pedestal Base, Ø900mm	£379.00
YCOM100	Metal Pedestal Base, Ø1000mm	£398.00
YCOM120	Metal Pedestal Base, Ø1200mm	£424.00



Alpine Tables MFC Finishes

Group 1 Colours

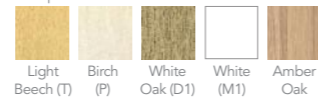

Group 2 Colours



Wood & colour finishes may not be representative of actual colours - please ask for a sample

A



B



C



Alpine Meeting & Conference Tables

Smart and business like, Alpine Conference tables are perfect for when you need a touch of class on a modest budget.

All our Alpine conference tables come with 25mm tops, 3mm lippings, a sturdy timber panel base or pole legs with a metal underframe. For an added touch of class why not have a pedestal column base?

A. D-end tables

- Choice of pole or panel legs
- D1000 x H720mm

YCZM201	Panel Leg, L2000	£335.00
YCZM241	Panel Leg, L2400	£388.00
YCZM200	Pole Legs, L2000 (Attached to Metal Underframe)	£349.00
YCZM240	Pole Legs, L2400 (Attached to Metal Underframe)	£402.00

B. Square-end tables

- Choice of pole or panel legs
- D1000 x H720mm

YCZM203	Panel Leg, L2000	£329.00
YCZM202	Pole Legs, L2000 (Attached to Metal Underframe)	£355.00

C. Barrel top table

- Choice of pole or panel legs
- D1200 x H720mm

YCZM243	Panel Leg, L2400	£378.00
YCZM242	Pole Legs, L2400 (Attached to Metal Underframe)	£399.00



A



B



C

The following table is for guidance only

Style	1200mm	1400mm	1600mm	1800mm	2000mm	2400mm
Square End	4 Seater	4 Seater	4 Seater	6 Seater	6 Seater	8 Seater
D End				6 Seater	8 Seater	8 Seater
Barrel Top			6 Seater	6 Seater	8 Seater	8 Seater
Circular	4/5 Seater	5-7 Seater	6-8 Seater			



Nova Conference Tables

- Modern, minimal and charming
- Nova conference tables have the huge benefit of no intermediate legs along the sides no matter how long you make the table. Freedom of movement with comfort, especially when you have to pack that extra person in
- Ultra modern technical design includes full optional cable management for IT supported conferences. Don't miss the matching Nova bench desking system on page 314
- Infinitely extendable using extensions YCNM144 and YCNM164

Colour Options

Group 1 Colours

- Light Beech (T)
- Birch (P)
- White Oak (D1)
- White (M1)
- Amber Oak

Group 2 Colours

- Walnut (U)
- Light Grey (N)

Wood & colour finishes may not be representative of actual colours - please ask for a sample

Frame Options

- White
- Silver Grey

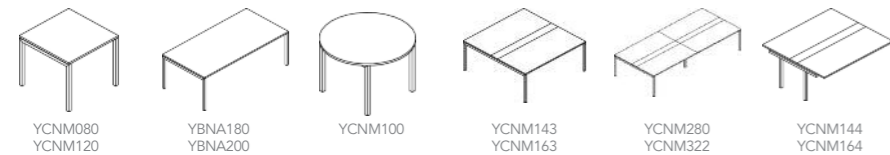

Tables

YCNM080	L800 x W800 x H740mm	£255.00	YCNM143	L1400 x W1640 x H740mm	£539.00
YCNM120	L1200 x W1200 x H740mm	£397.00	YCNM163	L1600 x W1640 x H740mm	£568.00
YBNA180	L1800 x W1000 x H740mm	£395.00	YCNM280	L2800 x W1640 x H740mm	£988.00
YBNA200	L2000 x W1000 x H740mm	£412.00	YCNM322	L3200 x W1640 x H740mm	£1012.00
YCNM100	Diameter 1000 x H740mm	£276.00	YCNM144	L1400 x W1640 x H740mm	£469.00
YCNM200	L1200 x W2000 x H740mm	£503.00	YCNM164	L1600 x W1640 x H740mm	£503.00



Accessories

Cable Trays

YZNZ001	L1400 x W180mm	£52.00
YZNZ002	L1600 x W180mm	£64.00
YZNZ004	L1400 x W180mm	£52.00
YZNZ005	L1600 x W180mm	£64.00
YZNZ007	L1400 x W180mm	£52.00
YZNZ008	L1600 x W180mm	£64.00

Cable Ports

YZNZ010	L320 x W130mm	£51.00
---------	---------------	--------

Shared Cable Trays for Bench Desking

YCTS110	L1100 x W180 x H110mm	£53.00
YCTS140	L1400 x W180 x H110mm	£64.00

Galway

Rustic and full of character, Galway's 40mm solid oak tops really bring out the timeless beauty of natural wood. With its chunky steel underframe, these tables and benches carry serious presence!

These can be used with soft seating or conference chairs.

- 40mm Tops
- 740mm high
- Lacquered finish
- 'A' profile leg frame available in black only
- 5 year warranty
- Also available with 36mm MFC top

Rectangular Meeting Tables

		Top	
Y660200	1800 x 900mm	Solid Oak	£1189.00
Y660201	1800 x 900mm	MFC	£579.00
Y660202	2000 x 1000mm	Solid Oak	£1369.00
Y660203	2000 x 1000mm	MFC	£636.00

Rectangular Meeting Benches

		Top	
Y660204	1800 x 300mm	Solid Oak	£595.00
Y660205	1800 x 300mm	MFC	£328.00
Y660206	2000 x 300mm	Solid Oak	£636.00
Y660207	2000 x 300mm	MFC	£349.00

As with all natural products, variations may occur.

Colour Options

Oak Top

- 40mm Solid Oak

MFC Top Finishes 36mm

- Light Oak
- Walnut
- Champagne
- White
- Graphite

Leg Colour

- Black
- White

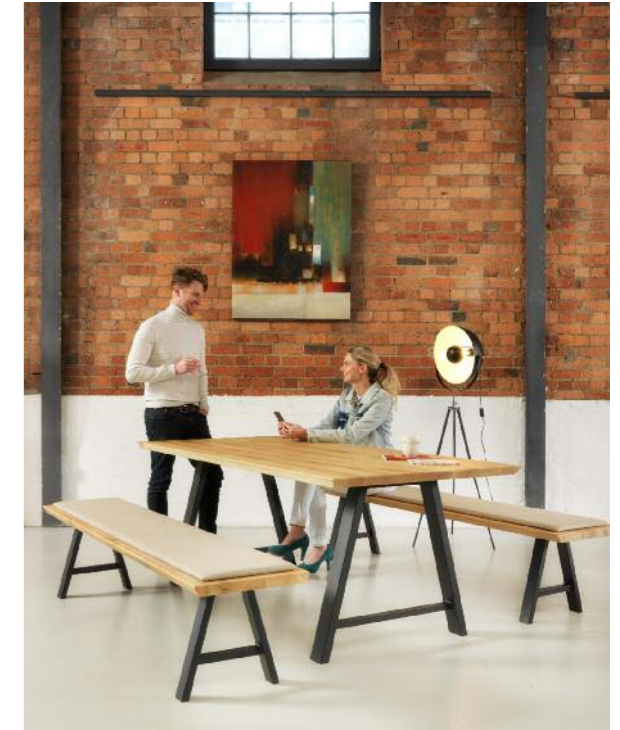

Wexford meeting tables

A clean, straight line and simple design make the Wexford a very desirable table. Supplied in a range of eleven finishes. It's triangular steel leg profile creates an alluring aura of class and is available in a choice of three colours giving scope to enhance any meeting room.

- 25mm top
- 740mm high
- Available with optional power and data fittings
- 5 year warranty
- Black or White frames supplied as standard, Chrome frames available POA

Wexford Square Meeting Tables

Y660300	1200 x 1200	£649.00
Y660302	1600 x 1600	£776.00

Wexford Rectangular Meeting Tables

Y660312	2000 x 1000	£995.00
---------	-------------	---------

Colour Options

- Beech
- Graphite
- Grey Oak
- Light Grey
- Light Oak
- Maple
- Natural Elm
- Stone Grey
- Walnut
- Black
- White



Page Link - see page
For soft seating... 238,239





Colorado Tables

Colorado tables are available with a choice of 3 leg options - Cantilever, Panel or Cantilever Plus. When ordering please add the suffix code X, P or C to the product code to denote the leg style you require as follows:

Cantilever: Code 'C' - Single leg in graphite (G) or silver (S)
 Panel: Code 'P' - Panel leg in chosen board finish
 Cantilever Plus: Code 'X' - Twin upright legs in white (W) or silver (S)

For example, order code YCTR12-8XW for a conference table with Cantilever Plus legs in White. Please note that if no leg colour is specified silver will be supplied as standard.

A. Rectangular tables

Code	Dimensions W x D x Hmm	Price for Each Leg Style		
		C	P	X
YCTR12-8	1200 x 800 x 727	£248.00	£248.00	£268.00
YCTR14-8	1400 x 800 x 727	£258.00	£258.00	£279.00
YCTR16-8*	1600 x 800 x 727	£271.00	£271.00	£293.00
YCTR18-8*	1800 x 800 x 727	£290.00	£290.00	£314.00
YCTR20-8*	2000 x 800 x 727	£306.00	£306.00	£330.00

- Legs are inset by 200mm from the ends of the table
- * Also available with cutout for one standard AE-EPM-2P2D power module (please request power module cutout when ordering)

B. Barrel tables

Code	Dimensions W x D x Hmm	Price for Each Leg Style		
		C	P	X
YCTB16-8*	1600 x 800 x 727	£323.00	£323.00	£345.00
YCTB18-8*	1800 x 800 x 727	£342.00	£342.00	£366.00
YCTB20-8*	2000 x 800 x 727	£358.00	£358.00	£382.00

- Legs are inset by 200mm from the ends of the table
- * Also available with cutout for one standard AE-EPM-2P2D power module (please request power module cutout when ordering)

C. Double d-ended tables

Code	Dimensions W x D x Hmm	Price for Each Leg Style		
		C	P	X
YBD6*	1800 x 1200 x 727	£366.00	£366.00	£382.00
YBD8*	2400 x 1200 x 727	£458.00	£458.00	£474.00

- Legs are inset by 200mm from the ends of the table
- * Also available with cutout for one standard AE-EPM-2P2D power module (please request power module cutout when ordering)

A

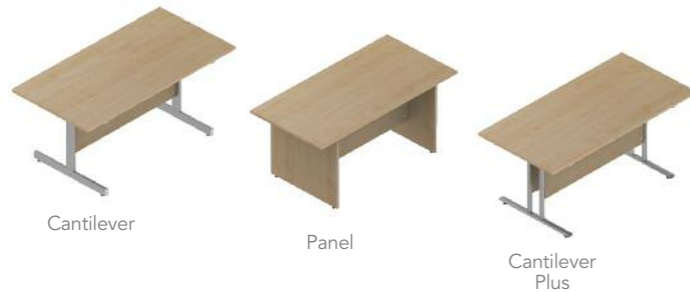

Cantilever

Panel

Cantilever Plus

B



Cantilever

Panel

Cantilever Plus

C



Cantilever

Panel

Cantilever Plus



See page 302

Wood finishes: Ash, Autumn Cherry, Beech, Barley, Grey, Light Oak, Maple, Verade Oak, Nebraska Oak, Anthracite, Concrete, Grey Cedar, Walnut or White.



Colorado Executive Tables

- Stylish range of conference and meeting tables to match with the Colorado Executive Furniture
- Attractive shaped leg design

A. Conference tables

Rectangular	W x D x Hmm	
YPCTR128	1200 x 800 x 727	£259.00
YPCTR148	1400 x 800 x 727	£275.00
YPCTR168	1600 x 800 x 727	£291.00
YPCTR188	1800 x 800 x 727	£308.00

- Legs are inset by 200mm from the ends of the table

Circular

YPCTC10	1000Ø x 727	£344.00
YPCTC12	1200Ø x 727	£359.00
YPCTC15	1500Ø x 727	£402.00

Barrel

YPCTB16	1600 x 1000/800 x 727	£342.00
YPCTB18	1800 x 1000/800 x 727	£359.00
YPCTB20	2000 x 1000/800 x 727	£378.00

- Legs are inset by 200mm from the ends of the table

B. Boardroom tables

Double D-Ended

		W x D x Hmm	
YPBD6*	6 Seater	1800 x 1200 x 727	£388.00
YPBD8*	8 Seater	2400 x 1200 x 727	£649.00
YPBD10*	10 Seater	3200 x 1200 x 727	£906.00
YPBD12*	12 Seater	4000 x 1200 x 727	£955.00
YPBD14*	14 Seater	4800 x 1200 x 727	£1015.00
YPBD16**	16 Seater	5600 x 1200 x 727	£1255.00
YPBD18***	18 Seater	6400 x 1200 x 727	£1465.00
YPBD20***	20 Seater	7200 x 1200 x 727	£1580.00

- * Also available with cutout for one standard AE-EPM-2P2D power module
- ** Also available with cutout for two standard AE-EPM-2P2D power modules
- *** Also available with cutout for two standard AE-EPM-2P2D power modules
- Please request power module cutout when ordering
- Legs are inset by 500mm from the ends of the table



See page 302

A



B



Larger tables may be supplied in more than one piece



Colorado Pole Leg Tables

A range of multipurpose tables with fully welded frames and 40mm round tubular legs. Finished in 25mm MFC with 2mm ABS edging.

A. Multipurpose square tables

	Size (mm) W x D	
YMTR06-6	600 x 600	£138.00
YMTR07-7	750 x 750	£164.00
YMTR08-8	800 x 800	£159.00

B. Multipurpose rectangular tables

YMTR12-6	1200 x 600	£171.00
YMTR15-7	1500 x 750	£191.00
YMTR10-8	1000 x 800	£167.00
YMTR12-8	1200 x 800	£177.00
YMTR14-8	1400 x 800	£188.00
YMTR16-8	1600 x 800	£199.00
YMTR18-8	1800 x 800	£212.00

C. Multipurpose trapezoidal tables

YMTZ12-6	1200 x 600	£202.00
YMTZ15-7	1500 x 750	£212.00
YMTZ16-8	1600 x 800	£237.00

• Internal angles 60° / 120°.

D. Multipurpose semi-circular tables

YMTS12-6	1200 x 600	£202.00
YMTS15-7	1500 x 750	£212.00
YMTS16-8	1600 x 800	£237.00

E. Multipurpose circular tables

	Diameter (mm)	
YMTC09	900ø	£185.00
YMTC12	1200ø	£210.00

A



B



C



D



E



Wood Finish Options

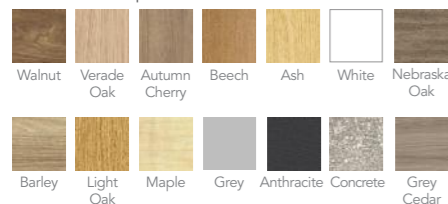

For larger quantities please phone for pricing

IMPORTANT:
When ordering, please specify the leg colour and table height you require.
Leg frames are available in Graphite, Silver or White
Frame heights: 460, 530, 590, 640, 710, 727 & 760mm high

Orbit Tilt Top Tables



Orbit tilt top tables

Ideal for Meeting Rooms or Classrooms



- Selection of 6 wood finishes
- Lockable castors
- Tubular steel polished chrome finish metalwork
- Linking mechanism available on request
- Can be nested together to save space when folded
- Available in 2 sizes of trapezoidal shape. use 3 x 30° or 4 x 22.5° to make a horseshoe
- All 720mm high



Polished Chrome Frames



Y15045	1600 x 800mm	Rectangular	£325.00
Y15047	1800 x 800mm	Rectangular	£339.00
Y15049	1412 x 740mm	Trapezoidal 22.5°	£325.00
Y15051	1600 x 693mm	Trapezoidal 30°	£325.00
Y15053	1600 x 800mm	Semi-Circular	£325.00

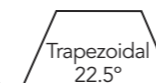

Matches other Orbit products on page 306

Wood & colour finishes may not be representative of actual colours - please ask for a sample

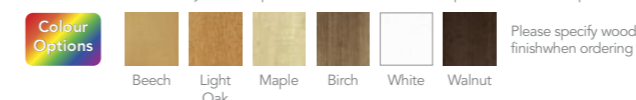

Alpine Tilt Top Tables

TABLES - TILT TOP

700MM DEEP

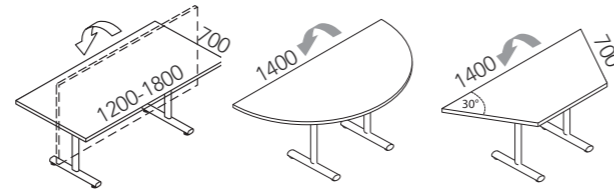

With silver tilt-top base with castors

YDFT122	Rectangular Table, 2 Leg, W1200	£274.00
YDFT142	Rectangular Table, 2 Leg, W1400	£282.00
YDFT162	Rectangular Table, 2 Leg, W1600	£288.00
YDFT182	Rectangular table, 2 Leg, W1800	£308.00
YDFT183	Half Round Table, 2 Leg, W1400	£294.00
YDFT185	Trapezoid Table, 2 Leg, W1400	£299.00

Alpine Tables MFC Finishes

Group 1 Colours

Light Beech (T)	Birch (P)	White Oak (D1)	White (M1)	Amber Oak	Walnut (U)	Light Grey (N)

Group 2 Colours

Wood & colour finishes may not be representative of actual colours - please ask for a sample

800MM DEEP

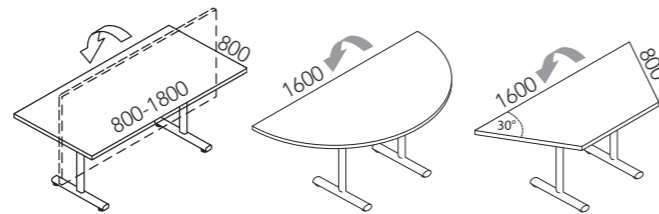

With silver tilt-top base with castors

YDFT121	Rectangular Table, 2 Leg, W1200	£288.00
YDFT141	Rectangular Table, 2 Leg, W1400	£299.00
YDFT161	Rectangular Table, 2 Leg, W1600	£312.00
YDFT181	Rectangular Table, 2 Leg, W1800	£318.00
YDFT160	Half round Table, 2 Leg, W1600	£312.00
YDFT184	Trapezoid Table, 2 leg, W1600	£320.00

Page Link - see page 241

Alpine Coffee Tables



Colorado Tilt Top Tables

A. Rectangular tilt top tables 800mm deep

	Dimensions (mm) W x D x H	
YRTTR08-8	800 x 800 x 727	£275.00
YRTTR10-8	1000 x 800 x 727	£282.00
YRTTR12-8	1200 x 800 x 727	£289.00
YRTTR14-8	1400 x 800 x 727	£299.00
YRTTR16-8	1600 x 800 x 727	£310.00
YRTTR18-8	1800 x 800 x 727	£322.00

• Tip top tables feature a tilting top from a horizontal to a vertical position using a single lever bar with integrated locking action. Fitted with 2 lockable & 2 non-lockable castors.

B. Rectangular tilt top tables 600mm deep

	Dimensions (mm) W x D x H	
YRTTR08-6	600 x 600 x 727	£250.00
YRTTR10-6	1000 x 600 x 727	£273.00
YRTTR12-6	1200 x 600 x 727	£278.00
YRTTR14-6	1400 x 600 x 727	£284.00
YRTTR16-6	1600 x 600 x 727	£290.00
YRTTR18-6	1800 x 600 x 727	£302.00

C. Trapezoidal tilt top tables

	Dimensions (mm) W x D x H	
YRTTZ12-6	1200 x 600 x 727	£298.00
YRTTZ16-8	1600 x 800 x 727	£324.00

• Internal angles of the trapezoidal are 60° & 120°. The depth is the length along the angled side.

D. Semi-circular tilt top tables

	Dimensions (mm) W x D x H	
YRTTS12-6	1200 x 600 x 727	£298.00
YRTTS16-8	1600 x 800 x 727	£324.00

E. Circular tilt top tables

	Diameter x Height (mm)	
YRTTC10	1000ø x 727	£320.00

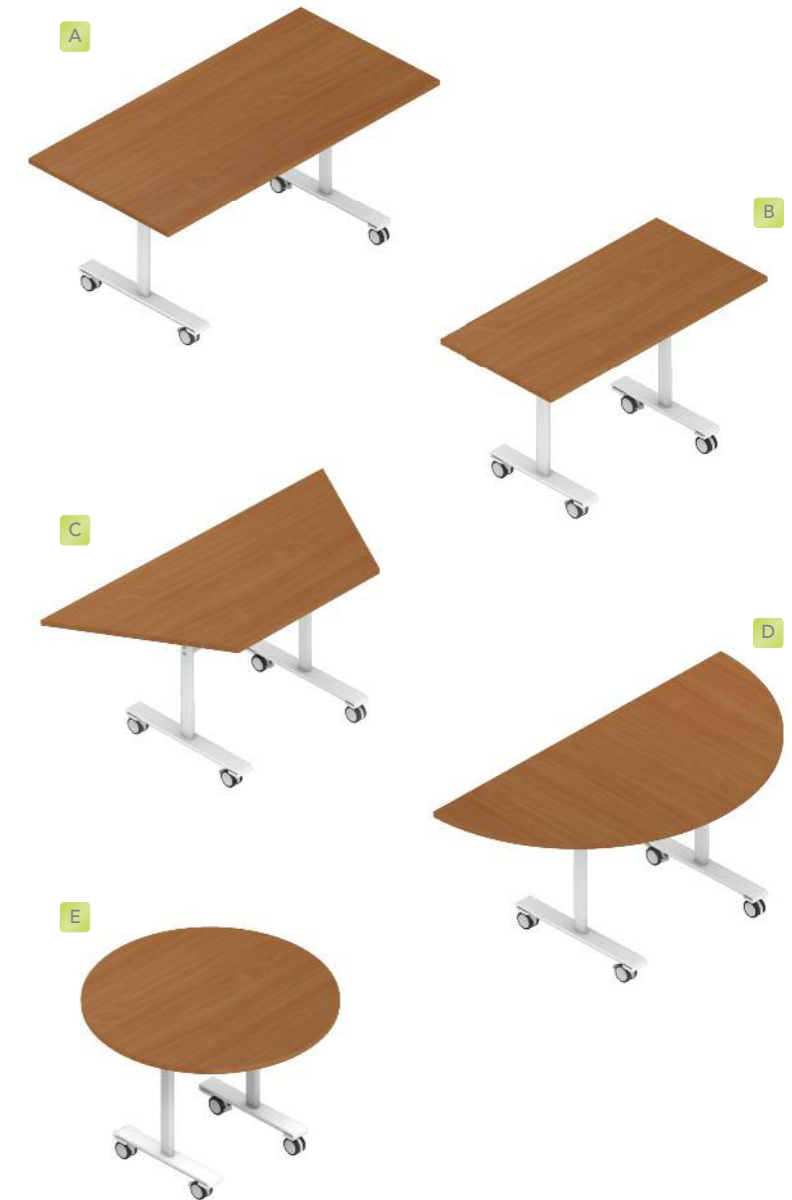

Wood Finish Options

Walnut	Verade Oak	Autumn Cherry	Beech	Ash	White	Nebraska Oak	Barley	Light Oak	Maple	Grey	Anthracite	Concrete	Grey Cedar

IMPORTANT
When ordering, please specify the leg colour and wood finish you require. Leg frames are available in Silver or White

Orbit Boardroom Barrel Top Tables



Orbit boardroom barrel top tables

- Premium stylish conference tables available with wooden or metal modesty panel
- Panel end frame
- 25mm tops and legs
- Beech finish as standard

		Std Panel	Metal Panel
YSTB18	W1200 x L1800mm	£705.00	£784.00
YSTB24	W1200 x L2400mm	£809.00	£869.00

Page Link - see pages
Matching office desking
320-323



Wood & colour finishes may not be representative of actual colours - please ask for a sample

Colour Options

Please specify wood finish when ordering



Bespoke Conference Tables

- Made to measure, designed to impress - the possibilities are endless
- Bespoke tables can be made exactly to your specification, including leg frame, top shape, top colour etc.
- Please call for a representative to come and plan your table with you
- Hand crafted
- Stunning effects
- True quality
- Extremely wide range of styles and finishes
- Full CAD planning available





Is your office working for you?

Our ergonomic desks will fit your space and our efficient storage range will maximize your work area.

Office Desking & Storage

Alpine Panel Leg Desking	310-311	Meeting Ends	336-337
Alpine Cantilever Leg	312	Pigeon Hole units	338
Alpine Pedestals	313	Executive Desking	339
Nova Bench Desking	314	Dormitories	340-343
Modesty Panels	315	Screens	315, 344-345
Alpine Storage	316-319	Cable Management	315, 346-347
Orbit Panel Leg Desking	320	Monitor Arms & CPU Holders	348-349
Orbit Storage	321	Storagewall	350-353
Signature Storage	322-323	Steel Storage	354-358
Orbit Height Adjustable desks	324	Steel Cupboards	359-360
Vermont Height Adjustable Desks	325	COSHH Cabinets	360-361
Colorado Desking	326-329	Steel Pedestals	362
Colorado Executive Desks	330-331	Safes	363-365
Colorado Pedestals	332	Filing Cabinets	365
Colorado Storage	333-335		

Office Desking & Storage

School and college offices are busy places! As you know, when you choose furniture it is essential it is designed to help you work more efficiently. We all like to work in a pleasing environment too, with style and colour choices each as important as the quality and functionality. We have a saying "form should equal function" – the wide choice in this section does exactly that and will enable you to find precisely what you need to create the best offices possible without breaking the bank or the bursar's heart!

We'd love to help! The choice can be bewildering and we can measure, plan and advise to ensure you get the best possible result – don't hesitate – call us today.

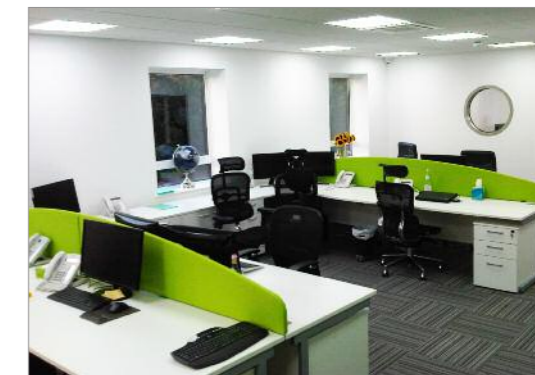

Due to limitations in the printing process, wood and colour finishes shown throughout the catalogue may not be representative of actual colour. Samples are available on request.



Alpine Panel Leg Desking

- A complete and versatile range of well-priced, traditionally styled office furniture.
- 25mm work tops with 3mm edging, solid 25mm leg and modesty panels
 - Six finishes to choose from and a range of matching pedestals, storage and meeting tables (see other pages)
 - Cable trays also available (see page 349)

5 Year Warranty

Straight workstations

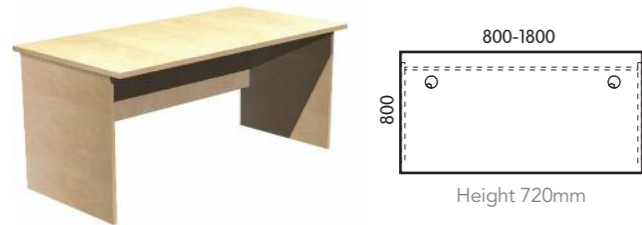

DDA081	L800mm	£143.00
DDA101	L1000mm	£151.00
DDA121	L1200mm	£161.00
DDA141	L1400mm	£175.00
DDA161	L1600mm	£187.00
DDA181	L1800mm	£204.00

Wave workstations 1000mm deep



DDL122	Left	L1200mm	£187.00
DDR122	Right	L1200mm	£187.00
DDL142	Left	L1400mm	£217.00
DDR142	Right	L1400mm	£217.00
DDL162	Left	L1600mm	£222.00
DDR162	Right	L1600mm	£222.00

800mm deep also available

Crescent workstations



DDL141	Left	L1400 x W1200mm	£238.00
DDR141	Right	L1400 x W1200mm	£238.00
DDL161	Left	L1600 x W1200mm	£248.00
DDR161	Right	L1600 x W1200mm	£248.00
DDL181	Left	L1800 x W1200mm	£268.00
DDR181	Right	L1800 x W1200mm	£268.00
DDB120	Symmetrical Corner	L1200 x W1200 x D600mm	£236.00

Workstation extensions



DDD082	L800mm	£124.00
DDD102	L1000mm	£136.00
DDD122	L1200mm	£154.00

COMPLETE ALPINE RANGE

Cantilever Leg Desks	312	Nova Bench Desking	314
Pedestals	313	Cupboards	316-319
Conference Tables	297	Meeting Tables	297-298,304



Alpine Cantilever Desking - See page 306

Alpine Tables MFC Finishes

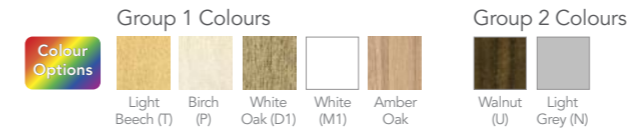

Wood & colour finishes may not be representative of actual colours - please ask for a sample

Page Link - see pages
For Teacher's Desks
26-27



Alpine Cantilever Leg Desking

A superb range of cantilever twin leg desking. This attractive range includes almost 30 different desk shapes and sizes to fit every situation. Quality 25mm tops in a choice of seven finishes.

Frames are also available in a white finish - please ask.

5 Year Warranty



Straight workstations

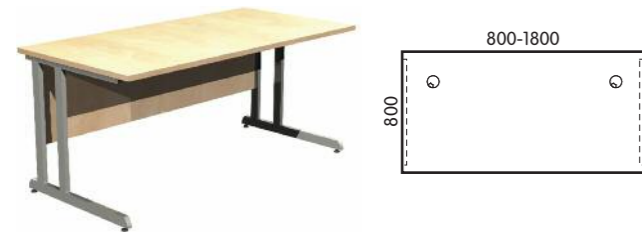

DCA081	L800mm	£169.00
DCA101	L1000mm	£177.00
DCA121	L1200mm	£187.00
DCA141	L1400mm	£204.00
DCA161	L1600mm	£210.00
DCA181	L1800mm	£231.00

Wave workstations 1000

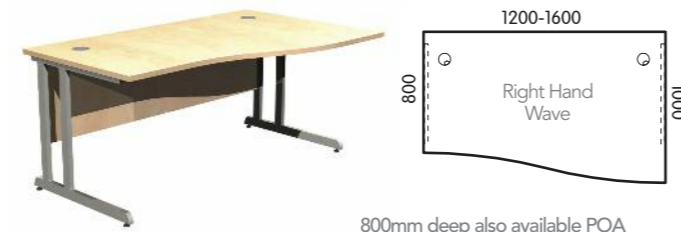

DCL122	Left	L1200mm	£226.00
DCR122	Right	L1200mm	£226.00
DCL142	Left	L1400mm	£241.00
DCR142	Right	L1400mm	£241.00
DCL162	Left	L1600mm	£249.00
DCR162	Right	L1600mm	£249.00

800mm deep also available POA

Crescent workstations



DCL141	Left	L1400 x W1200mm	£273.00
DCR141	Right	L1400 x W1200mm	£273.00
DCL161	Left	L1600 x W1200mm	£282.00
DCR161	Right	L1600 x W1200mm	£282.00
DCL181	Left	L1800 x W1200mm	£303.00
DCR181	Right	L1800 x W1200mm	£303.00
DCB120	Symmetrical Corner	L1200 x W1200 x D600mm	£269.00

Plastic push-fit leg insert

Smart triple compartment vertical cable trunk, push fits into leg.

Recommended for use with modesty fix cable trays - see page 341



OEVCRW	W100 x H600mm	White	£32.00
OEVCRS	W100 x H600mm	Silver	£32.00

Workstations extensions



DCD081	L800mm	£139.00
DCD101	L1000mm	£146.00
DCD121	L1200mm	£165.00

COMPLETE ALPINE RANGE

Panel Leg Desks	310	Nova Bench Desking	314
Pedestals	313	Cupboards	316-319
Conference Tables	297	Meeting Tables	297-298,304

Alpine Pedestals And Desk Height Storage

- Matching pedestals and desk height storage to complement all the Alpine ranges
- A huge choice of pedestals to suit every requirement and situation - don't forget the purpose made pen trays
- Desk height quadrant bookcases add that finishing touch and can double as a meeting point
- All desk height pedestals have height adjustable feet

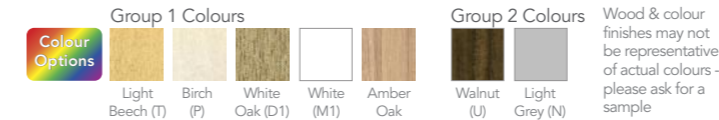

Wood & colour finishes may not be representative of actual colours - please ask for a sample

CONTRACT FIXED PEDESTALS



White finish wooden drawer sides. Metal file frame, central locking
W415 x D500 x H446mm

PSP525	2 Drawer	£151.00
PSP532	3 Drawer	£143.00

CONTRACT DESK HEIGHT PEDESTALS



White finish wooden drawer sides. Metal file frame. Central locking
W415 x H720mm

PSS637	3 Drawer D600	£208.00
PSS642	4 Drawer D600	£210.00
PSS837	3 Drawer D800	£235.00

CONTRACT SMALL MOBILE PEDESTALS



White finish wooden drawer sides. Metal file frame, central locking, mobile castors
W415 x D500 x H510mm

PSR525	2 Drawer	£189.00
PSR532	3 Drawer	£161.00

HEAVY DUTY DESK HEIGHT PEDESTALS



Metal drawer sides and solid drawer bottoms. Metal file frame, central locking, anti-tilt mechanism
W430 x H720mm

PUS635	3 Drawer D600	£294.00
PUS642	4 Drawer D600	£307.00
PUS835	3 Drawer D800	£365.00

STANDARD CONTRACT MOBILE PEDESTALS



White finish wooden drawer sides. Metal file frame, central locking, mobile castors
W415 x D500mm

PSR535	3 Drawer, H638	£195.00
PSR541	4 Drawer, H638	£208.00

PEN TRAYS



Organise paper, envelopes and forms in pedestal drawers.

ZZZ004	For PSR & PSS, D235mm	£14.00
ZZZ006	For PUR & PUS, D250mm	£16.00



N.B. The furniture shown here is just a small section of the Nova range - please ask for our full Range Guide.

5 Year Warranty

Nova Bench Desking System

Beauty in simplicity. Nova combines clean and minimal aesthetics with great functionality. The Nova shared leg system keeps costs and assembly time down to a minimum. Recessed legs on all central locations make for clear, easy working. Three desktop options - scoop back for easy, low-cost cable management, tops with cutouts for large cable ports or straight tops for the ultimate in clean lines - all at the same price.

Desk Top Colour Options

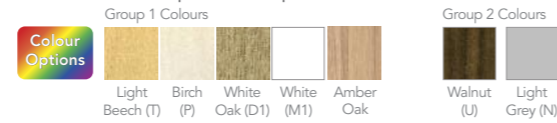

DESK



Desk with scoop back

DNA125	L1200mm	£304.00
DNA145	L1400mm	£316.00
DNA165	L1600mm	£333.00
DNA185	L1800mm	£371.00

2 DESK SQUARE BENCH



2 desk square bench with scoop backs

DNS126	L1200mm	£480.00
DNS146	L1400mm	£508.00
DNS166	L1600mm	£544.00
DNS186	L1800mm	£570.00

2 DESK LONG BENCH



2 desk long bench with scoop backs

DNS248	L2400mm	£508.00
DNS288	L2800mm	£538.00
DNS328	L3200mm	£558.00
DNS368	L3600mm	£598.00

4 DESK SQUARE BENCH



4 desk square bench with scoop backs

DNS247	L2400mm	£875.00
DNS287	L2800mm	£915.00
DNS327	L3200mm	£989.00
DNS367	L3600mm	£1058.00

EXTENSION FOR LONG BENCH



Long desk extension with scoop back

DND128	L1200mm	£293.00
DND148	L1400mm	£302.00
DND168	L1600mm	£323.00
DND188	L1800mm	£350.00

EXTENSION FOR SQUARE BENCH



Extension for square bench with scoop back

DND127	L1200mm	£448.00
DND147	L1400mm	£487.00
DND167	L1600mm	£506.00
DND187	L1800mm	£585.00

All desks also available in 700mm depth Ideal for IT suites

Nova Screens



FRAMELESS PERSPEX® SCREENS

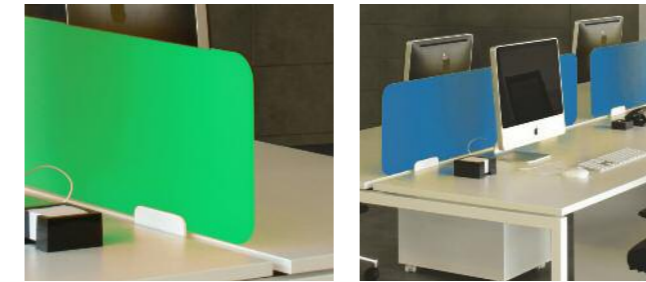

These unframed Perspex® screens or modesty panels come in an unprecedented choice of 75 colours! The only limit is your imagination.

- Transparent or opaque as standard
- Frosted finish also available, call for prices
- Minimum quantities may apply

DNK124	L1200mm	W1050 x H340	£135.00
DNK144	L1400mm	W1250 x H340	£159.00
DNK164	L1600mm	W1450 x H340	£169.00
DNK184	L1800mm	W1650 x H340	£185.00

CABLE PORT INSERTS

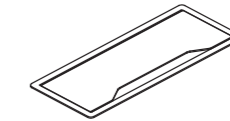

ZNZ010	Metal Lid	£52.00
	L320mm	

MFC MODESTY PANELS



MFC modesty panels

DNH120	L1200mm	£42.00
DNH140	L1400mm	£48.00
DNH160	L1700mm	£53.00
DNH180	L1800mm	£58.00
DNH200	L2000mm	£63.00

ACCESSORIES - CABLE TRAYS



Cable tray for central dump

CTS110	L1100mm	£52.00
CTS140	L1400mm	£69.00

Choice of Silver, White or Anthracite finish



Page Link - see pages

For desk screens

344-345

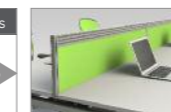

5 Year
Warranty

SHALLOW BOOKCASE



W800 x D400 x H720mm

PXA420 Shallow Open Front Unit
with 1 Shelf

£141.00

FILING CABINETS



H720mm



H1020mm



H1320mm

SLIDING DOOR CUPBOARD



W1200 x D600 x H720mm

PXL620 Lockable Sliding Doors.
Internal Shelf

£313.00

Page Link - see pages

For Steel
Storage

354-359



DEEP CUPBOARD



W800 x D600 x H720mm

PXD620 Cupboard with Locking
Doors & 1 Shelf

£269.00

H834mm

U2T101
Cupboard £420.00U3T101
Cupboard £549.00U5T101
Cupboard £754.00

DEEP TAMBOUR ACCESSORIES

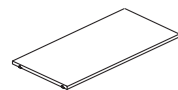
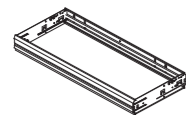
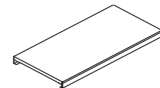
U0Z001
Shelf £23.00U0Z004
Pull out Filing Cradle, A4
or Foolscap Filing £152.00U0Z003
Lateral Filing Shelf, A4
or Foolscap Filing £87.00U0Z007
Lateral Filing Cradle, A4
or Foolscap Filing £52.00G6F116
Anti-Tilt (1 required per extra
pull out cradle) £18.00

Alpine Storage

Alpine X-Range

- A choice of over 60 cupboard and bookcase combinations to match all the Alpine ranges
- All storage units have 19mm carcasses, 25mm tops to complement desking, height adjustable levellers and finished backs, i.e. may be used as room dividers. Includes height adjustable shelves
- All cupboards include locks
- Standard base is plinth with height adjustable feet, alternative Nova steel feet or castor options also available - see page 318
- X-RANGE STORAGE is 425mm deep except where otherwise indicated
- 7 MFC finishes available - see page 313.

600mm WIDE, 5 LEVEL

H1954mm

X5N061
Bookcase
£229.00X5C061
Cupboard
RH Handle
£337.00X5C062
Cupboard
LH Handle
£337.00X5H061
Cupboard
RH Handle
£297.00X5H062
Cupboard
LH Handle
£297.00

600mm WIDE, 6 LEVEL (must be fixed back to wall)

H2320mm

X6N061
Bookcase
£269.00X6C061
Cupboard
RH Handle
£389.00X6C062
Cupboard
LH Handle
£389.00X6H061
Cupboard
RH Handle
£337.00X6H062
Cupboard
LH Handle
£337.00

800mm WIDE, 2 LEVEL

H834mm

X2N081
Bookcase
£143.00X2C081
Cupboard
£233.00X2F081
Sidefile
£676.00A4 Files
Only

800mm WIDE, 4 LEVEL

H1588mm

X4N081
Bookcase
£226.00X4H081
Cupboard
£339.00X4C081
Cupboard
£378.00

800mm WIDE, 3 LEVEL

H1211mm

X3N081
Bookcase
£187.00X3C081
Cupboard
£303.005 Year
Warranty

800mm WIDE, 5 LEVEL H1954mm



X5N081 Bookcase £282.00



X5H081 Cupboard £348.00



X5C081 Cupboard £442.00



X5F081 Bookcase & Sidefiler, A4 Files Only £898.00



X5G081 Cupboard with Glass Doors £609.00

800mm WIDE, 6 LEVEL (must be fixed back to wall) H2320mm



X6N081 Bookcase £307.00



X6C081 Cupboard £498.00



X6H081 Cupboard £387.00



WALL MOUNTED UNIT, 1 SHELF H370mm

X1N081 Wall Unit £64.00



X1C081 Wall Unit with Doors £120.00

1000mm WIDE, 2 LEVEL H834mm



X2N101 Bookcase £172.00



X2C101 Cupboard £285.00



X2F101 Sidefiler £773.00



X2T101 Tambour Cupboard £434.00



X2S101 Cupboard £293.00

BASE OPTIONS (X RANGE ONLY)

All base options are available at no extra cost.



PLINTH BASE

Wooden plinth base with hidden adjustable feet for levelling purposes. NB This option is the standard base on all units unless otherwise specified.



NOVA FEET

Square, tubular metal feet, adjustable for levelling purposes. Available in White (E), Silver (M), and Dark Grey (T1).



PLASTIC FEET

Black plastic feet, adjustable feet for levelling purposes. NB This foot option is smaller than the others and therefore lowers the overall unit height by 57mm.

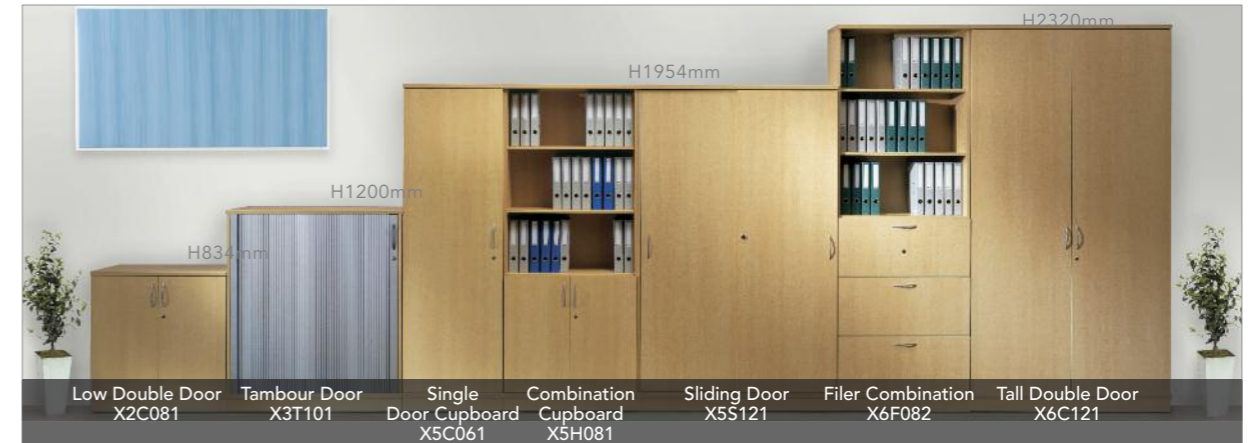

1000mm WIDE, 3 LEVEL H1200mm



X3S101 Sliding Door Cupboard £363.00



X3T101 Tambour Cupboard £565.00

1200mm WIDE, 2/3 LEVEL



X2S121 Cupboard £337.00



X3S121 Sliding Door Cupboard £401.00



X2N121 Bookcase Top Unit £181.00

1000mm WIDE, 5 LEVEL H1954mm



X5N101 Bookcase £326.00



X5C101 Cupboard £505.00

1200mm WIDE, 5 LEVEL H1954mm



X5N121 Bookcase £401.00



X5C121 Cupboard £598.00



X5S121 Sliding Door Cupboard £558.00

1000mm WIDE, 6 LEVEL (must be fixed back to wall) H2320mm



X6N101 Bookcase £378.00



X6C101 Cupboard £595.00

1200mm WIDE, 6 LEVEL (must be fixed back to wall) H2320mm



X6N121 Bookcase £457.00



X6C121 Cupboard £675.00

Orbit Panel Leg Desks

All desks are 725mm high
*Please specify colour when ordering

Phone For Bulk Prices

Best Seller

7 Year Warranty



A. Crescent desks right hand

• W1200 x D800mm
Length mm

YSRH14*	L1400mm	£233.00
YSRH16*	L1600mm	£256.00
YSRH18*	L1800mm	£321.00

B. Crescent desks left hand

• W1200 x D800mm
Length mm

YSLH14*	L1400mm	£233.00
YSLH16*	L1600mm	£256.00
YSLH18*	L1800mm	£321.00

C. Wave desks right hand

• Depth 1000mm
Length mm

YSWRH12*	L1200mm	£216.00
YSWRH14*	L1400mm	£229.00
YSWRH16*	L1600mm	£247.00

D. Wave desks left hand

• Depth 1000mm
Length mm

YSWLH12*	L1200mm	£216.00
YSWLH14*	L1400mm	£229.00
YSWLH16*	L1600mm	£247.00



E. Rectangular workstations

YSR6*	L600 x D800mm	£146.00
YSR8*	L800 x D800mm	£150.00
YSR10*	L1000 x D800mm	£154.00
YSR12*	L1200 x D800mm	£165.00
YSR14*	L1400 x D800mm	£177.00
YSR16*	L1600 x D800mm	£185.00
YSR18*	L1800 x D800mm	£215.00



F. Pedestals

• H725 x W443mm

YSDHP36	D600mm 3 Drawer - Desk High	£342.00
YSDHP46	D600mm 4 Drawer - Desk High	£342.00
YSDHP38	D800mm 3 Drawer - Desk High	£389.00
YSDHP48	D800mm 4 Drawer - Desk High	£389.00
YSMP3	Under Desk Pedestal L430 x D600 x H665mm Drawer	£342.00



G. Mobile pedestals

• H542 x W400 x D600mm		
YSM62D*	2 Drawer	£169.00
YSM63D*	3 Drawer	£169.00



H. Desk high pedestals

• H725 x W400mm

YS63D*	600mm deep 3 Drawer	£219.00
YS64D*	600mm deep 4 Drawer	£219.00
YS83D*	800mm deep 3 Drawer	£289.00
YS84D*	800mm deep 4 Drawer	£289.00

Page Link - see pages

Monitor arms & CPU holders 348-349



Colour Options

Please specify wood finish. Colours shown may not be representative of actual colours - please ask for a sample



Orbit Storage

- The Orbit Storage range is extremely flexible and versatile
- The undoubted quality of this storage range allows for a seven year guarantee on all products
- The slim-line 330mm depth of the adjustable shelved units also provides efficient space utilisation within the office or classroom
- All units are 800mm wide
- All units are constructed with 25mm tops and 18mm sides & back panels
- Please specify wood finish
- Finishes include Maple, Beech, Lt Oak, Birch, White & Walnut
- Add doors in a contrasting wood finish to achieve that extra individuality



7 Year Warranty

Desk high unit

• 725mm high x 350mm deep



Y41558* £209.00
Y41562* £314.00

1 shelf unit

• 893mm high



Y41566* £208.00
Y41570* £311.00

2 shelf unit - 1309mm high



Y41578* £224.00
Y41590* £378.00
Y41582* £351.00

3 shelf unit - 1725mm high



Y41598* £258.00
Y41606* £408.00
Y41614* £428.00
Y41602* £398.00
Y41738* £628.00
Y41622* £516.00

4 shelf unit 2141mm high



Y41634* £314.00
Y41638* £466.00
Y41658* £499.00
Y41686* £472.00
Y41682* £502.00
Y41646* £620.00
Y41794* £594.00
Y41822* £706.00
Y41666* £594.00
Y41810* £725.00
Y41782* £620.00
Y41762* £466.00



Signature Storage

Our new Signature storage range offers you a wide selection of stylish Bookcases, Cupboards, Filing Cabinets, Credenza Units and Tambours in a choice of sizes and colour finishes.

It features a contemporary panel base and matching feet, which come in either Silver or White.



Bookcases

Height	Code	800mm Wide	Code	1000mm Wide
740mm	Y701760	£208.00	Y701770	£243.00
1000mm	Y701761	£245.00	Y701771	£287.00
1200mm	Y701762	£295.00	Y701772	£343.00
1600mm	Y701763	£373.00	Y701773	£434.00
1800mm	Y701764	£422.00	Y701774	£490.00
2000mm	Y701765	£453.00	Y701775	£526.00

All bookcases are supplied with shelves

Credenza units

Height	Code	800mm Wide	Code	1000mm Wide
740mm	Y701780	£407.00	Y701785	£460.00
1000mm	Y701781	£472.00	Y701786	£536.00
1200mm	Y701782	£525.00	Y701787	£597.00

Filing cabinets

Height	Code	Price
Y701790	2 Drawer 740mm	£436.00
Y701791	3 Drawer 1070mm	£514.00
Y701792	4 Drawer 1400mm	£584.00

Side filer

Height	Code	Price
Y701795	2 Drawer 740mm	£709.00



Cupboards

Height	Code	800mm Wide	Code	1000mm Wide
740mm	Y701800	£317.00	Y701810	£370.00
1000mm	Y701801	£382.00	Y701811	£446.00
1200mm	Y701802	£395.00	Y701812	£461.00
1600mm	Y701803	£491.00	Y701813	£574.00
1800mm	Y701804	£539.00	Y701814	£629.00
2000mm	Y701805	£586.00	Y701815	£684.00

Shelves to be purchased separately.

Shelves 800mm wide

Code	Description	Price
Y701840	Single Shelf for Cupboards & Credenza	£44.00
Y701841	Single Shelf for Tambours	£44.00
Y701842	Single Filing Frame for Cupboards	£154.00
Y701843	Single Filing Frame for Tambours	£154.00
Y701844	Lateral Filing Frame for Cupboards	£106.00
Y701845	Lateral Filing Frame for Tambours	£106.00

Shelves 1000mm wide

Code	Description	Price
Y701850	Single Shelf for Cupboards & Credenza	£44.00
Y701851	Single Shelf for Tambours	£44.00
Y701852	Single Filing Frame for Cupboards	£154.00
Y701853	Single Filing Frame for Tambours	£154.00
Y701854	Lateral Filing Frame for Cupboards	£106.00
Y701855	Lateral Filing Frame for Tambours	£106.00

Shelving, Sliding Filing Frames and Lateral Filing Frames are available in Silver or White to complement the stylish panel base and feet.

Tambour Cupboards

Height	Code	800mm Wide	Code	1000mm Wide
740mm	Y701820	£429.00	Y701830	£513.00
1000mm	Y701821	£514.00	Y701831	£583.00
1200mm	Y701822	£591.00	Y701832	£652.00
1600mm	Y701823	£691.00	Y701833	£741.00
1800mm	Y701824	£749.00	Y701834	£804.00
2000mm	Y701825	£807.00	Y701835	£866.00

Shelves to be purchased separately.

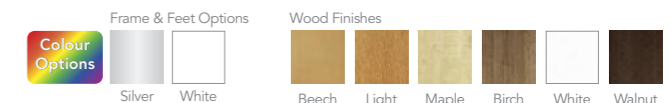

Colours shown may not be representative of actual colours - please ask for a sample

Orbit Height Adjustable & Sit-Stand Desks

7 Year
Warranty

A

A. Sit-stand rectangular desk

- Provide a flexible solution for the modern office
- An electric motor enables the operator to quickly and easily adjust their posture from a seated position to a standing height for maximum comfort throughout the day
- Full height adjustment from 650mm to 1250mm
- 2 Year Guarantee on the mechanism
- Wave desk style available - please enquire
- Modesty panel available as extra - please enquire

Y700558	1200 x 800mm	£848.00
Y700560	1400 x 800mm	£856.00
Y700562	1600 x 800mm	£864.00
Y700564	1800 x 800mm	£872.00

B. Height adjustable rectangular desk

- Height adjustable workstations are becoming more popular due to increasing public awareness of the potential health implications associated with being seated for long periods of time
- Full height adjustment from 695mm up to 995mm using side crank handle
- 2 Year Guarantee on mechanism

Y700566	1200 x 800mm	£583.00
Y700568	1400 x 800mm	£597.00
Y700570	1600 x 800mm	£612.00
Y700572	1800 x 800mm	£628.00

Metal Finishes

Colour
Options

Wood Finishes

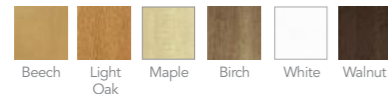

Vermont Height Adjustable Desking

Rectangle height adjustable desk (electric)

With a range of options and height settings, our height adjustable workstations give you the opportunity to create an office space that showcases your style whilst meeting your DDA requirements.

- 25mm Tops
- Adjustment range 710mm – 1210mm
- White or Silver Frames
- Black frames available on request
- 5 year Guarantee

Want to re-use an existing top? All items can be purchased 'frame only' – Please call for prices.

White Frame

Y700350	1200 x 800mm	£589.00
Y700352	1400 x 800mm	£609.00
Y700354	1600 x 800mm	£629.00
Y700356	1800 x 800mm	£649.00

Silver Frame

Y700358	1200 x 800mm	£589.00
Y700360	1400 x 800mm	£609.00
Y700362	1600 x 800mm	£629.00
Y700364	1800 x 800mm	£649.00

5 Year
Warranty

Corner height adjustable desk

The Vermont Corner height adjustable desk has all of the advantages of the popular Vermont rectangular desk, with a smooth-operating triple motor system and overload protection as standard. Perfect for executive use, giving extra workspace for printers and storage.

- Black frames available on request

White Frame

Y700366	1600 x 1600mm	£1056.00
Y700368	1800 x 1600mm	£1095.00

Silver Frame

Y700370	1600 x 1600mm	£1056.00
Y700372	1800 x 1600mm	£1095.00

Please state Left or Right Hand at point of ordering.

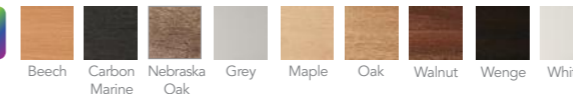

Finishes

Colour
Options

10 Year Warranty

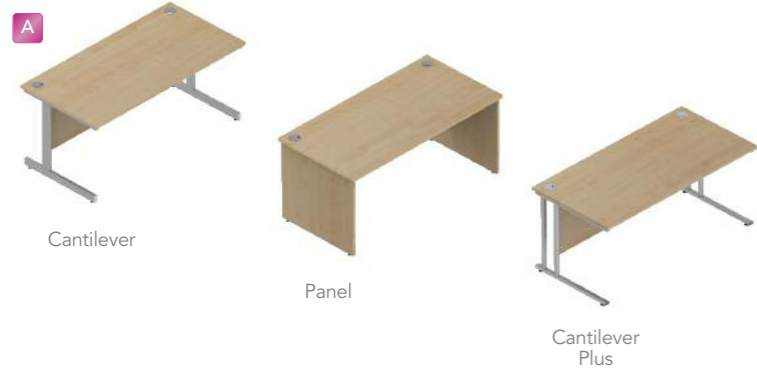

Cantilever

Panel

Cantilever Plus



Cantilever

Panel

Cantilever Plus



Cantilever

Panel

Cantilever Plus

Page Link - see page 336
For Desk Ends



Colour Options See page 327, opposite for wood finish options

Colorado Desking

Colorado tables are available with integrated modesty panels and a choice of 3 leg options - Cantilever, Panel or Cantilever Plus. When ordering please add the suffix code C, P or X to the product code to denote the leg style you require as follows:

- Cantilever: Code 'C' - Single leg in graphite (G) or silver (S)
- Panel : Code 'P' - Panel leg in chosen board finish
- Cantilever Plus: Code 'X' - Twin upright legs in white (W) or silver (S)

For example, order code YD08-8XW for a rectangular desk with Cantilever Plus legs in White. Please note that if no leg colour is specified silver will be supplied as standard.

Cable ports with optional trays or risers enable cable management.

A. Rectangular desks 800mm deep

- YUFP-8 fixed pedestals can be fitted to either side of all 800mm deep desks except D08-8 & D10-8

Code	Dimensions W x D x H	Price for Each Leg Style		
		C	P	X
YD08-8	800 x 800 x 727	£218.00	£218.00	£236.00
YD10-8	1000 x 800 x 727	£228.00	£228.00	£249.00
YD12-8	1200 x 800 x 727	£242.00	£242.00	£264.00
YD14-8	1400 x 800 x 727	£251.00	£251.00	£274.00
YD16-8	1600 x 800 x 727	£262.00	£262.00	£287.00
YD18-8	1800 x 800 x 727	£285.00	£285.00	£310.00

B. Rectangular desks 600mm deep

- YUFP-6 fixed pedestals can be fitted to either side of all 600mm deep desks except D08-6 & D10-6

Code	Dimensions W x D x H	Price for Each Leg Style		
		C	P	X
YD08-6	800 x 600 x 727	£198.00	£198.00	£220.00
YD10-6	1000 x 600 x 727	£212.00	£212.00	£233.00
YD12-6	1200 x 600 x 727	£224.00	£224.00	£246.00
YD14-6	1400 x 600 x 727	£240.00	£240.00	£259.00
YD16-6	1600 x 600 x 727	£247.00	£247.00	£272.00
YD18-6	1800 x 600 x 727	£266.00	£266.00	£292.00

C. Bow fronted desks

- Bow fronted desks accept YUFP-8 fixed pedestals

Code	Dimensions W x D x H	Price for Each Leg Style		
		C	P	X
YDB16-8	1600 x 900/800 x 727	£338.00	£338.00	£358.00
YDB18-8	1800 x 900/800 x 727	£355.00	£355.00	£376.00

10 Year Warranty



A. Wave desks

- Available in LH or RH (RH illustrated)
- Accept fixed pedestals YUFP-6 on side A

Code	Dimensions W x D x H	Price for Each Leg Style		
		C	P	X
YWD12-6	1200 x 700/600 x 727	£255.00	£255.00	£275.00
YWD14-6	1400 x 700/600 x 727	£265.00	£265.00	£286.00
YWD16-6	1600 x 700/600 x 727	£278.00	£278.00	£299.00
YWD18-6	1800 x 700/600 x 727	£296.00	£296.00	£320.00



B. Double wave desks

Code	Dimensions W x D x H	Price for Each Leg Style		
		C	P	X
YDWD16-6	1600 x 700/600 x 727	£299.00	£299.00	£322.00
YDWD18-6	1800 x 700/600 x 727	£320.00	£320.00	£342.00

Wood Finish Options

Page Link - see pages 348-349
Monitor arms & CPU holders

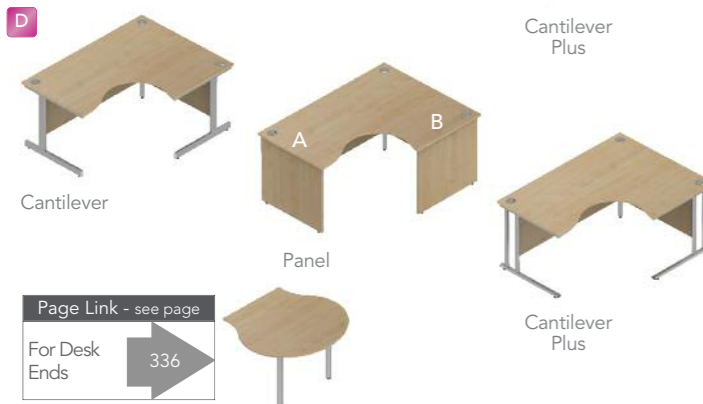
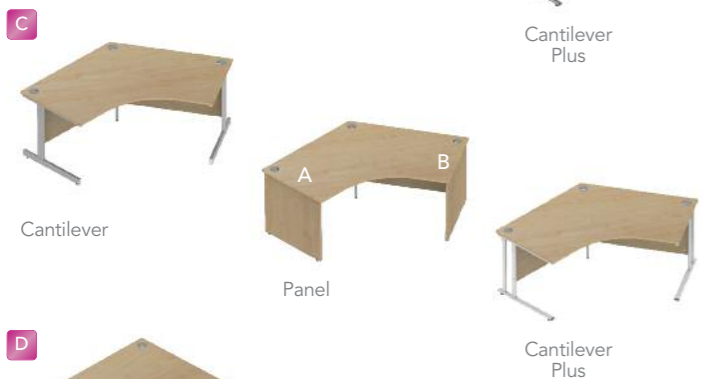
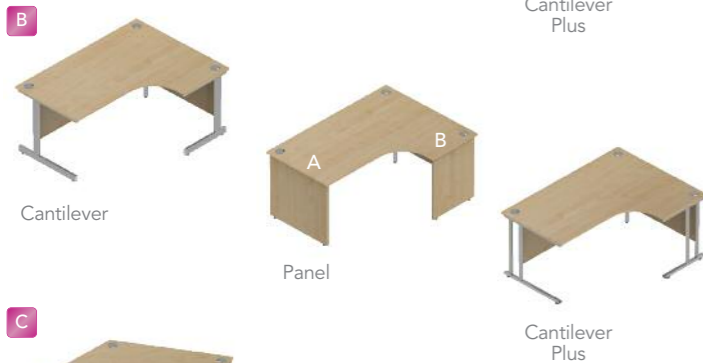
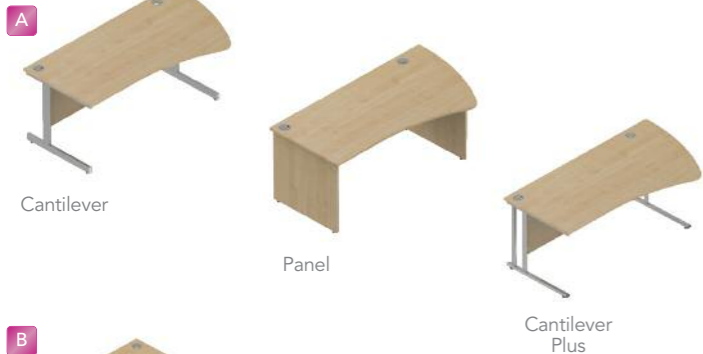

10 Year
Warranty

Colorado Desking

Colorado tables are available with integrated modesty panels and a choice of 3 leg options - Cantilever, Panel or Cantilever Plus. When ordering please add the suffix code C, P or X to the product code to denote the leg style you require as follows:

Cantilever: Code 'C' - Single leg in graphite (G) or silver (S)

Panel: Code 'P' - Panel leg in chosen board finish

Cantilever Plus: Code 'X' - Twin upright legs in white (W) or silver (S)

For example, order code YD08-8XW for a rectangular desk with Cantilever Plus legs in White. Please note that if no leg colour is specified silver will be supplied as standard. Cable ports with optional trays or risers enable cable management.

A. Arc desks

- Available in LH or RH (RH illustrated)
- Accept fixed pedestals YUFP-8 on side A

Code	Dimensions W x D x H	Price for Each Leg Style		
		C	P	X
YAD16	1600 x 1000/800 x 727	£320.00	£320.00	£341.00
YAD18	1800 x 1000/800 x 727	£339.00	£339.00	£362.00

B. Combi workstations

- Available in LH or RH (RH illustrated)
- CS16A, CS18A & CS20A accept fixed pedestals YUFP-8 on side A

Code	Dimensions W x D x A x B x H	Price for Each Leg Style		
		C	P	X
YCS14A	1400 x 1200 x 800 x 600 x 727	£336.00	£336.00	£367.00
YCS16A	1600 x 1200 x 800 x 600 x 727	£350.00	£350.00	£382.00
YCS18A	1800 x 1200 x 800 x 600 x 727	£373.00	£373.00	£402.00
YCS20A	2000 x 1200 x 800 x 600 x 727	£409.00	£409.00	£455.00

C. 120 degree cluster workstations

- Unhanded
- Do not accept fixed pedestals

Code	Dimensions W x D x A x B x H	Price for Each Leg Style		
		C	P	X
YCS3W10-6	1000 x 1000 x 600 x 600 x 727	£400.00	£400.00	£436.00
YCS3W12-6	1200 x 1200 x 600 x 600 x 727	£431.00	£431.00	£475.00
YCS3W12-8	1200 x 1200 x 800 x 800 x 727	£431.00	£431.00	£475.00

D. Cockpit workstations

- Unhanded
- Do not accept fixed pedestals

Code	Dimensions W x D x A x B x H	Price for Each Leg Style		
		C	P	X
YCWS16A	1600 x 1200 x 800 x 600 x 727	£350.00	£350.00	£385.00
YCWS18A	1800 x 1200 x 800 x 600 x 727	£379.00	£379.00	£412.00
YCWS20A	2000 x 1200 x 800 x 600 x 727	£402.00	£402.00	£451.00



A. D-end combi workstations

- Available in LH or RH (RH illustrated)
- Does not accept fixed pedestals

Code	Dimensions W x D x A x B x H	Price for Each Leg Style		
		C	P	X
YDCS19	1900 x 1200 x 800 x 600 x 727	£419.00	£419.00	£452.00

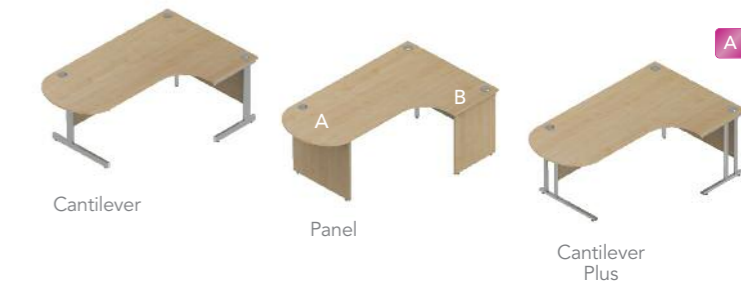

B. D-end cockpit workstations

- Available in LH or RH (RH illustrated)
- Does not accept fixed pedestals

Code	Dimensions W x D x A x B x H	Price for Each Leg Style		
		C	P	X
YDCWS19	1900 x 1200 x 800 x 600 x 727	£419.00	£419.00	£452.00

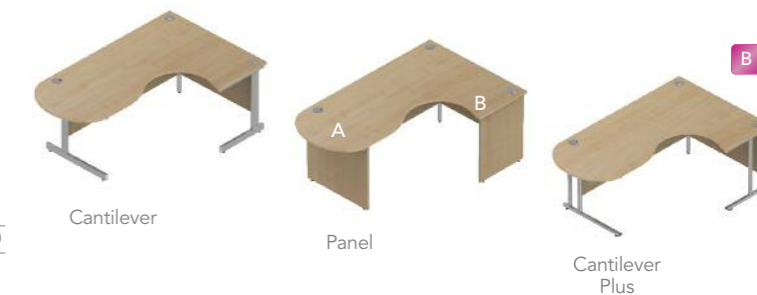

Page Link - see page

For Desk
Ends

336

10 Year
Warranty

A

Full Depth
Modesty Panels

B



C



D

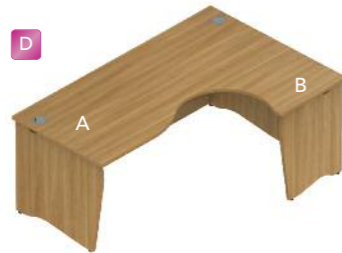

E

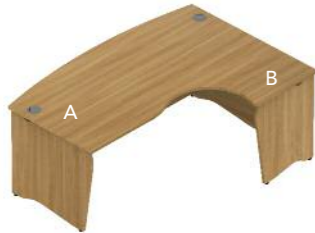

Page Link - see pages

For matching
Colorado
Conference Tables

300-302

Colour
Options

Wood Finish Options

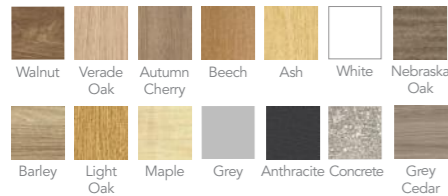

Colorado Executive Desking

Colorado executive desking has a stylish panel end leg design with full depth modesty panels. Optional conference extensions are available as are complementary meeting and boardroom tables.

A. Rectangular desks

- Fixed pedestals YUFP2-8 & YUFP3-8 can be fitted to either side of rectangular desks except YPD08-8 and YPD10-8

Code	Dimensions W x D x H	
YPD08-8	800 x 800 x 727	£236.00
YPD10-8	1000 x 800 x 727	£255.00
YPD12-8	1200 x 800 x 727	£263.00
YPD14-8	1400 x 800 x 727	£278.00
YPD16-8	1600 x 800 x 727	£293.00
YPD18-8	1800 x 800 x 727	£308.00
YPD20-8	2000 x 800 x 727	£327.00

B. Bow fronted desks

- Fixed pedestals UFP2-8 & UFP3-8 can be fitted to either side of all bow fronted desks

Code	Dimensions W x D x H	
YPD16-8B	1600 x 900/800 x 727	£354.00
YPD18-8B	1800 x 900/800 x 727	£372.00
YPD20-8B	2000 x 900/800 x 727	£389.00

C. Return units

- Available in LH or RH (RH illustrated)
- Return units affixes to either side of rectangular desks except YPD08-8 and YPD10-8 & to all bow fronted desks

Code	Dimensions W x D x H	
YPR08-6	800 x 600 x 727	£182.00
YPR10-6	1000 x 600 x 727	£199.00
YPR12-6	1200 x 600 x 727	£211.00

D. Cockpit workstations

- Available in LH or RH (RH illustrated)
- Does not accept fixed pedestals

Code	W x D x A x B x H	
YPCWS16A	1600 x 1200 x 800 x 600 x 727	£386.00
YPCWS18A	1800 x 1200 x 800 x 600 x 727	£411.00

E. Bow fronted cockpit workstations

- Available in LH or RH (RH illustrated)
- Does not accept fixed pedestals

Code	W x D x A x B x H	
YPBFCWS16A	1600 x 1300 x 800 x 600 x 727	£409.00
YPBFCWS18A	1800 x 1300 x 800 x 600 x 727	£435.00



A. D-ended cockpit workstation

- Available in LH or RH (RH illustrated)
- Does not accept fixed pedestals

Code	W x D x A x B x H	
YPDCWS19	1900 x 1200 x 800 x 600 x 727	£452.00

B. Scoop cockpit workstation

- Available in LH or RH (RH illustrated)
- Does not accept fixed pedestals

Code	W x D x A x B x H	
YPSCWS19	1900 x 1300 x 800 x 600 x 727	£472.00

C. Contact cockpit workstation

- Available in LH or RH (RH illustrated)
- Does not accept fixed pedestals

Code	W x D x A x B x H	
YPCWS19	1900 x 1300 x 800 x 600 x 727	£472.00

D. Bulb cockpit workstation

- Available in LH or RH (RH illustrated)
- Does not accept fixed pedestals

Code	W x D x A x B x H	
YPBCWS19	1900 x 1300 x 800 x 600 x 727	£472.00

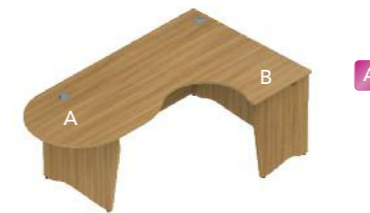
10 Year
Warranty

A

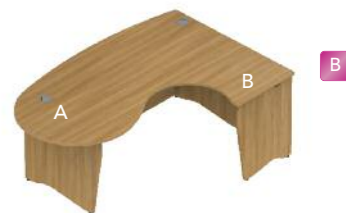

B



C

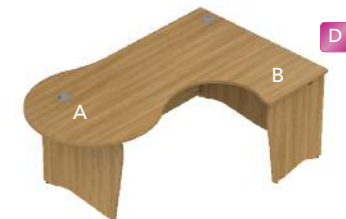

D



Fixed pedestals

- 800mm deep

Code	Dimensions W x D x H	
YUFP2-8	2 Drawer 416 x 558 x 482	£130.00
YUFP3-8	3 Drawer 416 x 558 x 482	£130.00



Fixed pedestals

- 600mm deep

Code	Dimensions W x D x H	
YUFP2-6	2 Drawer 416 x 473 x 482	£130.00
YUFP3-6	3 Drawer 416 x 473 x 482	£130.00

Colorado Storage



Mobile low pedestals

- Mobile, low under desk

Code	Dimensions W x D x H	
YUMP2	2 Drawer 420 x 568 x 542	£189.00
YUMP3	3 Drawer 420 x 568 x 542	£189.00



Mobile midi pedestals

- Mobile, midi under desk

Code	Dimensions W x D x H	
YUMMP3	3 Drawer 420 x 568 x 620	£238.00
YUMMP4	4 Drawer 420 x 568 x 620	£238.00



Mobile tall pedestals

- Mobile, tall under desk

Code	Dimensions W x D x H	
YUTMP3	3 Drawer 420 x 568 x 697	£238.00
YUTMP4	4 Drawer 420 x 568 x 697	£238.00



Slimline pedestals

- Mobile, tall, slimline under desk

Code	Dimensions W x D x H	
YUTMP3R	3 Drawer 320 x 568 x 697	£232.00
YUTMP4R	4 Drawer 320 x 568 x 697	£232.00



Desk high pedestals

- Static, desk high - 600mm deep

Code	Dimensions W x D x H	
YUDHP63	3 Drawer 420 x 600 x 727	£238.00
YUDHP64	4 Drawer 420 x 600 x 727	£238.00



Slimline pedestals

- Static, slimline desk high

Code	Dimensions W x D x H	
YUDHP63R	3 Drawer 320 x 600 x 727	£232.00
YUDHP64R	4 Drawer 320 x 600 x 727	£232.00



Desk high pedestals

- Static, desk high - 800mm deep

Code	Dimensions W x D x H	
YUDHP83	3 Drawer 420 x 800 x 727	£284.00
YUDHP84	4 Drawer 420 x 800 x 727	£284.00



Under desk pedestals

- Mobile, tall under desk

Code	Dimensions W x D x H	
YUTMP3SD	3 Drawer 420 x 528 x 697	£279.00
YUTMP4SD	4 Drawer 420 x 528 x 697	£288.00



Desk high pedestals

- Static, desk high - 600mm deep

Code	Dimensions W x D x H	
YUDHP63SD	3 Drawer 420 x 600 x 727	£279.00
YUDHP64SD	4 Drawer 420 x 600 x 727	£288.00



Desk high pedestals

- Static, desk high - 800mm deep

Code	Dimensions W x D x H	
YUDHP83SD	3 Drawer 420 x 800 x 727	£329.00
YUDHP84SD	4 Drawer 420 x 800 x 727	£336.00

These pedestals are Heavy Duty

These pedestals are Heavy Duty

These pedestals are Heavy Duty

10 Year Warranty

Colorado Storage



Bookcases

- Bookcases fitted with 1 adjustable shelf as standard

Code	Dimensions W x D x H	
YUBCU08-8	Open Fronted 800 x 360 x 887	£202.00
YUBCU09-8	Open Fronted 960 x 360 x 887	£214.00
YUBCGD09-8	Glass Doors 960 x 360 x 887	£325.00



Bookcase shelves

Code	Dimensions W x D x H	
YUBC-WS08	800 x 360	£26.00
YUBC-WS09	960 x 360	£27.00



Filing cabinets

- UFC3 illustrated
- Filing cabinets are fitted with anti-tilt mechanism

Code	Dimensions W x D x H	
YUFC2	2 Drawer 470 x 600 x 727	£298.00
YUFC3	3 Drawer 470 x 600 x 1041	£385.00
YUFC4	4 Drawer 470 x 600 x 1362	£479.00



Side filing units

Code	Dimensions W x D x H	
YUSF08	2 Drawer 800 x 600 x 727	£372.00



Plan chest

- Supplied with 1 deep and 5 shallow steel drawers

Code	Dimensions W x D x H	
YUPC10	6 Drawer 1000 x 800 x 727	£1142.00



Desk ends

- Radial tambour
- Suitable for A4 files only (maximum height 324mm)

Code	Dimensions W x D x H	
YURCUT08	1 Fixed Shelf 800 x 800 x 727	£499.00



Desk ends

- Radial open fronted
- Suitable for A4 files only (maximum height 324mm)

Code	Dimensions W x D x H	
YURCU06	1 Fixed Shelf 600 x 600 x 727	£265.00
YURCU08	1 Fixed Shelf 800 x 800 x 727	£275.00



Desk ends

- Elliptical open fronted
- Available in LH or RH (RH illustrated)
- Suitable for A4 files only (max height 324mm)

Code	Dimensions W x D x H	
YUECU06	1 Fixed Shelf 600 x 600 x 727	£265.00
YUECU08	1 Fixed Shelf 800 x 600 x 727	£275.00

Wood Finish Options

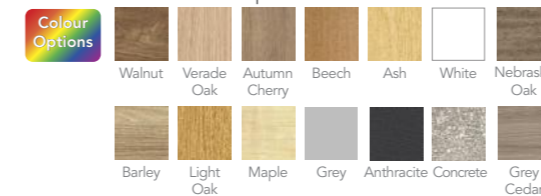

Colorado storage guide

Pedestals	332
Filing & Accessories	333
Cupboards	334-335
Combi Storage	335
Desk Extensions	336

Page Link - see pages

Monitor arms & CPU holders 348-349



10 Year
WarrantySupplied
emptySupplied
empty

Single door cupboards

- Available in LH or RH (RH illustrated)

Code	Dimensions W x D x H	
YUSD04-6-7	420 x 600 x 727	£258.00
YUSD04-5-7	420 x 528 x 727	£249.00
YUSD04-5-12	420 x 528 x 1207	£286.00
YUSD04-5-16	420 x 528 x 1607	£319.00
YUSD04-5-20	420 x 528 x 2007	£354.00

Supplied
empty

Storage cupboards

- Vertical opening tambour

Code	Dimensions W x D x H	
YUSVT08-6-7	800 x 600 x 727	£440.00
YUSVT08-E8-7*	800 x 800 x 727	£454.00
YUSVT09-5-7	960 x 528 x 727	£440.00
YUSVT09-E6-7*	960 x 600 x 1207	£449.00
YUSVT09-5-12	960 x 528 x 1207	£536.00
YUSVT09-5-16	960 x 528 x 1607	£585.00
YUSVT09-5-20	960 x 528 x 2007	£732.00

* Extended top

Price does
not include
pedestal

Pedestal file organiser

Code	Dimensions W x D x H	
YUDHP6FO	420 x 600 x 387	£159.00
YUDHP8FO	420 x 800 x 387	£176.00

Double door cupboards

Code	Dimensions W x D x H	
YUSD08-6-7	800 x 600 x 727	£290.00
YUSD08-E8-7*	800 x 800 x 727	£312.00
YUSD09-5-7	960 x 528 x 727	£290.00
YUSD09-E6-7*	960 x 600 x 727	£299.00
YUSD09-5-12	960 x 528 x 1207	£376.00
YUSD09-5-16	960 x 528 x 1607	£412.00
YUSD09-5-20	960 x 528 x 2007	£538.00

* Extended top



Storage cupboards

- Side opening tambour

Code	Dimensions W x D x H	
YUSOT11-5-7	1120 x 528 x 727	£462.00
YUSOT11-E6-7*	1120 x 600 x 727	£462.00
YUSOT11-5-12	1120 x 528 x 1207	£555.00
YUSOT11-5-16	1120 x 528 x 1607	£604.00
YUSOT11-5-20	1120 x 528 x 2007	£689.00

* Extended top

Pen trays

YPENT-A	For HD 420mm Wide Peds	£17.00
YPENT-B	For Standard 420mm Wide Peds	£17.00

Colorado Storage



Open storage cupboards

- Supplied empty

Code	Dimensions W x D x H	
YUSU04-6-7	420 x 600 x 727	£188.00
YUSU04-5-7	420 x 528 x 727	£182.00
YUSU04-5-12	420 x 528 x 1207	£220.00
YUSU04-5-16	420 x 528 x 1607	£250.00
YUSU04-5-20	420 x 528 x 2007	£296.00
YUSU08-6-7	800 x 600 x 727	£212.00
YUSU08-E8-7*	800 x 800 x 727	£225.00
YUSU09-5-7	960 x 528 x 727	£212.00
YUSU09-E6-7*	960 x 600 x 727	£222.00
YUSU09-5-12	960 x 528 x 1207	£248.00
YUSU09-5-16	960 x 528 x 1607	£288.00
YUSU09-6-20	960 x 528 x 2007	£345.00

* Extended top

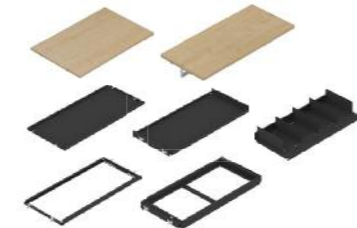

Storage cupboard internals

Code	Dimensions W x D x H	
YUS-WS04-6	MFC 420 x 600	£24.00
YUS-WS04-5	MFC 420 x 528	£23.00
YUS-WS08	MFC 800 x 600	£31.00
YUS-WS09	MFC 960 x 528	£31.00
YUS-WS09-CR	With Coat Rail	£55.00
YUS-FSS	Steel	£46.00
YUS-SSH	Slotted Shelf with 5 Dividers	£93.00
YUS-POF	Pull-Out Filing Frame	£98.00
YUS-LF	Lateral Filing Frame	£48.00
YUS-RS	Pull-Out Reference Shelf	£98.00

10 Year
Warranty

Colorado Storage



Cupboards - open fronted

	Shelves (Adjustable)	Dimensions W x D x H	
YUDCU06	1	600 x 400 x 727	£182.00
YUDCU08	1	800 x 400 x 727	£194.00



Cupboards - open fronted

- UDC3WU12 Low shelf height (from base) 335 x 400mm
- Upper shelf height (from lower shelf) is 314 x 400mm

	Shelves (Adjustable)	Dimensions W x D x H	
YUDC3WU12	3	1200 x 400 x 727	£369.00
YUDC3WU16	3	1600 x 400 x 727	£402.00



Cupboard - double door

	Shelves (Adjustable)	Dimensions W x D x H	
YUDCDD06	1	600 x 400 x 727	£258.00
YUDCDD08	1	800 x 400 x 727	£272.00

Credenza units

	Dimensions W x D x H	
YUCU-S	3 Shelving Compartments 1600 x 600 x 727	£492.00
YUCU-F	With Fridge Compartment 1600 x 600 x 727	£492.00

Combi-stor units

- Single door available in LH or RH (RH shown)
- Shelves included in price

	Shelves (Adjustable)	Dimensions W x D x H	
YUCSD04-7-D7	1	400 x 400 x 727	£239.00
YUCSD04-8-D8	1	400 x 400 x 887	£262.00
YUCSD04-12-D12	2	400 x 400 x 1287	£316.00
YUCSD04-16-D16	4	400 x 400 x 1687	£384.00
YUCSD04-20-D20	5	400 x 400 x 2087	£459.00

Combi-stor units

- Full double door
- Shelves included in price

	Shelves (Adjustable)	Dimensions W x D x H	
YUCSD08-7	1	800 x 400 x 727	£274.00
YUCSD08-8	2	800 x 400 x 887	£300.00
YUCSD08-12	3	800 x 400 x 1287	£360.00
YUCSD08-16	4	800 x 400 x 1687	£436.00
YUCSD08-20	4	800 x 400 x 2087	£525.00

Shelves
included in
price

Combi-stor units

- Low double door

	Shelves (Adjustable)	Dimensions W x D x H	
YUCSD08-12-D7	2	800 x 400 x 1287	£329.00
YUCSD08-16-D7	3	800 x 400 x 1687	£395.00
YUCSD08-20-D7	4	800 x 400 x 2087	£462.00

Shelves
included in
price

Combi-stor units

- Mid double door

	Shelves (Adjustable)	Dimensions W x D x H	
YUCSD08-16-D8	3	800 x 400 x 1687	£407.00
YUCSD08-20-D8	4	800 x 400 x 2087	£474.00
YUCSD08-16-D12	3	800 x 400 x 1687	£424.00
YUCSD08-20-D12	4	800 x 400 x 2087	£491.00



Combi-stor units

- Open fronted

	Shelves (Adjustable)	Dimensions W x D x H	
YUCSU04-7	1	400 x 400 x 727	£169.00
YUCSU04-8	1	400 x 400 x 887	£179.00
YUCSU04-12	2	400 x 400 x 1287	£222.00
YUCSU04-16	3	400 x 400 x 1687	£274.00
YUCSU04-20	4	400 x 400 x 2087	£332.00
YUCSU08-7	1	800 x 400 x 727	£195.00
YUCSU08-8	1	800 x 400 x 887	£208.00
YUCSU08-12	2	800 x 400 x 1287	£253.00
YUCSU08-16	3	800 x 400 x 1687	£312.00
YUCSU08-20	4	800 x 400 x 2087	£381.00

10 Year
Warranty

A



B



C



D



E



F

Colour
Options

Wood Finish Options

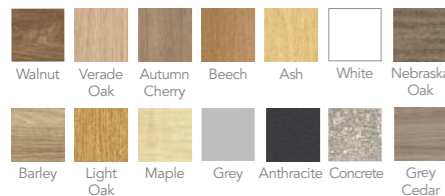

Colorado Desk Extensions

A. Colorado extension - bulb

Code	Dimensions Diameter x Height	Price for Each Leg Style		
		C	P	X
YCE-B12	1200ø x 727mm	£328.00	£328.00	£328.00

B. Colorado extension - teardrop

Code	Dimensions Diameter x Height	Price for Each Leg Style		
		C	P	X
YCE-T12	1200ø x 727mm	£357.00	£357.00	£357.00

C. Colorado extension - d-ended

- YCE-D161 & YCE-D121 conference extensions are used with Split & Intersect screens

Code	Dimensions Diameter x Height	Price for Each Leg Style		
		C	P	X
YCE-D160	1600 x 450 x 727	£255.00	£255.00	£255.00
YCE-D161	1610 x 450 x 727	£255.00	£255.00	£255.00
YCE-D120	1200 x 450 x 727	£235.00	£235.00	£235.00
YCE-D121	1210 x 450 x 727	£235.00	£235.00	£235.00

D. Colorado executive extension - bulb

- Bulb conference extension connects to the end of any 800mm deep desk or workstation
- A cutback leg can be used to improve leg room and is purchased separately

Code	Diameter x Height	
YPCE-B12	1200ø x 727mm	£330.00

E. Colorado executive extension - teardrop

- Teardrop conference extension connects to the end of any 800mm deep desk or workstation
- A cutback leg can be used to improve leg room and is purchased separately

Code	Diameter x Height	
YPCE-T12	1200ø x 727mm	£355.00

F. Colorado executive pedestal extension

- Available in LH or RH (RH illustrated)
- Pedestal extensions affix to the 600mm return end of the workstations
- Pedestals are not included in the above specification/price
- For pedestals see Universal. (Not designed for use with slimline pedestals)

Code	Diameter x Height	
YPPE08-6	800 x 600 x 727mm	£192.00
YPPE10-6	1000 x 600 x 727 mm	£199.00
YPPE12-6	1200 x 600 x 727 mm	£204.00

Alpine Conference & Meeting Ends

Meeting, greeting, training. A flexible modular system of all shapes and sizes.

Whether it's a meeting point on the end of a desk or a complete flexible training room requirement we've got what you need. Individual tables for exams or training – no problem; a conference for 20 – just push the tables together, add some half round ends for an instant result.

- Choice of 6 finishes
- All tables are 720mm high

DESK EXTENSIONS & MEETING POINTS

MEETING ENDS

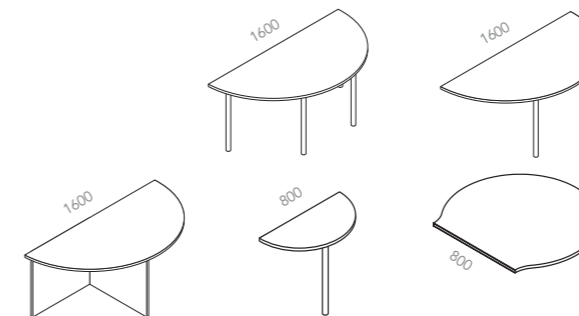

DZC180	Half Round Table, 4 Leg, R800 180°	£173.00
DDC180	Half Round Table, Panel Base, R800 180°	£195.00
DZC183	Half Round, Linking, W800	£61.00
DZC360	Bubble End, Linking, W1100	£149.00

QUADRANT LINKS

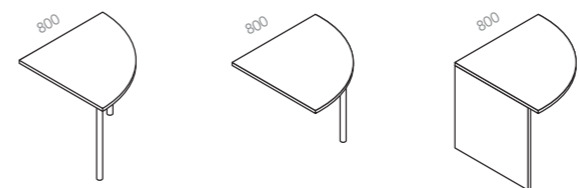

DZC901	Quarter Round Table, 1 Leg, R800 90°	£109.00
DDC900	Quarter Round Table, Panel Leg, R800 90°	£149.00



MEETING POINTS

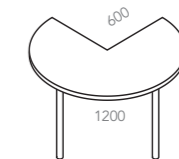

DZC271	270° for 600 End, W1200	£159.00
--------	-------------------------	---------

Page Link - see pages

Alpine
desks &
cupboards

310-319

Alpine Desking Storage & Tables MFC Finishes

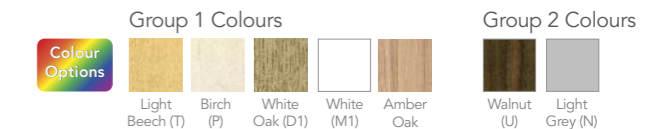

Wood & colour finishes may not be representative of actual colours - please ask for a sample



Pigeon Hole Units

High Quality, long lasting construction. These units are solid and heavy but we have designed them as modular parts which simply connect together with the supplied fixings. Ideal for sorting post & distributing mail.

- Manufactured from quality 18mm laminate
- All shelves are fully adjustable with 32mm hole spacings
- The clear acrylic shelves come complete with a label holder for the front
- Our pigeonhole range is available in a choice of 5 Wood finishes. BEECH, MAPLE, LIGHT OAK, GREY and WHITE
- Other pigeon hole combinations available, please call for details

A. 36 pigeon hole storage with cupboard

- Size: W826 x H1930 x D375mm

Y701101 36 Hole Unit £699.00

B. 48 pigeon hole storage with cupboard

- Size: W1094 x H1930 x D375mm

Y701102 48 Hole Unit £859.00

C. 72 pigeon hole storage with cupboard

- Size: W1094 x H1930 x D375mm

Y701103 72 Hole Unit £859.00

D. Colorado pigeon hole units

		Dimensions W x D x H (mm)	
YUPHU08-7	12 Holes	800 x 360 x 727	£336.00
YUPHU09-7	12 Holes	960 x 360 x 727	£339.00
YUPHU09-12	21 Holes	960 x 360 x 1207	£409.00
YUPHU09-15	27 Holes	960 x 360 x 1607	£459.00
YUPHU09-18	33 Holes	960 x 360 x 1837	£524.00
YUPHU-WS08	Extra Shelf	800 x 360	£18.00
YUPHU-WS09	Extra Shelf	960 x 360	£18.00

Wood Finish Options

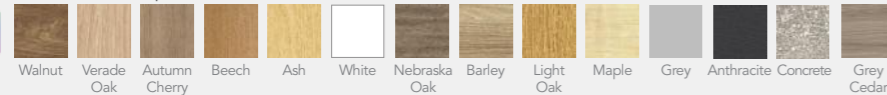

A large range of Executive Furniture is available for Executive Suites & Senior Leadership offices. Call today for more details or to arrange a free site survey and quotation.



New Product



Mattress not supplied, POA

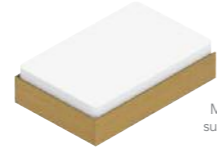

Mattress not supplied, POA



Mattress not supplied, POA

A. Single bedstead

- Panel frame
- Size W1970 x H525mm

		Depth mm	
Y765100*	Small	830	£275.00
Y765101**	Standard	980	£285.00

- * For a mattress 1900 x 750mm
- ** For a mattress 1900 x 900mm

B. Double bedstead

- Panel frame
- Size W1970 x H525mm

		Depth mm	
Y765102*	Small	1280	£322.00
Y765103**	Standard	1430	£335.00

- * For a mattress 1900 x 1200mm
- ** For a mattress 1900 x 1350mm

C. Welded frame bed

- Single
- Size W1970 x H525mm

		Depth mm	
Y765104*	Small	830	£275.00
Y765105**	Standard	980	£285.00

- * For a mattress 1900 x 750mm
- ** For a mattress 1900 x 900mm

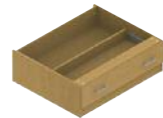

Mattress not supplied, POA

**D. Captain's bed**

- 2 drawer units reqd (see below)
- Size W1970 x H525mm

		Depth mm	
Y765106*	Small	830	£139.00
Y765107**	Standard	980	£152.00

- * For a mattress 1900 x 750mm
- ** For a mattress 1900 x 900mm

E. Drawer units (for item D)

- 1 drawer

Y765108	Fits Y765106		£115.00
Y765109	Fits Y765107		£129.00

**F. Cabin bed, single**

- Size W1970 x H1000mm
- See items G,H & I for storage

		Depth mm	
Y765110*	Small	830	£294.00
Y765111**	Standard	980	£312.00

- * For a mattress 1900 x 750mm
- ** For a mattress 1900 x 900mm



Available in LH or RH

**G. Single under bed storage**

- Single door unit
- Size W480 x H630mm

	Depth mm	
Y765120*	790	£90.00
Y765121**	940	£95.00

- * To suit Y765110
- ** To suit Y765111

H. Double under bed storage

- Double door unit
- Size W960 x H630mm

	Depth mm	
Y765122*	790	£134.00
Y765123**	940	£139.00

- * To suit Y765110
- ** To suit Y765111

I. Drawer under bed unit

- 3 drawer unit
- Size W960 x H630mm

	Depth mm	
Y765124*	790	£265.00
Y765125**	940	£272.00

- * To suit Y765110
- ** To suit Y765111

J. Headboards

- Height 500mm

		Width	
Y765130	Sm Single	800	£38.00
Y765131	Single	980	£41.00
Y765132	Sm Double	1280	£45.00
Y765133	Double	1430	£49.00

Colorado Dormitories

Colorado Dormitories

A range of matching top boxes, coat hooks, tables and wall protectors are available. Please ask for details.

Colour Options

New Product

Wood Finish Options

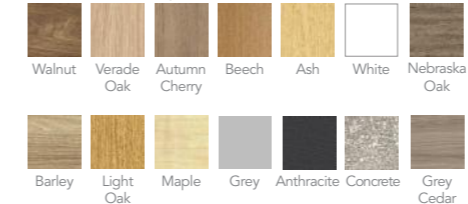

Shelf not supplied

A. Single wardrobe

- Clothes rail (& fittings) incl.
- Size D600 x H1830mm
- Available in LH or RH

	Width mm	
Y765140	400	£248.00
Y765141	500	£262.00
Y765142	600	£274.00



Shelf not supplied

B. Wardrobe & 2 drawers

- Clothes rail (& fittings) incl.
- Size D600 x H1830mm
- Available in LH or RH

	Width mm	
Y765143	400	£314.00
Y765144	500	£336.00
Y765145	600	£355.00



Shelf not supplied

C. Double wardrobe

- Clothes rail (& fittings) incl.
- Size D600 x H1830mm

	Width mm	
Y765146	800	£330.00
Y765147	900	£350.00
Y765148	1000	£368.00



Shelf not supplied

D. Double wardrobe + drawers

- Clothes rail (& fittings) incl.
- Size D600 x H1830mm
- Lockable option available POA

	Width mm	
Y765149	800	£426.00
Y765150	900	£448.00
Y765151	1000	£468.00

**E. Wardrobe shelves**

	W x Dmm	
Y765160	400 x 600	£26.00
Y765161	500 x 600	£27.00
Y765162	600 x 600	£29.00
Y765163	800 x 600	£33.00
Y765164	900 x 600	£35.00
Y765165	1000 x 600	£37.00

**F. Wardrobe fitment**

- 5 shelves to fit double wardrobe
- Clothes rail (& fittings) incl.

Y765166	To Fit Y765146	£122.00
Y765167	To Fit Y765147	£128.00
Y765168	To Fit Y765147	£134.00

**G. Wardrobe fitment**

- 4 shelves, to fit double wardrobe with drawers
- Clothes rail (& fittings) incl.

Y765169	To Fit Y765149	£92.00
Y765170	To Fit Y765150	£98.00
Y765171	To Fit Y765151	£102.00

Colorado Dormitories

New Product



A. Chest of (3) drawers

- 3 drawers

	W	D	H mm	
Y765175	600	470	727	£313.00
Y765176	800	470	727	£339.00
Y765177	600	600	727	£329.00
Y765178	800	600	727	£359.00



B. Chest of (4) drawers

- 4 drawers

	W	D	H mm	
Y765179	600	470	927	£384.00
Y765180	800	470	927	£416.00
Y765181	600	600	927	£403.00
Y765182	800	600	927	£438.00



C. 2 drawer cabinet

- 2 drawer

	W	D	H mm	
Y765183	400	470	727	£219.00



D. 3 drawer cabinet

- 3 drawer

	W	D	H mm	
Y765184	400	470	727	£234.00



Available in LH or RH

E. Single door cabinet

- Single drawer

	W	D	H mm	
Y765185	400	470	727	£184.00



Available in LH or RH

F. Cabinet with drawer & door

- 1 drawer and door

	W	D	H mm	
Y765186	400	470	727	£196.00

Colorado Dormitories

A range of matching top boxes, coat hooks, tables and wall protectors are available. Please ask for details.

Colour Options

New Product

Wood Finish Options

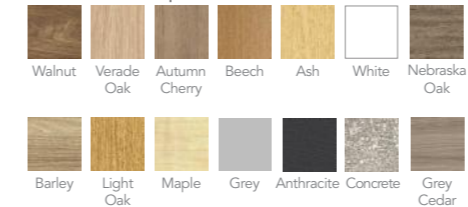

A. Pole leg pedestal desk

- 3 drawer
- Desks are unhandled

	W	D	H mm	
Y765190	1000	600	727	£289.00
Y765191	1200	600	727	£295.00



B. Panel end pedestal desk

- 3 drawer
- Desks are unhandled

	W	D	H mm	
Y765192	1000	600	727	£319.00
Y765193	1200	600	727	£328.00



C. Bookshelves

- Wall Hanging

	W	D	H mm	
Y765194	600	320	700	£109.00
Y765195	800	320	700	£116.00
Y765196	1000	320	700	£121.00



D. Bookcase 1 shelf

- 1 shelf

	W	D	H mm	
Y765197	600	470	727	£175.00
Y765198	800	470	727	£188.00



E. Bookcase 2 shelves

- 2 shelves

	W	D	H mm	
Y765199	600	470	927	£210.00
Y765200	800	470	927	£226.00



F. Bookcase 2 shelves, tall

- 2 shelves

	W	D	H mm	
Y765201	600	470	1127	£222.00
Y765202	800	470	1127	£240.00



Curved Top & Floor Standing Screens



Straight Top



Wave Top



Freestanding Screen Feet



Table Top Clamp

Colour Options Please ask for Cara or Lucia Fabric Swatch

Screens

- Freestanding screens with feet, desk mountable screens, clip on screens in a variety of heights, fabrics and colours to suit your needs
- We can also supply screens made to any specific size or shape, with different features such as glazed tops, aluminium side trims, stabilising disc feet
- Available with PVC or fabric trim, free-standing
- Talk to us and we'll find the right solution for your needs

A. Nimbus floor standing screens

- Free-standing screens come with two feet and can be fitted with linking strips (this must be specified at the time of order and will incur a small extra charge)
- The screen has a fabric trim as standard but can be supplied with grey or wood effect PVC trim at a small extra charge
- Available as standard or linked screens

Size(mm)	Standard Code	Standard Price	Linked Code	Linked Price
w1200 x h1200	YFS1212	£121.00	YLS1212	£129.00
w1000 x h1500	YFS1015	£125.00	YLS1015	£134.00
w1200 x h1500	YFS1215	£134.00	YLS1215	£142.00
w1500 x h1500	YFS1515	£154.00	YLS1515	£162.00
w1600 x h1500	YFS1615	£164.00	YLS1615	£169.00
w1200 x h1800	YFS1218	£146.00	YLS1218	£158.00
w1600 x h1800	YFS1618	£164.00	YLS1618	£189.00

For wave top add WW to code

POA

B. Nimbus desk mounted screens

- Clamp-on version

Wave

YWDT1200	W1200 x H280-480mm	£92.00
YWDT1400	W1400 x H280-480mm	£98.00
YWDT1600	W1600 x H280-480mm	£104.00
YWDT1800	W1800 x H280-480mm	£109.00

Straight

YSDT1200	W1200 x H480mm	£85.00
YSDT1400	W1400 x H480mm	£89.00
YSDT1600	W1600 x H480mm	£96.00
YSDT1800	W1800 x H480mm	£104.00

Curved

YCDT1200	W1200 x H180-380mm	£92.00
YCDT1400	W1400 x H180-380mm	£98.00
YCDT1600	W1600 x H180-380mm	£104.00
YCDT1800	W1800 x H180-380mm	£109.00

Fabric Screens

A. Aluminium end posts, plastic top caps

Size	Group 1 Fabrics Code	Group 1 Fabrics Price	Group 2 Fabrics Code	Group 2 Fabrics Price
W1200 x H380	700400	£114.00	700430	£124.00
W1400 x H380	700401	£117.00	700431	£130.00
W1600 x H380	700402	£132.00	700432	£146.00
W1800 x H380	700403	£140.00	700433	£156.00

B. Aluminium frame, single tool rail

Size	Group 1 Fabrics Code	Group 1 Fabrics Price	Group 2 Fabrics Code	Group 2 Fabrics Price
W1200 x H380	700410	£127.00	700440	£139.00
W1400 x H380	700411	£135.00	700441	£148.00
W1600 x H380	700412	£149.00	700442	£165.00
W1800 x H380	700413	£155.00	700443	£176.00

C. Aluminium frame, triple tool rail

Size	Group 1 Fabrics Code	Group 1 Fabrics Price	Group 2 Fabrics Code	Group 2 Fabrics Price
W1200 x H380	700420	£139.00	700450	£146.00
W1400 x H380	700421	£154.00	700451	£165.00
W1600 x H380	700422	£169.00	700452	£180.00
W1800 x H380	700423	£189.00	700453	£199.00

D. Screen hung accessories

A range of accessories suitable for the desk screen tool rails

Y700470	Pencil Pot	£19.00
Y700471	Name Holder	£16.00
Y700472	Phone Holder	£22.00
Y700473	Trinket Pot	£17.00
Y700474	Letter Tray A3	£29.00
Y700475	Letter Tray A4	£19.00
Y700476	Screen Mounted Pole Monitor Arm	£85.00



A

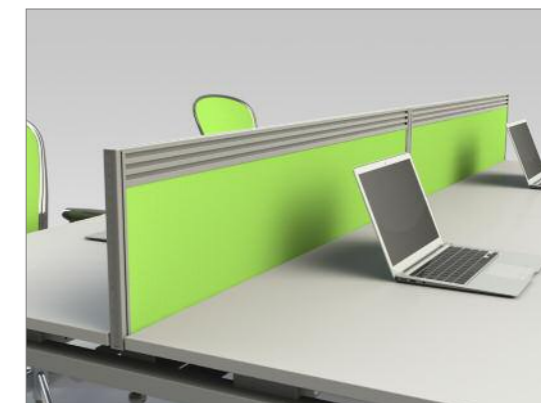

C

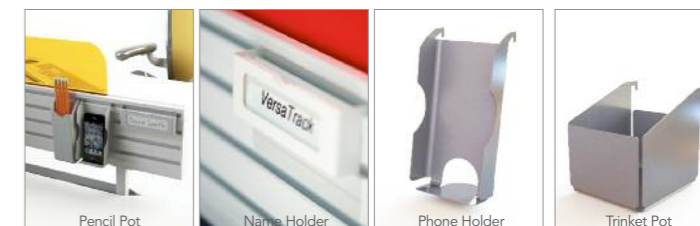

D



Spare Fuse
In Every Socket

A

With black
end caps

Shown in white



Unique fixing brackets

Page Link - see page

Additional
cable
management

315

Spare Fuse
In Every Socket2 sockets with individual
switches

3 sockets

Data housing stand
alone and connected
to power module

C



Cable Management

A. Alpine desk top power modules

- Power and Data where you want it, with added flexibility
- Many choices of configuration of data, power and switches
- Has a spare fuse in every socket
- Can be clamped to the back of the desk in various permutations with the unique fittings on the back of the module (Screen Toolbar mount Also Available)
- Each is supplied with Unique Desk Fittings, 300mm Lead to 3 pole connector and a spare fuse per socket
- Available in White, silver and black

		With* 2M Lead	With* 5M Lead
DTM2P1S	2 x UK Sockets 1 x Neon Switch	£36.10	£41.30
DTM2P2D1S	2 x UK Sockets 1 x Neon Switch 2 x RJ45 Cat5e Data	£50.60	£58.90
DTM4P2D1S	4 x UK Sockets 1 x Neon Switch 2 x RJ45 Cat5e Data	£73.70	£83.60

* Other Lead Lengths Available
Many further options available, please call for details

B. Alpine underdesk power modules

- Unique Design with a spare fuse for each socket so minimum downtime if a fuse fails
- Can be fixed underneath the desk
- Each Module may be linked directly to another – including data housings- to achieve the most complex of requirements quickly, easily and cost effectively
- Various Combinations
- Various Lengths of mains, connector and data leads available (see page opposite)

UPM205E	2 x UK Individually Fused 5A No Switches. 250mm Earth Lead	£14.10
UPM255E	2 x UK Individually Fused 5A 2 Switches. 250mm Earth Lead	£22.90
UPM303E	3 x UK Individually Fused 3.15A No Switches. 250mm Earth Lead	£16.50
UPM313E	3 x UK Individually Fused 3.15A 1 Switches. 250mm Earth Lead	£17.60
UPM405E	4 x UK Individually Fused 5A No Switches. 250mm Earth Lead	£19.80
UPM415E	4 x UK Individually Fused 5A 1 Switches. 250mm Earth Lead	£22.00
UPM445E	4 x UK Individually Fused 5A 4 Switches. 250mm Earth Lead	£24.20

C. Data housings

Use stand alone or clip onto the underdesk power modules

		With 2M Lead*	With 5M Lead*
DH2	Data Housing With 2 x RJ45 Cat5e Data Sockets	£29.00	£34.00
DH4	Data Housing With 4 x RJ45 Cat5e Data Sockets	£51.20	£66.90

* Other Lead Lengths Available-please call for details

Cable Management

A. Mains leads

- Ordered separately for Underdesk Power Modules

ML2	2M UK Plug To 3 Pole Connector	£5.40
ML3	3M UK Plug To 3 Pole Connector	£8.40
ML5	5M UK Plug To 3 Pole Connector	£10.80
ML8	8M UK Plug To 3 Pole Connector	£17.30
ML10	10M UK Plug To 3 Pole Connector	£14.10

Other Lead Lengths Available-please call for details

B. Connector leads

- Must be ordered separately for Underdesk Power Modules if connecting to other modules

CON500	500mm 3 Pole Male to Female	£5.50
CON1M	1M 3 Pole Male to Female	£6.40
CON1500	1.5M 3 Pole Male to Female	£6.80
CON2M	2M 3 Pole Male to Female Connector	£7.50

C. Cat5e booted data leads

- Must be ordered separately for Underdesk Data Housings

DL2	2M RJ45 Cat5E Data Lead	£2.99
DL4	4M RJ45 Cat5E Data Lead	£4.99
DL5	5M RJ45 Cat5E Data Lead	£5.49
DL10	10M RJ45 Cat5E Data Lead	£7.69

Other lead lengths available-please call for details

D. Power desk inserts

- These power modules sit nicely to a standard 80mm grommet hole allowing the user convenient access to a combination of power, data and smart charge USB
- Ideal for charging phones and tablets
- Available in Silver/White, Silver/Grey, Silver/Black
- Other socket combinations available, POA

Y700510	80mm 1 Power, 1 Data 2m	£39.00
Y700511	80mm 1 Power, 1 Data 3m	£41.00
Y700512	80mm 1 Power, 1 Data 5m	£44.00

Y700520	80mm 1 Power, 2 USB Chrg 2m	£77.00
Y700521	80mm 1 Power, 2 USB Chrg 3m	£78.00
Y700522	80mm 1 Power, 2 USB Chrg 5m	£80.00

Y700530	80mm 1 Cat5, 2 USB Chrg 2m	£86.00
Y700531	80mm 1 Cat5, 2 USB Chrg 3m	£88.00
Y700532	80mm 1 Cat5, 2 USB Chrg 5m	£92.00



A



B

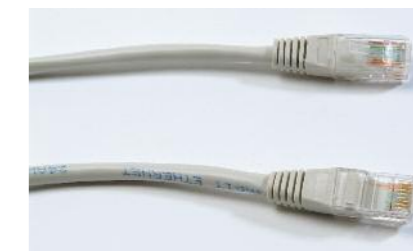

C

1 Power &
1 Data1 Power &
2 USB1 Cat5 &
2 USB

D

A



Available in twin & quad arms



Quick release height adjustment



Quick release VESA Mounting Plate Feature

B

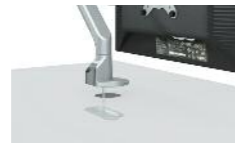

Through desk clamp



Clamp is tightened from above desk



Quick release VESA plate

C



Individual hinge adjustment

Three quick release connections



Holds two monitors up to 4kg each



Fits monitor widths up to 27"



Also includes 75mm VESA fixings to fit any monitor arm

Cable Management

A. Roma monitor arms

- Removable VESA mounting plate
- Quick release height adjustment
- Complete cable management
- Includes clamp and through desk fixing
- Available in black, silver and white

PMA521	Pole Mounted Monitor Arm for Single Screen 12.5kg	£60.40
PMA522	Pole Mounted Monitor Arms for Twin Screens 10kg x 2	£93.50
PMA524	Pole Mounted Monitor Arms for 4 Screens 8kg x 4	£192.50
PMSA521	Tool Rail Mounted Pole Monitor Arm for Single Screen 10kg	£60.50

B. Milano slimline gas lift monitor arms

- Removable VESA mounting plate
- Takes screens from 2kg-9kg
- Complete cable management
- Through desk fixing option
- Available in black, silver and white
- Clamp is tightened from above desk

GMA621	Monitor Arm for Single Screen	£120.50
--------	-------------------------------	---------

C. Milano optional mounting bracket for twin screens

- Capacity for two 4kg screens
- Compatible with other monitor arms via standard 75mm VESA plate
- Monitors fit VESA plates by hand turn screws
- Quick release fittings to Milano arm and both monitors
- Hinges allow individual monitor adjustment
- Certified by FIRA as part of the Milano range

700500		£64.90
--------	--	--------

Cable Management

A. Salerno mini cpu holder

- Ideal for small and thin client CPU's
- Fixes direct to desk top
- Choice of Black, White or Silver

Suitable for Very Small CPUs

		Model	Width Range	Height Range	
CHF1105-BK	Black	C1	50-110mm	190-310mm	£34.70
CHF1105-SV	Silver	C1	50-110mm	190-310mm	£34.70
CHF1105-WH	White	C1	50-110mm	190-310mm	£34.70
CHF1104-BK	Black	C4	40-115mm	205-360mm	£44.60
CHF1104-SV	Silver	C4	40-115mm	205-360mm	£44.60
CHF1104-WH	White	C4	40-115mm	205-360mm	£44.60

B. Salerno large cpu holder

- Ideal for older and large CPU's.
- Fixes direct to desk top
- Adjustable width 110 – 230mm; height 300 – 500mm high
- Choice of Black, White or Silver

		Model	Width Range	Height Range	
CHF2311-BK	Black	C2	110-230mm	300-500mm	£43.90
CHF2311-SV	Silver	C2	110-230mm	300-500mm	£43.90
CHF2311-WH	White	C2	110-230mm	300-500mm	£43.90
CHF2208-BK	Black	C3	110-230mm	300-500mm	£46.00
CHF2208-SV	Silver	C3	110-230mm	300-500mm	£46.00
CHF2208-WH	White	C3	110-230mm	300-500mm	£46.00

C. Salerno C6 universal strap cpu holder

- Ideal for all sizes of CPU.
- Fixes direct to desk top
- Adjustable width 40 – 230mm; height 180 – 500mm high
- CPU can be mounted vertically or horizontally

CHF2504-BK		£23.80
------------	--	--------

D. Vertical cable management

VCS-1	Plastic Cable Duct, White or Silver	£23.10
-------	-------------------------------------	--------

E. Horizontal cable management

Cable trays:

- Silver metal, attached to modesty panel
- D70 x H50mm

CTM085	Cable Tray for 1200mm Desk, W850	£31.90
CTM105	Cable Tray for 1400mm Desk, W1050	£36.30
CTM125	Cable Tray for 1600mm Desk, W1250	£40.70
CTM145	Cable Tray for 1800mm Desk, W1450	£46.20

F. Cable port

ZZZ022	*Extra Cable Port, 80mm Diameter	£5.50
--------	----------------------------------	-------

*Price does not include installation.



VCS-1



E



F

Suppose you wanted to create an atmosphere of excellence...
 Suppose you like impressive classrooms...
 Suppose there was a place for everything...

Storagewall is the perfect solution!



Storagewall can be used in a wide variety of applications, shown here in a management area.

Call today for a free site survey and quotation



Storagewall

Full height storage wall in MFC to provide maximum storage in any available area.

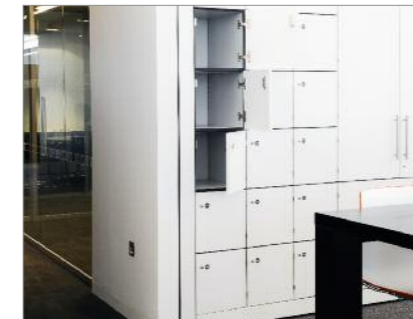

Lockers

The provision of personal storage space is a key objective within today's workplace environment.



Alcove modules

Add a seat or a display module with glass doors and low voltage lighting.



Internal fitments

Choose from shelves, filing frames, letter sorters, drawers to suit your own requirements



Tambours

In areas where space is at a premium such as corridors, tambours will overcome access problems.



Media display

Incorporate plasma screens, video-conferencing facilities and other media aids within specialist media modules.

Module options

Designed and manufactured to save space, save money and give you the most flexible and comprehensive storage system available.

There simply isn't sufficient room here to illustrate the huge range of applications and options, please contact your sales representative to arrange an appointment or call us to arrange a showroom visit.



Pigeon hole units

Can be combined with cupboards or drawers to save time and maximise space.



Bespoke colours

A huge range of options available in both woodgrain effects and plain colours, an opportunity to make your storage wall unique.

Internal fitment options

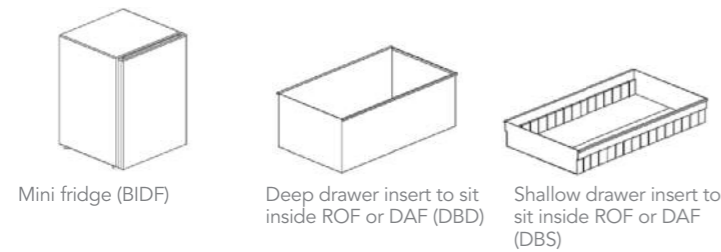
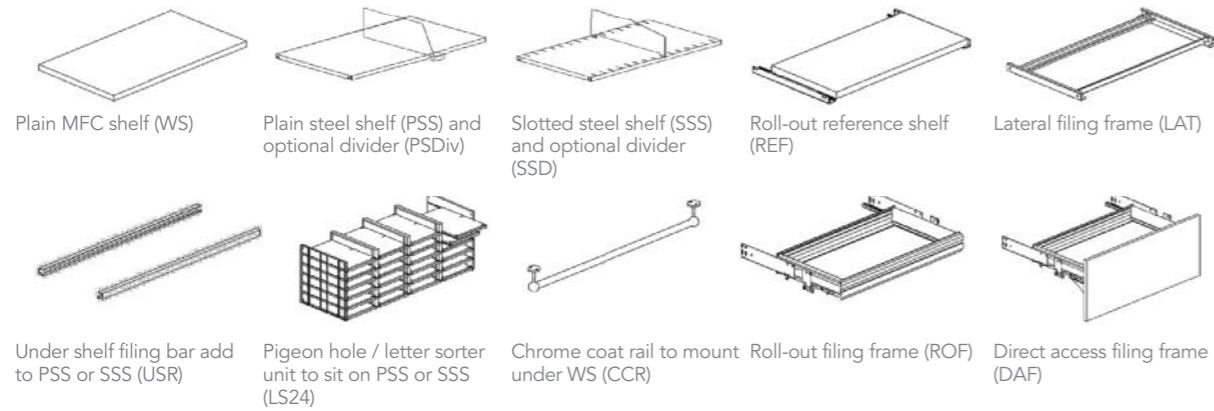

Design options

To further increase the flexibility of the solution available you also have the ability to specify the cupboard functionality using our diverse range of cupboard designs. For space saving and areas such as corridors where access is a key issue utilise the tambour front or sliding doors, for maximum storage the full height doors 'fit the bill', or where something a bit different is needed why not consider wave doors? Variations include split height doors and direct access filing, with the option of glass display alcoves. To increase versatility incorporate lockers and hot desking pedestals for nomadic working practices.

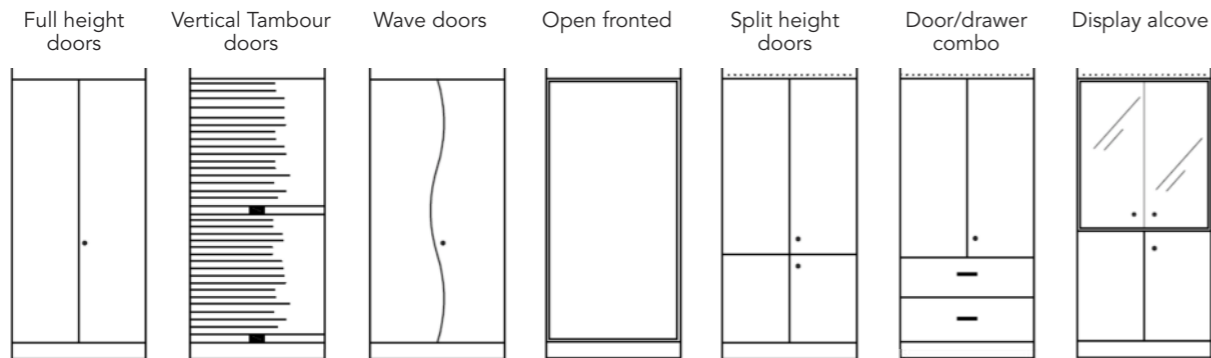

Storagewall - Internals & Options



Storagewall

Storagewall can provide up to 60% more storage than conventional storage cupboards – and in the same floor space usage! By using the full height and width of the available area, a storage density of 15.2² metres of storage per metre² of floor space can be achieved.

Consider the ability of storagewall to create an environment that is uncluttered and attractive to work in, functional and efficient to use and is adaptable to the ever changing demands of the modern workplace, and the argument for including it in your interior scheme becomes compelling.

Totally relocatable, able to provide acoustic ratings in line with the best partition systems, and flexible in design – storagewall is a modular storage system that can adapt to any environment.

Finish options

In order to make your storage wall truly unique and bespoke to your own environment, consider the almost infinite options available to your external finish. From a wide range of standard MFC finishes and coloured laminates, through book-matched and suited real wood veneers, and to more exotic finishes such as spray lacquered paint finishes, back painted glass and graphics—let the storagewall be the palette for your imagination!

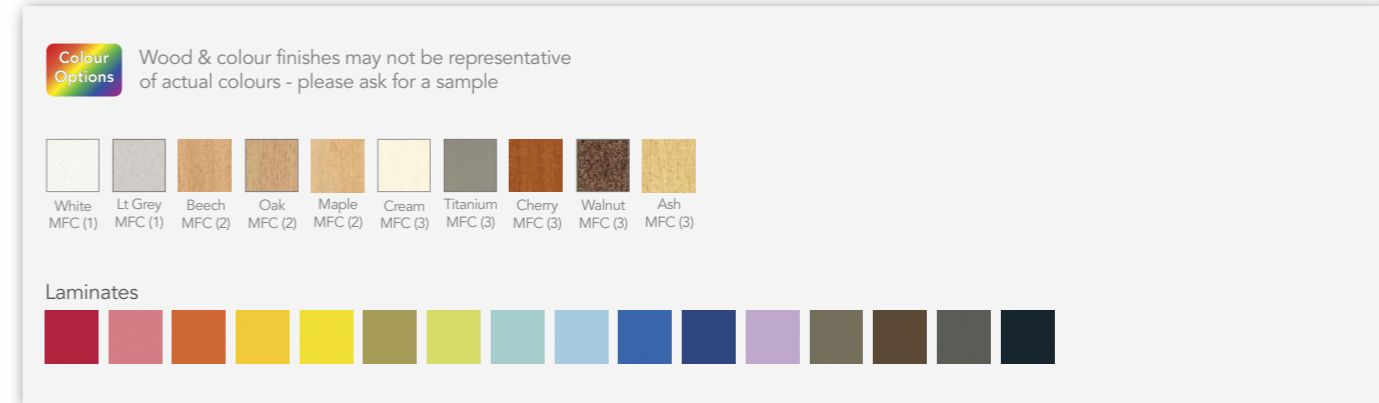

A

FAST
TRACK5 Year
WarrantyPhone
For Bulk
Prices

Steel Storage

A. Lugano standard filing cabinet



- 30kg suspension file carrying capacity per drawer
- 5 year guarantee
- Anti-tilt locking mechanism
- 100% drawer extension
- Drawer depth 445mm
- Standard colour Grey

YSLV2M*	2 Drawer - 711mm High	£109.00
YSLV3M*	3 Drawer - 1009mm High	£128.00
YSLV4M*	4 Drawer - 1320mm High	£134.00

Discounts available on quantity orders

B



B. Lugano multidrawer units



- Locking and non-locking
- 5 year guarantee
- Smooth running drawers
- Available in Goose Grey, Coffee Cream, Light Grey and Black

YMMR05LK	5 Drawer Locking	£112.00
YMMR10LK	10 Drawer Locking	£146.00
YMMR15LK	15 Drawer Locking	£189.00
YMMR05SD	5 Drawer Non Locking	£59.00
YMMR10SD	10 Drawer Non Locking	£103.00
YMMR15SD	15 Drawer Non Locking	£149.00

* Please state colour required

Steel Storage

A. Lugano premium filing cabinet



- 40kg suspension file carrying capacity per drawer
- 10 year guarantee
- 100% drawer extension
- Drawer depth 525mm
- Standard colour Grey

YMIFC2M*	2 Drawer - 711mm High	£123.00
YMIFC3M*	3 Drawer - 1009mm High	£139.00
YMIFC4M*	4 Drawer - 1320mm High	£149.00

A

10 Year
WarrantyPhone
For Bulk
Prices

B

B. Lugano coloured filing cabinet



- 40kg suspension file carrying capacity per drawer
- 10 year guarantee
- Anti-tilt locking mechanism
- 100% drawer extension
- Drawer depth 445mm
- Colours available as shown below
- 3 week delivery

Y785000*	2 Drawer Coloured - 711mm High	POA
Y785001*	3 Drawer Coloured - 1009mm High	POA
Y785002*	4 Drawer Coloured - 1320mm High	POA

* Please add colour code

Colour
Options10 Year
Warranty4 Week
Delivery

5 Year
Warranty

A



Steel Storage

A. Lugano storage cupboard

- Two locking doors with strengthener
- 5 year guarantee
- 5 heights available
- 915mm wide x 458mm deep
- Standard colours: Goose Grey, Coffee Cream, Black, Light Grey and Beige. Other colours available to order - see page 355



YMSC1A	690mm High	£145.00
YMSC4A	1020mm High	£149.00
YMSC6A	1650mm High	£169.00
YMSC7A	1830mm High	£174.00
YMSC8A	1950mm High	£215.00
YCAPSP1SD	Plain Shelf, 330mm Hanging	£14.00

Cupboards supplied empty - choose accessories from range on page 358

15 Year
Warranty

B



B. Lugano executive storage cupboard

- Locking doors with full length reinforcements
- Swan neck handle
- 15 year guarantee
- Security bar option
- 1000mm wide x 507mm deep
- Standard colours: Goose Grey, Coffee Cream, Black, Light Grey and Beige. Other colours available to order - see page 355



Y785020	1020mm High	£174.00
Y785021	1830mm High	£205.00
Y785022	1950mm High	£233.00

Cupboards supplied empty - choose accessories from range on page 358

Steel Storage

A. Lugano side tambour cupboard

- Magnetic handle strip
- Smooth running track
- 5 year guarantee
- 5 heights available
- Standard colours: Goose Grey, Coffee Cream, Black, Light Grey and Beige. Other colours available to order - see page 355
- 1000mm wide x 507mm deep



YM2ESD	690mm High	£269.00
YM4ESD	1016mm High	£289.00
YM9ESD	1320mm High	£313.00
YM6ESD	1651mm High	£333.00
YM7ESD	2000mm High	£344.00
YCAPSP1SD	Plain Shelf, 330mm Hanging	£14.00

Cupboards supplied empty - choose accessories from range on page 358

B. Lugano premium side tambour cupboard

- Smooth track glide system
- 15 year guarantee
- 7 heights available
- 1000mm wide x 507mm deep
- Standard carcass colours: Goose Grey, Coffee Cream, Black, Light Grey and Beige. Other colours available to order - see page 355
- Standard tambour colours: Grey, Black and Beige
- Other tambour colours available to order - Graphite, Silver, Red, Blue and Green - price on application (minimum 10 units)



YMXST2	690mm High	£339.00
YMXST4	1016mm High	£355.00
YMXST5	1200mm High	£389.00
YMXST9	1320mm High	£444.00
YMXST6	1651mm High	£479.00
YMXST7	2000mm High	£485.00
YMXST8	2210mm High	£550.00
YCAPSP1SD	Plain Shelf, 330mm Hanging	£14.00

Cupboards supplied empty - choose accessories from range on page 358

5 Year
Warranty

A

15 Year
Warranty

B





Plain Shelf, 330mm hanging



Wardrobe Shelf



Lateral Filing Frame



Roll Out Shelf



Letter Sorter



Roll Out Slotted Drawer / Shelf Dividers



Slotted Shelf / Slotted Shelf Divider



Plain Shelf, 270mm hanging



Roll Out Suspended Filing Frame

Cupboard fittings

With a range of 9 internals, all your storage requirements are covered; and remember all internals can be used in our range of Lugano Side Tambours, Vertical Tambours as well as Open Fronted Cupboards.

- Please note that roll-out items are only recommended in the bottom half of the units
- Remember to specify anti-tilt with roll-out filing



	Lugano & Lugano Premium	Lugano Executive	
Plain Shelf 330mm Hanging	YCAPSP1SD	Y785053	£14.00
Wardrobe Shelf	YCAWSP1	Y785056	£32.00
Lateral Filing Frame	YCALFP1	Y785050	£21.00
Roll Out Shelf	YCARSP1SD	Y785054	£59.00
Letter Sorter	YCALSP1SD	Y785051	£134.00
Roll Out Slotted Drawer	YCADRP1SD	N/A	£89.00
Shelf Dividers for above Pk5	Y700150	N/A	£14.00
Slotted Shelf	YCASSP1SD	Y785055	£26.00
Shelf Dividers for above PK5	YCASDP5SD	N/A	£31.00
Plain Shelf 270mm Hanging	YCAPSF1SD	Y785052	£29.00
Roll out Suspended Filing Frame	YSDCARFP1	Y785057	£99.00

Teacher Cupboards

- Secure and flexible storage solution for large and small item storage
- Ideal for use in classrooms
- Provides two upper storage levels complete with one adjustable shelf
- Choice of three tray sizes 75, 150 and 225mm high. All trays W312 x D427mm
- Reinforced doors with three point locking
- Tray colour options are opaque, yellow, red and blue
- Supplied with polypropylene trays
- Tray options are 12, 18 & 30 units

Tray storage teacher cupboards

Y785100	12	Extra Deep 225mm	Opaque	£436.00
Y785200	12	Extra Deep 225mm	Red	£436.00
Y785300	12	Extra Deep 225mm	Blue	£436.00
Y785400	12	Extra Deep 225mm	Yellow	£436.00

Y785500	18	Deep 150mm	Opaque	£497.00
Y785600	18	Deep 150mm	Red	£497.00
Y785700	18	Deep 150mm	Blue	£497.00
Y785800	18	Deep 150mm	Yellow	£497.00

Y785900	30	Shallow 75mm	Opaque	£529.00
Y786000	30	Shallow 75mm	Red	£529.00
Y786100	30	Shallow 75mm	Blue	£529.00
Y786200	30	Shallow 75mm	Yellow	£529.00

All cupboards H1830 x W1120 x D457mm. Trays and runners are delivered separately from the cupboard and require fitting on site. Trays manufactured from polypropylene.



Page Link - see pages
Static metal storage
90, 92-94



All cupboards are supplied with a mid grey carcass.

Standard door colours

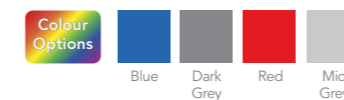



COSHH cabinets

A. COSHH cabinets

Code	Size (h x w x dmm)	Number of Shelves	Sump Capacity	3 Point Locking	Price
YCOH2001	1830 x 1220 x 457	3	45Ltr	✓	£416.00
YCOH2002	1830 x 915 x 457	3	36Ltr	✓	£345.00
YCOH2003	1220 x 915 x 457	2	36Ltr	✓	£299.00
YCOH2004	1830 x 610 x 457	3	20Ltr	✓	£294.00
YCOH2005	1000 x 915 x 457	1	30Ltr	✓	£240.00
YCOH2006	910 x 457 x 457	1	15Ltr	✓	£183.00
YCOH2007	710 x 915 x 457	1	30Ltr	✓	£217.00

B. mini COSHH cabinets

Code	Size (h x w x dmm)	Number of Shelves	Sump Capacity	3 Point Locking	Price
YCOH2008	610 x 915 x 381	1	15Ltr	✓	£206.00
YCOH2009	760 x 457 x 457	1	10Ltr	✓	£175.00
YCOH2010	710 x 915 x 305	1	10Ltr	✓	£166.00
YCOH2011	610 x 457 x 457	1	10Ltr	✓	£168.00
YCOH2012	457 x 457 x 305	1	5Ltr	✓	£159.00

C. COSHH stackable cabinet

Code	Size (h x w x dmm)	Number of Shelves	Sump Capacity	3 Point Locking	Price
YCOH2013	710 x 915 x 457	1	30Ltr	✓	£249.00

Designed to contain spillages via the leak proof sump, suitable for those substances classified as being harmful or irritant.

Supplied with GHS labelling, the primary label is 'Exclamation Mark'.

Dangerous Substance Cabinets

Robust metal construction cabinets with a leak proof sump to contain any spillages. Supplied with GHS labelling, the primary label is 'Flammable'.

A. Dangerous substance cabinets

Code	Size (h x w x dmm)	Number of Shelves	Sump Capacity	3 Point Locking	Price
YDSC1001	1830 x 1220 x 457	3	45Ltr	✓	£389.00
YDSC1002	1830 x 915 x 457	3	36Ltr	✓	£322.00
YDSC1003	1830 x 610 x 457	3	20Ltr	✓	£274.00
YDSC1004	1525 x 915 x 457	2	36Ltr	✓	£303.00
YDSC1005	1220 x 915 x 457	2	36Ltr	✓	£284.00
YDSC1006	1000 x 915 x 457	1	30Ltr	✓	£224.00
YDSC1007	910 x 457 x 457	1	15Ltr	✓	£168.00
YDSC1008	710 x 915 x 457	1	30Ltr	✓	£199.00

B. Mini dangerous substance cabinets

Code	Size (h x w x dmm)	Number of Shelves	Sump Capacity	3 Point Locking	Price
YDSC1009	610 x 915 x 457	1	30Ltr	✓	£195.00
YDSC1010	610 x 915 x 381	1	15Ltr	✓	£196.00
YDSC1011	780 x 457 x 457	1	10Ltr	✓	£163.00
YDSC1012	710 x 457 x 305	1	10Ltr	✓	£155.00
YDSC1013	710 x 355 x 305	1	5Ltr	✓	£149.00
YDSC1014	610 x 457 x 457	1	10Ltr	✓	£157.00
YDSC1015	457 x 457 x 305	1	5Ltr	✓	£149.00

C. Dangerous substance wall cabinets

Code	Size (h x w x dmm)	Number of Shelves	Sump Capacity	3 Point Locking	Price
YDSC1016	610 x 915 x 381	1	15Ltr	✓	£196.00
YDSC1017	480 x 915 x 457	1	20Ltr	✓	£189.00

D. Dangerous substance stackable cabinets

Code	Size (h x w x dmm)	Number of Shelves	Sump Capacity	3 Point Locking	Price
YDSC1018	710 x 915 x 457	1	30Ltr	✓	£232.00
YDSC1019	610 x 915 x 457	1	30Ltr	✓	£225.00



FREE Pen Tray and 2 drawer dividers with every pedestal

Steel Storage

Anzio CUBE Steel Pedestals



White Pedestals, Standard and Narrow Widths



3 Drawer, Silver Pedestals, Standard & Low Heights



- Super strong, smart option for the modern office
- Range includes narrow (300mm) width – ideal for small desks
- Choice of white or silver in all sizes
- Free drawer dividers and pen tray with every pedestal
- Available on Express 7 day delivery
- 4 locking, hidden castors (supplied, fitted)
- 5 year guarantee
- Compact 500mm depth – doesn't clash with large cable trays
- Main colour used inside drawers
- Central locking – free master key with large orders
- Anti-tilt mechanism
- Soft close drawer runners



All Anzio CUBE Steel Pedestals Come With Free Drawer Dividers & Pen Tray

A



A. Steel low mobile pedestal

- 1 Personal drawer 1 File drawer
- 410 x 500 x H495mm

YPMS4511-SV	Silver	£149.00
YPMS4511-WH	White	£149.00

B



B. Steel narrow low mobile pedestal

- 1 Personal drawer 1 File drawer
- 300 x 500 x H495mm

YPMS3511-SV	Silver	£141.50
YPMS3511-WH	White	£141.50

C



C. Steel mobile pedestal

- 2 Personal drawers 1 File drawer
- 410 x 500 x H597mm

YPMS4521-SV	Silver	£191.00
YPMS4521-WH	White	£191.00
YPMS4521-AN	Anthracite	£191.00
YPMS4521-BK	Black	£191.00

D



D Steel narrow mobile pedestal

- 2 Personal drawers 1 File drawer
- 300 x 500 x H597mm

YPMS3521-SV	Silver	£187.50
YPMS3521-WH	White	£187.50
YPMS3521-AN	Anthracite	£187.50
YPMS3521-BK	Black	£187.50

Page Link - see pages
313,320,332
For wooden pedestals



Safes

A. Key deposit safes

- Ideal for schools, office blocks, garages, homes
- Fitted with advanced electronic locking system, including anti-tamper or bounce solenoid locking system, and a key override facility
- Key deposit slot allows keys to be deposited without the need to open the safe
- Prepared for wall mounting, fixing bolts supplied
- Supplied with a selection of coloured key rings

Code	External size H x W x Dmm	Deposit slot H x W x Dmm	Capacity	
Y787600	280 x 300 x 100	55 x 35 x 15	30 keys	£80.00
Y787700	360 x 300 x 100	55 x 35 x 15	48 keys	£87.00
Y787800	660 x 430 x 130	55 x 35 x 15	144 keys	£146.00

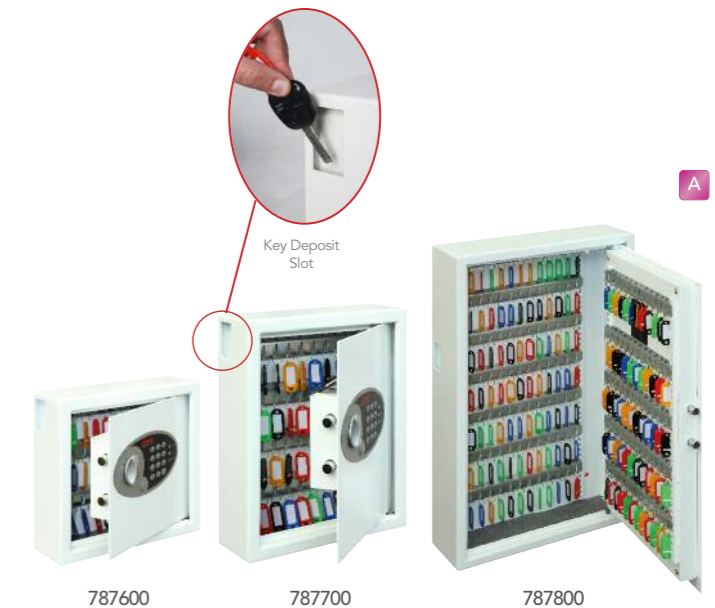

787600

787700

787800

B. Home & office safes

- Recommended for overnight cash cover of £1000 cash or £10,000 valuables
- Twin live locking bolts and concealed internal hinges for increased security
- Electronic locking with high security anti-tamper or bounce solenoid locking system
- Key over ride system. Supplied with 2 keys
- LED internal light
- Prepared for fixing to walls or concrete floors. Fixings supplied
- Scratch resistant metallic graphite paint
- Item 780600 stores laptop up to 430mm wide

Code	External size H x W x Dmm	Internal Size H x W x Dmm	Capacity L	No. Shelves	
Y787100	200 x 310 x 200	195 x 305 x 160	10	0	£56.00
Y787200	250 x 350 x 250	240 x 340 x 210	17	1	£68.00
Y787300	250 x 450 x 365	240 x 440 x 325	34	1	£100.00
Y787400	500 x 350 x 310	495 x 345 x 300	51	1	£122.00
Y787500	560 x 370 x 445	556 x 366 x 435	88	1	£149.00



787100



787200



787300



LED Internal Light



787400



787500

Lifetime
Warranty

A



Safes

A. Electronic fire safe

- Modern, compact fire and security safe
- 60 minute fire protection for paper and digital media, DVDs, USBs, memory sticks
- £2000 cash and £20,000 valuables rating
- Prepared for floor fixing, including bolts
- Fitted with user friendly, high security electronic lock
- Key hooks and pull out drawer included

	Internal/External Size H x W x Dmm	Capacity Litres	Weight Kg	
YEFS1	206 x 320 x 234 360 x 412 x 363	19	30	£184.00
YEFS2	320 x 260 x 304 410 x 350 x 430	25	34	£211.00
YEFS3 (underdesk)	410 x 300 x 300 515 x 400 x 440	36	53	£237.00

B. Security safe

- Fitted with high security double bitted VDS Class 1 key lock
- Fixing bolts supplied
- Manufacturer's insurance rating for cash and jewellery
- Also available with electronic locking, ask for details

	Internal/External Size H x W x Dmm	Capacity Litres	Weight Kg	
Y1181	140 x 270 x 200 220 x 350 x 300	18	20	£159.00
Y1182	270 x 370 x 250 350 x 450 x 350	28	40	£214.00
Y1183 (underdesk)	470 x 370 x 250 550 x 450 x 350	43	56	£289.00

C. Fire resistant media safe

- A compact data safe for convenient storage of important disks, tapes and electronic records
- Magnetic media fully protected
- 60 minute fire resistance for data
- Y2003 supplied with 2 shelves. Pull out media trays are optional extra.

	Internal/External Size H x W x Dmm	Capacity Litres	Weight Kg	
Y2001	245 x 155 x 197 420 x 350 x 430	7	43	£333.00
Y2002 (underdesk)	380 x 235 x 187 600 x 470 x 470	17	95	£639.00
Y2003	495 x 400 x 405 770 x 690 x 720	80	242	£1128.00

Suitable for
exam papers

B



C



Safes

A. Fire resistant cupboards

- High security cupboards with double walled construction
- Perfect for storing sensitive exam papers
- Fire resistant to 30 minutes
- 3 way locking system
- Supplied with height adjustable shelves
- Standard colour grey (RAL7035)
- Internal fittings available at extra cost. Please call for details.
- Electronic keypad locking system

Code	Internal Size h x w x d (mm)	Capacity Litres	Weight Kg	
YFRC1	1082 x 506 x 415 3 Shelves Light Grey	227	77	£733.00
YFRC2	1050 x 814 x 415 4 Shelves Light Grey	354	106	£929.00
YFRC3	1810 x 814 x 415 4 Shelves Light Grey	611	152	£1164.00

All models are available with an electronic keypad locking system as shown below.

YFRC1L	1082 x 506 x 415 3 Shelves Light Grey	227	77	£806.00
YFRC2L	1050 x 814 x 415 4 Shelves Light Grey	354	106	£999.00
YFRC3L	1810 x 814 x 415 4 Shelves Light Grey	611	152	£1237.00

B. Double secure filing cabinets

- Robust filing cabinets with locking bar system giving high security storage at a budget price
- 100% drawer extension
- 7 year guarantee
- Available in Goose Grey or Coffee Cream

Y11325	2 Drawer		£189.00
Y11326	3 Drawer		£218.00
Y11327	4 Drawer		£230.00

C. Fire resistant filing cabinets

- Light grey filing cabinets
- Fire resistant for 90 minutes
- Individual fire protection for all drawers
- Fire and impact tested 9.1metres for resistance to the impact of falling through the burning floors of a building

Y2244	4 Drawer	230kg	£1355.00
Y2242	2 Drawer	140kg	£929.00

D. Double secure filing cupboard

- Robust filing cupboard with locking bar system giving high security storage at a budget price
- 2 locking doors
- 5 year guarantee
- 915mm wide x 458mm deep
- Standard Colours: Light Grey, Goose Grey, Graphite, Black or Coffee Cream

Y785030	1830mm High		£289.00
---------	-------------	--	---------



A

Delivery of security cupboards is free of charge to a ground floor location with no more than one step involved. Other delivery locations require a site survey & quotation.

B



D



C



Page Link - see pages
For exam tables... 46-47



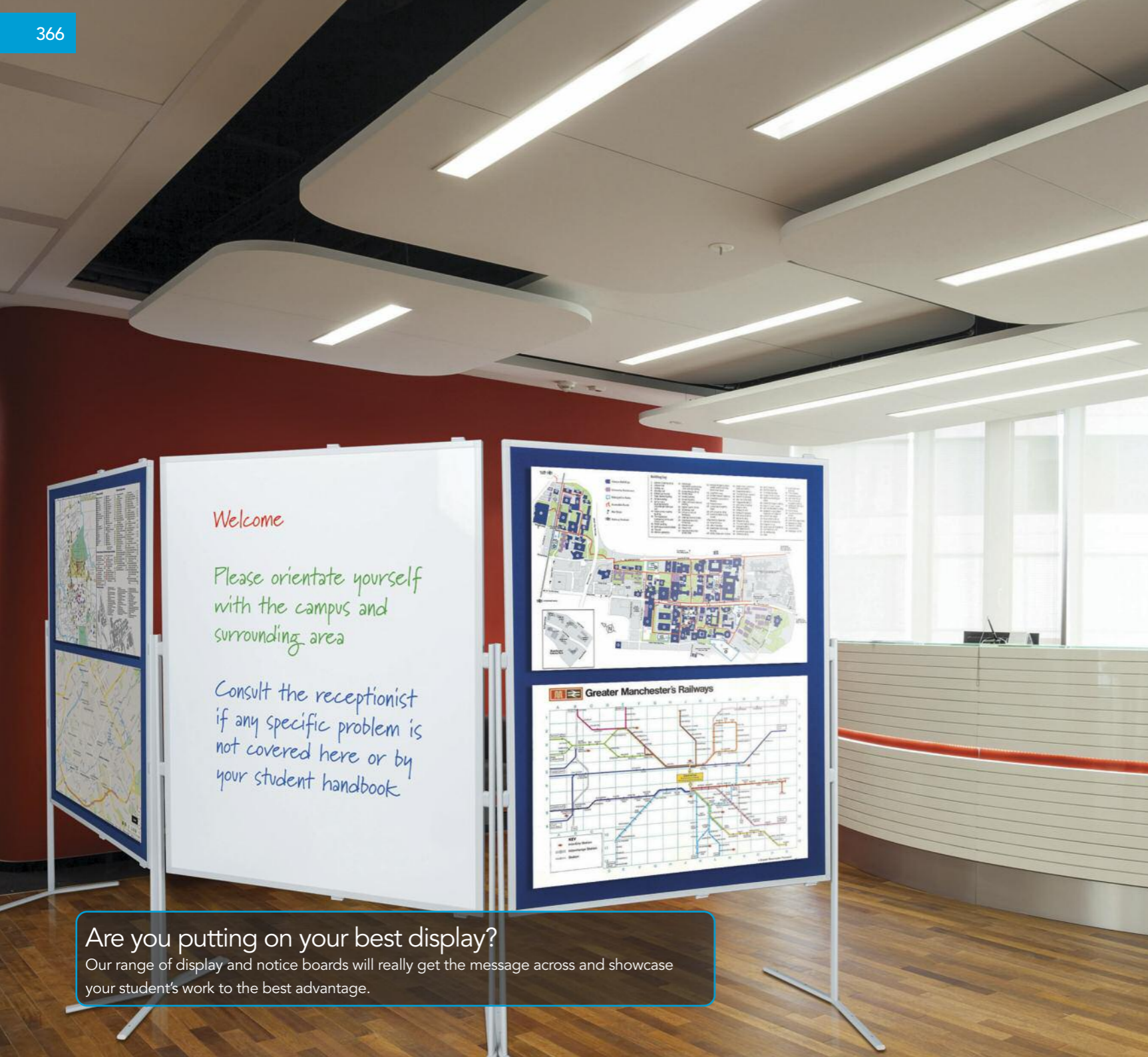

Are you putting on your best display?

Our range of display and notice boards will really get the message across and showcase your student's work to the best advantage.

Presentation & Display

Whiteboards	368-370
Glass Boards	371
Mobile Whiteboards	372-373
Flipchart Easels	374-375
Projection Boards	376
Projection Screens	377
Noticeboards	378-385
Exterior Showcases	386-387
Folding Display Systems	388-391
Literature Display	392
Poster Frames	393
Display Showcases	394-395
Lecterns	396
AV Cabinets	397

Presentation & Display

Having a display that looks effective and attractive can sometimes be difficult to achieve. Our large range of high quality display products will assist you in presenting your student's work to look its best as well as adding a feature to your classroom or school.

Whether you require just one notice board or a complete display system we can fulfill your requirements to your best advantage. If there is something you are looking for and can't find it in our catalogue please give us a call; we are sure we will be able to source it for you.



Best
Seller

A



B

Premium
Quality Brands

C

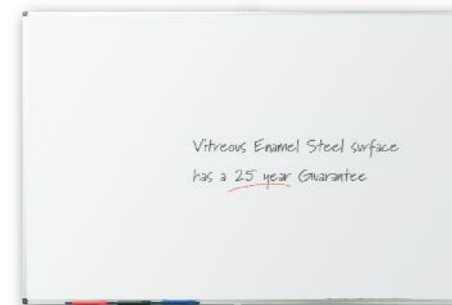
Premium
Quality Brands

Whiteboards

A. Plain & gridded non-magnetic whiteboards

Double sided whiteboard with one side plain ultrasmooth surface and gridded surface on the other. The gridded side has a feint 20mm square grid that assists the presenter, but is unseen by the audience. Aluminium framed & supplied with pen tray and concealed through-the-corner wall fixings. For use with drywipe pens. Mounted landscape or portrait.

YSMDW152	W600 x H450mm	each	£16.55
YSMDW32	W600 x H900mm	each	£21.45
YSMDW43	W900 x H1200mm	each	£28.60
YSMDW44	W1200 x H1200mm	each	£37.40
YSMDW54	W1500 x H1200mm	each	£48.60
YSMDW64	W1800 x H1200mm	each	£53.75
YSMDW84	W2400 x H1200mm	each	£70.00
YSMDW94	W2700 x H1200mm	each	£111.95

B. Magnetic whiteboards

This economically priced whiteboard has a revolutionary new surface which is ultra smooth to improve erasability, with the added advantage of accepting magnets

- Aluminium framed plain white drywipe surface
- Supplied with concealed wall fixings and pen tray
- All boards 180cm wide and larger have extra central fixings at top and bottom for additional safety and stability

YSMDWM152	W450 x H600mm	each	£17.25
YSMDWM32	W600 x H900mm	each	£24.25
YSMDWM43	W900 x H1200mm	each	£40.75
YSMDWM44	W1200 x H1200mm	each	£51.25
YSMDWM54	W1500 x H1200mm	each	£64.25
YSMDWM64	W1800 x H1200mm	each	£67.95
YSMDWM84	W2400 x H1200mm	each	£89.10
YSMDWM94	W2700 x H1200mm	each	£111.95
YSMDWM98	W3000 x H1200mm	each	£138.40

C. Vitreous enamel steel magnetic whiteboards

Vitreous Enamel Steel guaranteed for 25 years

- Aluminium framed whiteboards with concealed corner fixings and pen tray
- Surface accept magnets
- All boards 180cm wide and larger have extra central fixings at top and bottom for additional safety and stability

YVDW152	W450 x H600mm	each	£26.75
YVDW32	W900 x H600mm	each	£37.25
YVDW43	W1200 x H900mm	each	£62.65
YVDW44	W1200 x H1200mm	each	£87.70
YVDW54	W1500 x H1200mm	each	£99.60
YVDW64	W1800 x H1200mm	each	£119.10
YVDW84	W2400 x H1200mm	each	£148.00
YVDW94	W2700 x H1200mm	each	£200.45

Whiteboards

A. Light oak effect premium aluminium frame whiteboard

Stunning light oak wood effect aluminium frame with a traditional yet contemporary finish without the maintenance of real wood.

- Coated Steel Surface accepts magnets
- Attractive contoured frame design
- Concealed corner fixings

Y801650	W900 x H600mm	£55.65
Y801652	W1200 x H900mm	£76.75
Y801646	W1200 x H1200mm	£91.45
Y801648	W1500 x H1200mm	£110.10
Y801654	W1800 x H1200mm	£126.50
Y801656	W2400 x H1200mm	£152.05

B. Coloured edge premium aluminium frame whiteboard

- Concealed corner fixings
- Coated steel surface accepts magnets
- Available in 4 different colours

Y801150	W900 x H600mm	£69.25
Y801152	W1200 x H900mm	£93.75
Y801154	W1200 x H1200mm	£107.55
Y801156	W1500 x H1200mm	£128.65
Y801158	W1800 x H1200mm	£145.10
Y801160	W2400 x H1200mm	£171.35

**Please specify colour when ordering

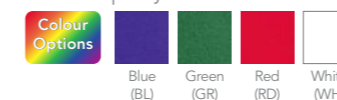

C. Coloured edge frameless whiteboards

- The tough ABS colour edging adds a modern accent to an everyday product
- Frameless whiteboard with a coloured edge
- Mounts flush to the wall
- Choice of 6 bright colours with matching caps
- Ideal for mounting side by side
- Please note: these boards are frameless so sizes shown are nominal

Y31060**	W900 x H600mm	each	£23.75
Y31062**	W1200 x H900mm	each	£33.00
Y31064**	W1200 x H1200mm	each	£39.20
Y31066**	W1500 x H1200mm	each	£54.20
Y31068**	W1800 x H1200mm	each	£59.90
Y31070**	W2400 x H1200mm	each	£74.05

**Please specify colour when ordering

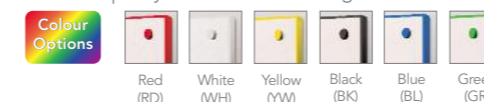
New Sizes
Available

A

New
Product

B



C





A



New Product



B

Whiteboards

A. Whiteboard walling

- Create a continuous drywipe whiteboard wall
- Frameless design
- 6 standard sizes to choose from to create the best option
- Simple through the board fixing
- ABS edge, white caps mask fixings
- Double sided, plain on one side, and feint square grid on the other
- Bespoke sizes available - please enquire

Y31072	W876 x H578mm	each	£28.75
Y31074	W1176 x H876mm	each	£38.00
Y31076	W1176 x H1176mm	each	£44.20
Y31078	W1476 x H1176mm	each	£59.20
Y31080	W1779 x H1176mm	each	£69.90
Y31082	W2379 x H1176mm	each	£84.05

Page Link - see pages
For
Conference Seating 256-271



Page Link - see pages
For
Meeting Tables 296-307



B. Frameless magnetic board

- Boards butt together to create a seamless, continuous run on flat walls
- Mounts flush to the wall
- Concealed mounting system
- Coated steel surface bonded to multi-layered wood backing

Y802500	W1200 x H1000mm	£324.00
Y802505	W2400 x H1000mm	£587.00



Edge detail

Glass Boards

A. Magnetic glass whiteboards

- The ultimate in contemporary drywipe presentation
- Magnetic glass drywipe board
- 4mm toughened safety glass, needs super strength magnets
- Chrome mounts which float the board away from the wall
- All fixings included
- Only available in White

Y31091	W600 x H900mm	each	£93.65
Y31092	W650 x H1000mm	each	£107.95
Y31093	W1500 x H1000mm	each	£195.45
Y31094	W900 x H1200mm	each	£147.60
Y31095	W1200 x H1200mm	each	£187.30
Y31096	W1800 x H1200mm	each	£253.10
Y31097	W2400 x H1200mm	each	£340.65
Y800120	Glass Pen Tray	each	£13.35



A

B. Coloured glass information boards

- Display your messages or menus in style
- 6 standard colour range, 4 vibrant colour range
- Range of attractive glass dry-wipe boards
- 4.5mm toughened glass with a steel back
- Accepts super strength magnets
- Board stands proud of the wall on special fixings

Y31098**	W500 x H500mm	each	£46.45
Y31099**	W450 x H600mm	each	£50.00

** Please specify board colour when ordering



B

C. Revolving glass whiteboard

Versatile mobile glass whiteboard that rotates and tilts to the desired viewing angle

- Steel core to accept super strength magnets
- White steel frame
- Sturdy feet with locking castors
- Full width steel pen tray

Y801658	W1200 x H900mm	£419.20
---------	----------------	---------



C

A



Mobile Whiteboards

A. Height adjustable mobile whiteboards

Double sided mobile drywipe whiteboard

- White anodised aluminium frame with locking castors
- Height adjustable panels that can be mounted portrait or landscape
- Double sided whiteboard with one side plain and the reverse with a faint grid

Y801280	W900 x H1200mm	£137.60
Y801282	W1200 x H1200mm	£146.90
Y801284	W1500 x H1200mm	£156.60
Y801286	W1800 x H1200mm	£167.20

Page Link - see pages
For Meeting Tables 296-307



B



B. Combi mobile noticeboards

- Freestanding board with whiteboard one side, noticeboard on reverse
- A versatile mobile board offering both pinboard and whiteboard applications in one product
- Available in two popular sizes and mounted on a stable powder coated steel frame, with four castors two of which are lockable
- A1 flip pad clamp on all whiteboard surfaces
- W700 x H1200mm available in grey or blue pinboard

DUONB127	W700 x H1200mm, Grey	each	£109.90
Y802000	W700 x H1200mm, Blue	each	£109.90
DUONB110	W1000 x H1000mm, Grey	each	£119.40

Mobile Whiteboards

A. Premium revolving whiteboards

- Versatile mobile whiteboard with dual action pivoting board
- Double sided whiteboard that can pivot on either its horizontal or vertical axis, enabling both sides to be used, or the surface angled towards the audience
- Available with coated steel writing surface that has the advantage of accepting magnets, or non-magnetic surface that is one side plain, one side gridded

Non Magnetic

YREV912	W1200 x H900mm	each	£136.55
YREV129	W900 x H1200mm	each	£139.15
YREV1212	W1200 x H1200mm	each	£149.15
YREV1512	W1500 x H1200mm	each	£160.90
YREV1812	W1800 x H1200mm	each	£178.35

Magnetic

YREVM912	W1200 x H900mm	each	£173.75
YREVM129	W900 x H1200mm	each	£173.75
YREVM1212	W1200 x H1200mm	each	£188.00
YREVM1512	W1500 x H1200mm	each	£211.90
YREVM1812	W1800 x H1200mm	each	£240.55

B. Standard revolving whiteboards

- Double sided whiteboard that can pivot on its horizontal axis
- Enables both sides to be used, or the surface angled towards the audience
- Available with coated steel writing surface that has the advantage of accepting magnets, or non-magnetic surface that is one side plain, one side gridded.
- Sturdy steel frame has four castors, 2 locking
- Steel cross bars aid rigidity and house a full length pen tray

Non Magnetic

YREV912	W1200 x H900mm	each	£104.00
YREV129	W900 x H1200mm	each	£106.35
YREV1212	W1200 x H1200mm	each	£111.70
YREV1215	W1500 x H1200mm	each	£122.00
YREV1218	W1800 x H1200mm	each	£129.50

Magnetic

YREVM912	W1200 x H900mm	each	£161.00
YREVM129	W900 x H1200mm	each	£164.55
YREVM1212	W1200 x H1200mm	each	£185.70
YREVM1215	W1500 x H1200mm	each	£208.35
YREVM1218	W1800 x H1200mm	each	£236.65

A

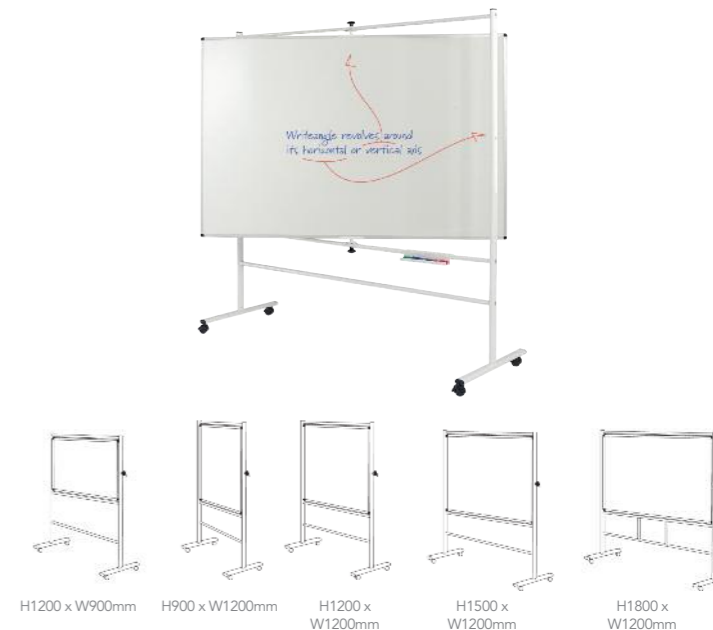

B





Flipchart Easels

A. Ultimate loopleg flipchart easel (coloured frames)

- Loopleg design creates very steady base with footbar
- Good stability when writing
- Double sized magnetic whiteboard, fully height adjustable
- Suitable for A1 standard 2 hole drilled pads
- Board size W650 x H860mm
- Max height 1770mm
- Optional carry bag

Y31001**	Flipchart Easel	each	£72.60
Y31067	Optional Carry Bag	each	£26.75

** Please specify colour when ordering

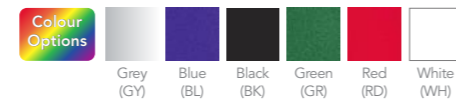

B. Glass flipchart easel

High quality glass easel for the ultimate presentation

- Steel backed to accept super strength magnets
- White steel frame
- Star base with locking castors
- Adjustable hook over flipchart pad hangers
- Full width aluminium pen tray
- 1000 x 700mm glassboard

Y801660	Glass Easel		£231.00
---------	-------------	--	---------

C. Ultimate mobile flipchart easel (coloured frames)

- Heavy duty mobile frame
- Magnetic whiteboard
- Height adjustable column
- Round tubular steel base
- Board size W700 x H1000mm
- Max height 1950mm

Y31003**	Mobile Easel	each	£131.05
----------	--------------	------	---------

** Please specify colour when ordering

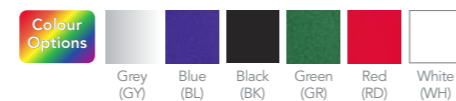

Flipchart Easels

A. Harrier flipchart easel

Economy tripod easel with class beating features

- Rear leg tie bar for extra stability and durability
- Telescopic legs for simple height adjustment
- Non-magnetic drywipe surface
- Available in Black or White frame
- Board size 1000 x 700mm
- Max height 1850mm

Y800130	Harrier Flipchart Easel - White	£55.00
Y800132	Harrier Flipchart Easel - Black	£55.00



B. Eagle mobile flipchart easel

Mobile easel mounted on five star base with locking castors

- Magnetic whiteboard
- Height adjustable
- Two side arms supplied as standard for hanging completed sheets
- Full width pen tray
- Board size 1000 x 700mm
- Max height 1820mm

Y800140	Mobile Flipchart Easel	£102.25
---------	------------------------	---------



C. A1 flipchart pads

Ideal for easels and mobile flipcharts

- 40 sheets per pad
- Supplied in packs of 5

Y800150	Pack of 5 Pads	£35.00
---------	----------------	--------



A



B



C

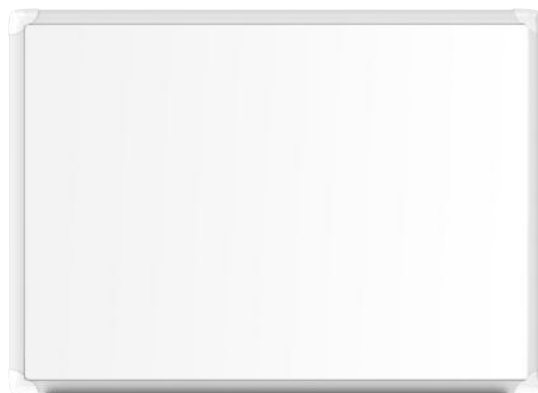

Projection Boards

A. High quality projection whiteboard

A projection whiteboard that is ideal for positioning next to standard magnetic whiteboards

- Made from high quality vitreous enamel semi matte steel
- Accepts standard drywipe markers
- Accepts magnets
- Ideal for short throw or ultra-short throw projectors
- 25 year surface warranty

Y801710	W1800 x H1200mm	£228.55
Y801712	W2400 x H1200mm	£294.40

B. Premium projection whiteboards

Semi-matt drywipe surface in 3 formats

- Top grade Japanese vitreous enamel steel, guaranteed for 25 years
- The semi-matt surface diffuses any hot spots
- Balanced steel back to avoid distortion
- Please ensure boards are fixed to a solid wall due to heavy materials used in the construction

Format: 4:3

View area: W1575 x H1181mm

Overall: W1615 x H1221mm

Y31084	4:3 Projection Board	each	£242.80
--------	----------------------	------	---------

Format: 16:9

View area: W2100 x H1181mm

Overall: W2140 x H1221mm

Y31086	16:9 Projection Board	each	£303.40
--------	-----------------------	------	---------

Format: 16:10

View area: W1890 x H1181mm

Overall: W1930 x H1221mm

Y31088	16:10 Projection Board	each	£267.80
--------	------------------------	------	---------

C. Slimline interactive whiteboard

3 in 1 solution; interactive board, projection screen and standard whiteboard

- Plug and play – extremely easy to use
- Accurate infrared technology
- Low power consumption
- 25 year warranty ceramic steel surface
- Highly scratch-resistant
- Plastic and aluminium frame

Y801714	W1793 x H1338mm (78")	£1065.00
---------	-----------------------	----------

Projection Screens

A. Portable projection screen

- Fully height adjustable
- Heavy duty tripod base
- Integral carry handle
- 5 different size viewing areas
- Plain matt white borderless surface or matt white projection surface with black borders

Borderless	Overall Size	
Y801100	W1250 x H1250mm	£54.30
Y801110	W1500 x H1500mm	£65.00
Y801120	W1800 x H1800mm	£69.75
Y801130	W2000 x H2000mm	£96.60
Y801140	W2400 x H2400mm	£144.25

With Borders

Y801105	W1250 x H1250mm	£71.15
Y801115	W1500 x H1500mm	£78.15
Y801125	W1800 x H1800mm	£96.60
Y801135	W2000 x H2000mm	£110.15
Y801145	W2400 x H2400mm	£160.15

B. Manual wall-mounted projection screen

- Popular manual pull-down screen
- New slow safety retract mechanism
- Good quality matt white woven cloth
- Easy to mount to wall or ceiling
- Available in 5 different size viewing areas
- Plain matt white borderless surface or matt white projection surface with black borders
- Wider choice of manual and electric projection screens available - please ask for details

Borderless	Overall Size	
Y801200	W1250 x H1250mm	£56.00
Y801210	W1500 x H1500mm	£59.10
Y801220	W1800 x H1800mm	£66.35
Y801230	W2000 x H2000mm	£81.85
Y801240	W2400 x H2400mm	£160.05

With Borders

Y801215	W1500 x H1500mm	£66.35
Y801225	W1800 x H1800mm	£76.70
Y801235	W2000 x H2000mm	£91.25
Y801245	W2400 x H2400mm	£180.05

A



B



A



Felt colours:



B

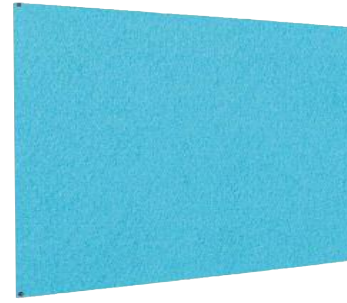

Fabric colours:



Ideal for escape routes/corridors

C

Acoustic Properties

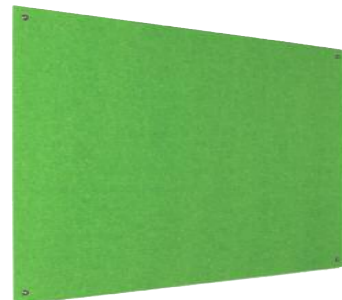

Unframed Noticeboards

A. Unframed noticeboards

This superior frameless pinboard is made from a high quality board and felt to give a durable and effective product.

- Can be mounted landscape or portrait
- Mounts through the board fixings supplied
- Available in Blue (BL), Burgundy (BG), Green (GR), Red (RD), Grey (GY)
- Can be made to a custom size - POA
- 1500 x 1200mm and larger are supplied in 2 parts

YUNB9060**	W900 x H600mm	each	£17.35
YUNB129**	W1200 x H900mm	each	£23.90
YUNB1212**	W1200 x H1200mm	each	£29.45
YUNB1512**	W1500 x H1200mm	each	£40.00
YUNB1812**	W1800 x H1200mm	each	£45.40
YUNB2412**	W2400 x H1200mm	each	£56.85

**Please specify colour when ordering

B. Colourtone vibrant unframed noticeboards

Simple yet effective style noticeboards to brighten up areas of any establishment.

- Can be mounted landscape or portrait
- Frameless design
- Available in 6 vibrant colours
- 3 largest sizes are supplied in 2 parts

Y801900**	W900 x H600mm	each	£24.10
Y801904**	W1200 x H900mm	each	£31.75
Y801905**	W1200 x H1200mm	each	£43.30
Y801907**	W1500 x H1200mm	each	£50.05
Y801909**	W1800 x H1200mm	each	£62.10
Y801911**	W2400 x H1200mm	each	£67.70

**Please specify colour when ordering

C. Unframed EcoColour® noticeboards

A fantastic range of recycled noticeboards that are not only fire resistant but also have acoustic properties

- Fire Resistant to Class 0
- Noticeboard is classified a 'B' according to BS EN13501-1
- Made from recycled materials
- Acoustic properties up to NRC 0.8
- Self- coloured pinnable core
- Available in 11 different colours

Y801500**	W900 x H600mm	£25.20
Y801502**	W1200 x H900mm	£41.40
Y801504**	W1200 x H1200mm	£52.90
Y801506**	W1500 x H1200mm	£64.15
Y801508**	W1800 x H1200mm	£78.55
Y801510**	W2400 x H1200mm	£102.25

**Please specify colour when ordering

Framed Noticeboards

A. Aluminium framed noticeboards

Made in the UK to the highest standards.

- Felt accepts Velcro® as well as pins - colour fast to BS1006
- Available in 5 standard felt colours - Blue (BL), Burgundy (BG), Red (RD), Green (GR), Grey (GY) or traditional cork
- Flush fix corners conceal wall fixings (supplied)

YNBS64**	W600 x H450mm	each	£16.25
YNBS96**	W900 x H600mm	each	£22.00
YNBS129**	W1200 x H900mm	each	£29.70
YNBS1212**	W1200 x H1200mm	each	£37.95
YNBS1512**	W1200 x H1500mm	each	£47.40
YNBS1812**	W1200 x H1800mm	each	£50.55
YNBS2412**	W1200 x H2400mm	each	£62.85

** Please specify colour when ordering

B. Colourtone vibrant noticeboards

- Colourtone range features 6 vibrant and contemporary colours that add a modern accent to an everyday product.
- New range of bright contemporary coloured fabric finishes
- Fabric accepts Velcro as well as pins
- Aluminium frames
- Flush fix corners conceal wall fixings
- 3 smaller size options available - please enquire

Y31000**	W900 x H600mm	each	£31.00
Y31002**	W1200 x H900mm	each	£40.95
Y31005A**	W1200 x H1200mm	each	£48.20
Y31007A**	W1500 x H1200mm	each	£62.05
Y31008**	W1800 x H1200mm	each	£70.15
Y31011A**	W2400 x H1200mm	each	£92.20

** Please specify colour when ordering

C. Aluminium frame EcoColour® noticeboards

A fantastic range of recycled noticeboards with aluminium frame that are not only fire resistant but also have acoustic properties

- Fire Resistant to Class 0
- Noticeboard is classified a 'B' according to BS EN13501-1
- Made from recycled materials
- Acoustic properties up to NRC 0.8
- Self- coloured pinnable core
- Available in 11 different colours

Y801520**	W900 x H600mm	£36.15
Y801522**	W1200 x H900mm	£63.85
Y801524**	W1200 x H1200mm	£73.65
Y801526**	W1500 x H1200mm	£90.75
Y801528**	W1800 x H1200mm	£117.60
Y801530**	W2400 x H1200mm	£136.10

** Please specify colour when ordering

Best Seller

A

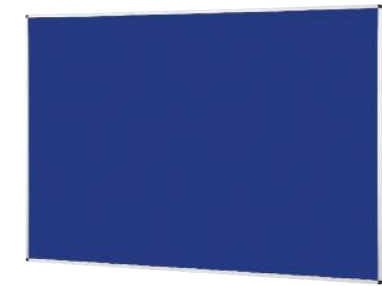

Felt colours:



B

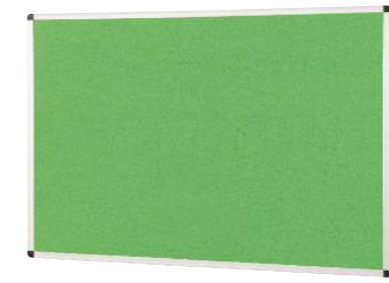

Fabric colours:

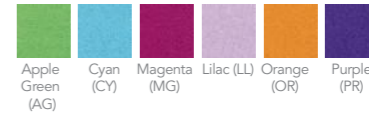

Ideal for escape routes/corridors

Acoustic Properties

C





A



Felt colours:

Frame options

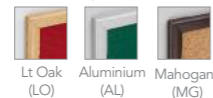

Ideal for escape routes/corridors

B

Acoustic Properties



Fire Resistant



C



See page 382 for 17 loop nylon colour options



Framed Noticeboards

A. Eco-friendly noticeboards

Ever popular range offering an environmental choice at an economical price and made in the UK

- Almost entirely constructed from timber industry by-products and recycled materials
- Attractive contoured 35mm wide frame is available in a choice of light oak, mahogany or aluminium effect finishes
- Available in 5 felt colours: Blue (BL), Burgundy (BG), Green (GR), Grey (GY), Red (RD) or Traditional Cork (CK)
- Felt accept both pins and Velcro®, cork option is pinnable
- Boards can be mounted portrait or landscape with concealed fixings provided

YECF96**	W900 x H600mm	£24.05
YECF129**	W1200 x H900mm	£32.85
YECF1212**	W1200 x H1200mm	£37.40
YECF1512**	W1500 x H1200mm	£50.55
YECF1812**	W1800 x H1200mm	£58.70
YECF2412**	W2400 x H1200mm	£74.40

** Please specify colour of material and frame when ordering

B. Light oak effect premium aluminium frame EcoColour® noticeboard

A range of boards made from the EcoColour® recycled material with a stunning light oak effect aluminium frame.

- Can be mounted portrait or landscape
- Acoustic properties up to NRC 0.8
- Self-coloured pinnable core
- Available in 11 different colours
- Fire Resistant to Class 0
- Noticeboard is classified a 'B' according to BS EN13501-1

Y801560**	W900 x H600mm	£54.60
Y801562**	W1200 x H900mm	£74.55
Y801564**	W1200 x H1200mm	£89.60
Y801566**	W1500 x H1200mm	£118.45
Y801567**	W1800 x H1200mm	£132.20
Y801568**	W2400 x H1200mm	£155.00

** Please specify colour when ordering

C. Light oak effect premium aluminium frame noticeboard

Stunning light oak wood effect aluminium frame with a traditional yet contemporary finish without the maintenance of real wood.

- Attractive contoured frame design
- Available in loop nylon fabric with 17 colour options
- Use with pins or Velcro
- Concealed corner fixings

Y801540**	W900 x H600mm	£44.75
Y801542**	W1200 x H900mm	£64.60
Y801544**	W1200 x H1200mm	£67.20
Y801546**	W1500 x H1200mm	£96.50
Y801548**	W1800 x H1200mm	£106.75
Y801550**	W2400 x H1200mm	£123.65

** Please specify colour when ordering

Tamperproof Noticeboards

A. Standard tamperproof noticeboards

Inexpensive solution to protecting displayed information against casual interference.

- Each door secures with 2 matching lock for convenience
- Surface accepts Velcro® or pins - colour fast to BS1006
- Available in 5 standard felt colours - Blue (BL), Burgundy (BG), Green (GR), Grey (GY) or Red (RD)

Single Door

YLN31**	W450 x H600mm	each	£47.95
YLN32**	W600 x H900mm	each	£57.15
YLN33**	W900 x H900mm	each	£72.05
YLN34**	W1200 x H900mm	each	£79.60
YLN35**	W1200 x H1200mm	each	£106.90

Double Door

YLN36**	W1800 x H1200mm	each	£163.70
YLN37**	W2400 x H1200mm	each	£193.80

** Please specify colour when ordering

B. Light oak effect premium aluminium frame EcoColour® tamperproof noticeboard

Stunning light oak effect aluminium frame with EcoColour® recycled material which is not only fire resistant but also has acoustic properties.

- Fire Resistant to Class 0
- Noticeboard is classified a 'B' according to BS EN13501-1
- Made from recycled material
- Acoustic properties up to NRC 0.8
- Attractive contour frame design
- Available in 11 different colours

Single Door

Y801700**	W600 x H900mm	£131.40
Y801702**	W900 x H1200mm	£174.00
Y801704**	W1200 x H1200mm	£226.00

Double Door

Y801706**	W1800 x H1200mm	£338.55
Y801708**	W2400 x H1200mm	£401.55

** Please specify colour when ordering

C. Light oak effect premium aluminium frame loop nylon tamperproof noticeboard

Stunning light oak wood effect aluminium frame with a traditional yet contemporary finish without the maintenance of real wood.

- Attractive contoured frame design
- Available in standard loop nylon fabric in 17 colours
- Use with pins or Velcro
- Concealed corner fixings
- Matching keys

Single Door

Y801570	W900 x H600mm	£117.55
Y801572	W1200 x H900mm	£163.10
Y801574	W1200 x H1200mm	£184.65

Double Door

Y801576	W1800 x H1200mm	£291.60
Y801578	W2400 x H1200mm	£322.95

** Please specify colour when ordering



Felt colours:

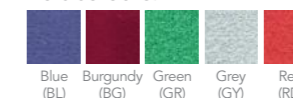

A

Ideal for escape routes/corridors

Acoustic Properties



Fire Resistant



See page 382 for 17 loop nylon colour options



C



A



Please note: these items are made to order



B



Frame colours

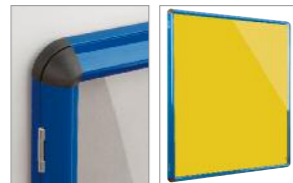

Standard Loop Nylon Range

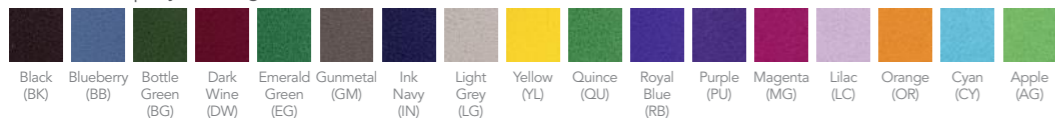

Tamperproof Noticeboards

A. Colourtone vibrant tamperproof noticeboards

- Stunning range of lockable notice boards in 6 colours
- 2 matching locks per door
- Full length glazing bars and quality hinges
- Aluminium frame, with fixings

Single Door

Y31012**	W600 x H900mm	each	£82.35
Y31014**	W900 x H900mm	each	£97.30
Y31016**	W1200 x H900mm	each	£113.50
Y31017A**	W1200 x H1200mm	each	£131.85

Double Door

Y31019A**	W1800 x H1200mm	each	£209.45
Y31021A**	W2400 x H1200mm	each	£238.10

** Please specify colour when ordering

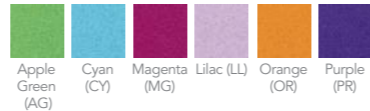

B. Premium tamperproof noticeboard

Contemporary framed lockable noticeboard.

- Contemporary styling with a wide range of frame and cloth colours
- Available in 6 different sizes all with standard loop nylon cloth
- Heavy duty design with 3mm thick PET covers and full length glazing bars
- Key Lock
- No door options are also available - please ask for details

Single Door

		Aluminium Frame	Coloured Frame
Y801260**	W600 x H900mm	£89.60	£130.95
Y801262**	W900 x H900mm	£123.95	£169.30
Y801264**	W900 x H1200mm	£143.45	£192.75
Y801266**	W1200 x H1200mm	£166.15	£226.20

Double Door

Y801268**	W1800 x H1200mm	£254.05	£344.90
Y801270**	W2400 x H1200mm	£286.35	£387.45

** Please specify colour of material and frame when ordering

Interior Showcases

A. Premium interior showcases

The elegantly styled premium Showcase has a top hinged door with support stays and 2 matching locks. Pinnable area is based on multiples of A4 sheets to maximise space utilisation. Standard & Resist-a-Flame versions are available.

- Each unit has two locks with matching keys
- Framework is available in anodised Aluminium (AL) or powder coated in Blue (BL), Red (RD), Green (GR), White (WH), Black (BK) or Light Oak (LO)
- Standard version are available in 12 popular loop nylon colours, accept pins and Velcro®.
- Resist-a-Flame® versions available, fully constructed to meet the latest building and fire regulations
- Tested to the relevant European 'reaction to fire' tests
- Easy to mount with concealed bracket, fixings provided

Standard showcases

YINTL4**	W712 x H570mm (A)	£162.45
YINTP4**	W537 x H750mm (B)	£162.45
YINTL8**	W967 x H750mm (C)	£205.80
YINTP8**	W752 x H1050mm (D)	£210.00
YINTP12**	W1012 x H1050mm (E)	£239.20
YINTP15**	W1182 x H1050mm (F)	£260.30
YINTP18**	W1397 x H1050mm (G)	£287.80

EcoColour® Resist-a-Flame® showcases

Y801580**	W712 x H570mm (A)	£168.40
Y801582**	W537 x H750mm (B)	£168.40
Y801584**	W967 x H750mm (C)	£215.25
Y801586**	W752 x H1050mm (D)	£220.50
Y801588**	W1012 x H1050mm (E)	£249.50
Y801590**	W1182 x H1050mm (F)	£271.85
Y801592**	W1397 x H1050mm (G)	£307.25

** Please specify colour of material and frame when ordering



Light Oak Effect Frame

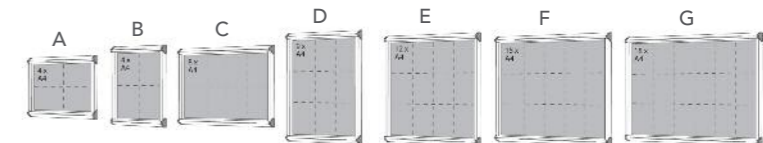

Standard Loop Nylon Range



EcoColour® Resist-a-Flame® Range

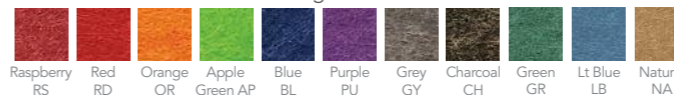

Frame colours



Please note: these items are made to order

A



Resist-a-Flame Woven Cloth Range

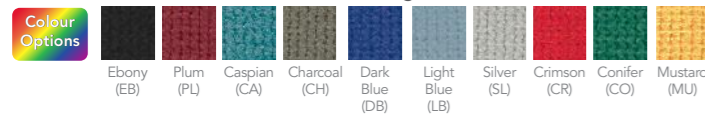

Please note: these items are made to order

B



Acoustic Properties

EcoColour® Resist-a-Flame® Range

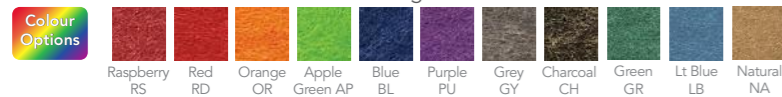

Resist-a-flame® Noticeboards

Market leading range of fire retardant noticeboards fully constructed to meet the latest building and fire regulations, tested to the relevant European 'reaction to fire tests' these products are classified B-SI,dO according to BS-EN 13501-1. Ideal for use in public buildings and commercial applications, and for use in primary fire routes.

A. Aluminium framed fire resistant noticeboards

- Fire retardant noticeboards with aluminium frames
- Fully assembled boards certified to BS EN13501
- Fire retardant woven cloth
- Range of 10 standard colours

Y31020**	W900 x H600mm	each	£42.20
Y31022**	W1200 x H900mm	each	£62.60
Y31024**	W1200 x H1200mm	each	£72.75
Y31025**	W1500 x H1200mm	each	£93.65
Y31026**	W1800 x H1200mm	each	£117.75
Y31028**	W2400 x H1200mm	each	£135.40

**Please specify colour when ordering.



B. Tamperproof EcoColour® fire resistant noticeboards

- Side hinged lockable noticeboards
- Fire Resistant to Class 0
- Noticeboard is classified a 'B' according to BS EN13501-1
- 2 locks per door with matching locks
- Clear covers tested to BS 476 part 7 class 1
- Range of 11 standard colours
- Acoustic properties up to NRC 0.8

Single Door

Y801620**	W600 x H900mm	each	£91.35
Y801624**	W900 x H1200mm	each	£132.90
Y801625**	W1200 x H1200mm	each	£157.60

Double Door

Y801626**	W1800 x H1200mm	each	£230.00
Y801628**	W2400 x H1200mm	each	£279.30

**Please specify colour when ordering.

Resist-a-flame® Noticeboards

A. Top hinged tamperproof EcoColour® fire resistant noticeboards

- Top hinged lockable noticeboards with door supports
- Ultimate choice for use in corridors
- Doors open upwards and kept in place with support stays
- 2 locks per doors with matching keys
- Range of 11 standard colours
- Fire Resistant to Class 0
- Noticeboard is classified a 'B' according to BS EN13501-1

Single Door

Y801630**	W900 x H600mm	each	£112.20
Y801632**	W900 x H900mm	each	£134.70
Y801634**	W900 x H1200mm	each	£145.50
Y801636**	W1200 x H900mm	each	£145.50
Y801638**	W1200 x H1200mm	each	£171.65

Double Door

Y801640**	W1800 x H900mm	each	£266.67
Y801642**	W1800 x H1200mm	each	£288.25
Y801644**	W2400 x H1200mm	each	£340.50

**Please specify colour when ordering.

EcoColour® Resist-a-Flame® Range

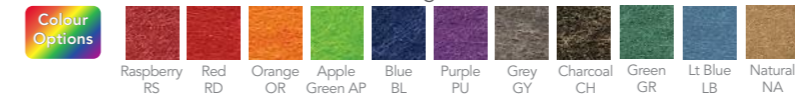

B. Premium sliding door EcoColour® fire resistant showcases

- Sliding lockable door option, ideal for busy corridors
- Doors manufactured from toughened safety glass
- Range of 11 standard colours
- Available in 4 sizes designed to take a given number of A4 sheets
- Framework is available in anodised Aluminium (AL) or powder coated in Blue (BL), Red (RD), Green (GR), White (WH) or Black (BK)

Y801612**	W967 x H750mm	each	£301.50
Y801614**	W1012 x H1050mm	each	£319.30
Y801616**	W1182 x H1050mm	each	£371.20
Y801618**	W1397 x H1050mm	each	£413.35

** Please specify colour of material and frame when ordering

Frame colours



EcoColour® Resist-a-Flame® Range

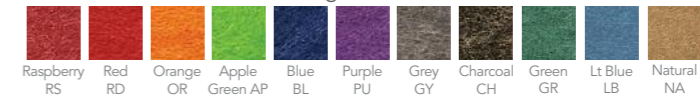

Light Oak Effect Frame

A

B



Please note: these items are made to order

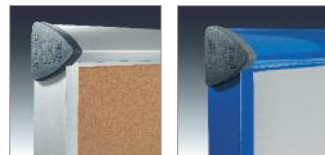

Exterior Showcases

A. Premium post mounted exterior showcases

- Post mounted weatherproof showcase for sinking into concrete or bolting onto a sound base
- Specification as per premium Exterior Showcase, with the addition of powder coated steel backing plate for rear weatherproofing
- Galvanised and powder coated heavy duty steel posts to take single or double sided showcases
- Two post options are available for bolting down, or concreting into the ground
- Finished height of the unit is 2.0m
- Available in four size options, supplied as a single showcase and a pair of applicable posts
- Extra showcase available individually to create a double sided unit
- Please specify frame and infill colours required

Direct delivery 2-3 weeks

Sunken posts

		Takes	
YPMS9**	W752 x H1050mm	9 x A4	£423.10
YPMS12**	W1012 x H1050mm	12 x A4	£465.95
YPMS15**	W1182 x H1050mm	15 x A4	£483.25
YPMS18**	W1397 x H1050mm	18 x A4	£528.20

Bolt down posts

		Takes	
YPMB9**	W752 x H1050mm	9 x A4	£417.25
YPMB12**	W1012 x H1050mm	12 x A4	£463.20
YPMB15**	W1182 x H1050mm	15 x A4	£484.30
YPMB18**	W1397 x H1050mm	18 x A4	£533.20

Extra showcase (without posts)

		Takes	
YEXS9**	W752 x H1050mm	9 x A4	£283.20
YEXS12**	W1012 x H1050mm	12 x A4	£322.55
YEXS15**	W1182 x H1050mm	15 x A4	£365.00
YEXS18**	W1397 x H1050mm	18 x A4	£395.40

** Please specify colour of material and frame when ordering

Light Oak Effect Frame Option



Exterior Showcases

A. Premium exterior showcases

Popular covered noticeboards that are designed to protect your information against the elements. All showcases are truly weatherproof and meet the IP55 requirements of EN60529 for water and dust ingress.

- Wall mounted units have top hinged doors with support stays and two matching locks
- The internal display area is based on displaying multiples of A4 sheets of paper
- Framework is available in anodised Aluminium (AL) or powder coated in Blue (BL), Red (RD) or Green (GR), White (WH), Black (BK) or Light Oak Effect (LO)
- The internal display area is pinnable with a choice of 18 standard loop nylon colours or cork. Whiteboard insert also available on request
- Supplied complete with fixings

YEXTL4**	W712 x H575mm (A)	£162.30
YEXTP4**	W537 x H750mm (B)	£162.30
YEXTL8**	W967 x H750mm (C)	£211.90
YEXTP8**	W752 x H1050mm (D)	£213.85
YEXTP12**	W1012 x H1050mm (E)	£249.45
YEXTP15**	W1182 x H1050mm (F)	£269.25
YEXTP18**	W1397 x H1050mm (G)	£298.90

** Please specify colour of material and frame when ordering

Light Oak Effect Frame Option

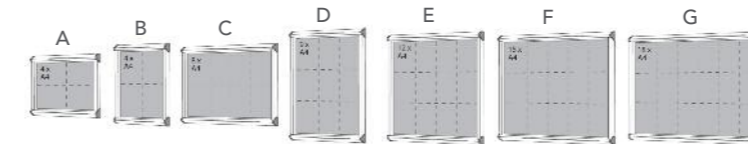

Standard Loop Nylon Range

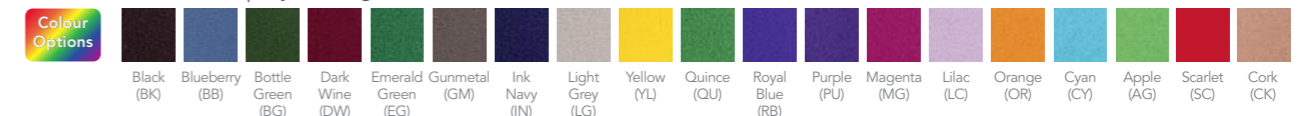

Please note: these items are made to order



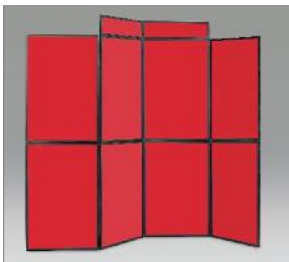
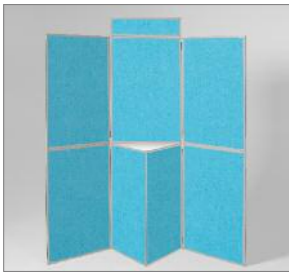
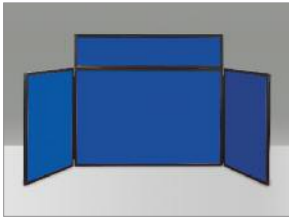
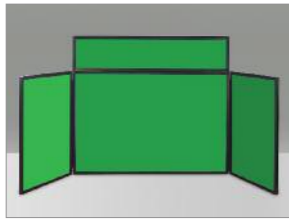

Please note: these items are made to order



Colour Options

Standard colours



Extended colour range - allow an additional 2-3 days for delivery

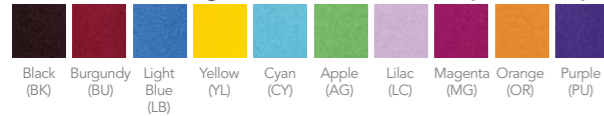

Folding Display Systems

A. Lightweight tabletop displays

- Ideal for presentations and displays, course work or exhibitions and fairs
- Double sided panels fold down to 900 x 600mm.
- All panels are double sided with a choice of loop nylon covering, which accepts Velcro® or Busyfix as well as pins
- Available in landscape or portrait formats
- All come with header panels and carry bags
- 4 standard and 10 extended loop nylon colour options
- Black or grey frame options

Maxi: Portrait All 3 panels 600 x 900mm
Header panel 600 x 200mm

Mini: Landscape centre panel 900 x 600mm
Side panels 450 x 600mm
Header panel 900 x 200mm

YMXT69**	Maxi Table Top	each	£82.25
YEDB3PH**	Mini Table Top	each	£70.80

Lightweight folding display systems

- Features as for the tabletop display system above
- 600 x 900mm panels are linked with flexible hinging, and clip on top of each other for easy assembly

B. Fast fold 6 panel system

- 6 x 600mm x 900mm panels
- 1 x 600mm x 200mm header • Weight: 8kg

YEDB6P**	6 Panel	£153.75
----------	---------	---------

C. Fast fold 7 panel

- 7 x 600mm x 900mm panels, 1 x triangular shelf
- 1 x 600mm x 200mm header • Weight: 13.7kg

YEDB7P**	7 Panel	£191.60
----------	---------	---------

D. Fast fold 8 panel

- 8 x 600mm x 900mm panels
- 2 x 600mm x 200mm headers • Weight: 11kg

YEDB8P**	8 Panel	£197.70
----------	---------	---------

E. Fast fold 10 panel

- 10 x 600mm x 900mm panels
- 2 x 600mm x 200mm headers
- 2 x triangular shelves • Weight: 24kg

YEDB10TP**	10 Panel	£273.65
------------	----------	---------

F. Panel bags

YBAG69B	Budget Bag (Holds 6 Panels)	£44.50
YBAG69S	Standard Bag (Holds 7-8 Panels)	£49.60
YBAG69LG	Large Bag (Holds 10 Panels)	£66.95

** Please specify colour when ordering

Folding Display Systems

Heavy duty system kits

- Buy the complete package - heavy duty system kits which include headers and a carrying bag
- These packages are a convenient and cost effective solution for purchasing a folding display system
- Robust folding panel system with 700 x 1000mm panels, framed with anodised aluminium interlocking gear hinge, which prevents daylight showing between the panels
- Top and bottom panels lock on top of each other for greater security
- Available in 3, 6 or 7 panels with a single header, while the 8 & 10 panel options have 2 headers
- The system is stored in a rugged carry bag
- Double sided panels are covered in a choice of 4 loop nylon colourways which are fire retardant to BS5867
- Accepts Velcro® as well as pins
- Available in 4 standard & 10 extended range colours

YDB3P**	3 Panel with Header	£140.45
YDB6P**	6 Panel with Header	£219.05
YDB7P**	7 Panel with Header	£261.35
YDB8P**	8 Panel with 2 Headers	£291.70
YDB10P**	10 Panel (No Headers)	£337.85

** Please specify colour when ordering



Colour Options

Standard colours



Extended colour range - allow an additional 2-3 days for delivery

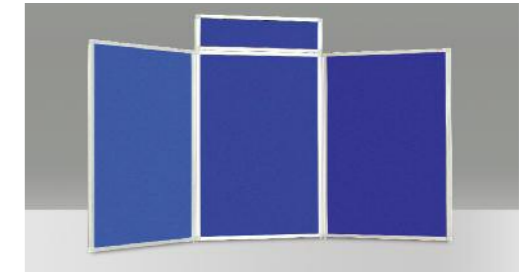



Folding Display Systems

Onboard pole and panel display systems

- A lightweight pole and panel system that due to its modular design enables the user to reconfigure and extend the display system to meet the application
- Standard 600 x 900mm panels can be mounted both portrait or landscape onto the 1800mm high pole, using C clips provided
- The system can be extended at any point in the future by purchasing another kit to link on
- All panels are doublesided with a choice of loop nylon covering, which accepts Velcro or Busyfix as well as pins
- Header panels have loop nylon fabric on one side and black on reverse
- Available in 4 standard colours & 10 extended range colours

A. 6 panel kit – 9.5kg

YPPDB6H**	6 – 600 x 900mm Display Panels		
	1 – 900 x 200mm Header	each	£208.15
YPBAG6	Panel Bag - 6 Panel	each	£44.50

B. 6 panel kit – 9kg

YPPDB6**	6 – 600 x 900mm Panels	each	£199.00
YPBAG6	Panel Bag - 6 Panel	each	£44.50

C. 7 panel kit – 10kg

YPPDB7H**	7 – 600 x 900mm Display Panels		
	1 – Triangular Shelf	each	£244.60
YPBAG78	Panel Bag - 7-8 Panel	each	£49.60

D. 8 panel kit – 10.5kg

YPPDB8**	8 – 600 x 900mm Panels	each	£252.05
YPBAG78	Panel Bag - 7-8 Panel	each	£49.60

E. 10 panel kit – 14.5kg

YPPDB10**	10 – 600 x 900mm Panels	each	£320.90
YPBAG10	Panel Bag - 10 Panel	each	£66.95

F. Accessories

YHEAD62**	Header Panel 200 x 600mm	each	£24.90
YHEAD92**	Header Panel 200 x 900mm	each	£26.35
YPNL96**	Extra Panel 600 x 900mm	each	£29.50
YPOLESET	Pole Set Black	set	£24.00

** Please specify colour when ordering these products

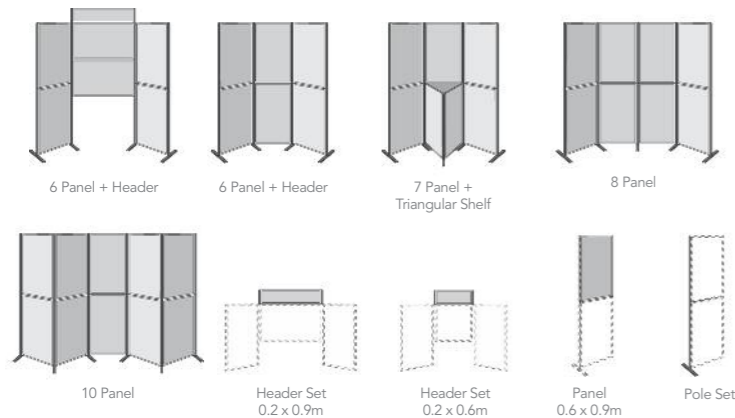

Standard colours



Extended colour range - allow an additional 2-3 days for delivery



Concertina Mobile Room Dividers

- Ideal for temporary room divisions
- Double sided and available in 3 heights and 4 panel configurations (each panel is 560mm wide)
- A wide range of colours in velcro friendly Nylon loop
- Also available in elegant wool mix fabric
- Each panel comes with two lockable castors and folds neatly for easy storage
- Delivery 5-7 working days

Code	Description	Height	Price
YCD124**	4 Panel	1200mm	£364.00
YCD125**	5 Panel	1200mm	£434.00
YCD127**	7 Panel	1200mm	£572.00
YCD129**	9 Panel	1200mm	£792.00
YCD154**	4 Panel	1500mm	£378.80
YCD155**	5 Panel	1500mm	£448.00
YCD157**	7 Panel	1500mm	£601.70
YCD159**	9 Panel	1500mm	£820.00

YCD184**	4 Panel	1800mm	£392.00
YCD185**	5 Panel	1800mm	£480.00
YCD187**	7 Panel	1800mm	£624.00
YCD189**	9 Panel	1800mm	£862.00

** Please specify colour when ordering

Best Seller



Please note: for safety reasons the room dividers cannot be used flat and must be angled for stability purposes. Using zig-zag configuration, it is recommended that 2 panels = 1 metre

Available colours

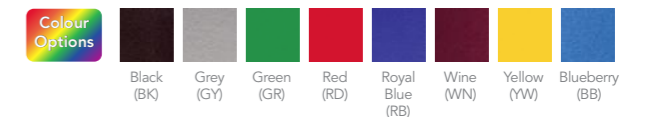

A



Available in:



B



Available in:



C



Available in:



Literature Display

A. Visual wall mounted literature display

Ever popular, colourful leaflet dispensers

- Curved, colourful, moulded body
- Concealed wall fixings
- 6 different sizes to suit a variety of leaflet sizes
- Available in 10 different colours

Y800500**	3 x A4	W267 x H521mm	£38.55
Y800510**	6 x A4	W502 x H521mm	£54.35
Y800520**	4 x A5	W184 x H521mm	£36.15
Y800530**	8 x A5	W352 x H521mm	£53.45
Y800540**	4 x 1/3 A4	W134 x H521mm	£39.80
Y800550**	8 x 1/3 A4	W255 x H521mm	£51.10

** Please specify colour when ordering

B. 4-sided revolving literature dispenser

- Clear acrylic pockets
- Chrome central column
- W560 x D560 x H1690mm
- 3 different options available in 4 different colours
- Also available in Orange, Lime or Lilac - please enquire for pricing

Y800600**	12 x A4	£350.60
Y800610**	16 x A5	£345.80
Y800620**	32 x 1/3 A4	£362.65

** Please specify colour when ordering

C. Curve free standing literature display

- Stylish literature dispenser with sturdy steel frame
- Two widths available - single A4 or double A4 side by side
- Header panel for personalisation
- Supplied with set of 4 optional castors for mobility
- Simple self assembly required
- D310 x H1430mm
- Available in 3 colours

Y800300**	Single A4 Per Shelf	W350mm	£71.00
Y800350**	Double A4 Per Shelf	W500mm	£86.80

** Please specify colour when ordering

Poster Frames

A. Aluminium poster frames

- Budget poster frame
- Frame snaps open and shut to change the poster
- Satin anodised aluminium frame
- Anti-glare uv resistant cover
- Internal use
- For quantities of more than 10, please ask for prices

Y31005	A4 W210 x H297mm	£13.00
Y31007	A3 W297 x H420mm	£15.00
Y31009	A2 W420 x H594mm	£20.00
Y31011	A1 W594 x H840mm	£26.50
Y31013	A0 W840 x H1189mm	£43.00
Y31015	B2 W500 x H700mm	£35.20
Y31017	B1 W700 x H1000mm	£47.50



B. Coloured poster frames

- Brightly coloured aluminium frame
- Frame snaps open and shut to change the poster
- Available in 5 striking colours
- Internal use

Y800200**	A4 W210 x H297mm	£16.50
Y800210**	A3 W297 x H420mm	£20.25
Y800220**	A2 W420 x H594mm	£29.45
Y800230**	A1 W594 x H840mm	£39.60
Y800240**	A0 W840 x H1189mm	£64.80
Y800250**	B2 W500 x H700mm	£37.50
Y800260**	B1 W700 x H1000mm	£57.60

** Please specify colour when ordering

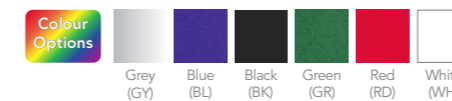

C. External tamperproof poster frames

New snap frame design is fitted with a weather-proof seal preventing water damage. The special frame profile and higher strength springs prevent casual tampering as a unique tool is required to open the frame.

- Weatherproof and tamperproof design
- Supplied with opening tool
- Ultraviolet protective film prevents fading

YEPF1000	A4 W210 x H297mm	each	£34.60
YEPF1001	A3 W297 x H420mm	each	£40.15
YEPF1002	A2 W420 x H594mm	each	£49.35
YEPF1003	A1 W594 x H840mm	each	£65.65
YEPF1004	A0 W840 x H1189mm	each	£106.40
YEPF1005	B2 W500 x H700mm	each	£55.85
YEPF1006	B1 W700 x H1000mm	each	£80.25



A

B

C



Please note: these items are made to order

Premium glazed display cases

A stylish range of display cases manufactured to the highest standard. Heavy duty yet contemporary aluminium framing, and toughened safety glass are used to create this range of wall and freestanding showcases.

Six tower units are available in a range of sizes, two with locking cupboards to the base. Wall mounted cabinets are available in a choice of two popular sizes. All units are lockable and supplied with glass shelving as illustrated.

Available in satin anodised aluminium or in a choice of four bright powder coat colours. Supplied ready assembled with castors, button feet are available at no extra cost – please specify when ordering.

Illuminated versions of the premium glazed display cases brings your display to life. Spotlights are clipped into a 12 volt track, enabling the illumination to be positioned exactly where you need it. The lights are simple to remove when not required or when sensitive displays are being housed.

TO ORDER: Please state the product code followed by the frame colour code required.

EXAMPLE: Wall cabinet unit 900 x 1200 x 200mm with white frame = YWC912WH

Frame Colours

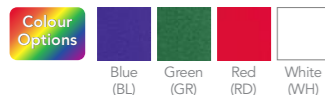

A. Wall cabinet

Size H900 x W1200 x D200mm

YWC912AL	Aluminium	£817.00
YWC912**	Coloured	£952.00

Illuminated

YLWC912AL	Aluminium	£1153.00
YLWC912**	Coloured	£1348.00

** Please specify colour when ordering



C. Wall cabinet

Size H1000 x W1000 x D200mm

YWC112AL	Aluminium	£784.00
YWC112**	Coloured	£918.00

Illuminated

YLWC112AL	Aluminium	£1120.00
YLWC112**	Coloured	£1254.00

** Please specify colour when ordering



B. Tower unit

Size H2000 x W600 x D600mm

YTU266AL	Aluminium	£1097.00
YTU266**	Coloured	£1232.00

Illuminated

YLTU266AL	Aluminium	£1433.00
YLTU266**	Coloured	£1612.00

** Please specify colour when ordering



D. Tower unit

Size H2000 x W500 x D500mm

YTU255AL	Aluminium	£940.00
YTU255**	Coloured	£1120.00

Illuminated

YLTU255AL	Aluminium	£1276.00
YLTU255**	Coloured	£1456.00

** Please specify colour when ordering



Please note: these items are made to order

A. Wide tower

Size H2000 x W1200 x D600mm

YWT216AL	Aluminium	£1556.00
YWT216**	Coloured	£1780.00

Illuminated

YLWT216AL	Aluminium	£1892.00
YLWT216**	Coloured	£2116.00

** Please specify colour when ordering



C. Wide tower

Size H2000 x W1000 x D500mm

YWT215AL	Aluminium	£1489.00
YWT215**	Coloured	£1713.00

Illuminated

YLWT215AL	Aluminium	£1825.00
YLWT215**	Coloured	£2049.00

** Please specify colour when ordering



B. Tower with cupboard

Size H2000 x W1200 x D600mm

YTC216AL	Aluminium	£1624.00
YTC216**	Coloured	£1848.00

Illuminated

YLTC216AL	Aluminium	£1960.00
YLTC216**	Coloured	£2184.00

** Please specify colour when ordering

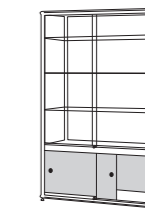

D. Tower with cupboard

Size H2000 x W1000 x D500mm

YTC215AL	Aluminium	£1512.00
YTC215**	Coloured	£1736.00

Illuminated

YLTC215AL	Aluminium	£1848.00
YLTC215**	Coloured	£2072.00

** Please specify colour when ordering

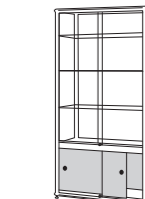

A



Please note: these items are made to order

B



Colour Options

C



Lecterns

A. Panel front lectern

Practical mobile lectern

- Popular mobile lectern finished in beech look panelling and grey steel framework
- Upper shelf angled with book rest to aid presentation, together with lower accessory shelf
- Lectern mounted on four castors two of which are locking

	(H)	(W)	(D)		
YPFLECT	1200	x 600	x 450mm	each	£200.00

B. Coloured panel front lecterns

- A colourful addition to the popular beech version
- New contemporary range of 7 colours
- Dark grey steel framework

Y31019	Orange	each	£225.90
Y31021	Blue	each	£225.90
Y31023	Lime Green	each	£225.90
Y31030	Grey	each	£225.90
Y31027	Black	each	£225.90
Y31029	Red	each	£225.90
Y31031	White	each	£225.90

Page Link - see page

Colorado Wood Finishes... 327



C. Colorado mobile lectern

- Lockable cupboard
- W600 x D600 x H1350mm
- Available in 12 different finishes - see page 321

Y800900	Colorado Lectern	£442.00
---------	------------------	---------

AV Cabinets

A. Multi-media projector cabinet

- Economical multi-media cabinet
- House all your multi-media equipment and accessories in this secure locking mobile cabinet
- Three shelves, two fixed and one sliding for the projector
- Cable access port to top and side for easy connectivity
- Finished in beech with ABS edging
- Size: H930 x W540 x D600mm

YMMPCBH	Multi-Media Projector Cabinet, Beech	£217.90
---------	--------------------------------------	---------

B. Premium multi-media projector cabinet

- Premier mobile multi-media cabinet
- Market leading cabinet with extra security and features
- Designed to house all multi-media projection equipment.
- Three point lock for added security.
- Contoured rounded edging to top and base panels
- Rear hinged panel for easy access to cabling.
- Additional cable ports and cable tidy
- Accessory storage tray to inside of door
- Size: H930 x W540 x D600mm

YSCMPBH	Premium Multi-Media Projector Cabinet, Beech	£276.05
---------	--	---------

Please note: these items are made to order

C. Premium coloured mobile multi-media cabinets

- The premium cabinet has now been developed in a range of 7 striking colours
- Premier coloured secure projector cabinets designed to house all multi-media projection equipment
- Rear lockable access door
- 4 shelves, 3 of which slide
- Ready assembled in 7 colours
- Size H930 x W524 x D570mm

Y31033	Red	£319.55
Y31036	Grey	£319.55
Y31037	Orange	£319.55
Y31039	Blue	£319.55
Y31041	Lime Green	£319.55
Y31043	Black	£319.55
Y31045	White	£319.55

A



B



C



Colour Options



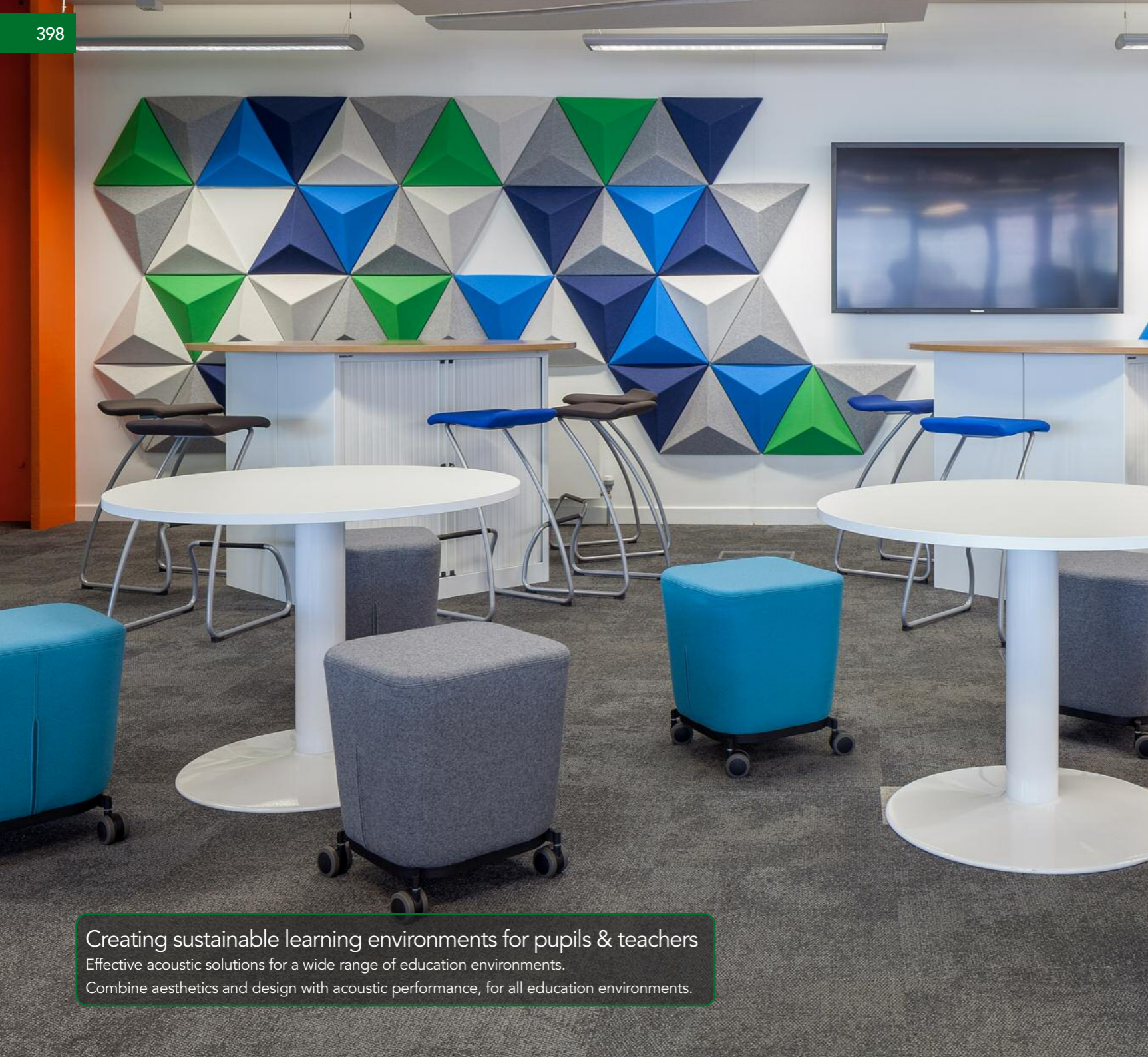

Creating sustainable learning environments for pupils & teachers
 Effective acoustic solutions for a wide range of education environments.
 Combine aesthetics and design with acoustic performance, for all education environments.

Acoustic Surfaces

HushBoard
 HushPanel

400-401
 402-403

Acoustic Surfaces





Hushboard Acoustic Surface

HushBoard is a superb decorative wall covering, specifically developed to enhance the educational environment. Its felt surface transforms noisy interiors as well as creating a colourful, highly durable and exciting surrounding.

- Perfect for use in schools, colleges and nurseries
- Improves teaching and learning by absorbing excess classroom noise
- Acoustic rating of NRC 0.40 is proven to reduce noise levels by 40%
- Pin, staple and velcro friendly, perfect for displays!
- Highly durable, resistant to staining and easily cleaned
- Saves the time and expense of recovering traditional wall boards
- Large range of 35 eye-catching, non fade colours
- Professional fitting service available for your own imaginative designs
- Recommended for a minimum 8 year cycle
- Fire retardant
- Call today for a sound survey and free quotation



Page Link - see pages
For acoustic noticeboards 378-380

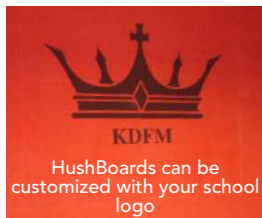

Pin, staple & Velcro friendly

HushBoard Acoustic Surface

Transform your environment and comply with acoustic directives.

Colour Options

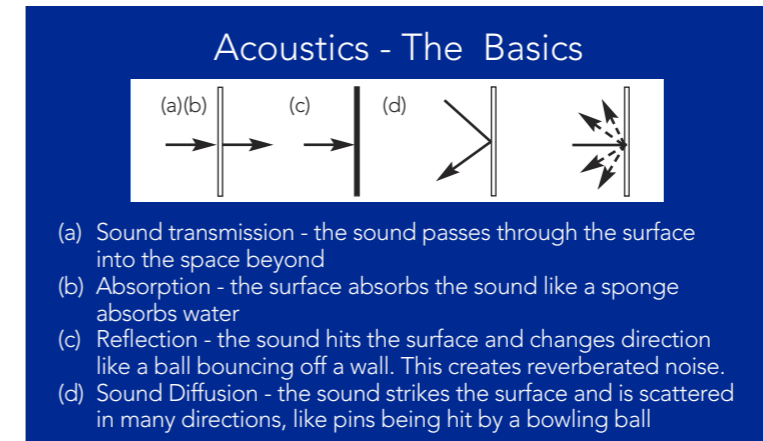

Statistics have shown that 25% of children cannot hear properly in the classroom which can result in learning difficulties. Install hushboard and boost their learning performance.

Call for a FREE sample swatch for accurate colour selection

Other products from the Hush range

Colours may vary



HushBlox
Stackable acoustic blocks allowing you to configure your learning space any way you want



HushTree
Large room divider providing acoustic properties with a fun and aesthetically pleasing design



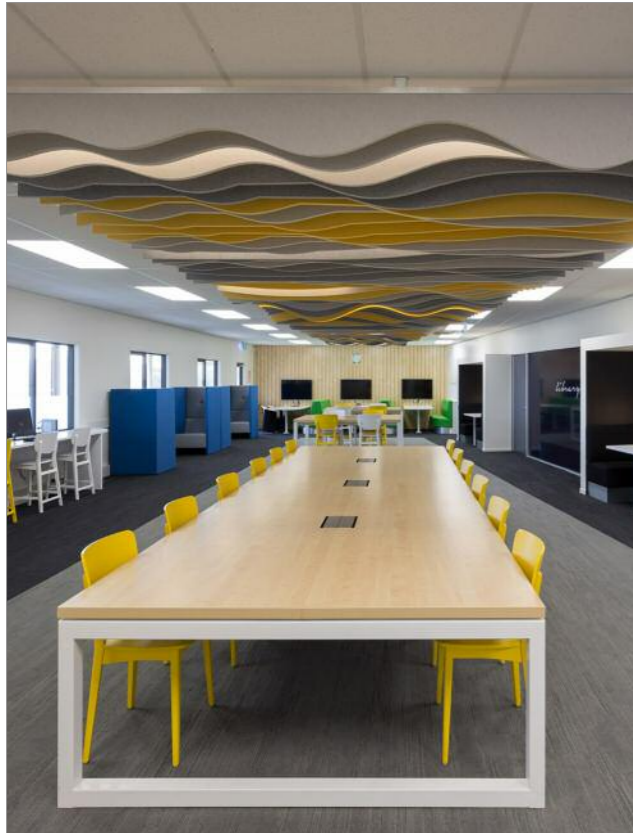

Page Link - see page

Stax
seating
range shown

178



HushPanel

HushPanel is an innovative 25mm or 50mm thick acoustic panel, that is engineered to provide superior sound absorption with balanced acoustic design. Ideal for wall and ceiling applications, HushPanel is unique in it's availability to be supplied as either a pre-finished panel covered with HushTex acoustic fabric, plain format or custom printed with any image, colour or pattern giving you the flexibility and freedom to create your own designs.

HushPanel Acoustic Surface

- Perfect for classrooms, corridors, theatres, communal areas and gymnasiums
- HushPanel transforms noisy interiors to quieter working areas whilst creating colourful and exciting surroundings
- HushPanels are flame retardant, semi rigid, impact resistant, and incredibly durable
- The panels are supplied in sheet form that can be cut and framed onsite, allowing for variations in wall size and shape
- They can also be supplied as custom cut and shaped for increased design flexibility
- This quality product fully answers to the criteria needed for BB93 Noise Level Compliance
- Frames and edge finishing kits are available allowing greater flexibility for constructing large wall areas or unique modular panels

Please contact us for further details
and a full technical specification.

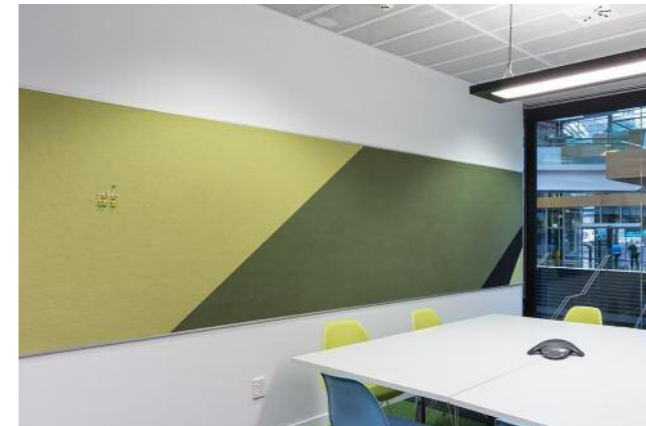

A wide range of standard colours are available as well as bespoke colours and designs. Please enquire for details.

HushPanel
'eats up echo'





Is your playground the Great Outdoors?

Our outside equipment, canopies and seating add that special combination of practicality and fun for all ages.

Outdoor Furniture

A-Frame Benches	406
Circular Tables	407
Outback Benches	408
Multicoloured Seat & Bench	409
Bespoke Curved Benches	410
Cotswold Range	411
Learning Curve	412
Stone Effect Furniture	413
Lockers, Cycle lockers	414
Bins	415-417
Bike Racks	417
Canopies & Steel Shelters	418-420
Cycle Shelters	421

Outdoor Furniture

We can help you to create fun and pleasant outdoor areas for children and adults alike.

Whether you are looking for some outdoor benching for the teachers to enjoy or a climbing frame for the children, we would love to hear from you.

Take some time to peruse the products and pictures in this Outdoor section and don't hesitate to contact us to discuss your requirements and find out what we can do for you.





A



A. Outback a-frame table

Made of recycled plastic, and fully recyclable, these environmentally friendly A-Frames are totally weather proof and virtually maintenance free. To prevent "sag" in the seats - as is common with some plastic furniture - they have galvanized steel re-inforcing which we fit as an integral component during manufacture. Also available in other colours to order at extra cost (black, green, grey, light brown).

- Recycled Plastic – and fully recyclable
- Virtually maintenance free and very environmentally friendly
- Totally weather proof with galvanized steel reinforcing
- Built to seat 6 persons
- Size: Overall base L1800 x W1300mm; seat height 450mm, table height 755mm; table width 620mm

YW0032 Outback A-Frame Table £717.60



B



B. Outback bench

Made of recycled plastic, and fully recyclable, these environmentally friendly benches are totally weather proof and virtually maintenance free. To prevent "sag" in the seats - as is common with some plastic furniture - they have galvanized steel re-inforcing fitted as an integral component during manufacture. Also available in other colours to order at extra cost (black, green, grey, light brown).

- Recycled Plastic – and fully recyclable
- Virtually maintenance free & very environmentally friendly
- Totally weather proof
- Galvanized Steel Reinforcing
- Built to seat 4 persons
- Size: L1800 x D670 x Seat Height 450mm, back height 770mm

YW9964 Outback Bench £597.60

C



C. Standard 6 seater a-frame table

These tables stand the rigorous demands of outdoor use. This traditional design has strength and quality as standard. The table is 1500mm long, and is manufactured using 34mm x 121mm timbers. They are immersed in white spirit based treatment for 3 minutes, which gives them their brown colour.

- Extremely strong design with a substantial construction
- Full immersion spirit treatment
- Timber from managed forestry resources
- Provision for optional parasol & base (extra)
- Re-treatment kits available
- Size: Overall base L1500 x W1270mm; seat height 450mm, table height 760mm; table width 625mm

YW0501 Standard 6 Seater A-Frame Table £238.68

A. Circular 8 seater table

Designed for commercial use and built to last; from the double thickness tops to the 46mm x 196mm thick leg the durability is well balanced with user friendliness. These versatile heavy duty outdoor round picnic tables stand up to the rigors and heavy demands that you would expect.

- Built to take 8 persons – a real workhorse
- Free, clear leg room
- Most popular model in the circular tables range
- 1.2m diameter table top (approx)
- Full spirit immersion treatment throughout
- Provision for optional parasol and base (extra)
- FSC® Certified
- Table diameter 1200 x H740mm
- Seats W850 x H440mm
- Overall outer dimensions 1200 x 1935mm

YC8ST Circular 8 Seater Table £477.60



B. Circular 6 seater table

Designed for commercial use and built to last; from the double thickness tops to the 46mm x 196mm thick leg the durability is well balanced with user friendliness. These versatile heavy duty outdoor round picnic tables stand up to the rigors and heavy demands that you would expect. The circular 6 seater is ideal for anyone less able, with wheelchair access for 3 wheelchairs.

- Easy access / egress seating
- Room for up to 3 wheelchairs
- Could help with your DDA programme
- Built to take 6 or 9 persons
- Table diameter 1200 x H740mm
- Seats W850 x W440mm
- Overall outer dimensions 2050 x 1820mm
- Optional parasol and base available at extra cost - POA

YC6ST Circular 6 Seater Table £454.80



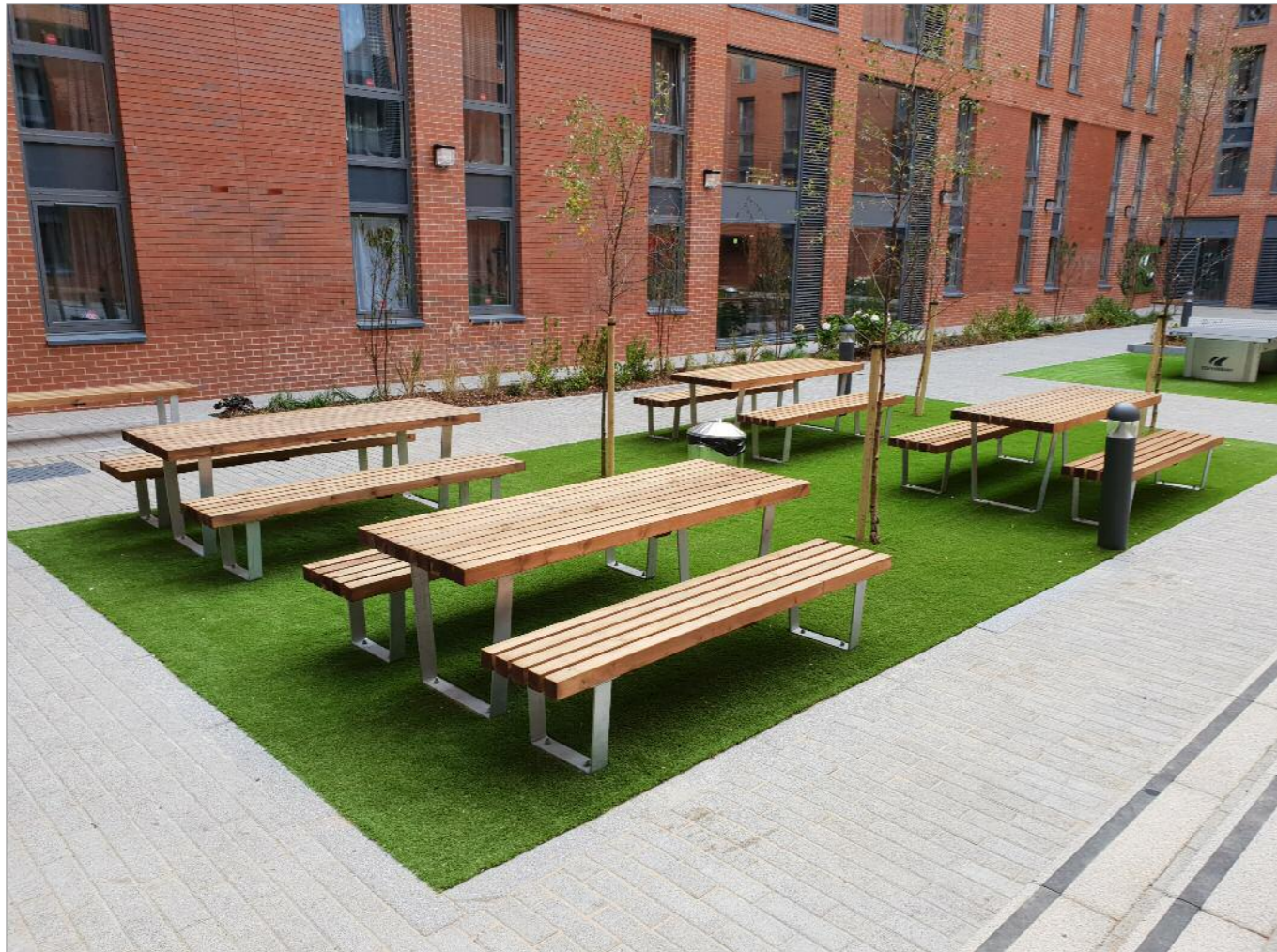

New
Product

Tamworth Table & Benching Sets

- Contemporary style table and bench sets to add character to your outdoor areas
- Made from chunky treated redwood timbers with thick steel frames
- FSC certified, with 10 year structural guarantee
- Vandal resistant - ideal for exposed locations where furniture needs to be strong enough for multi use
- Can be ground fixed for additional security

Y860104	1.8 m Table	each	£535.00
Y860102	1.8m Bench	each	£390.00
Y860100	Table & 2 Benches	set	£1280.00

A. Multicoloured seat

- Ready assembled
- Ground-fixing bolts
- Vandal-resistant
- Hygienic - easy-to-clean
- Environmentally friendly, made from recyclable plastic



YCPS2	2 Seater	H840 x L1350 x D620mm	£393.60
YCPS3	3 Seater	H840 x L1850 x D620mm	£423.60
YCPS4	4 Seater	H840 x L2050 x D620mm	£457.20

Page Link - see page
For
round
bins...  415



A

B. Clarendon teak bench

- High quality solid Teak finished to a high specification
- Engraving available - please ask for details

YCB12	1200mm	£468.30
YCB15	1500mm	£494.55
YCB18	1800mm	£565.95



B



Bespoke Curved Benches

A. Oxford benches

The Oxford range consists of highly versatile cross-slatted backless benches with galvanised steel frames. Available in any length, layout or radius, they are ideal for schools and public areas. They are available in a range of materials, and can include arm rests if required.

A highly cost-effective option. The steel legs and framework support seat planks which are fixed from underneath so no fixings show on the surface. Either softwood or hardwood can be used. Popular sizes are 1.8m or 2.0m and a common radius is 3.0m. Options of either bolt-down or root fix to suit most surfaces - we work to your design specification.

- Contemporary Design
- Design your own – or we can help
- Popular sizes: 1.5m or 1.8m at 3.0m radius
- Bolt down or root fix
- FSC® Certified woods

Choose from Softwood, Hardwood or Recycled Plastic options. Please ask for further details.

Please ask our consultants for advice and a free quote without obligation.

B. Curvex range - slim curved

The Curvex Range is a very simple, yet attractive and tasteful design. Being solid, they are very strong and sturdy and can take the toughest wear and tear that public areas can demand. Most popular in hardwood, they can also be supplied in softwood if required. Common sizes are 1.5m or 1.8m long at a radius of 3.0m but a variety of lengths and radii are available. These benches can be supplied as either root fix (extra long leg that is buried into the ground) or bolt-down with strong steel brackets.

- Extremely strong and sturdy
- Simple, tasteful design
- Hardwood or Softwood
- Popular sizes: 1.5m or 1.8m at 3.0m radius
- Can be a variety of lengths and radii
- Bolt down or root fix
- FSC® Certified

Choose from Softwood or Hardwood options. Please ask for further details.

Cotswold Concrete & Wood Range

- Cast steel-reinforced concrete ends provide excellent stability
- Sturdy and robust; these benches offer an ideal solution for playgrounds and public areas
- All prices include delivery

A. Bench (no back)

YS00033 L1830 x W610 x H500mm £433.95

B. Park bench - with back

YS00020 L1830 x W835 x 430mm Seat Height £526.41

C. Rectangle picnic table wheelchair access

- Extended table top L2430 x W710mm

YS00014 Rectangle Wheelchair Access £655.60

D. Rectangle picnic table 8 seater

- Table: 1825 x 710mm, Seat height 450mm

YS00001 Rectangle 8 Seater £642.40

E. Round picnic table

- 1310mm diameter, 2000mm overall width
- Seats 8 adults comfortably

YS00021 Round Table £832.15





A. Learning curve

- Seat Height: 380mm
- Length of each seat: 800mm
- Overall diameter: 2600mm
- Maintenance free and easy to clean
- Ground fixing supplied
- Recycled and recyclable plastic
- Simple self assembly is required

YLC1	2600mm Diameter	£568.80
------	-----------------	---------

Page Link - see pages
For
Outdoor
Lockers

137



Item shown YLC1. Please ask for details of other options in this range.



Call now
for a free
quotation

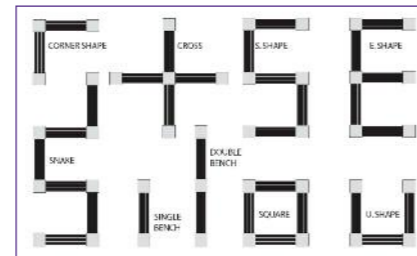

*Your imagination!
Your creation!
Flexible seating, with flat
tops or planter boxes.*



Other configurations available - please ask for details

Stone Effect Tables And Seating

- Highly popular maintenance free
- Ready assembled
- Available in stone colours only
- Vandal resistant
- Made from recycled and recyclable plastic



A

A. Premier bench without backs

YPB3	3 Seater	H410 x L1850 x D560mm	£346.80
YPB4	4 Seater	H410 x L2050 x D560mm	£359.76



B

B. Table set

- Table and 2 benches

YPTB6	6 Seater	L1850mm	£877.80
YPTB8	8 Seater	L2050mm	£963.60



C

C. Premier seats with backs

YPS3	3 Seater	H840 x L1850 x D620mm	£406.80
YPS4	4 Seater	H840 x L2050 x D620mm	£429.60



Plain colours



Stone effect colours

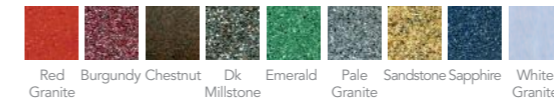

Page Link - see page
For
round
bins...

415



New Product

A



Page Link - see pages
For more
Outdoor
Lockers

137



A. Outdoor multi-purpose storage lockers

- These outdoor lockers are ideal for storage of outside items such as sports and training equipment, cricket and hockey bags, tool boxes, musical instruments and many other large items that clutter corridors and indoor rooms
- Hard wearing recycled polyethylene which is weather and vandal resistant
- Each locker can be supplied with either a padlock or integral keyed handle – Please state when ordering
- Lockers can be stacked and nested together to create a configuration that suits your space
- Wide range of Body colours available
- Available in two sizes – See below

Large Locker

YLMPL-P W550 x D700 x H550mm each £196.80

Extra Deep Large Locker

YJMPL-P W550 x D1250 x H550mm each £229.60

B. Cycle lockers

- These Outdoor Cycle Lockers are designed to hold most styles and shapes of bike
- A secure & environmentally friendly facility that can be used in car parks, Colleges, Stations, Leisure sites etc.
- Heavy Duty units made from recyclable weatherproof plastic
- Built-in floor with drainage holes for low maintenance and easy cleaning
- Comes with ground fixing bolts for hard surfaces
- Internal Storage hooks & ground fixing for securing bikes
- Comes with padlock and key
- Multiple lockers can be positioned together to form a range of layouts to suit your space –see diagram
- W960 x D1650 x H1250mm

YBBCL01 Single Unit £597.00

Colour Options

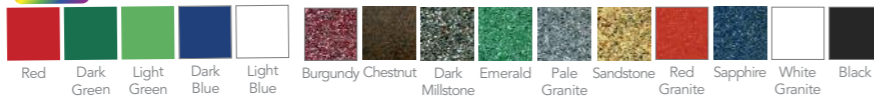

New Product

B



C

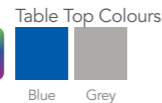

Colour Options

Table Top Colours
Blue Grey

C. Proline outdoor table tennis table

- A static & very sturdy outdoor table; ideal for playgrounds
- A hard, dense playing surface meets ITTF bounce standards and patented MATTOP® finish provides an antiglare finish and proper ball adherence
- 60mm structural galvanised steel frame
- 7mm resin laminate top
- Complete with a permanent tamperproof steel net
- 4 side slots storing table tennis bats
- Available with a Blue or Grey top

YTT1050OD £889.00

A. Classic bins

- Can be printed - please ask for details
- Polyethylene outer shell
- Galvanised steel liner
- Lock and Key
- Weighted base
- Easy to clean
- Size: H1130 x 520mm diameter
- 90 litre capacity
- Available in all colours, stone colours shown in picture

YCLB Classic Bin Standard Design £207.90

Plain colours

Colour Options

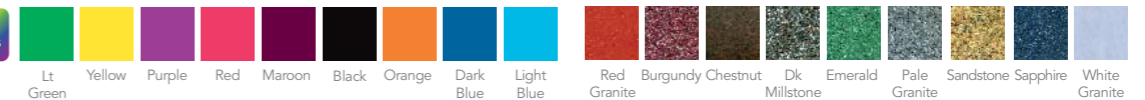

Stone effect colours



B. Manor litter bin with lid

- The removable, 40 litre, galvanised steel liners have a carry handle and are suitable for black plastic bin liners. These litter bins can be ground fixed through fixing holes in the feet - this comes as standard.
- Keep your property tidy with these smart litter bins!
- 40 litre, removable, galvanised liner
- Liner suitable for black plastic bin liners
- Matching removable lid
- Steel frame - can be fixed to the ground
- Size: H930 x W420mm

YW0189 Manor Litter Bin with Lid £261.80

C. Park litter bin

- The removable, 40 litre, galvanised steel liners have a carry handle and are suitable for black plastic bin liners. These litter bins can be ground fixed through fixing holes in the feet - this comes as standard.
- 40 litre, removable, galvanised liner
- Liner suitable for black plastic bin liners
- Steel frame - can be fixed to the ground
- Size: H750 x W410mm

YW0226 Wooden £240.90

YW0226BC Bright Colours £340.90

D. Grit bins

Our roadside standard grit bins are perfect for helping you to keep your paths and driveways ice free.

- **Standard Grit Bin:** H710mm x W840mm x D500mm, capacity: 200 litres
- **Large Grit Bin:** H920mm x W1050mm x D670mm, capacity: 400 litres

YBBGBS Standard each £185.90

YBBGBL Large each £217.00



B



C



Carriage may be charged on small orders, please enquire. More styles available - please ask for details.

D



A



A. Wall/post mounted bin

- Lock and key
- Wall or post mounting
- Polyethylene bodyshell
- Internal galvanised steel liner
- Environmentally friendly - made from recyclable plastic
- Wall fixing bolts supplied
- Hygienic, easy to clean
- Size H675 x W440 x D310mm
- Capacity 26L



YMPW £196.90

Colour Options



B. Strongbox recycling bin system - set of 4

- Polyethylene bodyshell
- Galvanised steel liner
- Pivoting bin for ease of emptying
- Hygienic - easy to clean
- Environmentally friendly - recyclable plastic
- Can be wall mounted
- Size: H920 x D400 x W510mm
- Capacity 39 litres

YRVP £977.90

Colour Options

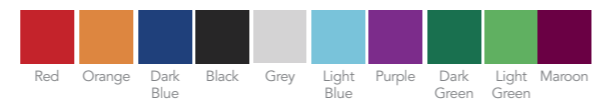

C. Tuftec litter bin

- Outdoor Heavy Duty 100L Tub Bin
- Contoured design with a wide base which allows for maximum capacity and stability
- 2 Piece design – lift off cover with an inner metal liner
- Concrete or soil fixings also available – POA
- Black finish
- Dimensions: H1030 x D540mm

YTTB100 £128.00



B



C

A



A. Mushroom litter bins

- 90L capacity mushroom shaped bin
- Polyethylene bodyshell
- Galvanised steel liner
- Hygienic, easy to clean
- Made from recyclable plastic
- Supplied with a lock & key (use key to unlock and access liner bin)
- Available with or without printed spots
- Comes in 9 bright colours: Light Green, Yellow, Purple, Dark Blue, Light Blue, Orange, Maroon, Black and Red
- Size: H900 x D720mm

YMUL01 Without Spots £273.90

YMULS01 With Spots £281.60

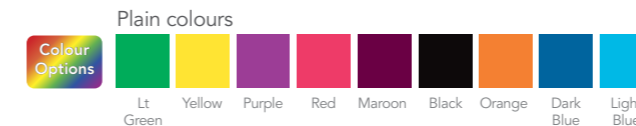

B. Pencil bins

- Polyethylene outer shell
- Galvanised steel liner
- Lock and Key
- Available in all plain colours

YPMIC Micro; H1040, 390 dia. 42 Litre £226.80

YPMID Midi; H1200, 390 dia. 52 Litre £220.80

YPMICL Pencil Bin with 'Litter' Letters, 42 Litre £235.20

YPMIDL Pencil Bin with 'Litter' Letters 52 Litre £236.40

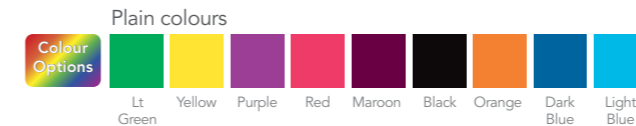

B

C



C. Wall mounted cycle holders

- Made from Heavy Duty Galvanised Steel
- Available with 90° or 45° angle to the wall

YSPR11 Cycle Holder POA

D. Cycle toast rack

- 4m wide
- Made from Heavy Duty Galvanised Steel, comes flanged for bolting down only

YSPTR05 Galvanised For 10 Cycles POA



D

Shelter & Shade

Outdoor Canopies & Shelters designed to suit your space

Adding a covered area to a school's outdoor space is a cost effective and fun way to immediately maximise the efficiency of the available space. It's now possible to learn and play outside in all weathers, while creating a focal point for the playground. Opt for natural, tactile timber or sturdy, low maintenance aluminium to enhance the school. A comfortable outdoor space also encourages more outdoor learning, which is proven to positively impact a child's social, emotional and physical wellbeing.

These products have been trusted by schools for years for safety, quality, durability, and great aesthetics. On offer is a comprehensive range of outdoor shelters to suit every budget and environment – whether you're looking for bike storage, a cost effective playground shelter or an all weather outdoor learning area, there is something to suit your budget and available space.

A. Timber cycle shelter and store

Includes Installation – POA

A sustainable shelter that also makes a serious statement. Not only bikes, but also bins and waiting parents can shelter here. Constructed with high quality, sustainably sourced timber anchored by steel posts, this shelter will fit in anywhere while adding a natural and multifunctional dimension to your outdoor space.



We offer a Complete Bespoke service to meet your specific requirements.
Please ask for Details
Prices are subject to a site survey and quotation.

Lux

Combining minimal, uncluttered aesthetics with an enviable array of child safety features, the Lux is the canopy of choice for many primary schools. With the gutters and downpipes hidden inside sturdy aluminium profiles the canopy is football-proof, looks great and is also inherently anti-climb. A certified Non-Fragile Roof gives you peace of mind, while the hidden fixings and rounded finish reduce the possibility of injury in the case of a potential impact. Available with clear and coloured roof options, the canopy carries a 10 year guarantee. Standard finishes are RAL 7016 (dark grey) and RAL 9010 (white) – for other colours POA.

A – Standard lux shelters

Includes Installation - POA



B. Lux shelter with post protectors

Includes Installation - POA



C. Lux shelter with enclosing blinds (Weatherproof option)

Includes Installation - POA



We offer a Complete Bespoke service to meet your specific requirements.
Please ask for Details
Prices are subject to a site survey and quotation.

Sailshade:

A simple and cost-effective way of introducing both colour and shade into an outdoor area. Use as single units or in combination to create a shade or delimit the playground into different areas. The playground isn't the only option – they also work well on a school field.

**Timber playground shelter:**

Perfect for outdoor learning, quiet time, play time, talking time – this high quality shelter with built in seating benches is a versatile addition to any space. Constructed from high quality, sustainably sourced softwood, its tactile and sheltered feel creates a refuge and favourite place for children and adults alike. Generous seating promotes inclusion and space for all.



We offer a Complete Bespoke service to meet your specific requirements.
Please ask for Details
Prices are subject to a site survey and quotation.

Velo Cycle Shelter

The Velo Cycle Shelters are timeless, durable, Cost-effective, unobtrusive and quick to install.

Available in a standard galvanized finish or galvanised and powder coated in the colour of your choice.

The Velo shelters can designed and made to fit your exact space so your bikes and Scooters stay dry and protected.



Page Link - see pages

Timber
Cycle
Shelters → 418



Page Link - see pages

For Bike
Lockers → 414



We offer a Complete Bespoke service to meet your specific requirements.
Please ask for Details
Prices are subject to a site survey and quotation.



Planning a school refurbishment over the holidays?

Or refreshing a 'tired' interior? We have the design experience and project 'know-how' to create and deliver the perfect result you're looking for without the hassle!

Design & Refurbishment

Design & Build	424-425
Washrooms	426-427
Libraries & Learning Zones	428
Staffrooms & Tea Points	429
IT Suites	430
Cloakrooms & Changing Rooms	431
Reception Areas	432
Offices & Meeting Rooms	433
Science Laboratories	434-435
Home Economics	436
Decorating	437
Flooring	438-439
Ceilings & Lighting	440
Classroom Refurbishment	441
Outdoor Spaces	442-443

Design & Refurbishment

Your new-build, extension or total refurbishment can safely be left entirely in our care. If you wish, we will undertake the whole process from initial consultation and plans right through to furniture, fittings and final sign off.

Or, if you prefer, we are happy to work with your architect or designer to bring your plans to life. Our aim is to relieve you of as much of the hassle as possible – leaving you to focus on what you are best at.

These are few of the services we offer:

- Initial plans
- Liaising with the Local Authority
- Applying for Planning/Building Regulations approval
- Groundwork, foundations
- All construction work
- Plumbing, electrics, lighting, heating and ventilation
- Carpentry and joinery
- Carpets, wall coverings and decoration
- Furniture design and installation



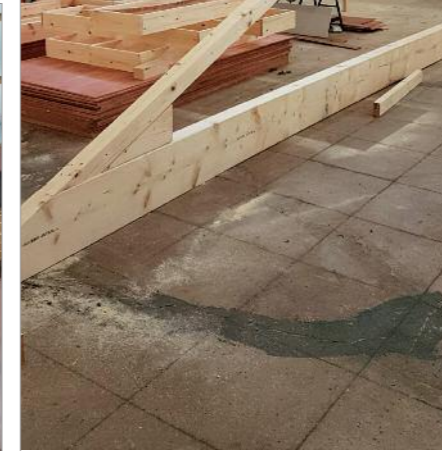

Design & Build

Your new-build, extension or total refurbishment can safely be left entirely in our care. If you wish, we will undertake the whole process from initial consultation and plans right through to furniture, fittings and final sign off.

Or if you prefer, we are happy to work with your architect/designer and bring your plans to life. Our aim is to relieve you of as much of the hassle as possible – leaving you to concentrate on what you are best at.

These are few of the services we offer:

- Initial plans
- Liaising with the Local Authority
- Applying for Planning/Building Regulations approval
- Groundwork, foundations
- All construction work
- Plumbing, electrics, lighting, heating and ventilation
- Carpentry and joinery
- Carpets, wall coverings and decoration
- Furniture design and installation

Design & Build

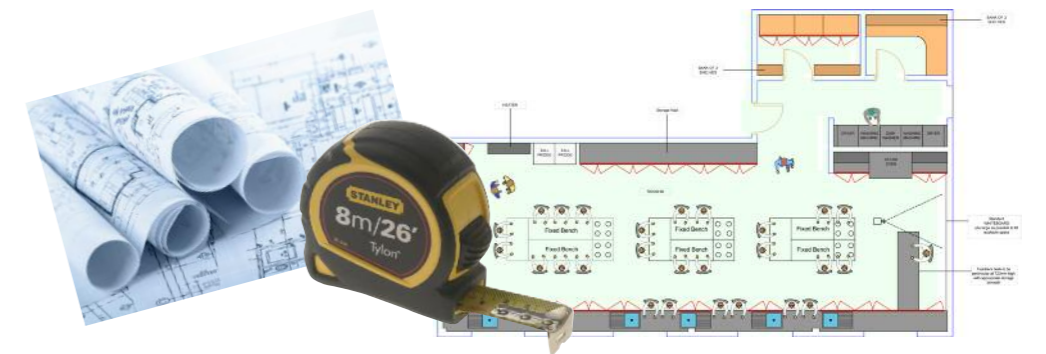



Washrooms

You might be surprised to know how many pupils (and parents) judge a school by its washrooms! A bright, colourful, hygienic and welcoming washroom environment can make a difference throughout the whole school.

Features & Options

- Fantastic selection of colour choices available
- Postformed vanity tops for fully-recessed or semi-recessed options

- Solid aluminium locks, hinges, headrail and adjustable feet
- Real high-pressure laminate face with impact resistant edging
- Ultimate durability
- Totally impervious to water
- Black profiled panel edges
- Low door and division height
- Option of print design doors
- Option of SGL or HPL core material

Please contact us for details of the full range and for more advice.

Washroom Accessories



Options & Accessories

We have a huge range of fixture and fitting options as well as our extensive range of colours, and materials.

- Heavy duty non slip vinyl provides a neat and cost effective flooring solution to wet areas
- Wall cladding uses matching material to the cubicles. It provides a

- cleanable robust surface with panels that can be removed if required
- Resin flooring uses a 3 layer system with metallic or mineral chips for durability & will not shrink or crack and is guaranteed for 25 years
- Ceramic tiles are ideal for washroom areas. There are a wide range of colours and sizes available, together with matching trims



Libraries & Learning Zones

Your new library or learning zone must provide efficient, practical and accessible storage of your learning resources. But if it is to fulfil its purpose it must also be attractive and welcoming for the pupils.

- Huge range of shelving configurations, colours and finishes
- Choice of standard module sizes or bespoke
- Reading dens, benches and tables
- Flooring and décor design and installation

Please contact us for details of the full range and for more advice.

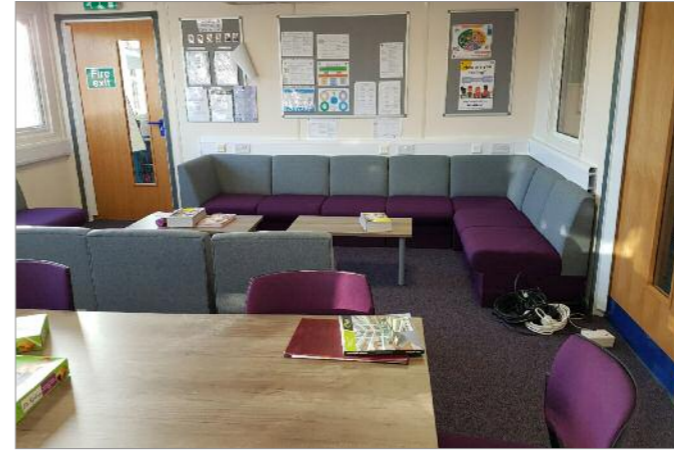

Staffrooms & Tea Points

- Backed up by our experience and expertise we ascertain exactly what you need – and build it for you
- Large range of comfortable and relaxing seating units
- Armchairs, coffee tables
- Flooring and décor design and installation
- Worktops, sinks and storage

Please contact us for details of the full range and for more advice.



IT Suites

Thoughtfully planned and carefully executed, a good IT suite will give many years of service. We can design and build the complete suite, including fixtures, fittings and cabling for each station.

- Flooring and décor design and installation
- Stylish and durable benching frames and tops
- Wide range of benching colours and finishes
- Range of chair designs and colours

Please contact us for details of the full range and for more advice.



Cloakrooms & Changing Rooms

An area where intelligent design and robust construction are essential. We are able to design, plan and construct your cloakroom or changing room and complete it with all necessary fittings and storage lockers.

- Flooring and décor design and installation
- Benching, racking and lockers
- Coat hooks

Please contact us for details of the full range and for more advice.



Reception Areas

With years of experience designing and fitting bespoke reception areas we can offer advice on every aspect of the process.

Even in the smallest and most awkward spaces we can deliver practical and beautiful solutions to suit your needs!

Please contact us for details of the full range and for more advice.



Offices & Meeting Rooms

As well as our extensive ranges of office furniture featured in this catalogue, we can help you design, and build or refurbish your offices.

Our experienced designers use 2D and 3D CAD drawings to optimise your office space. Our skilled installation teams include electricians, joiners, plumbers and flooring fitters.

Please contact us for details of the full range and for more advice.



Science Laboratories

- 16mm Trespa Toplab solid grade laminate worksurfaces
- Units come with MDF carcasses and laminate faced doors
- Turrets built and fitted to bespoke sizes for services including gas, water and electrics
- Removable back panels in base units allow access to pipework
- Full length steel drawer runners
- Vulcathene acid resistant waste pipework

- Grohe gas taps and water spouts
- Belfast sinks – range of sizes
- Large choice of surface colours and storage trays
- Matching furniture for Prep rooms
- Mobile steel tray storage
- Acid, poison and toxic chemical cabinets

Please contact us for details of the full range and for more advice.



Science Laboratory Options

- Powerbars
- USB ports
- Laptop trays
- Cable trays
- PC shelves
- Learning walls
- 270 degree hinges to the doors
- Corian worksurface option
- Draining grooves for the sinks
- Fume cupboards, built in or mobile
- Blackout blinds for light experiments

Please contact us for details of the full range and for more advice.

Trespa Top Colours Options





Freestanding or Built-In Appliances



Base units with over 30 colours of laminate top

Home Economics

We offer a wide range of materials and finishes in all its configurations, whether you want wood finish, laminate or even Trespa, we can do it all.

- Optional bag stores
- 40mm Plexi-Form tops with D wrap laminate edging
- Ingredients storage units
- Fully integrated appliances if required
- Gas safe approved installation

- Warming drawers
- Corner carousels
- Extraction for adequate ventilation to regulation requirements
- Large range of colours of worksurfaces and finish options; units, floors, walls, stools
- Ask one of our Design Team to draw up a plan for your consideration

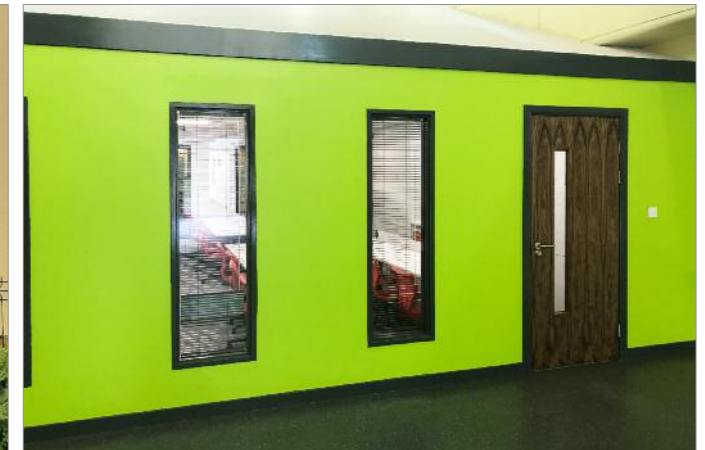

Decorating

Our decorating teams will work with you to cause the least disruption possible while work is in progress. They work fast, accurately and quietly, and will carefully clear up at the finish.

To us, this is the most important factor. The fact that you get a beautifully decorated space is a bonus.

Call us now with your requirements.



Please contact us for details of the full range and for more advice.



Flooring Options

We have an enormous range of flooring options, colours and patterns including carpeting, carpet tiles, vinyl and Polysafe flooring.

Please contact our experienced installation experts for advice about which materials are most suitable for your environment.

Please contact us for details of the full range and for more advice.

Carpet tile finishes

Hard-wearing and highly functional, our carpet tiles are designed with affordable excellence in mind.

A professional, smart-looking tile, the plain tile is available in 24 block colours, which seamlessly combines with Essence Stripe, Structure and Maze, providing unprecedented creative design opportunities.

With its plain level loop pile structure, and a strong line of commercial colours, this product goes back to the pure essence of a flooring product.



Essence

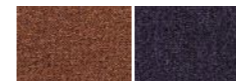

Essence Structure

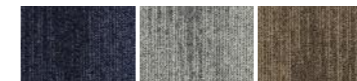

Essence Stripe

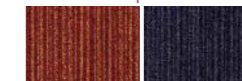

Essence Maze



Vinyl flooring

Standard XL is a hardwearing and practical commercial floorcovering available in a choice of gauges to suit the application. Not suitable for wet areas.

Featuring top-selling shades, representing the vast majority of volume sales, Standard XL is available in a duotone marbleised decoration.

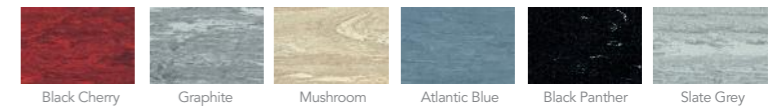



Ceilings & Lighting

Pupils' activity levels vary over the school day and as more schools use flexible desk arrangements, lighting and ceiling solutions need to be designed accordingly.

Lighting and ceilings play a significant role in contributing to the happiness and well-being of teachers and pupils. A well designed and flexible lighting solution will support activities and give uniform brightness throughout the room.



Circular steel rimmed single pendant



Single stainless pendant



Round interior bulkhead fitting



600 x 600mm LED panel



4-Tube low bay fitting



Wire mesh ball guard

Classroom Refurbishment

Classroom getting tired? Needing a new layout? Short of storage space? Staff and children getting depressed? The answer is to call us in to refit your classroom. We will strip it out, redecorate, give it new flooring, new storage equipment, new furniture, new ceiling and lighting. In short – a bright and enthusiastic atmosphere for the start of term.

- Flooring
- Ceiling and lighting
- Decorating
- Tables and chairs
- Built-in storage furniture
- Boards and interactive whiteboards
- Windows and blinds

Please contact us for details of the full range and for more advice.



Outdoor Spaces

Let us transform your outdoor space into an interesting and engaging play and relaxation area. We can undertake all aspects of design and installation.

- New hard and soft surfacing
- Fencing/walling
- Canopies
- Pergolas
- Gazebos
- Shade sails
- Play equipment
- Sheds and huts

Please contact us for details of the full range and for more advice.



A

Acoustic Surfaces	398-403
Activity Rugs	104-105
Adjustable Tables	120,121,324,325
Alu Lite Staging	202
Alu Rapid Staging	204-205
Art & Paper Storage	84,85
Auditorium Seating	207
AV Cabinets	397

B

Bean Bags	124
Beds, Dormitories	340-343
Benches, Outdoor	408-413

Bespoke Furniture

Conference Tables	307
IT Suites	144-145
Libraries	184-186
Multiwall	95
Receptions	282-293
Storage Wall	350-353
Bicycle Storage Rack	417
Bins	415-417

Boardroom Tables

Alpine	296,297,304
Barrel Top	297,300,301,306
Circular	298,301,302,305,
Flip-top	303-305
Oval	297,300,301
Pole Leg Tables	296-298,302

Bookcases

Alpine X Storage Range	317-319
Bookshelves	56,59,78
Classtore Modular	98,99
Coloured Edge	58,59
Desk High	316,317,321
Orbit Range	321
Quadrant	333
Signature	322
Book Storage	75,78,84,115,
Break Out Seating	168-175,212,239
Built In Classroom Storage	95-99

C

Cable Management	346-349
Cafeteria Tables	176,178

Calstor

Art Storage	85
Classroom Trolleys	89
Flexible Storage	88
Library Storage	89
Cantilever Shelving	187

Carpets

Design & Refurbishment	438-439
Early Years	103

Chairs

Anti Tilt	34,36-39
Atlas	32
Bordeaux	253



Cantilever	33,35
Cathedral Chair	264
Chair To Go	34
Chair Trolley	30,32,37,38,41
Chester Mesh	247,270
Chevron Posture	38
Chiltern	29
Classic Banquet	262
Classic Poly	30
Classroom	28-41
Dining	168-175
Ermington	172
Event	41
Flex Dining	168
Flow	35, 169
Folding	41
Forma	175
Forum	32

Gorgio	252
Graduate	11
High chairs	45
IT Chairs	146-149
La Rocca	169
Louis	260
Malaga	175
Merlin	243
Peak	261
Perennial	40
Pescara	173
Planet	29
Polka	169
Poly	28
Poly Superior	31
Posture	36-40
Recycled	29
Seville	175
Skagen	172
Skidbase	28,32,33,35
Sochi	168
Spar	173
Stacking	28-39



Standfast	31
Stanza	174
Strata	173
Tamperproof	31,36,146,148
Tuscany	168
Veneto	174
Vogue	264

Classroom Storage

Colorstore Units	79-84
Metal Tray Units	85,90-94
Tray Units	52-54,58,60-66,
	68-75,80-86,88-94
White Range	72,73
Classtore Modular Storage	98,99

Cloakroom & Washroom

Benching	140,141
Coat & Bag Racks	130,140,141
Early Years	130,131
Fit Out	140,141
Cloakroom Trolleys	87,89
Coat Hooks & Rails	131

Coffee Tables

Alpine	241
Metal Frame	218,223,233,240,241
Upholstered	212,214-216,220,233,240
Wooden	218,240,241
Computer Accessories	346-349
Conference Seating	256-271

Conference Tables

Alpine	296,297,304
Colorado	300-302,305
Galway	299
Nova	298
Orbit	303,306
Wexford	299

Coloured Edge Storage

Bookcase & Cupboards	59
Tray Units	58
Coloured Filing Cabinet	355
COSSH Cupboards	360

Cupboards

Alpine X Storage Range	317-319
Classroom	55,57,59,71,77,82,93
Coloured Edge Storage	59
Colourstore	80-84
COSSH	360
Desk High	316,323,334,335,
Fire Resistant	365
Open Bookcases	56,59,78
Orbit	321
Pigeon Hole	338
Signature Storage	322
Sliding Door Tray Units	63
Steel Storage	354-365
Storage Wall	350-353
Tambour Cupboard	316,318,
	319,323,334
Wooden Cupboards	55,57,59,67,77

Cushions	102,124
Cycle Racks	417
Cycle Lockers	414
Cycle Shelters	418,421

D

Data Leads	347
Data & Power Modules	346,347
Design & Refurb	424-443

Desks

Alpine	310-312
Bench Desking	314
Cantilever Leg	312,324-326,328,329
Exam	46,47
Height Adjustable	24,120-122,324,325
Locker	25
Office Desking	296-307
Orbit	320,324
Panel Leg	310,311,320,326-331
Reception	282-291
SMART Flip Top IT	151
Teacher	26,27
Trolley	46
Wooden	25

Dining Furniture

Bar Stool	173
-----------	-----



Benches	164,165,167,178
Bench Tables	159-161
Chairs	168-175
Fixed Seat Solutions	178
Folding Tables	159,160,161
Fresco	167
Outdoor	167

Queue Barriers	179
Screens	179
Stool Tables	160
Stools	173
Tables	158-161,164-167
Tilt Top	158
Trolley	166
Wall Pocket System	162,163

Display Panels

Fastfold	388
Heavy Duty	389
Lightweight	388
Mobile Room Dividers	391
Panel Bags	388
Pole and Panel	390
Tabletop	388
Dormitories	340-343
DuraStore Lockers	136,137

E

Early Years

Activity Rugs	104,105
Art Storage	84,85,
Bean Bags	124, 195
Book Storage	75,78,84,115
Bookcases	56,59,78,
Carpets	103
Cloakroom	130-141
Cloakroom Trolleys	87,89
Cushions	102
Height Adjustable Tables	120-122
Kinderbox Units	75,84,
Mats	103
Nursery Chairs	119
Nursery Tables	120-122
Outdoor Learning	127
Paper Storage	85
Room Scene Kits	110-113
Role Play Panels	108-109
Rugs	104,105
Sand & Water Play	106,127
Sofas	123,126
Soft Seating	123,125,126
Stacking Storage	67,69,77,
Storage Solutions	115-117
Themed Cushions	102
Themed Nursery Seating	123-126
Themed Rugs	104,105
Tray Storage	52-55,58,60-75,
	80-86,88-94,98,99,115,116
Trolleys	86,87,89

Easels	107,374,375	Classroom	24
Easi-Build Staging	200-201	Hushboard Acoustic Tiles	400-403
Easi-Fold Staging	203		
Ergonomic Seating	254,255		
Exam Desks	46,47		
Executive Seating	252,253,270,271		
		I	
		Interactive Whiteboard	376
		IT Desking & Benching	
		Design & Fit-out	424-441
		Flip Pod Desk	151
		IT Desks	151,152
		Laptop Unit	154,155
		Nova Bench Desking	314
		Workstations	152
		IT Seating	
		Contour	146
		Flow IT Chair	146
		IT Stool	149
		IT Tamperproof	148
		Mobile+ Chair	150
		Mono Posture	147,149
		Pennine	147
		Poly IT Chair	147
		Positive Posture IT Chair	147
		Ruckus	150
		Student Tamperproof	148
		Vogue IT	146
		IT Storage, Lapcabby	154,155
		IT Suites	144-155
		K	
		Kinderbox Units	75,84
		KomfiTub Children's Seating	123
		L	
		Lecterns	396
		Leather Chairs	
		Conference	270,271
		Managers	252,253
		Reception Seating	220,227
		Tub	220
		Library Furniture	
		Cantilever Shelving	187
		Dynamix Library Shelving	186
		Lundy Library Units	189
		Windermere Shelving	185
		Library Seating	192-195
		Filing Cabinets	
		Double Secure	365
		Steel	354,355
		Fire Resistant	365
		Signature	322
		Wooden	316,333,
		Filing Cupboards	
		Alpine X-Range	317-319
		Double Secure	365
		Colorado	334,335
		Fire Resistant	365
		Orbit	321
		Signature	322
		Steel	356-357
		Flipchart Easels	374,375
		Flip Top Desks	151
		Folding Chairs	41
		Folding Tables	
		Boardroom	303-305
		Dining	158
		Exam	46,47
		Meeting	303,304
		Training	303-305
		G	
		Glass Magnetic Whiteboard	371
		Glass Showcases	394,395
		Gratnell's Trays	50
		Gratnell's Tray Storage Units	52-55, 58,60-75,80-86,88-94,98,99,115,116
		Grit Bin	415
		H	
		HandiStor Storage	90
		Height Adjustable Tables	
		Early Years	120-122

Literature Display	392,393
Lockers	
Cube	133
Dangerous Substance	361
Janitorial	133
Laptop Charging	153
Mylockers	138,139
Outdoor	137,414
Plastic	136,137
Steel	132-135,138,139

M	
Magnetic Boards	368,370,371,373,
Mats	103
Meeting Tables	296-307
Mesh Back Chairs	246,247,258,261,265
Metal Cupboards	356,357,359-361
Metal Pedestals	362
Metal Tray Storage	85,86-94
Modular Seating	212-216,222, 228-233,238,239
Monitor Arms	348
Multi Drawer Cabinets	354
Multiwall	95

N	
Noticeboards	
Aluminium Frame Cork	379
Aluminium Frame Felt	379,380
Exterior	386,387
Felt Boards	378-380
Fire Retardant	378-381,384,385
Tamperproof Lockable	381,382, 384,385
Unframed	378
Nursery Chairs	119,123-126
Nursery Furniture	115-117,119-126
Nursery Tables	120-122

O	
Office Chairs	242-271
Office Desking	
Alpine	310-312
Executive Desking	330,331
Nova Desking	314
Orbit Panel Leg Desking	320

Orbit Furniture Range	
Desking	320,324
Storage	321
Operator Chairs	242-247
Outdoor Furniture	
Bins	415-417
Canopies	419-420
Cotswold Concrete & Wood Range	411
Cycle Racks	417-418
Grit Bin	415
Lockers	137,414
Outdoor Seating	167,406-413
Picnic Benches	406,407,411,413
Recycled Benches	408,409,412
Shelters/Canopies	418-421
Wooden Benches	408-411

P	
Paper Storage	85
Pedestals	
Metal	362
Wooden	313,320,332
Picnic Benches	
Stone Effect	413
Wooden	406,407,411
Pigeon Hole Units	338
Storage Wall	350-353
Plan Chests	85
Plants	292,293
Plastic Storage Trays	50
Poster Frames	393
Power Modules	346
Premium Storage Range	70-71

Presentation & Display	
Display Cases	394,395
Display Panels	388-390
Flipchart Easels	374,375
Hushboard	400,401
Mobile Room Dividers	391
Noticeboards	378-382,384,385
Whiteboards	368-370,372,373
Projection Boards	376
Projection Screens	377

R	
Reception Furniture	282-291
Reception Seating	212-238

Recycled Chairs	29
Refurbishment	424-443
Retreat Booths	196,197,236,237



S	
Safes	
Electronic Safe	364
Fire Resistant Media Safe	364
Sand & Water Play	106,127
Seating	
Backcare Chairs	250,254,255
Café Seating	168-175
Conference Seating	256-271
Early Years Seating	123,125,126
Fabric Swatches	276-279
High Back Sofas	231,232
Library Seating	182,189,192-195
Managers/Executive Chairs	252,253,270,271
Meeting/Conference Chairs	256-271
Mesh Back	246,247,258,261,265
Modular Seating	212-216,222, 228-233,238,239
Operator Seating	242-247
Pouffes	124,125
Reception Seating	212-238
Reception Steel Frame	217,218
Seating Dimensions	272-275
Seating Index	210,211
Staffroom Seating	212-239
Sofas	212,225-227
Task Chairs	248-251

Tubs	220-222
Wood Frame	219,235
Secure Storage	
Fire Resistant Safe	364
Cupboards	365
Safes	363-365
Screens	
Desk Mounted	315,344,345
Dining	179
Floor Standing	344
Showcases	
External	386,387
Fire Resistant	384,385
Glass Display Cases	394,395
Interior	381-383
Side Opening Tambours	316,318, 319,334, 357
Sink Unit	99
SMART IT Flip Top Desks	151
Sofas	212,225-227
Soft Seating	212-239
Staging & Auditorium	200-207
Staffroom Seating	212-239
Steel Storage	
Dangerous Substances	361
Filing Cabinets	354,355
Lockers	132-141
Multidrawer Units	354
Pedestals	362
Safes	363-365
Storage Cupboards	356,357,359
Tambour Cupboard	357
TecniStor Tray Storage	92-94
STEM Trolley	91
Stools	
Active Balance	34
Flow	45
Graduate Cantilever	42
Louis	260
Molde	268
Mono Posture	45
Olympic	42
Rectangular	44
Round Top	45
Skid Base	43
Stacking	43-45
Student Lipped	43
Wooden	43
Storage	
Allsorts	66,67
Alpine Office Storage	313,316-319

Art Storage	84,85
Bag Storage	86,87
Calstor Art Storage	85
Calstor Classroom Trolleys	89
Calstor Flexible Storage	88
Calstor Library Storage	89
Candy Colours Units	74-76
Charging Lockers	153
Classtor Modular Storage	98,99
Colorstore	79-84
Coloured Edge Storage	59
Contract Tray Storage	65
Early Years Storage	74-77,84, 85,115-118
Fire Resistant Filing Cabinets	365
Grasmere Book Storage	78
Gratnell's Tray	50
HandiStor	90
Kinderbox	75,84
Lapcabby	154,155
Laptop Charging Locker	153
Locking Secure Filing Cabinets	354,355,365
Metal Storage	354-365
Multidrawer	354
Orbit	320-321
Paper Storage Unit	85
Pedestals	313,320,332
Pigeon Hole Units	338
Premium Range	70-71
Safes	363-365
Signature	322,323
Sports Trolley	86
Steel Storage	354-365
STEM Trolley	91
Storage Cupboards	316-319,321, 323,334,335
Storage Trays	50



Storage Trolleys	86,87
Storagewall	350-353
Tambour Cupboards	316,317,318, 319,323,334
TecniStor	92-94
Tray Storage Units	52-54,58, 60-66,68-75,80-86,88-94

Windermere Shelving	185
Wooden Filing Cabinets	316,333,

Storage Trolley

Cloakroom Trolley	87,89
Exam Chair Trolley	41
Exam Desk Trolley	46
Lunchbox Trolley	86,87
Music Instrument Trolley	86
Sports Trolley	86
Transporting	86
Story Cushions	102

T**Tables**

Classroom	8-21
Clover	9
Conference Tables	296-307
Coffee Tables	240,241
Craft	22
Creative Cluster	8,9
Crushbent	16-18
Diamond	8
Exam	46,47
Fast - Track	11
Fully Welded	14,15,19,21
Graduate	11
Heavy Duty	10,23
Height Adjustable Tables	24, 120-122,324,325
Nursery	120-122
Outdoor	167,406,407,411,413
Pie	9
Premium	12,13,22
Primary	12
Project	22,23
Stacking	16-18
Table Height Guidance	6
Tilt Top	158,303-305
Tray	20,21
Tambour Cupboards	316,318, 319,323,334,357
Task Chairs	248-251
Teacher Cupboards	359
Teaching Wall	96,97
TecniStor Storage	92-94
Transporting Trolley	86
Tray Storage Units	52-54,58,60-66, 68-75,80-86,88-94
Tray Tables	20,21

Trolley

Chair Trolley	30,32,37,38,41
Cloakroom Trolley	87,89
Computer Trolley	152
Exam Desk Trolley	46
Lunchbox Trolley	86,87,89
Sports Trolley	86
STEM Trolley	91
Transporting	86

Tilt Top Tables

Dining	158
Tilt-Top	303-305

W**Wall Storage**

Multiwall	95
Teaching Wall	96,97

Washrooms

Accessories	426,427
Coat & Bag Racks	140,141

Whiteboards

Coloured Edge	369
Gridded Boards	368
Mobile Whiteboards	372,373
Magnetic Glass	371
Multi Touch Interactive	376
Non-Magnetic	368,373,
Premium Projection	376
Revolving Whiteboards	371,373
Table Tops	13
Workstation	151,152
Work Benches	23

Prices and product availability may vary during the lifetime of this catalogue. Please contact us to confirm at time of order.

©2019 E&OE