

Hanex[®] Solid Surfaces

Design Flexibility • Durability • Beauty



Hanex® Solid Surfaces

Design Flexibility • Durability • Beauty

Contents

Introduction	4
Commercial applications	6
Residential applications	8
Bellissimo and Nativo ranges	10
Brionne and Therapy ranges	12
Colour collection swatches	14
Cast sinks and bowls	16
Colour matched fabricated sinks and bowls	18
Certifications	20
Care, maintenance and warranty	22



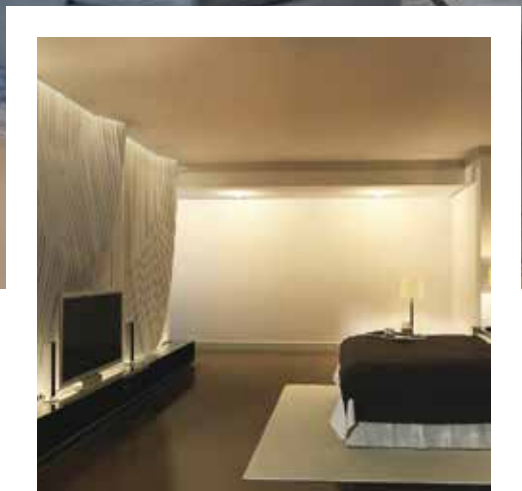
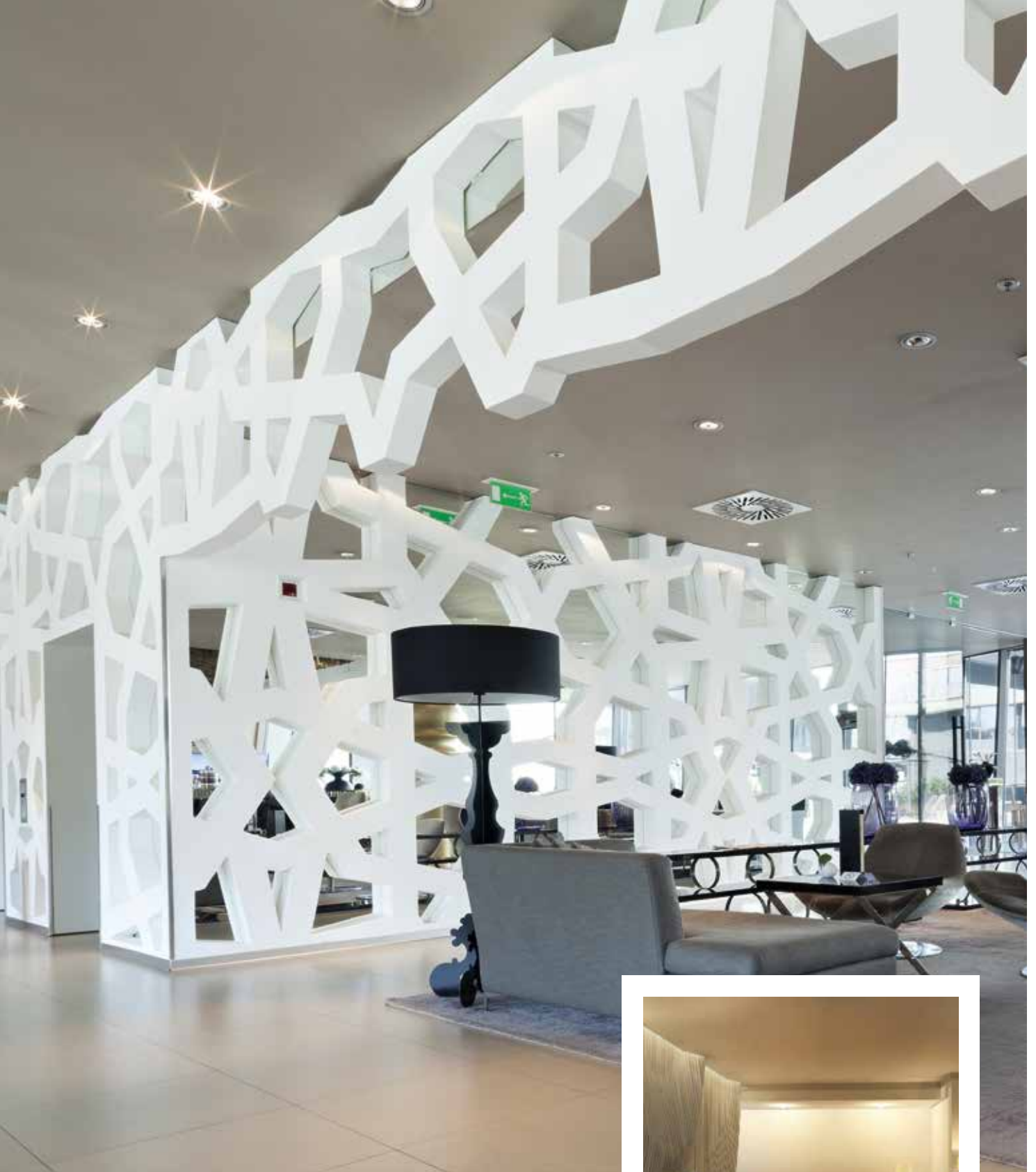

One inspirational surface...

infinite design possibilities

Hanex® is a premium solid surface material offering endless design possibilities and unrivalled product performance.

Infinite designs

Hanex® products are crafted from a unique blend of acrylic resins and natural materials. Hanex® sheet material can be cut, shaped, moulded and thermoformed into an unlimited range of designs. With 80 colours to choose from, including neutral classics and sophisticated pearlescents, there's something to suit every design or concept.

Infinite applications

Suitable for use in any residential or commercial setting, including hotels, retail, hospitality, healthcare, schools, offices or transport, Hanex® combines durability and beauty to create a premium surface that will stand the test of time.

Highly durable, scratch and stain resistant, and easy to maintain; Hanex® offers a cost effective, long-term option for commercial clients.

Unique benefits

- easy to create any design
- durable
- maintains its colour and shape
- resistant to heat, mould, pollutants and bacteria
- renewable and repairable
- environmentally friendly
- easy to care for and maintain
- scratch and stain resistant
- extensive colour range
- 10 year residential and commercial product warranty
- highest FR classification – EN13051-1b Euroclass B
- non-porous and certified NSF51



Commercial applications

The unlimited design flexibility of Hanex® allows you to create a beautiful and durable surface in any commercial setting.

Commercial applications include:

- office
- hospitality
- medical
- nurse stations
- reception desks
- bathroom vanities
- food preparation areas
- kitchens
- commercial fit outs including wall cladding
- desks/work stations
- table tops
- lift and foyer surrounds
- laboratory furniture
- benching
- lighting and more...



The Hanex® product samples received are a guide to colour and overall aesthetics only. Therefore please ensure you are familiar with the overall look of this product prior to purchase so as to avoid misperception issues with the final fabricated product.



Residential applications

Hanex® is ideal for all surface applications in the kitchen, bathroom and other areas of the home. Resistant to moisture, pollutants and bacteria, Hanex® is a hygienic material that is easy to clean and maintain, and offers scratch and stain resistance.

Whether your style is minimal and elegant or bright and bold, Hanex®'s wide range of colours incorporate the latest design trends, and have been developed to coordinate with a broad range of finishes and materials.

Residential applications include:

- kitchen worksurfaces with integrated Hanex® sinks
- splashbacks
- bathroom vanities with integrated Hanex® bowls
- bath and shower surrounds
- wall cladding
- lighting
- objet d'art



The Hanex® product samples received are a guide to colour and overall aesthetics only. Therefore please ensure you are familiar with the overall look of this product prior to purchase so as to avoid misperception issues with the final fabricated product.



Bellissimo NEW

Luxurious, innovative, creative.

The luxurious premium solid surface from Hanex®. Bellissimo offers design possibilities never before imagined by capturing the look and feel of natural stone with random vein designs.



BL-202 Flaxen

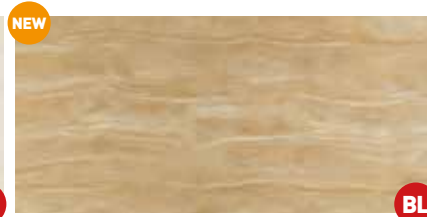

BL-203 Silkwood



BL-205 Sedimentary



BL-206 Slate Grey

Nativo NEW

Distinguished, natural, unique.

Nativo is a distinguished, premium collection with a unique look. The asymmetrical, atypical chips and tone-on-tone colours create a natural and wild look, not seen before in solid surfaces.



NA-001 Blando

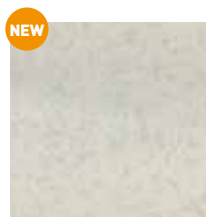

NA-002 Grano

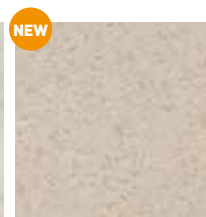

NA-003 Avena

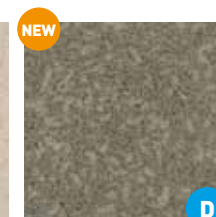

NA-004 Viento

D These décors are heavily pigmented colours, and are prone to show scratches, dust, haziness and ordinary wear and tear more easily than lighter textured décors. Therefore, the following décors are not recommended for use in residential and commercial applications that will be subject to heavy use, and/or horizontal application use, and will not be covered under the Hanex® 10 year commercial and domestic limited warranty in relation to claims for scratches of ordinary wear and tear.

BL These décors are veined colours and small samples may not show the veining effect. Ensure you are aware of the overall look of the Bellissimo product prior to purchase and fabrication of the sheets. Larger samples are available from the Hanex® specification team on 0845 603 7811 or larger décor images are available within our brochure or via www.hanex.co.uk. Please note that covered up stands and non-rebated down stands highlight the vein through the product, and edges should always be rebated on these décors.

The Hanex® product samples received are a guide to colour and overall aesthetics only. Therefore please ensure you are familiar with the overall look of this product prior to purchase so as to avoid misperception issues with the final fabricated product.



B-036 Merino Grey

Brionne

Crisp, clean, pure.

Brionne reflects the natural essence of quartz and solid stone. With an extended colour palette, Brionne now offers eight colours all inspired by natural hues.



B-001 Ivory Essence B-013 Bosque B-033 Festival Grain B-037 Jewel Beach B-027 Stoneholic

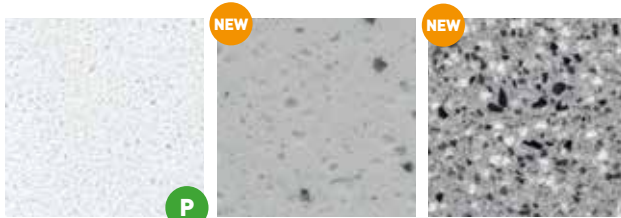

B-031 Helsinki B-036 Merino Grey B-021 Stone Henge

Therapy

NEW



Natural, eco-friendly, recycled.

Therapy is an eco-friendly collection that provides an organic and natural look. Therapy products are manufactured from recycled resources, caring for the environment.



RE-001 Snowflake RE-002 Nuts Crumble RE-003 Biscotti RE-004 Ginger Bread RE-005 Yuri Grey RE-006 Cacao Umber

P These décors are heavily pigmented colours, and are prone to show scratches, dust, haziness and ordinary wear and tear more easily than lighter textured décors. Therefore, the following décors are not recommended for use in residential and commercial applications that will be subject to heavy use, and/or horizontal application use, and will not be covered under the Hanex® 10 year commercial and domestic limited warranty in relation to claims for scratches of ordinary wear and tear.

D These décors contain pearl material within the top surface only and will not show on the edges or through the thickness of the sheet. Ensure you are aware of the overall look of the pearl product prior to purchase and fabrication of the sheets. Larger samples are available from the Hanex® specification team on 0845 603 7811. Please note that covered up stands and down stands highlight the exclusion of pearl material through the product, and edges should always be mitred or heavily rebated on these décors.

The Hanex® product samples received are a guide to colour and overall aesthetics only. Therefore please ensure you are familiar with the overall look of this product prior to purchase so as to avoid misperception issues with the final fabricated product.

Colour collection

Solo



Duo

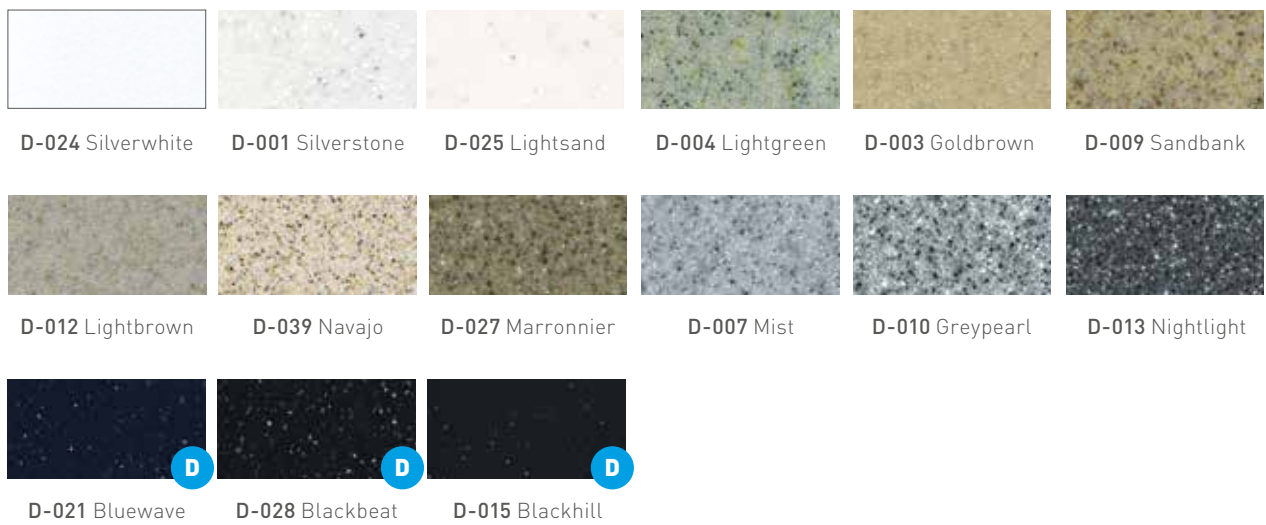

Pearl

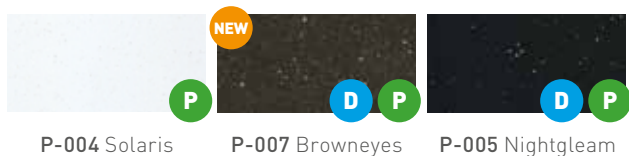

D These décors are heavily pigmented colours, and are prone to show scratches, dust, haziness and ordinary wear and tear more easily than lighter textured décors. Therefore, the following décors are not recommended for use in residential and commercial applications that will be subject to heavy use, and/or horizontal application use, and will not be covered under the Hanex® 10 year commercial and domestic limited warranty in relation to claims for scratches of ordinary wear and tear.

P These décors contain pearl material within the top surface only and will not show on the edges or through the thickness of the sheet. Ensure you are aware of the overall look of the pearl product prior to purchase and fabrication of the sheets. Larger samples are available from the Hanex® specification team on 0845 603 7811. Please note that covered up stands and down stands highlight the exclusion of pearl material through the product, and edges should always be mitred or heavily rebated on these décors.

The Hanex® product samples received are a guide to colour and overall aesthetics only. Therefore please ensure you are familiar with the overall look of this product prior to purchase so as to avoid misperception issues with the final fabricated product.

Cubic



C-004 Cubic Transblanc C-001 Cubic White C-002 Cubic Ivory

Magic



M-005 M-Orange M-003 Red M-007 Black

Trio

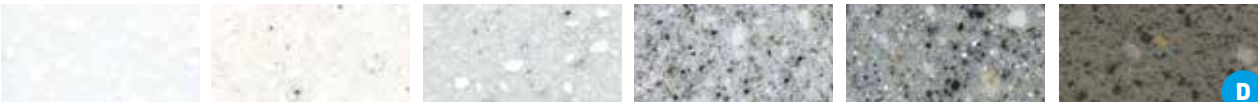

T-021 Pure Artic T-009 N-Silverstone T-050 Ice Queen T-006 H-Blanche T-008 H-Cloudy T-042 H-Gravel



T-071 Organic Cotton T-012 H-Elegance T-091 Triple X T-003 H-Ivory T-049 Hazelnut T-025 Chestnut



T-001 H-Eldorado T-088 Anemone T-210 Rebeca T-211 Valencia T-007 H-Indigoblue

Galleria



GAD-001 Athena GAD-003 Omega GAD-007 Juno GAD-010 Delta GAD-008 Poseidon

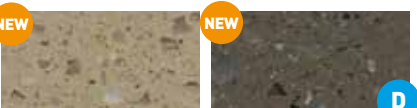

GAD-011 Xenon GAD-014 Hades



Cast sinks and bowls

VANITY BOWLS

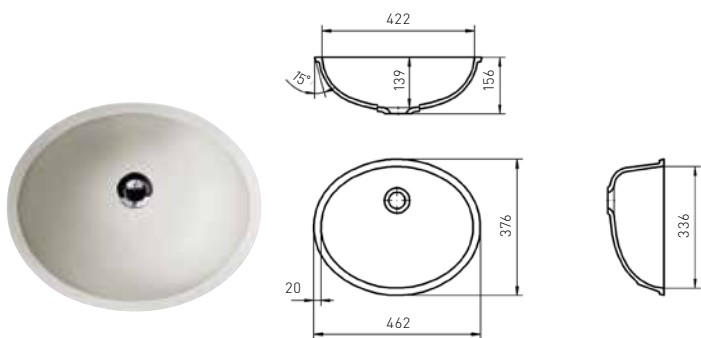

B-4637
Arctic White

Available with rear, front or no overflow.



KITCHEN SINKS

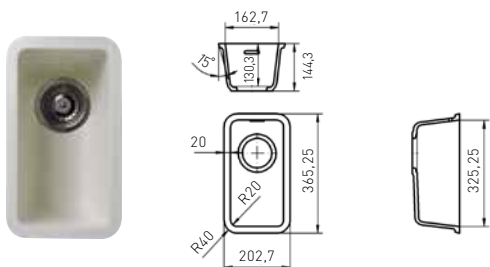

K-2036
Arctic White

Available with rear or no overflow.

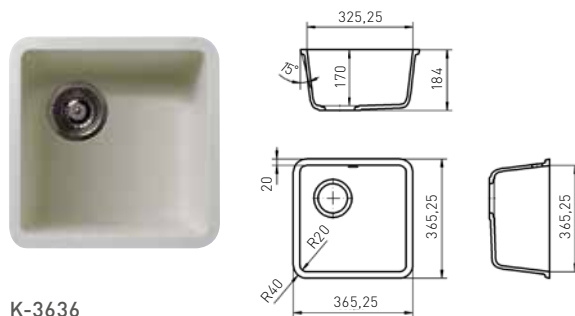

K-3636
Arctic White

Available with rear or no overflow.

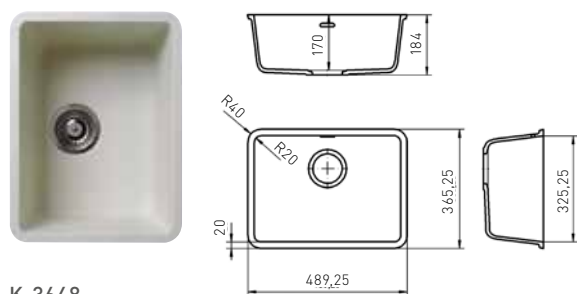

K-3648
Arctic White

Available with rear or no overflow.

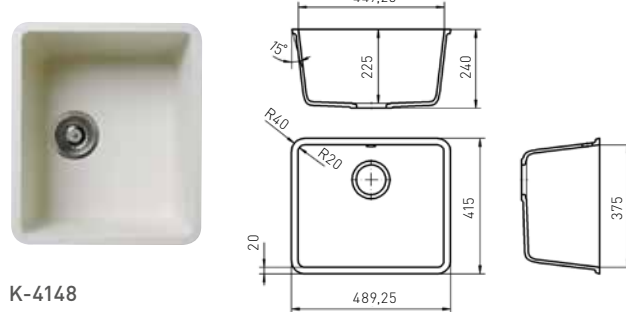

K-4148
Arctic White

Available with rear or no overflow.

All cast sinks are covered by a 2 year manufacturer's warranty.
Please note that these products are Arctic White, so will have a colour variation to the S-008 N-White and S-002 White Hanex® sheets.
Colour matched sinks and bowls for S-008 N-White and S-002 White Hanex® sheets are available in the fabricated sink and bowl ranges on pages 18 & 19.

Colour matched fabricated sinks and bowls

KITCHEN SINKS

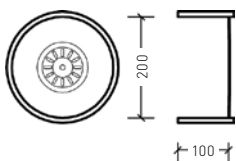

ZK-200 VA

With Stainless Steel Base.
Available with rear or no overflow.

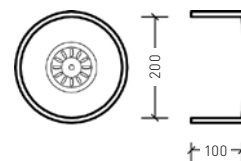

ZK-200 MWS

With Solid Surface Base.
Available with rear or no overflow.

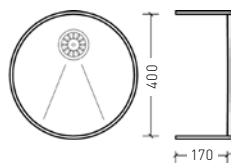

ZK-400 VA

With Stainless Steel Base.
Available with rear or no overflow.

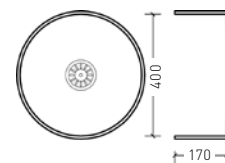

ZK-400 MWS

With Solid Surface Base.
Available with rear or no overflow.

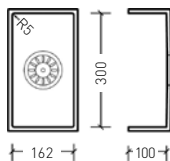

ZK-162 VA

With Stainless Steel Base.
Available with rear or no overflow.

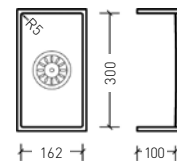

ZK-162 MWS

With Solid Surface Base.
Available with rear or no overflow.

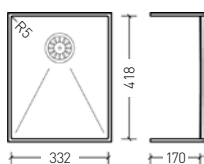

ZK-332 VA

With Stainless Steel Base.
Available with rear or no overflow.

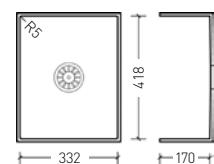

ZK-332 MWS

With Solid Surface Base.
Available with rear or no overflow.

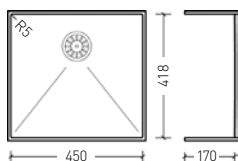

ZK-450 VA

With Stainless Steel Base.
Available with rear or no overflow.

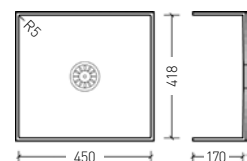

ZK-450 MWS

With Solid Surface Base.
Available with rear or no overflow.

All cast sinks are covered by a 2 year manufacturer's warranty.
Available in all Hanex décors.

We advise that darker décors will show discolouration due to the thermoforming involved to make the ZK-200 and ZK-400 products.

Please consult your retailer for further details.

Delivery lead-times will apply as these sinks are manufactured to order.

VANITY BOWLS

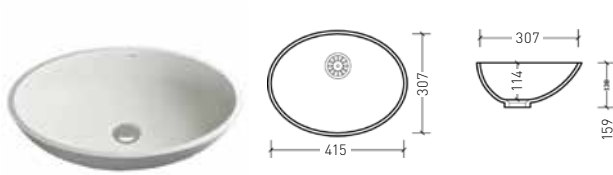

ZO-415

Available with rear or no overflow.

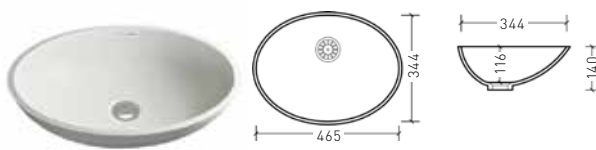

ZO-465

Available with rear or no overflow.

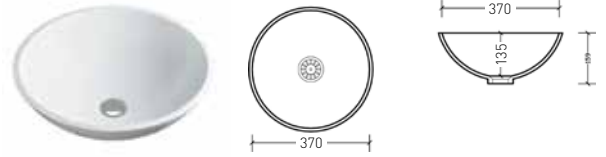

ZR-370

Available with rear or no overflow.

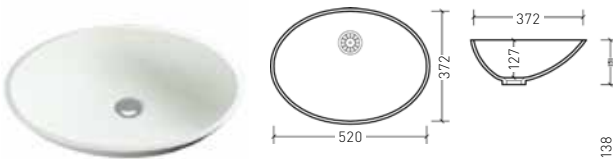

ZO-520

Available with rear or no overflow.

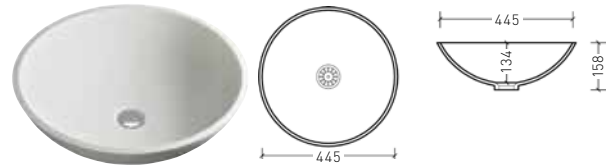

ZR-445

Available with rear or no overflow.

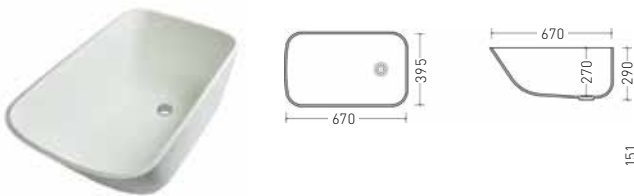

ZH-670

Available with rear or no overflow.

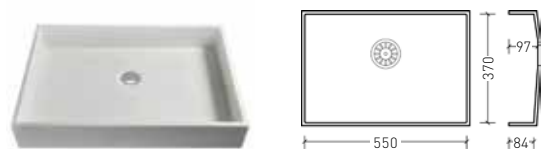

ZE-550

Available with rear or no overflow.

All cast sinks are covered by a 2 year manufacturer's warranty.

Available in all Hanex décors.

We advise that darker décors will show discolouration due to the thermoforming involved to make the ZO-415, ZO-465, ZO-520, ZH-670, ZR-370 and ZR-445 products.

Please consult your retailer for further details.

Delivery lead-times will apply as these bowls are manufactured to order.



S-008 N-White

Certifications

Hanex[®] achieves the following:

Fire (EN13501-1b). This is the European Fire Classification relating to all construction products, including products incorporated within building elements. Products are considered in relation to their end use application. Hanex[®] achieves EN13501-1b Euroclass B which is comparable to BS476 Class 0.

NSF51 Food Hygiene. This standard is applicable to the material and finishes used in the manufacture of food equipment (e.g. residential & commercial worksurfaces, food preparation areas, severy counters, etc).

Stain Resistance. Hanex[®] is an acrylic solid surface material product with a high level of alumina trihydrate content as the filler, an ingredient which provides superior resistance to stains and chemicals.

GreenGuard. Indoor Air Quality Certification ensures that products meet indoor air quality pollutant guidelines and standards.

Scientific Certification Systems (SCS). These certificates relate to recycled chips in use in our material.

Certificates available at www.hanex.co.uk





S-008 N-White

Care, maintenance and warranty

Unlike other surfacing materials, Hanex® is non-porous and features full dimensional colouring. This allows Hanex® to be refinished, removing any surface damage such as scratches, allowing you to restore the surface to its original condition.

Everyday cleaning. Wipe clean with a microfibre cloth, use Unika® solid surface worktop cleaner, mild detergents or non-bleach general household cleaners. Periodically go over the surface with the Unika® Care & Maintenance Kit to maintain a uniform appearance.

Persistent stains. To remove persistent stains or scratches, refer to the Unika® Care and Maintenance Kit. For deep scratches and/or other damages requiring professional repair, please contact your certified Fabricator or us on 0845 603 7811.

Heat damage. The innate feature of Hanex® gives it excellent heat resistant properties compared to other surfacing materials in the market. To prevent any damage from heat, never place hot items directly on the surface. Always use trivets with rubber feet for all hot objects.

Simple steps to avoid damage. Avoid cutting directly on Hanex® - always use a chopping board.

10 Year Warranty. Hanex® solid surface products come with a 10 year product warranty. Hanex® can only be fabricated and installed by Certified Hanex® Fabricators, so you have the assurance of quality product, expert installation, and the backing of our customer service support.

For further details, please visit: www.hanex.co.uk



Due to variations in the photographic and printing process, colours shown in this brochure may vary from the actual product. It is advisable to refer to a product sample before making your purchase. We reserve the right to change the specification of these products without prior notification.

The Hanex® product samples received are a guide to colour and overall aesthetics only. Therefore please ensure you are familiar with the overall look of this product prior to purchase so as to avoid misperception issues with the final fabricated product.



12mm all colours with 6mm available on selected colours.
Hanex® distributed in the UK by International Decorative Surfaces.

EN13501-1b.
Euroclass B-s1, d0.
6mm & 12mm/all Hanex® colours.



Local contact:



Hanex® Solid Surfaces

Design Flexibility • Durability • Beauty

Email: info@hanex.co.uk Telephone: 0845 603 7811
www.hanex.co.uk