

# Before ordering we need to know the following

Please fill in all the relevant details below as accurately as possible to ensure we specify the correct items, unless stated otherwise we will assume operating handle can be located 300mm from cill

## 1. Number of windows to be operated?

 <p>INDIVIDUALLY</p>	 <p>IN PAIRS</p>	 <p>OTHER (PLEASE PROVIDE A SKETCH)</p>
<input type="checkbox"/> Number	<input type="checkbox"/> Number	<input type="checkbox"/> Number

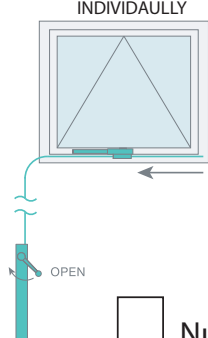
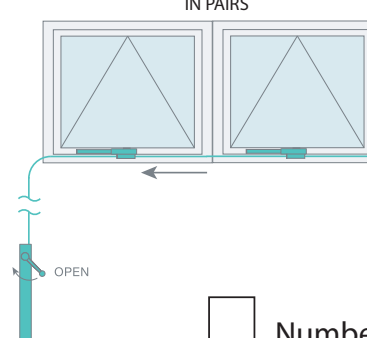
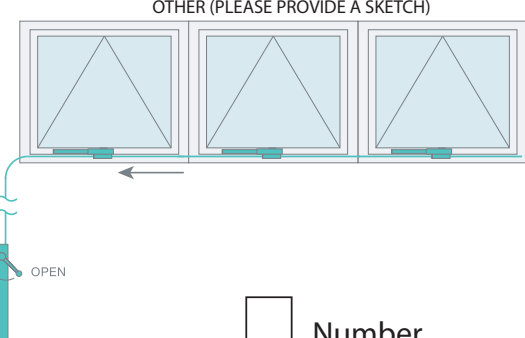

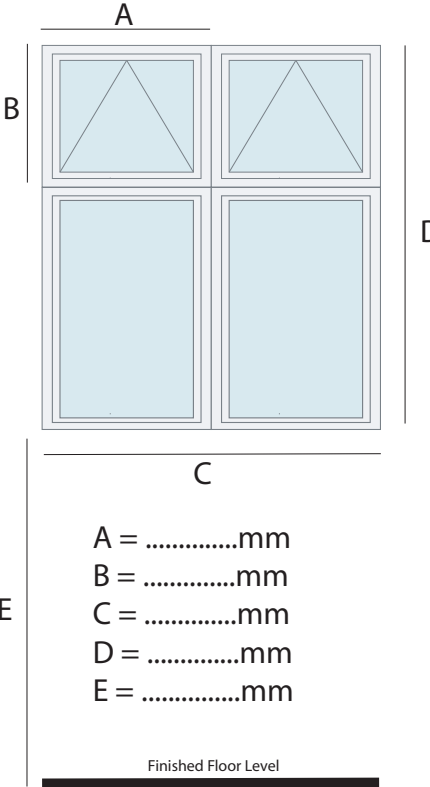

## 2. Window size?

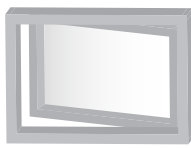

A = .....mm  
 B = .....mm  
 C = .....mm  
 D = .....mm  
 E = .....mm

Finished Floor Level

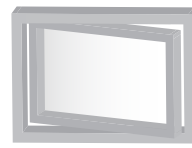
## 3. Window Style?

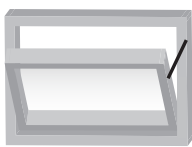
 Side hung open out <input type="checkbox"/>	 Horizontal pivot window <input type="checkbox"/>	 Vertical pivot window <input type="checkbox"/>
 Top hung open out <input type="checkbox"/>	 Bottom hung open in <input type="checkbox"/>	<p>For safety reasons we recommend fitting side support stays to all bottom-hung windows. Please note for bottom hung opening in windows a minimum of 50mm of frame above the window is required to mount the chain opener.</p>

## 4. How does the window open?

Inwards       Outwards

## 5. Window position?

Vertical       In a pitch

## 6. Window Material?

Timber       PVC-U       Aluminium

## 7. Sash & Frame Details with Dimensions

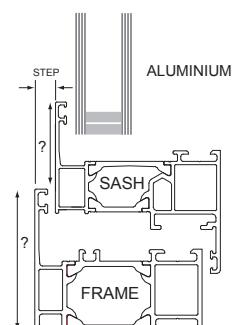
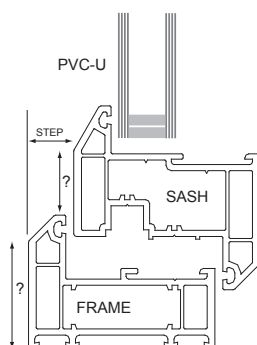
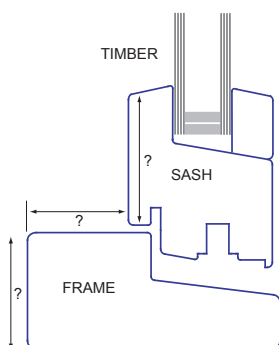

## Other Installation Examples

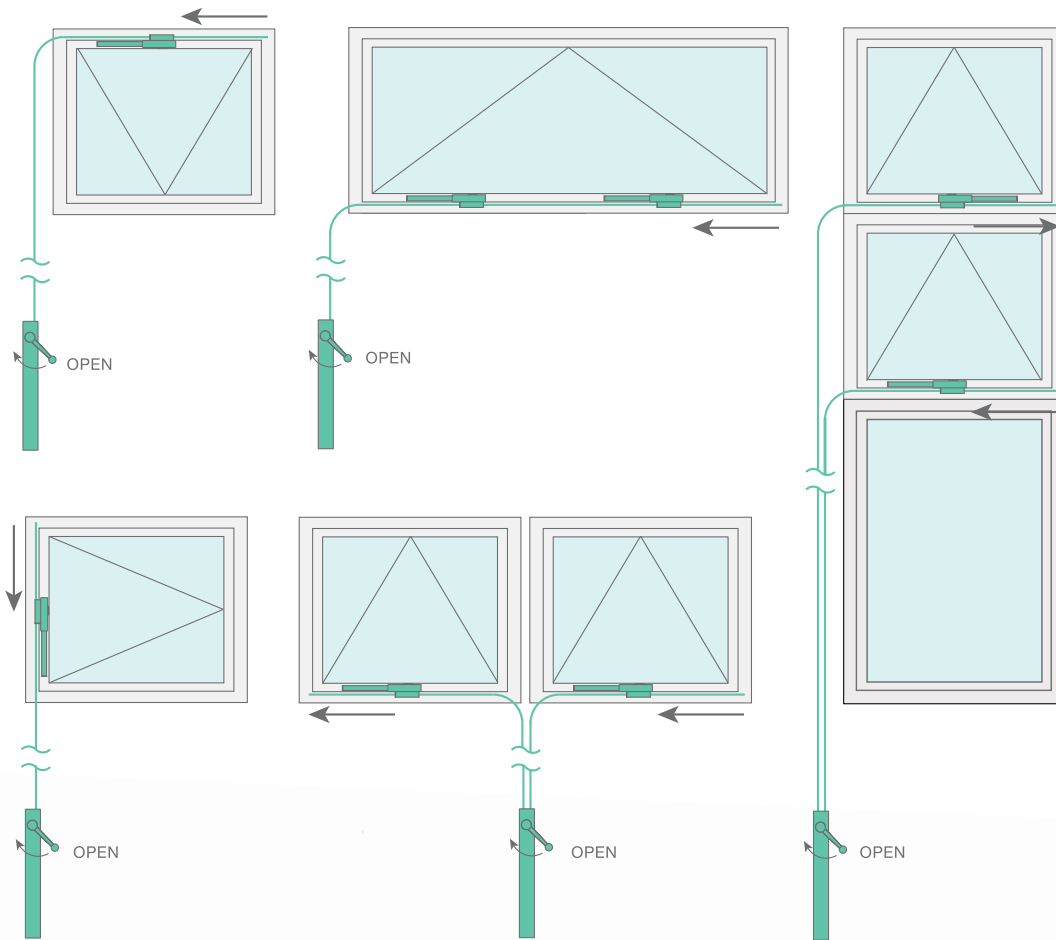

## Example of required sketch

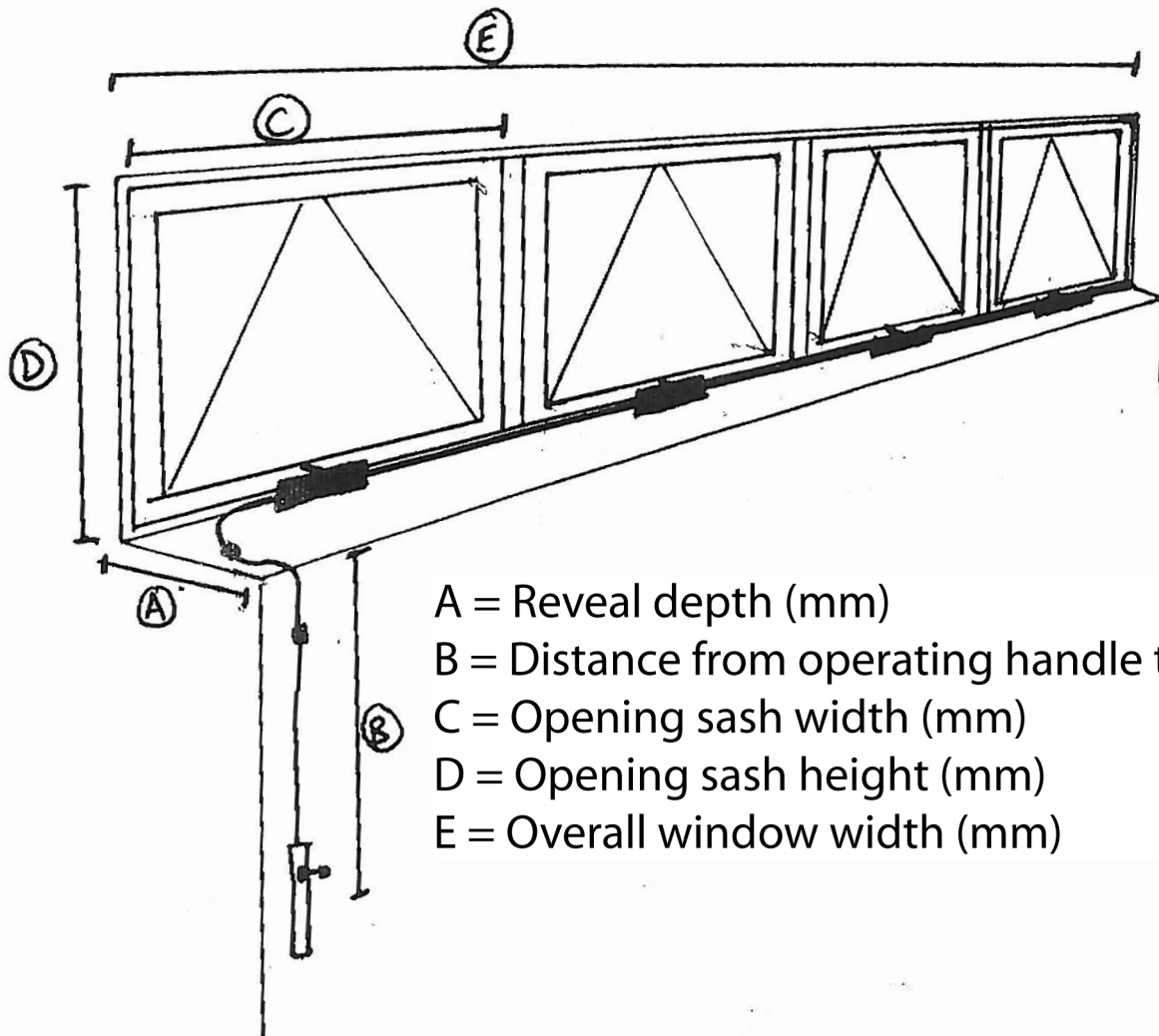

- A = Reveal depth (mm)
- B = Distance from operating handle to cill (mm)
- C = Opening sash width (mm)
- D = Opening sash height (mm)
- E = Overall window width (mm)