

# STOCK Cast Stone

SPRING 2019

## Stooled Cills

CILL Code	Overall Length	Brickwork Opening	Price ea.
01-705	665	460	£46.18
01-708	693	488	£48.31
01-709	778	573	£54.03
01-711	835	630	£58.02
01-714	890	685	£61.78
01-717	1003	798	£69.65
01-720	1120	915	£77.79
01-722	1228	1023	£85.89
01-724	1340	1135	£93.04
01-726	1405	1200	£97.60
01-729	1453 *	1248	£100.89
01-732	1547 *	1342	£107.44
01-733	1565 *	1360	£108.68
01-735	1678 *	1473	£116.73
01-736	1790 *	1585	£124.30
01-738	1975 *	1770	£137.15
01-740	2015 *	1810	£139.92
01-746	2545 *	2340	£176.66

\* Cills Cast in 2 pieces with central joint

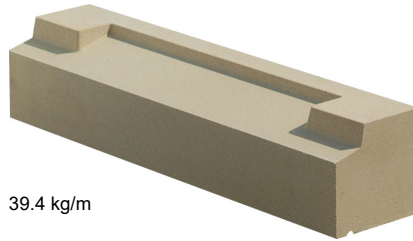

39.4 kg/m

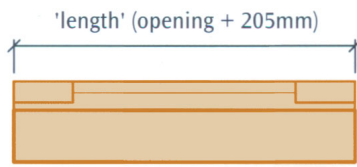
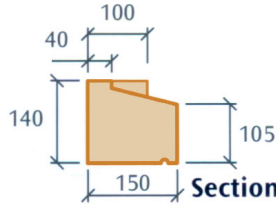

Elevation

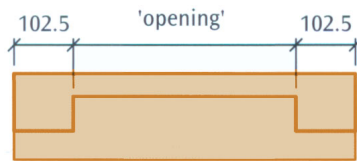

Plan

## Slip Cills

CILL Code	Length (mm)	Price ea.
01-791	1115	£77.52

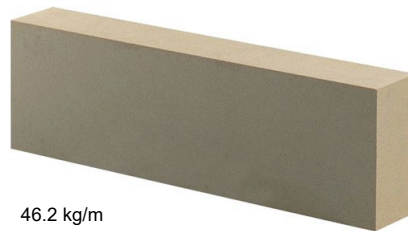

46.2 kg/m

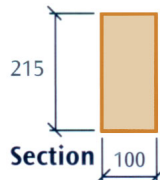

Note: All heads are non-loadbearing and must be supported on an appropriate structural steel lintel.

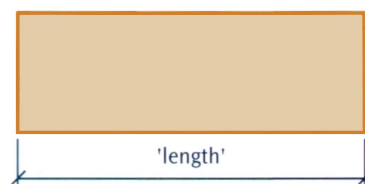

Elevation

(some 140mm tall heads now available from Stock)

## Chamfered Quoins

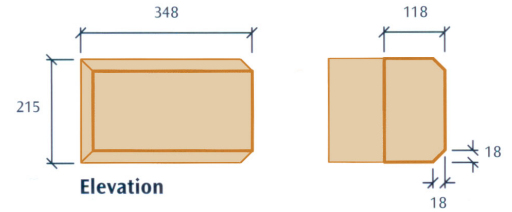

Elevation

24 kg

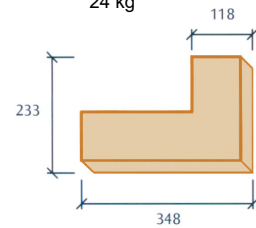

Plan



Code	Price ea.
07-762	£24.96

## Plain Quoins

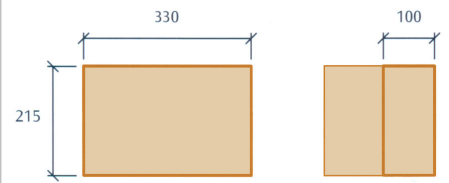

Elevation

20 kg

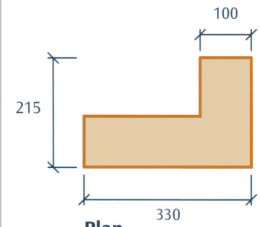

Plan

Code	Price ea.
07-770	£21.72

## Plain Heads

HEAD Code	Overall Length	Brickwork Opening	Price ea.
02-708	693	488	£54.10
02-709	771	566	£60.37
02-711	835	630	£65.21
02-713	890	685	£69.51
02-715	985	780	£76.87
02-716	1005	800	£78.07
02-720	1120	915	£87.43
02-723	1269	1064	£99.04
02-726	1405	1200	£109.68
02-732	1547 *	1342	£120.74
02-736	1790 *	1585	£139.75
02-738	1975 *	1770	£154.19
02-740	2015 *	1810	£156.56
02-746	2545 *	2340	£198.56

\* Heads Cast in 2 pieces with central joint

## Clip Keystones

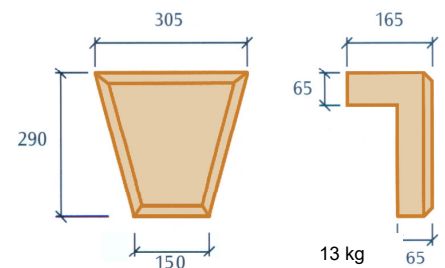

Code	Price ea.
07-365	£46.46



## Bullseye Surrounds

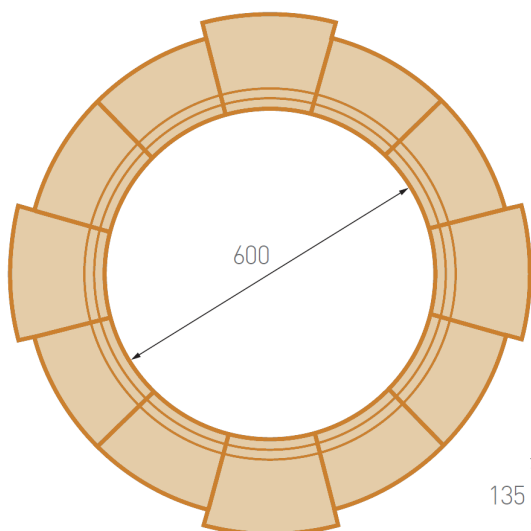

Bullseye Surrounds supplied in sections with an allowance for 5mm mortar joints. These surrounds are designed to be self supporting.

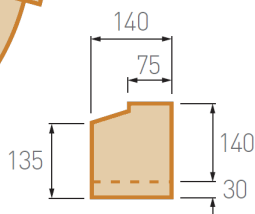

Code	Price ea.
08-065	£297.50

## Copings

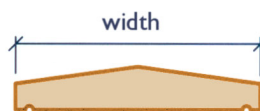

Section

Code	Width	Type	Weight	Price ea.
03-802	180 mm	Straight	7.5 kg	£12.99
03-812	300 mm	Straight	29.5 kg	£42.74
03-818	450 mm	Straight	22.0 kg	£28.70

Copings supplied in 490mm lengths, except 03-812 which is a 990mm length. Flat and once weathered copings also available, please contact Addstone Sales for further details.

## Pier Caps

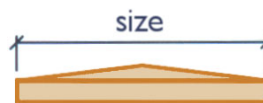

Elevation

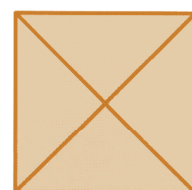

Plan

Code	Size	Weight	Price ea.
04-504	400mm x 400	15.0 kg	£61.27
04-506	500mm x 500	32.5 kg	£76.59

Other Pier Caps are also available, please contact Sales.

## Balustrade

Many elegant Cast Stone Balustrade styles available fast



Contact Addstone Sales for further details and request data sheet **PL02**

## Swimming Pool Copings



Vast range available, contact Addstone Sales to request a free copy of data sheet **PL03**

## Gable Vents

Code
07-465
Price ea.
£135.71

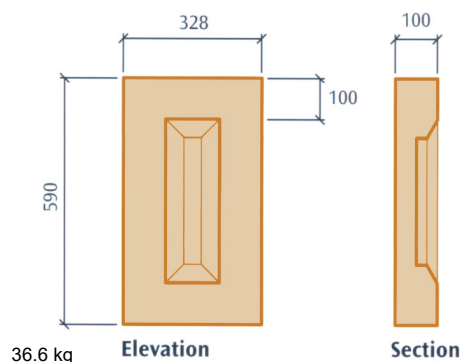

36.6 kg

Elevation

Section

## Corbels

Code
07-565
Price ea.
£59.54

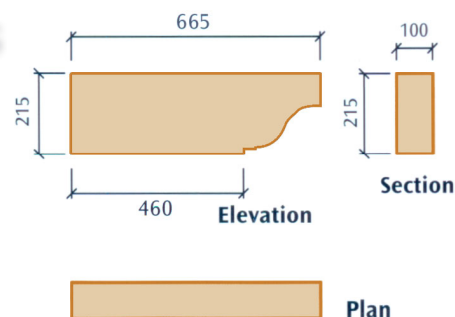

27 kg

Elevation

Section

Plan

**Addstone**<sup>TM</sup>  
Cast Stone from **STOCK**

Addstone Way • off Anchor Road • Stoke-on-Trent • ST3 5BL  
Tel: **01785 878 402** Fax: **01782 501 742**  
www.addstone.co.uk sales@addstone.co.uk

