

HAEMOSTATIC FORCEPS

- HAEMOSTATIC FORCEPS
- TOWEL CLAMPS
- TUBING FORCEPS
- SPONGE FORCEPS

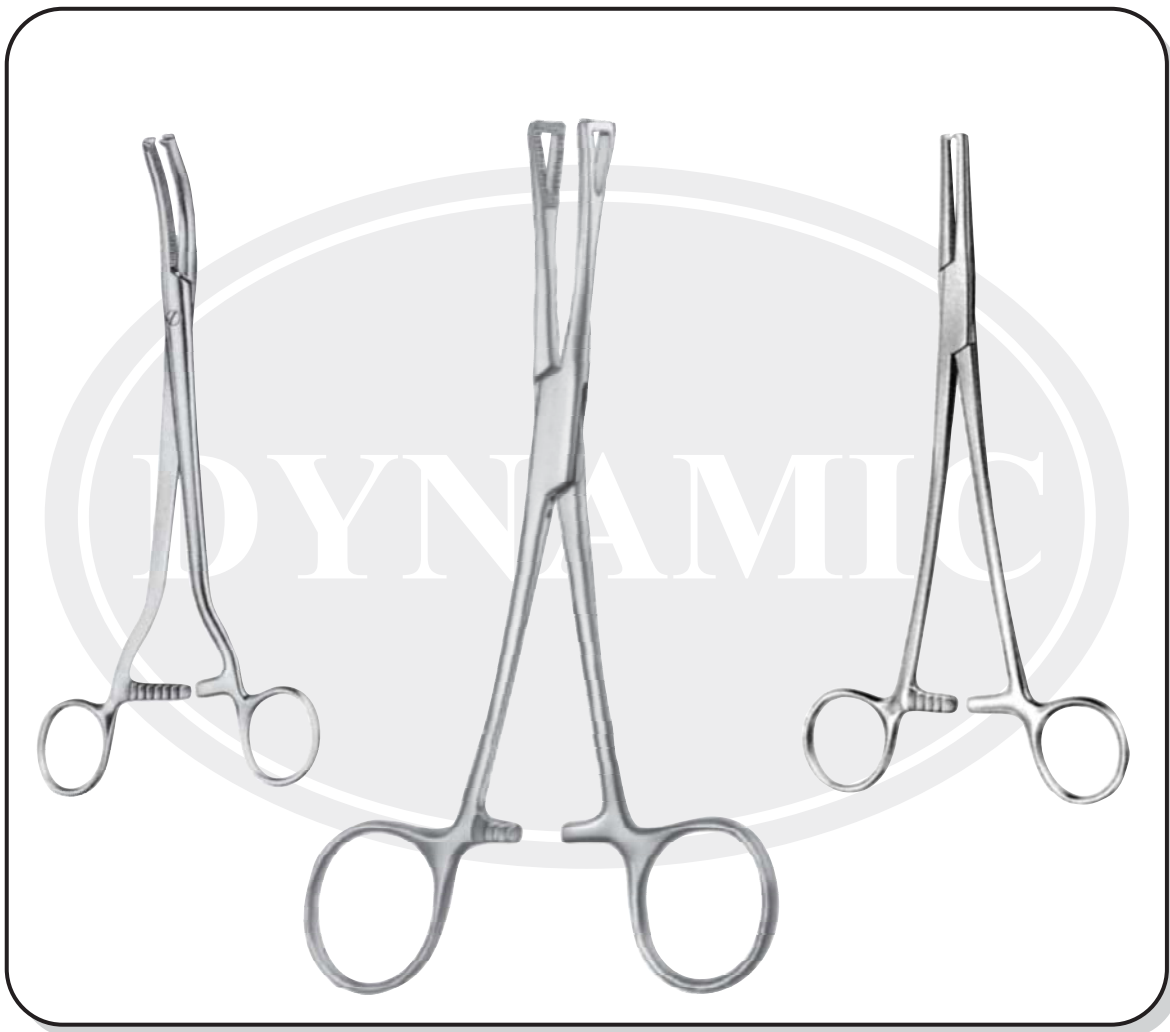



HAEMOSTATIC FORCEPS

Arterienklemmen

Pinces hemostatiques

Pinzas hemostaticas

Pinze emostatiche



TUFFIER
308-005-130
13.0 cm, 5"

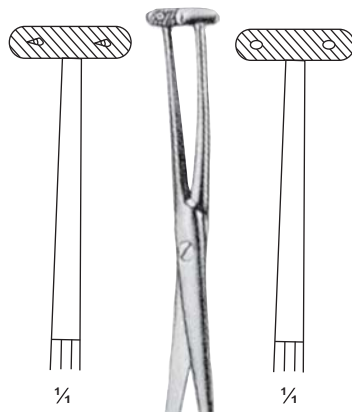
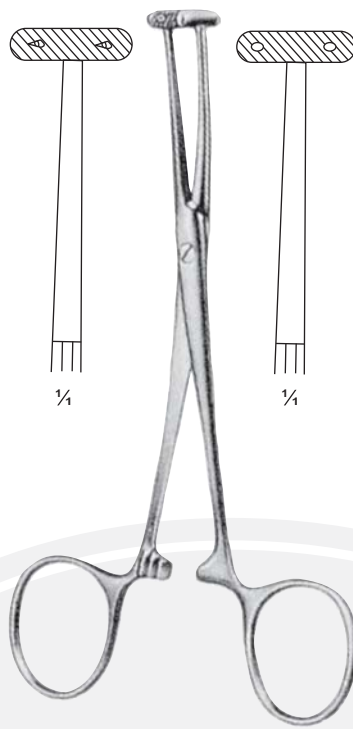

MARTEL
308-007-140
14.0 cm, 5 1/2"

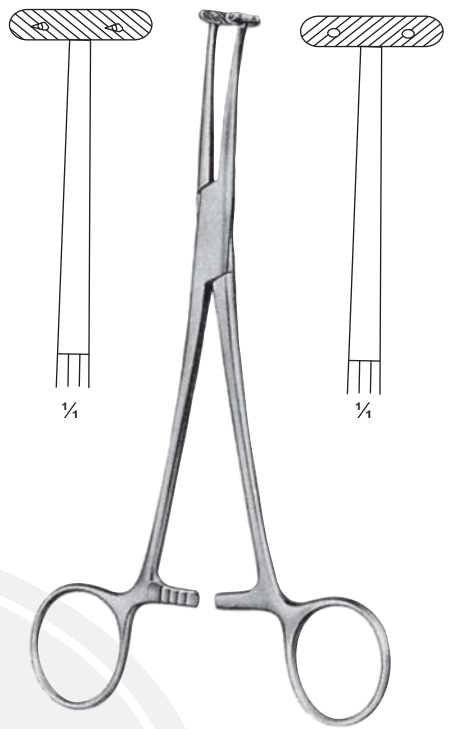

WILLET-MARTEL
308-010-190
19.0 cm, 7 1/2"

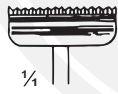

308-012-150
15 cm, 4 3/4"
Slight Curve

PRATT

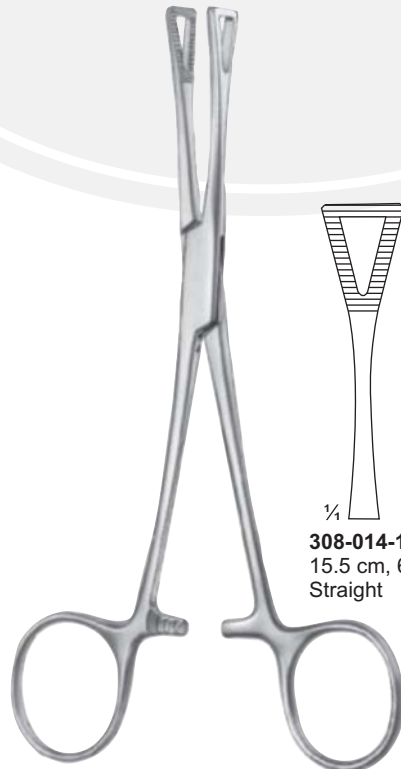

308-014-155
15.5 cm, 6"
Straight

PENNINGTON / SIEZING

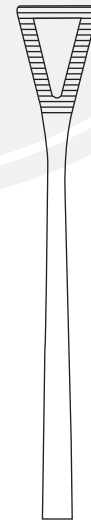

308-015-200
20 cm, 8"
Straight

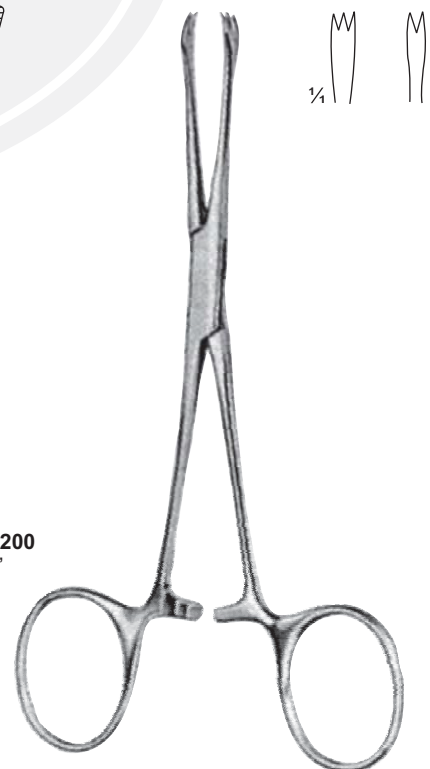

CHAPUT
308-018-130
13.0 cm, 5"

HAEMOSTATIC FORCEPS

Arterienklemmen

Pinces hemostatiques

Pinzas hemostaticas

Pinze emostatiche

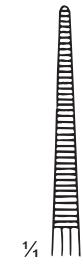

308-037-180
18 cm, 7"
308-038-210
21 cm, 8 1/4"



308-039-180
18 cm, 7"
308-040-210
21 cm, 8 1/4"

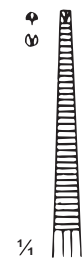

308-042-180
18 cm, 7"
308-043-210
21 cm, 8 1/4"



308-044-180
18 cm, 7"
308-045-210
21 cm, 8 1/4"

HALSTED-MOSQUITO

HALSTED-MOSQUITO 1:2

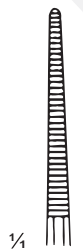

308-048-150
15 cm, 6"



308-049-150
15 cm, 6"

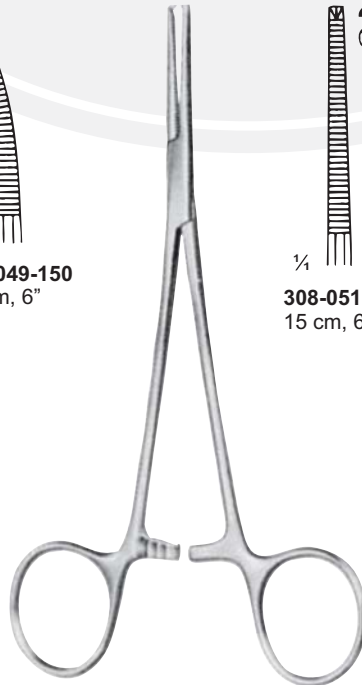

308-051-150
15 cm, 6"



308-052-150
15 cm, 6"

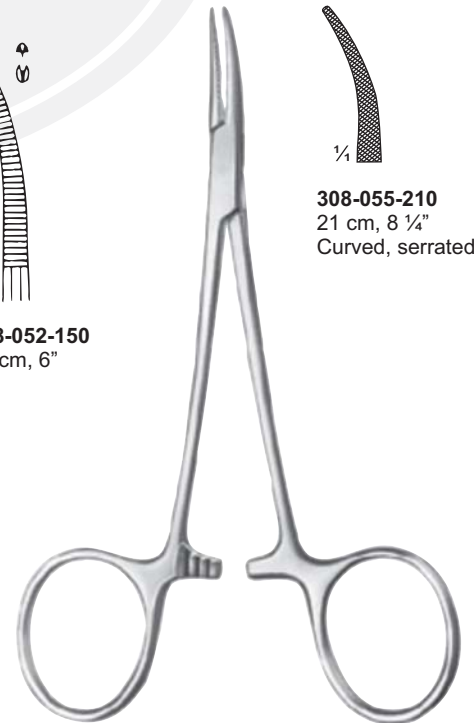

308-055-210
21 cm, 8 1/4"
Curved, serrated

LERICHE

LERICHE 1:2

VANDERBILT / VESSEL CLAMP



HAEMOSTATIC FORCEPS

Arterienklemmen

Pinces hemostatiques

Pinzas hemostaticas

Pinze emostatiche



**MICRO-MOSQUITO /
PETIT POINT**

308-058-100
10 cm, 4"
308-059-120
12 cm, 4 3/4"
Straight, serrated



308-060-100
10 cm, 4"
308-061-120
12 cm, 4 3/4"
Curved, serrated



MICRO-MOSQUITO 1:2

308-063-100
10 cm, 4"
308-064-120
12 cm, 4 3/4"

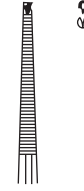

308-065-100
10 cm, 4"
308-066-120
12 cm, 4 3/4"

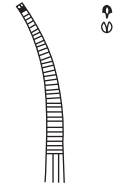

308-069-125
12.5 cm, 5"
308-070-140
14 cm, 5 1/2"
straight, serrated



308-071-180
18 cm, 7"
straight,
serrated



308-072-210
21 cm, 8 1/4"
straight,
serrated



308-073-125
12.5 cm, 5"
308-074-140
14 cm, 5 1/2"
Straight, 1:2 Teeth



308-075-180
18 cm, 7"
Straight,
1:2 Teeth



308-076-210
21 cm, 8 1/4"
Straight,
1:2 Teeth

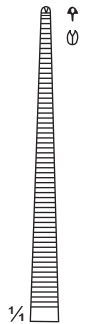

HALSTED-MOSQUITO

308-077-125
12.5 cm, 5"
308-078-140
14 cm, 5 1/2"
Curved,
serrated



308-079-180
18 cm, 7"
Curved,
serrated



308-080-205
20.5 cm, 8"
Curved,
serrated



308-081-125
12.5 cm, 5"
308-082-140
14 cm, 5 1/2"
Curved, 1:2 Teeth



308-083-180
18 cm, 7"
Curved,
1:2 Teeth

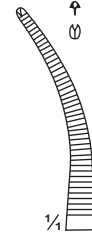

308-084-205
20.5 cm, 8"
Curved,
1:2 Teeth

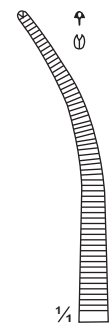

HAEMOSTATIC FORCEPS

Arterienklemmen

Pinzas hemostaticas

Pinces hemostatiques

Pinze emostatiche

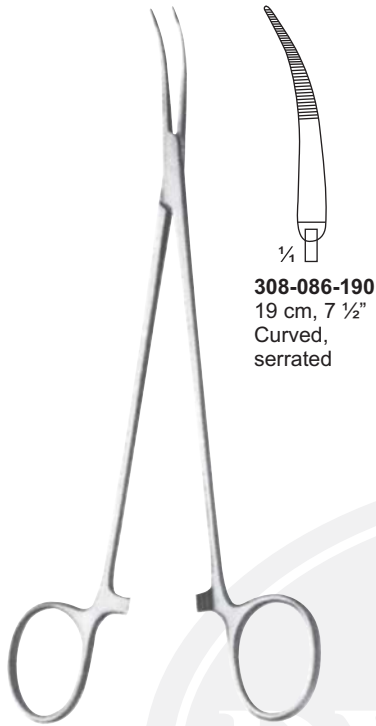

308-086-190
19 cm, 7 1/2"
Curved,
serrated

JACOBSON

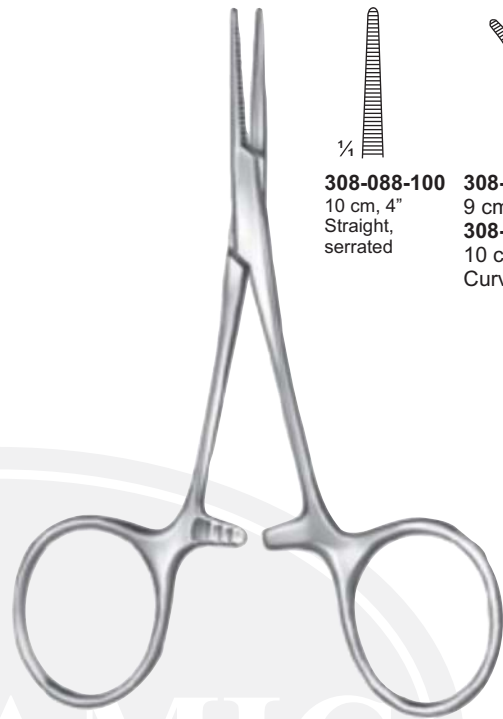

308-088-100
10 cm, 4"
Straight,
serrated

308-089-090
9 cm, 3 1/2"
308-090-100
10 cm, 4"
Curved, Serrated

HARTMANN / MOSQUITO

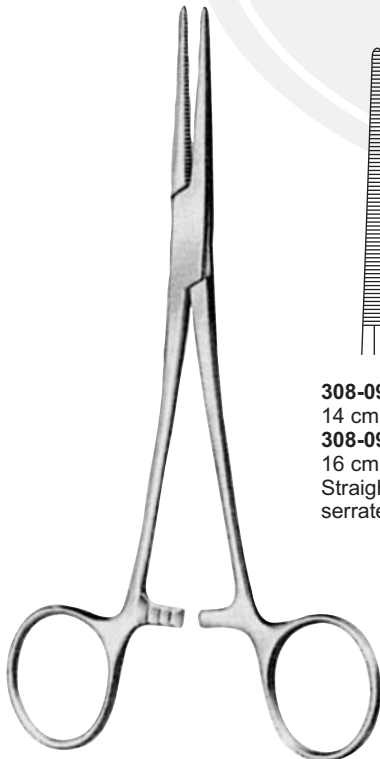

308-092-140
14 cm, 5 1/2"
308-093-160
16 cm, 6 1/4"
Straight,
serrated

COLLER



308-094-140
14 cm, 5 1/2"
308-095-160
16 cm, 6 1/4"
Curved,
serrated



308-097-130
13 cm, 5"
308-098-150
15 cm, 6"
Curved, Serrated

CHRISTOPHE



HAEMOSTATIC FORCEPS

Arterienklemmen

Pinzas hemostaticas

Pinces hemostatiques

Pinze emostatiche



KRONLEIN
308-100-130
13 cm, 5"



PEAN
308-102-125
12.5 cm, 5"



PEAN

308-104-125
12.5 cm, 5"

308-105-140
14 cm, 5 1/2"

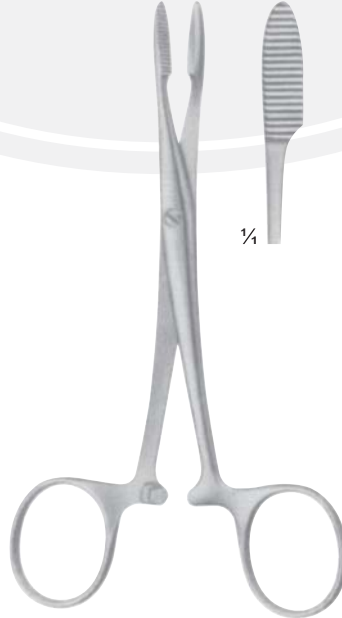

PEAN
308-107-165
16.5 cm, 6 3/4"



PEAN

308-109-165
16.5 cm, 6 3/4"

308-110-185
18.5 cm, 7"



HAEMOSTATIC FORCEPS

Arterienklemmen

Pinces hemostatiques

Pinzas hemostaticas

Pinze emostatiche



308-112-140
14 cm, 5 1/2"
308-113-160
16 cm, 6 1/4"
Straight,
Serrated



308-114-140
14 cm, 5 1/2"
308-115-160
16 cm, 6 1/4"
Curved,
Serrated

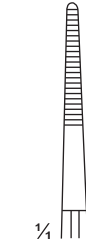

308-117-140
14 cm, 5 1/2"
Straight,
serrated



308-118-140
14 cm, 5 1/2"
Curved,
serrated

PEAN - DELICATE

PROVIDENCE / HOSPITAL

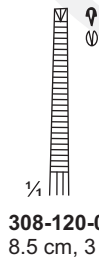
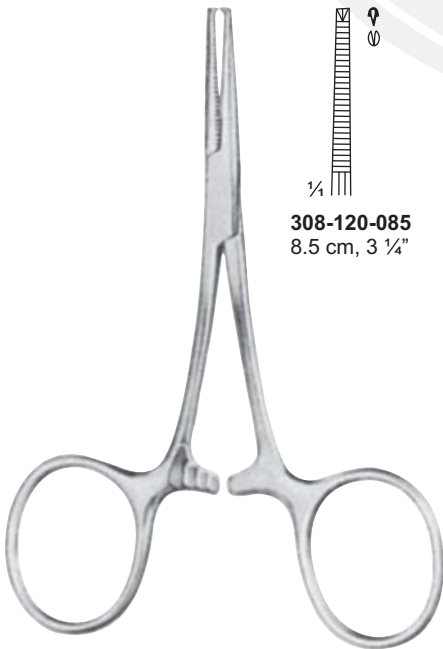

308-120-085
8.5 cm, 3 1/4"



308-122-160
16 cm, 6 1/4"
308-123-200
20 cm, 8"
Straight,
Cross Serrated



308-124-160
16 cm, 6 1/4"
308-125-200
20 cm, 8"
Curved,
Cross Serrated



ROCHESTER / CARMALT

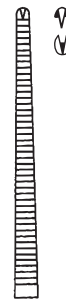

308-128-130
13 cm, 5"
308-129-140
14 cm, 5 1/2"
308-130-160
16 cm, 6 1/4"
Straight, 1:2 Teeth



308-131-140
14 cm, 5 1/2"
curved,
1:2 Teeth

KOCHER / DELICATE

TERRIER 1:2



HAEMOSTATIC FORCEPS

Arterienklemmen

Pinces hemostatiques

Pinzas hemostaticas

Pinze emostatiche

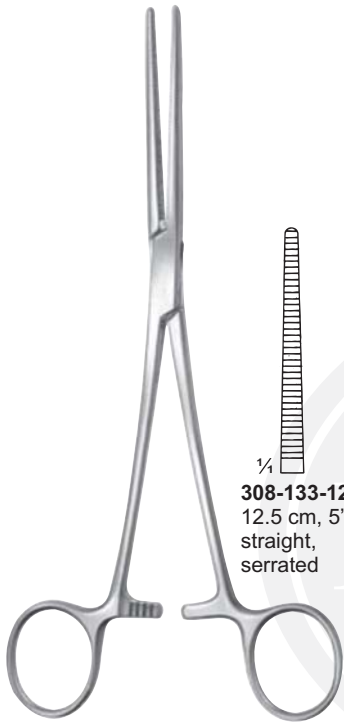

ROCHESTER / PEAN

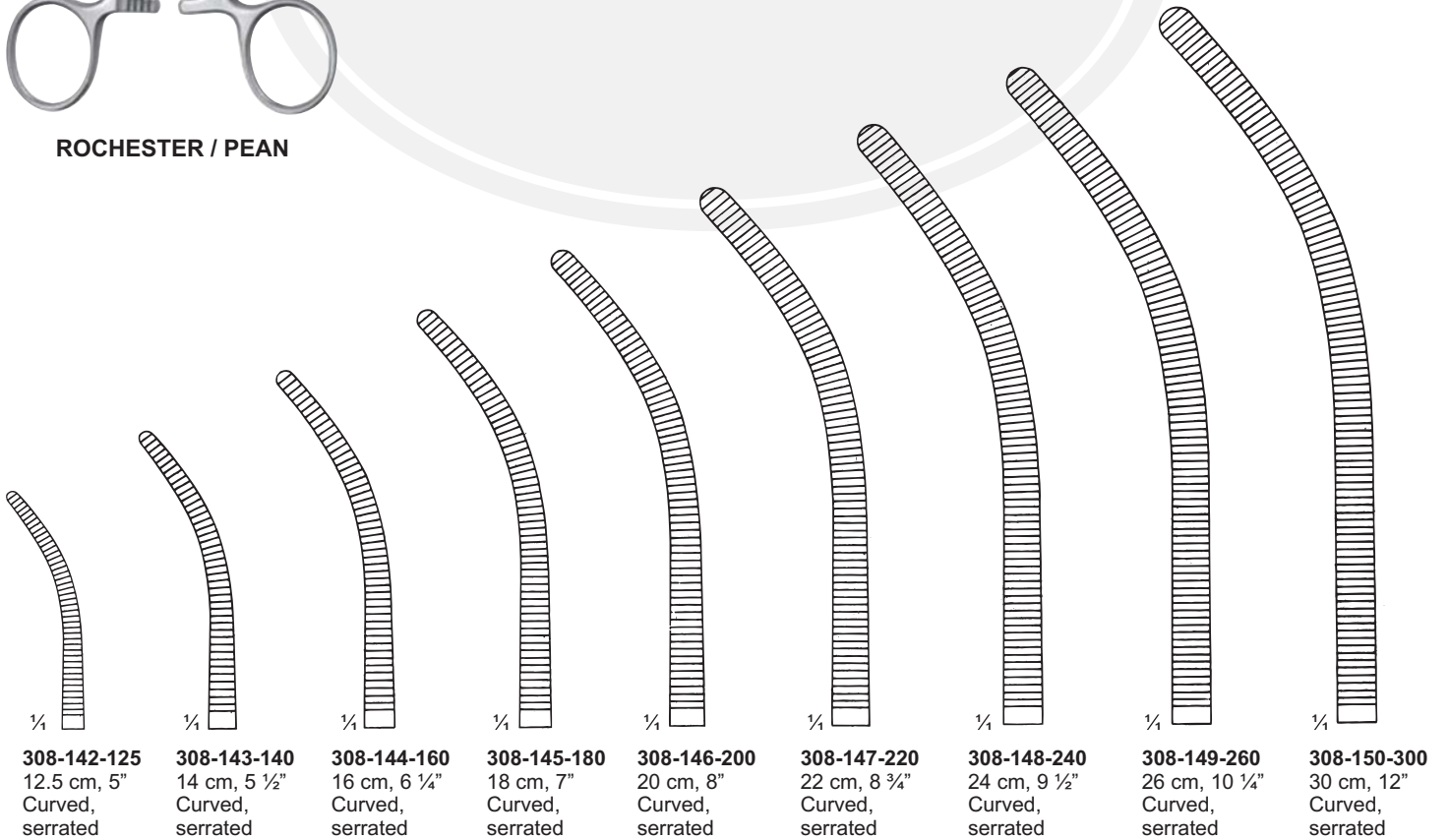
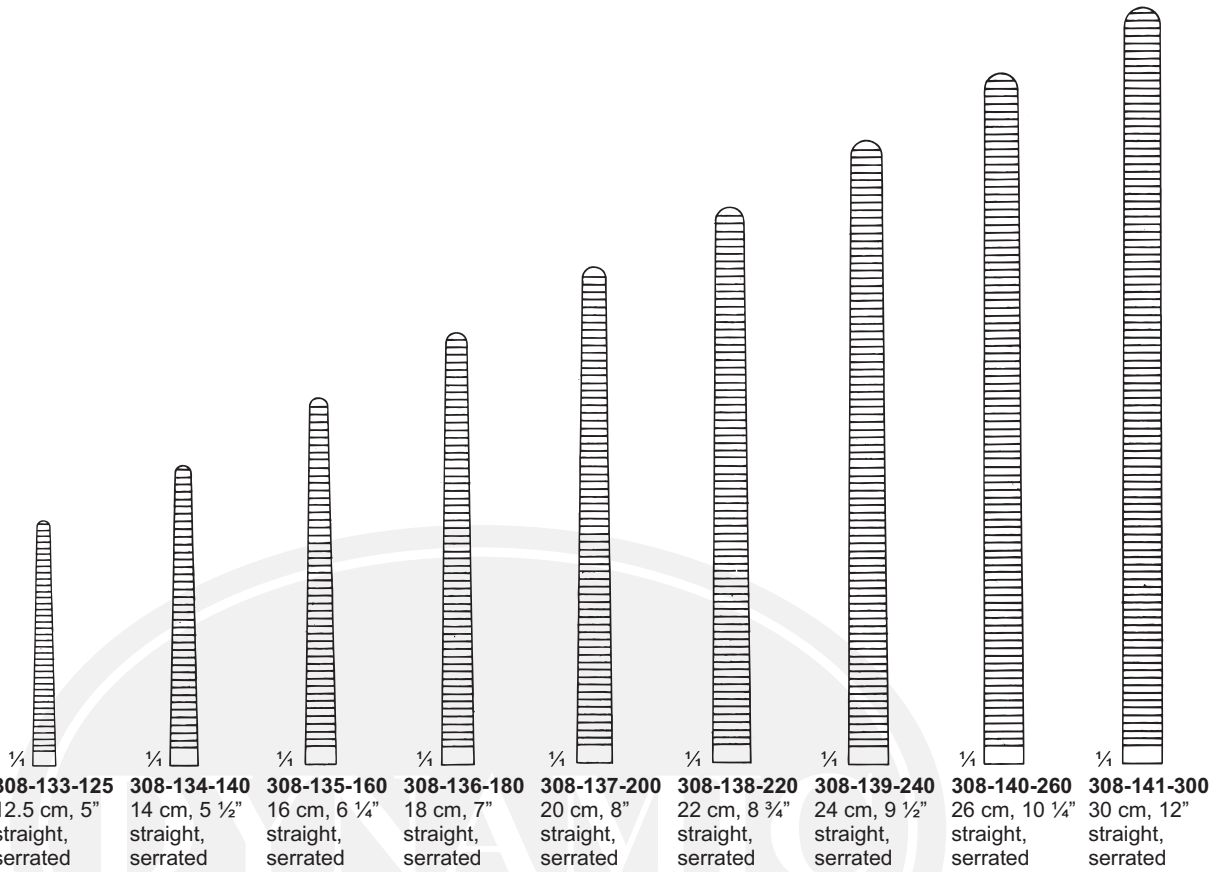



HAEMOSTATIC FORCEPS

Arterienklemmen

Pinces hemostatiques

Pinzas hemostaticas

Pinze emostatiche

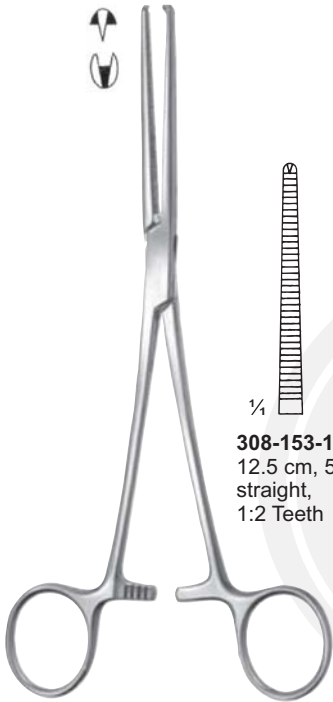

308-153-125 12.5 cm, 5" straight, 1:2 Teeth	308-154-140 14 cm, 5 1/2" straight, 1:2 Teeth	308-155-160 16 cm, 6 1/4" straight, 1:2 Teeth	308-156-180 18 cm, 7" straight, 1:2 Teeth	308-157-200 20 cm, 8" straight, 1:2 Teeth	308-158-220 22 cm, 8 3/4" straight, 1:2 Teeth	308-159-240 24 cm, 9 1/2" straight, 1:2 Teeth	308-160-260 26 cm, 10 1/4" straight, 1:2 Teeth serrated	308-161-300 30 cm, 12" straight, 1:2 Teeth serrated

ROCHESTER / OCHSNER / KOCHER

308-162-125 12.5 cm, 5" Curved, 1:2 Teeth	308-163-140 14 cm, 5 1/2" Curved, 1:2 Teeth	308-164-160 16 cm, 6 1/4" Curved, 1:2 Teeth	308-165-180 18 cm, 7" Curved, 1:2 Teeth	308-166-200 20 cm, 8" Curved, 1:2 Teeth	308-167-220 22 cm, 8 3/4" Curved, 1:2 Teeth	308-168-240 24 cm, 9 1/2" Curved, 1:2 Teeth	308-169-260 26 cm, 10 1/4" Curved, 1:2 Teeth	308-170-300 30 cm, 12" Curved, 1:2 Teeth



HAEMOSTATIC FORCEPS

Arterienklemmen

Pinces hemostatiques

Pinzas hemostaticas

Pinze emostatiche



SPENCER-WELLS



308-173-125
12.5 cm, 5"



308-174-140
14 cm, 5 1/2"



308-175-155
15.5 cm, 6"



308-176-180
18 cm, 7"



308-177-200
20 cm, 8"



308-178-125
12.5 cm, 5"



308-179-140
14 cm, 5 1/2"



308-180-155
15.5 cm, 6"



308-181-180
18 cm, 7"

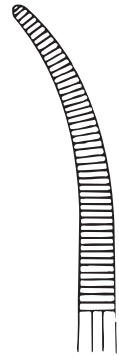

308-182-200
20 cm, 8"



KOCHER
delicate pattern



308-184-130
13 cm, 5"



308-185-140
14 cm, 5 1/2"



308-186-160
16 cm, 6 1/4"



308-187-130
13 cm, 5"



308-188-140
14 cm, 5 1/2"



308-189-160
16 cm, 6 1/4"



HAEMOSTATIC FORCEPS

Arterienklemmen

Pinces hemostatiques

Pinzas hemostaticas

Pinze emostatiche

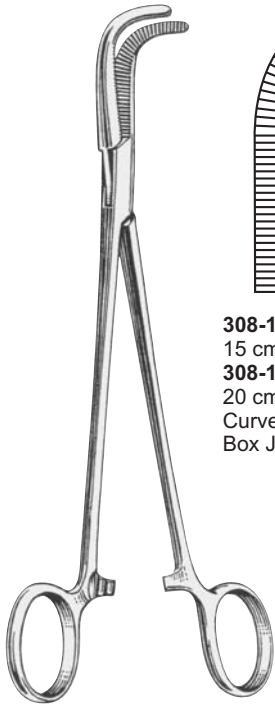

308-191-150
15 cm, 6"
308-192-200
20 cm, 8"
Curved, Flat
Box Joint.

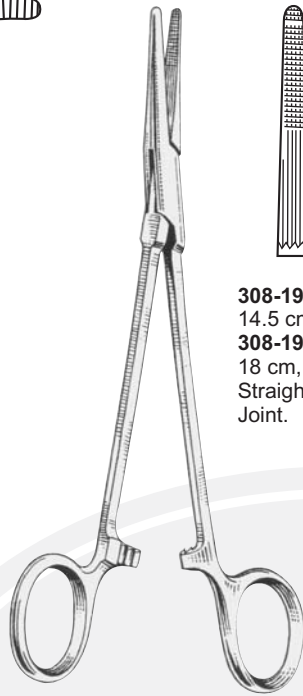
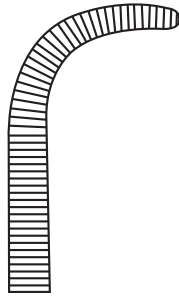

308-194-145
14.5 cm, 5 3/4"
308-195-180
18 cm, 7"
Straight
Joint.

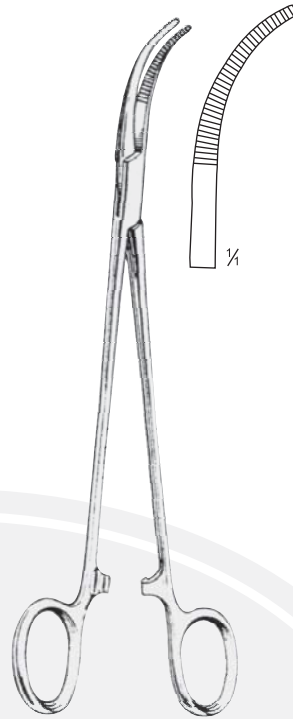

SAWTELL
308-197-185 18.5 cm, 7 1/4"
curved on flat joint

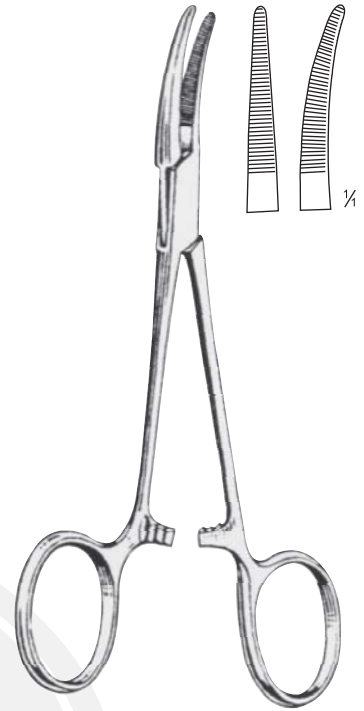
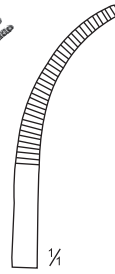

DUNHILL
308-199-130
13.0 cm, 5"
Straight, box joint, as
above but curved on flat.



CAIRNS
308-201-145
14.5 cm, 5 3/4"
Straight, box joint, as
above but curved on flat.

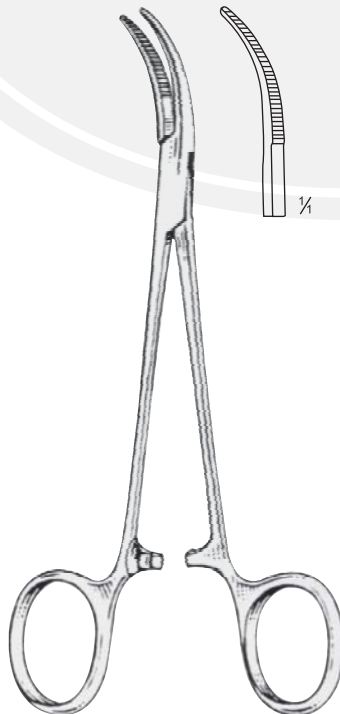

CAIRNS
308-203-145
14.5 cm, 5 3/4"
curved laterally,
joint

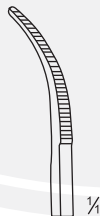

MEEKER



308-205-180
27 cm, 10 3/4"
Right Angle,
Serrated



SCHNIDT / SAWTELL



308-208-180
18 cm, 7"
Curved,
Serrated

HAEMOSTATIC FORCEPS

Arterienklemmen

Pinces hemostatiques

Pinzas hemostaticas

Pinze emostatiche



BABY-ADSON

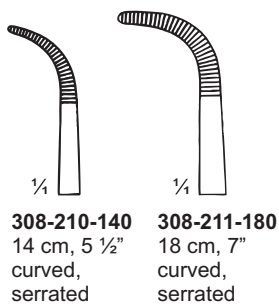

308-210-140
14 cm, 5 1/2"
curved,
serrated

308-211-180
18 cm, 7"
curved,
serrated

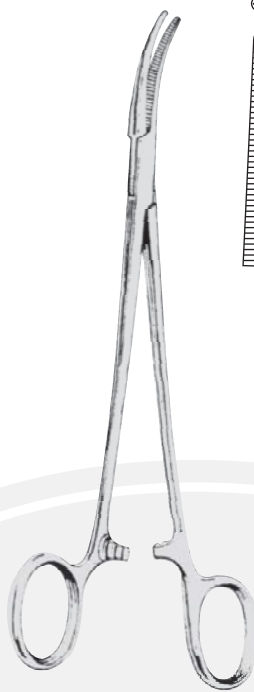

ADSON

308-213-180 18.0 cm, 7"
Straight, box joint,
as above but curved flat.
Straight, box joint,
one into two teeth

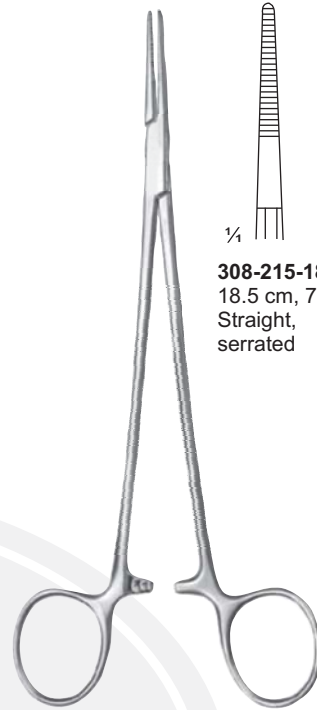
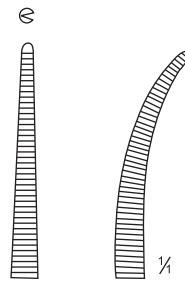

ADSON

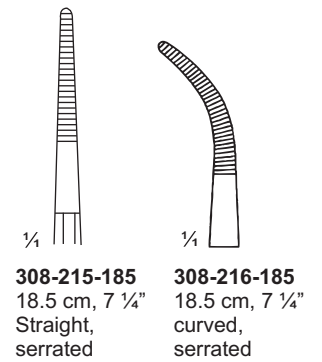

308-215-185
18.5 cm, 7 1/4"
Straight,
serrated

308-216-185
18.5 cm, 7 1/4"
curved,
serrated



ADSON 1:2

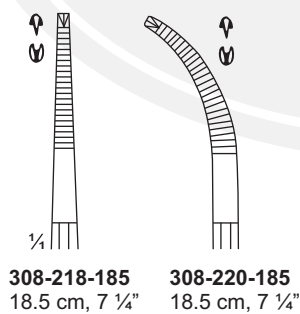

308-218-185
18.5 cm, 7 1/4"

308-220-185
18.5 cm, 7 1/4"



SAROOT

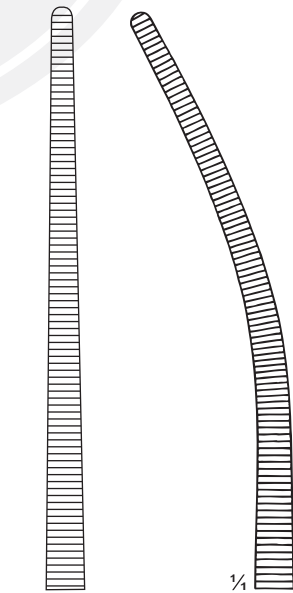

308-222-240
24 cm, 9 1/2"
Straight,
Serrated

308-223-240
24 cm, 9 1/2"
Curved,
Serrated



HAEMOSTATIC FORCEPS

Arterienklemmen

Pinces hemostatiques

Pinzas hemostaticas

Pinze emostatiche



308-225-135
13.5 cm, 5 1/4"

BABY-OVERHOLT

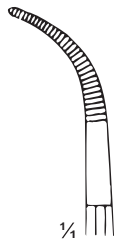

308-228-185
18.5 cm, 7 1/4"

OVERHOLT



308-230-205
20.5 cm, 8"

OVERHOLT



308-232-210
21 cm, 8 1/4"

OVERHOLT



308-234-215
21.5 cm, 8 3/4"

OVERHOLT

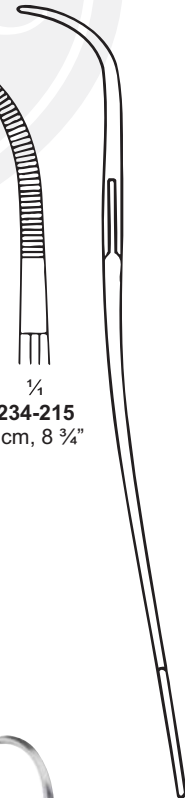

S-Shaped



HAEMOSTATIC FORCEPS

Arterienklemmen

Pinzas hemostaticas

Pinces hemostatiques

Pinze emostatiche



OVERHOLT-GEISSENDOERFER

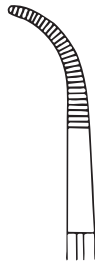

308-236-210
21 cm, 8 1/4"
308-237-270
27 cm, 10 3/4"



308-238-210
21 cm, 8 1/4"
308-239-270
27 cm, 10 3/4"



308-240-210
21 cm, 8 1/4"
308-241-270
27 cm, 10 3/4"

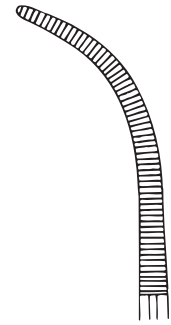

308-242-210
21 cm, 8 1/4"
308-243-270
27 cm, 10 3/4"



308-244-210
21 cm, 8 1/4"
308-245-270
27 cm, 10 3/4"

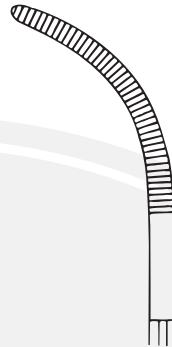

308-246-210
21 cm, 8 1/4"
308-247-270
27 cm, 10 3/4"



308-248-210
21 cm, 8 1/4"
308-249-270
27 cm, 10 3/4"



BAINBRIDGE

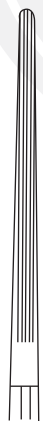

308-251-150
15 cm, 5 3/4"
308-252-185
18.5 cm, 7 1/4"



308-253-150
15 cm, 5 3/4"
308-254-185
18.5 cm, 7 1/4"

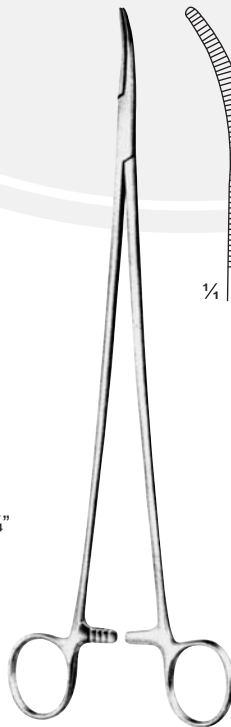

BRIDGE
308-256-280
28 cm, 11"
Curved, Serrated

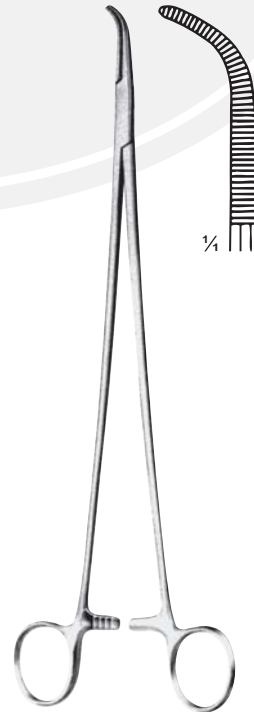

LAWRENCE
308-259-280
28.0 cm, 11"



KANTROWITZ
308-261-200 20 cm, 8"
308-262-240 24 cm, 9 1/2"
308-263-280 28 cm, 11"
Right Angle, Serrated

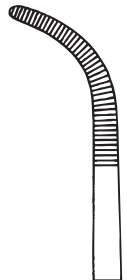



HAEMOSTATIC FORCEPS

Arterienklemmen

Pinces hemostatiques

Pinzas hemostaticas

Pinze emostatiche



MINI-GEMINI
curved, serrated

308-265-180 18 cm, 7"



308-266-220 22 cm, 8 3/4"



308-267-250 25 cm, 10"

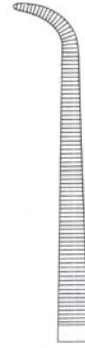

308-268-280 28 cm, 11"

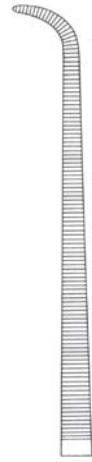

DYNAMIC



GEMINI
Curved, Serrated

308-270-130 13 cm, 5"



308-271-160 16 cm, 6 1/4"



308-272-180 18 cm, 7"



308-273-200 20 cm, 8"

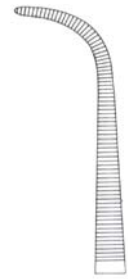

308-274-230 23 cm, 9"

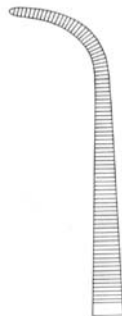

308-275-250 25 cm, 10"



308-276-280 28 cm, 11"





HAEMOSTATIC FORCEPS

Arterienklemmen

Pinces hemostatiques

Pinzas hemostaticas

Pinze emostatiche



RUMEL
23.0 cm, 9"

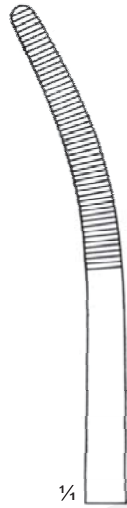

308-278-230
23.0 cm, 9"



308-279-230
23.0 cm, 9"



308-280-230
23.0 cm, 9"



308-281-230
23.0 cm, 9"

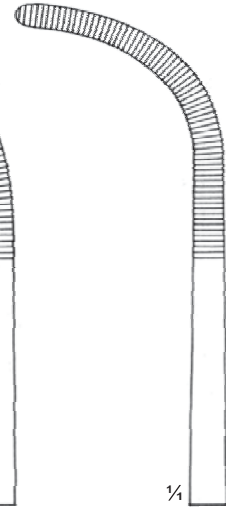

308-282-230
23.0 cm, 9"

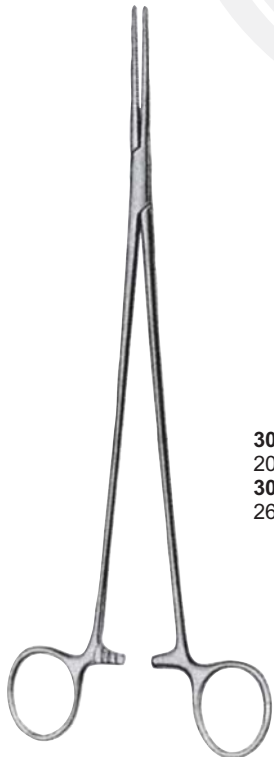

BENGOLEA



308-285-200
20 cm, 8"
308-286-260
26 cm, 10 1/4"



308-287-200
20 cm, 8"
308-288-260
26 cm, 10 1/4"



BENGOLEA 1:2



308-290-200
20 cm, 8"
308-291-260
26 cm, 10 1/4"

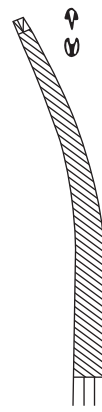

308-292-200
20 cm, 8"
308-293-260
26 cm, 10 1/4"

HAEMOSTATIC FORCEPS

Arterienklemmen

Pinces hemostatiques

Pinzas hemostaticas

Pinze emostatiche



CRAFOORD-SELLORS

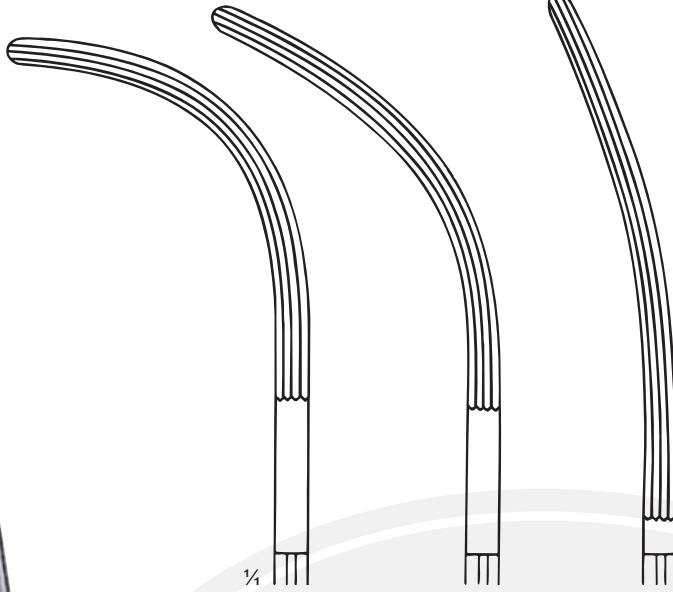

308-295-220
22.0 cm, 8 3/4"

308-296-230
23.0 cm, 9"

308-297-240
24.0 cm, 9 1/2"



ROBERTS

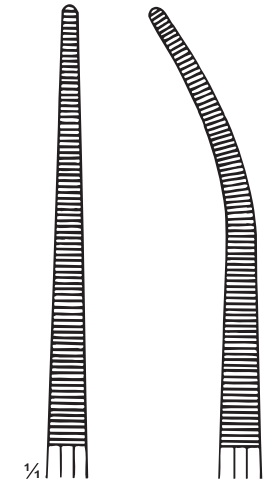

308-299-220
22.0 cm, 8 3/4"

308-300-220
22.0 cm, 8 3/4"



HEISS
20.0 cm, 8"

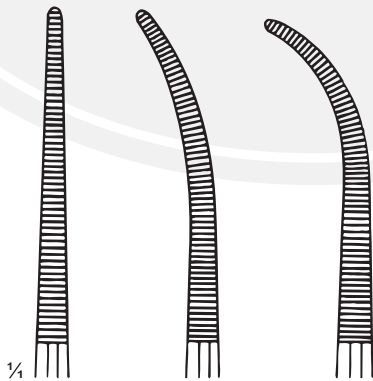
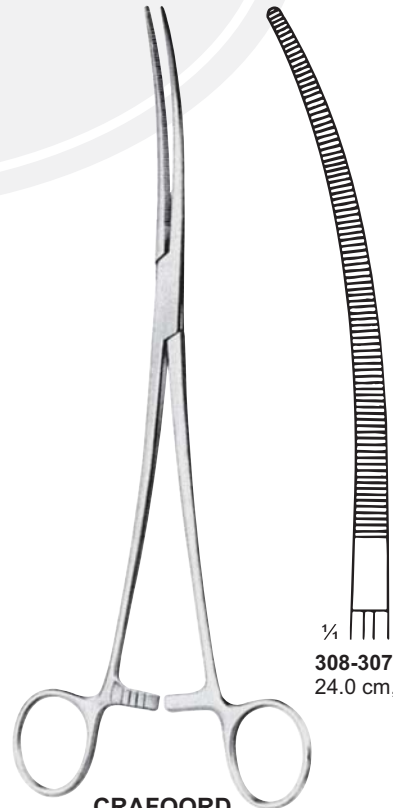

Fig.1
308-303-200

Fig.2
308-304-200

Fig.3
308-305-200



CRAFOORD

308-307-240
24.0 cm, 9 1/2"

HAEMOSTATIC FORCEPS

Arterienklemmen

Pinzas hemostaticas

Pinces hemostatiques

Pinze emostatiche



DIXON-LOVELACE
308-309-155
15.5 cm, 6"

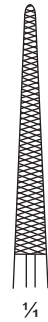

SCHNIDT-SAWTELL



308-311-190
19.0 cm, 7 ½"

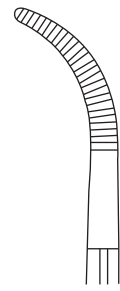

308-312-190
19.0 cm, 7 ½"



TOENNIS



308-314-210
21 cm, 8 ¼"
308-315-260
26 cm, 10 ¼"



308-316-210
21 cm, 8 ¼"
308-317-260
26 cm, 10 ¼"



TOENNIS 1:2



308-319-210
21 cm, 8 ¼"
308-320-260
26 cm, 10 ¼"

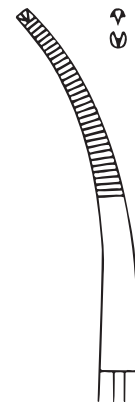

308-321-210
21 cm, 8 ¼"
308-322-260
26 cm, 10 ¼"



HAEMOSTATIC FORCEPS

Arterienklemmen

Pinces hemostatiques

Pinzas hemostaticas

Pinze emostatiche



308-325-140
14 cm, 5 1/2"
Curved,
Serrated

BABY-MIXTER



308-327-180
18.0 cm, 7"

BABY-MIXTER

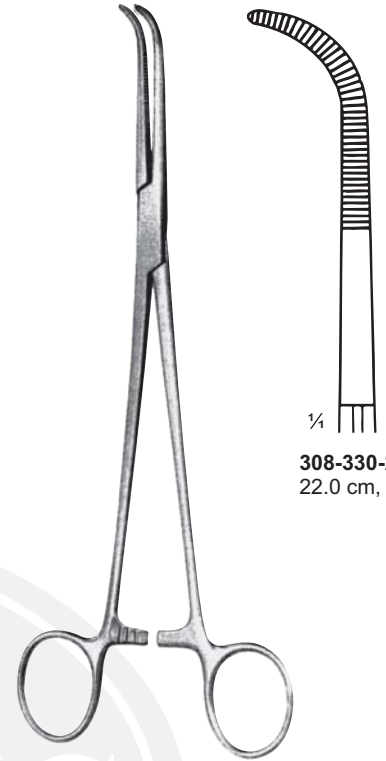

308-330-220
22.0 cm, 8 1/2"

MIXTER



MIXTER
Right Angle
Grooves

308-333-220
22 cm, 8 1/4"

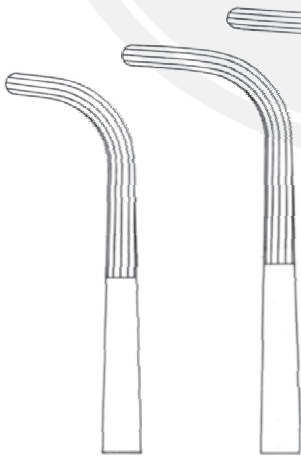

308-334-250
25 cm, 10"

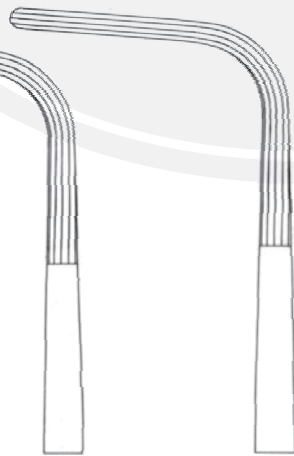

308-335-280
28 cm, 11"



MIXTER

308-337-155
15.5 cm, 6"
Fully Curved,
Serrated

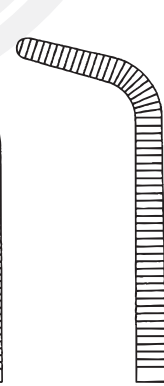

308-338-190
19 cm, 7 1/2"
Fully Curved,
Serrated

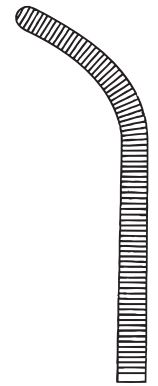

308-339-230
23 cm, 9"
Fully Curved,
Serrated

HAEMOSTATIC FORCEPS

Arterienklemmen

Pinzas hemostaticas

Pinces hemostatiques

Pinze emostatiche



¼
308-341-210
21 cm, 8 ¼"

OVERHOLT-MIXTER



308-343-155
15.5 cm, 6"

308-344-190
19.0 cm, 7 ½"

MIXTER-O'SHAUGNESSY



¼
308-347-190
19.0 cm, 7 ½"
Curved,
Grooves

LAHEY

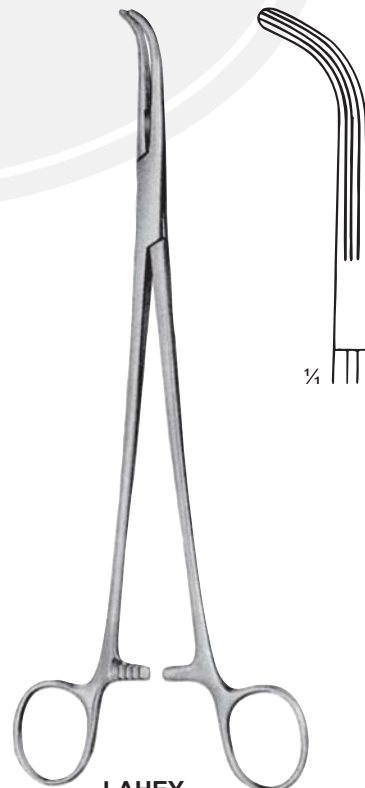

LAHEY
308-350-230
23.0 cm, 9"

HAEMOSTATIC FORCEPS

Arterienklemmen

Pinzas hemostaticas

Pinces hemostatiques

Pinze emostatiche



DEAN-SHALLCROSS



$\frac{1}{4}$
308-353-180
18 cm, 7"
S Curve,
Coarse
serration



LOWER
308-355-180
18.0 cm, 7"

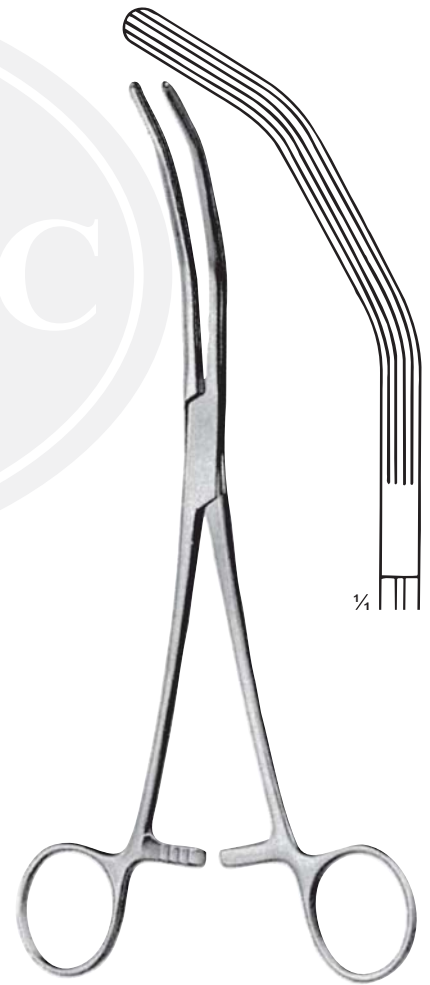

HERRICK
308-358-230
23.0 cm, 9"

$\frac{1}{4}$

HAEMOSTATIC FORCEPS

Arterienklemmen

Pinces hemostatiques

Pinzas hemostaticas

Pinze emostatiche



DANDY

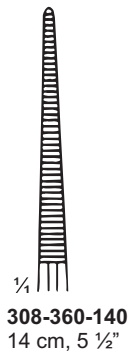

DANDY 1:2

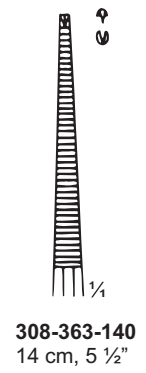

BIRKETT

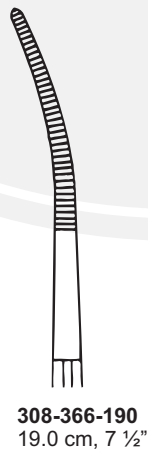
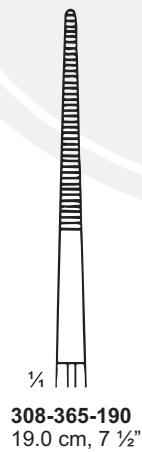

WIKSTROEM
308-368-190
19.0 cm, 7 ½"

HAEMOSTATIC FORCEPS

Arterienklemmen

Pinzas hemostaticas

Pinces hemostatiques

Pinze emostatiche



308-371-210
21 cm, 8 1/4"
light jaws

HEANEY



308-374-200
20 cm, 8"
Straight,
Serrated

HEANEY / BALLANTINE

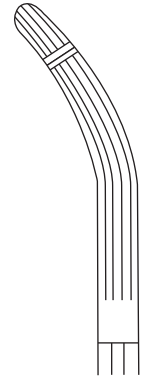

308-375-200
20 cm, 8"
Slight Curve,
Serrated



HEANEY / REZAK
308-378-210 21 cm, 8 1/4"
Straight, Cross Serrated



GARLAND
308-380-210
21 cm, 8 1/4"



HAEMOSTATIC FORCEPS

Arterienklemmen

Pinzas hemostaticas

Pinces hemostatiques

Pinze emostatiche



HEANEY



308-382-195
19.5 cm, 7 1/2"



308-383-215
21.5 cm, 8 1/2"



308-384-240
24 cm, 9 1/2"



308-385-195
19.5 cm, 7 1/2"



308-386-215
21.5 cm, 8 1/2"



308-387-240
24 cm, 9 1/2"



HEANEY-KANTER

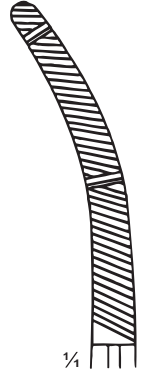

308-390-210
21 cm, 8 1/4"

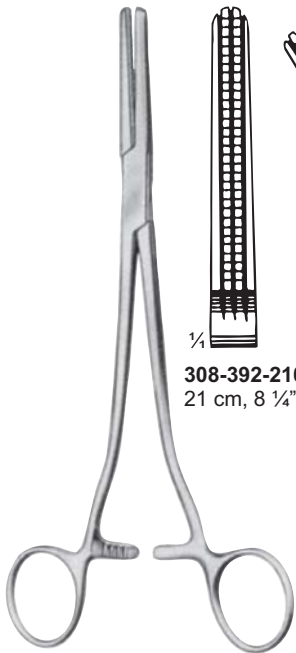

PARAMETRIUM

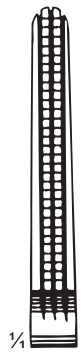

308-392-210
21 cm, 8 1/4"

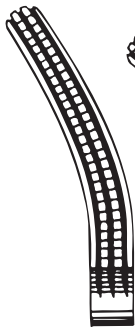

308-393-210
21 cm, 8 1/4"



308-394-210
21 cm, 8 1/4"

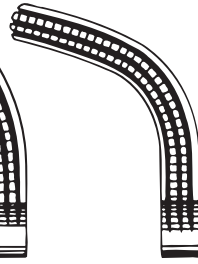

308-395-210
21 cm, 8 1/4"

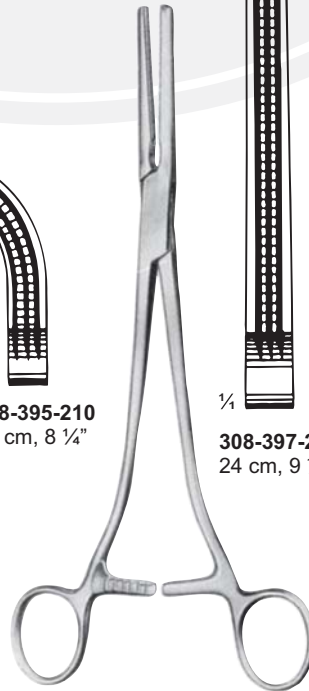

PARAMETRIUM

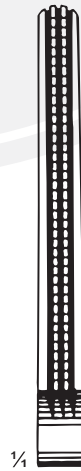

308-397-240
24 cm, 9 1/2"

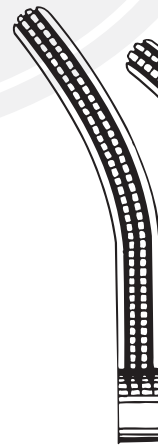

308-398-240
24 cm, 9 1/2"

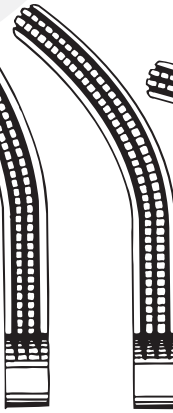

308-399-240
24 cm, 9 1/2"

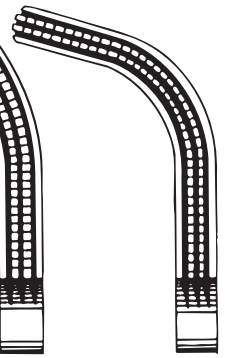

308-400-240
24 cm, 9 1/2"

HAEMOSTATIC FORCEPS

Arterienklemmen

Pinzas hemostaticas

Pinces hemostatiques

Pinze emostatiche



GUYON

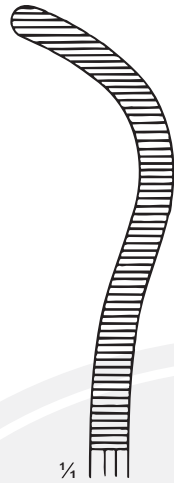

308-403-200 20 cm, 8"

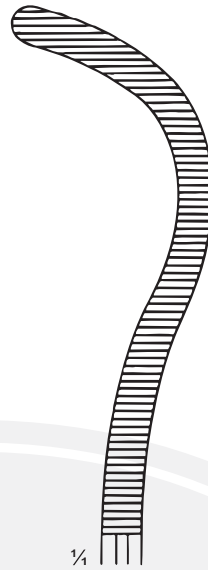

308-404-220 22 cm, 8 1/2"

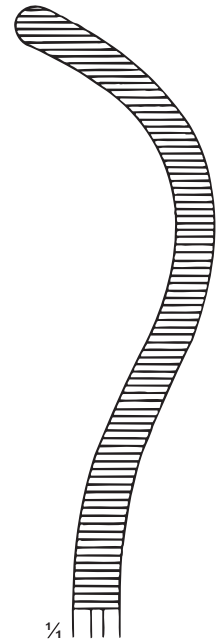

308-405-240 24 cm, 9 1/2"



GUYON

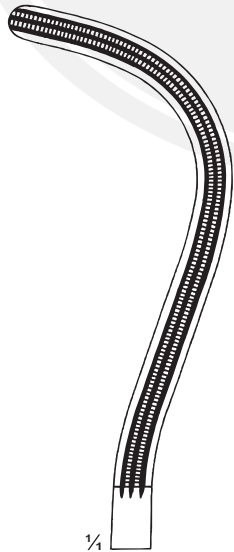

308-408-230
23 cm, 9"

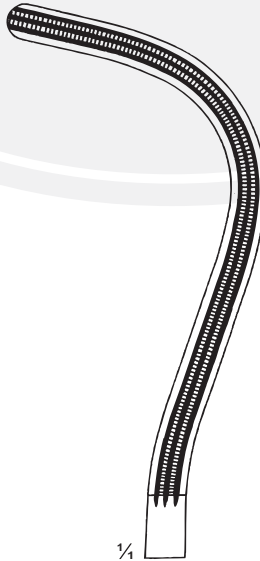

308-409-240
24 cm, 9 1/2"

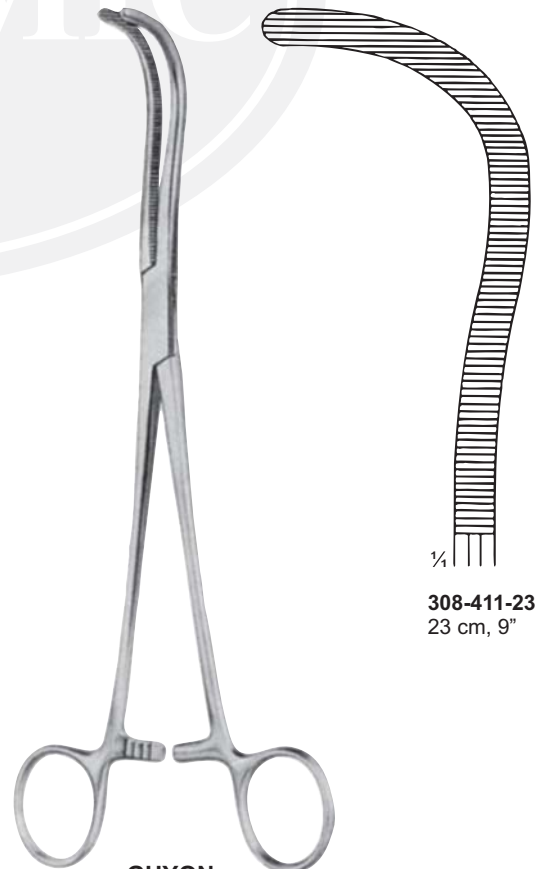

GUYON

308-411-230
23 cm, 9"

HAEMOSTATIC FORCEPS

Arterienklemmen

Pinzas hemostaticas

Pinces hemostatiques

Pinze emostatiche



308-413-190
19 cm, 7 1/2"



308-414-190
19 cm, 7 1/2"



DIXON-LOVELACE 1:2
308-416-155 15.5 cm, 6"



308-418-240
24 cm, 9 1/2"

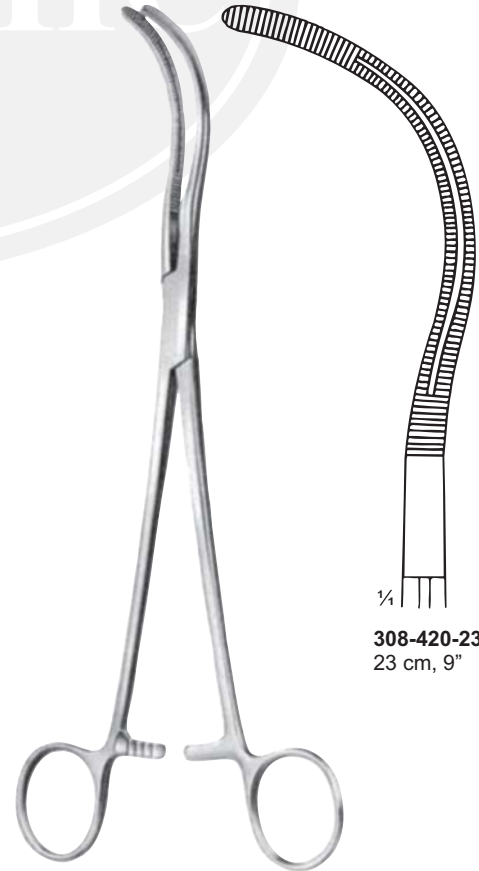

308-420-230
23 cm, 9"

FINOCCHIETTO

STILLE

HAEMOSTATIC FORCEPS

Arterienklemmen

Pinzas hemostaticas

Pinces hemostatiques

Pinze emostatiche



DESJARDINS

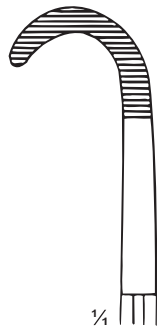

308-422-210
21 cm, 8 ¼"



JOHN HOPKINS

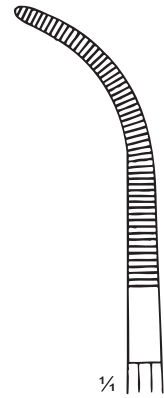

308-425-200
20 cm, 8"



ZENKER



308-427-200
20 cm, 8"

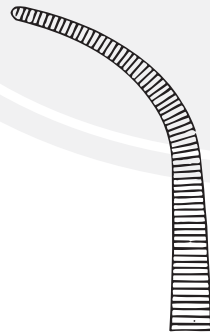

308-428-200
20 cm, 8"

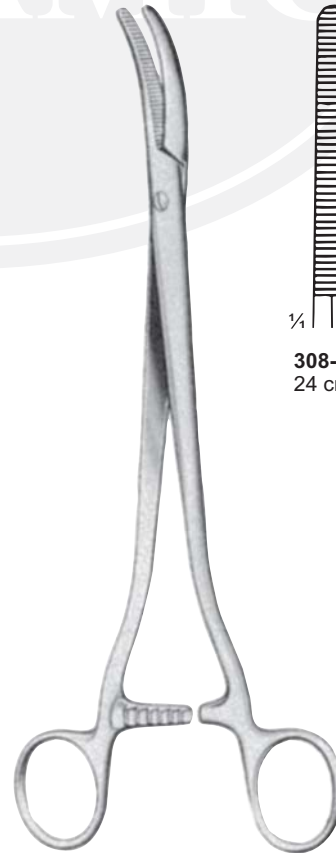

SEGOND-LANDAU



308-431-240
24 cm, 9 ½"

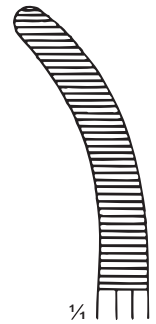

308-432-240
24 cm, 9 ½"



HAEMOSTATIC FORCEPS

Arterienklemmen

Pinces hemostatiques

Pinzas hemostaticas

Pinze emostatiche



MOYNIHAN ARTERY FORCEPS



308-435-230
23.0 cm, 9"

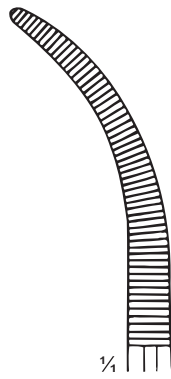

308-436-240
24.0 cm, 9 1/4"



FAURE
308-439-250
25.0 cm, 10"

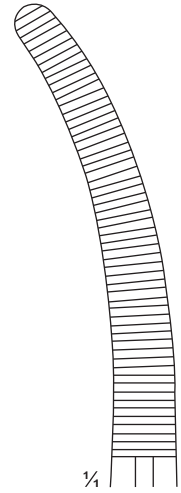

FAURE 1:2



308-442-200
20 cm, 8"
Slightly Curved



308-443-200
20 cm, 8"
More Curved



SCHINDLER 1:2

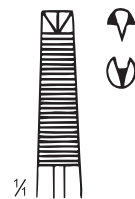

308-447-200
20 cm, 8"

HAEMOSTATIC FORCEPS

Arterienklemmen

Pinzas hemostaticas

Pinces hemostatiques

Pinze emostatiche

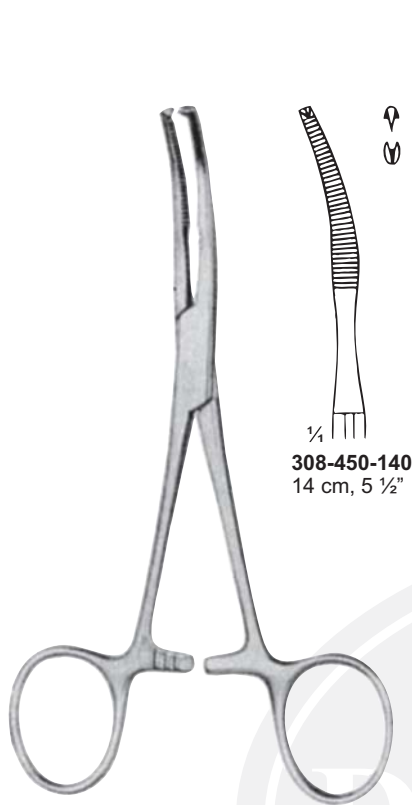

308-450-140
14 cm, 5 1/2"

BABY-MIKULICZ 1:2



308-453-180
18 cm, 7"

MIKULICZ 1:2

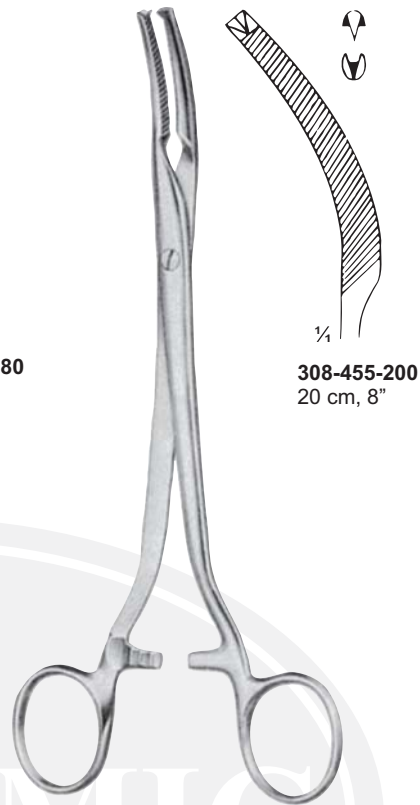

308-455-200
20 cm, 8"

MIKULICZ 1:2

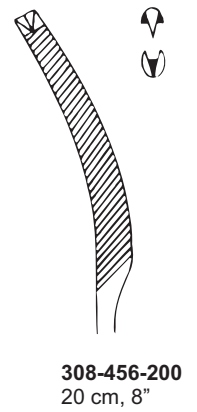

308-456-200
20 cm, 8"

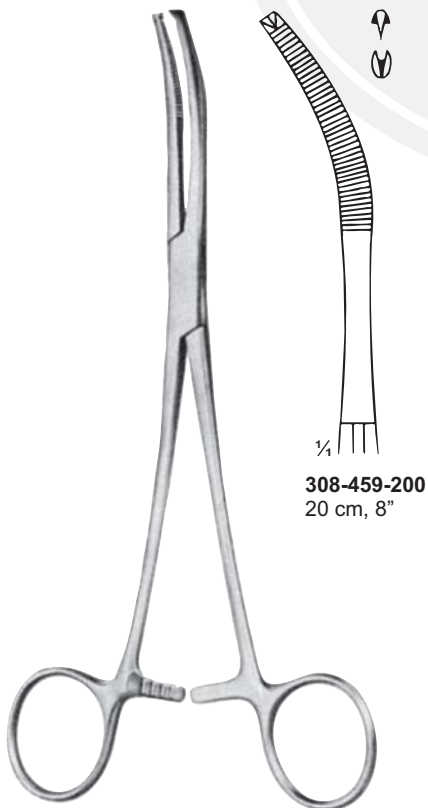

308-459-200
20 cm, 8"

MIKULICZ 1:2

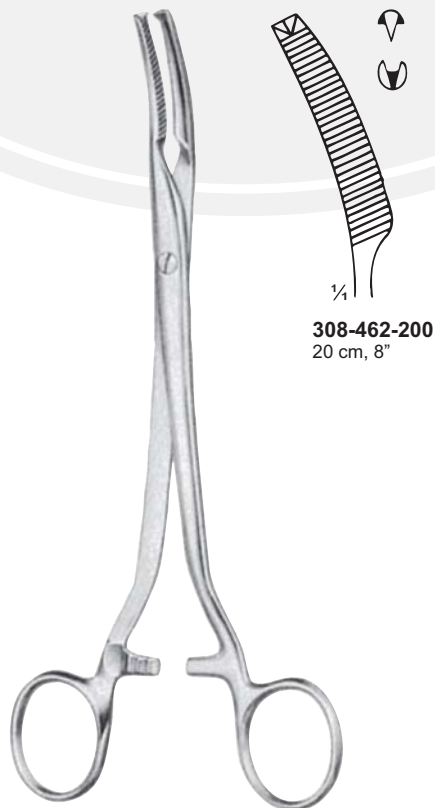

308-462-200
20 cm, 8"

MIKULICZ 1:2



308-465-230
23 cm, 9"

MIKULICZ 1:2



HAEMOSTATIC FORCEPS

Arterienklemmen

Pinzas hemostaticas

Pinces hemostatiques

Pinze emostatiche

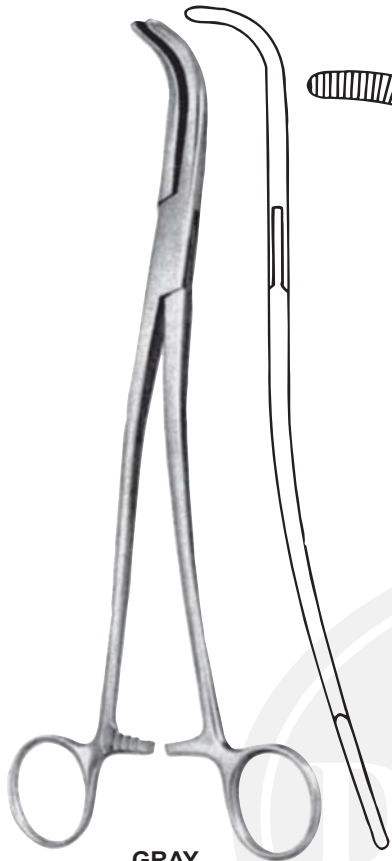

GRAY

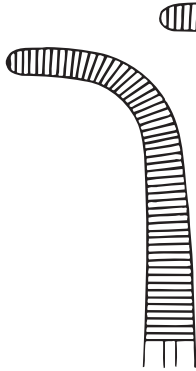

308-467-220
22 cm, 8 1/2"

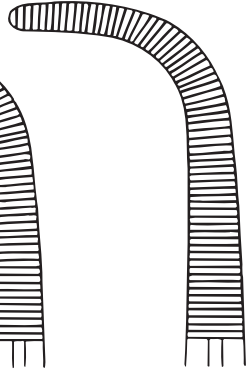

308-468-230
23 cm, 9"

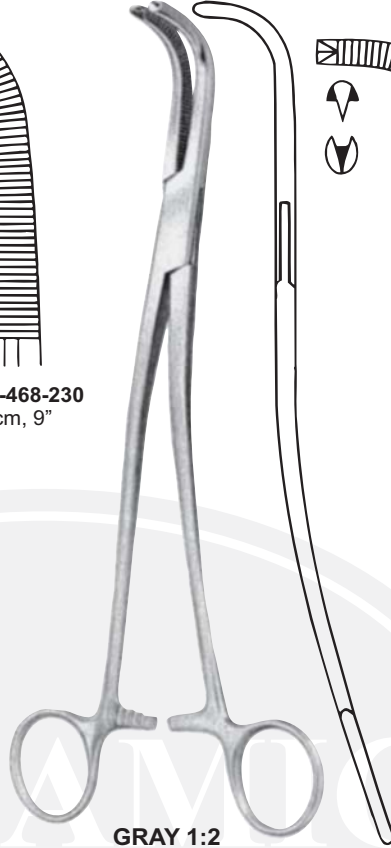

GRAY 1:2

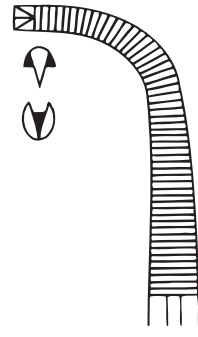

308-470-220
22 cm, 8 1/2"

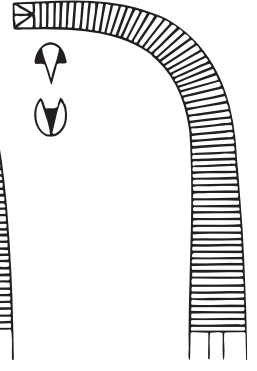

308-471-230
23 cm, 9"



PHANEUF 1:2



308-474-215
21.5 cm, 8 1/2"



308-475-215
21.5 cm, 8 1/2"



LONG
308-478-190
19.0 cm, 7 1/2"



HAEMOSTATIC FORCEPS

Arterienklemmen

Pinces hemostatiques

Pinzas hemostaticas

Pinze emostatiche



308-480-250
25 cm, 10"

WERTHEIM

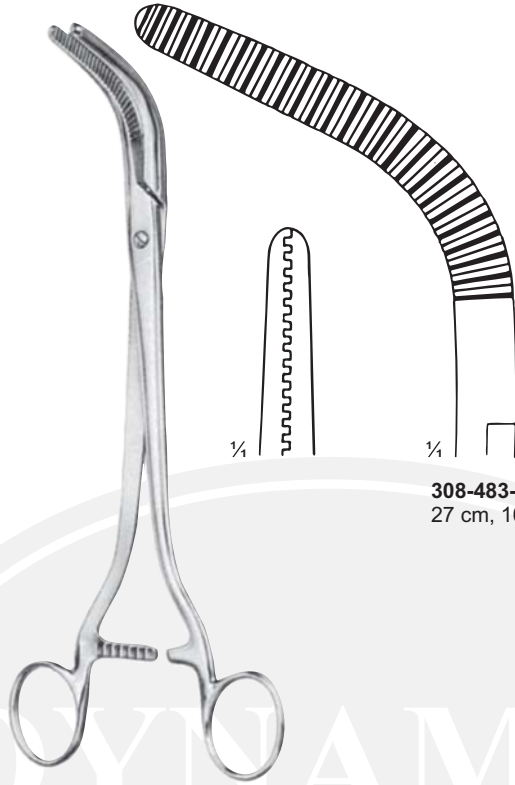

308-483-270
27 cm, 10 1/2"

WERTHEIM



308-485-215
21.5 cm, 8 1/2"

WERTHEIM-CULLEN



308-488-240
24 cm, 9 1/2"
Extra Strong

WERTHEIM 1:2



308-491-230
23 cm, 9"
slightly curved

WERTHEIM 1:2

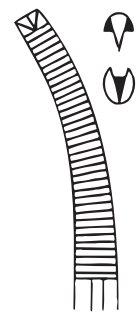

308-492-230
23 cm, 9"
more curved



HAEMOSTATIC FORCEPS

Arterienklemmen

Pinces hemostatiques

Pinzas hemostaticas

Pinze emostatiche

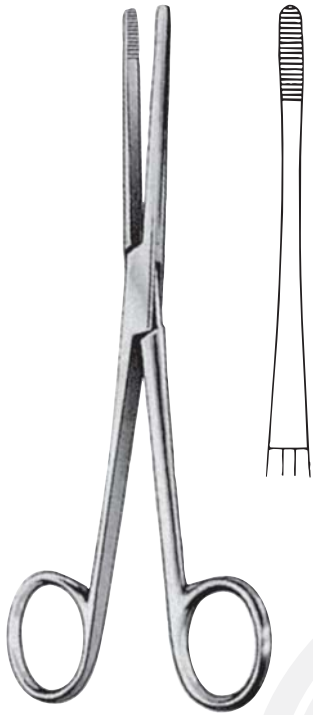

LISTER
308-494-130 13 cm, 5"
308-495-160 16 cm, 6 1/4"
308-496-180 18 cm, 7"



BOZEMANN

1/4
308-498-260
 26 cm, 10 1/4"
 Curved,
 Serrated

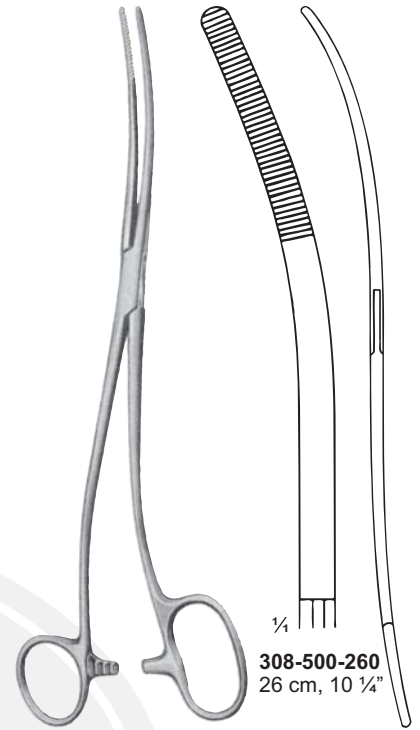

BOZEMANN-DOUGLAS

1/4
308-500-260
 26 cm, 10 1/4"



BOZEMANN

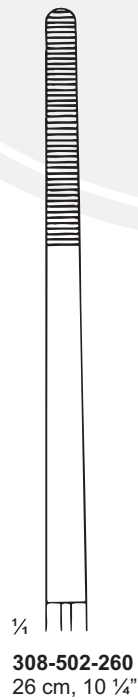

1/4
308-502-260
 26 cm, 10 1/4"

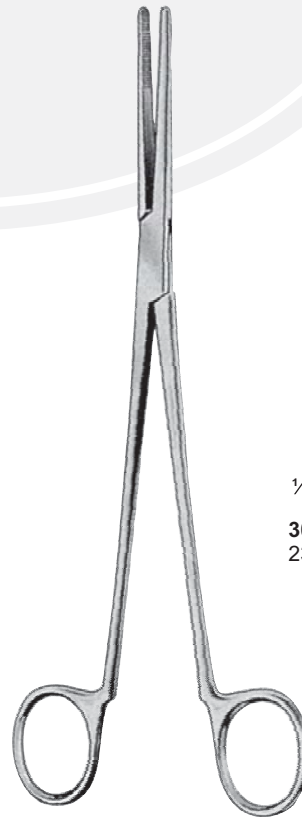

WESTERMARK

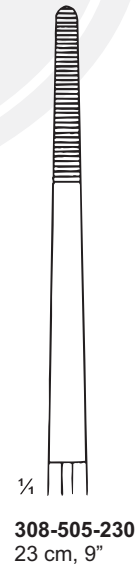

1/4
308-505-230
 23 cm, 9"

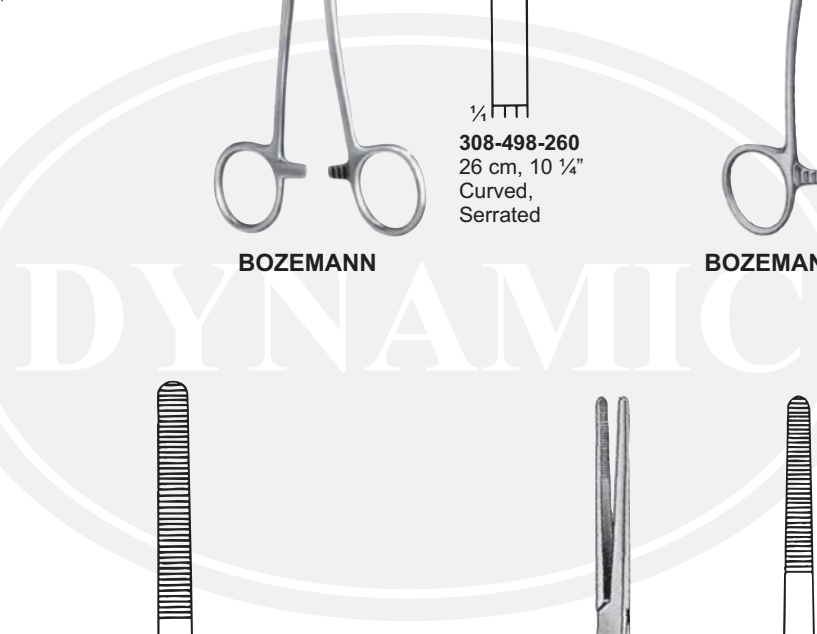



TOWEL FORCEPS

Tuchklemmen

Pinzas de campo

Pinces à champs

Pinze fissatele



JONES / PERFORATING
308-508-090
9 cm, 3 1/2"
Slight Curve



ENGL. MODELL
308-511-090
9 cm, 3 1/2"



SCHAEFFEL
308-514-090
9 cm, 3 1/2"

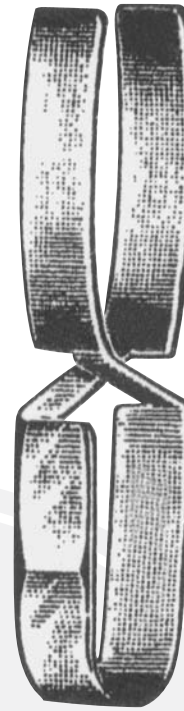

THOMSON-WALKER'S PENILE CLAMPS
308-516-090
9 cm, 3 1/2"
Cross-Action model.



DOYEN
308-517-180
18 cm, 7"



BACKHAUS
308-520-080 8 cm, 3"
308-521-110 11 cm, 4 1/2"
308-522-130 13 cm, 5"
308-523-150 15 cm, 5 3/4"
Curved



ROEDER
308-526-130 13 cm, 5"
308-527-150 15 cm, 6"
Curved, Serrated

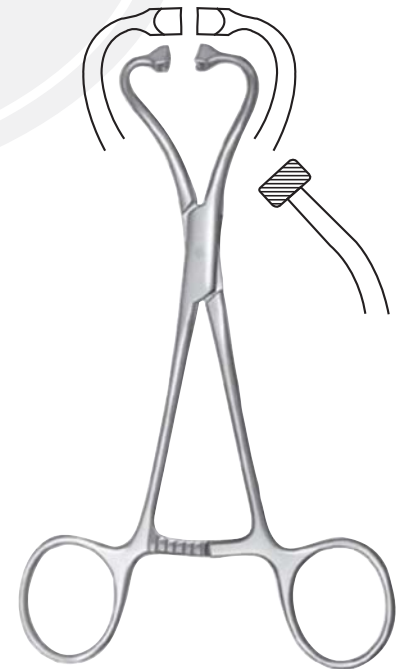

NON-PERFORATING
308-530-110 11 cm, 4 1/2"
308-531-130 13 cm, 5"



TOWEL FORCEPS

Tuchklemmen

Pinzas de campo

Pinces à champs

Pinze fissatele



LORNA
308-533-100 10 cm, 4"
308-534-110 11 cm, 4 1/2"
308-535-130 13 cm, 5"



BACKHAUS CLIP
308-537-110 11 cm, 4 1/2"
with clip for tubing or
cable



BALL & SOCKET
308-539-130 13 cm, 5"
Non-perferating



TOHOKU
308-541-100 10cm, 4"
308-542-130 13cm, 5"
Non-perferating

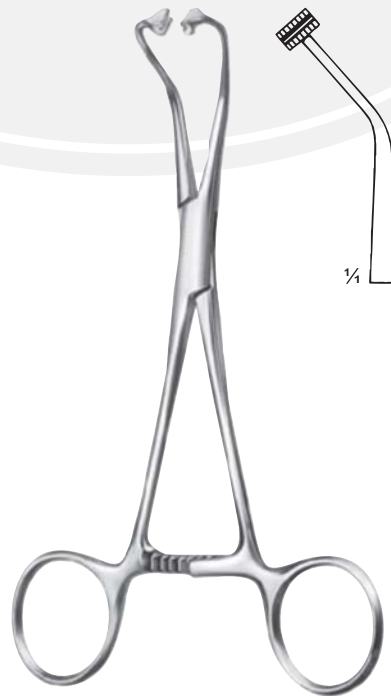

PEERS-BERTMAN
308-545-130
14.5 cm, 5 3/4"
Serrated



BERNHARD
308-548-165
16.5 cm, 6 1/2"

TUBING CLAMP

schlauchklemmen

Pinzas para tubos

Pinces presse-Tubes

Pinze serratubi



308-550-165
16.5 cm, 6 1/2"
308-551-180
18 cm, 7"
Straight, Smooth

PRESBYTERIAN

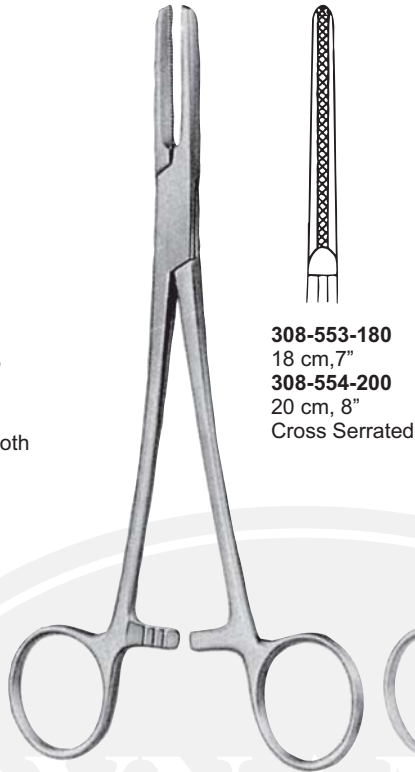

308-553-180
18 cm, 7"
308-554-200
20 cm, 8"
Cross Serrated

TUBING

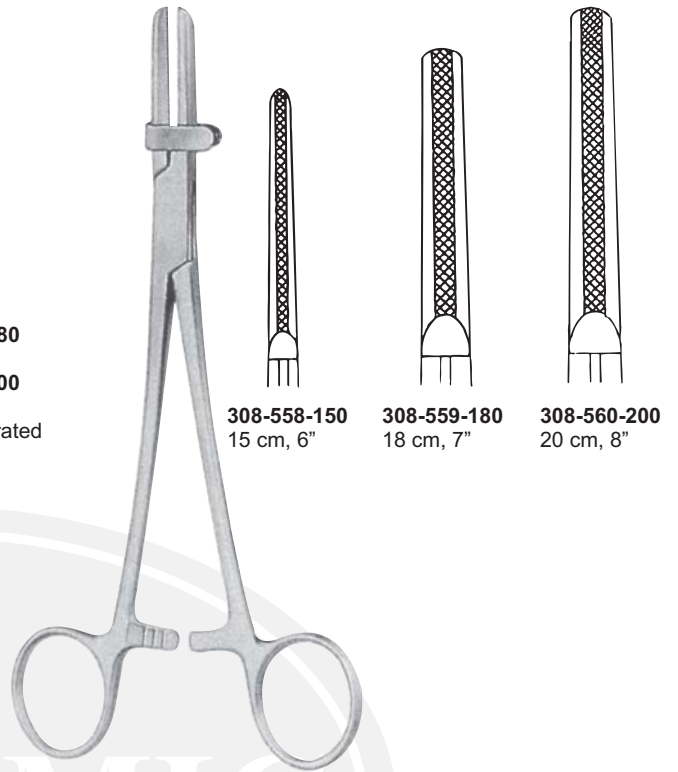

308-558-150
15 cm, 6"

308-559-180
18 cm, 7"

308-560-200
20 cm, 8"

TUBING CLUMP

308-557-000
with Protector,
Cross Serrated



308-563-145
14.5 cm, 5 3/4"
with long ratchet

KLINIKUM BERLIN

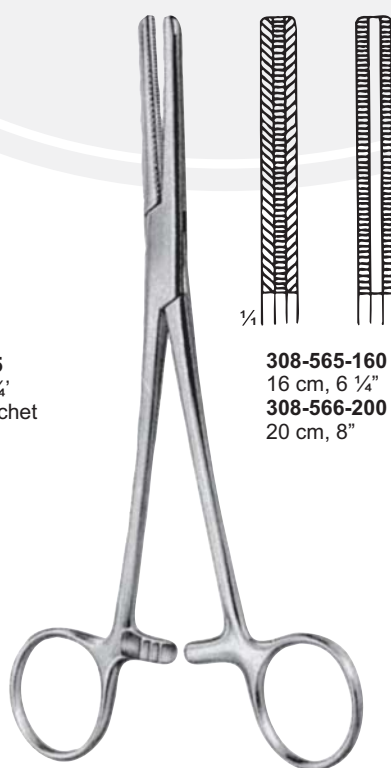

308-565-160
16 cm, 6 1/4"
308-566-200
20 cm, 8"

FERGUSSON

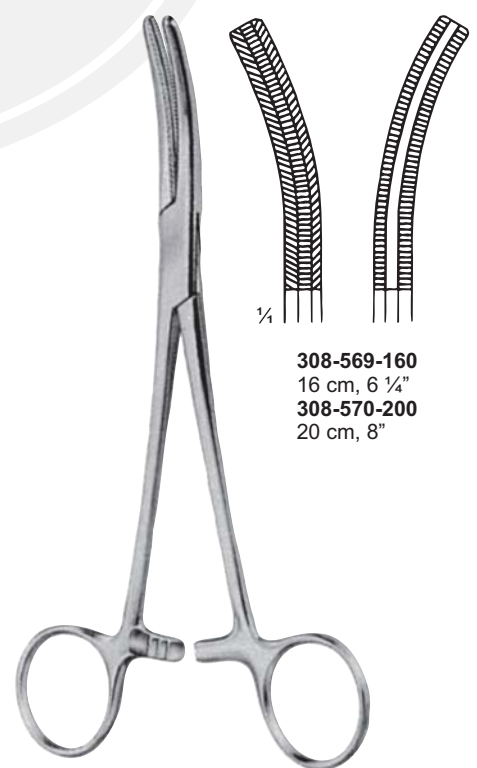

308-569-160
16 cm, 6 1/4"
308-570-200
20 cm, 8"

FERGUSSON



SPONGE FORCEPS

Schwammzange

Pince pour éponges

Pinza para tapones

Pinza per tamponi e spunge



FOERSTER-BALLEGER



308-573-170
17.75 cm, 6 3/4"
Straight, serrated

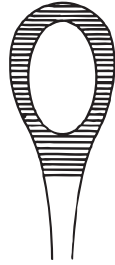

308-574-200
20.0 cm, 8"
Straight, serrated



308-575-200
20.0 cm, 8"
Straight, serrated



308-576-255
25.5 cm, 10"
Straight, Smooth



308-577-200
20.0 cm, 8"
Curved, serrated



308-578-255
25.5 cm, 10"
Curved, serrated



308-579-170
17.75 cm, 6 3/4"
Curved, serrated



308-580-255
25.5 cm, 10"
Curved, Smooth

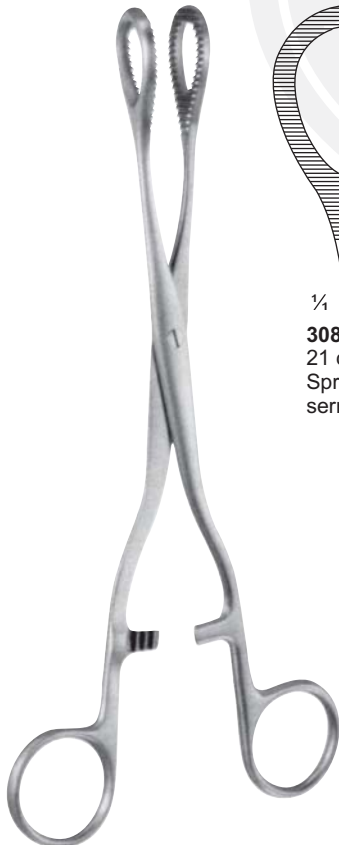

HEYWOOD-SMITH

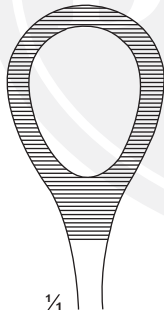

308-583-210
21 cm, 8 1/4"
Spread,
serrated



COLLIN

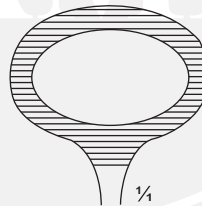

308-586-160
16 cm, 6 1/4"



HEYWOOD-SMITH

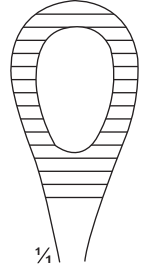

308-588-250
25 cm, 10"



SPONGE FORCEPS

Schwammzange

Pinza para tapones

Pince pour éponges

Pinza per tamponi e sponge

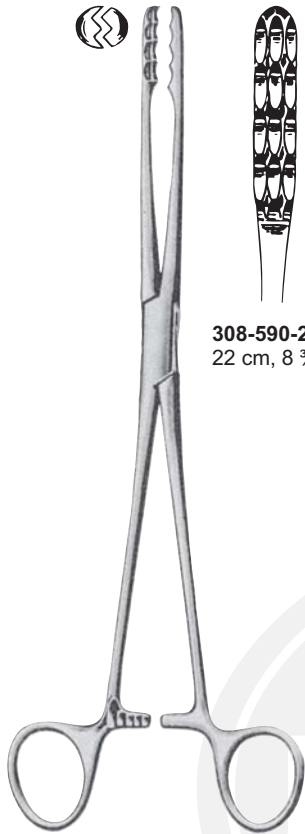

ULRICH

308-590-220
22 cm, 8 3/4"



308-591-250
25 cm, 10"
308-592-270
27 cm, 11"

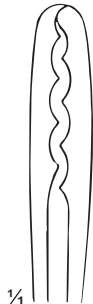

1/4



ULRICH

308-595-220
22 cm, 8 3/4"



308-596-250
25 cm, 10"
308-597-270
27 cm, 11"

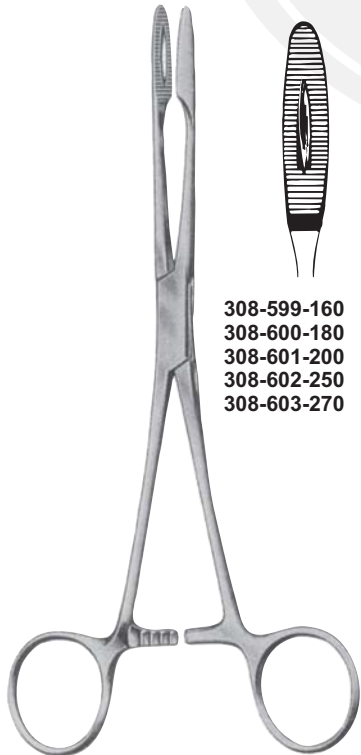

GROSS-MAIER

308-599-160 16 cm, 6 1/4"
308-600-180 18 cm, 7"
308-601-200 20 cm, 8"
308-602-250 25 cm, 10"
308-603-270 27 cm, 11"

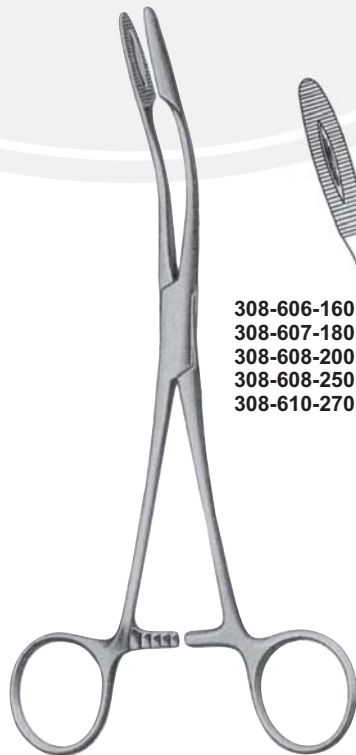

GROSS-MAIER

308-606-160 16 cm, 6 1/4"
308-607-180 18 cm, 7"
308-608-200 20 cm, 8"
308-608-250 25 cm, 10"
308-610-270 27 cm, 11"



HEYWOOD SMITH
308-613-250
25 cm, 10"



SPONGE FORCEPS

Schwammzange

Pince pour éponges

Pinza para tapones

Pinza per tamponi e spunge



$\frac{1}{4}$
308-615-240
24 cm, 9 ½"

FLETCHER



$\frac{1}{4}$
308-618-240
24 cm, 9 ½"

FLETCHER



$\frac{1}{4}$
308-621-250
18 cm, 8"

RAMPLEY



$\frac{1}{4}$
308-622-250
25 cm, 10"

SPONGE FORCEPS

Tuchklemmen

Pinzas de campo

Pinces à champs

Pinze fissatele



¼

308-625-250
25 cm, 10"

CHERON



¼

308-627-240
24 cm, 9 ½"

COLLIN



¼

308-630-240
24 cm, 9 ½"

NOTO



¼

308-632-320
32 cm, 12 ½"

KELLY



SPONGE FORCEPS

Schwammzange

Pinza para tapones

Pince pour éponges

Pinza per tamponi e sponge



¼
308-635-250
25 cm, 10"

PELKMANN



¼
308-638-250
25 cm, 10"

PELKMANN



¼
308-641-280
28 cm, 11 ¼"

SIMS-MAIER



¼
308-643-280
28 cm, 11 ¼"

SIMS-MAIER



¼
308-645-205
20.5 cm, 8"

DUPLAY



¼
308-648-205
20.5 cm, 8"

DUPLAY



FOERSTER-BALLENGER

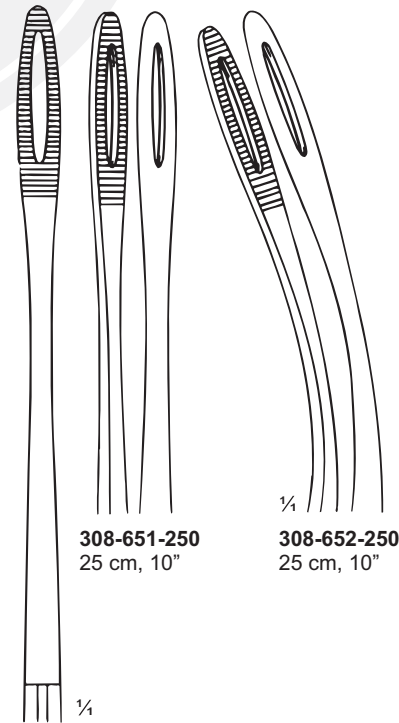

¼
308-651-250
25 cm, 10"

¼
308-652-250
25 cm, 10"