

table of contents

| | |
|----------------------|---|
| Ordering Information | 2 |
| Product Warranty | 3 |
| Finish Matrix | 4 |

Contemporary Casegoods

| | |
|------------|---------|
| Connect | 5-40 |
| Connection | 41-76 |
| a la Carte | 77-135 |
| Basics 3 | 137-168 |

Traditional Casegoods

| | |
|-------------|---------|
| Montebello | 169-204 |
| Georgian | 205-244 |
| Heritage II | 245-284 |

Conference/Reception

| | |
|------------------------------------|---------|
| Communique | 285-308 |
| Traditional Tables | 309-326 |
| Contemporary / Transitional Tables | 327-338 |
| Power Accessories | 339-343 |
| Reception Stations | 344-360 |

Online Only Series

jasperdesk.com

| |
|------------|
| a la Curve |
| Freedom |
| Heartwood |
| Kuebler |
| Metallix |
| St Clair |

ordering information and instructions

Prices

All prices herein are delivered list prices. The terms and prices in this price list supersedes all other published price lists. Prices cover standard product only. Charges for additional changes to standard product will be quoted separately upon request. Jasper Desk reserves the right to change prices and specifications without prior notice. Prices herein are domestic prices only for shipment within the 48 contiguous states of the United States.

Terms

Standard terms are 1% 15, net 30 days from date of invoice. Delinquent accounts may incur finance charges.

Ordering Information

Authorized Jasper Desk dealers may order by phone, mail, or fax. Phone orders require confirmation by written order.

Orders should be placed with: Jasper Desk Company, Inc.
225 Clay Street
Jasper, IN 47546
812.482.4132 PHONE
812.482.9552 FAX
800.365.7994 TOLL FREE

Acknowledgements

All orders will be acknowledged promptly showing how the order was entered, its approximate shipping time, and other pertinent information. Please examine all acknowledgements carefully and notify Jasper Desk immediately of any discrepancies. Jasper Desk will not be responsible for errors made on orders placed by phone without written confirmation.

Changes/Cancellations

All orders are acknowledged and are considered firm orders and therefore are not subject to change or cancellation. In the event that Jasper Desk agrees to accept a change/cancellation request prior to final production, a change/cancellation fee will be charged. Product(s) of special construction or with special finish are non-cancelable once production has begun.

Shipping Schedule

Jasper Desk is committed to the most prompt shipment possible of all of its products. Every effort is made to ship as acknowledged, however, the acknowledged ship date is approximate. We will generally ship within (5) working days of the acknowledged ship date. If a firm ship date is necessary, please let us know and we will do all we can to meet your request.

Availability

Standard products are available on a made-to-order basis, normally 6 weeks or sooner. Consult Customer Service for availability.



Products from Jasper Desk's Quickship Program are available within 10 working days from receipt of a clean, credit approved order. Large quantities may be subject to additional lead time. Quickship orders must be identified with "QS" behind model numbers in order to receive Quickship lead times.

Special Orders

Jasper Desk is among the most flexible in the industry in accommodating specialized product requirements. Should a particular need arise requiring special finish, size modification, or customization of product, contact Customer Service for quotation and lead time. Custom orders are generally shipped within 6-8 weeks. Special orders are not subject to cancellation.

Shipping - Carrier/Routing

Jasper Desk will reserve the right to select the carrier and routing, but will attempt to accommodate special requests.

Delivery and Freight Charges

Delivered pricing is dock-to-dock and does not include inside delivery or installation. All shipments must be F.O.B. point of origin, freight prepaid and allowed, to one destination within the 48 contiguous states of the United States. Shipments outside the 48 contiguous states are prepaid and allowed to port of exit. Any charges arising from failure to meet a shipment, rerouting while in transit, or carrier storage charges are not included in the pricing shown. Charges resulting from late deliveries beyond our control are not the responsibility of Jasper Desk.

Small parts orders will be shipped via UPS. On all other orders, the following minimum poundage charges apply per order.

For shipments into the states of California, Oregon, Washington, Arizona, Nevada, Idaho:

Under 2,000 lbs.....\$250.00 Net
2,000 lbs. and above.....No minimum poundage charge

For shipments into all other states excluding Alaska and Hawaii:

Under 500 lbs.....\$90.00 Net
500 lbs. and above.....No minimum poundage charge

Damaged Merchandise/Concealed Damage

All Jasper Desk products are shipped with the finest packing and cartoning, and our freight damage rate is among the lowest in the industry. Only furniture specialist carriers are used and all units are carefully inspected prior to shipment. Jasper Desk's liability for damages ceases upon receipt by the delivering carrier.

If a shipment is damaged in transit the following steps must be taken:

1. Before signing for the merchandise, make careful notation of all damages on the bill of lading and freight bill then contact factory for instruction.
2. You must file a claim with the carrier within 15 days of receipt of the shipment. Contact the carrier and request an inspection by an agent. This must be done within 15 days of delivery or the carrier will not entertain a total loss or damage claim
3. All shipping cartons must be retained for inspection by the carrier agent. Do not move items from the receiving location.
4. Contact Jasper Desk's Customer Service for an accurate estimate of replacement components, repair costs, or net cost on total loss.
5. On concealed damages the same steps should be followed. Failure to retain original cartons will result in claim denial.

Will-Call Orders

Will-Call Orders must be inspected by the customer's personnel and checked for damage. A signed Bill of Lading will be proof that the merchandise was received in good condition. If an inspection is not performed, the customer shall have no recourse for recovery of damages at a later date.

Manufacturing Defects

Claims of manufacturing defects will not be entertained without prior inspection by a Jasper Desk representative. Unauthorized deduction in payment of invoices will not be allowed.

Returns

Returns must be authorized in writing by Customer Service. Any return of product not authorized will not be accepted. If the customer orders merchandise incorrectly, we will consider a Returned Goods Authorization providing the unit has not been removed from its original factory cartoning. If authorized, the customer will be required to pay all freight expenses incurred plus a 50% restocking fee. Any products of a specialized nature may not be returned due to ordering errors.

Repair Charges

Authorization must be secured from Customer Service prior to incurring repair charges if Jasper Desk is expected to pay such charges.

Shortages

If the shipment is not delivered in accordance with the quantity of cartons and packages as shown on the Bill of Lading, do not accept it until such shortages are noted on the Bill of Lading.

Specification Changes

We reserve the right to change without notice any dimension, style or specifications of any model in Jasper Desk's product line. Dimensions shown in the price list are as accurate as possible. Actual sizes may vary up to 1" width, depth or height.

Packing and Cartoning

Jasper Desk uses the finest packing and cartoning. For special packing and cartoning requirements, contact Customer Service.

Selling Information

Possession of this price list does not in itself constitute an offer to sell. Orders can be received only from authorized Jasper Desk dealers.

warranty

Jasper Desk warrants its products to be free from defects in materials and workmanship given normal use and proper care, for a period of ten (10) years of single shift service.

Electrical components, pneumatic lifts and casters are warranted to be free from defects in materials and workmanship for the following periods of time from date of initial shipment.

Electrical components - two (2) years
Pneumatic lifts and casters - three (3) years

This warranty applies to all product manufactured December 1, 1995, and thereafter.

Jasper Desk tenders this warranty only to original purchasers acquiring our products through those parties specifically authorized by Jasper Desk to sell our product.

Repair and/or replacement, at our option, will be made on any part or parts found to be defective within the terms of the warranty.

This warranty does not cover:

- damage(s) caused by a transportation company.
- damage(s) resulting from user modification, alterations, misuse, abuse or negligent use of our product.
- natural variations in color, grain, or texture of wood and other covering materials which Jasper Desk has no control
- wearing or cuts to covering materials

Jasper Desk does not make any other warranties except as expressly set forth above, either express or implied, including any warranty of merchantability or fitness for any particular purpose, Jasper Desk shall not be liable for consequential or incidental damages under this warranty.

Further, Jasper Desk makes no warranties, express or implied, for improper assembly and/or installation of its products.

J A S P E R D E S K

STANDARD FINISH MATRIX

The matrix below provides a quick reference to standard wood finishes available on Jasper Desk Casegoods, Tables and Seating. To order, simply specify the finish name on your purchase order.

| | WOOD SPECIES | | | | | | | | | | | | | | | |
|------------------|--------------------|---------------|----------------|---------------|------------------|------------------|-----------------------------|---------------------------|------------|-------------|--------------|-----------------|-------------------|--------------|--------------------|---------------|
| | WALNUT | | | | | WHITE OAK | | | | CHERRY | | | MAPLE | | | |
| | ESPRESSO ON WALNUT | EMPIRE WALNUT | NATURAL WALNUT | ROYALE WALNUT | RICHLEIGH WALNUT | OLD WORLD WALNUT | CRESCENT MAHOGANY ON WALNUT | LANDMARK CHERRY ON WALNUT | HARBOR OAK | NATURAL OAK | AMBER CHERRY | CINNAMON CHERRY | COLLECTORS CHERRY | MOCHA CHERRY | MAHOGANY ON CHERRY | SUNRISE MAPLE |
| CASEGOODS | H | H | H | H | H | H | H | H | H | H | H | H | H | H | H | H |
| A LA CARTE | ● | ● | ● | ● | ● | ● | ● | ● | ● | ● | ● | ● | ● | ● | ● | ● |
| BASICS 3 | ● | ● | | ● | ● | ● | ● | | | ● | ● | ● | ● | ● | | |
| CONNECTION | ● | ● | ● | ● | ● | ● | ● | | ● | ● | ● | ● | ● | ● | ● | ● |
| HERITAGE II | ● | ● | | ● | ● | ● | ● | | | ● | ● | ● | ● | ● | | |
| GEORGIAN | ● | ● | ● | ● | ● | ● | ● | ● | ● | ● | ● | ● | ● | ● | | |
| MONTEBELLO | ● | ● | ● | ● | ● | ● | ● | | ● | ● | ● | ● | ● | ● | ● | ● |
| TABLES | | | | | | | | | | | | | | | | |
| COMMUNIQUE | ● | ● | ● | ● | ● | ● | ● | | ● | ● | ● | ● | ● | ● | ● | ● |
| TRADITIONAL | ● | ● | ● | ● | ● | ● | ● | ● | ● | ● | ● | ● | ● | ● | | |
| TRANSITIONAL | ● | ● | ● | ● | ● | ● | ● | ● | ● | ● | ● | ● | ● | ● | ● | ● |
| CONTEMPORARY | ● | ● | ● | ● | ● | ● | ● | ● | ● | ● | ● | ● | ● | ● | ● | ● |
| RECEPTION | | | | | | | | | | | | | | | | |
| TRADITIONAL | ● | ● | ● | ● | ● | ● | ● | ● | ● | ● | ● | ● | ● | ● | | |
| CONT./TRANS. | ● | ● | ● | ● | ● | ● | ● | ● | ● | ● | ● | ● | ● | ● | ● | ● |

KEY: H HIGH PRESSURE LAMINATE TOP (HPL) AVAILABLE AT NO UP-CHARGE

CUSTOM FINISHES

Requests for custom finish matches are welcomed on any Jasper Desk product. Please submit at least a 3" x 3" sample to the factory. Jasper Desk will supply a factory match sample for customer approval. There is a one time charge of \$298 list per order for any non-standard wood finish.

Because wood is a natural material, standard and custom finishes will exhibit some variation in grain and character.

CONNECT SERIES



Contemporary styling with a choice of 21 laminates, two edge details and three aluminum hardware selections. Can be specified with or without decorative metal inlay.

CONNECT SERIES

Laminate Available

Woodgrain Laminate



brighton - BRG



shea - SHE

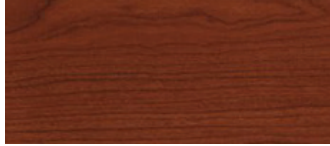

autumn - AUT

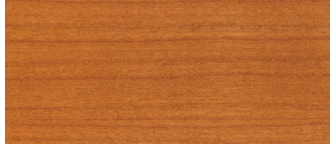

bourbon - BBN



blond echo - BLO



high line - HGL

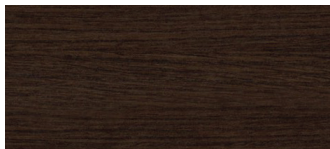

vintage - VIN



studio teak - STU



walnut heights - WLH



brazilwood - BZW



graphite - GRH



oatmeal cookie - OAT



aged ash - AGA



weathered ash - WEA

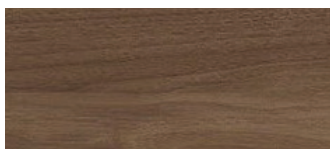

pinnacle walnut - PIN



florence walnut - FLO

Solid Color Laminate

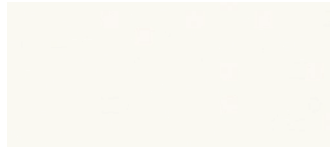

alabaster - ALB

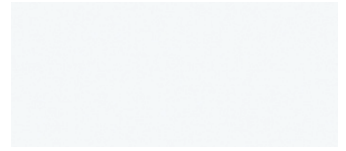

designer white - DWH

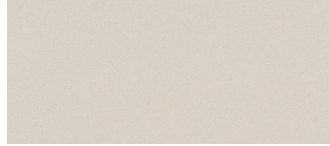

bridal blanco - BBL

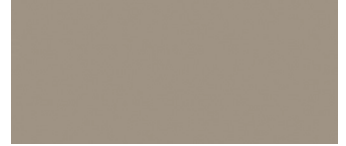

shadow - SHD



slate grey - SLG

Contrasting fronts



upgrade available to replace woodgrain surfaces on

- drawer fronts
- pedestal backs
- modesty panels
- hutch doors

CONNECT SERIES



Options Available

| | | |
|-----|---|--------------------------|
| NM | No metal Inlay on back panels | \$ -60 |
| CD | Center Drawer | \$ 374 |
| FF | Change BBF pedestal to F/F | \$ N/C |
| CPU | Change BBF or FF pedestal to CPU pedestal - inside dimensions: 14 3/16"Wx17 13/16"Dx22 3/8"H - hinged door (non-locking), two ventilation slots in back panel and inside end panel grommet | \$ 110 |
| PNT | Change lateral file or file center pedestal to printer pedestal - inside dimensions: 27 1/2"Wx17 13/16"Dx22 3/8"H - slide out printer shelf, wall access cut-out in back modesty and inside end panel grommet | \$ 110 |
| LK | Locking of individual doors, drawers or pedestals (where not standard) | \$ 55 |
| GR | Wire mgmt grommet (note location) | \$ 61 |
| WA | Wall access cut-out (modesty panels on bridges, credenzas, desks and returns) | \$ N/C |
| HB | Optional half modesty panel | \$ N/C |
| AHM | Electronic height adjustable mechanism added to worksurface, lifting column, control box, control pendant, with memory settings, motor cable, main power cable, anti-collision dongle. Lower metal lifts and anti-tip brackets. Adjusts from 30" - 44"H | Contact Customer Service |

CONNECT SERIES

Laminate

All chassis part surfaces are thermally fused melamine and have a PVC band where levelers are located.

Laminate Tops

Tops are 1 3/16" thick and feature a .050 thickness high pressure face to maximize durability. Edges feature 3/32 PVC external band and available in two different profile options.

End Panels

All panels are 3-ply balanced construction. Wing end panels feature adjustable levelers.

Modesty Panel

Panels are 3/4" thick, 3-ply balanced construction.

Drawers

Drawer side material is 3 ply 12mm vinyl wrapped particleboard with miterfold construction. Drawers are constructed with an attached drawer front.

Hardware

Drawer Suspensions - All drawers utilize "A" grade heavy duty 100% full extension metal ball bearing slide for smooth operation. Box drawers are rated for 75 lbs and file drawers are rated at 100lbs. Lateral file drawers are rated at 150 lbs.

Locks

Desk locks use pedestal locking. Individual pieces are shipped random keyed. Units may be keyed alike upon special request. Lateral files are central locking as standard and feature an anti-tip mechanism that prevents more than one drawer from being opened at a time. Locks are optional in credenza pedestals and doors and returns.

Drawer Pulls

Three sizes of Aluminum Bar pull available

Wire Management - Black rectangular grommets are standard on all returns, bridge and corner worksurfaces. Black wire access grommets are standard on all hutches and highback organizers.

Chassis Construction

Construction technique is dowel construction and reinforced with screws and wood and metal fasteners.

Filing

File drawers use an easily adjustable filing system which can be positioned to accommodate letter or legal filing.

CONNECT SERIES

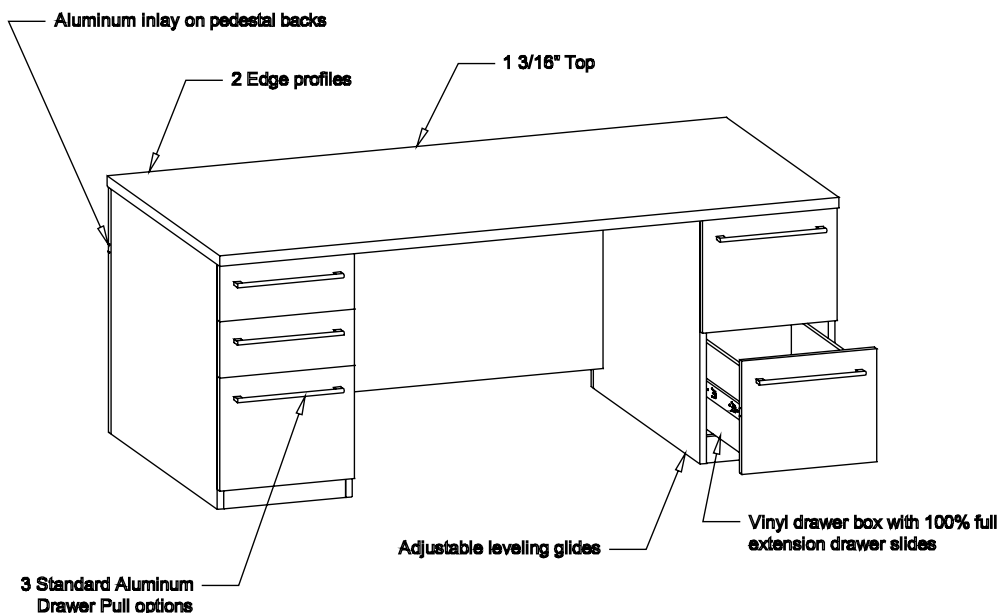

Ordering Information

Use the following steps to correctly place your order:

- 1) Determine the correct model number for the item you are selecting - example:
9500FR7236 = Double pedestal desk, 36" x 72" x 30"H
- 2) Determine the proper finish selection for the item - example:
9500FR7236-BRG = Double pedestal desk, 36" x 72" x 30"H, in Brighton
- 3) Determine the edge profile you may wish for the item - example:
9500FR7236-BRG-S = Double pedestal desk, 36" x 72" x 30"H, in Brighton, with Bead edge detail
- 4) Determine any additional options you may wish for the item - example:
9500FR7236-BRG-S-ABS = Double pedestal desk, 36" x 72" x 30"H, in Brighton, with Bead edge detail, with Aluminum Bar - Short pulls

Standard Profile Options

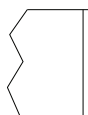

Square - A
Available on all laminates.



Bead - S
Available on:
Autumn
Brighton
Vintage
Bourbon
Shea

Standard Pull Options

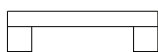

Aluminum Bar - Short
ABS



Aluminum Bar - Medium
ABM

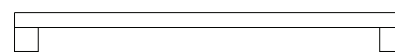

Aluminum Bar - Long
ABL

CONNECT SERIES

List Price

Double Pedestal Desks

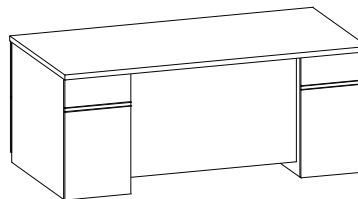

Approach side view

9500FK8442_ _ **\$2273**
 Double pedestal desk with arc conference top, box/box/file pedestal (LH), file/file pedestal (RH),
 pedestal locking, 10" center approach side overhang, stepped modesty panel
 46" W Kneespace
 42" x 84" x 30"H (455 lbs)
9500CD36 Optional Center Drawer **\$374**

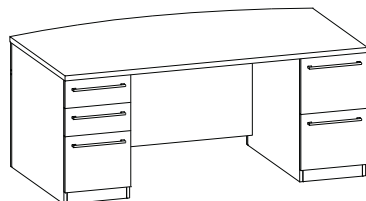

9500FK7242_ _ **\$2195**
 Double pedestal desk with arc conference top, box/box/file pedestal (LH), file/file pedestal (RH),
 pedestal locking, 10" center approach side overhang, stepped modesty panel
 40" W Kneespace
 42" x 72" x 30"H (405 lbs)
9500CD36 Optional Center Drawer **\$374**

9500FK7236_ _ **\$2090**
 Double pedestal desk with arc conference top, box/box/file pedestal (LH), file/file pedestal (RH),
 pedestal locking, 10" approach side overhang, stepped modesty panel
 40" W Kneespace
 36" x 72" x 30"H (360 lbs)
9500CD36 Optional Center Drawer **\$374**

9500FC8442_ _ **\$1869**
 Double pedestal desk with conference top, box/box/file pedestal (LH), file/file pedestal (RH),
 pedestal locking, 10" center approach side overhang, stepped modesty panel
 46" W Kneespace
 42" x 84" x 30"H (455 lbs)
9500CD36 Optional Center Drawer **\$374**

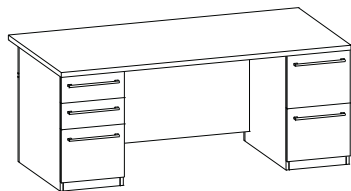

9500FC7236_ _ **\$1791**
 Double pedestal desk with conference top, box/box/file pedestal (LH), file/file pedestal (RH),
 pedestal locking, 10" center approach side overhang, stepped modesty panel
 40" W Kneespace
 36" x 72" x 30"H (405 lbs)
9500CD36 Optional Center Drawer **\$374**

9500FC6636_ _ **\$1742**
 Double pedestal desk with conference top, box/box/file pedestal (LH), file/file pedestal (RH),
 pedestal locking, 10" center approach side overhang, stepped modesty panel
 34" W Kneespace
 36" x 66" x 30"H (340 lbs)
9500CD30 Optional Center Drawer **\$374**

CONNECT SERIES

List Price

Double Pedestal Desks

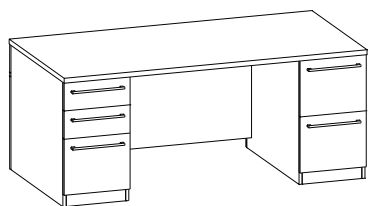

9500FR7236_ **\$1856**
 Double pedestal desk with fitted top, box/box/file pedestal (LH), file/file pedestal (RH),
 pedestal locking, recessed modesty panel
 40" W Kneespace
 36" x 72" x 30"H (365 lbs)

9500CD36 Optional Center Drawer **\$374**

9500FR7230_ **\$1815**
 Double pedestal desk with fitted top, box/box/file pedestal (LH), file/file pedestal (RH),
 pedestal locking, recessed modesty panel
 40" W Kneespace
 30" x 72" x 30"H (335 lbs)

9500CD36 Optional Center Drawer **\$374**

9500FR6636_ **\$1832**
 Double pedestal desk with fitted top, box/box/file pedestal (LH), file/file pedestal (RH),
 pedestal locking, recessed modesty panel
 34" W Kneespace
 36" x 66" x 30"H (345 lbs)

9500CD30 Optional Center Drawer **\$374**

9500FR6630_ **\$1752**
 Double pedestal desk with fitted top, box/box/file pedestal (LH), file/file pedestal (RH),
 pedestal locking, recessed modesty panel
 34" W Kneespace
 30" x 66" x 30"H (320 lbs)

9500CD30 Optional Center Drawer **\$374**

9500FR6030_ **\$1720**
 Double pedestal desk with fitted top, box/box/file pedestal (LH), file/file pedestal (RH),
 pedestal locking, recessed modesty panel
 28" W Kneespace
 30" x 60" x 30"H (305 lbs)

9500CD24 Optional Center Drawer **\$374**

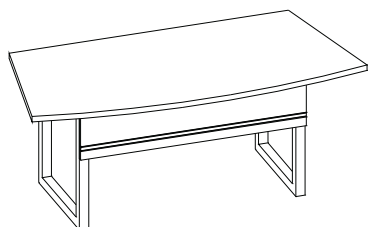

9500TK7242_ **\$1915**
 Arc top table desk with metal frame ends
 42" x 72" x 30"H (175 lbs)

9500CD36 Optional Center Drawer **\$374**

9500TK7236_ **\$1803**
 Arc top table desk with metal frame ends
 36" x 72" x 30"H (150 lbs)

9500CD36 Optional Center Drawer **\$374**

9500TK6636_ **\$1748**
 Arc top table desk with metal frame ends
 36" x 66" x 30"H (175 lbs)

9500CD30 Optional Center Drawer **\$374**

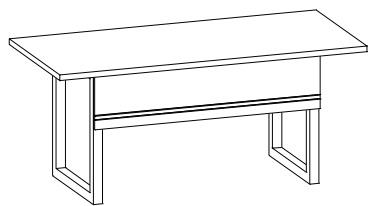

9500TD7242_ **\$1822**
 Table desk with metal frame ends
 42" x 72" x 30"H (175 lbs)

9500CD36 Optional Center Drawer **\$374**

9500TD7236_ **\$1776**
 Table desk with metal frame ends
 36" x 72" x 30"H (150 lbs)

9500CD36 Optional Center Drawer **\$374**

9500TD6630_ **\$1718**
 Table desk with metal frame ends
 30" x 66" x 30"H (125 lbs)

9500CD30 Optional Center Drawer **\$374**

CONNECT SERIES

List Price

Credenzas

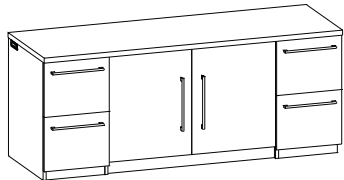

9500DC8424-4__ \$2037

Credenza with hinged door storage, two file/file pedestals (locking), hinged door storage area (non-locking) with one adjustable shelf
24" x 84" x 30"H (lbs)
Optional locking doors (LK) - add \$55 list

9500DC8420-4__ \$1972

Credenza with hinged door storage, two file/file pedestals (locking), hinged door storage area (non-locking) with one adjustable shelf
20" x 84" x 30"H (lbs)
Optional locking doors (LK) - add \$55 list

9500DC7224-4__ \$1794

Credenza with hinged door storage, two file/file pedestals (locking), hinged door storage area (non-locking) with one adjustable shelf
24" x 72" x 30"H (370 lbs)
Optional locking doors (LK) - add \$55 list

9500DC7220-4__ \$1729

Credenza with hinged door storage, two file/file pedestals (locking), hinged door storage area (non-locking) with one adjustable shelf
20" x 72" x 30"H (324 lbs)
Optional locking doors (LK) - add \$55 list

9500DC6624-4__ \$1673

Credenza with hinged door storage, two file/file pedestals (locking), hinged door storage area (non-locking) with one adjustable shelf
24" x 66" x 30"H (283 lbs)
Optional locking doors (LK) - add \$55 list

9500DC6620-4__ \$1608

Credenza with hinged door storage, two file/file pedestals (locking), hinged door storage area (non-locking) with one adjustable shelf
20" x 66" x 30"H (248 lbs)
Optional locking doors (LK) - add \$55 list

9500DC8424-3__ \$1757

Credenza with kneespace, two file/file pedestals (locking), wire mgmt grommet in ends and back
40" W kneespace
24" x 84" x 30"H (265 lbs)

9500DC8420-3__ \$1692

Credenza with kneespace, two file/file pedestals (locking), wire mgmt grommet in ends and back
40" W kneespace
20" x 84" x 30"H (265 lbs)

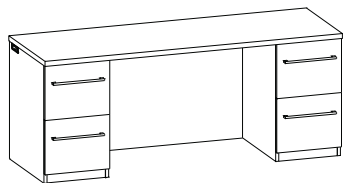

9500DC7224-3__ \$1597

Credenza with kneespace, two file/file pedestals (locking), wire mgmt grommet in ends and back
34" W kneespace
24" x 72" x 30"H (270 lbs)

9500DC7220-3__ \$1532

Credenza with kneespace, two file/file pedestals (locking), wire mgmt grommet in ends and back
34" W kneespace
20" x 72" x 30"H (236 lbs)

9500DC6624-3__ \$1517

Credenza with kneespace, two file/file pedestals (locking), wire mgmt grommet in ends and back
28" W kneespace
24" x 66" x 30"H (248 lbs)

9500DC6620-3__ \$1452

Credenza with kneespace, two file/file pedestals (locking), wire mgmt grommet in ends and back
28" W kneespace
20" x 66" x 30"H (217 lbs)

CONNECT SERIES

List Price

Storage Units

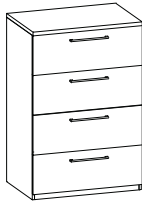

9500LF4V-3624__ _ \$1602
 Four drawer lateral file, legal or letter cross filing, central locking
 24" x 36" x 57"H (210 lbs)

9500LF4V-3620__ _ \$1570
 Four drawer lateral file, legal or letter cross filing, central locking
 20" x 36" x 57"H (184 lbs)



9500LF3V-3624__ _ \$1407
 Three drawer lateral file, legal or letter cross filing, central locking
 24" x 36" x 42"H (190 lbs)

9500LF3V-3620__ _ \$1375
 Three drawer lateral file, legal or letter cross filing, central locking
 20" x 36" x 42"H (167 lbs)



9500LF2-3624__ _ \$1086
 Two drawer lateral file, legal or letter cross filing, central locking
 24" x 36" x 30"H (155 lbs)

9500LF2-3620__ _ \$1053
 Two drawer lateral file, legal or letter cross filing, central locking
 20" x 36" x 30"H (136 lbs)

9500LF4-7224__ _ \$1924
 Double unit lateral file, legal or letter cross filing, central locking
 24" x 72" x 30"H (235 lbs)

9500LF4-7220__ _ \$1859
 Double unit lateral file, legal or letter cross filing, central locking
 20" x 72" x 30"H (235 lbs)

9500LF4-6624__ _ \$1895
 Double unit lateral file, legal or letter cross filing, central locking
 24" x 66" x 30"H (215 lbs)

9500LF4-6620__ _ \$1830
 Double unit lateral file, legal or letter cross filing, central locking
 20" x 66" x 30"H (215 lbs)

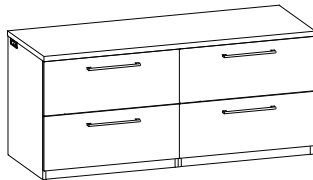

9500DSC72-24__ _ \$1738
 Four door hinged door cabinet (non-locking), one adjustable shelf per section
 24" x 72" x 30"H (300 lbs)
 Optional locking doors (LK) - add \$110 list

9500DSC72-20__ _ \$1673
 Four door hinged door cabinet (non-locking), one adjustable shelf per section
 20" x 72" x 30"H (300 lbs)
 Optional locking doors (LK) - add \$110 list

9500DSC66-24__ _ \$1666
 Four door hinged door cabinet (non-locking), one adjustable shelf per section
 24" x 66" x 30"H (260 lbs)
 Optional locking doors (LK) - add \$110 list

9500DSC66-20__ _ \$1601
 Four door hinged door cabinet (non-locking), one adjustable shelf per section
 20" x 66" x 30"H (260 lbs)
 Optional locking doors (LK) - add \$110 list

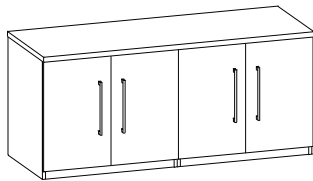

9500DSC36-24__ _ \$841
 Two door hinged door cabinet (non-locking), one adjustable shelf
 24" x 36" x 30"H (152 lbs)
 Optional locking doors (LK) - add \$55 list

9500DSC36-20__ _ \$802
 Two door hinged door cabinet (non-locking), one adjustable shelf
 20" x 36" x 30"H (133 lbs)
 Optional locking doors (LK) - add \$55 list

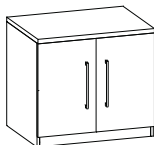

CONNECT SERIES

List Price

Storage Units

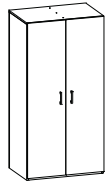

9500WC72-24_ _ **\$1669**
 Wardrobe, right side clothing carrier, left side four adjustable shelves, non-locking
 24" x 36" x 72"H (275 lbs) - Optional locking doors (LK) - add \$55 list

9500WC72-20_ _ **\$1604**
 Wardrobe, right side clothing carrier, left side four adjustable shelves, non-locking
 20" x 36" x 72"H (248 lbs) - Optional locking doors (LK) - add \$55 list

9500WC7218R-24_ _ hinged right (shown) **\$1446**

9500WC7218L-24_ _ hinged left
 Single unit wardrobe, top shelf, coat rod, non-locking left or right hinged door
 24" x 18" x 72"H (140 lbs) - Optional locking doors (LK) - add \$55 list

9500WC7218R-20_ _ hinged right (shown) **\$1397**

9500WC7218L-20_ _ hinged left
 Single unit wardrobe, top shelf, coat rod, non-locking left or right hinged door
 20" x 18" x 72"H (123 lbs) - Optional locking doors (LK) - add \$55 list

9500WSFFR-24_ _ right hand wardrobe (shown) **\$2124**

9500WSFFL-24_ _ left hand wardrobe
 Utility cabinet, wardrobe unit with hinged door (non-locking), top shelf, coat rod, file/file pedestal - bottom (locking), hinged door storage area (non-locking) with two adjustable shelves - top (right hand shown)
 24" x 36" x 72"H (350 lbs) - Optional locking doors (LK) - add \$55 list

9500WSFFR-20_ _ right hand wardrobe (shown) **\$2059**

9500WSFFL-20_ _ left hand wardrobe
 Utility cabinet, wardrobe unit with hinged door (non-locking), top shelf, coat rod, file/file pedestal - bottom (locking), hinged door storage area (non-locking) with two adjustable shelves - top (right hand shown)
 20" x 36" x 72"H (350 lbs) - Optional locking doors (LK) - add \$55 list

9500SCFF7218R-24_ _ hinged right **\$1571**

9500SCFF7218L-24_ _ hinged left (shown)
 Utility cabinet, file/file pedestal - bottom (locking), hinged door storage area (non-locking) with two adjustable shelves - top (left hand hinged door shown)
 24" x 18" x 72"H (260 lbs) - Optional locking doors (LK) - add \$55 list

9500SCFF7218R-20_ _ hinged right **\$1522**

9500SCFF7218L-20_ _ hinged left (shown)
 Utility cabinet, file/file pedestal - bottom (locking), hinged door storage area (non-locking) with two adjustable shelves - top (left hand hinged door shown)
 20" x 18" x 72"H (260 lbs) - Optional locking doors (LK) - add \$55 list

9500SC72-24_ _ **\$2015**

Storage cabinet, hinged doors (non-locking), four adjustable shelves
 24" x 36" x 72"H (285 lbs) - Optional locking doors (LK) - add \$55 list

9500SC72-20_ _ **\$1950**

Storage cabinet, hinged doors (non-locking), four adjustable shelves
 20" x 36" x 72"H (250 lbs) - Optional locking doors (LK) - add \$55 list

9500SC7218R-24_ _ hinged right (shown) **\$1596**

9500SC7218L-24_ _ hinged left
 Storage cabinet, non-locking left or right hinged door, four adjustable shelves
 24" x 18" x 72"H (140 lbs) - Optional locking doors (LK) - add \$55 list

9500SC7218R-20_ _ hinged right (shown) **\$1547**

9500SC7218L-20_ _ hinged left
 Storage cabinet, non-locking left or right hinged door, four adjustable shelves
 20" x 18" x 72"H (123 lbs) - Optional locking doors (LK) - add \$55 list

9500LF/BC-24_ _ **\$2130**

Storage cabinet / Lateral file, upper hinged door storage (non-locking) with two adjustable shelves, bottom - two lateral file drawers (locking), legal or letter filing
 24" x 36" x 72"H (310 lbs) - Optional locking doors (LK) - add \$55 list

9500LF/BC-20_ _ **\$2065**

Storage cabinet / Lateral file, upper hinged door storage (non-locking) with two adjustable shelves, bottom - two lateral file drawers (locking), legal or letter filing
 20" x 36" x 72"H (310 lbs) - Optional locking doors (LK) - add \$55 list

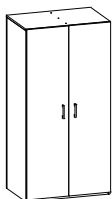
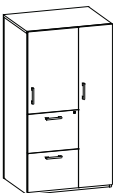

CONNECT SERIES

List Price

Corner Bookcases

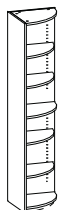

9500CBCL72-24 **\$969**

9500CBCR72-24 (shown)
 Corner Bookcase with four adjustable shelves
 24" x 18" x 72"H (140 lbs)

9500CBCL72-20 **\$912**

9500CBCR72-20 (shown)
 Corner Bookcase with four adjustable shelves
 20" x 18" x 72"H (140 lbs)

Bookcases

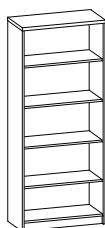

9500BC72_ **\$1061**

Open bookcase with three adjustable shelves, one fixed middle shelf and one fixed bottom shelf
 16" x 36" x 72"H (215 lbs)

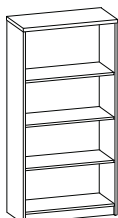

9500BC54_ **\$904**

Open bookcase with two adjustable shelves, one fixed middle shelf and one fixed bottom shelf
 16" x 36" x 54"H (160 lbs)

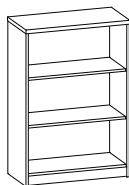

9500BC42_ **\$845**

Open bookcase with two adjustable shelves, one fixed bottom shelf
 16" x 36" x 42"H (135 lbs)

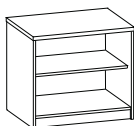

9500BC30-24_ **\$696**

Open bookcase with one adjustable shelf and one fixed bottom shelf
 24" x 32" x 30"H (132 lbs)

9500BC30-20_ **\$647**

Open bookcase with one adjustable shelf and one fixed bottom shelf
 20" x 32" x 30"H (115 lbs)

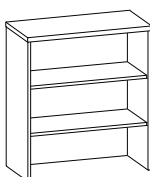

9500BCO42_ **\$553**

Stacking bookcase, two adjustable shelves
 16" x 36" x 42"H (100 lbs)

CONNECT SERIES

List Price

Computer Desk Workstations - Single Pedestal Desks

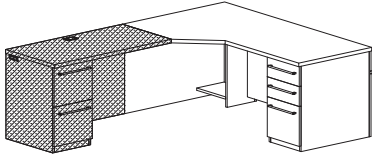
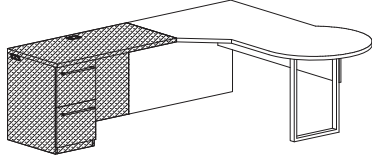
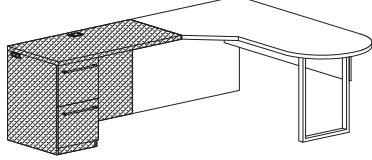
| | | |
|--|--|---------------|
| | 9500ECWSR7242-24_ _ | \$1771 |
| | Executive single pedestal computer desk (RH), box/box/file pedestal (locking), 42" corner unit, wire mgmt grommet in wing end, stepped modesty panel, for 24" return 30"- 42" x 72" x 30"H (325 lbs) | |
| | 9500ECWSR7242-20_ _ | \$1771 |
| | Executive single pedestal computer desk (RH), box/box/file pedestal (locking), 42" corner unit, wire mgmt grommet in wing end, stepped modesty panel, for 20" deep return 30"- 42" x 72" x 30"H (325 lbs) | |
| | 9500ECWSR7236-24_ _ | \$1694 |
| | Executive single pedestal computer desk (RH), box/box/file pedestal (locking), 36" corner unit, wire mgmt grommet in wing end, stepped modesty panel, for 24" deep return 24"- 36" x 72" x 30"H (325 lbs) | |
|  | 9500ECWSR7236-20_ _ | \$1694 |
| | Executive single pedestal computer desk (RH), box/box/file pedestal (locking), 36" corner unit, wire mgmt grommet in wing end, stepped modesty panel, for 20" deep return 24"- 36" x 72" x 30"H (325 lbs) | |
| | 9500ECWSR6636-24_ _ | \$1602 |
| | Executive single pedestal computer desk (RH), box/box/file pedestal (locking), 36" corner unit, wire mgmt grommet in wing end, stepped modesty panel, for 24" deep return 24"- 36" x 66" x 30"H (325 lbs) | |
| | 9500ECWSR6636-20_ _ | \$1602 |
| | Executive single pedestal computer desk (RH), box/box/file pedestal (locking), 36" corner unit, wire mgmt grommet in wing end, stepped modesty panel, for 20" deep return 24"- 36" x 66" x 30"H (325 lbs) | |
| | 9500ECWPR7242-24_ _ | \$1476 |
| | Freestanding P-Top computer desk (RH), 36" diameter end, with metal pedestal end, 42" corner unit, one wire mgmt grommet in wing end, for 24" deep return 30"-42" x 72" x 30"H (195 lbs) | |
|  | 9500ECWPR7242-20_ _ | \$1476 |
| | Freestanding P-Top computer desk (RH), 36" diameter end, with metal pedestal end, 42" corner unit, one wire mgmt grommet in wing end, for 20" deep return 30"-42" x 72" x 30"H (195 lbs) | |
| | 9500ECWBR7242-24_ _ | \$1216 |
| | Freestanding bullet top computer desk (RH), 30" diameter end, with metal pedestal end, 42" corner unit, one wire mgmt grommet in wing end, for 24" deep return 30"-42" x 72" x 30"H (195 lbs) | |
| | 9500ECWBR7242-20_ _ | \$1216 |
| | Freestanding bullet top computer desk (RH), 30" diameter end, with metal pedestal end, 42" corner unit, one wire mgmt grommet in wing end, for 20" deep return 30"-42" x 72" x 30"H (195 lbs) | |
| | 9500ECWBR7236-24_ _ | \$1121 |
| | Freestanding bullet top computer desk (RH), 30" diameter end, with metal pedestal end, 36" corner unit, one wire mgmt grommet in wing end, for 24" deep return 24"-36" x 72" x 30"H (195 lbs) | |
|  | 9500ECWBR7236-20_ _ | \$1121 |
| | Freestanding bullet top computer desk (RH), 30" diameter end, with metal pedestal end, 36" corner unit, one wire mgmt grommet in wing end, for 20" deep return 24"-36" x 72" x 30"H (195 lbs) | |
| | 9500ECWBR6636-24_ _ | \$1049 |
| | Freestanding bullet top computer desk (RH), 30" diameter end, with metal pedestal end, 36" corner unit, one wire mgmt grommet in wing end, for 24" deep return 24"-36" x 66" x 30"H (195 lbs) | |
| | 9500ECWBR6636-20_ _ | \$1049 |
| | Freestanding bullet top computer desk (RH), 30" diameter end, with metal pedestal end, 36" corner unit, one wire mgmt grommet in wing end, for 20" deep return 24"-36" x 66" x 30"H (195 lbs) | |

CONNECT SERIES

List Price

Computer Desk Workstations - Executive Returns

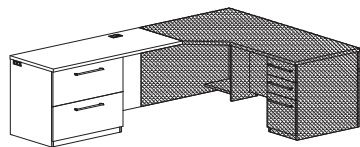

9500ERL2460LF__ \$1313

Executive height return (LH), two lateral file drawers (locking), wire mgmt grommets in top, back and end, 28"W kneespace
24" x 60" x 30"H (228 lbs)

9500ERL2060LF__ \$1268

Executive height return (LH), two lateral file drawers (locking), wire mgmt grommets in top, back and end, 28"W kneespace
20" x 60" x 30"H (208 lbs)

9500ERL2454LF__ \$1282

Executive height return (LH), two lateral file drawers (locking), wire mgmt grommets in top, back and end, 22"W kneespace
24" x 54" x 30"H (215 lbs)

9500ERL2054LF__ \$1236

Executive height return (LH), two lateral file drawers (locking), wire mgmt grommets in top, back and end, 22"W kneespace
20" x 54" x 30"H (195 lbs)

9500ERL2454__ \$1112

Executive height return (LH), file/file pedestal (locking), wire mgmt grommets in top, back and end, 38"W kneespace
24" x 54" x 30"H (140 lbs)

9500ERL2054__ \$1066

Executive height return (LH), file/file pedestal (locking), wire mgmt grommets in top, back and end, 38"W kneespace
20" x 54" x 30"H (140 lbs)

9500ERL2448__ \$1066

Executive height return (LH), file/file pedestal (locking), wire mgmt grommets in top, back and end, 32"W kneespace
24" x 48" x 30"H (140 lbs)

9500ERL2048__ \$1021

Executive height return (LH), file/file pedestal (locking), wire mgmt grommets in top, back and end, 32"W kneespace
20" x 48" x 30"H (140 lbs)

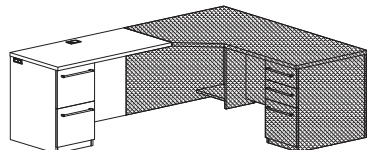

9500ERL2442__ \$1035

Executive height return (LH), file/file pedestal (locking), wire mgmt grommets in top, back and end, 26"W kneespace
24" x 42" x 30"H (140 lbs)

9500ERL2042__ \$989

Executive height return (LH), file/file pedestal (locking), wire mgmt grommets in top, back and end, 26"W kneespace
20" x 42" x 30"H (140 lbs)

9500ERL2436__ \$975

Executive height return (LH), file/file pedestal (locking), wire mgmt grommets in top, back and end, 20"W kneespace
24" x 36" x 30"H (140 lbs)

9500ERL2036__ \$930

Executive height return (LH), file/file pedestal (locking), wire mgmt grommets in top, back and end, 20"W kneespace
20" x 36" x 30"H (140 lbs)

CONNECT SERIES

List Price

Computer Desk Workstations - Single Pedestal Desks

9500ECWSL7242-24_ _ **\$1771**
 Executive single pedestal computer desk (LH), box/box/file pedestal (locking), 42" corner unit, wire mgmt grommet in wing end, stepped modesty panel, for 24" return
 30"- 42" x 72" x 30"H (325 lbs)

9500ECWSL7242-20_ _ **\$1771**
 Executive single pedestal computer desk (LH), box/box/file pedestal (locking), 42" corner unit, wire mgmt grommet in wing end, stepped modesty panel, for 20" deep return
 30"- 42" x 72" x 30"H (325 lbs)

9500ECWSL7236-24_ _ **\$1694**
 Executive single pedestal computer desk (LH), box/box/file pedestal (locking), 36" corner unit, wire mgmt grommet in wing end, stepped modesty panel, for 24" deep return
 24"- 36" x 72" x 30"H (325 lbs)

9500ECWSL7236-20_ _ **\$1694**
 Executive single pedestal computer desk (LH), box/box/file pedestal (locking), 36" corner unit, wire mgmt grommet in wing end, stepped modesty panel, for 20" deep return
 24"- 36" x 72" x 30"H (325 lbs)

9500ECWSL6636-24_ _ **\$1602**
 Executive single pedestal computer desk (LH), box/box/file pedestal (locking), 36" corner unit, wire mgmt grommet in wing end, stepped modesty panel, for 24" deep return
 24"- 36" x 66" x 30"H (325 lbs)

9500ECWSL6636-20_ _ **\$1602**
 Executive single pedestal computer desk (LH), box/box/file pedestal (locking), 36" corner unit, wire mgmt grommet in wing end, stepped modesty panel, for 20" deep return
 24"- 36" x 66" x 30"H (325 lbs)

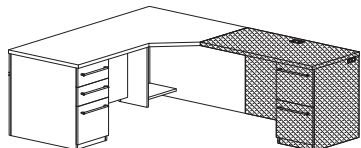

9500ECWPL7242-24_ _ **\$1476**
 Freestanding P-Top computer desk (LH), 36" diameter end, with metal pedestal end, 42" corner unit, one wire mgmt grommet in wing end, for 24" deep return
 30"-42" x 72" x 30"H (195 lbs)

9500ECWPL7242-20_ _ **\$1476**
 Freestanding P-Top computer desk (LH), 36" diameter end, with metal pedestal end, 42" corner unit, one wire mgmt grommet in wing end, for 20" deep return
 30"-42" x 72" x 30"H (195 lbs)

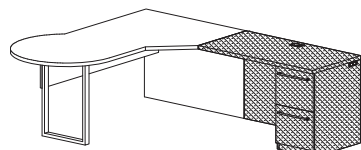

9500ECWBL7242-24_ _ **\$1216**
 Freestanding bullet top computer desk (LH), 30" diameter end, with metal pedestal end, 42" corner unit, one wire mgmt grommet in wing end, for 24" deep return
 30"-42" x 72" x 30"H (195 lbs)

9500ECWBL7242-20_ _ **\$1216**
 Freestanding bullet top computer desk (LH), 30" diameter end, with metal pedestal end, 42" corner unit, one wire mgmt grommet in wing end, for 20" deep return
 30"-42" x 72" x 30"H (195 lbs)

9500ECWBL7236-24_ _ **\$1121**
 Freestanding bullet top computer desk (LH), 30" diameter end, with metal pedestal end, 36" corner unit, one wire mgmt grommet in wing end, for 24" deep return
 24"-36" x 72" x 30"H (195 lbs)

9500ECWBL7236-20_ _ **\$1121**
 Freestanding bullet top computer desk (LH), 30" diameter end, with metal pedestal end, 36" corner unit, one wire mgmt grommet in wing end, for 20" deep return
 24"-36" x 72" x 30"H (195 lbs)

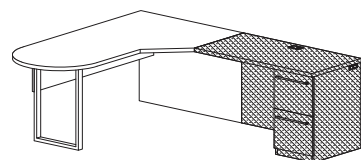



9500ECWBL6636-24_ _ **\$1049**
 Freestanding bullet top computer desk (LH), 30" diameter end, with metal pedestal end, 36" corner unit, one wire mgmt grommet in wing end, for 24" deep return
 24"-36" x 66" x 30"H (195 lbs)

9500ECWBL6636-20_ _ **\$1049**
 Freestanding bullet top computer desk (LH), 30" diameter end, with metal pedestal end, 36" corner unit, one wire mgmt grommet in wing end, for 20" deep return
 24"-36" x 66" x 30"H (195 lbs)

CONNECT SERIES

List Price

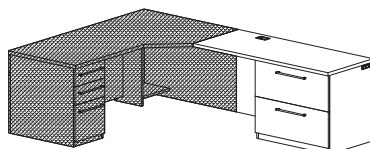
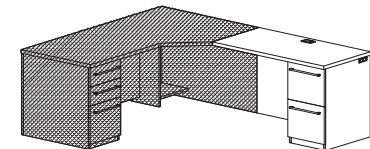
Computer Desk Workstations - Executive Returns

| | | |
|---|---|---------------|
|  | 9500ERR2460LF__ | \$1313 |
| | Executive height return (RH), two lateral file drawers (locking), wire mgmt grommets in top, back and end, 28"W kneespace 24" x 60" x 30"H (228 lbs) | |
| | 9500ERR2060LF__ | \$1268 |
| | Executive height return (RH), two lateral file drawers (locking), wire mgmt grommets in top, back and end, 28"W kneespace 20" x 60" x 30"H (208 lbs) | |
|  | 9500ERR2454LF__ | \$1282 |
| | Executive height return (RH), two lateral file drawers (locking), wire mgmt grommets in top, back and end, 22"W kneespace 24" x 54" x 30"H (215 lbs) | |
| | 9500ERR2054LF__ | \$1236 |
| | Executive height return (RH), two lateral file drawers (locking), wire mgmt grommets in top, back and end, 22"W kneespace 20" x 54" x 30"H (195 lbs) | |
|  | 9500ERR2454__ | \$1112 |
| | Executive height return (RH), file/file pedestal (locking), wire mgmt grommets in top, back and end, 38"W kneespace 24" x 54" x 30"H (140 lbs) | |
| | 9500ERR2054__ | \$1066 |
| | Executive height return (RH), file/file pedestal (locking), wire mgmt grommets in top, back and end, 38"W kneespace 20" x 54" x 30"H (140 lbs) | |
| | 9500ERR2448__ | \$1066 |
| | Executive height return (RH), file/file pedestal (locking), wire mgmt grommets in top, back and end, 32"W kneespace 24" x 48" x 30"H (140 lbs) | |
| | 9500ERR2048__ | \$1021 |
| | Executive height return (RH), file/file pedestal (locking), wire mgmt grommets in top, back and end, 32"W kneespace 20" x 48" x 30"H (140 lbs) | |
| | 9500ERR2442__ | \$1035 |
| | Executive height return (RH), file/file pedestal (locking), wire mgmt grommets in top, back and end, 26"W kneespace 24" x 42" x 30"H (140 lbs) | |
| 9500ERR2042__ | \$989 | |
| Executive height return (RH), file/file pedestal (locking), wire mgmt grommets in top, back and end, 26"W kneespace 20" x 42" x 30"H (140 lbs) | | |
| 9500ERR2436__ | \$975 | |
| Executive height return (RH), file/file pedestal (locking), wire mgmt grommets in top, back and end, 20"W kneespace 24" x 36" x 30"H (140 lbs) | | |
| 9500ERR2036__ | \$930 | |
| Executive height return (RH), file/file pedestal (locking), wire mgmt grommets in top, back and end, 20"W kneespace 20" x 36" x 30"H (140 lbs) | | |

CONNECT SERIES

List Price

Executive Workstations - Single Pedestal Desks

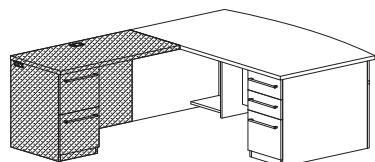

9500KSPR7242_ _ **\$1791**
 Executive single pedestal desk (RH) with arc conference top, box/box/file pedestal (locking),
 10" center overhang, stepped modesty panel
 42" x 72" x 30"H (335 lbs)

9500KSPR7236_ _ **\$1687**
 Executive single pedestal desk (RH) with arc conference top, box/box/file pedestal (locking),
 10" center overhang, stepped modesty panel
 36" x 72" x 30"H (305 lbs)

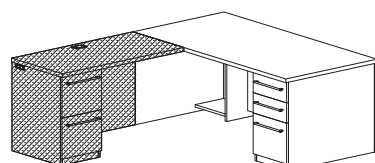

9500SPR7236_ _ **\$1597**
 Executive single pedestal desk (RH), box/box/file pedestal (locking),
 6" center overhang, stepped modesty panel
 36" x 72" x 30"H (330 lbs)

9500SPR7230_ _ **\$1508**
 Executive single pedestal desk (RH), box/box/file pedestal (locking),
 6" center overhang, stepped modesty panel
 30" x 72" x 30"H (300 lbs)

9500SPR6636_ _ **\$1572**
 Executive single pedestal desk (RH), box/box/file pedestal (locking),
 6" center overhang, stepped modesty panel
 36" x 66" x 30"H (290 lbs)

9500SPR6630_ _ **\$1492**
 Executive single pedestal desk (RH), box/box/file pedestal (locking),
 6" center overhang, stepped modesty panel
 30" x 66" x 30"H (275 lbs)

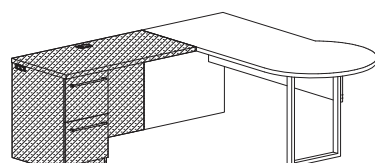

9500WSP7236R_ _ **\$1346**
 P Top worksurface (RH), 42" radius end, back panel and metal pedestal end
 36" x 72" x 30"H (190 lbs)

9500WSP6636R_ _ **\$1216**
 P Top worksurface (RH), 42" radius end, back panel and metal pedestal end
 36" x 66" x 30"H (172 lbs)

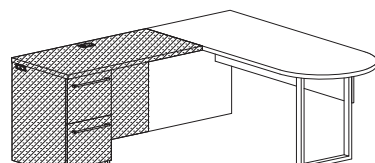

9500WSB7230R_ _ **\$1086**
 Bullet worksurface (RH), back panel and metal pedestal end
 30" x 72" x 30"H (169 lbs)

9500WSB6630R_ _ **\$1037**
 Bullet worksurface (RH), back panel and metal pedestal end
 30" x 66" x 30"H (154 lbs)

CONNECT SERIES

List Price

Executive Workstations - Executive Returns

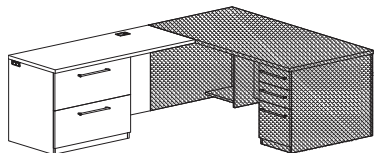

9500ERL2460LF _ _ **\$1313**
 Executive height return (LH), two lateral file drawers (locking),
 wire mgmt grommets in top, back and end, 28"W kneespace
 24" x 60" x 30"H (228 lbs)

9500ERL2060LF _ _ **\$1268**
 Executive height return (LH), two lateral file drawers (locking),
 wire mgmt grommets in top, back and end, 28"W kneespace
 20" x 60" x 30"H (208 lbs)

9500ERL2454LF _ _ **\$1282**
 Executive height return (LH), two lateral file drawers (locking),
 wire mgmt grommets in top, back and end, 22"W kneespace
 24" x 54" x 30"H (215 lbs)

9500ERL2054LF _ _ **\$1236**
 Executive height return (LH), two lateral file drawers (locking),
 wire mgmt grommets in top, back and end, 22"W kneespace
 20" x 54" x 30"H (195 lbs)

9500ERL2454 _ _ **\$1112**
 Executive height return (LH), file/file pedestal (locking),
 wire mgmt grommets in top, back and end, 38"W kneespace
 24" x 54" x 30"H (140 lbs)

9500ERL2054 _ _ **\$1066**
 Executive height return (LH), file/file pedestal (locking),
 wire mgmt grommets in top, back and end, 38"W kneespace
 20" x 54" x 30"H (140 lbs)

9500ERL2448 _ _ **\$1066**
 Executive height return (LH), file/file pedestal (locking),
 wire mgmt grommets in top, back and end, 32"W kneespace
 24" x 48" x 30"H (140 lbs)

9500ERL2048 _ _ **\$1021**
 Executive height return (LH), file/file pedestal (locking),
 wire mgmt grommets in top, back and end, 32"W kneespace
 20" x 48" x 30"H (140 lbs)

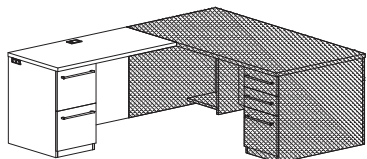

9500ERL2442 _ _ **\$1035**
 Executive height return (LH), file/file pedestal (locking),
 wire mgmt grommets in top, back and end, 26"W kneespace
 24" x 42" x 30"H (140 lbs)

9500ERL2042 _ _ **\$989**
 Executive height return (LH), file/file pedestal (locking),
 wire mgmt grommets in top, back and end, 26"W kneespace
 20" x 42" x 30"H (140 lbs)

9500ERL2436 _ _ **\$975**
 Executive height return (LH), file/file pedestal (locking),
 wire mgmt grommets in top, back and end, 20"W kneespace
 24" x 36" x 30"H (140 lbs)

9500ERL2036 _ _ **\$930**
 Executive height return (LH), file/file pedestal (locking),
 wire mgmt grommets in top, back and end, 20"W kneespace
 20" x 36" x 30"H (140 lbs)

CONNECT SERIES

List Price

Executive Workstations - Single Pedestal Desks

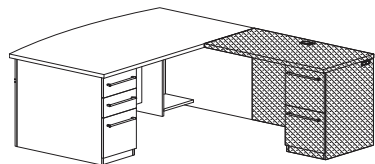

9500KSPL7242_ _ **\$1791**
 Executive single pedestal desk (LH) with arc conference top, box/box/file pedestal (locking),
 10" center overhang, stepped modesty panel
 42" x 72" x 30"H (335 lbs)

9500KSPL7236_ _ **\$1687**
 Executive single pedestal desk (LH) with arc conference top, box/box/file pedestal (locking),
 10" center overhang, stepped modesty panel
 36" x 72" x 30"H (305 lbs)

9500SPL7236_ _ **\$1596**
 Executive single pedestal desk (LH), box/box/file pedestal (locking),
 6" center overhang, stepped modesty panel
 36" x 72" x 30"H (330 lbs)

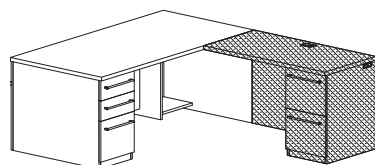

9500SPL7230_ _ **\$1508**
 Executive single pedestal desk (LH), box/box/file pedestal (locking),
 6" center overhang, stepped modesty panel
 30" x 72" x 30"H (300 lbs)

9500SPL6636_ _ **\$1572**
 Executive single pedestal desk (LH), box/box/file pedestal (locking),
 6" center overhang, stepped modesty panel
 36" x 66" x 30"H (290 lbs)

9500SPL6630_ _ **\$1492**
 Executive single pedestal desk (LH), box/box/file pedestal (locking),
 6" center overhang, stepped modesty panel
 30" x 66" x 30"H (275 lbs)

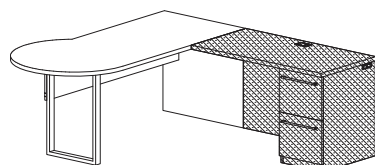

9500WSP7236L_ _ **\$1346**
 P Top worksurface (LH), 42" radius end, back panel and metal pedestal end
 36" x 72" x 30"H (190 lbs)

9500WSP6636L_ _ **\$1216**
 P Top worksurface (LH), 42" radius end, back panel and metal pedestal end
 36" x 66" x 30"H (172 lbs)

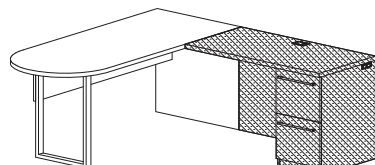

9500WSB7230L_ _ **\$1086**
 Bullet worksurface (LH), back panel and metal pedestal end
 30" x 72" x 30"H (169 lbs)

9500WSB6630L_ _ **\$1037**
 Bullet worksurface (LH), back panel and metal pedestal end
 30" x 66" x 30"H (154 lbs)

CONNECT SERIES

List Price

Executive Workstations - Executive Returns

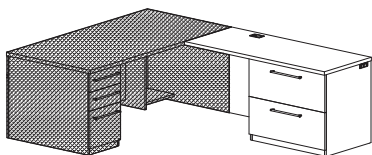

9500ERR2460LF_ _ **\$1313**
 Executive height return (RH), two lateral file drawers (locking),
 wire mgmt grommets in top, back and end, 28"W kneespace
 24" x 60" x 30"H (228 lbs)

9500ERR2060LF_ _ **\$1268**
 Executive height return (RH), two lateral file drawers (locking),
 wire mgmt grommets in top, back and end, 28"W kneespace
 20" x 60" x 30"H (208 lbs)

9500ERR2454LF_ _ **\$1282**
 Executive height return (RH), two lateral file drawers (locking),
 wire mgmt grommets in top, back and end, 22"W kneespace
 24" x 54" x 30"H (215 lbs)

9500ERR2054LF_ _ **\$1236**
 Executive height return (RH), two lateral file drawers (locking),
 wire mgmt grommets in top, back and end, 22"W kneespace
 20" x 54" x 30"H (195 lbs)

9500ERR2454_ _ **\$1112**
 Executive height return (RH), file/file pedestal (locking),
 wire mgmt grommets in top, back and end, 38"W kneespace
 24" x 54" x 30"H (140 lbs)

9500ERR2054_ _ **\$1066**
 Executive height return (RH), file/file pedestal (locking),
 wire mgmt grommets in top, back and end, 38"W kneespace
 20" x 54" x 30"H (140 lbs)

9500ERR2448_ _ **\$1066**
 Executive height return (RH), file/file pedestal (locking),
 wire mgmt grommets in top, back and end, 32"W kneespace
 24" x 48" x 30"H (140 lbs)

9500ERR2048_ _ **\$1021**
 Executive height return (RH), file/file pedestal (locking),
 wire mgmt grommets in top, back and end, 32"W kneespace
 20" x 48" x 30"H (140 lbs)

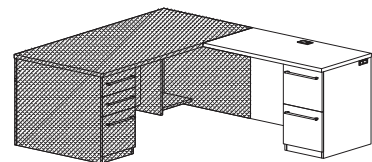

9500ERR2442_ _ **\$1035**
 Executive height return (RH), file/file pedestal (locking),
 wire mgmt grommets in top, back and end, 26"W kneespace
 24" x 42" x 30"H (140 lbs)

9500ERR2042_ _ **\$989**
 Executive height return (RH), file/file pedestal (locking),
 wire mgmt grommets in top, back and end, 26"W kneespace
 20" x 42" x 30"H (140 lbs)

9500ERR2436_ _ **\$975**
 Executive height return (RH), file/file pedestal (locking),
 wire mgmt grommets in top, back and end, 20"W kneespace
 24" x 36" x 30"H (140 lbs)

9500ERR2036_ _ **\$930**
 Executive height return (RH), file/file pedestal (locking),
 wire mgmt grommets in top, back and end, 20"W kneespace
 20" x 36" x 30"H (140 lbs)

CONNECT SERIES

List Price

Computer Desk U Workstations - Single Pedestal Desks

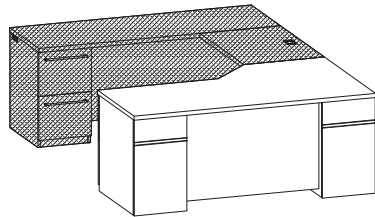

9500ECWSR7242-24_ _ **\$1771**
 Executive single pedestal computer desk (RH), box/box/file pedestal (locking), 42" corner unit, wire mgmt grommet in wing end, stepped modesty panel, for 24" return
 30"- 42" x 72" x 30"H (325 lbs)

9500ECWSR7242-20_ _ **\$1771**
 Executive single pedestal computer desk (RH), box/box/file pedestal (locking), 42" corner unit, wire mgmt grommet in wing end, stepped modesty panel, for 20" deep return
 30"- 42" x 72" x 30"H (325 lbs)

9500ECWSR7236-24_ _ **\$1694**
 Executive single pedestal computer desk (RH), box/box/file pedestal (locking), 36" corner unit, wire mgmt grommet in wing end, stepped modesty panel, for 24" deep return
 24"- 36" x 72" x 30"H (325 lbs)

9500ECWSR7236-20_ _ **\$1694**
 Executive single pedestal computer desk (RH), box/box/file pedestal (locking), 36" corner unit, wire mgmt grommet in wing end, stepped modesty panel, for 20" deep return
 24"- 36" x 72" x 30"H (325 lbs)

9500ECWSR6636-24_ _ **\$1602**
 Executive single pedestal computer desk (RH), box/box/file pedestal (locking), 36" corner unit, wire mgmt grommet in wing end, stepped modesty panel, for 24" deep return
 24"- 36" x 66" x 30"H (325 lbs)

9500ECWSR6636-20_ _ **\$1602**
 Executive single pedestal computer desk (RH), box/box/file pedestal (locking), 36" corner unit, wire mgmt grommet in wing end, stepped modesty panel, for 20" deep return
 24"- 36" x 66" x 30"H (325 lbs)

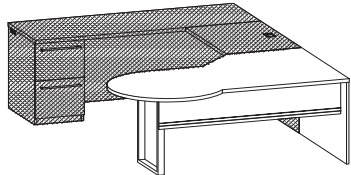

9500ECWPR7242-24_ _ **\$1476**
 Freestanding P-Top computer desk (RH), 36" diameter end, with metal pedestal end, 42" corner unit, one wire mgmt grommet in wing end, for 24" deep return
 30"-42" x 72" x 30"H (195 lbs)

9500ECWPR7242-20_ _ **\$1476**
 Freestanding P-Top computer desk (RH), 36" diameter end, with metal pedestal end, 42" corner unit, one wire mgmt grommet in wing end, for 20" deep return
 30"-42" x 72" x 30"H (195 lbs)

9500ECWBR7242-24_ _ **\$1216**
 Freestanding bullet top computer desk (RH), 30" diameter end, with metal pedestal end, 42" corner unit, one wire mgmt grommet in wing end, for 24" deep return
 30"-42" x 72" x 30"H (195 lbs)

9500ECWBR7242-20_ _ **\$1216**
 Freestanding bullet top computer desk (RH), 30" diameter end, with metal pedestal end, 42" corner unit, one wire mgmt grommet in wing end, for 20" deep return
 30"-42" x 72" x 30"H (195 lbs)

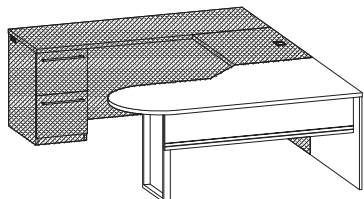

9500ECWBR7236-24_ _ **\$1121**
 Freestanding bullet top computer desk (RH), 30" diameter end, with metal pedestal end, 36" corner unit, one wire mgmt grommet in wing end, for 24" deep return
 24"-36" x 72" x 30"H (195 lbs)

9500ECWBR7236-20_ _ **\$1121**
 Freestanding bullet top computer desk (RH), 30" diameter end, with metal pedestal end, 36" corner unit, one wire mgmt grommet in wing end, for 20" deep return
 24"-36" x 72" x 30"H (195 lbs)

9500ECWBR6636-24_ _ **\$1049**
 Freestanding bullet top computer desk (RH), 30" diameter end, with metal pedestal end, 36" corner unit, one wire mgmt grommet in wing end, for 24" deep return
 24"-36" x 66" x 30"H (195 lbs)

9500ECWBR6636-20_ _ **\$1049**
 Freestanding bullet top computer desk (RH), 30" diameter end, with metal pedestal end, 36" corner unit, one wire mgmt grommet in wing end, for 20" deep return
 24"-36" x 66" x 30"H (195 lbs)

CONNECT SERIES

List Price

Computer Desk U Workstations - Connecting Bridges

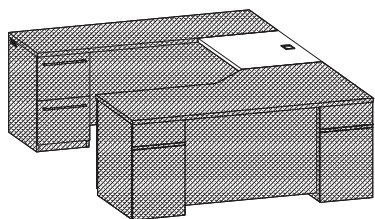

| | |
|--|--------------|
| 9500WS2442_ Executive height bridge, computer grommet in top and back 24" x 42" x 30"H (73 lbs) | \$341 |
| 9500WS2442TO_ Top only bridge | \$186 |
| 9500WS2042_ Executive height bridge, computer grommet in top and bac 20" x 42" x 30"H (64 lbs) | \$325 |
| 9500WS2042TO_ Top only bridge | \$176 |
| 9500WS2436_ Executive height bridge, computer grommet in top and back 24" x 36" x 30"H (63 lbs) | \$332 |
| 9500WS2436TO_ Top only bridge | \$174 |
| 9500WS2036_ Executive height bridge, computer grommet in top and back 20" x 36" x 30"H (55 lbs) | \$316 |
| 9500WS2036TO_ Top only bridge | \$158 |

Computer Desk U Workstations - Single Pedestal Credenzas

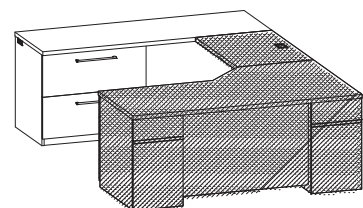

| | |
|--|---------------|
| 9500DCSPL7224LF_ Single pedestal credenza (LH), two lateral file drawers (locking), legal or letter filing, wire mgmt grommets in ends and back, 39"W kneespace 24" x 72" x 30"H (230 lbs) | \$1407 |
| 9500DCSPL7220LF_ Single pedestal credenza (LH), two lateral file drawers (locking), legal or letter filing, wire mgmt grommets in ends and back, 39"W kneespace 20" x 72" x 30"H (201 lbs) | \$1342 |
| 9500DCSPL6624LF_ Single pedestal credenza (LH), two lateral file drawers (locking), legal or letter filing, wire mgmt grommets in ends and back, 33"W kneespace 24" x 66" x 30"H (215 lbs) | \$1372 |
| 9500DCSPL6620LF_ Single pedestal credenza (LH), two lateral file drawers (locking), legal or letter filing, wire mgmt grommets in ends and back, 33"W kneespace 20" x 66" x 30"H (188 lbs) | \$1307 |

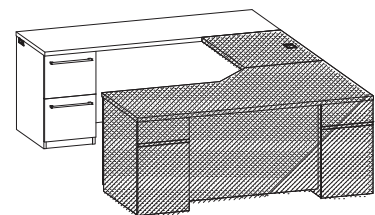

| | |
|--|---------------|
| 9500DCSPL7224_ Single pedestal credenza (LH), file/file pedestal (locking), wire mgmt grommets in ends and back, 55"W kneespace 24" x 72" x 30"H (220 lbs) | \$1246 |
| 9500DCSPL7220_ Single pedestal credenza (LH), file/file pedestal (locking), wire mgmt grommets in ends and back, 55"W kneespace 20" x 72" x 30"H (193 lbs) | \$1181 |
| 9500DCSPL6624_ Single pedestal credenza (LH), file/file pedestal (locking), wire mgmt grommets in ends and back, 49"W kneespace 24" x 66" x 30"H (200 lbs) | \$1211 |
| 9500DCSPL6620_ Single pedestal credenza (LH), file/file pedestal (locking), wire mgmt grommets in ends and back, 49"W kneespace 20" x 66" x 30"H (176 lbs) | \$1146 |

CONNECT SERIES

List Price

Computer Desk U Workstations - Single Pedestal Desks

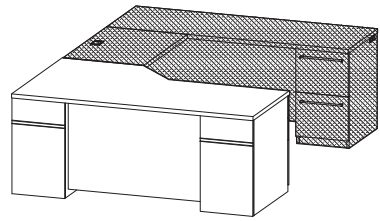
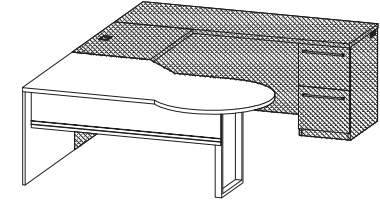
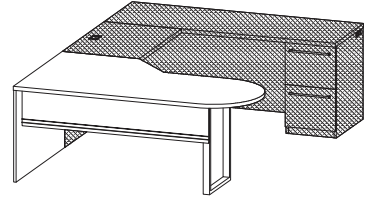
| | | | |
|--|--|--|---------------|
|  | 9500ECWSL7242-24_ _ | Executive single pedestal computer desk (LH), box/box/file pedestal (locking), 42" corner unit, wire mgmt grommet in wing end, stepped modesty panel, for 24" return 30"- 42" x 72" x 30"H (325 lbs) | \$1771 |
| | 9500ECWSL7242-20_ _ | Executive single pedestal computer desk (LH), box/box/file pedestal (locking), 42" corner unit, wire mgmt grommet in wing end, stepped modesty panel, for 20" deep return 30"- 42" x 72" x 30"H (325 lbs) | \$1771 |
| | 9500ECWSL7236-24_ _ | Executive single pedestal computer desk (LH), box/box/file pedestal (locking), 36" corner unit, wire mgmt grommet in wing end, stepped modesty panel, for 24" deep return 24"- 36" x 72" x 30"H (325 lbs) | \$1694 |
| | 9500ECWSL7236-20_ _ | Executive single pedestal computer desk (LH), box/box/file pedestal (locking), 36" corner unit, wire mgmt grommet in wing end, stepped modesty panel, for 20" deep return 24"- 36" x 72" x 30"H (325 lbs) | \$1694 |
| | 9500ECWSL6636-24_ _ | Executive single pedestal computer desk (LH), box/box/file pedestal (locking), 36" corner unit, wire mgmt grommet in wing end, stepped modesty panel, for 24" deep return 24"- 36" x 66" x 30"H (325 lbs) | \$1602 |
|  | 9500ECWPL7242-24_ _ | Freestanding P-Top computer desk (LH), 36" diameter end, with metal pedestal end, 42" corner unit, one wire mgmt grommet in wing end, for 24" deep return 30"-42" x 72" x 30"H (195 lbs) | \$1476 |
| | 9500ECWPL7242-20_ _ | Freestanding P-Top computer desk (LH), 36" diameter end, with metal pedestal end, 42" corner unit, one wire mgmt grommet in wing end, for 20" deep return 30"-42" x 72" x 30"H (195 lbs) | \$1476 |
|  | 9500ECWBL7242-24_ _ | Freestanding bullet top computer desk (LH), 30" diameter end, with metal pedestal end, 42" corner unit, one wire mgmt grommet in wing end, for 24" deep return 30"-42" x 72" x 30"H (195 lbs) | \$1216 |
| | 9500ECWBL7242-20_ _ | Freestanding bullet top computer desk (LH), 30" diameter end, with metal pedestal end, 42" corner unit, one wire mgmt grommet in wing end, for 20" deep return 30"-42" x 72" x 30"H (195 lbs) | \$1216 |
| | 9500ECWBL7236-24_ _ | Freestanding bullet top computer desk (LH), 30" diameter end, with metal pedestal end, 36" corner unit, one wire mgmt grommet in wing end, for 24" deep return 24"-36" x 72" x 30"H (195 lbs) | \$1121 |
| | 9500ECWBL7236-20_ _ | Freestanding bullet top computer desk (LH), 30" diameter end, with metal pedestal end, 36" corner unit, one wire mgmt grommet in wing end, for 20" deep return 24"-36" x 72" x 30"H (195 lbs) | \$1121 |
| | 9500ECWBL6636-24_ _ | Freestanding bullet top computer desk (LH), 30" diameter end, with metal pedestal end, 36" corner unit, one wire mgmt grommet in wing end, for 24" deep return 24"-36" x 66" x 30"H (195 lbs) | \$1049 |
| 9500ECWBL6636-20_ _ | Freestanding bullet top computer desk (LH), 30" diameter end, with metal pedestal end, 36" corner unit, one wire mgmt grommet in wing end, for 20" deep return 24"-36" x 66" x 30"H (195 lbs) | \$1049 | |

CONNECT SERIES

List Price

Computer Desk U Workstations - Connecting Bridges

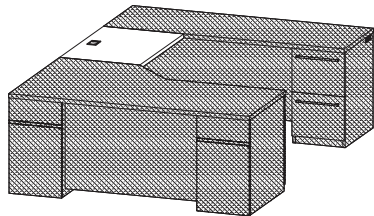

| | |
|--|--------------|
| 9500WS2442_ Executive height bridge, computer grommet in top and back 24" x 42" x 30"H (73 lbs) | \$341 |
| 9500WS2442TO_ Top only bridge | \$186 |
| 9500WS2042_ Executive height bridge, computer grommet in top and back 20" x 42" x 30"H (64 lbs) | \$325 |
| 9500WS2042TO_ Top only bridge | \$176 |
| 9500WS2436_ Executive height bridge, computer grommet in top and back 24" x 36" x 30"H (63 lbs) | \$332 |
| 9500WS2436TO_ Top only bridge | \$174 |
| 9500WS2036_ Executive height bridge, computer grommet in top and back 20" x 36" x 30"H (55 lbs) | \$316 |
| 9500WS2036TO_ Top only bridge | \$158 |

Computer Desk U Workstations - Single Pedestal Credenzas

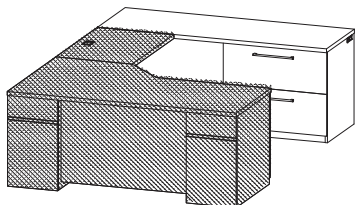

| | |
|--|---------------|
| 9500DCSPR7224LF_ Single pedestal credenza (RH), two lateral file drawers (locking), legal or letter filing, wire mgmt grommets in ends and back, 39"W kneespace 24" x 72" x 30"H (230 lbs) | \$1407 |
| 9500DCSPR7220LF_ Single pedestal credenza (RH), two lateral file drawers (locking), legal or letter filing, wire mgmt grommets in ends and back, 39"W kneespace 20" x 72" x 30"H (201 lbs) | \$1342 |
| 9500DCSPR6624LF_ Single pedestal credenza (RH), two lateral file drawers (locking), legal or letter filing, wire mgmt grommets in ends and back, 33"W kneespace 24" x 66" x 30"H (215 lbs) | \$1372 |
| 9500DCSPR6620LF_ Single pedestal credenza (RH), two lateral file drawers (locking), legal or letter filing, wire mgmt grommets in ends and back, 33"W kneespace 20" x 66" x 30"H (188 lbs) | \$1307 |

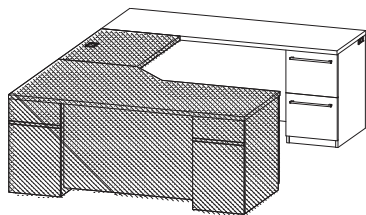

| | |
|--|---------------|
| 9500DCSPR7224_ Single pedestal credenza (RH), file/file pedestal (locking), wire mgmt grommets in ends and back, 55"W kneespace 24" x 72" x 30"H (220 lbs) | \$1246 |
| 9500DCSPR7220_ Single pedestal credenza (RH), file/file pedestal (locking), wire mgmt grommets in ends and back, 55"W kneespace 20" x 72" x 30"H (193 lbs) | \$1181 |
| 9500DCSPR6624_ Single pedestal credenza (RH), file/file pedestal (locking), wire mgmt grommets in ends and back, 49"W kneespace 24" x 66" x 30"H (200 lbs) | \$1211 |
| 9500DCSPR6620_ Single pedestal credenza (RH), file/file pedestal (locking), wire mgmt grommets in ends and back, 49"W kneespace 20" x 66" x 30"H (176 lbs) | \$1146 |

CONNECT SERIES

List Price

Executive Desk U Workstations - Single Pedestal Desks - Stepped Modesty Panel

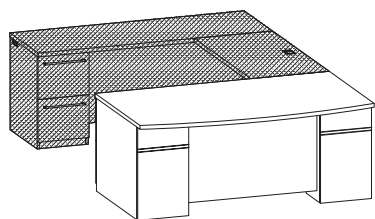

9500KSPR7242_ _ **\$1791**
 Executive single pedestal desk (RH) with arc conference top, box/box/file pedestal (locking),
 10" center overhang, stepped modesty panel
 42" x 72" x 30"H (335 lbs)

9500KSPR7236_ _ **\$1687**
 Executive single pedestal desk (RH) with arc conference top, box/box/file pedestal (locking),
 10" center overhang, stepped modesty panel
 36" x 72" x 30"H (305 lbs)

9500SPR7236_ _ **\$1596**
 Executive single pedestal desk (RH), box/box/file pedestal (locking),
 6" center overhang, stepped modesty panel
 36" x 72" x 30"H (330 lbs)

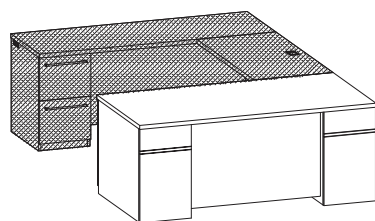

9500SPR7230_ _ **\$1508**
 Executive single pedestal desk (RH), box/box/file pedestal (locking),
 6" center overhang, stepped modesty panel
 30" x 72" x 30"H (300 lbs)

9500SPR6636_ _ **\$1572**
 Executive single pedestal desk (RH), box/box/file pedestal (locking),
 6" center overhang, stepped modesty panel
 36" x 66" x 30"H (290 lbs)

9500SPR6630_ _ **\$1492**
 Executive single pedestal desk (RH), box/box/file pedestal (locking),
 6" center overhang, stepped modesty panel
 30" x 66" x 30"H (275 lbs)

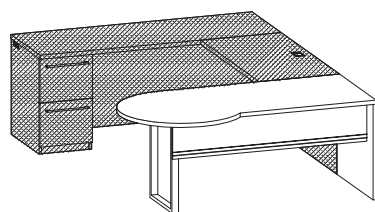

9500WSP7236R_ _ **\$1346**
 P Top worksurface (RH), 42" radius end, back panel and metal pedestal end
 36" x 72" x 30"H (190 lbs)

9500WSP6636R_ _ **\$1216**
 P Top worksurface (RH), 42" radius end, back panel and metal pedestal end
 36" x 66" x 30"H (172 lbs)

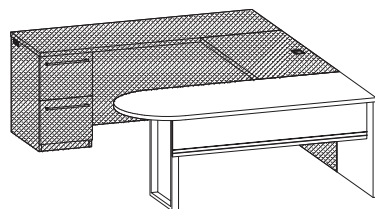

9500WSB7230R_ _ **\$1086**
 Bullet worksurface (RH), back panel and metal pedestal end
 30" x 72" x 30"H (169 lbs)

9500WSB6630R_ _ **\$1037**
 Bullet worksurface (RH), back panel and metal pedestal end
 30" x 66" x 30"H (154 lbs)

CONNECT SERIES

List Price

Executive Desk U Workstations - Connecting Bridges

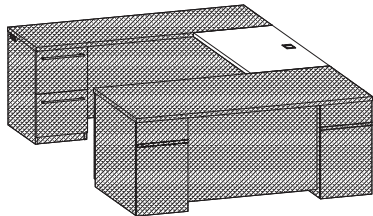

| | |
|--|--------------|
| 9500WS2448_ Executive height bridge, computer grommet in top and back 24" x 48" x 30"H (73 lbs) | \$357 |
| 9500WS2448TO_ Top only bridge | \$198 |
| 9500WS2048_ Executive height bridge, computer grommet in top and back 20" x 48" x 30"H (64 lbs) | \$335 |
| 9500WS2048TO_ Top only bridge | \$180 |
| 9500WS2442_ Executive height bridge, computer grommet in top and back 24" x 42" x 30"H (73 lbs) | \$341 |
| 9500WS2442TO_ Top only bridge | \$186 |
| 9500WS2042_ Executive height bridge, computer grommet in top and back 20" x 42" x 30"H (64 lbs) | \$325 |
| 9500WS2042TO_ Top only bridge | \$176 |

Computer Desk U Workstations - Single Pedestal Credenzas

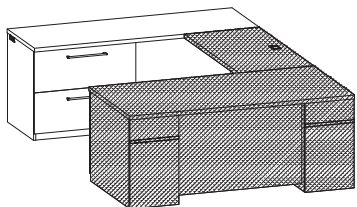

| | |
|--|---------------|
| 9500DCSPL7224LF_ Single pedestal credenza (LH), two lateral file drawers (locking), legal or letter filing, wire mgmt grommets in ends and back, 39"W kneespace 24" x 72" x 30"H (230 lbs) | \$1407 |
| 9500DCSPL7220LF_ Single pedestal credenza (LH), two lateral file drawers (locking), legal or letter filing, wire mgmt grommets in ends and back, 39"W kneespace 20" x 72" x 30"H (201 lbs) | \$1342 |
| 9500DCSPL6624LF_ Single pedestal credenza (LH), two lateral file drawers (locking), legal or letter filing, wire mgmt grommets in ends and back, 33"W kneespace 24" x 66" x 30"H (215 lbs) | \$1372 |
| 9500DCSPL6620LF_ Single pedestal credenza (LH), two lateral file drawers (locking), legal or letter filing, wire mgmt grommets in ends and back, 33"W kneespace 20" x 66" x 30"H (188 lbs) | \$1307 |

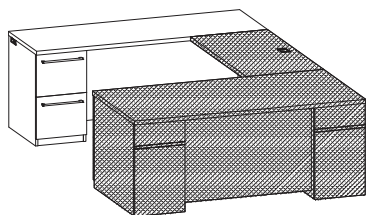

| | |
|--|---------------|
| 9500DCSPL7224_ Single pedestal credenza (LH), file/file pedestal (locking), wire mgmt grommets in ends and back, 55"W kneespace 24" x 72" x 30"H (220 lbs) | \$1246 |
| 9500DCSPL7220_ Single pedestal credenza (LH), file/file pedestal (locking), wire mgmt grommets in ends and back, 55"W kneespace 20" x 72" x 30"H (193 lbs) | \$1181 |
| 9500DCSPL6624_ Single pedestal credenza (LH), file/file pedestal (locking), wire mgmt grommets in ends and back, 49"W kneespace 24" x 66" x 30"H (200 lbs) | \$1211 |
| 9500DCSPL6620_ Single pedestal credenza (LH), file/file pedestal (locking), wire mgmt grommets in ends and back, 49"W kneespace 20" x 66" x 30"H (176 lbs) | \$1146 |

CONNECT SERIES

List Price

Executive Desk U Workstations - Single Pedestal Desks - Stepped Modesty Panel

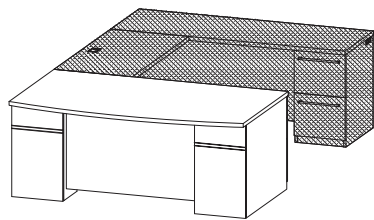

9500KSPL7242_ _ **\$1791**
 Executive single pedestal desk (LH) with arc conference top, box/box/file pedestal (locking),
 10" center overhang, stepped modesty panel
 42" x 72" x 30"H (335 lbs)

9500KSPL7236_ _ **\$1687**
 Executive single pedestal desk (LH) with arc conference top, box/box/file pedestal (locking),
 10" center overhang, stepped modesty panel
 36" x 72" x 30"H (305 lbs)

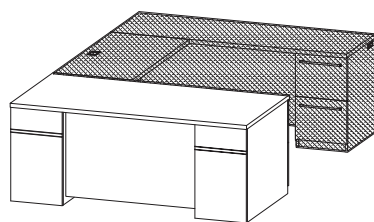

9500SPL7236_ _ **\$1596**
 Executive single pedestal desk (LH), box/box/file pedestal (locking),
 6" center overhang, stepped modesty panel
 36" x 72" x 30"H (330 lbs)

9500SPL7230_ _ **\$1508**
 Executive single pedestal desk (LH), box/box/file pedestal (locking),
 6" center overhang, stepped modesty panel
 30" x 72" x 30"H (300 lbs)

9500SPL6636_ _ **\$1572**
 Executive single pedestal desk (LH), box/box/file pedestal (locking),
 6" center overhang, stepped modesty panel
 36" x 66" x 30"H (290 lbs)

9500SPL6630_ _ **\$1492**
 Executive single pedestal desk (LH), box/box/file pedestal (locking),
 6" center overhang, stepped modesty panel
 30" x 66" x 30"H (275 lbs)

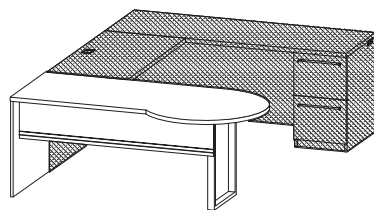

9500WSP7236L_ _ **\$1346**
 P Top worksurface (LH), 42" radius end, back panel and metal pedestal end
 36" x 72" x 30"H (190 lbs)

9500WSP6636L_ _ **\$1216**
 P Top worksurface (LH), 42" radius end, back panel and metal pedestal end
 36" x 66" x 30"H (172 lbs)

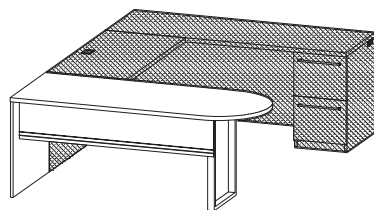

9500WSB7230L_ _ **\$1086**
 Bullet worksurface (LH), back panel and metal pedestal end
 30" x 72" x 30"H (169 lbs)

9500WSB6630L_ _ **\$1037**
 Bullet worksurface (LH), back panel and metal pedestal end
 30" x 66" x 30"H (154 lbs)

CONNECT SERIES

List Price

Executive Desk U Workstations - Connecting Bridges

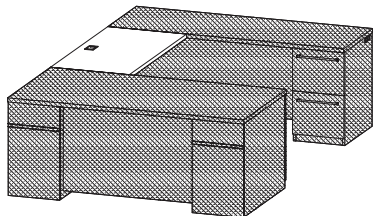

| | | |
|----------------------|--|-------|
| 9500WS2448_ | Executive height bridge, computer grommet in top and back 24" x 48" x 30"H (73 lbs) | \$357 |
| 9500WS2448TO_ | Top only bridge | \$198 |
| 9500WS2048_ | Executive height bridge, computer grommet in top and back 20" x 48" x 30"H (64 lbs) | \$335 |
| 9500WS2048TO_ | Top only bridge | \$180 |
| 9500WS2442_ | Executive height bridge, computer grommet in top and back 24" x 42" x 30"H (73 lbs) | \$341 |
| 9500WS2442TO_ | Top only bridge | \$186 |
| 9500WS2042_ | Executive height bridge, computer grommet in top and back 20" x 42" x 30"H (64 lbs) | \$325 |
| 9500WS2042TO_ | Top only bridge | \$176 |

Computer Desk U Workstations - Single Pedestal Credenzas

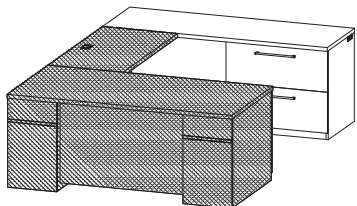

| | | |
|---------------------------|--|--------|
| 9500DCSPR7224LF_ _ | Single pedestal credenza (RH), two lateral file drawers (locking), legal or letter filing, wire mgmt grommets in ends and back, 39"W kneespace 24" x 72" x 30"H (230 lbs) | \$1407 |
| 9500DCSPR7220LF_ _ | Single pedestal credenza (RH), two lateral file drawers (locking), legal or letter filing, wire mgmt grommets in ends and back, 39"W kneespace 20" x 72" x 30"H (201 lbs) | \$1342 |
| 9500DCSPR6624LF_ _ | Single pedestal credenza (RH), two lateral file drawers (locking), legal or letter filing, wire mgmt grommets in ends and back, 33"W kneespace 24" x 66" x 30"H (215 lbs) | \$1372 |
| 9500DCSPR6620LF_ _ | Single pedestal credenza (RH), two lateral file drawers (locking), legal or letter filing, wire mgmt grommets in ends and back, 33"W kneespace 20" x 66" x 30"H (188 lbs) | \$1307 |
| 9500DCSPR7224_ _ | Single pedestal credenza (RH), file/file pedestal (locking), wire mgmt grommets in ends and back, 55"W kneespace 24" x 72" x 30"H (220 lbs) | \$1246 |
| 9500DCSPR7220_ _ | Single pedestal credenza (RH), file/file pedestal (locking), wire mgmt grommets in ends and back, 55"W kneespace 20" x 72" x 30"H (193 lbs) | \$1181 |
| 9500DCSPR6624_ _ | Single pedestal credenza (RH), file/file pedestal (locking), wire mgmt grommets in ends and back, 49"W kneespace 24" x 66" x 30"H (200 lbs) | \$1211 |
| 9500DCSPR6620_ _ | Single pedestal credenza (RH), file/file pedestal (locking), wire mgmt grommets in ends and back, 49"W kneespace 20" x 66" x 30"H (176 lbs) | \$1146 |

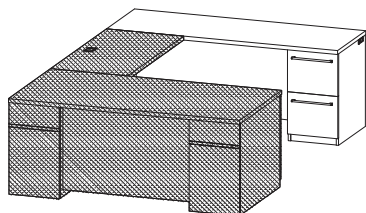

CONNECT SERIES

List Price

Overhead Storage Units

9500HC84 **\$1534**

Overhead storage unit with hinged doors, two storage areas behind four hinged doors (non-locking), two wire mgmt access grommets in bottom of back panel
 25" clearance between apron rail & worksurface
 16" x 84" x 42"H (250 lbs)
 Optional Open Storage - no doors (ND) - no price upcharge
 Optional Frosted Glass doors (FGD) - add \$539 list

9500HC78 **\$1481**

Overhead storage unit with hinged doors, two storage areas behind four hinged doors (non-locking), two wire mgmt access grommets in bottom of back panel
 25" clearance between apron rail & worksurface
 16" x 78" x 42"H (230 lbs)
 Optional Open Storage - no doors (ND) - no price upcharge
 Optional Frosted Glass doors (FGD) - add \$539 list

9500HC72 **\$1344**

Overhead storage unit with hinged doors, two storage areas behind four hinged doors (non-locking), two wire mgmt access grommets in bottom of back panel
 25" clearance between apron rail & worksurface
 16" x 72" x 42"H (220 lbs)
 Optional Open Storage - no doors (ND) - no price upcharge
 Optional Frosted Glass doors (FGD) - add \$539 list

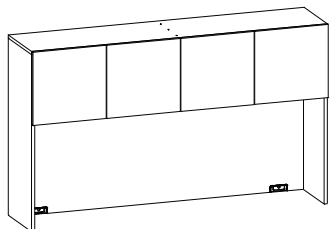

9500HC66 **\$1289**

Overhead storage unit with hinged doors, two storage areas behind four hinged doors (non-locking), two wire mgmt access grommets in bottom of back panel
 25" clearance between apron rail & worksurface
 16" x 66" x 42"H (205 lbs)
 Optional Open Storage - no doors (ND) - no price upcharge
 Optional Frosted Glass doors (FGD) - add \$539 list

9500HC60 **\$1267**

Overhead storage unit with hinged doors, two storage areas behind four hinged doors (non-locking), two wire mgmt access grommets in bottom of back panel
 25" clearance between apron rail & worksurface
 16" x 60" x 42"H (9500 lbs)
 Optional Open Storage - no doors (ND) - no price upcharge
 Optional Frosted Glass doors (FGD) - add \$539 list

9500HC48 **\$1063**

Overhead storage unit with hinged doors, two storage areas behind three hinged doors (non-locking), two wire mgmt access grommets in bottom of back panel
 25" clearance between apron rail & worksurface
 16" x 48" x 42"H (146 lbs)
 Optional Open Storage - no doors (ND) - no price upcharge
 Optional Frosted Glass doors (FGD) - add \$405 list

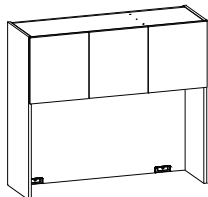

9500HC42 **\$1041**

Overhead storage unit with hinged doors, two storage areas behind three hinged doors (non-locking), two wire mgmt access grommets in bottom of back panel
 25" clearance between apron rail & worksurface
 16" x 42" x 42"H (130 lbs)
 Optional Open Storage - no doors (ND) - no price upcharge
 Optional Frosted Glass doors (FGD) - add \$405 list

*for tasklights and tackboards, see page 40

CONNECT SERIES

List Price

Wall Mounted Overhead Cabinet

9500WM72 **\$1237**

Wall mounted overhead storage unit with hinged doors, two storage areas behind four hinged doors (non-locking), supported by wall cleat, hardware provided by installer

16" x 72" x 18"H (187 lbs)

Optional Open Storage - no doors (ND) - no price upcharge

Optional Frosted Glass doors (FGD) - add \$539 list

9500WM66 **\$1192**

Wall mounted overhead storage unit with hinged doors, two storage areas behind four hinged doors (non-locking), supported by wall cleat, hardware provided by installer

16" x 66" x 18"H (174 lbs)

Optional Open Storage - no doors (ND) - no price upcharge

Optional Frosted Glass doors (FGD) - add \$539 list

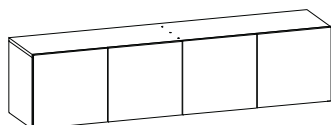

9500WM60 **\$1170**

Wall mounted overhead storage unit with hinged doors, two storage areas behind four hinged doors (non-locking), supported by wall cleat, hardware provided by installer

16" x 60" x 18"H (163 lbs)

Optional Open Storage - no doors (ND) - no price upcharge

Optional Frosted Glass doors (FGD) - add \$539 list

9500WM54 **\$1132**

Wall mounted overhead storage unit with hinged doors, two storage areas behind four hinged doors (non-locking), supported by wall cleat, hardware provided by installer

16" x 54" x 18"H (160 lbs)

Optional Open Storage - no doors (ND) - no price upcharge

Optional Frosted Glass doors (FGD) - add \$539 list

9500WM48 **\$888**

Wall mounted overhead storage unit with hinged doors, two storage areas behind three hinged doors (non-locking), single door on right side, supported by wall cleat, hardware provided by installer

16" x 48" x 18"H (154 lbs)

Optional Open Storage - no doors (ND) - no price upcharge

Optional Frosted Glass doors (FGD) - add \$405 list

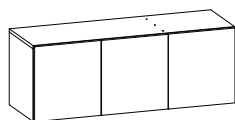

9500WM42 **\$782**

Wall mounted overhead storage unit with hinged doors, two storage areas behind three hinged doors (non-locking), single door on right side, supported by wall cleat, hardware provided by installer

16" x 42" x 18"H (142 lbs)

Optional Open Storage - no doors (ND) - no price upcharge

Optional Frosted Glass doors (FGD) - add \$405 list

9500WM36 **\$686**

Wall mounted overhead storage unit with hinged doors, one storage areas behind two hinged doors (non-locking), supported by wall cleat, hardware provided by installer

16" x 36" x 18"H (133 lbs)

Optional Open Storage - no doors (ND) - no price upcharge

Optional Frosted Glass doors (FGD) - add \$270 list

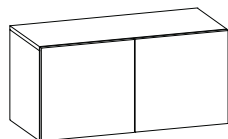

9500WM30 **\$683**

Wall mounted overhead storage unit with hinged doors, one storage areas behind two hinged doors (non-locking), supported by wall cleat, hardware provided by installer

16" x 30" x 18"H (128 lbs)

Optional Open Storage - no doors (ND) - no price upcharge

Optional Frosted Glass doors (FGD) - add \$270 list

*for tasklights and tackboards, see page 40

CONNECT SERIES

List Price

Storage Tower

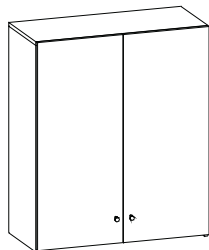

9500HS36 **\$910**
 Hinged door storage tower with two hinged doors (non-locking), one fixed shelf and one adjustable shelf,
 back panel grommet standard, pull knob
 16" x 36" x 42"H (99 lbs)
 Optional Frosted Glass doors (FGD) - add \$726 list

9500HS30 **\$750**
 Hinged door storage tower with two hinged doors (non-locking), one fixed shelf and one adjustable shelf,
 back panel grommet standard, pull knob
 16" x 30" x 42"H (88 lbs)
 Optional Frosted Glass doors (FGD) - add \$726 list

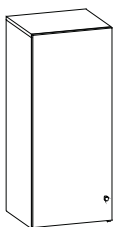

9500HS18L (hinged left) **\$578**
9500HS18R (hinged right) **\$578**
 Hinged door storage tower with one hinged door (non-locking), one fixed shelf and one adjustable shelf,
 back panel grommet standard, pull knob
 16" x 18" x 42"H (45 lbs)
 Optional Frosted Glass doors (FGD) - add \$363 list

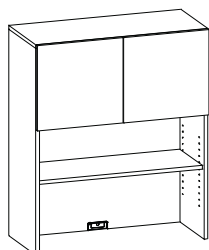

9500HB36 **\$888**
 Hinged door storage bookcase tower with hinged door compartment (non-locking), one adjustable shelf,
 back panel grommet standard
 16" x 36" x 42"H (99 lbs)
 Optional Frosted Glass doors (FGD) - add \$270 list

9500HB30 **\$725**
 Hinged door storage bookcase tower with hinged door compartment (non-locking), one adjustable shelf,
 back panel grommet standard
 16" x 30" x 42"H (88 lbs)
 Optional Frosted Glass doors (FGD) - add \$270 list

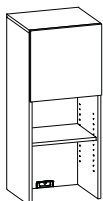

9500HB18L (hinged left) **\$569**
9500HB18R (hinged right) **\$569**
 Hinged door storage bookcase tower with hinged door compartment (non-locking), one adjustable shelf,
 back panel grommet standard
 16" x 18" x 42"H (45 lbs)
 Optional Frosted Glass doors (FGD) - add \$136 list

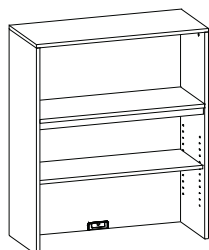

9500BO36 **\$554**
 Bookcase overhead tower with fixed shelf on top and adjustable shelf on bottom,
 back panel grommet standard
 16" x 36" x 42"H (78 lbs)

9500BO30 **\$545**
 Bookcase overhead tower with fixed shelf on top and adjustable shelf on bottom,
 back panel grommet standard
 16" x 30" x 42"H (75 lbs)

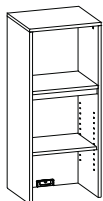

9500BO18 **\$513**
 Bookcase overhead tower with fixed shelf on top and adjustable shelf on bottom,
 back panel grommet standard
 16" x 18" x 42"H (41 lbs)

*for tasklights and tackboards, see page 40

CONNECT SERIES

List Price

Overhead Bridge Cabinet

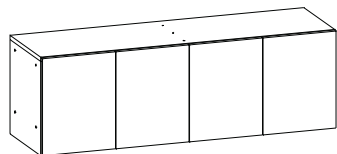
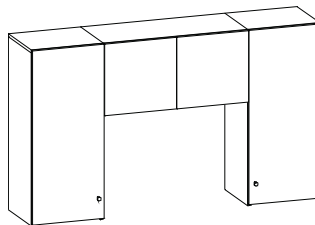

9500BC54 **\$1132**
 Overhead bridge cabinet, two storage areas behind 4 hinged doors (non-locking), supported by two storage towers
 16" x 54" x 18"H (157 lbs)
 Optional Open Storage - no doors (ND) - no price upcharge
 Optional Frosted Glass doors (FGD) - add \$539 list

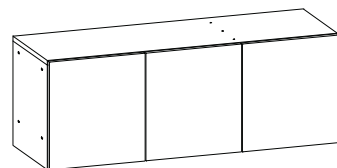

9500BC48 **\$888**
 Overhead bridge cabinet, two storage areas behind 3 hinged doors (non-locking), supported by two storage towers, single door on right side
 16" x 48" x 18"H (150 lbs)
 Optional Open Storage - no doors (ND) - no price upcharge
 Optional Frosted Glass doors (FGD) - add \$405 list

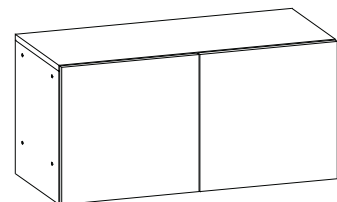

9500BC42 **\$782**
 Overhead bridge cabinet, two storage areas behind 3 hinged doors (non-locking), supported by two storage towers, single door on right side
 16" x 42" x 18"H (150 lbs)
 Optional Open Storage - no doors (ND) - no price upcharge
 Optional Frosted Glass doors (FGD) - add \$405 list



9500BC36 **\$686**
 Overhead bridge cabinet, one storage area behind 2 hinged doors (non-locking), supported by two storage towers
 16" x 36" x 18"H (130 lbs)
 Optional Open Storage - no doors (ND) - no price upcharge
 Optional Frosted Glass doors (FGD) - add \$270 list



9500BC30 **\$683**
 Overhead bridge cabinet, one storage area behind 2 hinged doors (non-locking), supported by two storage towers
 16" x 30" x 18"H (125 lbs)
 Optional Open Storage - no doors (ND) - no price upcharge
 Optional Frosted Glass doors (FGD) - add \$270 list

9500BS54 **\$381**
 Overhead bridge shelf, supported by two storage towers
 15 7/16" x 54" x 18"H (62 lbs)

9500BS48 **\$333**
 Overhead bridge shelf, supported by two storage towers
 15 7/16" x 48" x 18"H (55 lbs)

9500BS42 **\$303**
 Overhead bridge shelf, supported by two storage towers
 15 7/16" x 42" x 18"H (48 lbs)

9500BS36 **\$260**
 Overhead bridge shelf, supported by two storage towers
 15 7/16" x 36" x 18"H (41 lbs)

9500BS30 **\$258**
 Overhead bridge shelf, supported by two storage towers
 15 7/16" x 30" x 18"H (39 lbs)

*for tasklights and tackboards, see page 40

CONNECT SERIES

List Price

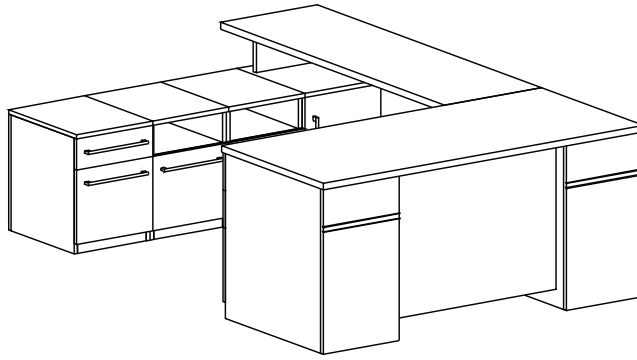

| Return Worksurface Riser | | | |
|---------------------------------|-----------------------|-------|-------|
| 9500WR6024 _ | 60"W x 24"D x 9 1/4"H | 68lbs | \$682 |
| 9500WR6020 _ | 60"W x 20"D x 9 1/4"H | 60lbs | \$650 |
| 9500WR6624 _ | 66"W x 24"D x 9 1/4"H | 74lbs | \$715 |
| 9500WR6620 _ | 66"W x 20"D x 9 1/4"H | 65lbs | \$683 |
| 9500WR7224 _ | 72"W x 24"D x 9 1/4"H | 78lbs | \$748 |
| 9500WR7220 _ | 72"W x 20"D x 9 1/4"H | 69lbs | \$715 |

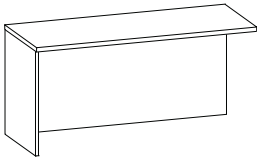

| Return Worksurface Shell - Left | | | |
|--|--------------------|--------|-------|
| 9500SH6024L _ | 60"W x 24"D x 30"H | 120lbs | \$724 |
| 9500SH6020L _ | 60"W x 20"D x 30"H | 105lbs | \$659 |
| 9500SH6624L _ | 66"W x 24"D x 30"H | 132lbs | \$782 |
| 9500SH6620L _ | 66"W x 20"D x 30"H | 116lbs | \$717 |
| 9500SH7224L _ | 72"W x 24"D x 30"H | 144lbs | \$841 |
| 9500SH7220L _ | 72"W x 20"D x 30"H | 126lbs | \$776 |

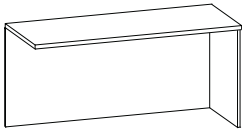

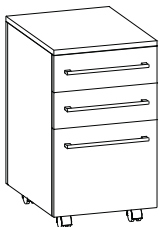

| Return Worksurface Shell - Right | | | |
|---|--------------------|--------|-------|
| 9500SH6024R _ | 60"W x 24"D x 30"H | 120lbs | \$724 |
| 9500SH6020R _ | 60"W x 20"D x 30"H | 105lbs | \$659 |
| 9500SH6624R _ | 66"W x 24"D x 30"H | 132lbs | \$782 |
| 9500SH6620R _ | 66"W x 20"D x 30"H | 116lbs | \$717 |
| 9500SH7224R _ | 72"W x 24"D x 30"H | 144lbs | \$841 |
| 9500SH7220R _ | 72"W x 20"D x 30"H | 126lbs | \$776 |



| | | | |
|---|--|--|---------------|
| 9500MP-BBF | | | \$1008 |
| Mobile pedestal box-box-file, non-locking | | | |
| 16" x 20 x 28"H (97 lbs) | | | |

CONNECT SERIES

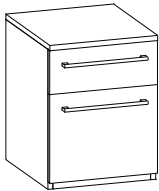
List Price

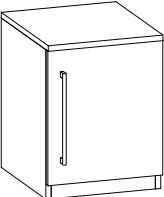
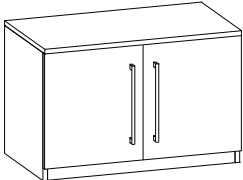
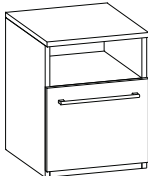
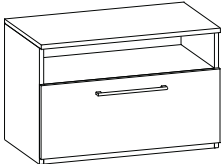
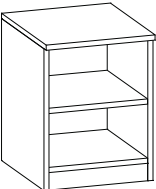
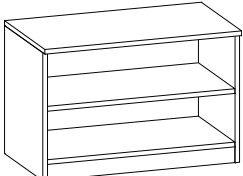
| | | |
|---|---|-------|
|  | 9500BP-BF1818 Bench Height Unit with Box/File drawer configuration (non-locking) 18" x 18" x 19 1/2"H (79 lbs) | \$591 |
| | 9500BP-BF1824 Bench Height Unit with Box/File drawer configuration (non-locking) 18" x 24" x 19 1/2"H (89 lbs) | \$631 |
|  | 9500BP-BF3618 Bench Height Unit with Box/File drawer configuration (non-locking) 36" x 18" x 19 1/2"H (126 lbs) | \$774 |
| | 9500BP-BF3624 Bench Height Unit with Box/File drawer configuration (non-locking) 36" x 24" x 19 1/2"H (142 lbs) | \$836 |
|  | 9500BP-HD1818(L/R) Bench Height Unit with Hinged door configuration (non-locking), specify left or right 18" x 18" x 19 1/2"H (79 lbs) | \$510 |
| | 9500BP-HD1824(L/R) Bench Height Unit with Hinged door configuration (non-locking), specify left or right 18" x 24" x 19 1/2"H (89 lbs) | \$551 |
|  | 9500BP-HD3618 Bench Height Unit with Hinged door configuration (non-locking) 36" x 18" x 19 1/2"H (126 lbs) | \$653 |
| | 9500BP-HD3624 Bench Height Unit with Hinged door configuration (non-locking) 36" x 24" x 19 1/2"H (142 lbs) | \$702 |
|  | 9500BP-CF1818 Bench Height Unit with Open shelf/File drawer configuration (non-locking) 18" x 18" x 19 1/2"H (79 lbs) | \$544 |
| | 9500BP-CF1824 Bench Height Unit with Open shelf/File drawer configuration (non-locking) 18" x 24" x 19 1/2"H (89 lbs) | \$583 |
|  | 9500BP-CF3618 Bench Height Unit with Open shelf/File drawer configuration (non-locking) 36" x 18" x 19 1/2"H (79 lbs) | \$702 |
| | 9500BP-CF3624 Bench Height Unit with Open shelf/File drawer configuration (non-locking) 36" x 24" x 19 1/2"H (89 lbs) | \$764 |
|  | 9500BP-BC1818 Bench Height Unit with Open shelf configuration, adjustable shelf 18" x 18" x 19 1/2"H (79 lbs) | \$428 |
| | 9500BP-BC1824 Bench Height Unit with Open shelf configuration, adjustable shelf 18" x 24" x 19 1/2"H (89 lbs) | \$466 |
|  | 9500BP-BC3618 Bench Height Unit with Open shelf configuration, adjustable shelf 36" x 18" x 19 1/2"H (79 lbs) | \$530 |
| | 9500BP-BC3624 Bench Height Unit with Open shelf configuration, adjustable shelf 36" x 24" x 19 1/2"H (89 lbs) | \$591 |

CONNECT SERIES

List Price

Training Tables

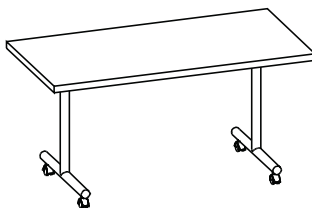
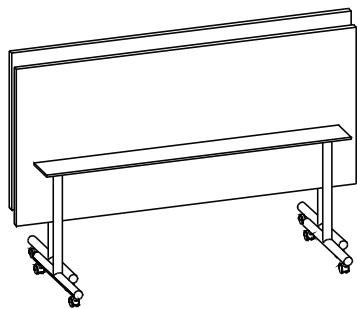

| Training Tables | | | |
|-----------------|--------------------|---------|--------|
| 9500TT2048 _ | 48"W x 20"D x 29"H | 75 lbs | \$1395 |
| 9500TT2054 _ | 54"W x 20"D x 29"H | 81 lbs | \$1435 |
| 9500TT2060 _ | 60"W x 20"D x 29"H | 87 lbs | \$1475 |
| 9500TT2066 _ | 66"W x 20"D x 29"H | 93 lbs | \$1515 |
| 9500TT2072 _ | 72"W x 20"D x 29"H | 98 lbs | \$1715 |
| | | | |
| 9500TT2448 _ | 48"W x 24"D x 29"H | 85 lbs | \$1430 |
| 9500TT2454 _ | 54"W x 24"D x 29"H | 92 lbs | \$1470 |
| 9500TT2460 _ | 60"W x 24"D x 29"H | 98 lbs | \$1510 |
| 9500TT2466 _ | 66"W x 24"D x 29"H | 105 lbs | \$1550 |
| 9500TT2472 _ | 72"W x 24"D x 29"H | 112 lbs | \$1750 |
| | | | |
| 9500TT3048 _ | 48"W x 30"D x 29"H | 98 lbs | \$1510 |
| 9500TT3054 _ | 54"W x 30"D x 29"H | 107 lbs | \$1550 |
| 9500TT3060 _ | 60"W x 30"D x 29"H | 116 lbs | \$1590 |
| 9500TT3066 _ | 66"W x 30"D x 29"H | 124 lbs | \$1630 |
| 9500TT3072 _ | 72"W x 30"D x 29"H | 133 lbs | \$1830 |
| | | | |
| 9500TT3666 _ | 66"W x 36"D x 29"H | 143 lbs | \$1690 |
| 9500TT3672 _ | 72"W x 36"D x 29"H | 153 lbs | \$1890 |

Pneumatic Adjustable Height Tables

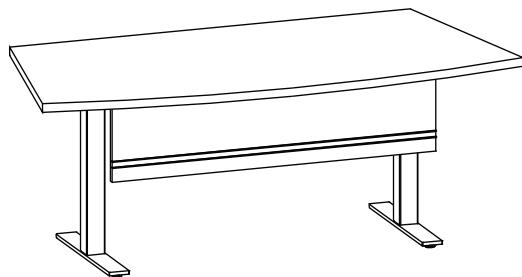

| Adjustable Height Tables - Rectangle | | | |
|--------------------------------------|--------------------|---------|--------|
| 9500AT3060 _ | 60"W x 30"D x 29"H | 160 lbs | \$3020 |
| 9500AT3066 _ | 66"W x 30"D x 29"H | 168 lbs | \$3090 |
| 9500AT3072 _ | 72"W x 30"D x 29"H | 175 lbs | \$3120 |
| 9500AT3666 _ | 66"W x 36"D x 29"H | 185 lbs | \$3190 |
| 9500AT3672 _ | 72"W x 36"D x 29"H | 194 lbs | \$3410 |
| | | | |
| Adjustable Height Tables - Arc Top | | | |
| 9500AK3060 _ | 60"W x 30"D x 29"H | 150 lbs | \$3220 |
| 9500AK3066 _ | 66"W x 30"D x 29"H | 158 lbs | \$3290 |
| 9500AK3666 _ | 66"W x 36"D x 29"H | 170 lbs | \$3320 |
| 9500AK3672 _ | 72"W x 36"D x 29"H | 179 lbs | \$3390 |
| 9500AK4272 _ | 72"W x 42"D x 29"H | 200 lbs | \$3610 |

CONNECT SERIES

List Price

Conference Table Tops



| | |
|---|--------------|
| 9500MT48DIA_ Round conference table top 48" diameter x 1 3/16"H (62 lbs) | \$408 |
| 9500MT42DIA_ Round conference table top 42" diameter x 1 3/16"H (50 lbs) | \$313 |
| 9500MT36DIA_ Round conference table top 36" diameter x 1 3/16"H (30 lbs) | \$271 |

Conference Table Bases

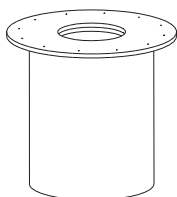

| | |
|---|--------------|
| 9500MCB22 22" diameter drum base (for use with 48" diameter tops) 22" diameter x 27 3/4"H (85 lbs) | \$565 |
| 9500MCB18 18" diameter drum base (for use with 36"-42" diameter tops) 18" diameter x 27 3/4"H (85 lbs) | \$435 |

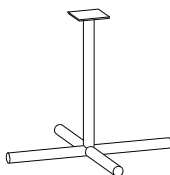

| | |
|--|--------------|
| 12CRFPB32 X-base in chrome (for use with 42" - 48" diameter tops) 32" x 32" x 27 3/4"H (21 lbs) | \$592 |
| 12PWFPB32 X-base in black (for use with 42" - 48" diameter tops) 32" x 32" x 27 3/4"H (21 lbs) | \$511 |
| 12CRFPB26 X-base in chrome (for use with 36" diameter tops) 26" x 26" x 27 3/4"H (16 lbs) | \$458 |
| 12PWFPB26 X-base in black (for use with 36" diameter tops) 26" x 26" x 27 3/4"H (16 lbs) | \$390 |

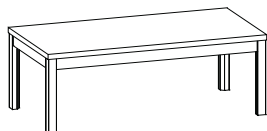

| | |
|---|--------------|
| 9500MT2448_ Magazine table 24" x 48" x 16"H (58 lbs) | \$619 |
|---|--------------|

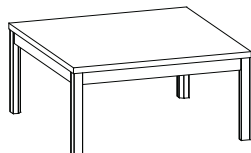

| | |
|---|--------------|
| 9500CT2828_ Corner table 28" x 28" x 21"H (42 lbs) | \$604 |
|---|--------------|

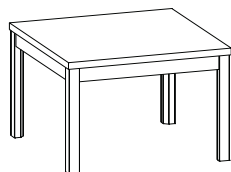

| | |
|--|--------------|
| 9500ET2028_ End table 20" x 28" x 21"H (38 lbs) | \$527 |
|--|--------------|

CONNECT SERIES

List Price

Accessories

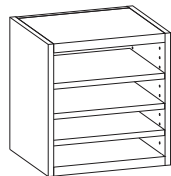

9500PSA **\$603**
 Portable work organizer, with three paper trays
 15" x 12" x 17"H (20 lbs)

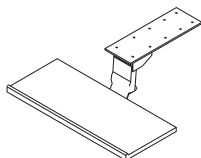

AKPW **\$472**
 Articulating keyboard - leverless, with non- handed mouse pad, 5" height adjustment,
 25 degree tilt - 360 degree swivel, wooden keyboard tray - specify finish
 11 1/4" x 21 1/2" x 2 3/4"H (25 lbs)

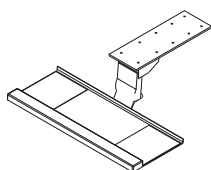

AKP **\$337**
 Articulating keyboard - leverless, with non- handed mouse pad, 5" height
 adjustment, 25 degree tilt - 360 degree swivel, black molded keyboard tray
 11" x 25" x 2 3/4"H (21 lbs)

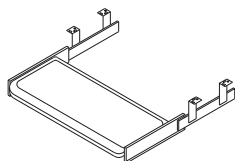

KD **\$153**
 Pull-out keyboard - leverless, black molded keyboard tray
 10 5/8" x 21 1/2" x 3 5/8"H (15 lbs)



LH **\$83**
 Wire mgmt channel, 22" length - set of four, double sided velcro attachment
 4 lbs

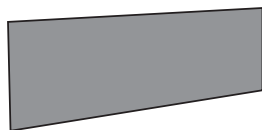

TB77 **\$474**
 Fabric tackboard, (COM, Grade A, Grade B) 3/4" x 77" x 15 1/2"H (20 lbs)

TB71 **\$448**
 Fabric tackboard, (COM, Grade A, Grade B) 3/4" x 71" x 15 1/2"H (18 lbs)

TB65 **\$400**
 Fabric tackboard, (COM, Grade A, Grade B) 3/4" x 65" x 15 1/2"H (16 lbs)

TB59 **\$386**
 Fabric tackboard, (COM, Grade A, Grade B) 3/4" x 59" x 15 1/2"H (14 lbs)

TB53 **\$341**
 Fabric tackboard, (COM, Grade A, Grade B) 3/4" x 53" x 15 1/2"H (12 lbs)

TB41 **\$300**
 Fabric tackboard, (COM, Grade A, Grade B) 3/4" x 41" x 15 1/2"H (11 lbs)

TB35 **\$233**
 Fabric tackboard, (COM, Grade A, Grade B) 3/4" x 35" x 15 1/2"H (10 lbs)



TL48 **\$215**
 Task light (UL approved), 6" x 48" x 1 1/2"H (15 lbs)

TL24 **\$185**
 Task light (UL approved), 6" x 24" x 1 1/2"H (10 lbs)

CONNECTION SERIES



Contemporary styling with a choice of 18 finishes, four edge details and three aluminum hardware selections. Can be specified with or without decorative metal inlay.
All items are available in a choice of walnut, cherry, maple, and double cut finishes.

CONNECTION SERIES

Finishes Available

Walnut

Natural Walnut



Richleigh Walnut

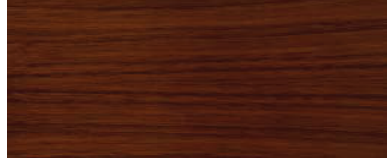

Royal Walnut

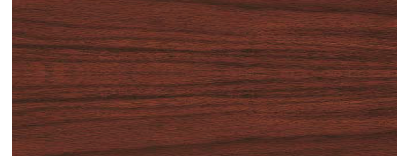

Empire Walnut



Old World Mahogany



Crescent Cherry on Walnut

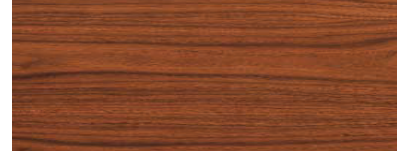

Espresso

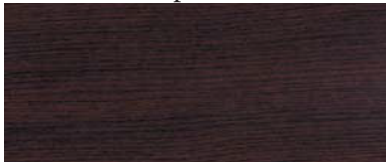

Cherry

Natural Cherry



Amber Cherry



Cinnamon Cherry



Collector's Cherry



Mocha Cherry



Mahogany on Cherry



Maple

Sunrise Maple



Double Cut - 10% upcharge

Cremello



Khaki



Coffee



Graphite



**The finishes shown on this page have been reproduced as accurately as possible, however, due to the printing process some finishes may vary slightly from the actual finish samples originally photographed. In addition, due to the nature of wood, it is possible that some slight variations in color and grain character may occur naturally (which is the beauty of a natural product). Wood finish chips are available for each of the above finishes if requested (please call customer service).

CONNECTION SERIES



Options Available

| | | | |
|-----|---|----|--------------------------|
| HPL | Matching high pressure laminate substituted for wood top - Call customer service for matching finish selections | \$ | N/C |
| CD | Center Drawer | \$ | 374 |
| FF | Change BBF pedestal to F/F | \$ | N/C |
| CPU | Change BBF or FF pedestal to CPU pedestal - inside dimensions: 14 3/16"Wx17 13/16"Dx22 3/8"H - hinged door (non-locking), two ventilation slots in back panel and inside end panel grommet | \$ | 110 |
| PNT | Change lateral file or file center pedestal to printer pedestal - inside dimensions: 27 1/2"Wx17 13/16"Dx22 3/8"H - slide out printer shelf, wall access cut-out in back modesty and inside end panel grommet | \$ | 110 |
| NM | No metal inlay on back panel | \$ | -60 |
| LK | Locking of individual doors, drawers or pedestals (where not standard) | \$ | 55 |
| GR | Wire mgmt grommet (note location) | \$ | 61 |
| WA | Wall access cut-out (modesty panels on bridges, credenzas, desks and returns) | \$ | N/C |
| HB | Optional half modesty panel on units with backs | \$ | N/C |
| AHM | Electronic height adjustable mechanism added to worksurface, lifting column, control box, control pendant, with memory settings, motor cable, main power cable, anti-collision dongle. Lower metal lifts and anti-tip brackets. Adjusts from 30" - 44"H | | Contact Customer Service |

CONNECTION SERIES

Warranty and Certification

All products listed are warranted against defects of material and workmanship under normal use and service for a minimum of 10 years from the date of installation (see full warranty information). All products listed are Level 2 BIFMA certified.

Veneer

Veneer on all exposed surfaces is American Black Walnut, Cherry, or Maple. Outside surface veneers are book matched to provide proper grain consistency and uniform grain appearance. Drawer fronts are vertical grain cherry, maple, or walnut veneers and matched in selected sets to ensure proper veneer balance and uniform grain appearance. Double Cut veneer is also available with a 10% upcharge.

Wood Veneer Tops

1 3/16" thick tops utilizing 3-ply construction with solid cherry, maple or walnut wood band edging, shaped with five edge details. Both user side and approach side tops are shaped with the selected edge detail on 30", 36" and 42" depth tops. 24" depth tops are shaped on user side only unless otherwise noted. Top cores are high density particle board or fiber board dependent upon the application. Cherry, maple, oak or walnut veneer tops are standard. High pressure laminate tops are optional, with many standard finishes having matching laminate tops available (call customer service for options).

Modesty Panels and End Panels

End panels are 29/32" thick with a 3-ply construction with a black PVC band along top edge and a solid lumber band on the bottom edge of the panel to prevent tear out. Modesty panels are 3/4" thick, 3-ply construction. All veneers are vertical grain cherry, maple, oak or walnut veneers matched to ensure proper veneer balance, provide proper grain consistency and uniform grain appearance. Full modesty panels are standard for desk, bridge, and kneespace credenzas with optional half modesty options available.

Drawers

Drawer fronts are 3-ply hardwood construction, 3/4" thick with book matched veneers to provide proper grain consistency and uniform grain appearance. All drawers utilize five sided drawer construction. Drawer side material is 3 ply 12mm vinyl wrapped particleboard with miterfold construction. Drawers are constructed with an attached drawer front.

Doors

Doors are 3/4" thick 3-ply construction with vertical grain cherry, maple or walnut veneers and matched in selected sets to ensure proper veneer balance and uniform grain appearance. European style hidden hinges are used on all doors. Tempered glass conforming to ASTM C 1048 is used in all glass doors.

Shelves

Shelves are 3-ply construction with a 1/4" cherry, maple, oak or walnut rim on the front edge. All shelves are full depth of the interior compartment unless specified otherwise. Faces are book matched walnut, cherry or oak veneer. Hutch shelves are cherry, maple, oak or walnut faced on both sides. A minimum of one adjustable or fixed shelf is provided with each cabinet storage unit (see individual unit for details). Adjustable shelves are provided with metal adjustable shelf hardware supports.

Bases

Height adjustable leveling glides are mounted in each corner with a threaded metal insert capped with a nylon glide that is height adjustable to approx. 1 1/2" to ensure proper leveling of the unit to varying floor conditions.

Hardware

Drawer Suspensions – File, box, pencil and center drawers utilize steel "A" grade heavy duty metal slides for smooth operation. All pedestal drawers have 100 % full extension slides. All suspension systems feature positive and cushioned in/out stops. All box, center, and tray drawers are removable without tools and the suspensions are designed to prevent accidental removal.

Locks – All desks and credenzas utilize pedestal locking. Lateral files are keyed as standard and feature central locking with anti-tip drawer interlock systems. Individual pieces are shipped random keyed. Units may be keyed alike upon special request. A minimum of fifty key changes (numbers) are available. Core lock changes are available (contact customer service)

Drawer Pulls – Three drawer pull options are available in aluminum finish.

Hinges – European style hidden hinges on all hinged doors.

Wire Management – Black wire management grommets are standard on all returns and bridge work surfaces located in back center of the tops. Black wire management access grommets are standard on all credenzas, hutches, overhead storage units and computer tables located in back panel. Optional additional black wire management grommets, wall access cut-outs, wiring harness and wiring channels along with integrated cable management to conceal power and data cords are also available. Optional data ports accessible at work surface height (see accessories).

Chassis Construction

Construction technique is dowel construction and heavily glue blocked with hardwood cleats for maximum strength.

Filing

File drawers use an easily adjustable filing rail system which can be positioned to accommodate front to back or side to side letter or legal filing.

Finish

All exposed surfaces are finished with a UV inhibitor catalyzed varnish finish to ensure maximum durability, chemical resistance, color retention and clarity. All exterior surfaces are finished in the following multi-step sequence: sap stain, NGR stain, wash coat, wash coat sand, filler spray, filler wipe, sealer spray, sealer sand, varnish spray, varnish sand, varnish spray. Moisture content for all wooden parts is between 5 - 9% prior to sealing. Drawer interiors and exteriors are UV prefinished with sealer, sealer sand, and varnished. Custom finish matches are available, contact customer service for request

CONNECTION SERIES

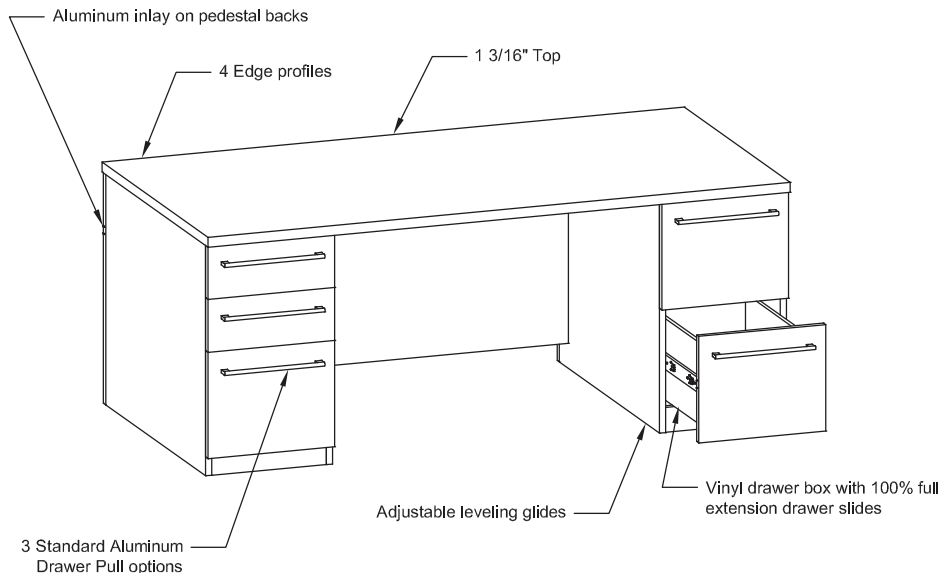

Ordering Information

Use the following steps to correctly place your order:

- 1) Determine the correct model number for the item you are selecting - example:
9000FR7236 = Double pedestal desk, 36" x 72" x 30"H
- 2) Determine the proper finish selection for the item - example:
9000FR7236-CC = Double pedestal desk, 36" x 72" x 30"H, in Crescent Cherry
- 3) Determine the edge profile you may wish for the item - example:
9000FR7236-CC-B = Double pedestal desk, 36" x 72" x 30"H, in Crescent Cherry finish, with Kerf edge detail
- 4) Determine any additional options you may wish for the item - example:
9000FR7236-CC-B-ABS = Double pedestal desk, 36" x 72" x 30"H, in Crescent Cherry, with Kerf edge detail, with Aluminum Bar - Short pulls

Standard Profile Options

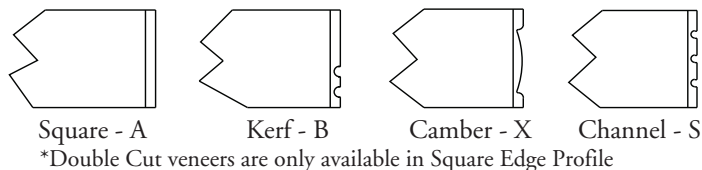

Standard Pull Options

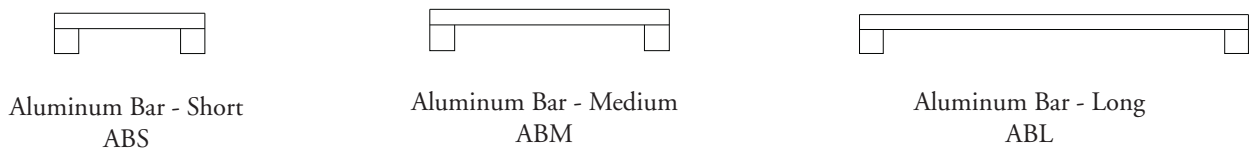

CONNECTION SERIES

List Price

Double Pedestal Desks

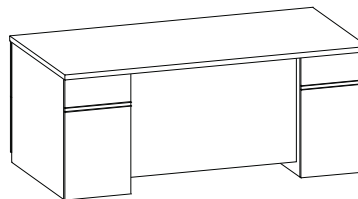

Approach side view

9000FK8442_ _ **\$3566**
 Double pedestal desk with arc conference top, box/box/file pedestal (LH), file/file pedestal (RH),
 pedestal locking, 10" center approach side overhang, stepped modesty panel
 46" W Kneespace
 42" x 84" x 30"H (455 lbs)
9000CD36 Optional Center Drawer **\$374**

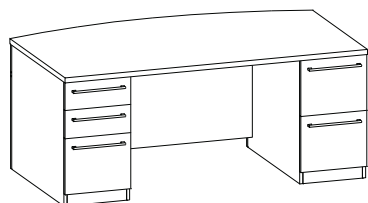

9000FK7242_ _ **\$3444**
 Double pedestal desk with arc conference top, box/box/file pedestal (LH), file/file pedestal (RH),
 pedestal locking, 10" center approach side overhang, stepped modesty panel
 40" W Kneespace
 42" x 72" x 30"H (405 lbs)
9000CD36 Optional Center Drawer **\$374**

9000FK7236_ _ **\$3281**
 Double pedestal desk with arc conference top, box/box/file pedestal (LH), file/file pedestal (RH),
 pedestal locking, 10" approach side overhang, stepped modesty panel
 40" W Kneespace
 36" x 72" x 30"H (360 lbs)
9000CD36 Optional Center Drawer **\$374**

9000FC8442_ _ **\$2933**
 Double pedestal desk with conference top, box/box/file pedestal (LH), file/file pedestal (RH),
 pedestal locking, 10" center approach side overhang, stepped modesty panel
 46" W Kneespace
 42" x 84" x 30"H (455 lbs)
9000CD36 Optional Center Drawer **\$374**

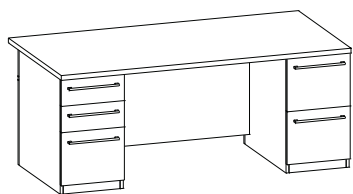

9000FC7236_ _ **\$2811**
 Double pedestal desk with conference top, box/box/file pedestal (LH), file/file pedestal (RH),
 pedestal locking, 10" center approach side overhang, stepped modesty panel
 40" W Kneespace
 42" x 72" x 30"H (405 lbs)
9000CD36 Optional Center Drawer **\$374**

9000FC6636_ _ **\$2734**
 Double pedestal desk with conference top, box/box/file pedestal (LH), file/file pedestal (RH),
 pedestal locking, 10" center approach side overhang, stepped modesty panel
 34" W Kneespace
 36" x 66" x 30"H (340 lbs)
9000CD30 Optional Center Drawer **\$374**

CONNECTION SERIES

List Price

Double Pedestal Desks

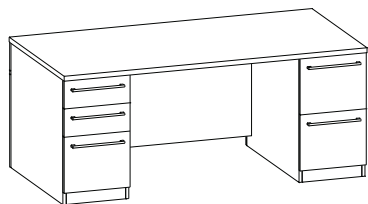

9000FR7236_ _ \$2913

Double pedestal desk with fitted top, box/box/file pedestal (LH), file/file pedestal (RH), pedestal locking, recessed modesty panel
40" W Kneespace
36" x 72" x 30"H (365 lbs)

9000CD36 Optional Center Drawer \$374

9000FR7230_ _ \$2848

Double pedestal desk with fitted top, box/box/file pedestal (LH), file/file pedestal (RH), pedestal locking, recessed modesty panel
40" W Kneespace
30" x 72" x 30"H (335 lbs)

9000CD36 Optional Center Drawer \$374

9000FR6636_ _ \$2875

Double pedestal desk with fitted top, box/box/file pedestal (LH), file/file pedestal (RH), pedestal locking, recessed modesty panel
34" W Kneespace
36" x 66" x 30"H (345 lbs)

9000CD30 Optional Center Drawer \$374

9000FR6630_ _ \$2749

Double pedestal desk with fitted top, box/box/file pedestal (LH), file/file pedestal (RH), pedestal locking, recessed modesty panel
34" W Kneespace
30" x 66" x 30"H (320 lbs)

9000CD30 Optional Center Drawer \$374

9000FR6030_ _ \$2698

Double pedestal desk with fitted top, box/box/file pedestal (LH), file/file pedestal (RH), pedestal locking, recessed modesty panel
28" W Kneespace
30" x 60" x 30"H (305 lbs)

9000CD24 Optional Center Drawer \$374

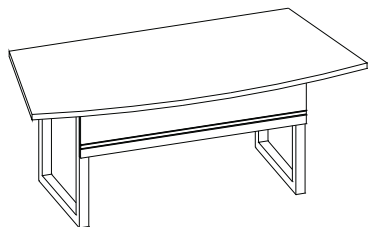

9000TK7242_ _ \$2193

Arc top table desk with metal frame ends
42" x 72" x 30"H (175 lbs)

9000CD36 Optional Center Drawer \$374

9000TK7236_ _ \$2066

Arc top table desk with metal frame ends
36" x 72" x 30"H (150 lbs)

9000CD36 Optional Center Drawer \$374

9000TK6636_ _ \$2004

Arc top table desk with metal frame ends
36" x 66" x 30"H (175 lbs)

9000CD30 Optional Center Drawer \$374

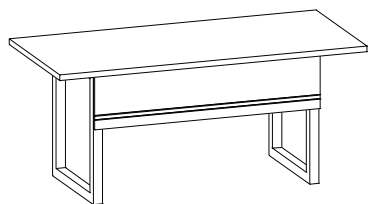

9000TD7242_ _ \$2088

Table desk with metal frame ends
42" x 72" x 30"H (175 lbs)

9000CD36 Optional Center Drawer \$374

9000TD7236_ _ \$2035

Table desk with metal frame ends
36" x 72" x 30"H (150 lbs)

9000CD36 Optional Center Drawer \$374

9000TD6630_ _ \$1969

Table desk with metal frame ends
30" x 66" x 30"H (125 lbs)

9000CD30 Optional Center Drawer \$374

CONNECTION SERIES

List Price

Credenzas

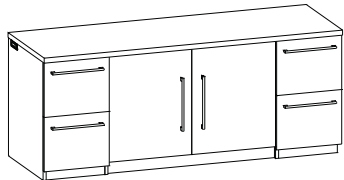

9000DC8424-4__ \$3197

Credenza with hinged door storage, two file/file pedestals (locking), hinged door storage area (non-locking) with one adjustable shelf
24" x 84" x 30"H (lbs)
Optional locking doors (LK) - add \$55 list

9000DC8420-4__ \$3095

Credenza with hinged door storage, two file/file pedestals (locking), hinged door storage area (non-locking) with one adjustable shelf
20" x 84" x 30"H (lbs)
Optional locking doors (LK) - add \$55 list

9000DC7224-4__ \$2816

Credenza with hinged door storage, two file/file pedestals (locking), hinged door storage area (non-locking) with one adjustable shelf
24" x 72" x 30"H (370 lbs)
Optional locking doors (LK) - add \$55 list

9000DC7220-4__ \$2714

Credenza with hinged door storage, two file/file pedestals (locking), hinged door storage area (non-locking) with one adjustable shelf
20" x 72" x 30"H (324 lbs)
Optional locking doors (LK) - add \$55 list

9000DC6624-4__ \$2625

Credenza with hinged door storage, two file/file pedestals (locking), hinged door storage area (non-locking) with one adjustable shelf
24" x 66" x 30"H (283 lbs)
Optional locking doors (LK) - add \$55 list

9000DC6620-4__ \$2523

Credenza with hinged door storage, two file/file pedestals (locking), hinged door storage area (non-locking) with one adjustable shelf
20" x 66" x 30"H (248 lbs)
Optional locking doors (LK) - add \$55 list

9000DC8424-3__ \$2758

Credenza with kneespace, two file/file pedestals (locking), wire mgmt grommet in ends and back
40" W kneespace
24" x 84" x 30"H (265 lbs)

9000DC8420-3__ \$2656

Credenza with kneespace, two file/file pedestals (locking), wire mgmt grommet in ends and back
40" W kneespace
20" x 84" x 30"H (265 lbs)

9000DC7224-3__ \$2507

Credenza with kneespace, two file/file pedestals (locking), wire mgmt grommet in ends and back
34" W kneespace
24" x 72" x 30"H (270 lbs)

9000DC7220-3__ \$2405

Credenza with kneespace, two file/file pedestals (locking), wire mgmt grommet in ends and back
34" W kneespace
20" x 72" x 30"H (236 lbs)

9000DC6624-3__ \$2381

Credenza with kneespace, two file/file pedestals (locking), wire mgmt grommet in ends and back
28" W kneespace
24" x 66" x 30"H (248 lbs)

9000DC6620-3__ \$2279

Credenza with kneespace, two file/file pedestals (locking), wire mgmt grommet in ends and back
28" W kneespace
20" x 66" x 30"H (217 lbs)

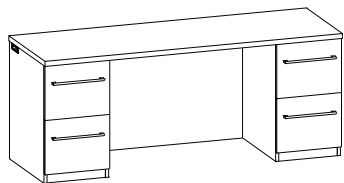

CONNECTION SERIES

List Price

Storage Units

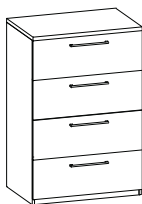

9000LF4V-3624__ _ \$2515
 Four drawer lateral file, legal or letter cross filing, central locking
 24" x 36" x 57"H (210 lbs)

9000LF4V-3620__ _ \$2464
 Four drawer lateral file, legal or letter cross filing, central locking
 20" x 36" x 57"H (184 lbs)



9000LF3V-3624__ _ \$2209
 Three drawer lateral file, legal or letter cross filing, central locking
 24" x 36" x 42"H (190 lbs)

9000LF3V-3620__ _ \$2158
 Three drawer lateral file, legal or letter cross filing, central locking
 20" x 36" x 42"H (167 lbs)



9000LF2-3624__ _ \$1704
 Two drawer lateral file, legal or letter cross filing, central locking
 24" x 36" x 30"H (155 lbs)

9000LF2-3620__ _ \$1653
 Two drawer lateral file, legal or letter cross filing, central locking
 20" x 36" x 30"H (136 lbs)

9000LF4-7224__ _ \$3020
 Double unit lateral file, legal or letter cross filing, central locking
 24" x 72" x 30"H (235 lbs)

9000LF4-7220__ _ \$2918
 Double unit lateral file, legal or letter cross filing, central locking
 20" x 72" x 30"H (235 lbs)

9000LF4-6624__ _ \$2974
 Double unit lateral file, legal or letter cross filing, central locking
 24" x 66" x 30"H (215 lbs)

9000LF4-6620__ _ \$2872
 Double unit lateral file, legal or letter cross filing, central locking
 20" x 66" x 30"H (215 lbs)

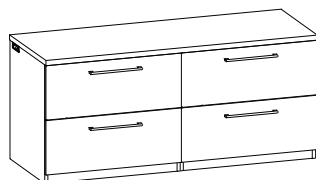

9000DSC72-24__ _ \$2727
 Four door hinged door cabinet (non-locking), one adjustable shelf per section
 24" x 72" x 30"H (300 lbs)
 Optional locking doors (LK) - add \$110 list

9000DSC72-20__ _ \$2625
 Four door hinged door cabinet (non-locking), one adjustable shelf per section
 20" x 72" x 30"H (300 lbs)
 Optional locking doors (LK) - add \$110 list

9000DSC66-24__ _ \$2615
 Four door hinged door cabinet (non-locking), one adjustable shelf per section
 24" x 66" x 30"H (260 lbs)
 Optional locking doors (LK) - add \$110 list

9000DSC66-20__ _ \$2513
 Four door hinged door cabinet (non-locking), one adjustable shelf per section
 20" x 66" x 30"H (260 lbs)
 Optional locking doors (LK) - add \$110 list

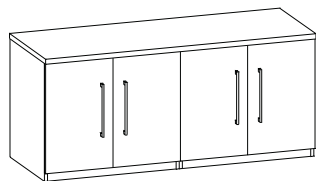

9000DSC36-24__ _ \$1320
 Two door hinged door cabinet (non-locking), one adjustable shelf
 24" x 36" x 30"H (152 lbs)
 Optional locking doors (LK) - add \$55 list

9000DSC36-20__ _ \$1259
 Two door hinged door cabinet (non-locking), one adjustable shelf
 20" x 36" x 30"H (133 lbs)
 Optional locking doors (LK) - add \$55 list

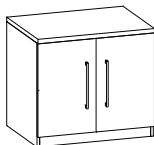

CONNECTION SERIES

List Price

Storage Units

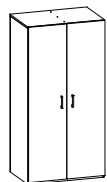

9000WC72-24_ _ **\$2619**
 Wardrobe, right side clothing carrier, left side four adjustable shelves, non-locking
 24" x 36" x 72"H (275 lbs) - Optional locking doors (LK) - add \$55 list

9000WC72-20_ _ **\$2517**
 Wardrobe, right side clothing carrier, left side four adjustable shelves, non-locking
 20" x 36" x 72"H (248 lbs) - Optional locking doors (LK) - add \$55 list

9000WC7218R-24_ _ hinged right (shown) **\$2269**

9000WC7218L-24_ _ hinged left
 Single unit wardrobe, top shelf, coat rod, non-locking left or right hinged door,
 24" x 18" x 72"H (140 lbs) - Optional locking doors (LK) - add \$55 list

9000WC7218R-20_ _ hinged right (shown) **\$2192**

9000WC7218L-20_ _ hinged left
 Single unit wardrobe, top shelf, coat rod, non-locking left or right hinged door
 20" x 18" x 72"H (123 lbs) - Optional locking doors (LK) - add \$55 list

9000WSFFR-24_ _ right hand wardrobe (shown) **\$3334**

9000WSFFL-24_ _ left hand wardrobe
 Utility cabinet, wardrobe unit with hinged door (non-locking), top shelf, coat rod, file/file pedestal - bottom
 (locking), hinged door storage area (non-locking) with two adjustable shelves - top (right hand shown)
 24" x 36" x 72"H (350 lbs) - Optional locking doors (LK) - add \$55 list

9000WSFFR-20_ _ right hand wardrobe (shown) **\$3232**

9000WSFFL-20_ _ left hand wardrobe
 Utility cabinet, wardrobe unit with hinged door (non-locking), top shelf, coat rod, file/file pedestal - bottom
 (locking), hinged door storage area (non-locking) with two adjustable shelves - top (right hand shown)
 20" x 36" x 72"H (350 lbs) - Optional locking doors (LK) - add \$55 list

9000SCFF7218R-24_ _ hinged right **\$2465**

9000SCFF7218L-24_ _ hinged left (shown)
 Utility cabinet, file/file pedestal - bottom (locking), hinged door storage area (non-locking)
 with two adjustable shelves - top (left hand hinged door shown)
 24" x 18" x 72"H (260 lbs) - Optional locking doors (LK) - add \$55 list

9000SCFF7218R-20_ _ hinged right **\$2388**

9000SCFF7218L-20_ _ hinged left (shown)
 Utility cabinet, file/file pedestal - bottom (locking), hinged door storage area (non-locking)
 with two adjustable shelves - top (left hand hinged door shown)
 20" x 18" x 72"H (260 lbs) - Optional locking doors (LK) - add \$55 list

9000SC72-24_ _ **\$3162**

Storage cabinet, hinged doors (non-locking), four adjustable shelves
 24" x 36" x 72"H (285 lbs) - Optional locking doors (LK) - add \$55 list

9000SC72-20_ _ **\$3060**

Storage cabinet, hinged doors (non-locking), four adjustable shelves
 20" x 36" x 72"H (250 lbs) - Optional locking doors (LK) - add \$55 list

9000SC7218R-24_ _ hinged right (shown) **\$2505**

9000SC7218L-24_ _ hinged left
 Storage cabinet, non-locking left or right hinged door, four adjustable shelves
 24" x 18" x 72"H (140 lbs) - Optional locking doors (LK) - add \$55 list

9000SC7218R-20_ _ hinged right (shown) **\$2428**

9000SC7218L-20_ _ hinged left
 Storage cabinet, non-locking left or right hinged door, four adjustable shelves
 20" x 18" x 72"H (123 lbs) - Optional locking doors (LK) - add \$55 list

9000LF/BC-24_ _ **\$3342**

Storage cabinet / Lateral file, upper hinged door storage (non-locking) with two adjustable shelves,
 bottom - two lateral file drawers (locking), legal or letter filing
 24" x 36" x 72"H (310 lbs) - Optional locking doors (LK) - add \$55 list

9000LF/BC-20_ _ **\$3240**

Storage cabinet / Lateral file, upper hinged door storage (non-locking) with two adjustable shelves,
 bottom - two lateral file drawers (locking), legal or letter filing
 20" x 36" x 72"H (310 lbs) - Optional locking doors (LK) - add \$55 list

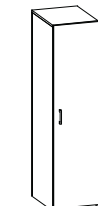
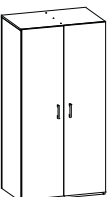
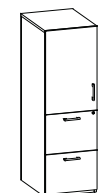
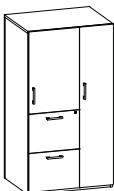
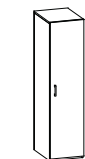

CONNECTION SERIES

List Price

Corner Bookcases

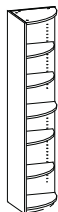

9000CBCL72-24
9000CBCR72-24 (shown)
 Corner Bookcase with four adjustable shelves
 24" x 18" x 72"H (140 lbs)

\$1520

9000CBCL72-20
9000CBCR72-20 (shown)
 Corner Bookcase with four adjustable shelves
 20" x 18" x 72"H (140 lbs)

\$1408

Bookcases

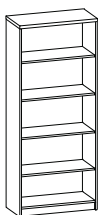

9000BC72_
 Open bookcase with three adjustable shelves, one fixed middle shelf and one fixed bottom shelf
 16" x 36" x 72"H (215 lbs)

\$1665

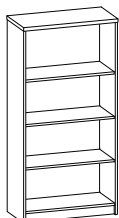

9000BC54_
 Open bookcase with two adjustable shelves, one fixed middle shelf and one fixed bottom shelf
 16" x 36" x 54"H (160 lbs)

\$1418

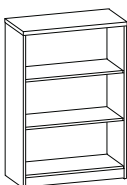

9000BC42_
 Open bookcase with two adjustable shelves, one fixed bottom shelf
 16" x 36" x 42"H (135 lbs)

\$1325

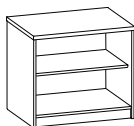

9000BC30-24_
 Open bookcase with one adjustable shelf and one fixed bottom shelf
 24" x 32" x 30"H (132 lbs)

\$1092

9000BC30-20_
 Open bookcase with one adjustable shelf and one fixed bottom shelf
 20" x 32" x 30"H (115 lbs)

\$1015

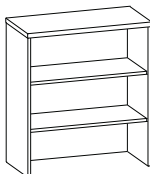

9000BCO42_
 Stacking bookcase, two adjustable shelves
 16" x 36" x 42"H (100 lbs)

\$869

CONNECTION SERIES

List Price

Computer Desk Workstations - Single Pedestal Desks

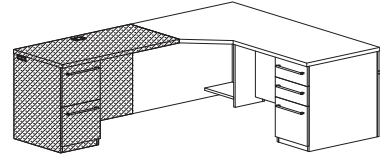
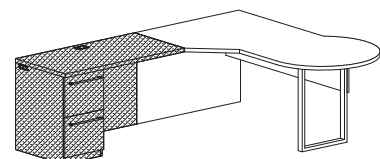
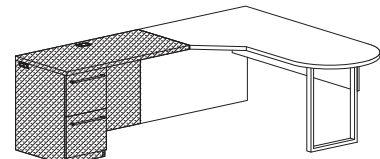
| | |
|--|--|
| | <p>9000ECWSR7242-24_ _ \$2780 Executive single pedestal computer desk (RH), box/box/file pedestal (locking), 42" corner unit, wire mgmt grommet in wing end, stepped modesty panel, for 24" return 30"- 42" x 72" x 30"H (325 lbs)</p> |
| | <p>9000ECWSR7242-20_ _ \$2780 Executive single pedestal computer desk (RH), box/box/file pedestal (locking), 42" corner unit, wire mgmt grommet in wing end, stepped modesty panel, for 20" deep return 30"- 42" x 72" x 30"H (325 lbs)</p> |
| | <p>9000ECWSR7236-24_ _ \$2658 Executive single pedestal computer desk (RH), box/box/file pedestal (locking), 36" corner unit, wire mgmt grommet in wing end, stepped modesty panel, for 24" deep return 30"- 42" x 72" x 30"H (325 lbs)</p> |
|  | <p>9000ECWSR7236-20_ _ \$2658 Executive single pedestal computer desk (RH), box/box/file pedestal (locking), 36" corner unit, wire mgmt grommet in wing end, stepped modesty panel, for 20" deep return 24"- 36" x 72" x 30"H (325 lbs)</p> |
| | <p>9000ECWSR6636-24_ _ \$2515 Executive single pedestal computer desk (RH), box/box/file pedestal (locking), 36" corner unit, wire mgmt grommet in wing end, stepped modesty panel, for 24" deep return 24"- 36" x 66" x 30"H (325 lbs)</p> |
| | <p>9000ECWSR6636-20_ _ \$2515 Executive single pedestal computer desk (RH), box/box/file pedestal (locking), 36" corner unit, wire mgmt grommet in wing end, stepped modesty panel, for 20" deep return 24"- 36" x 66" x 30"H (325 lbs)</p> |
| | <p>9000ECWPR7242-24_ _ \$2316 Freestanding P-Top computer desk (RH), 36" diameter end, with metal pedestal end, 42" corner unit, one wire mgmt grommet in wing end, for 24" deep return 30"-42" x 72" x 30"H (195 lbs)</p> |
|  | <p>9000ECWPR7242-20_ _ \$2316 Freestanding P-Top computer desk (RH), 36" diameter end, with metal pedestal end, 42" corner unit, one wire mgmt grommet in wing end, for 20" deep return 30"-42" x 72" x 30"H (195 lbs)</p> |
| | <p>9000ECWBR7242-24_ _ \$1908 Freestanding bullet top computer desk (RH), 30" diameter end, with metal pedestal end, 42" corner unit, one wire mgmt grommet in wing end, for 24" deep return 30"-42" x 72" x 30"H (195 lbs)</p> |
| | <p>9000ECWBR7242-20_ _ \$1908 Freestanding bullet top computer desk (RH), 30" diameter end, with metal pedestal end, 42" corner unit, one wire mgmt grommet in wing end, for 20" deep return 30"-42" x 72" x 30"H (195 lbs)</p> |
| | <p>9000ECWBR7236-24_ _ \$1759 Freestanding bullet top computer desk (RH), 30" diameter end, with metal pedestal end, 36" corner unit, one wire mgmt grommet in wing end, for 24" deep return 24"-36" x 72" x 30"H (195 lbs)</p> |
|  | <p>9000ECWBR7236-20_ _ \$1759 Freestanding bullet top computer desk (RH), 30" diameter end, with metal pedestal end, 36" corner unit, one wire mgmt grommet in wing end, for 20" deep return 24"-36" x 72" x 30"H (195 lbs)</p> |
| | <p>9000ECWBR6636-24_ _ \$1647 Freestanding bullet top computer desk (RH), 30" diameter end, with metal pedestal end, 36" corner unit, one wire mgmt grommet in wing end, for 24" deep return 24"-36" x 66" x 30"H (195 lbs)</p> |
| | <p>9000ECWBR6636-20_ _ \$1647 Freestanding bullet top computer desk (RH), 30" diameter end, with metal pedestal end, 36" corner unit, one wire mgmt grommet in wing end, for 20" deep return 24"-36" x 66" x 30"H (195 lbs)</p> |

CONNECTION SERIES

List Price

Computer Desk Workstations - Executive Returns

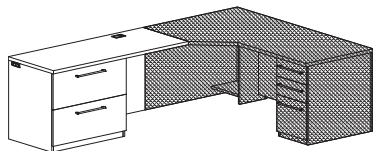

9000ERL2460LF__ \$2061

Executive height return (LH), two lateral file drawers (locking), wire mgmt grommets in top, back and end, 28"W kneespace 24" x 60" x 30"H (228 lbs)

9000ERL2060LF__ \$1989

Executive height return (LH), two lateral file drawers (locking), wire mgmt grommets in top, back and end, 28"W kneespace 20" x 60" x 30"H (208 lbs)

9000ERL2454LF__ \$2012

Executive height return (LH), two lateral file drawers (locking), wire mgmt grommets in top, back and end, 22"W kneespace 24" x 54" x 30"H (215 lbs)

9000ERL2054LF__ \$1941

Executive height return (LH), two lateral file drawers (locking), wire mgmt grommets in top, back and end, 22"W kneespace 20" x 54" x 30"H (195 lbs)

9000ERL2454__ \$1745

Executive height return (LH), file/file pedestal (locking), wire mgmt grommets in top, back and end, 38"W kneespace 24" x 54" x 30"H (140 lbs)

9000ERL2054__ \$1673

Executive height return (LH), file/file pedestal (locking), wire mgmt grommets in top, back and end, 38"W kneespace 20" x 54" x 30"H (140 lbs)

9000ERL2448__ \$1673

Executive height return (LH), file/file pedestal (locking), wire mgmt grommets in top, back and end, 32"W kneespace 24" x 48" x 30"H (140 lbs)

9000ERL2048__ \$1602

Executive height return (LH), file/file pedestal (locking), wire mgmt grommets in top, back and end, 32"W kneespace 20" x 48" x 30"H (140 lbs)

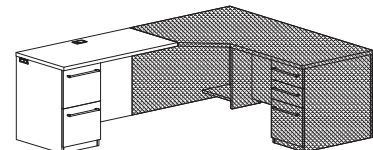

9000ERL2442__ \$1624

Executive height return (LH), file/file pedestal (locking), wire mgmt grommets in top, back and end, 26"W kneespace 24" x 42" x 30"H (140 lbs)

9000ERL2042__ \$1553

Executive height return (LH), file/file pedestal (locking), wire mgmt grommets in top, back and end, 26"W kneespace 20" x 42" x 30"H (140 lbs)

9000ERL2436__ \$1530

Executive height return (LH), file/file pedestal (locking), wire mgmt grommets in top, back and end, 20"W kneespace 24" x 36" x 30"H (140 lbs)

9000ERL2036__ \$1459

Executive height return (LH), file/file pedestal (locking), wire mgmt grommets in top, back and end, 20"W kneespace 20" x 36" x 30"H (140 lbs)

CONNECTION SERIES

List Price

Computer Desk Workstations - Single Pedestal Desks

9000ECWSL7242-24_ _ **\$2780**
 Executive single pedestal computer desk (LH), box/box/file pedestal (locking), 42" corner unit, wire mgmt grommet in wing end, stepped modesty panel, for 24" return
 30"- 42" x 72" x 30"H (325 lbs)

9000ECWSL7242-20_ _ **\$2780**
 Executive single pedestal computer desk (LH), box/box/file pedestal (locking), 42" corner unit, wire mgmt grommet in wing end, stepped modesty panel, for 20" deep return
 30"- 42" x 72" x 30"H (325 lbs)

9000ECWSL7236-24_ _ **\$2658**
 Executive single pedestal computer desk (LH), box/box/file pedestal (locking), 36" corner unit, wire mgmt grommet in wing end, stepped modesty panel, for 24" deep return
 30"- 42" x 72" x 30"H (325 lbs)

9000ECWSL7236-20_ _ **\$2658**
 Executive single pedestal computer desk (LH), box/box/file pedestal (locking), 36" corner unit, wire mgmt grommet in wing end, stepped modesty panel, for 20" deep return
 24"- 36" x 72" x 30"H (325 lbs)

9000ECWSL6636-24_ _ **\$2515**
 Executive single pedestal computer desk (LH), box/box/file pedestal (locking), 36" corner unit, wire mgmt grommet in wing end, stepped modesty panel, for 24" deep return
 24"- 36" x 66" x 30"H (325 lbs)

9000ECWSL6636-20_ _ **\$2515**
 Executive single pedestal computer desk (LH), box/box/file pedestal (locking), 36" corner unit, wire mgmt grommet in wing end, stepped modesty panel, for 20" deep return
 24"- 36" x 66" x 30"H (325 lbs)

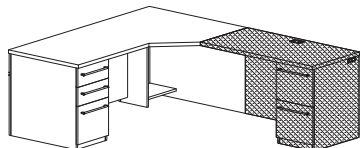

9000ECWPL7242-24_ _ **\$2316**
 Freestanding P-Top computer desk (LH), 36" diameter end, with metal pedestal end, 42" corner unit, one wire mgmt grommet in wing end, for 24" deep return
 30"-42" x 72" x 30"H (195 lbs)

9000ECWPL7242-20_ _ **\$2316**
 Freestanding P-Top computer desk (LH), 36" diameter end, with metal pedestal end, 42" corner unit, one wire mgmt grommet in wing end, for 20" deep return
 30"-42" x 72" x 30"H (195 lbs)

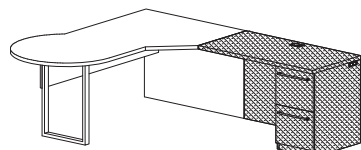

9000ECWBL7242-24_ _ **\$1908**
 Freestanding bullet top computer desk (LH), 30" diameter end, with metal pedestal end, 42" corner unit, one wire mgmt grommet in wing end, for 24" deep return
 30"-42" x 72" x 30"H (195 lbs)

9000ECWBL7242-20_ _ **\$1908**
 Freestanding bullet top computer desk (LH), 30" diameter end, with metal pedestal end, 42" corner unit, one wire mgmt grommet in wing end, for 20" deep return
 30"-42" x 72" x 30"H (195 lbs)

9000ECWBL7236-24_ _ **\$1759**
 Freestanding bullet top computer desk (LH), 30" diameter end, with metal pedestal end, 36" corner unit, one wire mgmt grommet in wing end, for 24" deep return
 24"-36" x 72" x 30"H (195 lbs)

9000ECWBL7236-20_ _ **\$1759**
 Freestanding bullet top computer desk (LH), 30" diameter end, with metal pedestal end, 36" corner unit, one wire mgmt grommet in wing end, for 20" deep return
 24"-36" x 72" x 30"H (195 lbs)

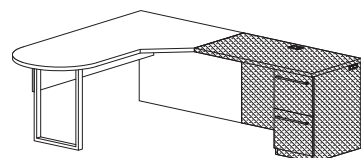

9000ECWBL6636-24_ _ **\$1647**
 Freestanding bullet top computer desk (LH), 30" diameter end, with metal pedestal end, 36" corner unit, one wire mgmt grommet in wing end, for 24" deep return
 24"-36" x 66" x 30"H (195 lbs)

9000ECWBL6636-20_ _ **\$1647**
 Freestanding bullet top computer desk (LH), 30" diameter end, with metal pedestal end, 36" corner unit, one wire mgmt grommet in wing end, for 20" deep return
 24"-36" x 66" x 30"H (195 lbs)

CONNECTION SERIES

List Price

Computer Desk Workstations - Executive Returns

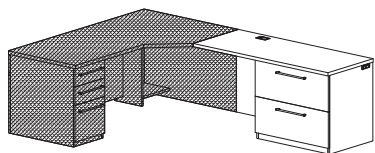

9000ERR2460LF__ **\$2061**

Executive height return (RH), two lateral file drawers (locking), wire mgmt grommets in top, back and end, 28"W kneespace 24" x 60" x 30"H (228 lbs)

9000ERR2060LF__ **\$1989**

Executive height return (RH), two lateral file drawers (locking), wire mgmt grommets in top, back and end, 28"W kneespace 20" x 60" x 30"H (208 lbs)

9000ERR2454LF__ **\$2012**

Executive height return (RH), two lateral file drawers (locking), wire mgmt grommets in top, back and end, 22"W kneespace 24" x 54" x 30"H (215 lbs)

9000ERR2054LF__ **\$1941**

Executive height return (RH), two lateral file drawers (locking), wire mgmt grommets in top, back and end, 22"W kneespace 20" x 54" x 30"H (195 lbs)

9000ERR2454__ **\$1745**

Executive height return (RH), file/file pedestal (locking), wire mgmt grommets in top, back and end, 38"W kneespace 24" x 54" x 30"H (140 lbs)

9000ERR2054__ **\$1673**

Executive height return (RH), file/file pedestal (locking), wire mgmt grommets in top, back and end, 38"W kneespace 20" x 54" x 30"H (140 lbs)

9000ERR2448__ **\$1673**

Executive height return (RH), file/file pedestal (locking), wire mgmt grommets in top, back and end, 32"W kneespace 24" x 48" x 30"H (140 lbs)

9000ERR2048__ **\$1602**

Executive height return (RH), file/file pedestal (locking), wire mgmt grommets in top, back and end, 32"W kneespace 20" x 48" x 30"H (140 lbs)

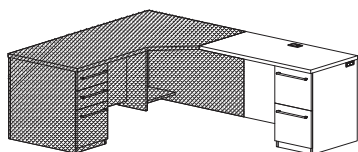

9000ERR2442__ **\$1624**

Executive height return (RH), file/file pedestal (locking), wire mgmt grommets in top, back and end, 26"W kneespace 24" x 42" x 30"H (140 lbs)

9000ERR2042__ **\$1553**

Executive height return (RH), file/file pedestal (locking), wire mgmt grommets in top, back and end, 26"W kneespace 20" x 42" x 30"H (140 lbs)

9000ERR2436__ **\$1530**

Executive height return (RH), file/file pedestal (locking), wire mgmt grommets in top, back and end, 20"W kneespace 24" x 36" x 30"H (140 lbs)

9000ERR2036__ **\$1459**

Executive height return (RH), file/file pedestal (locking), wire mgmt grommets in top, back and end, 20"W kneespace 20" x 36" x 30"H (140 lbs)

CONNECTION SERIES

List Price

Executive Workstations - Single Pedestal Desks

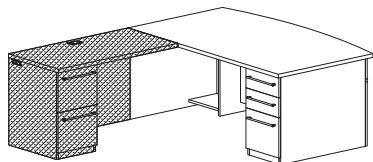

9000KSPR7242_ _ **\$2811**

Executive single pedestal desk (RH) with arc conference top, box/box/file pedestal (locking), 10" center overhang, stepped modesty panel
42" x 72" x 30"H (335 lbs)

9000KSPR7236_ _ **\$2647**

Executive single pedestal desk (RH) with arc conference top, box/box/file pedestal (locking), 10" center overhang, stepped modesty panel
36" x 72" x 30"H (305 lbs)

9000SPR7236_ _ **\$2505**

Executive single pedestal desk (RH), box/box/file pedestal (locking), 6" center overhang, stepped modesty panel
36" x 72" x 30"H (330 lbs)

9000SPR7230_ _ **\$2367**

Executive single pedestal desk (RH), box/box/file pedestal (locking), 6" center overhang, stepped modesty panel
30" x 72" x 30"H (300 lbs)

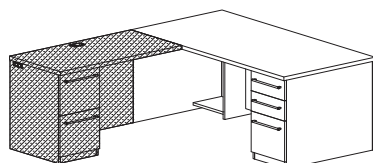

9000SPR6636_ _ **\$2467**

Executive single pedestal desk (RH), box/box/file pedestal (locking), 6" center overhang, stepped modesty panel
36" x 66" x 30"H (290 lbs)

9000SPR6630_ _ **\$2341**

Executive single pedestal desk (RH), box/box/file pedestal (locking), 6" center overhang, stepped modesty panel
30" x 66" x 30"H (275 lbs)

9000WSP7236R_ _ **\$2112**

P Top worksurface (RH), 42" radius end, back panel and metal pedestal end
36" x 72" x 30"H (190 lbs)

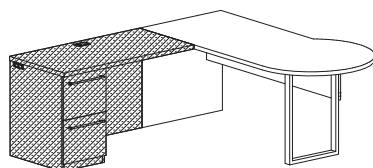

9000WSP6636R_ _ **\$1908**

P Top worksurface (RH), 42" radius end, back panel and metal pedestal end
36" x 66" x 30"H (172 lbs)

9000WSB7230R_ _ **\$1704**

Bullet worksurface (RH), back panel and metal pedestal end
30" x 72" x 30"H (169 lbs)

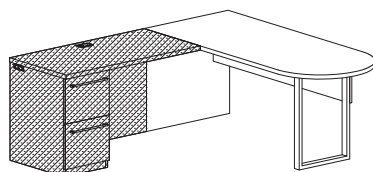

9000WSB6630R_ _ **\$1627**

Bullet worksurface (RH), back panel and metal pedestal end
30" x 66" x 30"H (154 lbs)

CONNECTION SERIES

List Price

Executive Workstations - Executive Returns

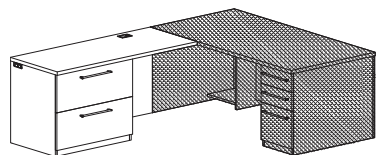

9000ERL2460LF _ _ **\$2061**
 Executive height return (LH), two lateral file drawers (locking),
 wire mgmt grommets in top, back and end, 28"W kneespace
 24" x 60" x 30"H (228 lbs)

9000ERL2060LF _ _ **\$1989**
 Executive height return (LH), two lateral file drawers (locking),
 wire mgmt grommets in top, back and end, 28"W kneespace
 20" x 60" x 30"H (208 lbs)

9000ERL2454LF _ _ **\$2012**
 Executive height return (LH), two lateral file drawers (locking),
 wire mgmt grommets in top, back and end, 22"W kneespace
 24" x 54" x 30"H (215 lbs)

9000ERL2054LF _ _ **\$1941**
 Executive height return (LH), two lateral file drawers (locking),
 wire mgmt grommets in top, back and end, 22"W kneespace
 20" x 54" x 30"H (195 lbs)

9000ERL2454 _ _ **\$1745**
 Executive height return (LH), file/file pedestal (locking),
 wire mgmt grommets in top, back and end, 38"W kneespace
 24" x 54" x 30"H (140 lbs)

9000ERL2054 _ _ **\$1673**
 Executive height return (LH), file/file pedestal (locking),
 wire mgmt grommets in top, back and end, 38"W kneespace
 20" x 54" x 30"H (140 lbs)

9000ERL2448 _ _ **\$1673**
 Executive height return (LH), file/file pedestal (locking),
 wire mgmt grommets in top, back and end, 32"W kneespace
 24" x 48" x 30"H (140 lbs)

9000ERL2048 _ _ **\$1602**
 Executive height return (LH), file/file pedestal (locking),
 wire mgmt grommets in top, back and end, 32"W kneespace
 20" x 48" x 30"H (140 lbs)

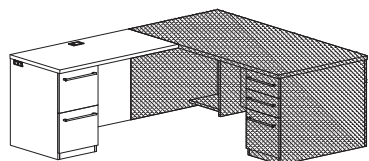

9000ERL2442 _ _ **\$1624**
 Executive height return (LH), file/file pedestal (locking),
 wire mgmt grommets in top, back and end, 26"W kneespace
 24" x 42" x 30"H (140 lbs)

9000ERL2042 _ _ **\$1553**
 Executive height return (LH), file/file pedestal (locking),
 wire mgmt grommets in top, back and end, 26"W kneespace
 20" x 42" x 30"H (140 lbs)

9000ERL2436 _ _ **\$1530**
 Executive height return (LH), file/file pedestal (locking),
 wire mgmt grommets in top, back and end, 20"W kneespace
 24" x 36" x 30"H (140 lbs)

9000ERL2036 _ _ **\$1459**
 Executive height return (LH), file/file pedestal (locking),
 wire mgmt grommets in top, back and end, 20"W kneespace
 20" x 36" x 30"H (140 lbs)

CONNECTION SERIES

List Price

Executive Workstations - Single Pedestal Desks

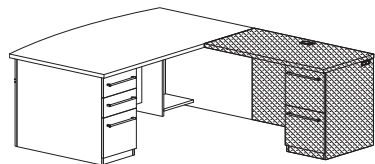

9000KSPL7242_ _ **\$2811**
 Executive single pedestal desk (LH) with arc conference top, box/box/file pedestal (locking),
 10" center overhang, stepped modesty panel
 42" x 72" x 30"H (335 lbs)

9000KSPL7236_ _ **\$2647**
 Executive single pedestal desk (LH) with arc conference top, box/box/file pedestal (locking),
 10" center overhang, stepped modesty panel
 36" x 72" x 30"H (305 lbs)

9000SPL7236_ _ **\$2505**
 Executive single pedestal desk (LH), box/box/file pedestal (locking),
 6" center overhang, stepped modesty panel
 36" x 72" x 30"H (330 lbs)

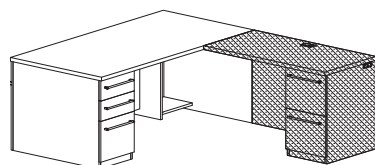

9000SPL7230_ _ **\$2367**
 Executive single pedestal desk (LH), box/box/file pedestal (locking),
 6" center overhang, stepped modesty panel
 30" x 72" x 30"H (300 lbs)

9000SPL6636_ _ **\$2467**
 Executive single pedestal desk (LH), box/box/file pedestal (locking),
 6" center overhang, stepped modesty panel
 36" x 66" x 30"H (290 lbs)

9000SPL6630_ _ **\$2341**
 Executive single pedestal desk (LH), box/box/file pedestal (locking),
 6" center overhang, stepped modesty panel
 30" x 66" x 30"H (275 lbs)

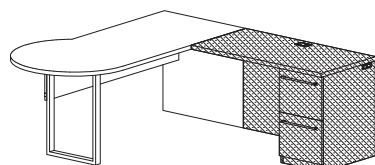

9000WSP7236L_ _ **\$2112**
 P Top worksurface (LH), 42" radius end, back panel and metal pedestal end
 36" x 72" x 30"H (190 lbs)

9000WSP6636L_ _ **\$1908**
 P Top worksurface (LH), 42" radius end, back panel and metal pedestal end
 36" x 66" x 30"H (172 lbs)

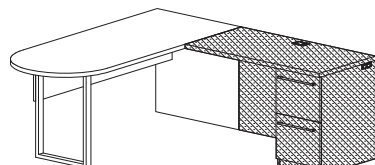

9000WSB7230L_ _ **\$1704**
 Bullet worksurface (LH), back panel and metal pedestal end
 30" x 72" x 30"H (169 lbs)

9000WSB6630L_ _ **\$1627**
 Bullet worksurface (LH), back panel and metal pedestal end
 30" x 66" x 30"H (154 lbs)

CONNECTION SERIES

List Price

Executive Workstations - Executive Returns

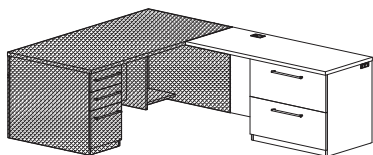

9000ERR2460LF_ _ **\$2061**
 Executive height return (RH), two lateral file drawers (locking),
 wire mgmt grommets in top, back and end, 28"W kneespace
 24" x 60" x 30"H (228 lbs)

9000ERR2060LF_ _ **\$1989**
 Executive height return (RH), two lateral file drawers (locking),
 wire mgmt grommets in top, back and end, 28"W kneespace
 20" x 60" x 30"H (208 lbs)

9000ERR2454LF_ _ **\$2012**
 Executive height return (RH), two lateral file drawers (locking),
 wire mgmt grommets in top, back and end, 22"W kneespace
 24" x 54" x 30"H (215 lbs)

9000ERR2054LF_ _ **\$1941**
 Executive height return (RH), two lateral file drawers (locking),
 wire mgmt grommets in top, back and end, 22"W kneespace
 20" x 54" x 30"H (195 lbs)

9000ERR2454_ _ **\$1745**
 Executive height return (RH), file/file pedestal (locking),
 wire mgmt grommets in top, back and end, 38"W kneespace
 24" x 54" x 30"H (140 lbs)

9000ERR2054_ _ **\$1673**
 Executive height return (RH), file/file pedestal (locking),
 wire mgmt grommets in top, back and end, 38"W kneespace
 20" x 54" x 30"H (140 lbs)

9000ERR2448_ _ **\$1673**
 Executive height return (RH), file/file pedestal (locking),
 wire mgmt grommets in top, back and end, 32"W kneespace
 24" x 48" x 30"H (140 lbs)

9000ERR2048_ _ **\$1602**
 Executive height return (RH), file/file pedestal (locking),
 wire mgmt grommets in top, back and end, 32"W kneespace
 20" x 48" x 30"H (140 lbs)

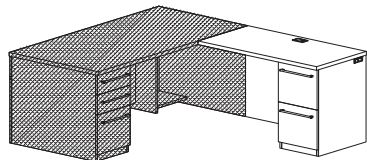

9000ERR2442_ _ **\$1624**
 Executive height return (RH), file/file pedestal (locking),
 wire mgmt grommets in top, back and end, 26"W kneespace
 24" x 42" x 30"H (140 lbs)

9000ERR2042_ _ **\$1553**
 Executive height return (RH), file/file pedestal (locking),
 wire mgmt grommets in top, back and end, 26"W kneespace
 20" x 42" x 30"H (140 lbs)

9000ERR2436_ _ **\$1530**
 Executive height return (RH), file/file pedestal (locking),
 wire mgmt grommets in top, back and end, 20"W kneespace
 24" x 36" x 30"H (140 lbs)

9000ERR2036_ _ **\$1459**
 Executive height return (RH), file/file pedestal (locking),
 wire mgmt grommets in top, back and end, 20"W kneespace
 20" x 36" x 30"H (140 lbs)

CONNECTION SERIES

List Price

Computer Desk U Workstations - Single Pedestal Desks

9000ECWSR7242-24_ _ **\$2780**
 Executive single pedestal computer desk (RH), box/box/file pedestal (locking), 42" corner unit, wire mgmt grommet in wing end, stepped modesty panel, for 24" return
 30"- 42" x 72" x 30"H (325 lbs)

9000ECWSR7242-20_ _ **\$2780**
 Executive single pedestal computer desk (RH), box/box/file pedestal (locking), 42" corner unit, wire mgmt grommet in wing end, stepped modesty panel, for 20" deep return
 30"- 42" x 72" x 30"H (325 lbs)

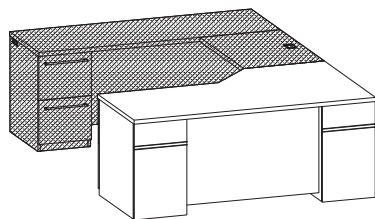

9000ECWSR7236-24_ _ **\$2658**
 Executive single pedestal computer desk (RH), box/box/file pedestal (locking), 36" corner unit, wire mgmt grommet in wing end, stepped modesty panel, for 24" deep return
 30"- 42" x 72" x 30"H (325 lbs)

9000ECWSR7236-20_ _ **\$2658**
 Executive single pedestal computer desk (RH), box/box/file pedestal (locking), 36" corner unit, wire mgmt grommet in wing end, stepped modesty panel, for 20" deep return
 24"- 36" x 72" x 30"H (325 lbs)

9000ECWSR6636-24_ _ **\$2515**
 Executive single pedestal computer desk (RH), box/box/file pedestal (locking), 36" corner unit, wire mgmt grommet in wing end, stepped modesty panel, for 24" deep return
 24"- 36" x 66" x 30"H (325 lbs)

9000ECWSR6636-20_ _ **\$2515**
 Executive single pedestal computer desk (RH), box/box/file pedestal (locking), 36" corner unit, wire mgmt grommet in wing end, stepped modesty panel, for 20" deep return
 24"- 36" x 66" x 30"H (325 lbs)

9000ECWPR7242-24_ _ **\$2316**
 Freestanding P-Top computer desk (RH), 36" diameter end, with metal pedestal end, 42" corner unit, one wire mgmt grommet in wing end, for 24" deep return
 30"-42" x 72" x 30"H (195 lbs)

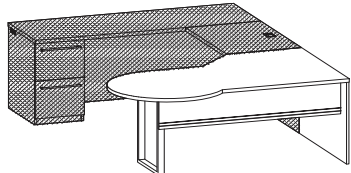

9000ECWPR7242-20_ _ **\$2316**
 Freestanding P-Top computer desk (RH), 36" diameter end, with metal pedestal end, 42" corner unit, one wire mgmt grommet in wing end, for 20" deep return
 30"-42" x 72" x 30"H (195 lbs)

9000ECWBR7242-24_ _ **\$1908**
 Freestanding bullet top computer desk (RH), 30" diameter end, with metal pedestal end, 42" corner unit, one wire mgmt grommet in wing end, for 24" deep return
 30"-42" x 72" x 30"H (195 lbs)

9000ECWBR7242-20_ _ **\$1908**
 Freestanding bullet top computer desk (RH), 30" diameter end, with metal pedestal end, 42" corner unit, one wire mgmt grommet in wing end, for 20" deep return
 30"-42" x 72" x 30"H (195 lbs)

9000ECWBR7236-24_ _ **\$1759**
 Freestanding bullet top computer desk (RH), 30" diameter end, with metal pedestal end, 36" corner unit, one wire mgmt grommet in wing end, for 24" deep return
 24"-36" x 72" x 30"H (195 lbs)

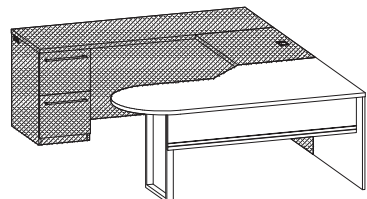

9000ECWBR7236-20_ _ **\$1759**
 Freestanding bullet top computer desk (RH), 30" diameter end, with metal pedestal end, 36" corner unit, one wire mgmt grommet in wing end, for 20" deep return
 24"-36" x 72" x 30"H (195 lbs)

9000ECWBR6636-24_ _ **\$1647**
 Freestanding bullet top computer desk (RH), 30" diameter end, with metal pedestal end, 36" corner unit, one wire mgmt grommet in wing end, for 24" deep return
 24"-36" x 66" x 30"H (195 lbs)

9000ECWBR6636-20_ _ **\$1647**
 Freestanding bullet top computer desk (RH), 30" diameter end, with metal pedestal end, 36" corner unit, one wire mgmt grommet in wing end, for 20" deep return
 24"-36" x 66" x 30"H (195 lbs)

CONNECTION SERIES

List Price

Computer Desk U Workstations - Connecting Bridges

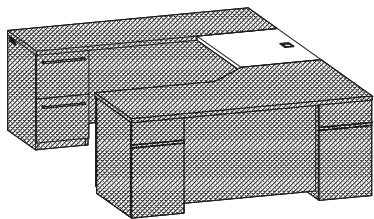

| | |
|--|--------------|
| 9000WS2442_ Executive height bridge, computer grommet in top and back 24" x 48" x 30"H (73 lbs) | \$536 |
| 9000WS2442TO_ Top only bridge | \$292 |
| 9000WS2042_ Executive height bridge, computer grommet in top and bac 24" x 42" x 30"H (64 lbs) | \$510 |
| 9000WS2042TO_ Top only bridge | \$277 |
| 9000WS2436_ Executive height bridge, computer grommet in top and back 24" x 36" x 30"H (63 lbs) | \$522 |
| 9000WS2436TO_ Top only bridge | \$274 |
| 9000WS2036_ Executive height bridge, computer grommet in top and back 24" x 36" x 30"H (55 lbs) | \$496 |
| 9000WS2036TO_ Top only bridge | \$248 |

Computer Desk U Workstations - Single Pedestal Credenzas

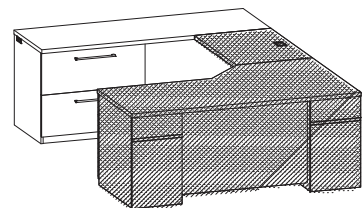

| | |
|--|---------------|
| 9000DCSPL7224LF_ Single pedestal credenza (LH), two lateral file drawers (locking), legal or letter filing, wire mgmt grommets in ends and back, 39"W kneespace 24" x 72" x 30"H (230 lbs) | \$2208 |
| 9000DCSPL7220LF_ Single pedestal credenza (LH), two lateral file drawers (locking), legal or letter filing, wire mgmt grommets in ends and back, 39"W kneespace 20" x 72" x 30"H (201 lbs) | \$2106 |
| 9000DCSPL6624LF_ Single pedestal credenza (LH), two lateral file drawers (locking), legal or letter filing, wire mgmt grommets in ends and back, 33"W kneespace 24" x 66" x 30"H (215 lbs) | \$2154 |
| 9000DCSPL6620LF_ Single pedestal credenza (LH), two lateral file drawers (locking), legal or letter filing, wire mgmt grommets in ends and back, 33"W kneespace 20" x 66" x 30"H (188 lbs) | \$2051 |

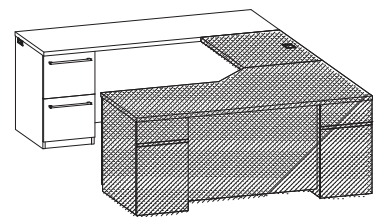

| | |
|--|---------------|
| 9000DCSPL7224_ Single pedestal credenza (LH), file/file pedestal (locking), wire mgmt grommets in ends and back, 55"W kneespace 24" x 72" x 30"H (220 lbs) | \$1955 |
| 9000DCSPL7220_ Single pedestal credenza (LH), file/file pedestal (locking), wire mgmt grommets in ends and back, 55"W kneespace 20" x 72" x 30"H (193 lbs) | \$1853 |
| 9000DCSPL6624_ Single pedestal credenza (LH), file/file pedestal (locking), wire mgmt grommets in ends and back, 49"W kneespace 24" x 66" x 30"H (200 lbs) | \$1901 |
| 9000DCSPL6620_ Single pedestal credenza (LH), file/file pedestal (locking), wire mgmt grommets in ends and back, 49"W kneespace 20" x 66" x 30"H (176 lbs) | \$1799 |

CONNECTION SERIES

List Price

Computer Desk U Workstations - Single Pedestal Desks

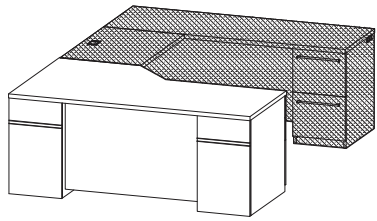
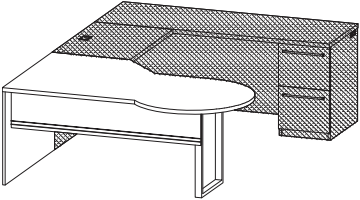
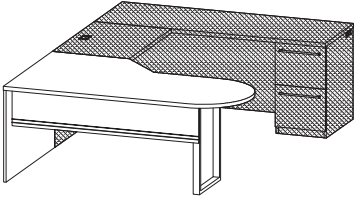
| | | | |
|--|--|--|---------------|
|  | 9000ECWSL7242-24_ _ | Executive single pedestal computer desk (LH), box/box/file pedestal (locking), 42" corner unit, wire mgmt grommet in wing end, stepped modesty panel, for 24" return 30"- 42" x 72" x 30"H (325 lbs) | \$2780 |
| | 9000ECWSL7242-20_ _ | Executive single pedestal computer desk (LH), box/box/file pedestal (locking), 42" corner unit, wire mgmt grommet in wing end, stepped modesty panel, for 20" deep return 30"- 42" x 72" x 30"H (325 lbs) | \$2780 |
| | 9000ECWSL7236-24_ _ | Executive single pedestal computer desk (LH), box/box/file pedestal (locking), 36" corner unit, wire mgmt grommet in wing end, stepped modesty panel, for 24" deep return 30"- 42" x 72" x 30"H (325 lbs) | \$2658 |
| | 9000ECWSL7236-20_ _ | Executive single pedestal computer desk (LH), box/box/file pedestal (locking), 36" corner unit, wire mgmt grommet in wing end, stepped modesty panel, for 20" deep return 24"- 36" x 72" x 30"H (325 lbs) | \$2658 |
| | 9000ECWSL6636-24_ _ | Executive single pedestal computer desk (LH), box/box/file pedestal (locking), 36" corner unit, wire mgmt grommet in wing end, stepped modesty panel, for 24" deep return 24"- 36" x 66" x 30"H (325 lbs) | \$2515 |
|  | 9000ECWPL7242-24_ _ | Freestanding P-Top computer desk (LH), 36" diameter end, with metal pedestal end, 42" corner unit, one wire mgmt grommet in wing end, for 24" deep return 30"-42" x 72" x 30"H (195 lbs) | \$2316 |
| | 9000ECWPL7242-20_ _ | Freestanding P-Top computer desk (LH), 36" diameter end, with metal pedestal end, 42" corner unit, one wire mgmt grommet in wing end, for 20" deep return 30"-42" x 72" x 30"H (195 lbs) | \$2316 |
|  | 9000ECWBL7242-24_ _ | Freestanding bullet top computer desk (LH), 30" diameter end, with metal pedestal end, 42" corner unit, one wire mgmt grommet in wing end, for 24" deep return 30"-42" x 72" x 30"H (195 lbs) | \$1908 |
| | 9000ECWBL7242-20_ _ | Freestanding bullet top computer desk (LH), 30" diameter end, with metal pedestal end, 42" corner unit, one wire mgmt grommet in wing end, for 20" deep return 30"-42" x 72" x 30"H (195 lbs) | \$1908 |
| | 9000ECWBL7236-24_ _ | Freestanding bullet top computer desk (LH), 30" diameter end, with metal pedestal end, 36" corner unit, one wire mgmt grommet in wing end, for 24" deep return 24"-36" x 72" x 30"H (195 lbs) | \$1759 |
| | 9000ECWBL7236-20_ _ | Freestanding bullet top computer desk (LH), 30" diameter end, with metal pedestal end, 36" corner unit, one wire mgmt grommet in wing end, for 20" deep return 24"-36" x 72" x 30"H (195 lbs) | \$1759 |
| | 9000ECWBL6636-24_ _ | Freestanding bullet top computer desk (LH), 30" diameter end, with metal pedestal end, 36" corner unit, one wire mgmt grommet in wing end, for 24" deep return 24"-36" x 66" x 30"H (195 lbs) | \$1647 |
| 9000ECWBL6636-20_ _ | Freestanding bullet top computer desk (LH), 30" diameter end, with metal pedestal end, 36" corner unit, one wire mgmt grommet in wing end, for 20" deep return 24"-36" x 66" x 30"H (195 lbs) | \$1647 | |

CONNECTION SERIES

List Price

Computer Desk U Workstations - Connecting Bridges

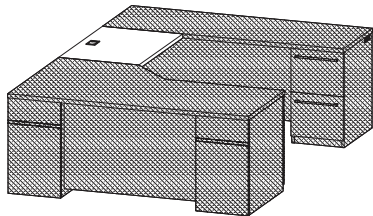

| | |
|--|--------------|
| 9000WS2442_ Executive height bridge, computer grommet in top and back 24" x 48" x 30"H (73 lbs) | \$536 |
| 9000WS2442TO_ Top only bridge | \$292 |
| 9000WS2042_ Executive height bridge, computer grommet in top and back 24" x 42" x 30"H (64 lbs) | \$510 |
| 9000WS2042TO_ Top only bridge | \$277 |
| 9000WS2436_ Executive height bridge, computer grommet in top and back 24" x 36" x 30"H (63 lbs) | \$522 |
| 9000WS2436TO_ Top only bridge | \$274 |
| 9000WS2036_ Executive height bridge, computer grommet in top and back 24" x 36" x 30"H (55 lbs) | \$496 |
| 9000WS2036TO_ Top only bridge | \$248 |

Computer Desk U Workstations - Single Pedestal Credenzas

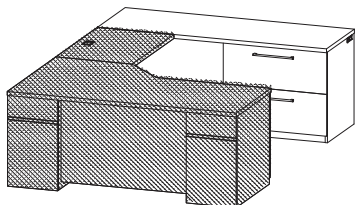

| | |
|--|---------------|
| 9000DCSPR7224LF_ Single pedestal credenza (RH), two lateral file drawers (locking), legal or letter filing, wire mgmt grommets in ends and back, 39"W kneespace 24" x 72" x 30"H (230 lbs) | \$2208 |
| 9000DCSPR7220LF_ Single pedestal credenza (RH), two lateral file drawers (locking), legal or letter filing, wire mgmt grommets in ends and back, 39"W kneespace 20" x 72" x 30"H (201 lbs) | \$2106 |
| 9000DCSPR6624LF_ Single pedestal credenza (RH), two lateral file drawers (locking), legal or letter filing, wire mgmt grommets in ends and back, 33"W kneespace 24" x 66" x 30"H (215 lbs) | \$2154 |
| 9000DCSPR6620LF_ Single pedestal credenza (RH), two lateral file drawers (locking), legal or letter filing, wire mgmt grommets in ends and back, 33"W kneespace 20" x 66" x 30"H (188 lbs) | \$2052 |

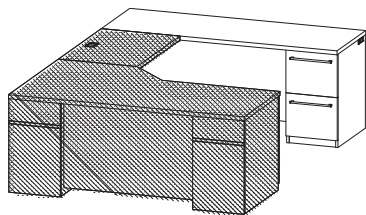

| | |
|--|---------------|
| 9000DCSPR7224_ Single pedestal credenza (RH), file/file pedestal (locking), wire mgmt grommets in ends and back, 55"W kneespace 24" x 72" x 30"H (220 lbs) | \$1955 |
| 9000DCSPR7220_ Single pedestal credenza (RH), file/file pedestal (locking), wire mgmt grommets in ends and back, 55"W kneespace 20" x 72" x 30"H (193 lbs) | \$1853 |
| 9000DCSPR6624_ Single pedestal credenza (RH), file/file pedestal (locking), wire mgmt grommets in ends and back, 49"W kneespace 24" x 66" x 30"H (200 lbs) | \$1901 |
| 9000DCSPR6620_ Single pedestal credenza (RH), file/file pedestal (locking), wire mgmt grommets in ends and back, 49"W kneespace 20" x 66" x 30"H (176 lbs) | \$1799 |

CONNECTION SERIES

List Price

Executive Desk U Workstations - Single Pedestal Desks - Stepped Modesty Panel

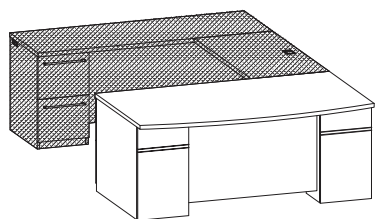

9000KSPR7242_ _ **\$2811**
 Executive single pedestal desk (RH) with arc conference top, box/box/file pedestal (locking),
 10" center overhang, stepped modesty panel
 42" x 72" x 30"H (335 lbs)

9000KSPR7236_ _ **\$2647**
 Executive single pedestal desk (RH) with arc conference top, box/box/file pedestal (locking),
 10" center overhang, stepped modesty panel
 36" x 72" x 30"H (305 lbs)

9000SPR7236_ _ **\$2505**
 Executive single pedestal desk (RH), box/box/file pedestal (locking),
 6" center overhang, stepped modesty panel
 36" x 72" x 30"H (330 lbs)

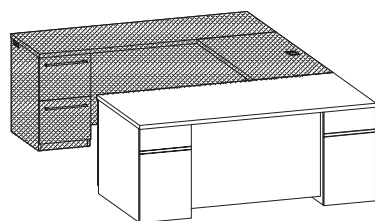

9000SPR7230_ _ **\$2367**
 Executive single pedestal desk (RH), box/box/file pedestal (locking),
 6" center overhang, stepped modesty panel
 30" x 72" x 30"H (300 lbs)

9000SPR6636_ _ **\$2467**
 Executive single pedestal desk (RH), box/box/file pedestal (locking),
 6" center overhang, stepped modesty panel
 36" x 66" x 30"H (290 lbs)

9000SPR6630_ _ **\$2341**
 Executive single pedestal desk (RH), box/box/file pedestal (locking),
 6" center overhang, stepped modesty panel
 30" x 66" x 30"H (275 lbs)

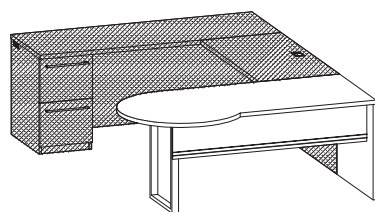

9000WSP7236R_ _ **\$2112**
 P Top worksurface (RH), 42" radius end, back panel and metal pedestal end
 36" x 72" x 30"H (190 lbs)

9000WSP6636R_ _ **\$1908**
 P Top worksurface (RH), 42" radius end, back panel and metal pedestal end
 36" x 66" x 30"H (172 lbs)

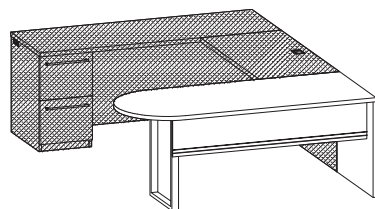

9000WSB7230R_ _ **\$1704**
 Bullet worksurface (RH), back panel and metal pedestal end
 30" x 72" x 30"H (169 lbs)

9000WSB6630R_ _ **\$1627**
 Bullet worksurface (RH), back panel and metal pedestal end
 30" x 66" x 30"H (154 lbs)

CONNECTION SERIES

List Price

Executive Desk U Workstations - Connecting Bridges

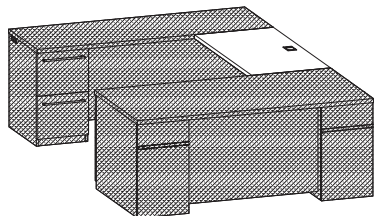

| | |
|--|--------------|
| 9000WS2448_ Executive height bridge, computer grommet in top and back 24" x 48" x 30"H (73 lbs) | \$560 |
| 9000WS2448TO_ Top only bridge | \$312 |
| 9000WS2048_ Executive height bridge, computer grommet in top and back 24" x 48" x 30"H (64 lbs) | \$531 |
| 9000WS2048TO_ Top only bridge | \$286 |
| 9000WS2442_ Executive height bridge, computer grommet in top and back 24" x 42" x 30"H (73 lbs) | \$536 |
| 9000WS2442TO_ Top only bridge | \$292 |
| 9000WS2042_ Executive height bridge, computer grommet in top and back 24" x 42" x 30"H (64 lbs) | \$510 |
| 9000WS2042TO_ Top only bridge | \$267 |

Computer Desk U Workstations - Single Pedestal Credenzas

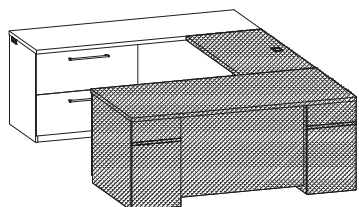

| | |
|--|---------------|
| 9000DCSPL7224LF_ Single pedestal credenza (LH), two lateral file drawers (locking), legal or letter filing, wire mgmt grommets in ends and back, 39"W kneespace 24" x 72" x 30"H (230 lbs) | \$2208 |
| 9000DCSPL7220LF_ Single pedestal credenza (LH), two lateral file drawers (locking), legal or letter filing, wire mgmt grommets in ends and back, 39"W kneespace 20" x 72" x 30"H (201 lbs) | \$2106 |
| 9000DCSPL6624LF_ Single pedestal credenza (LH), two lateral file drawers (locking), legal or letter filing, wire mgmt grommets in ends and back, 33"W kneespace 24" x 66" x 30"H (215 lbs) | \$2154 |
| 9000DCSPL6620LF_ Single pedestal credenza (LH), two lateral file drawers (locking), legal or letter filing, wire mgmt grommets in ends and back, 33"W kneespace 20" x 66" x 30"H (188 lbs) | \$2052 |

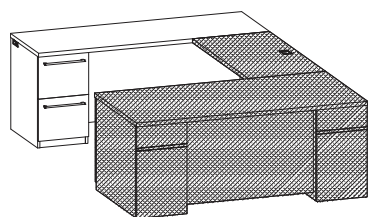

| | |
|--|---------------|
| 9000DCSPL7224_ Single pedestal credenza (LH), file/file pedestal (locking), wire mgmt grommets in ends and back, 55"W kneespace 24" x 72" x 30"H (220 lbs) | \$1955 |
| 9000DCSPL7220_ Single pedestal credenza (LH), file/file pedestal (locking), wire mgmt grommets in ends and back, 55"W kneespace 20" x 72" x 30"H (193 lbs) | \$1853 |
| 9000DCSPL6624_ Single pedestal credenza (LH), file/file pedestal (locking), wire mgmt grommets in ends and back, 49"W kneespace 24" x 66" x 30"H (200 lbs) | \$1901 |
| 9000DCSPL6620_ Single pedestal credenza (LH), file/file pedestal (locking), wire mgmt grommets in ends and back, 49"W kneespace 20" x 66" x 30"H (176 lbs) | \$1799 |

CONNECTION SERIES

List Price

Executive Desk U Workstations - Single Pedestal Desks - Stepped Modesty Panel

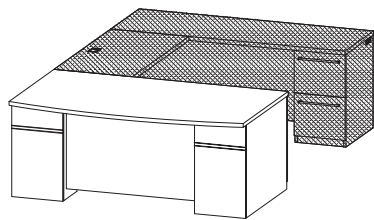

9000KSPL7242_ _ **\$2811**
 Executive single pedestal desk (LH) with arc conference top, box/box/file pedestal (locking),
 10" center overhang, stepped modesty panel
 42" x 72" x 30"H (335 lbs)

9000KSPL7236_ _ **\$2647**
 Executive single pedestal desk (LH) with arc conference top, box/box/file pedestal (locking),
 10" center overhang, stepped modesty panel
 36" x 72" x 30"H (305 lbs)

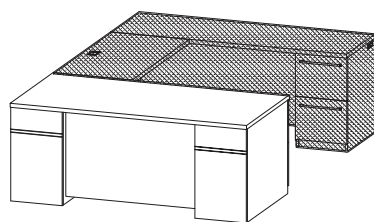

9000SPL7236_ _ **\$2505**
 Executive single pedestal desk (LH), box/box/file pedestal (locking),
 6" center overhang, stepped modesty panel
 36" x 72" x 30"H (330 lbs)

9000SPL7230_ _ **\$2367**
 Executive single pedestal desk (LH), box/box/file pedestal (locking),
 6" center overhang, stepped modesty panel
 30" x 72" x 30"H (300 lbs)

9000SPL6636_ _ **\$2467**
 Executive single pedestal desk (LH), box/box/file pedestal (locking),
 6" center overhang, stepped modesty panel
 36" x 66" x 30"H (290 lbs)

9000SPL6630_ _ **\$2341**
 Executive single pedestal desk (LH), box/box/file pedestal (locking),
 6" center overhang, stepped modesty panel
 30" x 66" x 30"H (275 lbs)

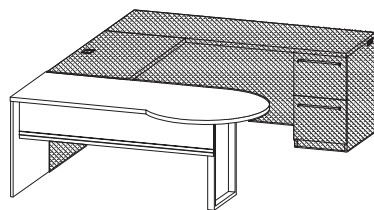

9000WSP7236L_ _ **\$2112**
 P Top worksurface (LH), 42" radius end, back panel and metal pedestal end
 36" x 72" x 30"H (190 lbs)

9000WSP6636L_ _ **\$1908**
 P Top worksurface (LH), 42" radius end, back panel and metal pedestal end
 36" x 66" x 30"H (172 lbs)

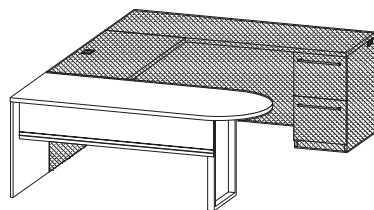

9000WSB7230R_ _ **\$1704**
 Bullet worksurface (RH), back panel and metal pedestal end
 30" x 72" x 30"H (169 lbs)

9000WSB6630R_ _ **\$1627**
 Bullet worksurface (RH), back panel and metal pedestal end
 30" x 66" x 30"H (154 lbs)

CONNECTION SERIES

List Price

Executive Desk U Workstations - Connecting Bridges

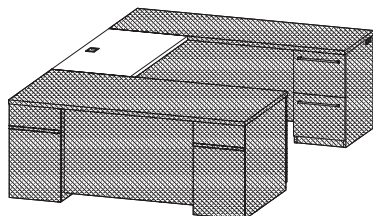

| | |
|--|-------|
| 9000WS2448_ | \$560 |
| Executive height bridge, computer grommet in top and back 24" x 48" x 30"H (73 lbs) | |
| 9000WS2448TO_ Top only bridge | \$312 |
| 9000WS2048_ | \$531 |
| Executive height bridge, computer grommet in top and back 24" x 48" x 30"H (64 lbs) | |
| 9000WS2048TO_ Top only bridge | \$286 |
| 9000WS2442_ | \$536 |
| Executive height bridge, computer grommet in top and back 24" x 42" x 30"H (73 lbs) | |
| 9000WS2442TO_ Top only bridge | \$292 |
| 9000WS2042_ | \$510 |
| Executive height bridge, computer grommet in top and back 24" x 42" x 30"H (64 lbs) | |
| 9000WS2042TO_ Top only bridge | \$267 |

Computer Desk U Workstations - Single Pedestal Credenzas

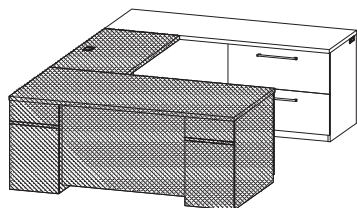

| | |
|---|--------|
| 9000DCSPR7224LF_ _ | \$2208 |
| Single pedestal credenza (RH), two lateral file drawers (locking), legal or letter filing, wire mgmt grommets in ends and back, 39"W kneespace 24" x 72" x 30"H (230 lbs) | |
| 9000DCSPR7220LF_ _ | \$2106 |
| Single pedestal credenza (RH), two lateral file drawers (locking), legal or letter filing, wire mgmt grommets in ends and back, 39"W kneespace 20" x 72" x 30"H (201 lbs) | |
| 9000DCSPR6624LF_ _ | \$2154 |
| Single pedestal credenza (RH), two lateral file drawers (locking), legal or letter filing, wire mgmt grommets in ends and back, 33"W kneespace 24" x 66" x 30"H (215 lbs) | |
| 9000DCSPR6620LF_ _ | \$2052 |
| Single pedestal credenza (RH), two lateral file drawers (locking), legal or letter filing, wire mgmt grommets in ends and back, 33"W kneespace 20" x 66" x 30"H (188 lbs) | |
| 9000DCSPR7224_ _ | \$1955 |
| Single pedestal credenza (RH), file/file pedestal (locking), wire mgmt grommets in ends and back, 55"W kneespace 24" x 72" x 30"H (220 lbs) | |
| 9000DCSPR7220_ _ | \$1853 |
| Single pedestal credenza (RH), file/file pedestal (locking), wire mgmt grommets in ends and back, 55"W kneespace 20" x 72" x 30"H (193 lbs) | |
| 9000DCSPR6624_ _ | \$1901 |
| Single pedestal credenza (RH), file/file pedestal (locking), wire mgmt grommets in ends and back, 49"W kneespace 24" x 66" x 30"H (200 lbs) | |
| 9000DCSPR6620_ _ | \$1799 |
| Single pedestal credenza (RH), file/file pedestal (locking), wire mgmt grommets in ends and back, 49"W kneespace 20" x 66" x 30"H (176 lbs) | |

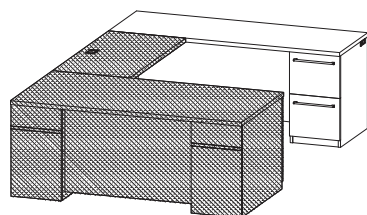

CONNECTION SERIES

List Price

Overhead Storage Units

9000HC84 **\$2408**

Overhead storage unit with hinged wood doors, two storage areas behind four hinged doors (non-locking), two wire mgmt access grommets in bottom of back panel
 25" clearance between apron rail & worksurface
 16" x 84" x 42"H (250 lbs)
 Optional Open Storage - no doors (ND) - no price upcharge
 Optional Frosted Glass doors (FGD) - add \$539 list

9000HC78 **\$2324**

Overhead storage unit with hinged wood doors, two storage areas behind four hinged doors (non-locking), two wire mgmt access grommets in bottom of back panel
 25" clearance between apron rail & worksurface
 16" x 78" x 42"H (230 lbs)
 Optional Open Storage - no doors (ND) - no price upcharge
 Optional Frosted Glass doors (FGD) - add \$539 list

9000HC72 **\$2109**

Overhead storage unit with hinged wood doors, two storage areas behind four hinged doors (non-locking), two wire mgmt access grommets in bottom of back panel
 25" clearance between apron rail & worksurface
 16" x 72" x 42"H (220 lbs)
 Optional Open Storage - no doors (ND) - no price upcharge
 Optional Frosted Glass doors (FGD) - add \$539 list

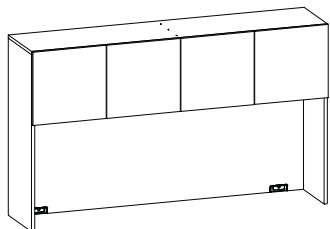

9000HC66 **\$2023**

Overhead storage unit with hinged wood doors, two storage areas behind four hinged doors (non-locking), two wire mgmt access grommets in bottom of back panel
 25" clearance between apron rail & worksurface
 16" x 66" x 42"H (205 lbs)
 Optional Open Storage - no doors (ND) - no price upcharge
 Optional Frosted Glass doors (FGD) - add \$539 list

9000HC60 **\$1988**

Overhead storage unit with hinged wood doors, two storage areas behind four hinged doors (non-locking), two wire mgmt access grommets in bottom of back panel
 25" clearance between apron rail & worksurface
 16" x 60" x 42"H (9000 lbs)
 Optional Open Storage - no doors (ND) - no price upcharge
 Optional Frosted Glass doors (FGD) - add \$539 list

9000HC48 **\$1668**

Overhead storage unit with hinged wood doors, two storage areas behind three hinged doors (non-locking), two wire mgmt access grommets in bottom of back panel
 25" clearance between apron rail & worksurface
 16" x 48" x 42"H (146 lbs)
 Optional Open Storage - no doors (ND) - no price upcharge
 Optional Frosted Glass doors (FGD) - add \$405 list

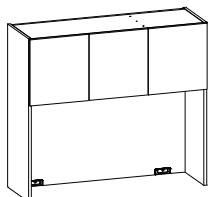

9000HC42 **\$1634**

Overhead storage unit with hinged wood doors, two storage areas behind three hinged doors (non-locking), two wire mgmt access grommets in bottom of back panel
 25" clearance between apron rail & worksurface
 16" x 42" x 42"H (130 lbs)
 Optional Open Storage - no doors (ND) - no price upcharge
 Optional Frosted Glass doors (FGD) - add \$405 list

*for tasklights and tackboards, see page 76

CONNECTION SERIES

List Price

Wall Mounted Overhead Cabinet

9000WM72 **\$1942**
 Wall mounted overhead storage unit with hinged wood doors, two storage areas behind four hinged doors (non-locking), supported by wall cleat, hardware provided by installer
 16" x 72" x 18"H (187 lbs)
 Optional Open Storage - no doors (ND) - no price upcharge
 Optional Frosted Glass doors (FGD) - add \$539 list

9000WM66 **\$1870**
 Wall mounted overhead storage unit with hinged wood doors, two storage areas behind four hinged doors (non-locking), supported by wall cleat, hardware provided by installer
 16" x 66" x 18"H (174 lbs)
 Optional Open Storage - no doors (ND) - no price upcharge
 Optional Frosted Glass doors (FGD) - add \$539 list

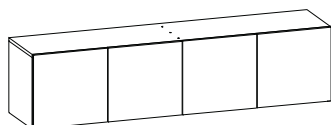

9000WM60 **\$1836**
 Wall mounted overhead storage unit with hinged wood doors, two storage areas behind four hinged doors (non-locking), supported by wall cleat, hardware provided by installer
 16" x 60" x 18"H (163 lbs)
 Optional Open Storage - no doors (ND) - no price upcharge
 Optional Frosted Glass doors (FGD) - add \$539 list

9000WM54 **\$1776**
 Wall mounted overhead storage unit with hinged wood doors, two storage areas behind four hinged doors (non-locking), supported by wall cleat, hardware provided by installer
 16" x 54" x 18"H (160 lbs)
 Optional Open Storage - no doors (ND) - no price upcharge
 Optional Frosted Glass doors (FGD) - add \$539 list

9000WM48 **\$1393**
 Wall mounted overhead storage unit with hinged wood doors, two storage areas behind three hinged doors (non-locking), single door on right side, supported by wall cleat, hardware provided by installer
 16" x 48" x 18"H (154 lbs)
 Optional Open Storage - no doors (ND) - no price upcharge
 Optional Frosted Glass doors (FGD) - add \$405 list

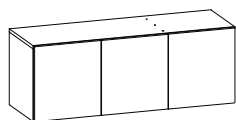

9000WM42 **\$1227**
 Wall mounted overhead storage unit with hinged wood doors, two storage areas behind three hinged doors (non-locking), single door on right side, supported by wall cleat, hardware provided by installer
 16" x 42" x 18"H (142 lbs)
 Optional Open Storage - no doors (ND) - no price upcharge
 Optional Frosted Glass doors (FGD) - add \$405 list

9000WM36 **\$1077**
 Wall mounted overhead storage unit with hinged wood doors, one storage areas behind two hinged doors (non-locking), supported by wall cleat, hardware provided by installer
 16" x 36" x 18"H (133 lbs)
 Optional Open Storage - no doors (ND) - no price upcharge
 Optional Frosted Glass doors (FGD) - add \$270 list

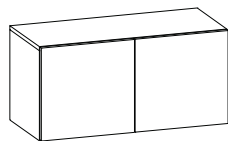

9000WM30 **\$1071**
 Wall mounted overhead storage unit with hinged wood doors, one storage areas behind two hinged doors (non-locking), supported by wall cleat, hardware provided by installer
 16" x 30" x 18"H (128 lbs)
 Optional Open Storage - no doors (ND) - no price upcharge
 Optional Frosted Glass doors (FGD) - add \$270 list

*for tasklights and tackboards, see page 76

CONNECTION SERIES

List Price

Storage Tower

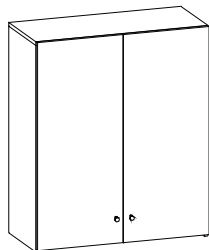

9000HS36 **\$1228**
 Hinged door storage tower with two hinged doors (non-locking), one fixed shelf and one adjustable shelf,
 back panel grommet standard, pull knob
 16" x 36" x 42"H (99 lbs)
 Optional Frosted Glass doors (FGD) - add \$726 list

9000HS30 **\$1178**
 Hinged door storage tower with two hinged doors (non-locking), one fixed shelf and one adjustable shelf,
 back panel grommet standard, pull knob
 16" x 30" x 42"H (88 lbs)
 Optional Frosted Glass doors (FGD) - add \$726 list

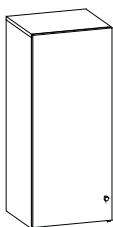

9000HS18L (hinged left) **\$907**
9000HS18R (hinged right) **\$907**
 Hinged door storage tower with one hinged door (non-locking), one fixed shelf and one adjustable shelf,
 back panel grommet standard, pull knob
 16" x 18" x 42"H (45 lbs)
 Optional Frosted Glass doors (FGD) - add \$363 list

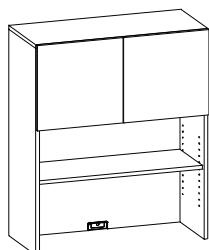

9000HB36 **\$1393**
 Hinged door storage bookcase tower with hinged door compartment (non-locking), one adjustable shelf,
 back panel grommet standard
 16" x 36" x 42"H (99 lbs)
 Optional Frosted Glass doors (FGD) - add \$270 list

9000HB30 **\$1138**
 Hinged door storage bookcase tower with hinged door compartment (non-locking), one adjustable shelf,
 back panel grommet standard
 16" x 30" x 42"H (88 lbs)
 Optional Frosted Glass doors (FGD) - add \$270 list

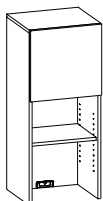

9000HB18L (hinged left) **\$893**
9000HB18R (hinged right) **\$893**
 Hinged door storage bookcase tower with hinged door compartment (non-locking), one adjustable shelf,
 back panel grommet standard
 16" x 18" x 42"H (45 lbs)
 Optional Frosted Glass doors (FGD) - add \$136 list

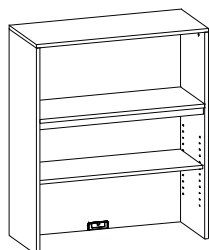

9000BO36 **\$870**
 Bookcase overhead tower with fixed shelf on top and adjustable shelf on bottom,
 back panel grommet standard
 16" x 36" x 42"H (78 lbs)

9000BO30 **\$855**
 Bookcase overhead tower with fixed shelf on top and adjustable shelf on bottom,
 back panel grommet standard
 16" x 30" x 42"H (75 lbs)

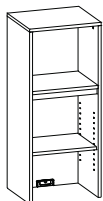

9000BO18 **\$805**
 Bookcase overhead tower with fixed shelf on top and adjustable shelf on bottom,
 back panel grommet standard
 16" x 18" x 42"H (41 lbs)

*for tasklights and tackboards, see page 76

CONNECTION SERIES

List Price

Overhead Bridge Cabinet

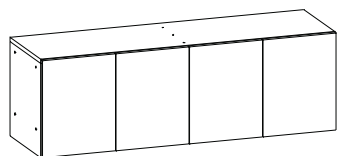
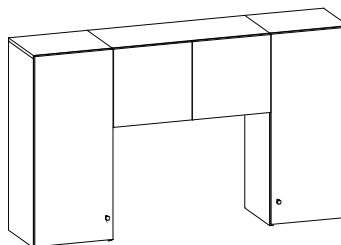

9000OBC54

Overhead bridge cabinet, two storage areas behind 4 hinged doors (non-locking), supported by two storage towers

16" x 54" x 18"H (157 lbs)

Optional Open Storage - no doors (ND) - no price upcharge

Optional Frosted Glass doors (FGD) - add \$539 list

\$1776

9000OBC48

Overhead bridge cabinet, two storage areas behind 3 hinged doors (non-locking), supported by two storage towers, single door on right side

16" x 48" x 18"H (150 lbs)

Optional Open Storage - no doors (ND) - no price upcharge

Optional Frosted Glass doors (FGD) - add \$405 list

\$1393

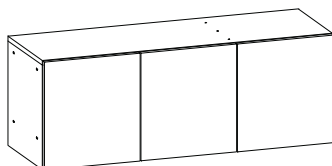

9000OBC42

Overhead bridge cabinet, two storage areas behind 3 hinged doors (non-locking), supported by two storage towers, single door on right side

16" x 42" x 18"H (150 lbs)

Optional Open Storage - no doors (ND) - no price upcharge

Optional Frosted Glass doors (FGD) - add \$405 list

\$1227

9000OBC36

Overhead bridge cabinet, one storage area behind 2 hinged doors (non-locking), supported by two storage towers

16" x 36" x 18"H (130 lbs)

Optional Open Storage - no doors (ND) - no price upcharge

Optional Frosted Glass doors (FGD) - add \$270 list

\$1077

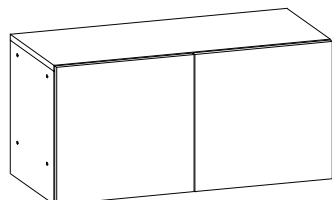

9000OBC30

Overhead bridge cabinet, one storage area behind 2 hinged doors (non-locking), supported by two storage towers

16" x 30" x 18"H (125 lbs)

Optional Open Storage - no doors (ND) - no price upcharge

Optional Frosted Glass doors (FGD) - add \$270 list

\$1071

9000OBS54

Overhead bridge shelf, supported by two storage towers

15 7/16" x 54" x 18"H (62 lbs)

\$598

9000OBS48

Overhead bridge shelf, supported by two storage towers

15 7/16" x 48" x 18"H (55 lbs)

\$523



9000OBS42

Overhead bridge shelf, supported by two storage towers

15 7/16" x 42" x 18"H (48 lbs)

\$475

9000OBS36

Overhead bridge shelf, supported by two storage towers

15 7/16" x 36" x 18"H (41 lbs)

\$407

9000OBS30

Overhead bridge shelf, supported by two storage towers

15 7/16" x 30" x 18"H (39 lbs)

\$404

*for tasklights and tackboards, see page 76

CONNECTION SERIES

List Price

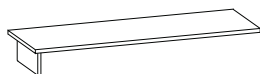
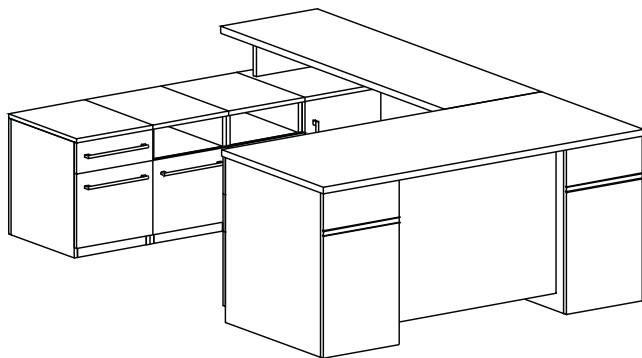

| Return Worksurface Riser | | | |
|---------------------------------|-----------------------|-------|--------|
| 9000WR6024 _ | 60"W x 24"D x 9 1/4"H | 68lbs | \$1071 |
| 9000WR6020 _ | 60"W x 20"D x 9 1/4"H | 60lbs | \$1020 |
| 9000WR6624 _ | 66"W x 24"D x 9 1/4"H | 74lbs | \$1122 |
| 9000WR6620 _ | 66"W x 20"D x 9 1/4"H | 65lbs | \$1071 |
| 9000WR7224 _ | 72"W x 24"D x 9 1/4"H | 78lbs | \$1173 |
| 9000WR7220 _ | 72"W x 20"D x 9 1/4"H | 69lbs | \$1122 |

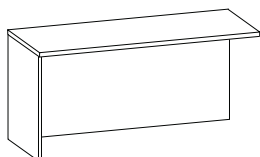

| Return Worksurface Shell - Left | | | |
|--|--------------------|--------|--------|
| 9000SH6024L _ | 60"W x 24"D x 30"H | 120lbs | \$1136 |
| 9000SH6020L _ | 60"W x 20"D x 30"H | 105lbs | \$1034 |
| 9000SH6624L _ | 66"W x 24"D x 30"H | 132lbs | \$1228 |
| 9000SH6620L _ | 66"W x 20"D x 30"H | 116lbs | \$1126 |
| 9000SH7224L _ | 72"W x 24"D x 30"H | 144lbs | \$1319 |
| 9000SH7220L _ | 72"W x 20"D x 30"H | 126lbs | \$1217 |



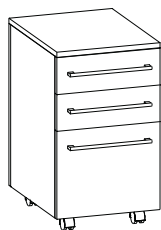

| Return Worksurface Shell - Right | | | |
|---|--------------------|--------|--------|
| 9000SH6024R _ | 60"W x 24"D x 30"H | 120lbs | \$1136 |
| 9000SH6020R _ | 60"W x 20"D x 30"H | 105lbs | \$1034 |
| 9000SH6624R _ | 66"W x 24"D x 30"H | 132lbs | \$1228 |
| 9000SH6620R _ | 66"W x 20"D x 30"H | 116lbs | \$1126 |
| 9000SH7224R _ | 72"W x 24"D x 30"H | 144lbs | \$1319 |
| 9000SH7220R _ | 72"W x 20"D x 30"H | 126lbs | \$1217 |



| | | | |
|---|--|--|---------------|
| 9000MP-BBF | | | \$1581 |
| Mobile pedestal Box-box-file, non-locking | | | |
| 16" x 20 x 28"H (97 lbs) | | | |

CONNECTION SERIES

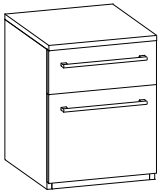
List Price

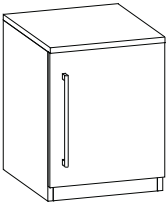
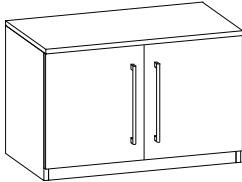
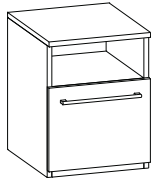
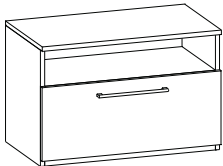
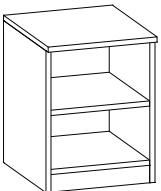
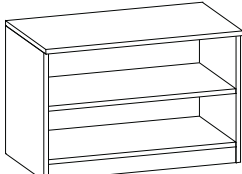
| | | |
|---|---|---------------|
|  | 9000BP-BF1818 Bench Height Unit with Box/File drawer configuration (non-locking) 18" x 18" x 19 1/2"H (79 lbs) | \$928 |
| | 9000BP-BF1824 Bench Height Unit with Box/File drawer configuration (non-locking) 18" x 24" x 19 1/2"H (89 lbs) | \$990 |
|  | 9000BP-BF3618 Bench Height Unit with Box/File drawer configuration (non-locking) 36" x 18" x 19 1/2"H (126 lbs) | \$1214 |
| | 9000BP-BF3624 Bench Height Unit with Box/File drawer configuration (non-locking) 36" x 24" x 19 1/2"H (142 lbs) | \$1312 |
|  | 9000BP-HD1818(L/R) Bench Height Unit with Hinged door configuration (non-locking), specify left or right 18" x 18" x 19 1/2"H (79 lbs) | \$801 |
| | 9000BP-HD1824(L/R) Bench Height Unit with Hinged door configuration (non-locking), specify left or right 18" x 24" x 19 1/2"H (89 lbs) | \$865 |
|  | 9000BP-HD3618 Bench Height Unit with Hinged door configuration (non-locking) 36" x 18" x 19 1/2"H (126 lbs) | \$1025 |
| | 9000BP-HD3624 Bench Height Unit with Hinged door configuration (non-locking) 36" x 24" x 19 1/2"H (142 lbs) | \$1101 |
|  | 9000BP-CF1818 Bench Height Unit with Open shelf/File drawer configuration (non-locking) 18" x 18" x 19 1/2"H (79 lbs) | \$853 |
| | 9000BP-CF1824 Bench Height Unit with Open shelf/File drawer configuration (non-locking) 18" x 24" x 19 1/2"H (89 lbs) | \$915 |
|  | 9000BP-CF3618 Bench Height Unit with Open shelf/File drawer configuration (non-locking) 36" x 18" x 19 1/2"H (79 lbs) | \$1101 |
| | 9000BP-CF3624 Bench Height Unit with Open shelf/File drawer configuration (non-locking) 36" x 24" x 19 1/2"H (89 lbs) | \$1199 |
|  | 9000BP-BC1818 Bench Height Unit with Open shelf configuration, adjustable shelf 18" x 18" x 19 1/2"H (79 lbs) | \$672 |
| | 9000BP-BC1824 Bench Height Unit with Open shelf configuration, adjustable shelf 18" x 24" x 19 1/2"H (89 lbs) | \$731 |
|  | 9000BP-BC3618 Bench Height Unit with Open shelf configuration, adjustable shelf 36" x 18" x 19 1/2"H (79 lbs) | \$832 |
| | 9000BP-BC3624 Bench Height Unit with Open shelf configuration, adjustable shelf 36" x 24" x 19 1/2"H (89 lbs) | \$928 |

CONNECTION SERIES

List Price

Training Tables

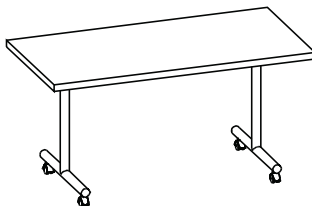
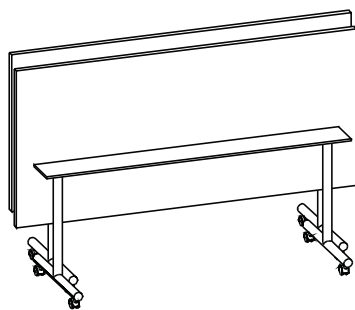

| Training Tables | | | |
|-----------------|--------------------|---------|--------|
| 9000TT2048 _ | 48"W x 20"D x 29"H | 75 lbs | \$1709 |
| 9000TT2054 _ | 54"W x 20"D x 29"H | 81 lbs | \$1750 |
| 9000TT2060 _ | 60"W x 20"D x 29"H | 87 lbs | \$1791 |
| 9000TT2066 _ | 66"W x 20"D x 29"H | 93 lbs | \$1831 |
| 9000TT2072 _ | 72"W x 20"D x 29"H | 98 lbs | \$2035 |
| | | | |
| 9000TT2448 _ | 48"W x 24"D x 29"H | 85 lbs | \$1745 |
| 9000TT2454 _ | 54"W x 24"D x 29"H | 92 lbs | \$1785 |
| 9000TT2460 _ | 60"W x 24"D x 29"H | 98 lbs | \$1826 |
| 9000TT2466 _ | 66"W x 24"D x 29"H | 105 lbs | \$1867 |
| 9000TT2472 _ | 72"W x 24"D x 29"H | 112 lbs | \$2071 |
| | | | |
| 9000TT3048 _ | 48"W x 30"D x 29"H | 98 lbs | \$1826 |
| 9000TT3054 _ | 54"W x 30"D x 29"H | 107 lbs | \$1867 |
| 9000TT3060 _ | 60"W x 30"D x 29"H | 116 lbs | \$1908 |
| 9000TT3066 _ | 66"W x 30"D x 29"H | 124 lbs | \$1949 |
| 9000TT3072 _ | 72"W x 30"D x 29"H | 133 lbs | \$2153 |
| 9000TT3666 _ | 66"W x 36"D x 29"H | 143 lbs | \$2010 |
| 9000TT3672 _ | 72"W x 36"D x 29"H | 153 lbs | \$2214 |

Pneumatic Adjustable Height Tables

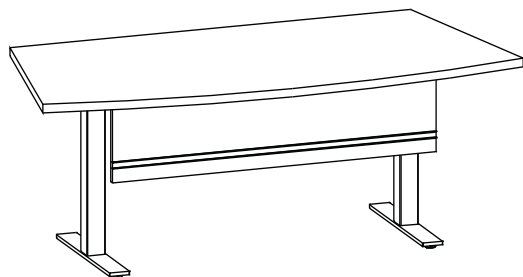

| Adjustable Height Tables - Rectangle | | | |
|--------------------------------------|--------------------|---------|--------|
| 9000AT3060 _ | 60"W x 30"D x 29"H | 160 lbs | \$3409 |
| 9000AT3066 _ | 66"W x 30"D x 29"H | 168 lbs | \$3445 |
| 9000AT3072 _ | 72"W x 30"D x 29"H | 175 lbs | \$3476 |
| 9000AT3666 _ | 66"W x 36"D x 29"H | 185 lbs | \$3511 |
| 9000AT3672 _ | 72"W x 36"D x 29"H | 194 lbs | \$3669 |
| | | | |
| Adjustable Height Tables - Arc Top | | | |
| 9000AK3060 _ | 60"W x 30"D x 29"H | 150 lbs | \$3567 |
| 9000AK3066 _ | 66"W x 30"D x 29"H | 158 lbs | \$3603 |
| 9000AK3666 _ | 66"W x 36"D x 29"H | 170 lbs | \$3634 |
| 9000AK3672 _ | 72"W x 36"D x 29"H | 179 lbs | \$3651 |
| 9000AK4272 _ | 72"W x 42"D x 29"H | 200 lbs | \$3828 |

CONNECTION SERIES

List Price

Conference Table Tops



| | |
|---|--------------|
| 9000MT48DIA_ Round conference table top 48" diameter x 1 3/16"H (62 lbs) | \$641 |
| 9000MT42DIA_ Round conference table top 42" diameter x 1 3/16"H (50 lbs) | \$491 |
| 9000MT36DIA_ Round conference table top 36" diameter x 1 3/16"H (30 lbs) | \$426 |

Conference Table Bases

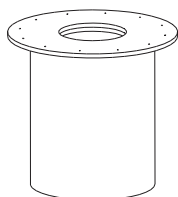

| | |
|---|--------------|
| 9000MCB22 22" diameter drum base (for use with 48" diameter tops) 22" diameter x 27 3/4"H (85 lbs) Not available in Double Cut Veneer | \$887 |
| 9000MCB18 18" diameter drum base (for use with 36"-42" diameter tops) 18" diameter x 27 3/4"H (85 lbs) Not available in Double Cut Veneer | \$683 |

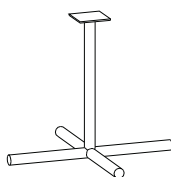

| | |
|--|--------------|
| 12CRFPB32 X-base in chrome (for use with 42" - 48" diameter tops) 32" x 32" x 27 3/4"H (21 lbs) | \$592 |
| 12PWFPB32 X-base in black (for use with 42" - 48" diameter tops) 32" x 32" x 27 3/4"H (21 lbs) | \$511 |
| 12CRFPB26 X-base in chrome (for use with 36" diameter tops) 26" x 26" x 27 3/4"H (16 lbs) | \$458 |
| 12PWFPB26 X-base in black (for use with 36" diameter tops) 26" x 26" x 27 3/4"H (16 lbs) | \$390 |

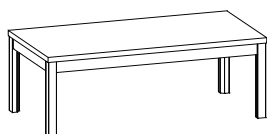

| | |
|---|--------------|
| 9000MT2448_ Magazine table 24" x 48" x 16"H (58 lbs) | \$972 |
|---|--------------|

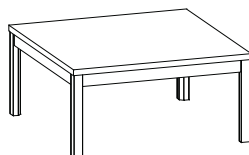

| | |
|---|--------------|
| 9000CT2828_ Corner table 28" x 28" x 21"H (42 lbs) | \$948 |
|---|--------------|

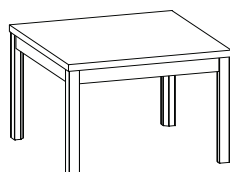

| | |
|--|--------------|
| 9000ET2028_ End table 20" x 28" x 21"H (38 lbs) | \$827 |
|--|--------------|

CONNECTION SERIES

List Price

Accessories

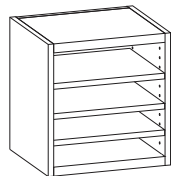

9000PSA
 Portable work organizer, with three paper trays
 16" x 10 3/4" x 24 3/4"H (20 lbs)

\$616

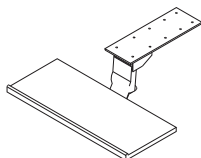

AKPW
 Articulating keyboard - leverless, with non- handed mouse pad, 5" height adjustment,
 25 degree tilt - 360 degree swivel, wooden keyboard tray - specify finish
 11 1/4" x 21 1/2" x 2 3/4"H (25 lbs)

\$472

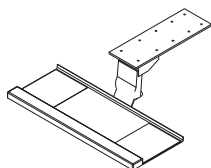

AKP
 Articulating keyboard - leverless, with non- handed mouse pad, 5" height
 adjustment, 25 degree tilt - 360 degree swivel, black molded keyboard tray
 11" x 25" x 2 3/4"H (21 lbs)

\$337

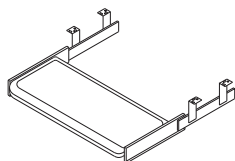

KD
 Pull-out keyboard - leverless, black molded keyboard tray
 10 5/8" x 21 1/2" x 3 5/8"H (15 lbs)

\$153



LH
 Wire mgmt channel, 22" length - set of four, double sided velcro attachment
 4 lbs

\$83

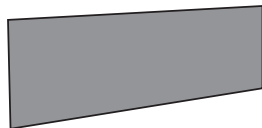

TB77
 Fabric tackboard, (COM, Grade A, Grade B) 3/4" x 77" x 15 1/2"H (20 lbs)

\$474

TB71
 Fabric tackboard, (COM, Grade A, Grade B) 3/4" x 71" x 15 1/2"H (18 lbs)

\$448

TB65
 Fabric tackboard, (COM, Grade A, Grade B) 3/4" x 65" x 15 1/2"H (16 lbs)

\$400

TB59
 Fabric tackboard, (COM, Grade A, Grade B) 3/4" x 59" x 15 1/2"H (14 lbs)

\$386

TB53
 Fabric tackboard, (COM, Grade A, Grade B) 3/4" x 53" x 15 1/2"H (12 lbs)

\$341

TB41
 Fabric tackboard, (COM, Grade A, Grade B) 3/4" x 41" x 15 1/2"H (11 lbs)

\$300

TB35
 Fabric tackboard, (COM, Grade A, Grade B) 3/4" x 35" x 15 1/2"H (10 lbs)

\$233



TL48
 Task light (UL approved), 6" x 48" x 1 1/2"H (15 lbs)

\$215

TL24
 Task light (UL approved), 6" x 24" x 1 1/2"H (10 lbs)

\$185

A LA CARTE SERIES



Contemporary - Transitional modular styling with a choice of 16 finishes, five edge details and five hardware selections in three finishes.

All items are available in a choice of walnut, cherry and mahogany finishes.

A LA CARTE SERIES

Finishes Available

Walnut

Natural Walnut



Richleigh Walnut



Royal Walnut



Empire Walnut



Old World Mahogany



Crescent Cherry on Walnut

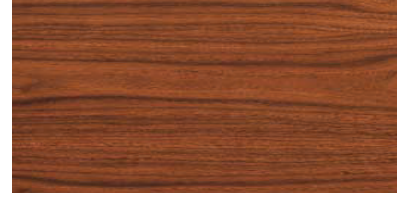

Espresso

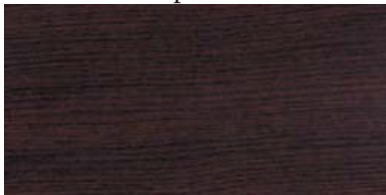

Cherry

Natural Cherry



Amber Cherry



Cinnamon Cherry



Collector's Cherry

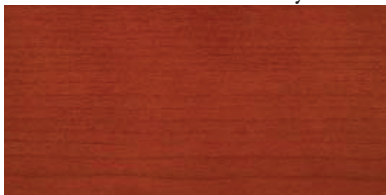

Mocha Cherry



Mahogany on Cherry



Oak

Landmark Oak

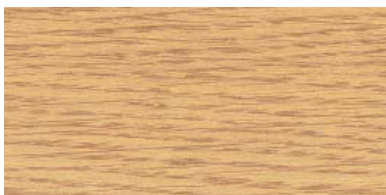

Harbor Oak

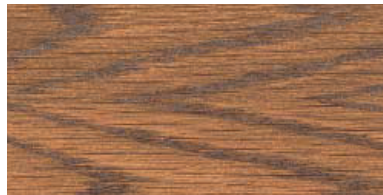

Maple

Sunrise Maple



**The finishes shown on this page have been reproduced as accurately as possible, however, due to the printing process some finishes may vary slightly from the actual finish samples originally photographed. In addition, due to the nature of wood, it is possible that some slight variations in color and grain character may occur naturally (which is the beauty of a natural product). Wood finish chips are available for each of the above finishes if requested (please call customer service).

A LA CARTE SERIES



Options Available

| | | | |
|-----|---|--------------------------------|-----|
| HPL | Matching high pressure laminate substituted for wood top - Call customer service for matching finish selections | \$ | N/C |
| CD | Center Drawer | \$ | 374 |
| FF | Change BBF pedestal to F/F | \$ | N/C |
| BBF | Change F/F to BBF | \$ | 66 |
| CPU | Change BBF or FF pedestal to CPU pedestal - inside dimensions: 14 3/16"Wx17 13/16"Dx22 3/8"H - hinged door (non-locking), two ventilation slots in back panel and inside end panel grommet | \$ | 110 |
| PNT | Change lateral file or file center pedestal to printer pedestal - inside dimensions: 27 1/2"Wx17 13/16"Dx22 3/8"H - slide out printer shelf, wall access cut-out in back modesty and inside end panel grommet | \$ | 110 |
| LK | Locking of individual doors, drawers or pedestals (where not standard) | \$ | 55 |
| GR | Wire mgmt grommet (note location) | \$ | 61 |
| WA | Wall access cut-out (modesty panels on bridges, credenzas, desks and returns) | \$ | N/C |
| HB | Optional half modesty panel on units with backs | \$ | N/C |
| AHM | Electronic height adjustable mechanism added to worksurface, lifting column, control box, control pendant, with memory settings, motor cable, main power cable, anti-collision dongle. Lower metal lifts and anti-tip brackets. Adjusts from 30" - 44"H | Contact Customer Service | |

A LA CARTE SERIES

Warranty and Certification

All products listed are warranted against defects of material and workmanship under normal use and service for a minimum of 10 years from the date of installation (see full warranty information). All products listed are Level 2 BIFMA certified.

Veneer

Veneer on all exposed surfaces is American Black Walnut, Cherry, Oak or Maple. Outside surface veneers are book matched to provide proper grain consistency and uniform grain appearance. Drawer fronts are vertical grain cherry, maple, oak or walnut veneers and matched in selected sets to ensure proper veneer balance and uniform grain appearance.

Wood Veneer Tops

1 3/16" thick tops utilizing 3-ply construction with solid cherry, maple, oak or walnut wood band edging, shaped with five edge details. Both user side and approach side tops are shaped with the selected edge detail on 30", 36" and 42" depth tops. 24" depth tops are shaped on user side only unless otherwise noted. Top cores are high density particle board or fiberboard dependent upon the application. Cherry, maple, oak or walnut veneer tops are standard. High pressure laminate tops are optional, with many standard finishes having matching laminate tops available (call customer service for options).

Modesty Panels and End Panels

End panels are 29/32" thick with a 3-ply construction with a black PVC band along top edge and a solid lumber band on the bottom edge of the panel to prevent tear out. Modesty panels are 3/4" thick, 3-ply construction. All veneers are vertical grain cherry, maple, oak or walnut veneers matched to ensure proper veneer balance, provide proper grain consistency and uniform grain appearance. Full modesty panels are standard for desk, bridge, and kneespace credenzas with optional half modesty options available.

Drawers

Drawer sides and backs are wood, 7/16" thick. Drawer fronts are 3-ply hardwood construction, 3/4" thick with book matched veneers to provide proper grain consistency and uniform grain appearance. All drawers utilize five sided drawer construction. Drawers are assembled with dovetail construction in all four corners. Drawer bottoms are 7/32" 3-ply hardwood dado construction.

Doors

Doors are 3/4" thick 3-ply construction with vertical grain cherry, maple or walnut veneers and matched in selected sets to ensure proper veneer balance and uniform grain appearance. European style hidden hinges are used on all doors. Tempered glass conforming to ASTM C 1048 is used in all glass doors.

Shelves

Shelves are 3-ply construction with a 1/4" cherry, maple, oak or walnut rim on the front edge. All shelves are full depth of the interior compartment unless specified otherwise. Faces are book matched walnut, cherry or oak veneer. Hutch shelves are cherry, maple, oak or walnut faced on both sides. A minimum of one adjustable or fixed shelf is provided with each cabinet storage unit (see individual unit for details). Adjustable shelves are provided with metal adjustable shelf hardware supports.

Bases

Height adjustable leveling glides are mounted in each corner with a threaded metal insert capped with a nylon glide that is height adjustable to approx. 1 1/2" to ensure proper leveling of the unit to varying floor conditions.

Hardware

Drawer Suspensions – File, box, pencil and center drawers utilize steel "A" grade heavy duty metal slides for smooth operation. All pedestal drawers have 100 % full extension slides. All suspension systems feature positive and cushioned in/out stops. All box, center, and tray drawers are removable without tools and the suspensions are designed to prevent accidental removal.

Locks – All desks and credenzas utilize pedestal locking. Lateral files are keyed as standard and feature central locking with anti-tip drawer interlock systems. Individual pieces are shipped random keyed. Units may be keyed alike upon special request. A minimum of fifty key changes (numbers) are available. Core lock changes are available (contact customer service)

Drawer Pulls – Four drawer pull options are available in black or nickel finish and one drawer pull option is available in brass (see attached for details).

Hinges – European style hidden hinges on all hinged doors.

Wire Management – Black wire management grommets are standard on all returns and bridge work surfaces located in back center of the tops. Black wire management access grommets are standard on all credenzas, hutches, overhead storage units and computer tables located in back panel. Optional additional black wire management grommets, wall access cut-outs, wiring harness and wiring channels along with integrated cable management to conceal power and data cords are also available. Optional data ports accessible at work surface height (see accessories).

Chassis Construction

Construction technique is mortise and tenon, groove and tenon, heavily glue blocked with hardwood cleats for maximum strength.

Filing

File drawers use an easily adjustable filing rail system which can be positioned to accommodate front to back or side to side letter or legal filing.

Finish

All exposed surfaces are finished with a UV inhibitor catalyzed varnish finish to ensure maximum durability, chemical resistance, color retention and clarity. All exterior surfaces are finished in the following multi-step sequence: sap stain, NGR stain, wash coat, wash coat sand, filler spray, filler wipe, sealer spray, sealer sand, varnish spray, varnish sand, varnish spray. Moisture content for all wooden parts is between 5 - 9% prior to sealing. Drawer interiors and exteriors are UV prefinished with sealer, sealer sand, and varnished. Custom finish matches are available, contact customer service for request

A LA CARTE SERIES

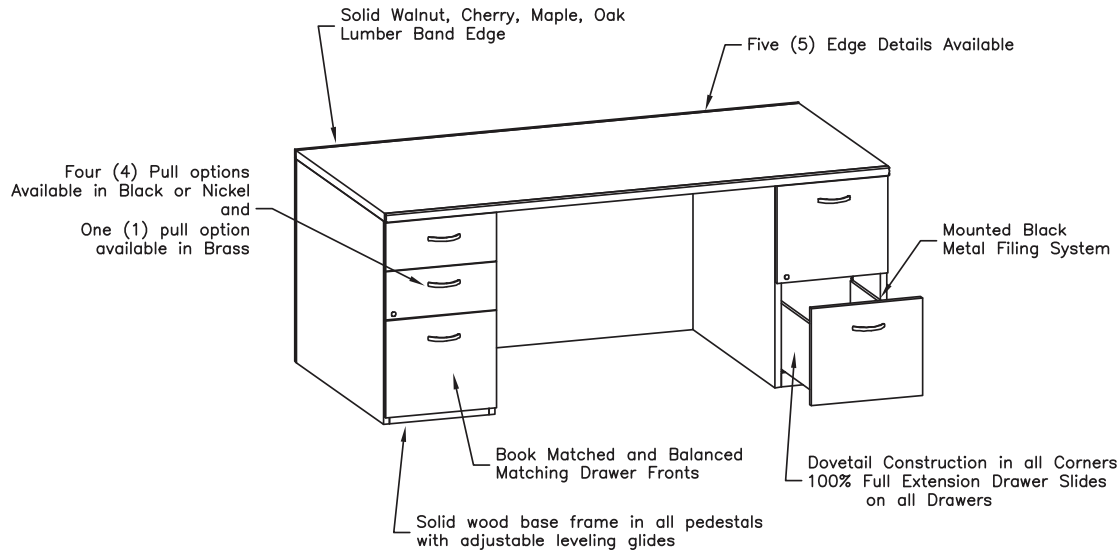

Available in Walnut, Cherry, Maple, and Oak
 Standard Pedestal Locking
 All surfaces are catalyzed varnish finish
 Available in Modular or Set-up Units
 Optional Center Drawer

Ordering Information

Use the following steps to correctly place your order:

- 1) Determine the correct model number for the item you are selecting - example:
200FR7236SB = Double pedestal desk, 36" x 72" x 30"H
- 2) Determine the proper finish selection for the item - example:
200FR7236SB-CC = Double pedestal desk, 36" x 72" x 30"H, in Crescent Cherry
- 3) Determine the edge profile you may wish for the item - example:
200FR7236SB-CC-D = Double pedestal desk, 36" x 72" x 30"H, in Crescent Cherry finish, with Reeded edge detail
- 4) Determine any additional options you may wish for the item - example:
200FR7236SB-CC-D-AN = Double pedestal desk, 36" x 72" x 30"H, in Crescent Cherry, with Reeded edge detail, with Arc Nickel pulls

Standard Profile Options



Square - A

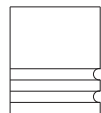

Kerf - B

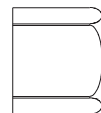

Tri-Oval - C

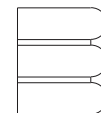

Reeded - D

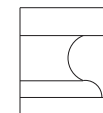

Classic - E

Standard Pull Options



LB - Bar Black



AB - Arc Black



CB - Crescent Black



JB - Wave Black



KB - Classic Brass



LN - Bar Nickel



AN - Arc Nickel



CN - Crescent Nickel



JN - Wave Nickel

A LA CARTE SERIES

List Price

Double Pedestal Desks with Stepped Modesty Panels

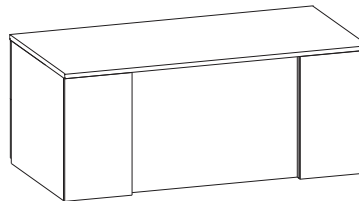

Approach side view

200FK8442SB_ _ \$4545
 Double pedestal desk with arc conference top, box/box/file pedestal (LH), file/file pedestal (RH), pedestal locking, 10" center approach side overhang, stepped modesty panel
 46" W Kneespace
 42" x 84" x 30"H (455 lbs)

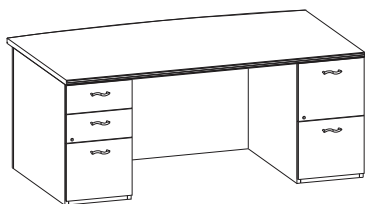

200FK7242SB_ _ \$4254
 Double pedestal desk with arc conference top, box/box/file pedestal (LH), file/file pedestal (RH), pedestal locking, 10" center approach side overhang, stepped modesty panel
 40" W Kneespace
 42" x 72" x 30"H (405 lbs)

200CD36 Optional Center Drawer \$374

200FK7236SB_ _ \$3948
 Double pedestal desk with arc conference top, box/box/file pedestal (LH), file/file pedestal (RH), pedestal locking, 10" approach side overhang, stepped modesty panel
 40" W Kneespace
 36" x 72" x 30"H (340 lbs)

200CD36 Optional Center Drawer \$374

200FR7236SB_ _ \$4034
 Double pedestal desk with fitted top, box/box/file pedestal (LH), file/file pedestal (RH), pedestal locking, 4" center approach side overhang, stepped modesty panel
 40" W Kneespace
 36" x 72" x 30"H (365 lbs)

200CD36 Optional Center Drawer \$374

200FR7230SB_ _ \$3770
 Double pedestal desk with fitted top, box/box/file pedestal (LH), file/file pedestal (RH), pedestal locking, 4" center approach side overhang, stepped modesty panel
 40" W Kneespace
 30" x 72" x 30"H (335 lbs)

200CD36 Optional Center Drawer \$374

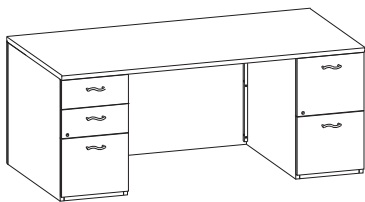

200FR6636SB_ _ \$3944
 Double pedestal desk with fitted top, box/box/file pedestal (LH), file/file pedestal (RH), pedestal locking, 4" center approach side overhang, stepped modesty panel
 34" W Kneespace
 36" x 66" x 30"H (345 lbs)

200CD30 Optional Center Drawer \$374

200FR6630SB_ _ \$3668
 Double pedestal desk with fitted top, box/box/file pedestal (LH), file/file pedestal (RH), pedestal locking, 4" center approach side overhang, stepped modesty panel
 34" W Kneespace
 30" x 66" x 30"H (320 lbs)

200CD30 Optional Center Drawer \$374

200FR6030SB_ _ \$3638
 Double pedestal desk with fitted top, box/box/file pedestal (LH), file/file pedestal (RH), pedestal locking, 4" center approach side overhang, stepped modesty panel
 28" W Kneespace
 30" x 60" x 30"H (305 lbs)

200CD24 Optional Center Drawer \$374

A LA CARTE SERIES

List Price

Double Pedestal Desks with Recessed Modesty Panels

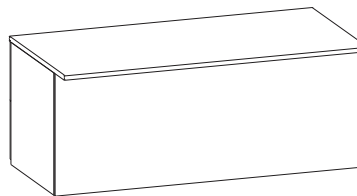

Approach side view

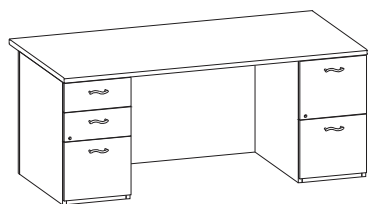
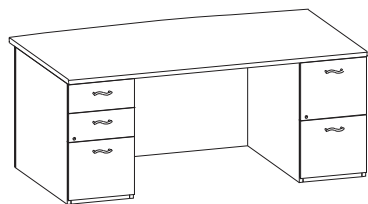

200FK8442FB_ _ **\$4462**
 Double pedestal desk with arc conference top, box/box/file pedestal (LH), file/file pedestal (RH), pedestal locking, 10" center approach side overhang, recessed modesty panel
 46" W Kneespace
 42" x 84" x 30"H (455 lbs)

200FK7242FB_ _ **\$4182**
 Double pedestal desk with arc conference top, box/box/file pedestal (LH), file/file pedestal (RH), pedestal locking, 10" center approach side overhang, recessed modesty panel
 40" W Kneespace
 42" x 72" x 30"H (405 lbs)

200CD36 **\$374**
 Optional Center Drawer

200FK7236FB_ _ **\$3878**
 Double pedestal desk with arc conference top, box/box/file pedestal (LH), file/file pedestal (RH), pedestal locking, 10" approach side overhang, recessed modesty panel
 40" W Kneespace
 36" x 72" x 30"H (340 lbs)

200CD36 **\$374**
 Optional Center Drawer

200FR7236FB_ _ **\$3870**
 Double pedestal desk with conference top, box/box/file pedestal (LH), file/file pedestal (RH), pedestal locking, 6" approach side overhang, recessed modesty panel
 40" W Kneespace
 36" x 72" x 30"H (365 lbs)

200CD36 **\$374**
 Optional Center Drawer



200FR7230FB_ _ **\$3462**
 Double pedestal desk with conference top, box/box/file pedestal (LH), file/file pedestal (RH), pedestal locking, 6" approach side overhang, recessed modesty panel
 40" W Kneespace
 30" x 72" x 30"H (335 lbs)

200CD36 **\$374**
 Optional Center Drawer



200FR6636FB_ _ **\$3777**
 Double pedestal desk with conference top, box/box/file pedestal (LH), file/file pedestal (RH), pedestal locking, 6" approach side overhang, recessed modesty panel
 34" W Kneespace
 36" x 66" x 30"H (345 lbs)

200CD30 **\$374**
 Optional Center Drawer



200FR6630FB_ _ **\$3339**
 Double pedestal desk with conference top, box/box/file pedestal (LH), file/file pedestal (RH), pedestal locking, 6" approach side overhang, recessed modesty panel
 34" W Kneespace
 30" x 66" x 30"H (320 lbs)

200CD30 **\$374**
 Optional Center Drawer



200FR6030FB_ _ **\$3261**
 Double pedestal desk with conference top, box/box/file pedestal (LH), file/file pedestal (RH), pedestal locking, 6" approach side overhang, recessed modesty panel
 28" W Kneespace
 30" x 60" x 30"H (305 lbs)

200CD24 **\$374**
 Optional Center Drawer

A LA CARTE SERIES

List Price

Credenzas

200DC84-4 _ _ **\$4238**
 Credenza with hinged door storage, two file/file pedestals (locking), hinged door storage area (non-locking) with one adjustable shelf
 24" x 84" x 30"H (310 lbs)
 Optional locking doors (LK) - add \$55 list

200DC72-4 _ _ **\$3909**
 Credenza with hinged door storage, two file/file pedestals (locking), hinged door storage area (non-locking) with one adjustable shelf
 24" x 72" x 30"H (285 lbs)
 Optional locking doors (LK) - add \$55 list

200DC66-4 _ _ **\$3753**
 Credenza with hinged door storage, two file/file pedestals (locking), hinged door storage area (non-locking) with one adjustable shelf
 24" x 66" x 30"H (255 lbs)
 Optional locking doors (LK) - add \$55 list

200DC60-4 _ _ **\$3630**
 Credenza with hinged door storage, two file/file pedestals (locking), hinged door storage area (non-locking) with one adjustable shelf
 24" x 60" x 30"H (225 lbs)
 Optional locking doors (LK) - add \$55 list

200DC84-3 _ _ **\$3536**
 Credenza with kneespace, two file/file pedestals (locking), wire mgmt grommet in back
 40" W kneespace
 24" x 84" x 30"H (265 lbs)

200DC72-3 _ _ **\$3207**
 Credenza with kneespace, two file/file pedestals (locking), wire mgmt grommet in back
 40" W kneespace
 24" x 72" x 30"H (255 lbs)

200DC66-3 _ _ **\$3148**
 Credenza with kneespace, two file/file pedestals (locking), wire mgmt grommet in back
 34" W kneespace
 24" x 66" x 30"H (245 lbs)

200DC60-3 _ _ **\$3100**
 Credenza with kneespace, two file/file pedestals (locking), wire mgmt grommet in back
 28" W kneespace
 24" x 60" x 30"H (235 lbs)

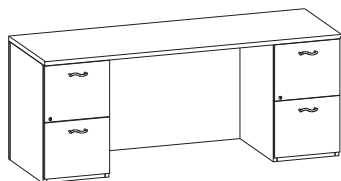
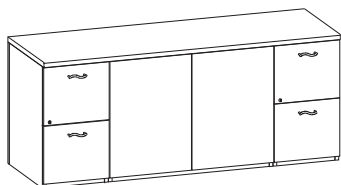

A LA CARTE SERIES

List Price

Storage Units

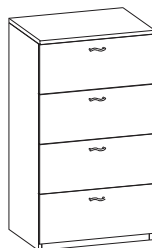

200LF4V_ _
Four drawer lateral file, legal or letter cross filing, central locking
24" x 32" x 56"H (220 lbs)



\$3907

200LF4V-42_ _
24" x 42" x 56"H (260 lbs)

\$3997

200LF4V-36_ _
24" x 36" x 56"H (240 lbs)

\$3931

200LF4V-30_ _
24" x 30" x 56"H (215 lbs)

\$3888

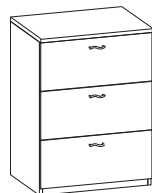

200LF3V_ _
Three drawer lateral file, legal or letter cross filing, central locking
24" x 32" x 42"H (200 lbs)

\$3092

200LF3V-42_ _
24" x 42" x 42"H (220 lbs)

\$3199

200LF3V-36_ _
24" x 36" x 42"H (210 lbs)

\$3119

200LF3V-30_ _
24" x 30" x 42"H (190 lbs)

\$3039

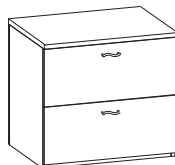

200LF2_ _
Two drawer lateral file, legal or letter cross filing, central locking
24" x 32" x 30"H (140 lbs)



\$2018

200LF2-42_ _
24" x 42" x 30"H (180 lbs)

\$2090

200LF2-36_ _
24" x 36" x 30"H (160 lbs)

\$2048

200LF2-30_ _
24" x 30" x 30"H (135 lbs)

\$2014

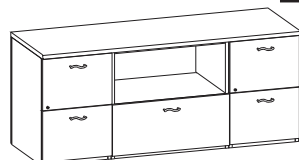

200FC5BC_ _
Open storage/file, left and right file/file pedestal (locking), center - top open storage area, bottom - lateral file (locking), legal or letter filing, wire mgmt grommet in back panel
24" x 72" x 30"H (370 lbs)

\$3775

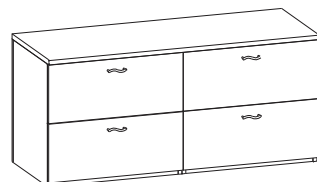

200LF4-72_ _
Double unit lateral file, legal or letter cross filing, central locking
24" x 72" x 30"H (235 lbs)

\$3734

200LF4-66_ _
Double unit lateral file, legal or letter cross filing, central locking
24" x 66" x 30"H (215 lbs)

\$3674

200LF4-60_ _
Double unit lateral file, legal or letter cross filing, central locking
24" x 60" x 30"H (195 lbs)

\$3613

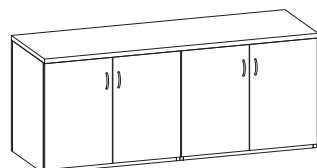

200SC-72_ _
Four door hinged door cabinet (non-locking), one adjustable shelf per section
24" x 72" x 30"H (300 lbs)
Optional locking doors (LK) - add \$110 list

\$3782

200SC-66_ _
Four door hinged door cabinet (non-locking), one adjustable shelf per section
24" x 66" x 30"H (260 lbs)
Optional locking doors (LK) - add \$110 list

\$3722

200SC-60_ _
Four door hinged door cabinet (non-locking), one adjustable shelf per section
24" x 60" x 30"H (200 lbs)
Optional locking doors (LK) - add \$110 list

\$3661

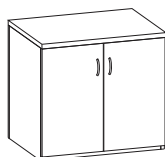

200SC-32_ _
Two door hinged door cabinet (non-locking), one adjustable shelf
24" x 32" x 30"H (140 lbs)
Optional locking doors (LK) - add \$55 list

\$2042

A LA CARTE SERIES

List Price

Storage Units



200WC69_ _ **\$3835**
 Wardrobe, left side clothing carrier, right side four adjustable shelves, non-locking
 24" x 32" x 69"H (285 lbs)
 Optional locking doors (LK) - add \$55 list
 Optional full wardrobe - full coat rod (FULL) - N/C



200WC6916R_ _ hinged right **\$2372**
200WC6916L_ _ hinged left (shown)
 Single unit wardrobe, top shelf, coat rod, non-locking left or right hinged door
 24" x 16" x 69"H (165 lbs)
 Optional locking doors (LK) - add \$55 list

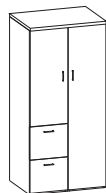

200WSFFR69_ _ right hand wardrobe (shown) **\$4376**
200WSFFL69_ _ left hand wardrobe
 Utility cabinet, wardrobe unit with hinged door (non-locking), top shelf, coat rod, file/file pedestal - bottom (locking), hinged door storage area (non-locking) with two adjustable shelves - top (right hand shown)
 24" x 32" x 69"H (350 lbs)
 Optional locking doors (LK) - add \$110 list



200SCFF6916R_ _ hinged right **\$2852**
200SCFF6916L_ _ hinged left (shown)
 Utility cabinet, file/file pedestal - bottom (locking), hinged door storage area (non-locking) with two adjustable shelves - top (left hand hinged door shown)
 24" x 16" x 69"H (155 lbs)
 Optional locking doors (LK) - add \$55 list

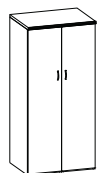

200SC69_ _ **\$3970**
 Storage cabinet, hinged doors (non-locking), four adjustable shelves
 24" x 32" x 69"H (265 lbs)
 Optional locking doors (LK) - add \$55 list



200SC6916R_ _ hinged right **\$2383**
200SC6916L_ _ hinged left (shown)
 Storage cabinet, non-locking left or right hinged door, four adjustable shelves
 24" x 16" x 69"H (175 lbs)
 Optional locking doors (LK) - add \$55 list



200LF/BCW69_ _ **\$4853**
 Storage cabinet / Lateral file, upper hinged door storage (non-locking) with two adjustable shelves, bottom - two lateral file drawers (locking), legal or letter filing
 24" x 32" x 69"H (310 lbs)
 Optional locking doors (LK) - add \$55 list

A LA CARTE SERIES

List Price

Bookcases

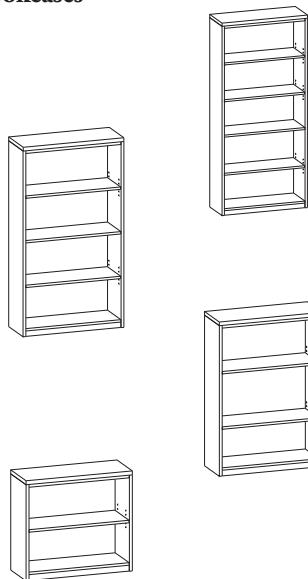

200BC72 \$2143
 Open bookcase with three adjustable shelves, one fixed middle shelf and one fixed bottom shelf, square edge only, unfinished back
 16" x 33" x 72"H (215 lbs)

200BC60 \$1730
 Open bookcase with two adjustable shelves, one fixed middle shelf and one fixed bottom shelf, square edge only, unfinished back
 16" x 33" x 60"H (160 lbs)

200BC48 \$1429
 Open bookcase with two adjustable shelves, one fixed bottom shelf, square edge only, unfinished back
 16" x 33" x 48"H (135 lbs)

200BC30 \$1066
 Open bookcase with one adjustable shelf and one fixed bottom shelf, square edge only, unfinished back
 16" x 33" x 30"H (86 lbs)

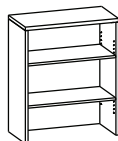

200BCO39_ \$1346
 Stacking bookcase, two adjustable shelves
 16" x 32" x 39"H (70 lbs)

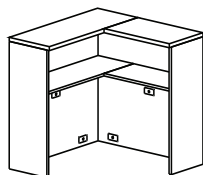

200HC4242 \$2260
 Open corner hutch, one fixed shelf, ** square edge detail only
 24 1/2" clearance between worksurface and bottom shelf
 Each side of the back panel has three grommets: 2 lower, 1 upper
 42" x 42" x 39"H (190 lbs)

200HC3636 \$2045
 Open corner hutch, one fixed shelf, ** square edge detail only
 24 1/2" clearance between worksurface and bottom shelf
 Each side of the back panel has three grommets: 2 lower, 1 upper
 36" x 36" x 39"H (170 lbs)

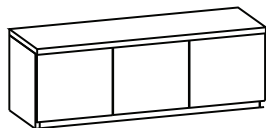

200WM48_ \$1445
 Wall mounted storage unit, three hinged doors
 16" x 48" x 16"H (89 lbs)

200WM42_ \$1247
 Wall mounted storage unit, three hinged doors
 16" x 42" x 16"H (80 lbs)

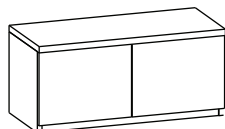

200WM36_ \$1095
 Wall mounted storage unit, two hinged doors
 16" x 36" x 16"H (70 lbs)

200WM30_ \$981
 Wall mounted storage unit, two hinged doors
 16" x 30" x 16"H (62 lbs)

A LA CARTE SERIES

List Price

Computer Desk Workstations - Single Pedestal Desks

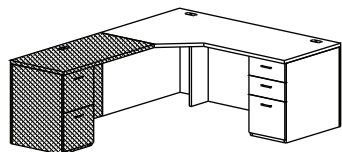

200ECWSR7242SB_ _ **\$3373**
 Executive single pedestal computer desk (RH) with fitted top, box/box/file pedestal (locking), 42" corner unit, two wire mgmt grommets in top, stepped modesty panel 30"- 42" x 72" x 30"H (325 lbs)

200ECWSR7236SB_ _ **\$3198**
 Executive single pedestal computer desk (RH) with fitted top, box/box/file pedestal (locking), 36" corner unit, two wire mgmt grommets in top, stepped modesty panel 24"- 36" x 72" x 30"H (285 lbs)

200ECWSR6636SB_ _ **\$3079**
 Executive single pedestal computer desk (RH) with fitted top, box/box/file pedestal (locking), 36" corner unit, two wire mgmt grommets in top, stepped modesty panel 24"- 36" x 66" x 30"H (260 lbs)

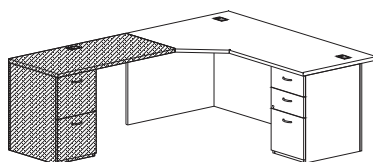

200ECWSR7242FB_ _ **\$3166**
 Executive single pedestal computer desk (RH) with conference top, box/box/file pedestal (locking), 42" corner panel unit, two wire mgmt grommets in top, recessed modesty panel 30"- 42" x 72" x 30"H (315 lbs)



200ECWSR7236FB_ _ **\$2988**
 Executive single pedestal computer desk (RH) with fitted top, box/box/file pedestal (locking), 36" corner unit, two wire mgmt grommets in top, flush modesty panel 24"- 36" x 72" x 30"H (275 lbs)

200ECWSR6636FB_ _ **\$2814**
 Executive single pedestal computer desk (RH) with fitted top, box/box/file pedestal (locking), 36" corner unit, two wire mgmt grommets in top, flush modesty panel 24"- 36" x 66" x 30"H (250 lbs)

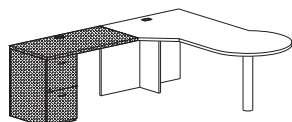

200ECWSP76R_ _ **\$2625**
 Freestanding P-Top computer desk (RH), 36" diameter end, with 4" black pedestal leg, 42" corner unit, one wire mgmt grommet in top (left) 30"-42" x 76" x 30"H (195 lbs)

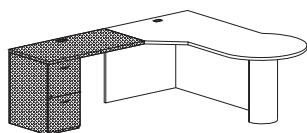

200ECWSP76RFB_ _ **\$3344**
 Freestanding P-Top computer desk (RH), 36" diameter end, with wood half cylinder base with full modesty panel, 42" corner unit, one wire mgmt grommet in top (left) 30"-42" x 76" x 30"H (235 lbs)

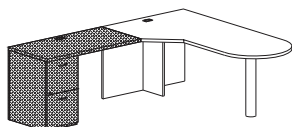

200ECWSB76R_ _ **\$2415**
 Freestanding bullet top computer desk (RH), 30" diameter end, with 4" black pedestal leg, 42" corner unit, one wire mgmt grommet in top (left) 30"-42" x 76" x 30"H (195 lbs)

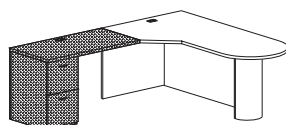





200ECWSB76RFB_ _ **\$3128**
 Freestanding bullet top computer desk (RH), 30" diameter end, with wood half cylinder base with full modesty panel, 42" corner unit, one wire mgmt grommet in top (left) 30"-42" x 76" x 30"H (235 lbs)

A LA CARTE SERIES

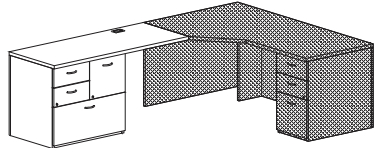
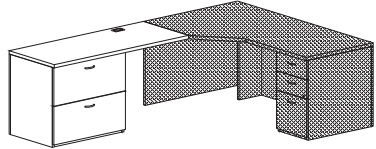
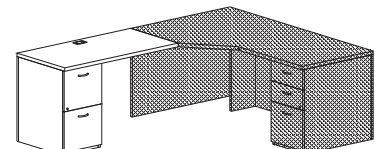
List Price

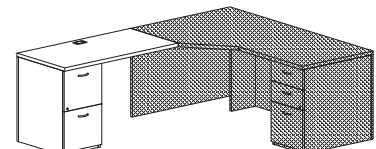
Computer Desk Workstations - Executive Returns

| | | | |
|---|------------------------|---|--------|
|  | 200ERL72FC_ _ | Executive height return (LH), file center pedestal (locking), two box, one file drawer top, one lateral file drawer bottom, one wire mgmt grommet, 40"W kneespace 24" x 72" x 30"H (235 lbs) | \$2892 |
| | 200ERL72FCFB_ _ | with full modesty panel | \$3115 |
| | 200ERL60FC_ _ | Executive height return (LH), file center pedestal (locking), two box, one file drawer top, one lateral file drawer bottom, one wire mgmt grommet, 28"W kneespace 24" x 60" x 30"H (215 lbs) | \$2672 |
| | 200ERL60FCFB_ _ | with full modesty panel | \$2896 |
|  | 200ERL54FC_ _ | Executive height return (LH), file center pedestal (locking), two box, one file drawer top, one lateral file drawer bottom, one wire mgmt grommet, 22"W kneespace 24" x 54" x 30"H (205 lbs) | \$2413 |
| | 200ERL54FCFB_ _ | with full modesty panel | \$2637 |
| | 200ERL72LF_ _ | Executive height return (LH), two lateral file drawers (locking), one wire mgmt grommet, 40"W kneespace 24" x 72" x 30"H (250 lbs) | \$2580 |
| | 200ERL72LFFB_ _ | with full modesty panel | \$2803 |
|  | 200ERL60LF_ _ | Executive height return (LH), two lateral file drawers (locking), one wire mgmt grommet, 28"W kneespace 24" x 60" x 30"H (225 lbs) | \$2345 |
| | 200ERL60LFFB_ _ | with full modesty panel | \$2568 |
| | 200ERL54LF_ _ | Executive height return (LH), two lateral file drawers (locking), one wire mgmt grommet, 22"W kneespace 24" x 54" x 30"H (180 lbs) | \$2190 |
| | 200ERL54LFFB_ _ | with full modesty panel | \$2418 |
|  | 200ERL72_ _ | Executive height return (LH), file/file pedestal (locking), 1/2 support panel on connection end, one wire mgmt grommet, 56"W kneespace, 24" x 72" x 30"H (200 lbs) | \$2330 |
| | 200ERL72FB_ _ | with full modesty panel | \$2554 |
| | 200ERL60_ _ | Executive height return (LH), file/file pedestal (locking), one wire mgmt grommet, 32"W kneespace 24" x 60" x 30"H (140 lbs) | \$2035 |
| | 200ERL60FB_ _ | with full modesty panel | \$2252 |
|  | 200ERL54_ _ | Executive height return (LH), file/file pedestal (locking), one wire mgmt grommet, 32"W kneespace 24" x 54" x 30"H (140 lbs) | \$1887 |
| | 200ERL54FB_ _ | with full modesty panel | \$2101 |
| | 200ERL48_ _ | Executive height return (LH), file/file pedestal (locking), one wire mgmt grommet, 32"W kneespace 24" x 48" x 30"H (140 lbs) | \$1739 |
| | 200ERL48FB_ _ | with full modesty panel | \$1950 |
|  | 200ERL42_ _ | Executive height return (LH), file/file pedestal (locking), one wire mgmt grommet, 26"W kneespace 24" x 42" x 30"H (135 lbs) | \$1701 |
| | 200ERL42FB_ _ | with full modesty panel | \$1898 |
| | 200ERL36_ _ | Executive height return (LH), file/file pedestal (locking), one wire mgmt grommet, 20"W kneespace 24" x 36" x 30"H (130 lbs) | \$1540 |
| | 200ERL36FB_ _ | with full modesty panel | \$1675 |



A LA CARTE SERIES

List Price

Computer Desk Workstations - Single Pedestal Desks

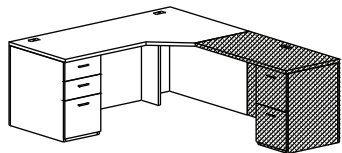

200ECWSL7242SB_ _ **\$3373**
 Executive single pedestal computer desk (LH) with fitted top, box/box/file pedestal (locking), 42" corner unit, two wire mgmt grommets in top, stepped modesty panel
 30"- 42" x 72" x 30"H (325 lbs)

200ECWSL7236SB_ _ **\$3198**
 Executive single pedestal computer desk (LH) with fitted top, box/box/file pedestal (locking), 36" corner unit, two wire mgmt grommets in top, stepped modesty panel
 24"- 36" x 72" x 30"H (285 lbs)

200ECWSL6636SB_ _ **\$3079**
 Executive single pedestal computer desk (LH) with fitted top, box/box/file pedestal (locking), 36" corner unit, two wire mgmt grommets in top, stepped modesty panel
 24"- 36" x 66" x 30"H (260 lbs)

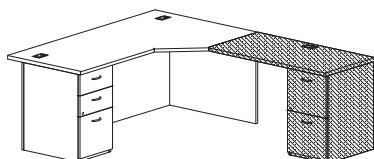

200ECWSL7242FB_ _ **\$3166**
 Executive single pedestal computer desk (LH) with conference top, box/box/file pedestal (locking), 42" corner unit, two wire mgmt grommets in top, recessed modesty panel
 30"- 42" x 72" x 30"H (315 lbs)



200ECWSL7236FB_ _ **\$2988**
 Executive single pedestal computer desk (LH) with fitted top, box/box/file pedestal (locking), 36" corner unit, two wire mgmt grommets in top, flush modesty panel
 24"- 36" x 72" x 30"H (275 lbs)

200ECWSL6636FB_ _ **\$2814**
 Executive single pedestal computer desk (LH) with fitted top, box/box/file pedestal (locking), 36" corner unit, two wire mgmt grommets in top, flush modesty panel
 24"- 36" x 66" x 30"H (250 lbs)

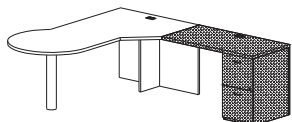

200ECWSP76L_ **\$2625**
 Freestanding P-Top computer desk (LH), 36" diameter end, with 4" black pedestal leg, 42" corner unit, one wire mgmt grommet in top (left)
 30"-42" x 76" x 30"H (195 lbs)

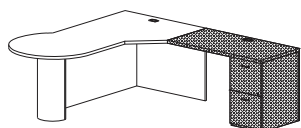

200ECWSP76LFB_ **\$3344**
 Freestanding P-Top computer desk (LH), 36" diameter end, with wood half cylinder base with full modesty panel, 42" corner unit, one wire mgmt grommet in top (left)
 30"-42" x 76" x 30"H (235 lbs)

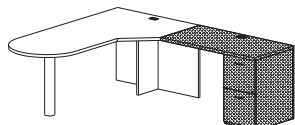

200ECWSB76L_ **\$2415**
 Freestanding bullet top computer desk (LH), 30" diameter end, with 4" black pedestal leg, 42" corner unit, one wire mgmt grommet in top (right)
 30"-42" x 76" x 30"H (195 lbs)

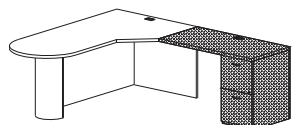



200ECWSB76LFB_ **\$3128**
 Freestanding bullet top computer desk (LH), 30" diameter end, with wood half cylinder base with full modesty panel, 42" corner unit, one wire mgmt grommet in top (right)
 30"-42" x 76" x 30"H (235 lbs)

A LA CARTE SERIES

List Price

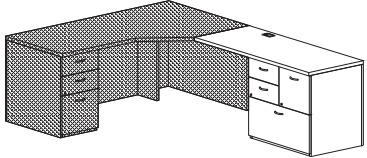
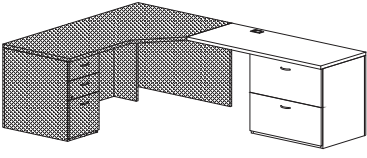
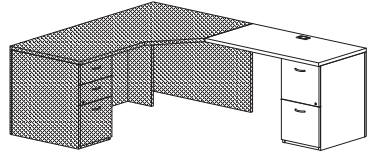
Computer Desk Workstations - Executive Returns

| | |
|---|---|
|  | 200ERR72FC__ \$2892 |
| | Executive height return (RH), file center pedestal (locking), two box, one file drawer top, one lateral file drawer bottom, one wire mgmt grommet, 40"W kneespace 24" x 72" x 30"H (235 lbs) |
| | 200ERR72FCFB__ with full modesty panel \$3115 |
|  | 200ERR60FC__ \$2672 |
| | Executive height return (RH), file center pedestal (locking), two box, one file drawer top, one lateral file drawer bottom, one wire mgmt grommet, 28"W kneespace 24" x 60" x 30"H (215 lbs) |
| | 200ERR60FCFB__ with full modesty panel \$2896 |
|  | 200ERR54FC__ \$2413 |
| | Executive height return (RH), file center pedestal (locking), two box, one file drawer top, one lateral file drawer bottom, one wire mgmt grommet, 22"W kneespace 24" x 54" x 30"H (205 lbs) |
| | 200ERR54FCFB__ with full modesty panel \$2637 |
|  | 200ERR72LF__ \$2580 |
| | Executive height return (RH), two lateral file drawers (locking), one wire mgmt grommet, 40"W kneespace 24" x 72" x 30"H (250 lbs) |
| | 200ERR72LFFB__ with full modesty panel \$2803 |
|  | 200ERR60LF__ \$2345 |
| | Executive height return (RH), two lateral file drawers (locking), one wire mgmt grommet, 28"W kneespace 24" x 60" x 30"H (225 lbs) |
| | 200ERR60LFFB__ with full modesty panel \$2568 |
| | 200ERR54LF__ \$2190 |
| | Executive height return (RH), two lateral file drawers (locking), one wire mgmt grommet, 22"W kneespace 24" x 54" x 30"H (180 lbs) |
| | 200ERR54LFFB__ with full modesty panel \$2418 |
| | 200ERR72__ \$2330 |
| | Executive height return (RH), file/file pedestal (locking), 1/2 support panel on connection end, one wire mgmt grommet, 56"W kneespace 24" x 72" x 30"H (200 lbs) |
| | 200ERR72FB__ with full modesty panel \$2554 |
| | 200ERR60__ \$2035 |
| | Executive height return (RH), file/file pedestal (locking), one wire mgmt grommet, 32"W kneespace 24" x 60" x 30"H (140 lbs) |
| | 200ERR60FB__ with full modesty panel \$2252 |
| | 200ERR54__ \$1887 |
| | Executive height return (RH), file/file pedestal (locking), one wire mgmt grommet, 32"W kneespace 24" x 54" x 30"H (140 lbs) |
| | 200ERR54FB__ with full modesty panel \$2101 |
| | 200ERR48__ \$1739 |
| | Executive height return (RH), file/file pedestal (locking), one wire mgmt grommet, 32"W kneespace 24" x 48" x 30"H (140 lbs) |
| | 200ERR48FB__ with full modesty panel \$1950 |
| | 200ERR42__ \$1701 |
| | Executive height return (RH), file/file pedestal (locking), one wire mgmt grommet, 26"W kneespace 24" x 42" x 30"H (135 lbs) |
| | 200ERR42FB__ with full modesty panel \$1898 |
| | 200ERR36__ \$1540 |
| | Executive height return (RH), file/file pedestal (locking), one wire mgmt grommet, 20"W kneespace 24" x 36" x 30"H (130 lbs) |
| | 200ERR36FB__ with full modesty panel \$1675 |



A LA CARTE SERIES

List Price

Executive Workstations - Single Pedestal Desks - Stepped Modesty Panel

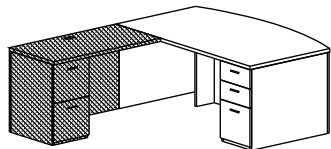

200KSPR8442SB_ _ **\$3942**
 Executive single pedestal desk (RH) with arc conference top, box/box/file pedestal (locking),
 10" center overhang, stepped modesty panel
 42" x 84" x 30"H (350 lbs)

200KSPR7242SB_ _ **\$3599**
 Executive single pedestal desk (RH) with arc conference top, box/box/file pedestal (locking),
 10" center overhang, stepped modesty panel
 42" x 72" x 30"H (335 lbs)

200KSPR7236SB_ _ **\$3311**
 Executive single pedestal desk (RH) with arc conference top, box/box/file pedestal (locking),
 10" center overhang, stepped modesty panel
 36" x 72" x 30"H (305 lbs)

200SPR8442SB_ _ **\$3646**
 Executive single pedestal desk (RH), box/box/file pedestal (locking),
 4" center overhang, stepped modesty panel
 42" x 84" x 30"H (330 lbs)

200SPR7236SB_ _ **\$3374**
 Executive single pedestal desk (RH), box/box/file pedestal (locking),
 4" center overhang, stepped modesty panel
 36" x 72" x 30"H (300 lbs)

200SPR7230SB_ _ **\$3132**
 Executive single pedestal desk (RH), box/box/file pedestal (locking),
 4" center overhang, stepped modesty panel
 30" x 72" x 30"H (280 lbs)

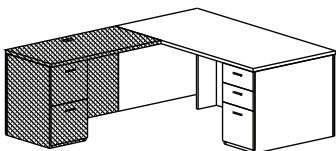

200SPR6636SB_ _ **\$3287**
 Executive single pedestal desk (RH), box/box/file pedestal (locking),
 4" center overhang, stepped modesty panel
 36" x 66" x 30"H (305 lbs)





200SPR6630SB_ _ **\$3027**
 Executive single pedestal desk (RH), box/box/file pedestal (locking),
 4" center overhang, stepped modesty panel
 30" x 66" x 30"H (295 lbs)

200SPR6030SB_ _ **\$2902**
 Executive single pedestal desk (RH), box/box/file pedestal (locking),
 4" center overhang, stepped modesty panel
 10" pedestal accommodates side-to-side letter or legal filing only.
200SPR6030SB-FS If freestanding option is specified, pedestal will
 be letter width. 30" x 60" x 30"H (275 lbs)

A LA CARTE SERIES

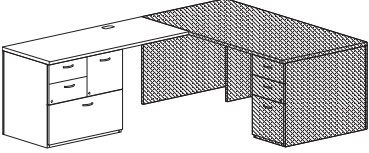
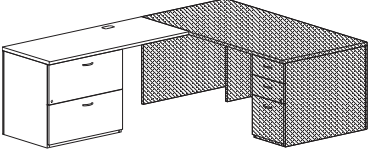
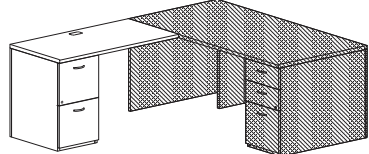
List Price

Executive Workstations - Executive Returns

| | | |
|---|---|--------|
|  | 200ERL72FC _ _ | \$2892 |
| | Executive height return (LH), file center pedestal (locking), two box, one file drawer top, one lateral file drawer bottom, one wire mgmt grommet, 40"W kneespace 24" x 72" x 30"H (235 lbs) | |
| | 200ERL72FCFB _ _ with full modesty panel | \$3115 |
|  | 200ERL60FC _ _ | \$2672 |
| | Executive height return (LH), file center pedestal (locking), two box, one file drawer top, one lateral file drawer bottom, one wire mgmt grommet, 28"W kneespace 24" x 60" x 30"H (215 lbs) | |
| | 200ERL60FCFB _ _ with full modesty panel | \$2896 |
|  | 200ERL54FC _ _ | \$2413 |
| | Executive height return (LH), file center pedestal (locking), two box, one file drawer top, one lateral file drawer bottom, one wire mgmt grommet, 22"W kneespace 24" x 54" x 30"H (205 lbs) | |
| | 200ERL54FCFB _ _ with full modesty panel | \$2637 |
|  | 200ERL72LF _ _ | \$2580 |
| | Executive height return (LH), two lateral file drawers (locking), one wire mgmt grommet, 40"W kneespace 24" x 72" x 30"H (250 lbs) | |
| | 200ERL72LFFB _ _ with full modesty panel | \$2803 |
|  | 200ERL60LF _ _ | \$2345 |
| | Executive height return (LH), two lateral file drawers (locking), one wire mgmt grommet, 28"W kneespace 24" x 60" x 30"H (225 lbs) | |
| | 200ERL60LFFB _ _ with full modesty panel | \$2568 |
|  | 200ERL54LF _ _ | \$2190 |
| | Executive height return (LH), two lateral file drawers (locking), one wire mgmt grommet, 22"W kneespace 24" x 54" x 30"H (180 lbs) | |
| | 200ERL54LFFB _ _ with full modesty panel | \$2418 |
| | 200ERL72 _ _ | \$2330 |
| | Executive height return (LH), file/file pedestal (locking), 1/2 support panel on connection end, one wire mgmt grommet, 56"W kneespace, 24" x 72" x 30"H (200 lbs) | |
| | 200ERL72FB _ _ with full modesty panel | \$2554 |
| | 200ERL60 _ _ | \$2035 |
| | Executive height return (LH), file/file pedestal (locking), one wire mgmt grommet, 32"W kneespace 24" x 60" x 30"H (140 lbs) | |
| | 200ERL60FB _ _ with full modesty panel | \$2252 |
| | 200ERL54 _ _ | \$1887 |
| | Executive height return (LH), file/file pedestal (locking), one wire mgmt grommet, 32"W kneespace 24" x 54" x 30"H (140 lbs) | |
| | 200ERL54FB _ _ with full modesty panel | \$2101 |
| | 200ERL48 _ _ | \$1739 |
| | Executive height return (LH), file/file pedestal (locking), one wire mgmt grommet, 32"W kneespace 24" x 48" x 30"H (140 lbs) | |
| | 200ERL48FB _ _ with full modesty panel | \$1950 |
| | 200ERL42 _ _ | \$1701 |
| | Executive height return (LH), file/file pedestal (locking), one wire mgmt grommet, 26"W kneespace 24" x 42" x 30"H (135 lbs) | |
| | 200ERL42FB _ _ with full modesty panel | \$1898 |
| | 200ERL36 _ _ | \$1540 |
| | Executive height return (LH), file/file pedestal (locking), one wire mgmt grommet, 20"W kneespace 24" x 36" x 30"H (130 lbs) | |
| | 200ERL36FB _ _ with full modesty panel | \$1675 |



A LA CARTE SERIES

List Price

Executive Workstations - Single Pedestal Desks - Stepped Modesty Panel

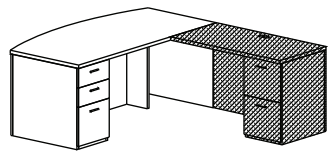

200KSPL8442SB__ **\$3942**
 Executive single pedestal desk (LH) with arc conference top, box/box/file pedestal (locking),
 10" center overhang, stepped modesty panel
 42" x 84" x 30"H (350 lbs)

200KSPL7242SB__ **\$3599**
 Executive single pedestal desk (LH) with arc conference top, box/box/file pedestal (locking),
 10" center overhang, stepped modesty panel
 42" x 72" x 30"H (335 lbs)

200KSPL7236SB__ **\$3311**
 Executive single pedestal desk (LH) with arc conference top, box/box/file pedestal (locking),
 10" center overhang, stepped modesty panel
 36" x 72" x 30"H (305 lbs)

200SPL8442SB__ **\$3646**
 Executive single pedestal desk (LH), box/box/file pedestal (locking),
 4" center overhang, stepped modesty panel
 42" x 84" x 30"H (330 lbs)

200SPL7236SB__ **\$3374**
 Executive single pedestal desk (LH), box/box/file pedestal (locking),
 4" center overhang, stepped modesty panel
 36" x 72" x 30"H (300 lbs)

200SPL7230SB__ **\$3132**
 Executive single pedestal desk (LH), box/box/file pedestal (locking),
 4" center overhang, stepped modesty panel
 30" x 72" x 30"H (280 lbs)

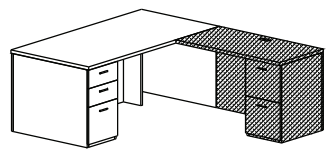

200SPL6636SB__ **\$3287**
 Executive single pedestal desk (LH), box/box/file pedestal (locking),
 4" center overhang, stepped modesty panel
 36" x 66" x 30"H (305 lbs)



200SPL6630SB__ **\$3027**
 Executive single pedestal desk (LH), box/box/file pedestal (locking),
 4" center overhang, stepped modesty panel
 30" x 66" x 30"H (295 lbs)

200SPL6030SB__ **\$2902**
 Executive single pedestal desk (LH), box/box/file pedestal (locking),
 4" center overhang, stepped modesty panel
 10" w pedestal accommodates side-to-side letter or legal filing only.
200SPL6030SB-FS If freestanding option is specified, pedestal will
 be letter width. 30" x 60" x 30"H (275 lbs)

A LA CARTE SERIES

List Price

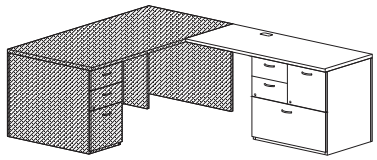
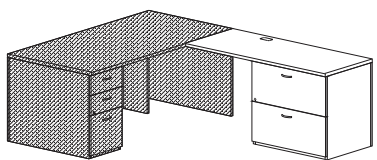
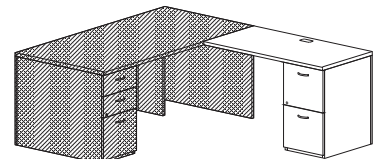
Executive Workstations - Executive Returns

| | |
|---|---|
|  | 200ERR72FC__ \$2892 |
| | Executive height return (RH), file center pedestal (locking), two box, one file drawer top, one lateral file drawer bottom, one wire mgmt grommet, 40"W kneespace 24" x 72" x 30"H (235 lbs) |
| | 200ERR72FCFB__ with full modesty panel \$3115 |
|  | 200ERR60FC__ \$2672 |
| | Executive height return (RH), file center pedestal (locking), two box, one file drawer top, one lateral file drawer bottom, one wire mgmt grommet, 28"W kneespace 24" x 60" x 30"H (215 lbs) |
| | 200ERR60FCFB__ with full modesty panel \$2896 |
|  | 200ERR54FC__ \$2413 |
| | Executive height return (RH), file center pedestal (locking), two box, one file drawer top, one lateral file drawer bottom, one wire mgmt grommet, 22"W kneespace 24" x 54" x 30"H (205 lbs) |
| | 200ERR54FCFB__ with full modesty panel \$2637 |
|  | 200ERR72LF__ \$2580 |
| | Executive height return (RH), two lateral file drawers (locking), one wire mgmt grommet, 40"W kneespace 24" x 72" x 30"H (250 lbs) |
| | 200ERR72LFFB__ with full modesty panel \$2803 |
|  | 200ERR60LF__ \$2345 |
| | Executive height return (RH), two lateral file drawers (locking), one wire mgmt grommet, 28"W kneespace 24" x 60" x 30"H (225 lbs) |
| | 200ERR60LFFB__ with full modesty panel \$2568 |
| | 200ERR54LF__ \$2190 |
| | Executive height return (RH), two lateral file drawers (locking), one wire mgmt grommet, 22"W kneespace 24" x 54" x 30"H (180 lbs) |
| | 200ERR54LFFB__ with full modesty panel \$2418 |
| | 200ERR72__ \$2330 |
| | Executive height return (RH), file/file pedestal (locking), 1/2 support panel on connection end, one wire mgmt grommet, 56"W kneespace 24" x 72" x 30"H (200 lbs) |
| | 200ERR72FB__ with full modesty panel \$2554 |
| | 200ERR60__ \$2035 |
| | Executive height return (RH), file/file pedestal (locking), one wire mgmt grommet, 32"W kneespace 24" x 60" x 30"H (140 lbs) |
| | 200ERR60FB__ with full modesty panel \$2252 |
| | 200ERR54__ \$1887 |
| | Executive height return (RH), file/file pedestal (locking), one wire mgmt grommet, 32"W kneespace 24" x 54" x 30"H (140 lbs) |
| | 200ERR54FB__ with full modesty panel \$2101 |
| | 200ERR48__ \$1739 |
| | Executive height return (RH), file/file pedestal (locking), one wire mgmt grommet, 32"W kneespace 24" x 48" x 30"H (140 lbs) |
| | 200ERR48FB__ with full modesty panel \$1950 |
| | 200ERR42__ \$1701 |
| | Executive height return (RH), file/file pedestal (locking), one wire mgmt grommet, 26"W kneespace 24" x 42" x 30"H (135 lbs) |
| | 200ERR42FB__ with full modesty panel \$1898 |
| | 200ERR36__ \$1540 |
| | Executive height return (RH), file/file pedestal (locking), one wire mgmt grommet, 20"W kneespace 24" x 36" x 30"H (130 lbs) |
| | 200ERR36FB__ with full modesty panel \$1675 |



A LA CARTE SERIES

List Price

Executive Workstations - Single Pedestal Desks - Recessed Modesty Panel

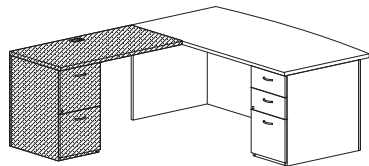

200KSPR8442FB_ _ **\$3620**
 Executive single pedestal desk (RH) with arc conference top, box/box/file pedestal (locking),
 6" center overhang, recessed modesty panel
 42" x 84" x 30"H (350 lbs)

200KSPR7242FB_ _ **\$3331**
 Executive single pedestal desk (RH) with arc conference top, box/box/file pedestal (locking),
 6" center overhang, recessed modesty panel
 42" x 72" x 30"H (335 lbs)

200KSPR7236FB_ _ **\$3045**
 Executive single pedestal desk (RH) with arc conference top, box/box/file pedestal (locking),
 6" center overhang, recessed modesty panel
 36" x 72" x 30"H (305 lbs)

200SPR8442FB_ _ **\$3401**
 Executive single pedestal desk (RH), box/box/file pedestal (locking),
 6" overhang, recessed modesty panel
 42" x 84" x 30"H (330 lbs)

200SPR7236FB_ _ **\$3038**
 Executive single pedestal desk (RH), box/box/file pedestal (locking),
 6" overhang, recessed modesty panel
 36" x 72" x 30"H (300 lbs)



200SPR7230FB_ _ **\$2747**
 Executive single pedestal desk (RH), box/box/file pedestal (locking),
 6" overhang, recessed modesty panel
 30" x 72" x 30"H (280 lbs)

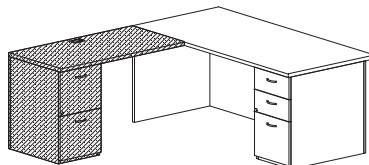

200SPR6636FB_ _ **\$2944**
 Executive single pedestal desk (RH), box/box/file pedestal (locking),
 6" overhang, recessed modesty panel
 36" x 66" x 30"H (305 lbs)

200SPR6630FB_ _ **\$2628**
 Executive single pedestal desk (RH), box/box/file pedestal (locking),
 6" overhang, recessed modesty panel
 30" x 66" x 30"H (295 lbs)



200SPR6030FB_ _ **\$2398**
 Executive single pedestal desk (RH), box/box/file pedestal (locking),
 6" overhang, recessed modesty panel
 10" w pedestal accommodates side-to-side letter or legal filing only.
200SPR6030FB-FS If freestanding option is specified, pedestal
 will be letter width. 30" x 60" x 30"H (275 lbs)

A LA CARTE SERIES

List Price

Executive Workstations - Executive Returns

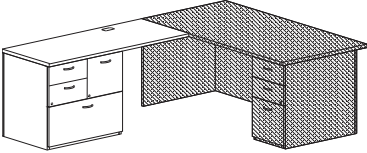
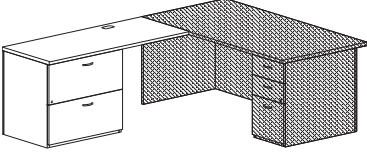
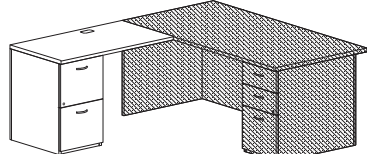
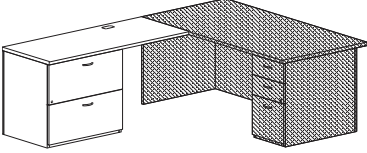
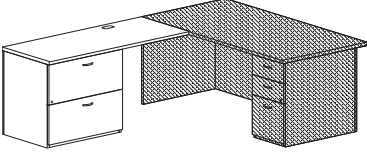
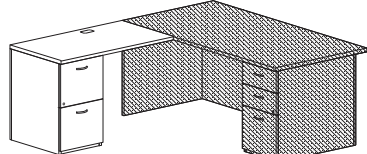
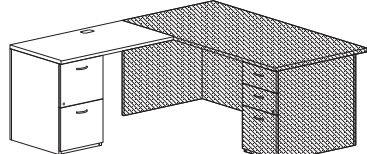
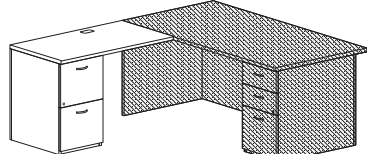
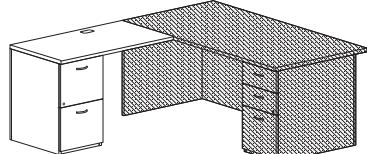
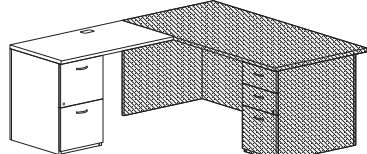
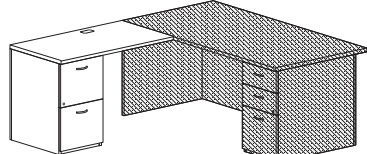
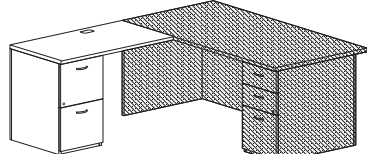
| | | |
|---|---|--------|
|  | 200ERL72FC _ _ | \$2892 |
| | Executive height return (LH), file center pedestal (locking), two box, one file drawer top, one lateral file drawer bottom, one wire mgmt grommet, 40"W kneespace 24" x 72" x 30"H (235 lbs) | |
| | 200ERL72FCFB _ _ with full modesty panel | \$3115 |
|  | 200ERL60FC _ _ | \$2672 |
| | Executive height return (LH), file center pedestal (locking), two box, one file drawer top, one lateral file drawer bottom, one wire mgmt grommet, 28"W kneespace 24" x 60" x 30"H (215 lbs) | |
| | 200ERL60FCFB _ _ with full modesty panel | \$2896 |
|  | 200ERL54FC _ _ | \$2413 |
| | Executive height return (LH), file center pedestal (locking), two box, one file drawer top, one lateral file drawer bottom, one wire mgmt grommet, 22"W kneespace 24" x 54" x 30"H (205 lbs) | |
| | 200ERL54FCFB _ _ with full modesty panel | \$2637 |
|  | 200ERL72LF _ _ | \$2580 |
| | Executive height return (LH), two lateral file drawers (locking), one wire mgmt grommet, 40"W kneespace 24" x 72" x 30"H (250 lbs) | |
| | 200ERL72LFFB _ _ with full modesty panel | \$2803 |
|  | 200ERL60LF _ _ | \$2345 |
| | Executive height return (LH), two lateral file drawers (locking), one wire mgmt grommet, 28"W kneespace 24" x 60" x 30"H (225 lbs) | |
| | 200ERL60LFFB _ _ with full modesty panel | \$2568 |
|  | 200ERL54LF _ _ | \$2190 |
| | Executive height return (LH), two lateral file drawers (locking), one wire mgmt grommet, 22"W kneespace 24" x 54" x 30"H (180 lbs) | |
| | 200ERL54LFFB _ _ with full modesty panel | \$2418 |
|  | 200ERL72 _ _ | \$2330 |
| | Executive height return (LH), file/file pedestal (locking), 1/2 support panel on connection end, one wire mgmt grommet, 56"W kneespace, 24" x 72" x 30"H (200 lbs) | |
| | 200ERL72FB _ _ with full modesty panel | \$2554 |
|  | 200ERL60 _ _ | \$2035 |
| | Executive height return (LH), file/file pedestal (locking), one wire mgmt grommet, 32"W kneespace 24" x 60" x 30"H (140 lbs) | |
| | 200ERL60FB _ _ with full modesty panel | \$2252 |
|  | 200ERL54 _ _ | \$1887 |
| | Executive height return (LH), file/file pedestal (locking), one wire mgmt grommet, 32"W kneespace 24" x 54" x 30"H (140 lbs) | |
| | 200ERL54FB _ _ with full modesty panel | \$2101 |
|  | 200ERL48 _ _ | \$1739 |
| | Executive height return (LH), file/file pedestal (locking), one wire mgmt grommet, 32"W kneespace 24" x 48" x 30"H (140 lbs) | |
| | 200ERL48FB _ _ with full modesty panel | \$1950 |
|  | 200ERL42 _ _ | \$1701 |
| | Executive height return (LH), file/file pedestal (locking), one wire mgmt grommet, 26"W kneespace 24" x 42" x 30"H (135 lbs) | |
| | 200ERL42FB _ _ with full modesty panel | \$1898 |
|  | 200ERL36 _ _ | \$1540 |
| | Executive height return (LH), file/file pedestal (locking), one wire mgmt grommet, 20"W kneespace 24" x 36" x 30"H (130 lbs) | |
| | 200ERL36FB _ _ with full modesty panel | \$1675 |



A LA CARTE SERIES

List Price

Executive Workstations - Single Pedestal Desks - Recessed Modesty Panel

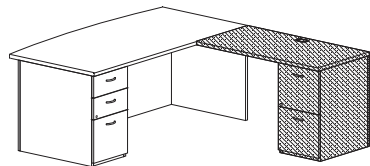

200KSPL8442FB__ **\$3620**
 Executive single pedestal desk (LH) with arc conference top, box/box/file pedestal (locking),
 6" center overhang, recessed modesty panel
 42" x 84" x 30"H (350 lbs)

200KSPL7242FB__ **\$3331**
 Executive single pedestal desk (LH) with arc conference top, box/box/file pedestal (locking),
 6" center overhang, recessed modesty panel
 42" x 72" x 30"H (335 lbs)

200KSPL7236FB__ **\$3045**
 Executive single pedestal desk (LH) with arc conference top, box/box/file pedestal (locking),
 6" center overhang, recessed modesty panel
 36" x 72" x 30"H (305 lbs)

200SPL8442FB__ **\$3401**
 Executive single pedestal desk (LH), box/box/file pedestal (locking),
 6" overhang, recessed modesty panel
 42" x 84" x 30"H (350 lbs)

200SPL7236FB__ **\$3038**
 Executive single pedestal desk (LH), box/box/file pedestal (locking),
 6" overhang, recessed modesty panel
 36" x 72" x 30"H (300 lbs)



200SPL7230FB__ **\$2747**
 Executive single pedestal desk (LH), box/box/file pedestal (locking),
 6" overhang, recessed modesty panel
 30" x 72" x 30"H (280 lbs)

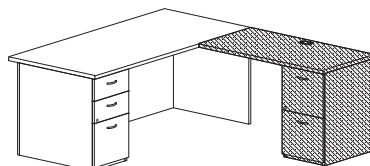

200SPL6636FB__ **\$2944**
 Executive single pedestal desk (LH), box/box/file pedestal (locking),
 6" overhang, recessed modesty panel
 36" x 66" x 30"H (305 lbs)

200SPL6630FB__ **\$2628**
 Executive single pedestal desk (LH), box/box/file pedestal (locking),
 6" overhang, recessed modesty panel
 30" x 66" x 30"H (295 lbs)





200SPL6030FB__ **\$2398**
 Executive single pedestal desk (LH), box/box/file pedestal (locking),
 6" overhang, recessed modesty panel
 10" w pedestal accommodates side-to-side letter or legal filing only.
200SPL6030FB-FS If freestanding option is specified, pedestal
 will be letter width. 30" x 60" x 30"H (275 lbs)

A LA CARTE SERIES

List Price

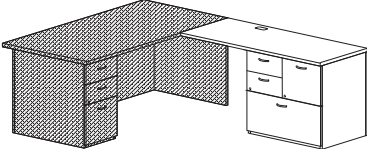
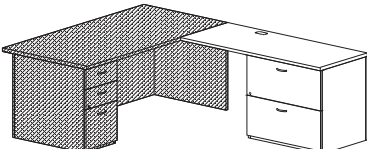
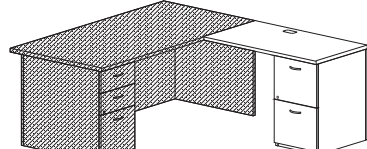
Executive Workstations - Executive Returns

| | |
|---|---|
|  | 200ERR72FC__ \$2892 |
| | Executive height return (RH), file center pedestal (locking), two box, one file drawer top, one lateral file drawer bottom, one wire mgmt grommet, 40"W kneespace 24" x 72" x 30"H (235 lbs) |
| | 200ERR72FCFB__ with full modesty panel \$3115 |
|  | 200ERR60FC__ \$2672 |
| | Executive height return (RH), file center pedestal (locking), two box, one file drawer top, one lateral file drawer bottom, one wire mgmt grommet, 28"W kneespace 24" x 60" x 30"H (215 lbs) |
| | 200ERR60FCFB__ with full modesty panel \$2896 |
|  | 200ERR54FC__ \$2413 |
| | Executive height return (RH), file center pedestal (locking), two box, one file drawer top, one lateral file drawer bottom, one wire mgmt grommet, 22"W kneespace 24" x 54" x 30"H (205 lbs) |
| | 200ERR54FCFB__ with full modesty panel \$2637 |
|  | 200ERR72LF__ \$2580 |
| | Executive height return (RH), two lateral file drawers (locking), one wire mgmt grommet, 40"W kneespace 24" x 72" x 30"H (250 lbs) |
| | 200ERR72LFFB__ with full modesty panel \$2803 |
|  | 200ERR60LF__ \$2345 |
| | Executive height return (RH), two lateral file drawers (locking), one wire mgmt grommet, 28"W kneespace 24" x 60" x 30"H (225 lbs) |
| | 200ERR60LFFB__ with full modesty panel \$2568 |
| | 200ERR54LF__ \$2190 |
| | Executive height return (RH), two lateral file drawers (locking), one wire mgmt grommet, 22"W kneespace 24" x 54" x 30"H (180 lbs) |
| | 200ERR54LFFB__ with full modesty panel \$2418 |
| | 200ERR72__ \$2330 |
| | Executive height return (RH), file/file pedestal (locking), 1/2 support panel on connection end, one wire mgmt grommet, 56"W kneespace 24" x 72" x 30"H (200 lbs) |
| | 200ERR72FB__ with full modesty panel \$2554 |
| | 200ERR60__ \$2035 |
| | Executive height return (RH), file/file pedestal (locking), one wire mgmt grommet, 32"W kneespace 24" x 60" x 30"H (140 lbs) |
| | 200ERR60FB__ with full modesty panel \$2252 |
| | 200ERR54__ \$1887 |
| | Executive height return (RH), file/file pedestal (locking), one wire mgmt grommet, 32"W kneespace 24" x 54" x 30"H (140 lbs) |
| | 200ERR54FB__ with full modesty panel \$2101 |
| | 200ERR48__ \$1739 |
| | Executive height return (RH), file/file pedestal (locking), one wire mgmt grommet, 32"W kneespace 24" x 48" x 30"H (140 lbs) |
| | 200ERR48FB__ with full modesty panel \$1950 |
| | 200ERR42__ \$1701 |
| | Executive height return (RH), file/file pedestal (locking), one wire mgmt grommet, 26"W kneespace 24" x 42" x 30"H (135 lbs) |
| | 200ERR42FB__ with full modesty panel \$1898 |
| | 200ERR36__ \$1540 |
| | Executive height return (RH), file/file pedestal (locking), one wire mgmt grommet, 20"W kneespace 24" x 36" x 30"H (130 lbs) |
| | 200ERR36FB__ with full modesty panel \$1675 |



A LA CARTE SERIES

List Price

Executive Workstations - P-Top Desks

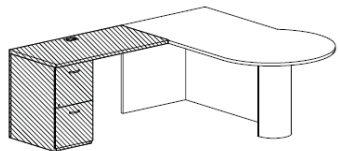

200WSP7236RFB_
P-top desk (RH), 42" diameter end, wood half cylinder base with full modesty 36" x 72" x 30"H (190 lbs)

\$3020

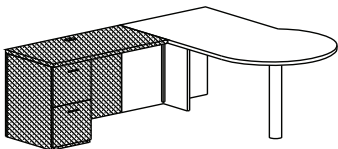

200WSP7236R_
P-top desk (RH), 42" diameter end, 4" diameter black metal base 36" x 72" x 30"H (170 lbs)

\$2301



Executive Workstations - Bullet Desks

200WSB7236RFB_
Bullet desk (RH), 36" diameter end, wood half cylinder base with full modesty 36" x 72" x 30"H (200 lbs)

\$2755

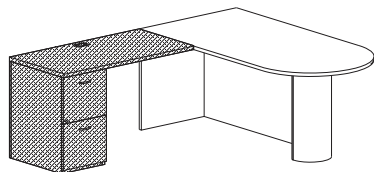

200WSB7230RFB_
Bullet desk (RH), 30" diameter end, wood half cylinder base with full modesty 30" x 72" x 30"H (177 lbs)

\$2519

200WSB6630RFB_
Bullet desk (RH), 30" diameter end, wood half cylinder base with full modesty 30" x 66" x 30"H (150 lbs)

\$2146

200WSB7236_
Bullet desk, 36" diameter end, 4" diameter black metal base 36" x 72" x 30"H (165 lbs)

\$2017

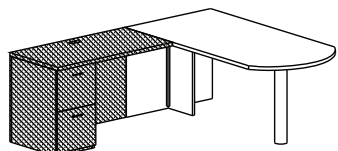

200WSB7230_
Bullet desk, 30" diameter end, 4" diameter black metal base 30" x 72" x 30"H (157 lbs)

\$1806



200WSB6630_
Bullet desk, 30" diameter end, 4" diameter black metal base 30" x 66" x 30"H (130 lbs)

\$1681

A LA CARTE SERIES

List Price

Executive Workstations - Executive Returns

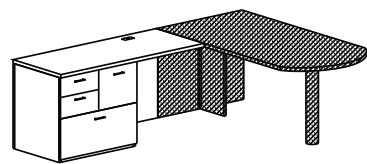

200ERL72FC_ _ \$2892
 Executive height return (LH), file center pedestal (locking), two box, one file drawer top, one lateral file drawer bottom, one wire mgmt grommet, 40"W kneespace
 24" x 72" x 30"H (235 lbs)

200ERL72FCFB_ _ with full modesty panel \$3115

200ERL60FC_ _ \$2672
 Executive height return (LH), file center pedestal (locking), two box, one file drawer top, one lateral file drawer bottom, one wire mgmt grommet, 28"W kneespace
 24" x 60" x 30"H (215 lbs)

200ERL60FCFB_ _ with full modesty panel \$2896

200ERL54FC_ _ \$2413
 Executive height return (LH), file center pedestal (locking), two box, one file drawer top, one lateral file drawer bottom, one wire mgmt grommet, 22"W kneespace
 24" x 54" x 30"H (205 lbs)

200ERL54FCFB_ _ with full modesty panel \$2637

200ERL72LF_ _ \$2580
 Executive height return (LH), two lateral file drawers (locking), one wire mgmt grommet, 40"W kneespace
 24" x 72" x 30"H (250 lbs)

200ERL72LFFB_ _ with full modesty panel \$2803

200ERL60LF_ _ \$2345
 Executive height return (LH), two lateral file drawers (locking), one wire mgmt grommet, 28"W kneespace
 24" x 60" x 30"H (225 lbs)

200ERL60LFFB_ _ with full modesty panel \$2568

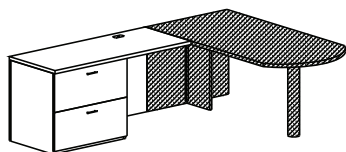

200ERL54LF_ _ \$2190
 Executive height return (LH), two lateral file drawers (locking), one wire mgmt grommet, 22"W kneespace
 24" x 54" x 30"H (180 lbs)

200ERL54LFFB_ _ with full modesty panel \$2418

200ERL72_ _ \$2330
 Executive height return (LH), file/file pedestal (locking), 1/2 support panel on connection end, one wire mgmt grommet, 56"W kneespace, 24" x 72" x 30"H (200 lbs)

200ERL72FB_ _ with full modesty panel \$2554

200ERL60_ _ \$2035
 Executive height return (LH), file/file pedestal (locking), one wire mgmt grommet, 32"W kneespace
 24" x 60" x 30"H (140 lbs)

200ERL60FB_ _ with full modesty panel \$2252

200ERL54_ _ \$1887
 Executive height return (LH), file/file pedestal (locking), one wire mgmt grommet, 32"W kneespace
 24" x 54" x 30"H (140 lbs)

200ERL54FB_ _ with full modesty panel \$2101

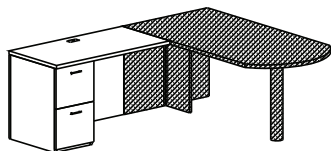

200ERL48_ _ \$1739
 Executive height return (LH), file/file pedestal (locking), one wire mgmt grommet, 32"W kneespace
 24" x 48" x 30"H (140 lbs)

200ERL48FB_ _ with full modesty panel \$1950



200ERL42_ _ \$1701
 Executive height return (LH), file/file pedestal (locking), one wire mgmt grommet, 26"W kneespace
 24" x 42" x 30"H (135 lbs)

200ERL42FB_ _ with full modesty panel \$1898



200ERL36_ _ \$1540
 Executive height return (LH), file/file pedestal (locking), one wire mgmt grommet, 20"W kneespace
 24" x 36" x 30"H (130 lbs)

200ERL36FB_ _ with full modesty panel \$1675

A LA CARTE SERIES

List Price

Executive Workstations - P-Top Desks

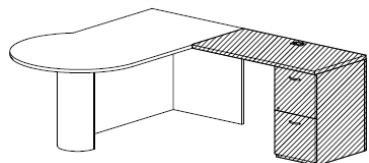

200WSP7236LFB_
P-top desk (LH), 42" diameter end, wood half cylinder base with full modesty 36" x 72" x 30"H (190 lbs)

\$3020

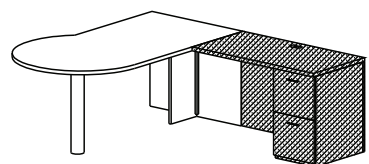

200WSP7236L_
P-top desk (LH), 42" diameter end, 4" diameter black metal base 36" x 72" x 30"H (170 lbs)

\$2301



Executive Workstations - Bullet Desks

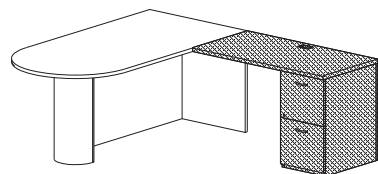

200WSB7236LFB_
Bullet desk (LH), 36" diameter end, wood half cylinder base with full modesty 36" x 72" x 30"H (200 lbs)

\$2755

200WSB7230LFB_
Bullet desk (LH), 30" diameter end, wood half cylinder base with full modesty 30" x 72" x 30"H (177 lbs)

\$2519

200WSB6630LFB_
Bullet desk (LH), 30" diameter end, wood half cylinder base with full modesty 30" x 66" x 30"H (150 lbs)

\$2146

200WSB7236_
Bullet desk, 36" diameter end, 4" diameter black metal base 36" x 72" x 30"H (165 lbs)

\$2017

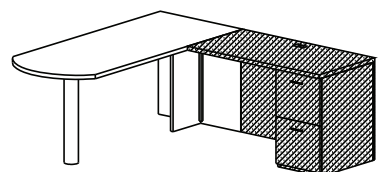

200WSB7230_
Bullet desk, 30" diameter end, 4" diameter black metal base 30" x 72" x 30"H (157 lbs)

\$1806



200WSB6630_
Bullet desk, 30" diameter end, 4" diameter black metal base 30" x 66" x 30"H (130 lbs)

\$1681

A LA CARTE SERIES

List Price

Executive Workstations - Executive Returns

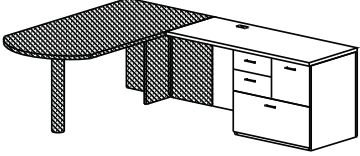
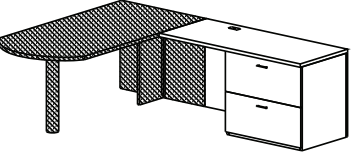
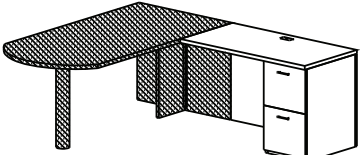
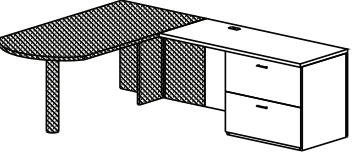
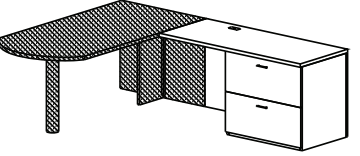
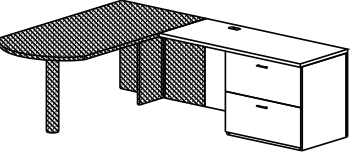
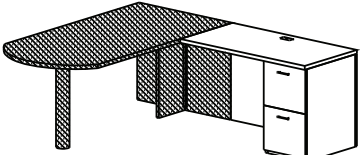
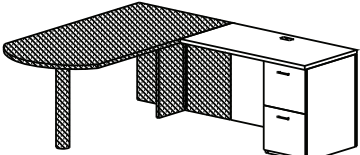
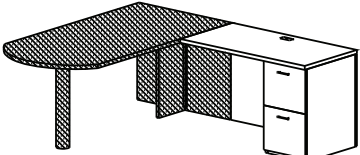
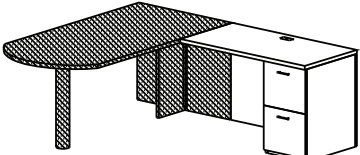
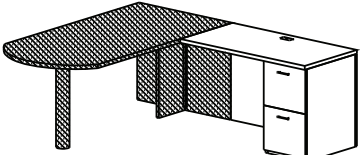
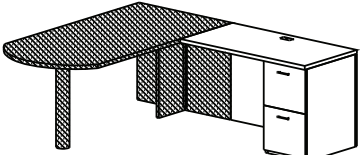
| | |
|---|---|
|  | 200ERR72FC__ \$2892 |
| | Executive height return (RH), file center pedestal (locking), two box, one file drawer top, one lateral file drawer bottom, one wire mgmt grommet, 40"W kneespace 24" x 72" x 30"H (235 lbs) |
| | 200ERR72FCFB__ with full modesty panel \$3115 |
|  | 200ERR60FC__ \$2672 |
| | Executive height return (RH), file center pedestal (locking), two box, one file drawer top, one lateral file drawer bottom, one wire mgmt grommet, 28"W kneespace 24" x 60" x 30"H (215 lbs) |
| | 200ERR60FCFB__ with full modesty panel \$2896 |
|  | 200ERR54FC__ \$2413 |
| | Executive height return (RH), file center pedestal (locking), two box, one file drawer top, one lateral file drawer bottom, one wire mgmt grommet, 22"W kneespace 24" x 54" x 30"H (205 lbs) |
| | 200ERR54FCFB__ with full modesty panel \$2637 |
|  | 200ERR72LF__ \$2580 |
| | Executive height return (RH), two lateral file drawers (locking), one wire mgmt grommet, 40"W kneespace 24" x 72" x 30"H (250 lbs) |
| | 200ERR72LFFB__ with full modesty panel \$2803 |
|  | 200ERR60LF__ \$2345 |
| | Executive height return (RH), two lateral file drawers (locking), one wire mgmt grommet, 28"W kneespace 24" x 60" x 30"H (225 lbs) |
| | 200ERR60LFFB__ with full modesty panel \$2568 |
|  | 200ERR54LF__ \$2190 |
| | Executive height return (RH), two lateral file drawers (locking), one wire mgmt grommet, 22"W kneespace 24" x 54" x 30"H (180 lbs) |
| | 200ERR54LFFB__ with full modesty panel \$2418 |
|  | 200ERR72__ \$2330 |
| | Executive height return (RH), file/file pedestal (locking), 1/2 support panel on connection end, one wire mgmt grommet, 56"W kneespace 24" x 72" x 30"H (200 lbs) |
| | 200ERR72FB__ with full modesty panel \$2554 |
|  | 200ERR60__ \$2035 |
| | Executive height return (RH), file/file pedestal (locking), one wire mgmt grommet, 32"W kneespace 24" x 60" x 30"H (140 lbs) |
| | 200ERR60FB__ with full modesty panel \$2252 |
|  | 200ERR54__ \$1887 |
| | Executive height return (RH), file/file pedestal (locking), one wire mgmt grommet, 32"W kneespace 24" x 54" x 30"H (140 lbs) |
| | 200ERR54FB__ with full modesty panel \$2101 |
|  | 200ERR48__ \$1739 |
| | Executive height return (RH), file/file pedestal (locking), one wire mgmt grommet, 32"W kneespace 24" x 48" x 30"H (140 lbs) |
| | 200ERR48FB__ with full modesty panel \$1950 |
|  | 200ERR42__ \$1701 |
| | Executive height return (RH), file/file pedestal (locking), one wire mgmt grommet, 26"W kneespace 24" x 42" x 30"H (135 lbs) |
| | 200ERR42FB__ with full modesty panel \$1898 |
|  | 200ERR36__ \$1540 |
| | Executive height return (RH), file/file pedestal (locking), one wire mgmt grommet, 20"W kneespace 24" x 36" x 30"H (130 lbs) |
| | 200ERR36FB__ with full modesty panel \$1675 |



A LA CARTE SERIES

List Price

Computer Desk U Workstations - Single Pedestal Desks

| | |
|--|--|
| | <p>200ECWSR7242SB_ _ \$3373 Executive single pedestal computer desk (RH) with fitted top, box/box/file pedestal (locking), 42" corner unit, two wire mgmt grommets in top, stepped modesty panel 30"- 42" x 72" x 30"H (325 lbs)</p> |
| | <p>200ECWSR7236SB_ _ \$3198 Executive single pedestal computer desk (RH) with fitted top, box/box/file pedestal (locking), 36" corner unit, two wire mgmt grommets in top, stepped modesty panel 24"- 36" x 72" x 30"H (285 lbs)</p> |
| | <p>200ECWSR6636SB_ _ \$3079 Executive single pedestal computer desk (RH) with fitted top, box/box/file pedestal (locking), 36" corner unit, two wire mgmt grommets in top, stepped modesty panel 24"- 36" x 66" x 30"H (260 lbs)</p> |
| | <p>200ECWSR7242FB_ _ \$3166 Executive single pedestal computer desk (RH) with conference top, box/box/file pedestal (locking), 42" corner unit, two wire mgmt grommets in top, recessed modesty panel 30"- 42" x 72" x 30"H (315 lbs)</p> |
| | <p>200ECWSR7236FB_ _ \$2988 Executive single pedestal computer desk (RH) with fitted top, box/box/file pedestal (locking), 36" corner unit, two wire mgmt grommets in top, flush modesty panel 24"- 36" x 72" x 30"H (275 lbs)</p> |
| | <p>200ECWSR6636FB_ _ \$2814 Executive single pedestal computer desk (RH) with fitted top, box/box/file pedestal (locking), 36" corner unit, two wire mgmt grommets in top, flush modesty panel 24"- 36" x 66" x 30"H (250 lbs)</p> |
| | <p>200ECWSP76R_ _ \$2625 Freestanding P-Top computer desk (RH), 36" diameter end, with 4" black pedestal leg, 42" corner unit, one wire mgmt grommet in top (left) 30"-42" x 76" x 30"H (195 lbs)</p> |
| | <p>200ECWSP76RFB_ _ \$3344 Freestanding P-Top computer desk (RH), 36" diameter end, with wood half cylinder base with full modesty panel, 42" corner unit, one wire mgmt grommet in top (left) 30"-42" x 76" x 30"H (235 lbs)</p> |
| | <p>200ECWSB76R_ _ \$2415 Freestanding bullet top computer desk (RH), 30" diameter end, with 4" black pedestal leg, 42" corner unit, one wire mgmt grommet in top (left) 30"-42" x 76" x 30"H (195 lbs)</p> |
| | <p>200ECWSB76RFB_ _ \$3128 Freestanding bullet top computer desk (RH), 30" diameter end, with wood half cylinder base with full modesty panel, 42" corner unit, one wire mgmt grommet in top (left) 30"-42" x 76" x 30"H (235 lbs)</p> |



A LA CARTE SERIES

List Price

Computer Desk U Workstations - Connecting Bridges

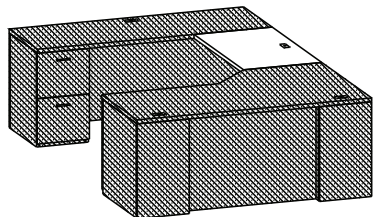

| | |
|---|--------------|
| 200WS54_ Executive height bridge, one computer grommet 24" x 54" x 30"H (83 lbs) | \$905 |
| 200WS48_ Executive height bridge, one computer grommet 24" x 48" x 30"H (78 lbs) | \$808 |
| 200WS42_ Executive height bridge, one computer grommet 24" x 42" x 30"H (73 lbs) | \$650 |
| 200WS36_ Executive height bridge, one computer grommet 24" x 36" x 30"H (68 lbs) | \$585 |



Computer Desk U Workstations - Single Pedestal Credenzas

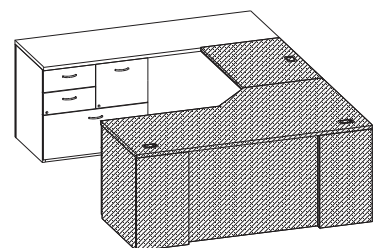

| | |
|--|---------------|
| 200DCSPL84FC_ _ Single pedestal credenza (LH), file center pedestal (locking), two box, one file drawer top, one lateral file drawer bottom, one wire mgmt grommet, 45"W kneespace 24" x 84" x 30"H (285 lbs) | \$3391 |
| 200DCSPL72FC_ _ Single pedestal credenza (LH), file center pedestal (locking), two box, one file drawer top, one lateral file drawer bottom, one wire mgmt grommet, 39"W kneespace 24" x 72" x 30"H (220 lbs) | \$3213 |
| 200DCSPL66FC_ _ Single pedestal credenza (LH), file center pedestal (locking), two box, one file drawer top, one lateral file drawer bottom, one wire mgmt grommet, 33"W kneespace 24" x 66" x 30"H (205 lbs) | \$3164 |

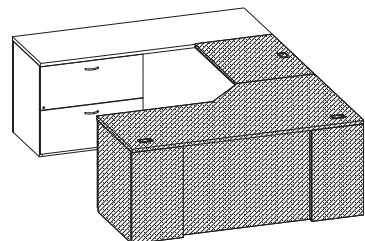

| | |
|--|---------------|
| 200DCSPL84LF_ _ Single pedestal credenza (LH), two lateral file drawers (locking), legal or letter filing, one wire mgmt grommet in back panel, 45"W kneespace 24" x 84" x 30"H (260 lbs) | \$3048 |
| 200DCSPL72LF_ _ Single pedestal credenza (LH), two lateral file drawers (locking), legal or letter filing, one wire mgmt grommet in back panel, 39"W kneespace 24" x 72" x 30"H (230 lbs) | \$2893 |
| 200DCSPL66LF_ _ Single pedestal credenza (LH), two lateral file drawers (locking), legal or letter filing, one wire mgmt grommet in back panel, 33"W kneespace 24" x 66" x 30"H (215 lbs) | \$2836 |

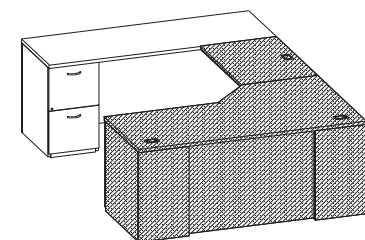

| | |
|--|---------------|
| 200DCSPL72_ _ Single pedestal credenza (LH), file/file pedestal (locking), one wire mgmt grommet in back panel, 55"W kneespace 24" x 72" x 30"H (220 lbs) | \$2625 |
| 200DCSPL66_ _ Single pedestal credenza (LH), file/file pedestal (locking), one wire mgmt grommet in back panel, 49"W kneespace 24" x 66" x 30"H (210 lbs) | \$2566 |
| 200DCSPL60_ _ Single pedestal credenza (LH), file/file pedestal (locking), one wire mgmt grommet in back panel, 43"W kneespace 24" x 60" x 30"H (195 lbs) | \$2405 |



A LA CARTE SERIES

List Price

Computer Desk U Workstations - Single Pedestal Desks

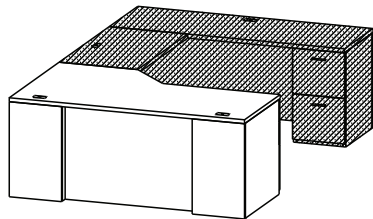

200ECWSL7242SB_ _ \$3373
 Executive single pedestal computer desk (LH) with fitted top, box/box/file pedestal (locking), 42" corner unit, two wire mgmt grommets in top, stepped modesty panel
 30"- 42" x 72" x 30"H (325 lbs)

200ECWSL7236SB_ _ \$3198
 Executive single pedestal computer desk (LH) with fitted top, box/box/file pedestal (locking), 36" corner unit, two wire mgmt grommets in top, stepped modesty panel
 24"- 36" x 72" x 30"H (285 lbs)

200ECWSL6636SB_ _ \$3079
 Executive single pedestal computer desk (LH) with fitted top, box/box/file pedestal (locking), 36" corner unit, two wire mgmt grommets in top, stepped modesty panel
 24"- 36" x 66" x 30"H (260 lbs)

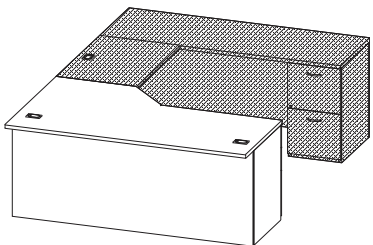

200ECWSL7242FB_ _ \$3166
 Executive single pedestal computer desk (LH) with conference top, box/box/file pedestal (locking), 42" corner unit, two wire mgmt grommets in top, recessed modesty panel
 30"- 42" x 72" x 30"H (315 lbs)



200ECWSL7236FB_ _ \$2988
 Executive single pedestal computer desk (LH) with fitted top, box/box/file pedestal (locking), 36" corner unit, two wire mgmt grommets in top, flush modesty panel
 24"- 36" x 72" x 30"H (275 lbs)

200ECWSL6636FB_ _ \$2814
 Executive single pedestal computer desk (LH) with fitted top, box/box/file pedestal (locking), 36" corner unit, two wire mgmt grommets in top, flush modesty panel
 24"- 36" x 66" x 30"H (250 lbs)

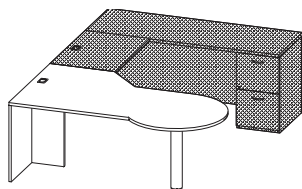

200ECWSP76L_ \$2625
 Freestanding P-Top computer desk (LH), 36" diameter end, with 4" black pedestal leg, 42" corner unit, one wire mgmt grommet in top (right)
 30"-42" x 76" x 30"H (195 lbs)

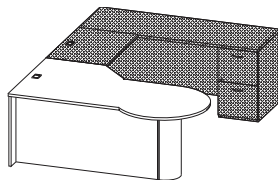

200ECWSP76LFB_ \$3344
 Freestanding P-Top computer desk (LH), 36" diameter end, with wood half cylinder base with full modesty panel, 42" corner unit, one wire mgmt grommet in top (right)
 30"-42" x 76" x 30"H (235 lbs)

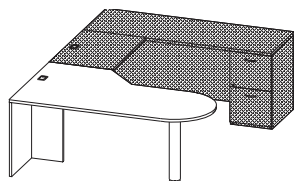

200ECWSB76L_ \$2415
 Freestanding bullet top computer desk (LH), 30" diameter end, with 4" black pedestal leg, 42" corner unit, one wire mgmt grommet in top (right)
 30"-42" x 76" x 30"H (195 lbs)

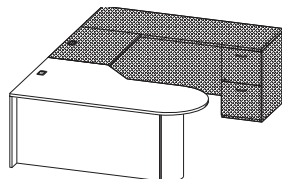

200ECWSB76LFB_ \$3128
 Freestanding bullet top computer desk (LH), 30" diameter end, with wood half cylinder base with full modesty panel, 42" corner unit, one wire mgmt grommet in top (right)
 30"-42" x 76" x 30"H (235 lbs)

A LA CARTE SERIES

List Price

Computer Desk U Workstations - Connecting Bridges

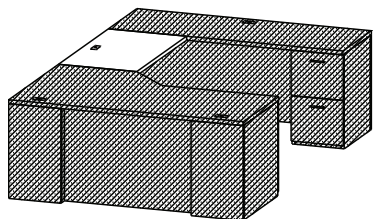

| | |
|---|--------------|
| 200WS54_ Executive height bridge, one computer grommet 24" x 54" x 30"H (83 lbs) | \$905 |
| 200WS48_ Executive height bridge, one computer grommet 24" x 48" x 30"H (78 lbs) | \$808 |
| 200WS42_ Executive height bridge, one computer grommet 24" x 42" x 30"H (73 lbs) | \$650 |
| 200WS36_ Executive height bridge, one computer grommet 24" x 36" x 30"H (68 lbs) | \$585 |



Computer Desk U Workstations - Single Pedestal Credenzas

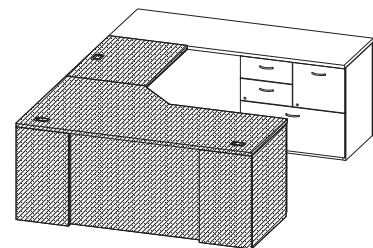

| | |
|--|---------------|
| 200DCSPR84FC_ _ Single pedestal credenza (RH), file center pedestal (locking), two box, one file drawer top, one lateral file drawer bottom, one wire mgmt grommet, 45"W kneespace 24" x 84" x 30"H (285 lbs) | \$3391 |
| 200DCSPR72FC_ _ Single pedestal credenza (RH), file center pedestal (locking), two box, one file drawer top, one lateral file drawer bottom, one wire mgmt grommet, 39"W kneespace 24" x 72" x 30"H (220 lbs) | \$3213 |
| 200DCSPR66FC_ _ Single pedestal credenza (RH), file center pedestal (locking), two box, one file drawer top, one lateral file drawer bottom, one wire mgmt grommet, 33"W kneespace 24" x 66" x 30"H (205 lbs) | \$3164 |

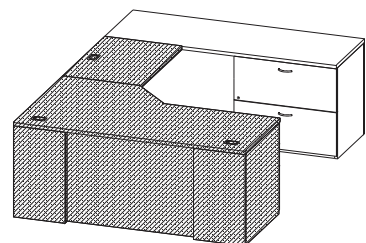

| | |
|--|---------------|
| 200DCSPR84LF_ _ Single pedestal credenza (RH), two lateral file drawers (locking), legal or letter filing, one wire mgmt grommet in back panel, 45"W kneespace 24" x 84" x 30"H (260 lbs) | \$3048 |
| 200DCSPR72LF_ _ Single pedestal credenza (RH), two lateral file drawers (locking), legal or letter filing, one wire mgmt grommet in back panel, 39"W kneespace 24" x 72" x 30"H (230 lbs) | \$2893 |
| 200DCSPR66LF_ _ Single pedestal credenza (RH), two lateral file drawers (locking), legal or letter filing, one wire mgmt grommet in back panel, 33"W kneespace 24" x 66" x 30"H (215 lbs) | \$2836 |

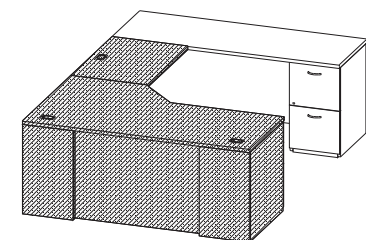

| | |
|--|---------------|
| 200DCSPR72_ _ Single pedestal credenza (RH), file/file pedestal (locking), one wire mgmt grommet in back panel, 55"W kneespace 24" x 72" x 30"H (220 lbs) | \$2625 |
| 200DCSPR66_ _ Single pedestal credenza (RH), file/file pedestal (locking), one wire mgmt grommet in back panel, 49"W kneespace 24" x 66" x 30"H (210 lbs) | \$2566 |
| 200DCSPR60_ _ Single pedestal credenza (RH), file/file pedestal (locking), one wire mgmt grommet in back panel, 43"W kneespace 24" x 60" x 30"H (195 lbs) | \$2405 |



A LA CARTE SERIES

List Price

Executive Desk U Workstations - Single Pedestal Desks - Stepped Modesty Panel

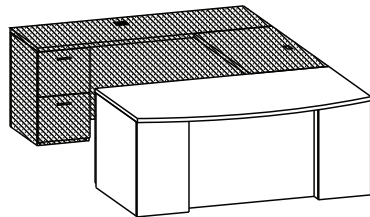

200KSPR8442SB__ \$3942

Executive single pedestal desk (RH) with arc conference top, box/box/file pedestal (locking), 10" center overhang, stepped modesty panel
42" x 84" x 30"H (350 lbs)

200KSPR7242SB__ \$3599

Executive single pedestal desk (RH) with arc conference top, box/box/file pedestal (locking), 10" center overhang, stepped modesty panel
42" x 72" x 30"H (335 lbs)

200KSPR7236SB__ \$3311

Executive single pedestal desk (RH) with arc conference top, box/box/file pedestal (locking), 10" center overhang, stepped modesty panel
36" x 72" x 30"H (305 lbs)

200SPR8442SB__ \$3646

Executive single pedestal desk (RH), box/box/file pedestal (locking), 4" center overhang, stepped modesty panel
42" x 84" x 30"H (330 lbs)

200SPR7236SB__ \$3374

Executive single pedestal desk (RH), box/box/file pedestal (locking), 4" center overhang, stepped modesty panel
36" x 72" x 30"H (310 lbs)

200SPR7230SB__ \$3132

Executive single pedestal desk (RH), box/box/file pedestal (locking), 4" center overhang, stepped modesty panel
30" x 72" x 30"H (280 lbs)

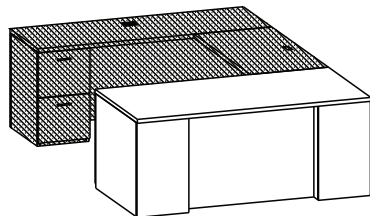

200SPR6636SB__ \$3287

Executive single pedestal desk (RH), box/box/file pedestal (locking), 4" center overhang, stepped modesty panel
36" x 66" x 30"H (305 lbs)

200SPR6630SB__ \$3027

Executive single pedestal desk (RH), box/box/file pedestal (locking), 4" center overhang, stepped modesty panel
30" x 66" x 30"H (295 lbs)

200SPR6030SB__ \$2902

Executive single pedestal desk (RH), box/box/file pedestal (locking), 4" center overhang, stepped modesty panel
10" w pedestal accommodates side-to-side letter or legal filing only.
200SPR6030SB-FS If freestanding option is specified, pedestal will be letter width. 30" x 60" x 30"H (275 lbs)

A LA CARTE SERIES

List Price

Executive Desk U Workstations - Connecting Bridges

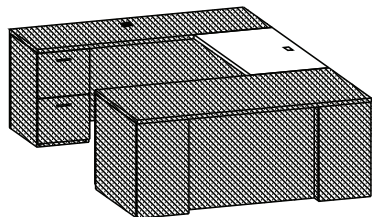

| | |
|---|--------------|
| 200WS54_ Executive height bridge, one computer grommet 24" x 54" x 30"H (83 lbs) | \$905 |
| 200WS48_ Executive height bridge, one computer grommet 24" x 48" x 30"H (78 lbs) | \$808 |
| 200WS42_ Executive height bridge, one computer grommet 24" x 42" x 30"H (73 lbs) | \$650 |
| 200WS36_ Executive height bridge, one computer grommet 24" x 36" x 30"H (68 lbs) | \$585 |



Executive Desk U Workstations - Single Pedestal Credenzas

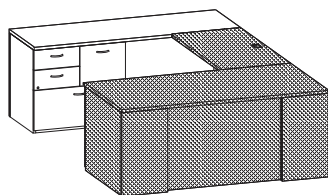

| | |
|--|---------------|
| 200DCSPL84FC_ _ Single pedestal credenza (LH), file center pedestal (locking), two box, one file drawer top, one lateral file drawer bottom, one wire mgmt grommet, 45"W kneespace 24" x 84" x 30"H (310 lbs) | \$3391 |
| 200DCSPL72FC_ _ Single pedestal credenza (LH), file center pedestal (locking), two box, one file drawer top, one lateral file drawer bottom, one wire mgmt grommet, 39"W kneespace 24" x 72" x 30"H (220 lbs) | \$3213 |
| 200DCSPL66FC_ _ Single pedestal credenza (LH), file center pedestal (locking), two box, one file drawer top, one lateral file drawer bottom, one wire mgmt grommet, 33"W kneespace 24" x 66" x 30"H (205 lbs) | \$3164 |

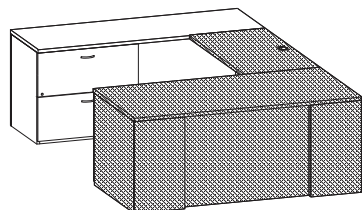

| | |
|--|---------------|
| 200DCSPL84LF_ _ Single pedestal credenza (LH), two lateral file drawers (locking), legal or letter filing, one wire mgmt grommet in back panel, 45"W kneespace 24" x 84" x 30"H (260 lbs) | \$3048 |
| 200DCSPL72LF_ _ Single pedestal credenza (LH), two lateral file drawers (locking), legal or letter filing, one wire mgmt grommet in back panel, 39"W kneespace 24" x 72" x 30"H (230 lbs) | \$2893 |
| 200DCSPL66LF_ _ Single pedestal credenza (LH), two lateral file drawers (locking), legal or letter filing, one wire mgmt grommet in back panel, 33"W kneespace 24" x 66" x 30"H (215 lbs) | \$2836 |

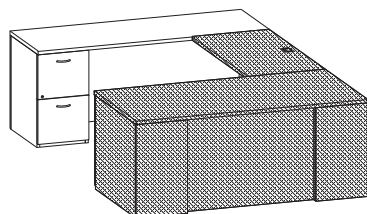

| | |
|--|---------------|
| 200DCSPL72_ _ Single pedestal credenza (LH), file/file pedestal (locking), one wire mgmt grommet in back panel, 55"W kneespace 24" x 72" x 30"H (220 lbs) | \$2625 |
| 200DCSPL66_ _ Single pedestal credenza (LH), file/file pedestal (locking), one wire mgmt grommet in back panel, 49"W kneespace 24" x 66" x 30"H (210 lbs) | \$2566 |
| 200DCSPL60_ _ Single pedestal credenza (LH), file/file pedestal (locking), one wire mgmt grommet in back panel, 43"W kneespace 24" x 60" x 30"H (195 lbs) | \$2405 |



A LA CARTE SERIES

List Price

Executive Desk U Workstations - Single Pedestal Desks - Stepped Modesty Panel

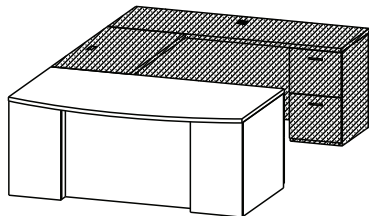

200KSPL8442SB_ _ **\$3942**
 Executive single pedestal desk (LH) with arc conference top, box/box/file pedestal (locking),
 10" center overhang, stepped modesty panel
 42" x 84" x 30"H (350 lbs)

200KSPL7242SB_ _ **\$3599**
 Executive single pedestal desk (LH) with arc conference top, box/box/file pedestal (locking),
 10" center overhang, stepped modesty panel
 42" x 72" x 30"H (335 lbs)

200KSPL7236SB_ _ **\$3311**
 Executive single pedestal desk (LH) with arc conference top, box/box/file pedestal (locking),
 10" center overhang, stepped modesty panel
 36" x 72" x 30"H (305 lbs)

200SPL8442SB_ _ **\$3646**
 Executive single pedestal desk (LH), box/box/file pedestal (locking),
 4" center overhang, stepped modesty panel
 42" x 84" x 30"H (330 lbs)

200SPL7236SB_ _ **\$3374**
 Executive single pedestal desk (LH), box/box/file pedestal (locking),
 4" center overhang, stepped modesty panel
 36" x 72" x 30"H (300 lbs)

200SPL7230SB_ _ **\$3132**
 Executive single pedestal desk (LH), box/box/file pedestal (locking),
 4" center overhang, stepped modesty panel
 30" x 72" x 30"H (280 lbs)

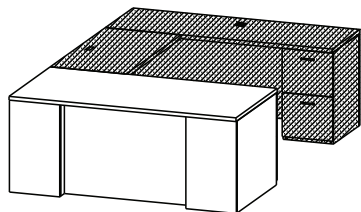

200SPL6636SB_ _ **\$3287**
 Executive single pedestal desk (LH), box/box/file pedestal (locking),
 4" center overhang, stepped modesty panel
 36" x 66" x 30"H (305 lbs)

200SPL6630SB_ _ **\$3027**
 Executive single pedestal desk (LH), box/box/file pedestal (locking),
 4" center overhang, stepped modesty panel
 30" x 66" x 30"H (295 lbs)

200SPL6030SB_ _ **\$2902**
 Executive single pedestal desk (LH), box/box/file pedestal (locking),
 4" center overhang, stepped modesty panel
 10" w pedestal accommodates side-to-side letter or legal filing only.
200SPL6030SB-FS If freestanding option is specified, pedestal
 will be letter width. 30" x 60" x 30"H (275 lbs)

A LA CARTE SERIES

List Price

Executive Desk U Workstations - Connecting Bridges

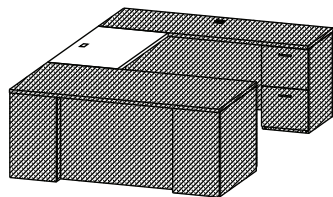

| | |
|---|--------------|
| 200WS54_ Executive height bridge, one computer grommet 24" x 54" x 30"H (83 lbs) | \$905 |
| 200WS48_ Executive height bridge, one computer grommet 24" x 48" x 30"H (78 lbs) | \$808 |
| 200WS42_ Executive height bridge, one computer grommet 24" x 42" x 30"H (73 lbs) | \$650 |
| 200WS36_ Executive height bridge, one computer grommet 24" x 36" x 30"H (68 lbs) | \$585 |



Executive Desk U Workstations - Single Pedestal Credenzas

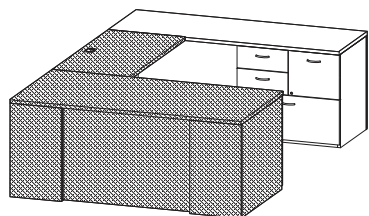

| | |
|--|---------------|
| 200DCSPR84FC_ _ Single pedestal credenza (RH), file center pedestal (locking), two box, one file drawer top, one lateral file drawer bottom, one wire mgmt grommet, 45"W kneespace 24" x 84" x 30"H (310 lbs) | \$3391 |
| 200DCSPR72FC_ _ Single pedestal credenza (RH), file center pedestal (locking), two box, one file drawer top, one lateral file drawer bottom, one wire mgmt grommet, 39"W kneespace 24" x 72" x 30"H (220 lbs) | \$3213 |
| 200DCSPR66FC_ _ Single pedestal credenza (RH), file center pedestal (locking), two box, one file drawer top, one lateral file drawer bottom, one wire mgmt grommet, 33"W kneespace 24" x 66" x 30"H (205 lbs) | \$3164 |

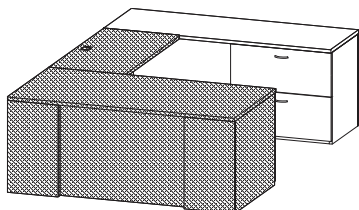

| | |
|--|---------------|
| 200DCSPR84LF_ _ Single pedestal credenza (RH), two lateral file drawers (locking), legal or letter filing, one wire mgmt grommet in back panel, 45"W kneespace 24" x 84" x 30"H (260 lbs) | \$3048 |
| 200DCSPR72LF_ _ Single pedestal credenza (RH), two lateral file drawers (locking), legal or letter filing, one wire mgmt grommet in back panel, 39"W kneespace 24" x 72" x 30"H (230 lbs) | \$2893 |
| 200DCSPR66LF_ _ Single pedestal credenza (RH), two lateral file drawers (locking), legal or letter filing, one wire mgmt grommet in back panel, 33"W kneespace 24" x 66" x 30"H (215 lbs) | \$2836 |

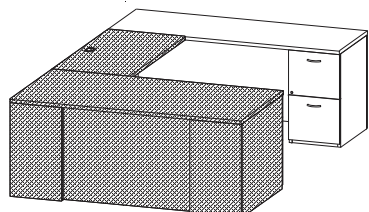

| | |
|--|---------------|
| 200DCSPR72_ _ Single pedestal credenza (RH), file/file pedestal (locking), one wire mgmt grommet in back panel, 55"W kneespace 24" x 72" x 30"H (220 lbs) | \$2625 |
| 200DCSPR66_ _ Single pedestal credenza (RH), file/file pedestal (locking), one wire mgmt grommet in back panel, 49"W kneespace 24" x 66" x 30"H (210 lbs) | \$2566 |
| 200DCSPR60_ _ Single pedestal credenza (RH), file/file pedestal (locking), one wire mgmt grommet in back panel, 43"W kneespace 24" x 60" x 30"H (195 lbs) | \$2405 |



A LA CARTE SERIES

List Price

Executive Desk U Workstations - Single Pedestal Desks - Recessed Modesty Panel

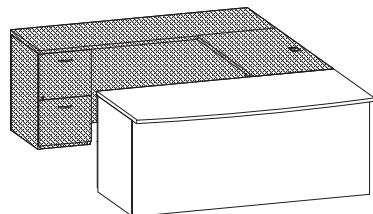

200KSPR8442FB_ _ **\$3620**
 Executive single pedestal desk (RH) with arc conference top, box/box/file pedestal (locking),
 6" center overhang, recessed modesty panel
 42" x 84" x 30"H (350 lbs)

200KSPR7242FB_ _ **\$3331**
 Executive single pedestal desk (RH) with arc conference top, box/box/file pedestal (locking),
 6" center overhang, recessed modesty panel
 42" x 72" x 30"H (335 lbs)

200KSPR7236FB_ _ **\$3045**
 Executive single pedestal desk (RH) with arc conference top, box/box/file pedestal (locking),
 6" center overhang, recessed modesty panel
 36" x 72" x 30"H (305 lbs)

200SPR8442FB_ _ **\$3401**
 Executive single pedestal desk (RH), box/box/file pedestal (locking),
 6" overhang, recessed modesty panel
 42" x 84" x 30"H (340 lbs)

200SPR7236FB_ _ **\$3038**
 Executive single pedestal desk (RH), box/box/file pedestal (locking),
 6" overhang, recessed modesty panel
 36" x 72" x 30"H (310 lbs)



200SPR7230FB_ _ **\$2747**
 Executive single pedestal desk (RH), box/box/file pedestal (locking),
 6" overhang, recessed modesty panel
 30" x 72" x 30"H (280 lbs)

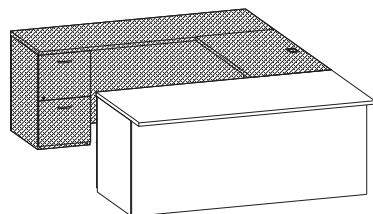

200SPR6636FB_ _ **\$2944**
 Executive single pedestal desk (RH), box/box/file pedestal (locking),
 6" overhang, recessed modesty panel
 36" x 66" x 30"H (300 lbs)

200SPR6630FB_ _ **\$2628**
 Executive single pedestal desk (RH), box/box/file pedestal (locking),
 6" overhang, recessed modesty panel
 30" x 66" x 30"H (295 lbs)



200SPR6030FB_ _ **\$2398**
 Executive single pedestal desk (RH), box/box/file pedestal (locking),
 6" overhang, recessed modesty panel
 10" w pedestal accommodates side-to-side letter or legal filing only.
200SPR6030FB-FS If freestanding option is specified, pedestal
 will be letter width. 30" x 60" x 30"H (275 lbs)

A LA CARTE SERIES

List Price

Executive Desk U Workstations - Connecting Bridges

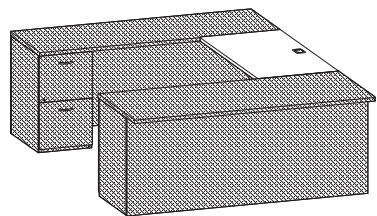

| | |
|---|--------------|
| 200WS54_ Executive height bridge, one computer grommet 24" x 54" x 30"H (83 lbs) | \$905 |
| 200WS48_ Executive height bridge, one computer grommet 24" x 48" x 30"H (78 lbs) | \$808 |
| 200WS42_ Executive height bridge, one computer grommet 24" x 42" x 30"H (73 lbs) | \$650 |
| 200WS36_ Executive height bridge, one computer grommet 24" x 36" x 30"H (68 lbs) | \$585 |



Executive Desk U Workstations - Single Pedestal Credenzas

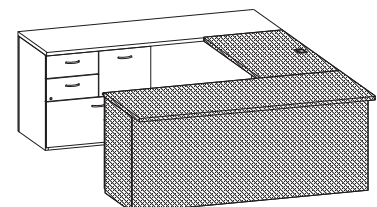

| | |
|--|---------------|
| 200DCSPL84FC_ _ Single pedestal credenza (LH), file center pedestal (locking), two box, one file drawer top, one lateral file drawer bottom, one wire mgmt grommet, 45"W kneespace 24" x 84" x 30"H (285 lbs) | \$3391 |
| 200DCSPL72FC_ _ Single pedestal credenza (LH), file center pedestal (locking), two box, one file drawer top, one lateral file drawer bottom, one wire mgmt grommet, 39"W kneespace 24" x 72" x 30"H (220 lbs) | \$3213 |
| 200DCSPL66FC_ _ Single pedestal credenza (LH), file center pedestal (locking), two box, one file drawer top, one lateral file drawer bottom, one wire mgmt grommet, 33"W kneespace 24" x 66" x 30"H (205 lbs) | \$3164 |

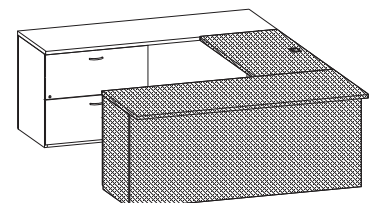

| | |
|--|---------------|
| 200DCSPL84LF_ _ Single pedestal credenza (LH), two lateral file drawers (locking), legal or letter filing, one wire mgmt grommet in back panel, 45"W kneespace 24" x 84" x 30"H (260 lbs) | \$3048 |
| 200DCSPL72LF_ _ Single pedestal credenza (LH), two lateral file drawers (locking), legal or letter filing, one wire mgmt grommet in back panel, 39"W kneespace 24" x 72" x 30"H (230 lbs) | \$2893 |
| 200DCSPL66LF_ _ Single pedestal credenza (LH), two lateral file drawers (locking), legal or letter filing, one wire mgmt grommet in back panel, 33"W kneespace 24" x 66" x 30"H (215 lbs) | \$2836 |

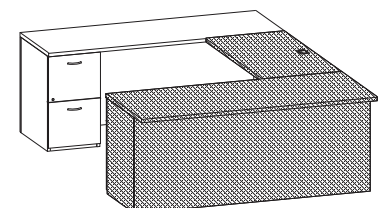

| | |
|--|---------------|
| 200DCSPL72_ _ Single pedestal credenza (LH), file/file pedestal (locking), one wire mgmt grommet in back panel, 55"W kneespace 24" x 72" x 30"H (220 lbs) | \$2625 |
| 200DCSPL66_ _ Single pedestal credenza (LH), file/file pedestal (locking), one wire mgmt grommet in back panel, 49"W kneespace 24" x 66" x 30"H (210 lbs) | \$2566 |
| 200DCSPL60_ _ Single pedestal credenza (LH), file/file pedestal (locking), one wire mgmt grommet in back panel, 43"W kneespace 24" x 60" x 30"H (195 lbs) | \$2405 |



A LA CARTE SERIES

List Price

Executive Desk U Workstations - Single Pedestal Desks - Recessed Modesty Panel

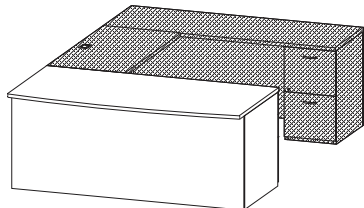

200KSPL8442FB_ _ **\$3620**
 Executive single pedestal desk (LH) with arc conference top, box/box/file pedestal (locking),
 6" center overhang, recessed modesty panel
 42" x 84" x 30"H (350 lbs)

200KSPL7242FB_ _ **\$3331**
 Executive single pedestal desk (LH) with arc conference top, box/box/file pedestal (locking),
 6" center overhang, recessed modesty panel
 42" x 72" x 30"H (335 lbs)

200KSPL7236FB_ _ **\$3045**
 Executive single pedestal desk (LH) with arc conference top, box/box/file pedestal (locking),
 6" center overhang, recessed modesty panel
 36" x 72" x 30"H (305 lbs)

200SPL8442FB_ _ **\$3401**
 Executive single pedestal desk (LH), box/box/file pedestal (locking),
 6" overhang, recessed modesty panel
 42" x 84" x 30"H (350 lbs)

200SPL7236FB_ _ **\$3038**
 Executive single pedestal desk (LH), box/box/file pedestal (locking),
 6" overhang, recessed modesty panel
 36" x 72" x 30"H (330 lbs)

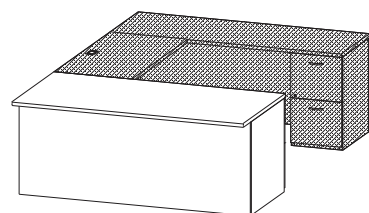

200SPL7230FB_ _ **\$2747**
 Executive single pedestal desk (LH), box/box/file pedestal (locking),
 6" overhang, recessed modesty panel
 30" x 72" x 30"H (300 lbs)



200SPL6636FB_ _ **\$2944**
 Executive single pedestal desk (LH), box/box/file pedestal (locking),
 6" overhang, recessed modesty panel
 36" x 66" x 30"H (290 lbs)

200SPL6630FB_ _ **\$2628**
 Executive single pedestal desk (LH), box/box/file pedestal (locking),
 6" overhang, recessed modesty panel
 30" x 66" x 30"H (275 lbs)



200SPL6030FB_ _ **\$2398**
 Executive single pedestal desk (LH), box/box/file pedestal (locking),
 6" overhang, recessed modesty panel
 10" w pedestal accommodates side-to-side letter or legal filing only.
200SPL6030FB-FS If freestanding option is specified, pedestal
 will be letter width. 30" x 60" x 30"H (250 lbs)

A LA CARTE SERIES

List Price

Executive Desk U Workstations - Connecting Bridges

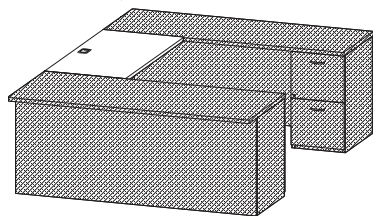

| | |
|---|--------------|
| 200WS54_ Executive height bridge, one computer grommet 24" x 54" x 30"H (83 lbs) | \$905 |
| 200WS48_ Executive height bridge, one computer grommet 24" x 48" x 30"H (78 lbs) | \$808 |
| 200WS42_ Executive height bridge, one computer grommet 24" x 42" x 30"H (73 lbs) | \$650 |
| 200WS36_ Executive height bridge, one computer grommet 24" x 36" x 30"H (68 lbs) | \$585 |



Executive Desk U Workstations - Single Pedestal Credenzas

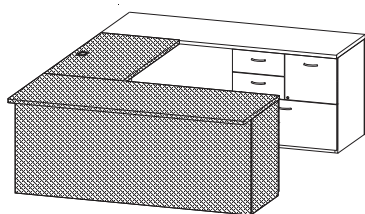

| | |
|--|---------------|
| 200DCSPR84FC_ _ Single pedestal credenza (RH), file center pedestal (locking), two box, one file drawer top, one lateral file drawer bottom, one wire mgmt grommet, 45"W kneespace 24" x 84" x 30"H (260 lbs) | \$3391 |
| 200DCSPR72FC_ _ Single pedestal credenza (RH), file center pedestal (locking), two box, one file drawer top, one lateral file drawer bottom, one wire mgmt grommet, 39"W kneespace 24" x 72" x 30"H (220 lbs) | \$3213 |
| 200DCSPR66FC_ _ Single pedestal credenza (RH), file center pedestal (locking), two box, one file drawer top, one lateral file drawer bottom, one wire mgmt grommet, 33"W kneespace 24" x 66" x 30"H (205 lbs) | \$3164 |

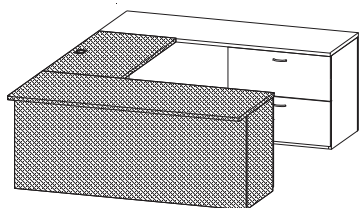

| | |
|--|---------------|
| 200DCSPR84LF_ _ Single pedestal credenza (RH), two lateral file drawers (locking), legal or letter filing, one wire mgmt grommet in back panel, 45"W kneespace 24" x 84" x 30"H (260 lbs) | \$3048 |
| 200DCSPR72LF_ _ Single pedestal credenza (RH), two lateral file drawers (locking), legal or letter filing, one wire mgmt grommet in back panel, 39"W kneespace 24" x 72" x 30"H (230 lbs) | \$2893 |
| 200DCSPR66LF_ _ Single pedestal credenza (RH), two lateral file drawers (locking), legal or letter filing, one wire mgmt grommet in back panel, 33"W kneespace 24" x 66" x 30"H (215 lbs) | \$2836 |

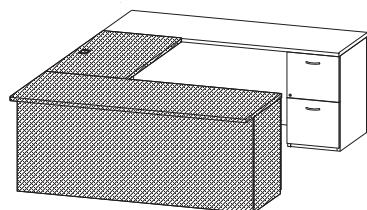

| | |
|--|---------------|
| 200DCSPR72_ _ Single pedestal credenza (RH), file/file pedestal (locking), one wire mgmt grommet in back panel, 55"W kneespace 24" x 72" x 30"H (220 lbs) | \$2625 |
| 200DCSPR66_ _ Single pedestal credenza (RH), file/file pedestal (locking), one wire mgmt grommet in back panel, 49"W kneespace 24" x 66" x 30"H (210 lbs) | \$2566 |
| 200DCSPR60_ _ Single pedestal credenza (RH), file/file pedestal (locking), one wire mgmt grommet in back panel, 43"W kneespace 24" x 60" x 30"H (195 lbs) | \$2405 |



A LA CARTE SERIES

List Price

Executive Desk U Workstations - P-Top Desks

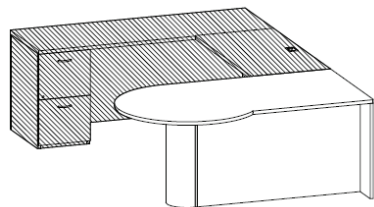

200WSP7236RFB_ **\$3020**
 P-top desk (RH), 42" diameter end, wood half cylinder base with full modesty 36" x 72" x 30"H (190 lbs)

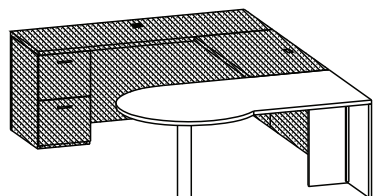

200WSP7236R_ **\$2301**
 P-top desk (RH), 42" diameter end, 4" diameter black metal base 36" x 72" x 30"H (170 lbs)



Executive Desk U Workstations - Bullet Desks

200WSB7236RFB_ **\$2755**
 Bullet desk (RH), 36" diameter end, wood half cylinder base with full modesty 36" x 72" x 30"H (200 lbs)

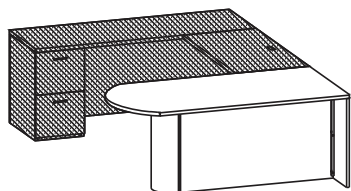

200WSB7230RFB_ **\$2519**
 Bullet desk (RH), 30" diameter end, wood half cylinder base with full modesty 30" x 72" x 30"H (177 lbs)

200WSB6630RFB_ **\$2146**
 Bullet desk (RH), 30" diameter end, wood half cylinder base with full modesty 30" x 66" x 30"H (150 lbs)

200WSB7236_ **\$2017**
 Bullet desk, 36" diameter end, 4" diameter black metal base 36" x 72" x 30"H (165 lbs)

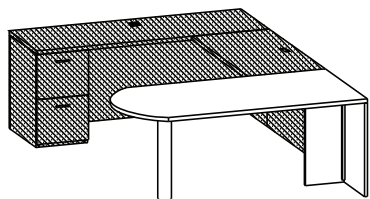

200WSB7230_ **\$1806**
 Bullet desk, 30" diameter end, 4" diameter black metal base 30" x 72" x 30"H (157 lbs)

200WSB6630_ **\$1681**
 Bullet desk, 30" diameter end, 4" diameter black metal base 30" x 66" x 30"H (130 lbs)

A LA CARTE SERIES

List Price

Executive Desk U Workstations - Connecting Bridges

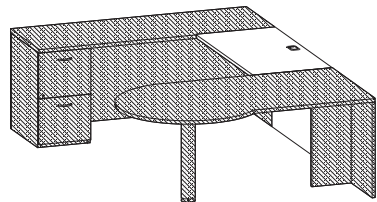

| | |
|---|--------------|
| 200WS54_ Executive height bridge, one computer grommet 24" x 54" x 30"H (83 lbs) | \$905 |
| 200WS48_ Executive height bridge, one computer grommet 24" x 48" x 30"H (78 lbs) | \$808 |
| 200WS42_ Executive height bridge, one computer grommet 24" x 42" x 30"H (73 lbs) | \$650 |
| 200WS36_ Executive height bridge, one computer grommet 24" x 36" x 30"H (68 lbs) | \$585 |



Executive Desk U Workstations - Single Pedestal Credenzas

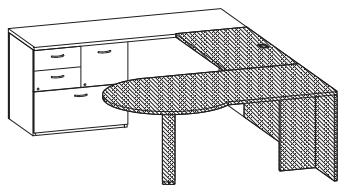

| | |
|--|---------------|
| 200DCSPL84FC_ _ Single pedestal credenza (LH), file center pedestal (locking), two box, one file drawer top, one lateral file drawer bottom, one wire mgmt grommet, 45"W kneespace 24" x 84" x 30"H (310 lbs) | \$3391 |
| 200DCSPL72FC_ _ Single pedestal credenza (LH), file center pedestal (locking), two box, one file drawer top, one lateral file drawer bottom, one wire mgmt grommet, 39"W kneespace 24" x 72" x 30"H (220 lbs) | \$3213 |
| 200DCSPL66FC_ _ Single pedestal credenza (LH), file center pedestal (locking), two box, one file drawer top, one lateral file drawer bottom, one wire mgmt grommet, 33"W kneespace 24" x 66" x 30"H (205 lbs) | \$3146 |

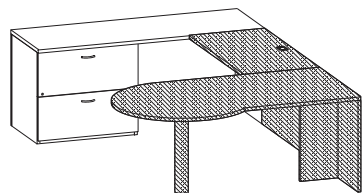

| | |
|--|---------------|
| 200DCSPL84LF_ _ Single pedestal credenza (LH), two lateral file drawers (locking), legal or letter filing, one wire mgmt grommet in back panel, 45"W kneespace 24" x 84" x 30"H (260 lbs) | \$3048 |
| 200DCSPL72LF_ _ Single pedestal credenza (LH), two lateral file drawers (locking), legal or letter filing, one wire mgmt grommet in back panel, 39"W kneespace 24" x 72" x 30"H (230 lbs) | \$2893 |
| 200DCSPL66LF_ _ Single pedestal credenza (LH), two lateral file drawers (locking), legal or letter filing, one wire mgmt grommet in back panel, 33"W kneespace 24" x 66" x 30"H (215 lbs) | \$2836 |

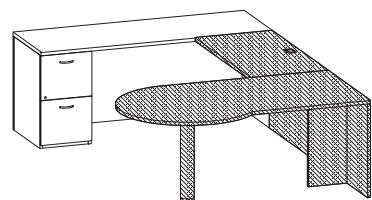

| | |
|--|---------------|
| 200DCSPL72_ _ Single pedestal credenza (LH), file/file pedestal (locking), one wire mgmt grommet in back panel, 55"W kneespace 24" x 72" x 30"H (220 lbs) | \$2625 |
| 200DCSPL66_ _ Single pedestal credenza (LH), file/file pedestal (locking), one wire mgmt grommet in back panel, 49"W kneespace 24" x 66" x 30"H (210 lbs) | \$2566 |
| 200DCSPL60_ _ Single pedestal credenza (LH), file/file pedestal (locking), one wire mgmt grommet in back panel, 43"W kneespace 24" x 60" x 30"H (195 lbs) | \$2405 |



A LA CARTE SERIES

List Price

Executive Desk U Workstations - P-Top Desks

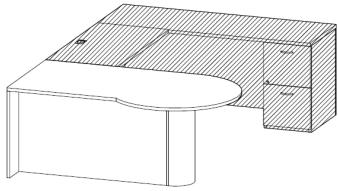

200WSP7236LFB_
P-top desk (LH), 42" diameter end, wood half cylinder base with full modesty 36" x 72" x 30"H (190 lbs)

\$3020

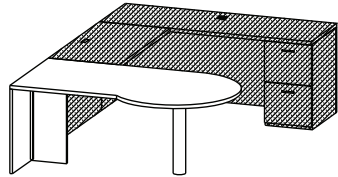

200WSP7236L_
P-top desk (LH), 42" diameter end, 4" diameter black metal base 36" x 72" x 30"H (170 lbs)

\$2301



Executive Desk U Workstations - Bullet Desks

200WSB7236LFB_
Bullet desk (LH), 36" diameter end, wood half cylinder base with full modesty 36" x 72" x 30"H (185 lbs)

\$2755

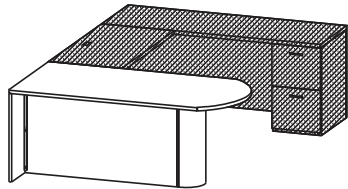

200WSB7230LFB_
Bullet desk (LH), 30" diameter end, wood half cylinder base with full modesty 30" x 72" x 30"H (177 lbs)

\$2519

200WSB6630LFB_
Bullet desk (LH), 30" diameter end, wood half cylinder base with full modesty 30" x 66" x 30"H (200 lbs)

\$2146

200WSB7236_
Bullet desk, 36" diameter end, 4" diameter black metal base 36" x 72" x 30"H (165 lbs)

\$2017

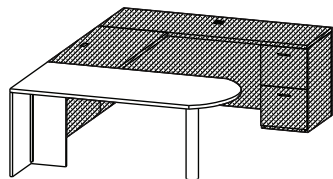

200WSB7230_
Bullet desk, 30" diameter end, 4" diameter black metal base 30" x 72" x 30"H (157 lbs)

\$1806

200WSB6630_
Bullet desk, 30" diameter end, 4" diameter black metal base 30" x 66" x 30"H (130 lbs)

\$1681

A LA CARTE SERIES

List Price

Executive Desk U Workstations - Connecting Bridges

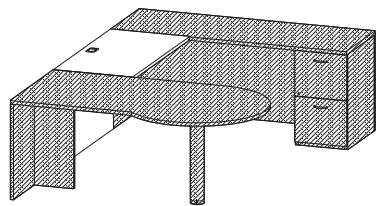

| | |
|---|--------------|
| 200WS54_ Executive height bridge, one computer grommet 24" x 54" x 30"H (83 lbs) | \$905 |
| 200WS48_ Executive height bridge, one computer grommet 24" x 48" x 30"H (78 lbs) | \$808 |
| 200WS42_ Executive height bridge, one computer grommet 24" x 42" x 30"H (73 lbs) | \$650 |
| 200WS36_ Executive height bridge, one computer grommet 24" x 36" x 30"H (68 lbs) | \$585 |



Executive Desk U Workstations - Single Pedestal Credenzas

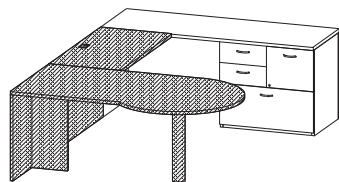

| | |
|--|---------------|
| 200DCSPR84FC_ _ Single pedestal credenza (RH), file center pedestal (locking), two box, one file drawer top, one lateral file drawer bottom, one wire mgmt grommet, 45"W kneespace 24" x 84" x 30"H (260 lbs) | \$3391 |
| 200DCSPR72FC_ _ Single pedestal credenza (RH), file center pedestal (locking), two box, one file drawer top, one lateral file drawer bottom, one wire mgmt grommet, 39"W kneespace 24" x 72" x 30"H (220 lbs) | \$3213 |
| 200DCSPR66FC_ _ Single pedestal credenza (RH), file center pedestal (locking), two box, one file drawer top, one lateral file drawer bottom, one wire mgmt grommet, 33"W kneespace 24" x 66" x 30"H (205 lbs) | \$3164 |

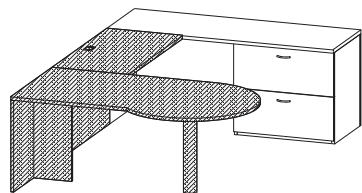

| | |
|--|---------------|
| 200DCSPR84LF_ _ Single pedestal credenza (RH), two lateral file drawers (locking), legal or letter filing, one wire mgmt grommet in back panel, 45"W kneespace 24" x 84" x 30"H (260 lbs) | \$3048 |
| 200DCSPR72LF_ _ Single pedestal credenza (RH), two lateral file drawers (locking), legal or letter filing, one wire mgmt grommet in back panel, 39"W kneespace 24" x 72" x 30"H (230 lbs) | \$2893 |
| 200DCSPR66LF_ _ Single pedestal credenza (RH), two lateral file drawers (locking), legal or letter filing, one wire mgmt grommet in back panel, 33"W kneespace 24" x 66" x 30"H (215 lbs) | \$2836 |

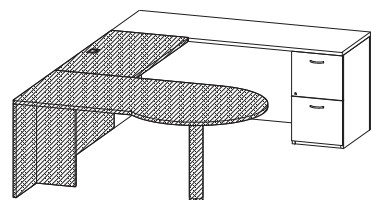

| | |
|--|---------------|
| 200DCSPR72_ _ Single pedestal credenza (RH), file/file pedestal (locking), one wire mgmt grommet in back panel, 55"W kneespace 24" x 72" x 30"H (220 lbs) | \$2625 |
| 200DCSPR66_ _ Single pedestal credenza (RH), file/file pedestal (locking), one wire mgmt grommet in back panel, 49"W kneespace 24" x 66" x 30"H (210 lbs) | \$2566 |
| 200DCSPR60_ _ Single pedestal credenza (RH), file/file pedestal (locking), one wire mgmt grommet in back panel, 43"W kneespace 24" x 60" x 30"H (195 lbs) | \$2405 |



A LA CARTE SERIES

List Price

Corner Configurations - Connecting Corners

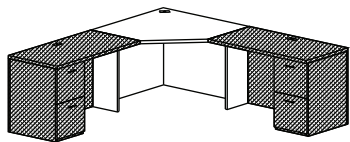

200CWS42_
 Corner unit - 42", one computer grommet
 42" x 42" x 30"H (160 lbs)



\$2075

200CWS36_
 Corner unit - 36", one computer grommet
 36" x 36" x 30"H (140 lbs)



\$1918

Corner Configurations - Connecting Units

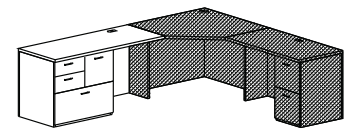

200ERL72FC_ _
 Executive height return (LH), file center pedestal (locking), two box, one file
 drawer top, one lateral file drawer bottom, one wire mgmt grommet, 40"W kneespace
 24" x 72" x 30"H (235 lbs)

\$2892

200ERL72FCFB_ _ with full modesty panel

\$3115

200ERL60FC_ _
 Executive height return (LH), file center pedestal (locking), two box, one file
 drawer top, one lateral file drawer bottom, one wire mgmt grommet, 28"W kneespace
 24" x 60" x 30"H (215 lbs)

\$2672

200ERL60FCFB_ _ with full modesty panel

\$2896

200ERL54FC_ _
 Executive height return (LH), file center pedestal (locking), two box, one file
 drawer top, one lateral file drawer bottom, one wire mgmt grommet, 22"W kneespace
 24" x 54" x 30"H (205 lbs)

\$2413

200ERL54FCFB_ _ with full modesty panel

\$2637

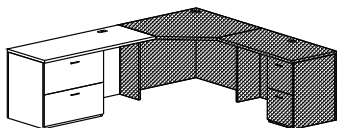

200ERL72LF_ _
 Executive height return (LH), two lateral file drawers (locking),
 one wire mgmt grommet, 40"W kneespace
 24" x 72" x 30"H (250 lbs)

\$2580

200ERL72LFFB_ _ with full modesty panel

\$2803

200ERL60LF_ _
 Executive height return (LH), two lateral file drawers (locking),
 one wire mgmt grommet, 28"W kneespace
 24" x 60" x 30"H (225 lbs)



\$2345

200ERL60LFFB_ _ with full modesty panel

\$2568

200ERL54LF_ _
 Executive height return (LH), two lateral file drawers (locking),
 one wire mgmt grommet, 22"W kneespace
 24" x 54" x 30"H (180 lbs)

\$2190

200ERL54LFFB_ _ with full modesty panel

\$2418

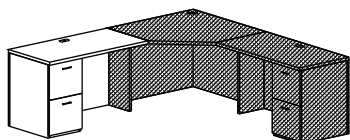

200ERL48_ _
 Executive height return (LH), file/file pedestal (locking),
 one wire mgmt grommet, 32"W kneespace
 24" x 48" x 30"H (140 lbs)



\$1739

200ERL48FB_ _ with full modesty panel

\$1950

200ERL42_ _
 Executive height return (LH), file/file pedestal (locking),
 one wire mgmt grommet, 26"W kneespace
 24" x 42" x 30"H (135 lbs)



\$1701

200ERL42FB_ _ with full modesty panel

\$1898

200ERL36_ _
 Executive height return (LH), file/file pedestal (locking),
 one wire mgmt grommet, 20"W kneespace
 24" x 36" x 30"H (130 lbs)

\$1540

200ERL36FB_ _ with full modesty panel

\$1675

A LA CARTE SERIES

List Price

Corner Configurations - Connecting Corners

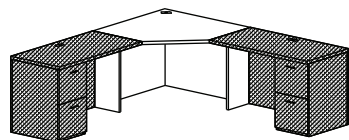

200CWS42_
 Corner unit - 42", one computer grommet
 42" x 42" x 30"H (160 lbs)



\$2075

200CWS36_
 Corner unit - 36", one computer grommet
 36" x 36" x 30"H (140 lbs)



\$1918

Corner Configurations - Connecting Units

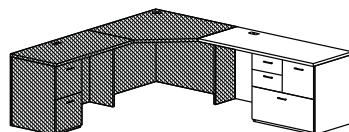

200ERR72FC_
 Executive height return (RH), file center pedestal (locking), two box, one file drawer top, one lateral file drawer bottom, one wire mgmt grommet, 40"W kneespace
 24" x 72" x 30"H (235 lbs)

\$2892

200ERR72FCFB_ with full modesty panel

\$3115

200ERR60FC_
 Executive height return (RH), file center pedestal (locking), two box, one file drawer top, one lateral file drawer bottom, one wire mgmt grommet, 28"W kneespace
 24" x 60" x 30"H (215 lbs)

\$2672

200ERR60FCFB_ with full modesty panel

\$2896

200ERR54FC_
 Executive height return (RH), file center pedestal (locking), two box, one file drawer top, one lateral file drawer bottom, one wire mgmt grommet, 22"W kneespace
 24" x 54" x 30"H (205 lbs)

\$2413

200ERR54FCFB_ with full modesty panel

\$2637

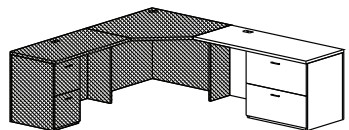

200ERR72LF_
 Executive height return (RH), two lateral file drawers (locking), one wire mgmt grommet, 40"W kneespace
 24" x 72" x 30"H (250 lbs)

\$2580

200ERR72LFFB_ with full modesty panel

\$2803

200ERR60LF_
 Executive height return (RH), two lateral file drawers (locking), one wire mgmt grommet, 28"W kneespace
 24" x 60" x 30"H (225 lbs)

\$2345

200ERR60LFFB_ with full modesty panel

\$2568

200ERR54LF_
 Executive height return (RH), two lateral file drawers (locking), one wire mgmt grommet, 22"W kneespace
 24" x 54" x 30"H (180 lbs)

\$2190

200ERR54LFFB_ with full modesty panel

\$2418

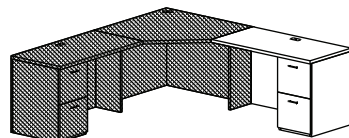

200ERR48_
 Executive height return (RH), file/file pedestal (locking), one wire mgmt grommet, 32"W kneespace
 24" x 48" x 30"H (140 lbs)

\$1739

200ERR48FB_ with full modesty panel

\$1950

200ERR42_
 Executive height return (RH), file/file pedestal (locking), one wire mgmt grommet, 26"W kneespace
 24" x 42" x 30"H (135 lbs)

\$1701

200ERR42FB_ with full modesty panel

\$1898

200ERR36_
 Executive height return (RH), file/file pedestal (locking), one wire mgmt grommet, 20"W kneespace
 24" x 36" x 30"H (130 lbs)

\$1540

200ERR36FB_ with full modesty panel

\$1675



A LA CARTE SERIES

List Price

Overhead Storage Units

200HC84_ **\$3495**

Overhead storage unit with hinged wood doors, two storage areas behind four hinged doors (non-locking), three wire mgmt access grommets in center back panel
 24 1/2" clearance between apron rail & worksurface
 16" x 84" x 39"H (250 lbs)
 Optional Open Storage - no doors (ND) - no price upcharge
 Optional Metallic Frosted Plexiglass doors (MFPD) - add \$759 list
 Optional Clear Glass doors (CGD) - add \$539 list - locks not available

200HC78_ **\$3027**

Overhead storage unit with hinged wood doors, two storage areas behind four hinged doors (non-locking), three wire mgmt access grommets in center back panel
 24 1/2" clearance between apron rail & worksurface
 16" x 78" x 39"H (230 lbs)
 Optional Open Storage - no doors (ND) - no price upcharge
 Optional Metallic Frosted Plexiglass doors (MFPD) - add \$759 list
 Optional Clear Glass doors (CGD) - add \$539 list - locks not available

200HC72_ **\$2892**

Overhead storage unit with hinged wood doors, two storage areas behind four hinged doors (non-locking), three wire mgmt access grommets in center back panel
 24 1/2" clearance between apron rail & worksurface
 16" x 72" x 39"H (220 lbs)
 Optional Open Storage - no doors (ND) - no price upcharge
 Optional Metallic Frosted Plexiglass doors (MFPD) - add \$759 list
 Optional Clear Glass doors (CGD) - add \$539 list - locks not available

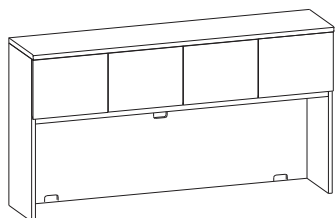

200HC66_ **\$2793**

Overhead storage unit with hinged wood doors, two storage areas behind four hinged doors (non-locking), three wire mgmt access grommets in center back panel
 24 1/2" clearance between apron rail & worksurface
 16" x 66" x 39"H (205 lbs)
 Optional Open Storage - no doors (ND) - no price upcharge
 Optional Metallic Frosted Plexiglass doors (MFPD) - add \$759 list
 Optional Clear Glass doors (CGD) - add \$539 list - locks not available



200HC60_ **\$2563**

Overhead storage unit with hinged wood doors, two storage areas behind four hinged doors (non-locking), three wire mgmt access grommets in center back panel
 24 1/2" clearance between apron rail & worksurface
 16" x 60" x 39"H (200 lbs)
 Optional Open Storage - no doors (ND) - no price upcharge
 Optional Metallic Frosted Plexiglass doors (MFPD) - add \$759 list
 Optional Clear Glass doors (CGD) - add \$539 list - locks not available

200HC48_ **\$2236**

Overhead storage unit with hinged wood doors, one storage area behind two hinged doors (non-locking), three wire mgmt access grommets in center back panel
 24 1/2" clearance between apron rail & worksurface
 16" x 48" x 39"H (146 lbs)
 Optional Open Storage - no doors (ND) - no price upcharge
 Optional Metallic Frosted Plexiglass doors (MFPD) - add \$380 list
 Optional Clear Glass doors (CGD) - add \$270 list - locks not available

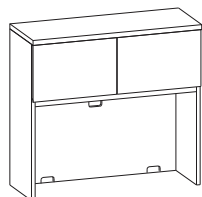

200HC42_ **\$1862**

Overhead storage unit with hinged wood doors, one storage area behind two hinged doors (non-locking), three wire mgmt access grommets in center back panel
 24 1/2" clearance between apron rail & worksurface
 16" x 42" x 39"H (130 lbs)
 Optional Open Storage - no doors (ND) - no price upcharge
 Optional Metallic Frosted Plexiglass doors (MFPD) - add \$380 list
 Optional Clear Glass doors (CGD) - add \$270 list - locks not available

*for tasklights and tackboards, see page 129

A LA CARTE SERIES

List Price

Overhead Storage Units

200HC84PH_ **\$3963**

Overhead storage unit with hinged wood doors, two storage areas behind four hinged doors (non-locking), three wire mgmt access grommets in center back panel, paper organizer 18 1/2" clearance between apron rail & worksurface
 16" x 84" x 39"H (305 lbs)
 Optional Open Storage - no doors (ND) - no price upcharge
 Optional Metallic Frosted Plexiglass doors (MFPD) - add \$759 list
 Optional Clear Glass doors (CGD) - add \$539 list - locks not available

200HC78PH_ **\$3734**

Overhead storage unit with hinged wood doors, two storage areas behind four hinged doors (non-locking), three wire mgmt access grommets in center back panel, paper organizer 18 1/2" clearance between apron rail & worksurface
 16" x 78" x 39"H (285 lbs)
 Optional Open Storage - no doors (ND) - no price upcharge
 Optional Metallic Frosted Plexiglass doors (MFPD) - add \$759 list
 Optional Clear Glass doors (CGD) - add \$539 list - locks not available

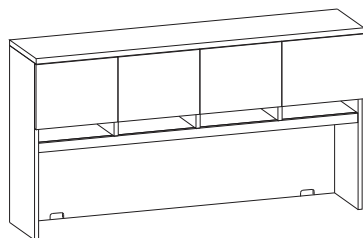

200HC72PH_ **\$3353**

Overhead storage unit with hinged wood doors, two storage areas behind four hinged doors (non-locking), three wire mgmt access grommets in center back panel, paper organizer 18 1/2" clearance between apron rail & worksurface
 16" x 72" x 39"H (265 lbs)
 Optional Open Storage - no doors (ND) - no price upcharge
 Optional Metallic Frosted Plexiglass doors (MFPD) - add \$759 list
 Optional Clear Glass doors (CGD) - add \$539 list - locks not available

200HC66PH_ **\$3232**

Overhead storage unit with hinged wood doors, two storage areas behind four hinged doors (non-locking), three wire mgmt access grommets in center back panel, paper organizer 18 1/2" clearance between apron rail & worksurface
 16" x 66" x 39"H (240 lbs)
 Optional Open Storage - no doors (ND) - no price upcharge
 Optional Metallic Frosted Plexiglass doors (MFPD) - add \$759 list
 Optional Clear Glass doors (CGD) - add \$539 list - locks not available

200HC60PH_ **\$2966**

Overhead storage unit with hinged wood doors, two storage areas behind four hinged doors (non-locking), three wire mgmt access grommets in center back panel, paper organizer 18 1/2" clearance between apron rail & worksurface
 16" x 60" x 39"H (220 lbs)
 Optional Open Storage - no doors (ND) - no price upcharge
 Optional Metallic Frosted Plexiglass doors (MFPD) - add \$759 list
 Optional Clear Glass doors (CGD) - add \$539 list - locks not available

200HC48PH_ **\$2507**

Overhead storage unit with hinged wood doors, one storage area behind two hinged doors (non-locking), three wire mgmt access grommets in center back panel, paper organizer 18 1/2" clearance between apron rail & worksurface
 16" x 48" x 39"H (146 lbs)
 Optional Open Storage - no doors (ND) - no price upcharge
 Optional Metallic Frosted Plexiglass doors (MFPD) - add \$380 list
 Optional Clear Glass doors (CGD) - add \$270 list - locks not available

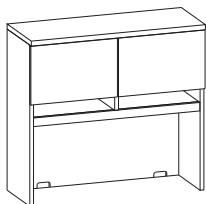

200HC42PH_ **\$2170**

Overhead storage unit with hinged wood doors, one storage area behind two hinged doors (non-locking), three wire mgmt access grommets in center back panel, paper organizer 18 1/2" clearance between apron rail & worksurface
 16" x 42" x 39"H (130 lbs)
 Optional Open Storage - no doors (ND) - no price upcharge
 Optional Metallic Frosted Plexiglass doors (MFPD) - add \$380 list
 Optional Clear Glass doors (CGD) - add \$270 list - locks not available

*for tasklights and tackboards, see page 129

A LA CARTE SERIES

List Price

Overhead Storage Units

200HO84_ **\$4835**

Overhead storage unit with hinged wood doors (non-locking), three storage areas, three adjustable shelves in outer sections, upper center section storage, three wire mgmt access grommets in center back panel
 20 1/2" clearance between apron rail & worksurface
 16" x 84" x 39"H (250 lbs)
 Optional Open Storage - no doors (ND) - no price upcharge
 Optional Metallic Frosted Plexiglass doors (MFPD) - add \$957 list
 Optional Clear Glass doors (CGD) - add \$726 listlocknotavailable

200HO78_ **\$4556**

Overhead storage unit with hinged wood doors (non-locking), three storage areas, three adjustable shelves in outer sections, upper center section storage, three wire mgmt access grommets in center back panel
 20 1/2" clearance between apron rail & worksurface
 16" x 78" x 39"H (230 lbs)
 Optional Open Storage - no doors (ND) - no price upcharge
 Optional Metallic Frosted Plexiglass doors (MFPD) - add \$957 list
 Optional Clear Glass doors (CGD) - add \$726 listlocknotavailable

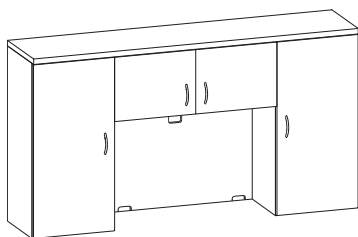

200HO72_ **\$4092**

Overhead storage unit with hinged wood doors (non-locking), three storage areas, three adjustable shelves in outer sections, upper center section storage, three wire mgmt access grommets in center back panel
 20 1/2" clearance between apron rail & worksurface
 16" x 72" x 39"H (215 lbs)
 Optional Open Storage - no doors (ND) - no price upcharge
 Optional Metallic Frosted Plexiglass doors (MFPD) - add \$957 list
 Optional Clear Glass doors (CGD) - add \$726 listlocknotavailable

200HO66_ **\$3943**

Overhead storage unit with hinged wood doors (non-locking), three storage areas, three adjustable shelves in outer sections, upper center section storage, three wire mgmt access grommets in center back panel
 20 1/2" clearance between apron rail & worksurface
 16" x 66" x 39"H (200 lbs)
 Optional Open Storage - no doors (ND) - no price upcharge
 Optional Metallic Frosted Plexiglass doors (MFPD) - add \$957 list
 Optional Clear Glass doors (CGD) - add \$726 listlocknotavailable

200HO60_ **\$3619**

Overhead storage unit with hinged wood doors (non-locking), three storage areas, three adjustable shelves in outer sections, upper center section storage, three wire mgmt access grommets in center back panel
 20 1/2" clearance between apron rail & worksurface
 16" x 60" x 39"H (185 lbs)
 Optional Open Storage - no doors (ND) - no price upcharge
 Optional Metallic Frosted Plexiglass doors (MFPD) - add \$957 list
 Optional Clear Glass doors (CGD) - add \$726 listlocknotavailable

*for tasklights and tackboards, see page 129

A LA CARTE SERIES

List Price

Overhead Storage Units

200HS84L **\$4400**

200HS84R

Overhead storage unit with hinged wood doors (non-locking), three storage areas, three adjustable shelves in outer section, upper section storage, two wire mgmt access grommets in center back panel
20 1/2" clearance between apron rail & worksurface
16" x 84" x 39"H (250 lbs)

Optional Open Storage - no doors (ND) - no price upcharge
Optional Metallic Frosted Plexiglass doors (MFPD) - add \$864 list
Optional Clear Glass doors (CGD) - add \$644 listlocksnotavailable

200HS78L **\$4145**

200HS78R

Overhead storage unit with hinged wood doors (non-locking), three storage areas, three adjustable shelves in outer section, upper section storage, two wire mgmt access grommets in center back panel
20 1/2" clearance between apron rail & worksurface
16" x 78" x 39"H (230 lbs)

Optional Open Storage - no doors (ND) - no price upcharge
Optional Metallic Frosted Plexiglass doors (MFPD) - add \$864 list
Optional Clear Glass doors (CGD) - add \$644 listlocksnotavailable

200HS72L **\$3723**

200HS72R

Overhead storage unit with hinged wood doors (non-locking), three storage areas, three adjustable shelves in outer section, upper section storage, two wire mgmt access grommets in center back panel
20 1/2" clearance between apron rail & worksurface
16" x 72" x 39"H (215 lbs)

Optional Open Storage - no doors (ND) - no price upcharge
Optional Metallic Frosted Plexiglass doors (MFPD) - add \$864 list
Optional Clear Glass doors (CGD) - add \$644 listlocksnotavailable

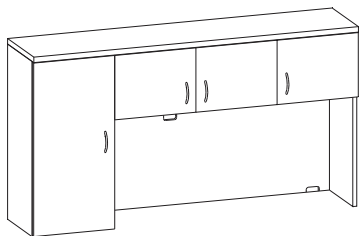

200HS66L **\$3587**

200HS66R

Overhead storage unit with hinged wood doors (non-locking), three storage areas, three adjustable shelves in outer section, upper section storage, two wire mgmt access grommets in center back panel
20 1/2" clearance between apron rail & worksurface
16" x 66" x 39"H (200 lbs)

Optional Open Storage - no doors (ND) - no price upcharge
Optional Metallic Frosted Plexiglass doors (MFPD) - add \$864 list
Optional Clear Glass doors (CGD) - add \$644 listlocksnotavailable

200HS60L **\$3292**

200HS60R

Overhead storage unit with hinged wood doors (non-locking), two storage areas, three adjustable shelves in outer section, upper section storage, two wire mgmt access grommets in center back panel
20 1/2" clearance between apron rail & worksurface
16" x 60" x 39"H (185 lbs)

Optional Open Storage - no doors (ND) - no price upcharge
Optional Metallic Frosted Plexiglass doors (MFPD) - add \$864 list
Optional Clear Glass doors (CGD) - add \$644 listlocksnotavailable

*for tasklights and tackboards, see page 129

A LA CARTE SERIES

List Price

Overhead Storage Units

200OSU-84_ **\$3947**
Storage hutch with four wood doors (non-locking), two storage areas behind four hinged doors
16" x 84" x 39"H (250 lbs)
Optional Open Storage - no doors (ND) - no price upcharge
Optional Metallic Frosted Plexiglass doors (MFPD) - add \$1001 list
Optional Clear Glass doors (CGD) - add \$759 list - locks not available

200OSU-72_ **\$3391**
Storage hutch with four wood doors (non-locking), two storage areas behind four hinged doors
16" x 72" x 39"H (220 lbs)
Optional Open Storage - no doors (ND) - no price upcharge
Optional Metallic Frosted Plexiglass doors (MFPD) - add \$1001 list
Optional Clear Glass doors (CGD) - add \$759 list - locks not available



200OSU-66_ **\$3110**
Storage hutch with four wood doors (non-locking), two storage areas behind four hinged doors
16" x 66" x 39"H (200 lbs)
Optional Open Storage - no doors (ND) - no price upcharge
Optional Metallic Frosted Plexiglass doors (MFPD) - add \$1001 list
Optional Clear Glass doors (CGD) - add \$759 list - locks not available

200OSU-60_ **\$2869**
Storage hutch with four wood doors (non-locking), two storage areas behind four hinged doors
16" x 60" x 39"H (185 lbs)
Optional Open Storage - no doors (ND) - no price upcharge
Optional Metallic Frosted Plexiglass doors (MFPD) - add \$1001 list
Optional Clear Glass doors (CGD) - add \$759 list - locks not available

200OSU-32_ **\$1555**
Storage hutch with two wood doors (non-locking), one storage area behind two hinged doors
16" x 32" x 39"H (125 lbs)
Optional Open Storage - no doors (ND) - no price upcharge
Optional Metallic Frosted Plexiglass doors (MFPD) - add \$671 list
Optional Clear Glass doors (CGD) - add \$429 list - locks not available

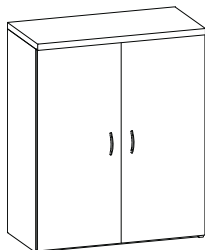

A LA CARTE SERIES

List Price

Conference Table Tops

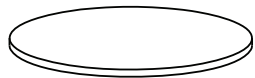

200MT48DIA_
Round conference table top
48" diameter x 1 3/16"H (62 lbs)



\$654

200MT42DIA_
Round conference table top
42" diameter x 1 3/16"H (50 lbs)



\$501

200MT36DIA_
Round conference table top
36" diameter x 1 3/16"H (30 lbs)

\$434



200MTTDT36
36" Teardrop conference table top (dock with 24" deep surfaces)
36" diameter x 1 3/16"H (30 lbs)
Square edge only

\$332

Conference Table Bases

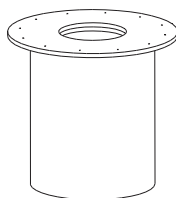

200MCB22
22" diameter drum base (for use with 48" diameter tops)
22" diameter x 27 3/4"H (85 lbs)



\$904

200MCB18
18" diameter drum base (for use with 36"-42" diameter tops)
18" diameter x 27 3/4"H (85 lbs)

\$696

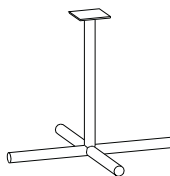

12CRFPB32
X-base in chrome (for use with 42" - 48" diameter tops)
32" x 32" x 27 3/4"H (21 lbs)

\$592

12PWFPB32
X-base in black (for use with 42" - 48" diameter tops)
32" x 32" x 27 3/4"H (21 lbs)

\$511

12CRFPB26
X-base in chrome (for use with 36" diameter tops)
26" x 26" x 27 3/4"H (16 lbs)

\$458

12PWFPB26
X-base in black (for use with 36" diameter tops)
26" x 26" x 27 3/4"H (16 lbs)

\$390



200MOBHA
Adjustable height X-base in black (for use with 36" - 42" diameter tops),
adjusts from 26" - 41", mobile on casters (locking)
32" x 32" x 27 3/4"H (25 lbs)

\$2290



200MOBFT
Flip top X-base in black (for use with 36" - 42" diameter tops),
mobile on casters (locking)
32" x 32" x 27 3/4"H (24 lbs)

\$1827

A LA CARTE SERIES

List Price

Computer Tables

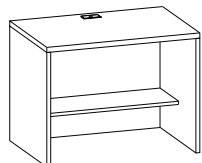

200CRT36_ \$1241
 Computer table, 10" deep storage shelf, one wire mgmt grommet in top and back panel
 24" x 36" x 30"H (105 lbs)
 Optional with caster (C) add \$139 list
 Optional with one adjustable 10" deep storage shelf (ASF) add \$165 list

200CRT48_ \$1617
 Computer table, 10" deep storage shelf, one wire mgmt grommet in top and back panel
 24" x 48" x 29"H (135 lbs)
 Optional with caster (C) add \$139 list
 Optional with one adjustable 10" deep storage shelf (ASF) add \$193 list

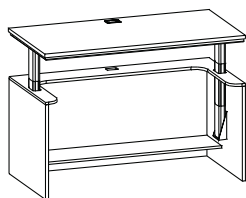

200CRT60AH_ \$7861
 Height adjustable computer table, 10" deep storage shelf, one wire mgmt grommet in top and back panel, lifting colum, control box, control pendant with memory settings, motor cable, main power cable, anti-collision dongle, lower metal lifts and anti tip brackets
 30" x 60" x 30"-44"H (265 lbs)

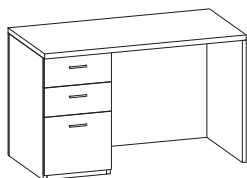

200DCSPL48_ _ (shown) \$2324
 Single pedestal credenza (LH), box/box/file pedestal (locking), one wire mgmt grommet in back panel, 30"W kneespace
 24" x 48" x 30"H (160 lbs)

200DCSPR48_ _ \$2324
 Single pedestal credenza (RH), box/box/file pedestal (locking), one wire mgmt grommet in back panel, 30"W kneespace
 24" x 48" x 30"H (160 lbs)

Work Tables

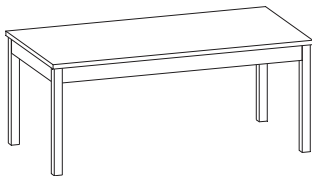

200WLT84_ \$2818
 Work table
 42" x 84" x 30"H (200 lbs)

200WLT72_ \$2414
 Work table
 36" x 72" x 30"H (140 lbs)

200WLT66_ \$2252
 Work table
 30" x 66" x 30"H (125 lbs)

200WLT6030_ \$2087
 Work table
 30" x 60" x 30"H (110 lbs)

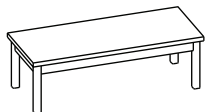

200MT2048_ \$991
 Magazine table
 20" x 48" x 16"H (58 lbs)

200CT2828_ \$967
 Corner table
 28" x 28" x 21"H (42 lbs)

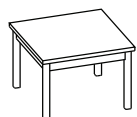

200ET2028_ \$843
 End table
 20" x 28" x 21"H (38 lbs)

A LA CARTE SERIES

List Price

Accessories

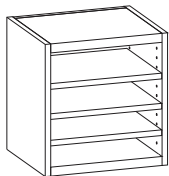

200PSA
 Portable work organizer, with three paper trays
 15" x 12" x 17"H (20 lbs)

\$628

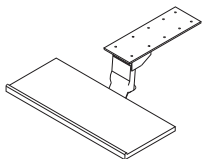

AKPW
 Articulating keyboard - leverless, with non-haned mouse pad, 5" height adjustment,
 25 degree tilt - 360 degree swivel, wooden keyboard tray - specify finish
 11 1/4" x 21 1/2" x 2 3/4"H (25 lbs)

\$472

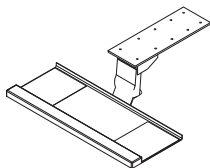

AKP
 Articulating keyboard - leverless, with non-haned mouse pad, 5" height adjustment,
 25 degree tilt - 360 degree swivel, black molded keyboard tray
 11" x 25" x 2 3/4"H (21 lbs)



\$337

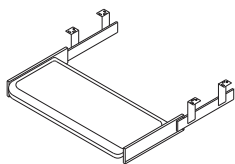

KD
 Pull-out keyboard - leverless, black molded keyboard tray
 10 5/8" x 21 1/2" x 3 5/8"H (15 lbs)

\$153

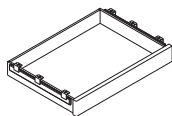

200PD20
 Pencil Drawer
 20"W x 18"D x 3"H
 *Consider kneespace clearance

\$234



LH
 Wire mgmt channel, 22" length - set of four, double sided velcro attachment
 4 lbs

\$83

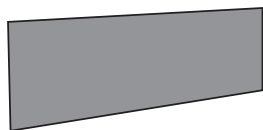

TB77
 Fabric tackboard, (COM, Grade A, Grade B) 3/4" x 77" x 15 1/2"H (20 lbs)

\$474

TB71
 Fabric tackboard, (COM, Grade A, Grade B) 3/4" x 71" x 15 1/2"H (18 lbs)

\$448

TB65
 Fabric tackboard, (COM, Grade A, Grade B) 3/4" x 65" x 15 1/2"H (16 lbs)

\$400

TB59
 Fabric tackboard, (COM, Grade A, Grade B) 3/4" x 59" x 15 1/2"H (14 lbs)

\$386

TB53
 Fabric tackboard, (COM, Grade A, Grade B) 3/4" x 53" x 15 1/2"H (12 lbs)

\$341

TB41
 Fabric tackboard, (COM, Grade A, Grade B) 3/4" x 41" x 15 1/2"H (11 lbs)

\$300

TB35
 Fabric tackboard, (COM, Grade A, Grade B) 3/4" x 35" x 15 1/2"H (10 lbs)

\$233



TL48
 Task light (UL approved), 6" x 48" x 1 1/2"H (15 lbs)



\$215

TL24
 Task light (UL approved), 6" x 24" x 1 1/2"H (10 lbs)

\$185

A LA CARTE SERIES

List Price

Modular Units - Arc Top Worksurfaces



| | | |
|----------------------|--|--------|
| 200MT4296ARC_ | Arc top work surface, 42" x 96" x 1 3/16"H (145 lbs) | \$1297 |
| 200MT4290ARC_ | Arc top work surface, 42" x 90" x 1 3/16"H (140 lbs) | \$1167 |
| 200MT4284ARC_ | Arc top work surface, 42" x 84" x 1 3/16"H (135 lbs) | \$1037 |
| 200MT4280ARC_ | Arc top work surface, 42" x 80" x 1 3/16"H (130 lbs) | \$951 |
| 200MT4278ARC_ | Arc top work surface, 42" x 78" x 1 3/16"H (125 lbs) | \$907 |
| 200MT4272ARC_ | Arc top work surface, 42" x 72" x 1 3/16"H (115 lbs) | \$777 |
| 200MT3672ARC_ | Arc top work surface, 36" x 72" x 1 3/16"H (95 lbs) | \$647 |

Modular Units - Rectangular Top Worksurfaces (42"D)



| | | |
|-------------------|--|-------|
| 200MT4296_ | Rectangular work surface, 42" x 96" x 1 3/16"H (145 lbs) | \$916 |
| 200MT4284_ | Rectangular work surface, 42" x 84" x 1 3/16"H (145 lbs) | \$841 |
| 200MT4278_ | Rectangular work surface, 42" x 78" x 1 3/16"H (145 lbs) | \$766 |
| 200MT4272_ | Rectangular work surface, 42" x 72" x 1 3/16"H (145 lbs) | \$691 |

Modular Units - Rectangular Top Worksurfaces (36"D)

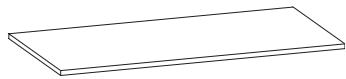

| | | |
|-------------------|--|-------|
| 200MT3696_ | Rectangular work surface, 36" x 96" x 1 3/16"H (145 lbs) | \$827 |
| 200MT3684_ | Rectangular work surface, 36" x 84" x 1 3/16"H (145 lbs) | \$764 |
| 200MT3678_ | Rectangular work surface, 36" x 78" x 1 3/16"H (145 lbs) | \$700 |
| 200MT3672_ | Rectangular work surface, 36" x 72" x 1 3/16"H (145 lbs) | \$637 |
| 200MT3666_ | Rectangular work surface, 36" x 66" x 1 3/16"H (145 lbs) | \$574 |

Modular Units - Bullet Shaped Worksurfaces

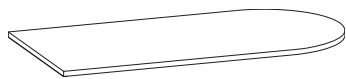

| | | |
|--------------------|--|-------|
| 200MTB3672_ | Bullet shaped work surface, 36" x 72" x 1 3/16"H (110 lbs) | \$805 |
| 200MTB3072_ | Bullet shaped work surface, 30" x 72" x 1 3/16"H (102 lbs) | \$654 |
| 200MTB3066_ | Bullet shaped work surface, 30" x 66" x 1 3/16"H (75 lbs) | \$539 |

Modular Units - P-Top Worksurfaces



| | | |
|---------------------|---|-------|
| 200MTP3672R_ | P-Top work surface (RH), 42" radius end, 36" x 72" x 1 3/16"H (110 lbs) | \$730 |
| 200MTP3672L_ | P-Top work surface (LH), 42" radius end, 36" x 72" x 1 3/16"H (110 lbs) | \$730 |

Modular Units - Bridge Worksurfaces

Use with 23" depth pedestals
-grain direction runs front to back



| | | |
|-------------------|---|-------|
| 200MTRB60_ | Bridge work surface, 24" x 60" x 1 3/16"H, Specify grommet location | \$430 |
| 200MTRB54_ | Bridge work surface, 24" x 54" x 1 3/16"H | \$387 |
| 200MTRB48_ | Bridge work surface, 24" x 48" x 1 3/16"H | \$319 |
| 200MTRB42_ | Bridge work surface, 24" x 42" x 1 3/16"H | \$298 |
| 200MTRB36_ | Bridge work surface, 24" x 36" x 1 3/16"H | \$279 |

A LA CARTE SERIES

List Price

Modular Units - Rectangular Worksurfaces (30")



| | | |
|--|---|-------|
| 200MT3096_ Rectangular worksurface, 30" x 96" x 1 3/16"H (115 lbs) | | \$818 |
| 200MT3090_ Rectangular worksurface, 30" x 90" x 1 3/16"H (110 lbs) | | \$771 |
| 200MT3084_ Rectangular worksurface, 30" x 84" x 1 3/16"H (105 lbs) | | \$724 |
| 200MT3080_ Rectangular worksurface, 30" x 80" x 1 3/16"H (102 lbs) | | \$646 |
| 200MT3078_ Rectangular worksurface, 30" x 78" x 1 3/16"H (100 lbs) | | \$631 |
| 200MT3072_ Rectangular worksurface, 30" x 72" x 1 3/16"H (95 lbs) |  | \$584 |
| 200MT3066_ Rectangular worksurface, 30" x 66" x 1 3/16"H (88 lbs) | | \$538 |
| 200MT3064_ Rectangular worksurface, 30" x 64" x 1 3/16"H (85 lbs) | | \$525 |
| 200MT3060_ Rectangular worksurface, 30" x 60" x 1 3/16"H (72 lbs) | | \$498 |
| 200MT3054_ Rectangular worksurface, 30" x 54" x 1 3/16"H (68 lbs) | | \$474 |
| 200MT3048_ Rectangular worksurface, 30" x 48" x 1 3/16"H (67 lbs) | | \$450 |
| 200MT3042_ Rectangular worksurface, 30" x 42" x 1 3/16"H (62 lbs) | | \$416 |
| 200MT3036_ Rectangular worksurface, 30" x 36" x 1 3/16"H (57 lbs) | | \$393 |

Modular Units - Rectangular Worksurfaces (24")



| | | |
|---|---|-------|
| 200MT2496_ Rectangular worksurface, 24" x 96" x 1 3/16"H (99 lbs) |  | \$739 |
| 200MT2490_ Rectangular worksurface, 24" x 90" x 1 3/16"H (94 lbs) |  | \$707 |
| 200MT2484_ Rectangular worksurface, 24" x 84" x 1 3/16"H (88 lbs) |  | \$568 |
| 200MT2480_ Rectangular worksurface, 24" x 80" x 1 3/16"H (85 lbs) |  | \$551 |
| 200MT2478_ Rectangular worksurface, 24" x 78" x 1 3/16"H (83 lbs) | | \$522 |
| 200MT2472_ Rectangular worksurface, 24" x 72" x 1 3/16"H (78 lbs) |  | \$474 |
| 200MT2466_ Rectangular worksurface, 24" x 66" x 1 3/16"H (74 lbs) |  | \$453 |
| 200MT2464_ Rectangular worksurface, 24" x 64" x 1 3/16"H (71 lbs) |  | \$449 |
| 200MT2460_ Rectangular worksurface, 24" x 60" x 1 3/16"H (68 lbs) |  | \$413 |
| 200MT2454_ Rectangular worksurface, 24" x 54" x 1 3/16"H (61 lbs) | | \$361 |
| 200MT2448_ Rectangular worksurface, 24" x 48" x 1 3/16"H (53 lbs) |  | \$308 |
| 200MT2442_ Rectangular worksurface, 24" x 42" x 1 3/16"H (45 lbs) |  | \$290 |
| 200MT2436_ Rectangular worksurface, 24" x 36" x 1 3/16"H (40 lbs) | | \$265 |
| 200MT2432_ Rectangular worksurface, 24" x 32" x 1 3/16"H (34 lbs) |  | \$249 |
| 200MT2430_ Rectangular worksurface, 24" x 30" x 1 3/16"H (30 lbs) | | \$240 |
| 200MT2424_ Rectangular worksurface, 24" x 24" x 1 3/16"H (28 lbs) | | \$215 |
| 200MT2416_ Rectangular worksurface, 24" x 16" x 1 3/16"H (26 lbs) | | \$173 |

A LA CARTE SERIES

List Price

Modular Units - Modular Back Panels

| | |
|--|---------------|
| 200MB96 Modular back panel, 3/4" x 96" x 28 3/8"H (60 lbs) | \$1009 |
| 200MB90 Modular back panel, 3/4" x 90" x 28 3/8"H (57 lbs) | \$955 |
| 200MB84 Modular back panel, 3/4" x 84" x 28 3/8"H (53 lbs) | \$892 |
| 200MB80 Modular back panel, 3/4" x 80" x 28 3/8"H (50 lbs) | \$872 |
| 200MB78 Modular back panel, 3/4" x 78" x 28 3/8"H (47 lbs) | \$855 |
| 200MB72 Modular back panel, 3/4" x 72" x 28 3/8"H (45 lbs) | \$809 |
| 200MB66 Modular back panel, 3/4" x 66" x 28 3/8"H (42 lbs) | \$762 |
| 200MB64 Modular back panel, 3/4" x 64" x 28 3/8"H (41 lbs) | \$747 |
| 200MB60 Modular back panel, 3/4" x 60" x 28 3/8"H (38 lbs) | \$706 |
| 200MB54 Modular back panel, 3/4" x 54" x 28 3/8"H (34 lbs) | \$662 |
| 200MB48 Modular back panel, 3/4" x 48" x 28 3/8"H (30 lbs) | \$611 |
| 200MB42 Modular back panel, 3/4" x 42" x 28 3/8"H (27 lbs) | \$433 |
| 200MB40 Modular back panel for step back, 3/4" x 40" x 28 3/8"H (27 lbs) | \$415 |
| 200MB36 Modular back panel, 3/4" x 36" x 28 3/8"H (23 lbs) | \$382 |
| 200MB34 Modular back panel, 3/4" x 34" x 28 3/8"H (21 lbs) | \$371 |
| 200MB32 Modular back panel, 3/4" x 32" x 28 3/8"H (21 lbs) | \$334 |
| 200MB28 Modular back panel for step back, 3/4" x 28" x 28 3/8"H (13 lbs) | \$322 |
| 200MB24 Modular back panel, 3/4" x 24" x 28 3/8"H (12 lbs) | \$262 |
| 200MB16 Modular back panel, 3/4" x 16" x 28 3/8"H (10 lbs) | \$203 |



Optional Wire Management



WM **\$77**
Optional wire management cutout on top center back of the above modesty panel



HB **NC**
Optional Half Back Panel for Units with Backs (11"H) - approx. 18" above floor level



GR **\$61**
Wire management grommet (black) - note location



LH **\$83**
Wire management channel, 22" length - set of four, double sided velcro attachment (4 lbs)



CL **\$65**
Velcro wire management (secures wires) - set of four, double sided velcro attachment (1 lb)

A LA CARTE SERIES

List Price

Modular Units - Modular End Panels



| | |
|--|-------|
| 200MWE42 Modular end panel, 42" x 1" x 28 3/8"H (35 lbs) | \$622 |
| 200MWE41 Modular end panel, 41" x 1" x 28 3/8"H (35 lbs) | \$618 |
| 200MWE36 Modular end panel, 36" x 1" x 28 3/8"H (30 lbs) | \$533 |
| 200MWE35 Modular end panel, 35" x 1" x 28 3/8"H (30 lbs) | \$529 |
| 200MWE30 Modular end panel, 30" x 1" x 28 3/8"H (26 lbs) | \$461 |
| 200MWE29 Modular end panel, 29" x 1" x 28 3/8"H (26 lbs) | \$457 |
| 200MWE24 Modular end panel, 24" x 1" x 28 3/8"H (21 lbs) | \$410 |
| 200MWE23 Modular end panel, 23" x 1" x 28 3/8"H (21 lbs) | \$406 |



Modular Units - Modular T End Panels

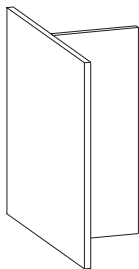

| | |
|--|-------|
| 200MWET42 Modular end panel, 42" x 12" x 28 3/8"H (45 lbs) | \$794 |
| 200MWET36 Modular end panel, 36" x 12" x 28 3/8"H (40 lbs) | \$748 |
| 200MWET30 Modular end panel, 30" x 12" x 28 3/8"H (35 lbs) | \$680 |
| 200MWET24 Modular end panel, 24" x 12" x 28 3/8"H (30 lbs) | \$612 |



Modular Units - Modular Step Panels

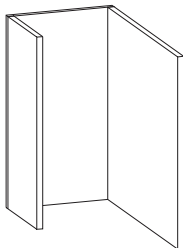

| | |
|--|--------|
| 200MWE42SSBL or 200MWE42SSBR Modular step panel, 42" x 16" x 28 3/8"H (55 lbs) | \$1024 |
| 200MWE36SSBL or 200MWE36SSBR Modular step panel, 36" x 16" x 28 3/8"H (50 lbs) | \$965 |
| 200MWE30SSBL or 200MWE30SSBR Modular step panel, 30" x 16" x 28 3/8"H (45 lbs) | \$895 |
| 200MWE24SSBL or 200MWE24SSBR Modular step panel, 24" x 16" x 28 3/8"H (40 lbs) | \$825 |

Modular Units - Modular Support Panel



| | |
|--|-------|
| 200MWE12 Modular support panel, 12" x 1" x 28 3/8"H (10 lbs) | \$252 |
|--|-------|



Modular Units - Modular Support Bases



| | |
|--|-------|
| 200MCB 4" Diameter black metal base, 4" x 4" x 28 1/4"H (15 lbs) | \$362 |
| 200MCBW 4" Diameter wood base, 4" x 4" x 28 1/4"H (15 lbs) | \$327 |



| | |
|--|-------|
| 200MHCB12 12" Diameter half cylinder wood base, 12" x 6" x 28 1/4"H (10 lbs) | \$699 |
|--|-------|

A LA CARTE SERIES

List Price

Modular Units - Modular Pedestals

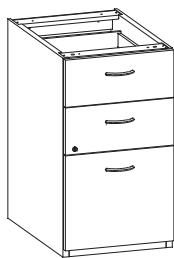

200MPBBF3616 \$1751
 Modular box/box/file pedestal (locking), open back, to be used under modular worksurfaces
 35"D x 16"W x 28 3/8"H (105 lbs)

200MPBBF3016 \$1588
 Modular box/box/file pedestal (locking), open back, to be used under modular worksurfaces 
 29"D x 16"W x 28 3/8"H (81 lbs)

200MPBBF2416 \$1317
 Modular box/box/file pedestal (locking), open back, to be used under modular worksurfaces 
 23"D x 16"W x 28 3/8"H (70 lbs)

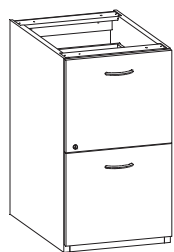

200MPFF3616 \$1492
 Modular file/file pedestal (locking), open back, to be used under modular worksurfaces
 35"D x 16"W x 28 3/8"H (100 lbs)

200MPFF3016 \$1394
 Modular file/file pedestal (locking), open back, to be used under modular worksurfaces 
 29"D x 16"W x 28 3/8"H (76 lbs)

200MPFF2416 \$1255
 Modular file/file pedestal (locking), open back, to be used under modular worksurfaces 
 23"D x 16"W x 28 3/8"H (65 lbs)

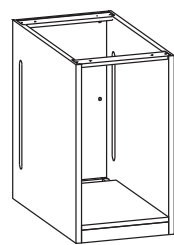

200MPCP3616 \$921
 Modular CPU pedestal, open front - open back, to be used under modular worksurfaces,
 ventilation slots on right and left sides (back)
 35"D x 16"W x 28 3/8"H (65 lbs)

200MPCP3016 \$879
 Modular CPU pedestal, open front - open back, to be used under modular worksurfaces,
 ventilation slots on right and left sides (back)
 29"D x 16"W x 28 3/8"H (55 lbs)

200MPCP2416 \$836
 Modular CPU pedestal, open front - open back, to be used under modular worksurfaces,
 ventilation slots on right and left sides (back)
 23"D x 16"W x 28 3/8"H (45 lbs)

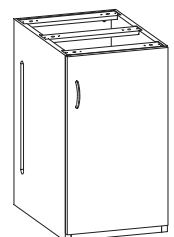

200MPCPHD3616L or 200MPCPHD3616R \$1313
 Modular CPU pedestal, hinged door front - open back, to be used under modular worksurfaces,
 ventilation slots on right and left sides (back)
 35"D x 16"W x 28 3/8"H (75 lbs)

200MPCPHD3016L or 200MPCPHD3016R \$1271
 Modular CPU pedestal, hinged door front - open back, to be used under modular worksurfaces,
 ventilation slots on right and left sides (back)
 29"D x 16"W x 28 3/8"H (65 lbs)

200MPCPHD2416L or 200MPCPHD2416R \$1228
 Modular CPU pedestal, hinged door front - open back, to be used under modular worksurfaces,
 ventilation slots on right and left sides (back)
 23"D x 16"W x 28 3/8"H (55 lbs)

A LA CARTE SERIES

List Price

Modular Units - Modular Pedestals

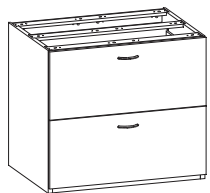

200MPLF22432

Modular lateral file pedestal (locking), open back, to be used under modular worksurfaces, accommodates legal or letter filing
23"D x 32"W x 28 3/8"H (115 lbs)

\$1680

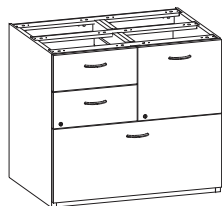

200MPFC2432

Modular file center pedestal (locking), open back, to be used under modular worksurfaces, two box, one filedrawer-top, lateral file-bottom
23"D x 32"W x 28 3/8"H (145 lbs)

\$2066

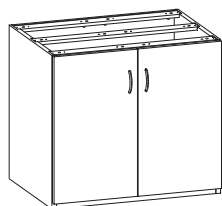

200MPHD2432

Modular hinged door storage pedestal (non-locking), open back, to be used under modular worksurfaces, one adjustable shelf
23"D x 32"W x 28 3/8"H (113 lbs)

\$1794

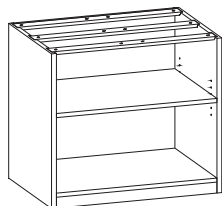

200MPBC2432

Modular open bookcase with one adjustable shelf, open back, to be used under modular worksurfaces
23"D x 32"W x 28 3/8"H (113 lbs)

\$1010



200GB6

Ganging bracket, used to attach two pedestals or series of pedestals at bottom
6"D x 3 1/2"W x 2"H (2 lbs)

\$41

Mobile Pedestals

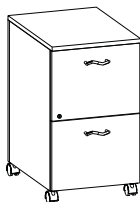

200MOBFF2416

Mobile pedestal with file/file pedestal (locking)
22"D x 16"W x 28"H (95 lbs)

\$1463

*no edge profile

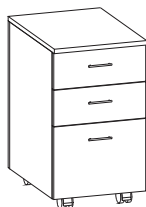

200MOBBF2416

Mobile pedestal with box/box/file pedestal (locking)
22"D x 16"W x 28"H (95 lbs)

\$1419

*no edge profile

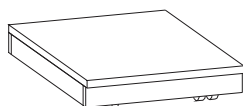

200MOBPP2416

Mobile pedestal printer pedestal stand
16"D x 16"W x 4"H (20 lbs)

\$928

A LA CARTE SERIES

List Price

Desk Shells

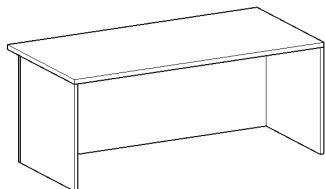

200SH7236FB_ _ \$2140
Shell only, no pedestals
36" x 72" x 30"H (210 lbs)

200SH7230FB_ _ \$1986
Shell only, no pedestals
30" x 72" x 30"H (180 lbs)

200SH6636FB_ _ \$2060
Shell only, no pedestals
36" x 66" x 30"H (187 lbs)

200SH6630FB_ _ \$1874
Shell only, no pedestals
30" x 66" x 30"H (170 lbs)

200SH6030FB_ _ \$1800
Shell only, no pedestals
30" x 60" x 30"H (159 lbs)

200SH4830FB_ _ \$1681
Shell only, no pedestals
30" x 48" x 30"H (137 lbs)

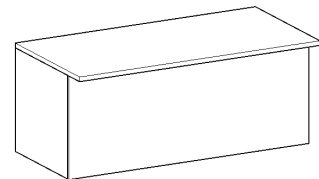

Credenza Shells

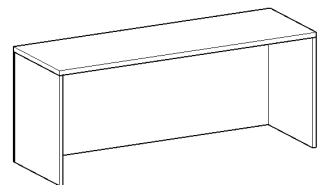

200DCSH72_ _ \$1841
Shell only, no pedestals
24" x 72" x 30"H (163 lbs)

200DCSH66_ _ \$1778
Shell only, no pedestals
24" x 66" x 30"H (156 lbs)

200DCSH60_ _ \$1709
Shell only, no pedestals
24" x 60" x 30"H (146 lbs)

200DCSH48_ _ \$1476
Shell only, no pedestals
24" x 48" x 30"H (123 lbs)

Transaction Counter - Desk & Credenza

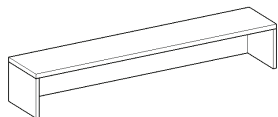

200TC72_ _ \$1084
14" x 72" x 12"H (80 lbs)

200TC66_ _ \$1061
14" x 66" x 12"H (74 lbs)

200TC60_ _ \$1038
14" x 60" x 12"H (68 lbs)

Transaction Counter - Bridge

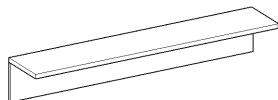

200TCC80_ _ \$1041
14" x 80" x 12"H (80 lbs)

200TCC74_ _ \$1018
14" x 74" x 12"H (74 lbs)

200TCC68_ _ \$995
14" x 68" x 12"H (68 lbs)

Transaction Counter - Return

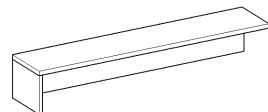

200TCL70_ _ (shown) / 200TCR70_ _ \$1042
14" x 70" x 12"H (76 lbs)

200TCL64_ _ (shown) / 200TCR64_ _ \$1015
14" x 64" x 12"H (70 lbs)

200TCL58_ _ (shown) / 200TCR58_ _ \$992
14" x 58" x 12"H (64 lbs)

200TCL52_ _ (shown) / 200TCR52_ _ \$969
14" x 52" x 12"H (58 lbs)

BASICS 3 SERIES



Contemporary styling with a choice of 12 finishes, 6 edge details and 1 3/16” thick wood tops highlights the Basics 3 Series.

BASICS 3 SERIES

Finishes Available

Walnut

Empire Walnut

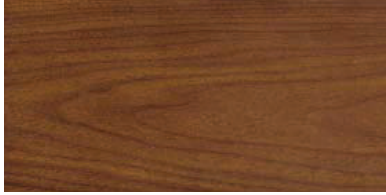

Richleigh Walnut



Royal Walnut



Espresso



Old World Mahogany



Crescent Cherry on Walnut

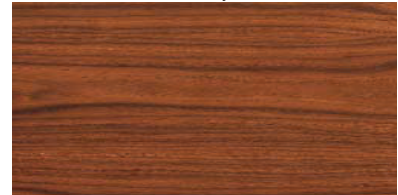

Cherry

Collector's Cherry



Amber Cherry



Cinnamon Cherry

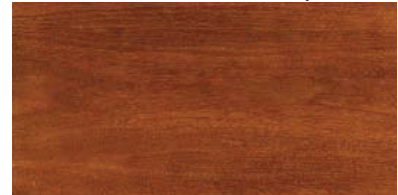

Mocha Cherry



Mahogany on Cherry

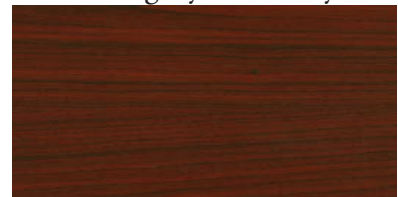

Maple

Sunrise Maple



**The finishes shown on this page have been reproduced as accurately as possible, however, due to the printing process some finishes may vary slightly from the actual finish samples originally photographed. In addition, due to the nature of wood, it is possible that some slight variations in color and grain character may occur naturally (which is the beauty of a natural product). Wood finish chips are available for each of the above finishes if requested (please call customer service).

BASICS 3 SERIES



Options Available

| | | |
|-------|---|--------------------------|
| HPL | Matching high pressure laminate substituted for wood top - Call customer service for matching finish selections | \$ N/C |
| CD | Center Drawer | \$ 374 |
| Pulls | Optional hardware pulls in place of standard finger pull | \$ 33 per pull |
| FF | Change BBF pedestal to F/F | \$ N/C |
| CPU | Change BBF or FF pedestal to CPU pedestal - inside dimensions: 14 3/16"Wx17 13/16"Dx22 3/8"H - hinged door (non-locking), two ventilation slots in back panel and inside end panel grommet | \$ 110 |
| BBF | Change F/F pedestal to BBF | \$ 110 |
| PNT | Change lateral file or file center pedestal to printer pedestal - inside dimensions: 27 1/2"Wx17 13/16"Dx22 3/8"H - slide out printer shelf, wall access cut-out in back modesty and inside end panel grommet | \$ 110 |
| HB | Optional half modesty panel on units with backs | \$ N/C |
| LK | Locking of individual doors, drawers or pedestals (where not standard) | \$ 55 |
| FS | Freestanding unit - change from connecting unit (notched) to freestanding unit | \$ 88 |
| GR | Wire mgmt grommet (note location) | \$ 61 |
| WA | Wall access cut-out (modesty panels on bridges, credenzas, desks and returns) | \$ N/C |
| AHM | Electronic height adjustable mechanism added to worksurface, lifting column, control box, control pendant, with memory settings, motor cable, main power cable, anti-collision dongle. Lower metal lifts and anti-tip brackets. Adjusts from 30" - 44"H | Contact Customer Service |

BASICS 3 SERIES

Warranty and Certification

All products listed are warranted against defects of material and workmanship under normal use and service for a minimum of 10 years from the date of installation (see full warranty information). All products listed are Level 2 BIFMA certified.

Veneer

Veneer on all exposed surfaces is American Black Walnut, Cherry or Maple. Outside surface veneers are book matched to provide proper grain consistency and uniform grain appearance. Drawer fronts are vertical grain cherry, maple or walnut veneers and matched in selected sets to ensure proper veneer balance and uniform grain appearance.

Wood Veneer Tops

1 3/16" thick tops utilizing 3-ply construction, shaped with six edge details. Top cores are high density fiberboard. Cherry, maple or walnut veneer tops are standard. High pressure laminate tops are optional, with many standard finishes having matching laminate tops available (call customer service for options).

Modesty Panels and End Panels

End panels are 29/32" thick with a 3-ply construction and a solid lumber band on the bottom edge of the panel to prevent tear out. Modesty panels are 3/4" thick, 3-ply construction. All veneers are vertical grain cherry, maple or walnut veneers matched to ensure proper veneer balance, provide proper grain consistency and uniform grain appearance. Full modesty panels are standard for desk, bridge, and kneespace credenzas with optional half modesty options available.

Drawers

Drawer sides and backs are vinyl wrapped, 7/16" thick. Drawer fronts are 3-ply hardwood construction, 3/4" thick with book matched veneers to provide proper grain consistency and uniform grain appearance. All drawers utilize five sided drawer construction. Drawers are assembled with dovetail construction in all four corners. Drawer bottoms are 7/32" 3-ply hardwood dado construction.

Doors

Doors are 3/4" thick 3-ply construction with vertical grain cherry, maple or walnut veneers and matched in selected sets to ensure proper veneer balance and uniform grain appearance. European style hidden hinges are used on all doors. Tempered glass conforming to ASTM C 1048 is used in all glass doors.

Shelves

Shelves are 3-ply construction with a 1/4" cherry, maple or walnut rim on the front edge. All shelves are full depth of the interior compartment unless specified otherwise. Faces are book matched cherry, maple or walnut veneer. Hutch shelves are cherry, maple or walnut faced on both sides. A minimum of one adjustable or fixed shelf is provided with each cabinet storage unit (see individual unit for details). Adjustable shelves are provided with metal adjustable shelf hardware supports.

Bases

Height adjustable leveling glides are mounted in each corner with a threaded metal insert capped with a nylon glide that is height adjustable to approx. 1 1/2" to ensure proper leveling of the unit to varying floor conditions.

Hardware

Drawer Suspensions – File, box, pencil and center drawers utilize steel "A" grade heavy duty metal slides for smooth operation. All pedestal drawers have 100 % full extension slides. All suspension systems feature positive and cushioned in/out stops. All box, center, and tray drawers are removable without tools and the suspensions are designed to prevent accidental removal.

Locks – All desks and credenzas utilize pedestal locking. Lateral files are keyed as standard and feature central locking with anti-tip drawer interlock systems. Individual pieces are shipped random keyed. Units may be keyed alike upon special request. A minimum of fifty key changes (numbers) are available. Core lock changes are available (contact customer service).

Drawer Pulls – Finger pulls are standard with the optional replacement for four drawer pull options in either black or nickel finish and one drawer pull option (in brass) for an additional up-charge (see attached for details).

Hinges – European style hidden hinges on all hinged doors.

Wire Management – Black wire management grommets are standard on all returns and bridge work surfaces located in back center of the tops. Black wire management access grommets are standard on all credenzas, hutches, overhead storage units and computer tables located in back panel. Optional additional black wire management grommets, wall access cut-outs, wiring harness and wiring channels along with integrated cable management to conceal power and data cords are also available. Optional data ports accessible at work surface height (see accessories).

Chassis Construction

Construction technique is mortise and tenon, groove and tenon, heavily glue blocked with hardwood cleats for maximum strength.

Filing

File drawers use an easily adjustable filing rail system which can be positioned to accommodate front to back or side to side letter or legal filing.

Finish

All exposed surfaces are finished with a UV inhibitor catalyzed varnish finish to ensure maximum durability, chemical resistance, color retention and clarity. All exterior surfaces are finished in the following multi-step sequence: sap stain, NGR stain, wash coat, wash coat sand, filler spray, filler wipe, sealer spray, sealer sand, varnish spray, varnish sand, varnish spray. Moisture content for all wooden parts is between 5 - 9% prior to sealing. Drawer interiors and exteriors are UV prefinished with sealer, sealer sand, and varnished. Custom finish matches are available, contact customer service for request.

Standard Profile Options

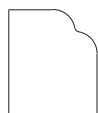

Duet - H

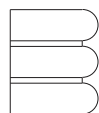

Reeded - D

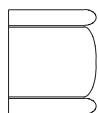

Tri-Oval - C

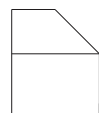

Bevel - V



Square - A

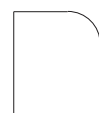

Radius - R

Optional Drawer Pulls



LB - Bar Black



AB - Arc Black



CB - Crescent Black



JB - Wave Black



KB - Classic Brass



LN - Bar Nickel



AN - Arc Nickel



CN - Crescent Nickel



JN - Wave Nickel

BASICS 3 SERIES

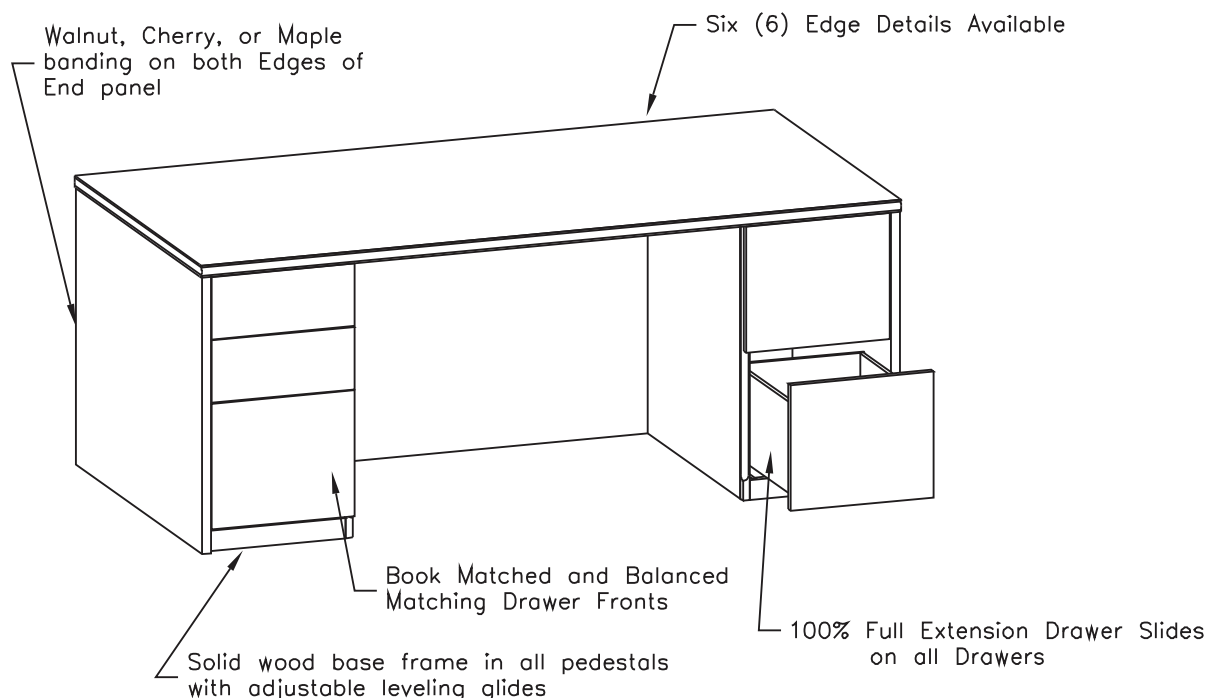

Ordering Information

Use the following steps to correctly place your order:

1) Determine the correct model number for the item you are selecting - example:

7000FC72 = Double pedestal desk, 36" x 72" x 29"H

2) Determine the proper finish selection for the item - example:

7000FC72-OW = Double pedestal desk, 36" x 72" x 29"H, in Old World Mahogany

3) Determine the edge profile you may wish for the item - example:

7000FC72-OW-V = Double pedestal desk, 36" x 72" x 29"H, in Old World Mahogany, with Bevel edge detail

4) Determine any additional options you may wish for the item - example:

7000FC72-OW-V-AN = Double pedestal desk, 36" x 72" x 29"H, in Old World Mahogany, with Bevel edge detail, with Arc Nickel pulls

BASICS 3 SERIES

List Price

Double Pedestal Desks

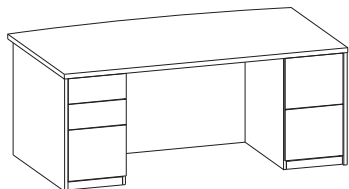

7000FK7242FP_ _ \$2938
 Double pedestal desk with arc conference top, box/box/file pedestal (LH), file/file pedestal (RH), pedestal locking, full modesty, 6" approach overhang
 40" W Kneespace
 42" x 72" x 29"H (405 lbs)
7000CD36 Optional Center Drawer \$374



7000FK7236FP_ _ \$2543
 Double pedestal desk with arc conference top, box/box/file pedestal (LH), file/file pedestal (RH), pedestal locking, full modesty, 6" approach overhang
 40" W Kneespace
 36" x 72" x 29"H (395 lbs)
7000CD36 Optional Center Drawer \$374

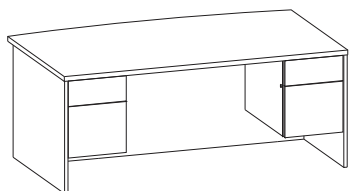

7000FK7242_ _ \$2520
 Double pedestal desk with arc conference top, two box/file 3/4 pedestals, pedestal locking, full modesty, 3" approach overhang
 40" W Kneespace
 42" x 72" x 29"H (405 lbs)
7000CD36 Optional Center Drawer \$374

7000FK7236_ _ \$2156
 Double pedestal desk with arc conference top, two box/file 3/4 pedestals, pedestal locking, full modesty, 3" approach overhang
 40" W Kneespace
 36" x 72" x 29"H (395 lbs)
7000CD36 Optional Center Drawer \$374

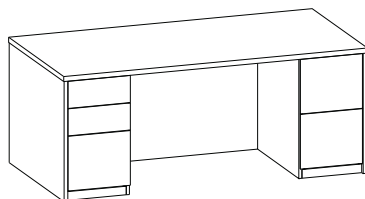

7000FC72FP_ _ \$2919
 Double pedestal desk with conference top, box/box/file pedestal (LH), file/file pedestal (RH), pedestal locking, full modesty, 3" approach overhang
 40" W Kneespace
 36" x 72" x 29"H (365 lbs)
7000CD36 Optional Center Drawer \$374



7000FC66FP_ _ \$2671
 Double pedestal desk with conference top, box/box/file pedestal (LH), file/file pedestal (RH), pedestal locking, full modesty, 3" approach overhang
 34" W Kneespace
 30" x 66" x 29"H (320 lbs)
7000CD30 Optional Center Drawer \$374

7000FC60FP_ _ \$2439
 Double pedestal desk with conference top, box/box/file pedestal (LH), file/file pedestal (RH), pedestal locking, full modesty, 3" approach overhang
 28" W Kneespace
 30" x 60" x 29"H (305 lbs)
7000CD24 Optional Center Drawer \$374

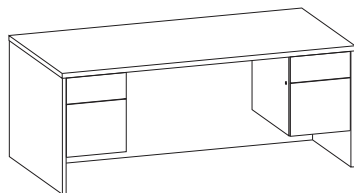

7000FC72_ _ \$2632
 Double pedestal desk with conference top, two box/file 3/4 pedestals, pedestal locking, full modesty, 3" approach overhang
 40" W Kneespace
 36" x 72" x 29"H (365 lbs)
7000CD36 Optional Center Drawer \$374

7000FC66_ _ \$2397
 Double pedestal desk with conference top, two box/file 3/4 pedestals, pedestal locking, full modesty, 3" approach overhang
 34" W Kneespace
 30" x 66" x 29"H (320 lbs)
7000CD30 Optional Center Drawer \$374

7000FC60_ _ \$2172
 Double pedestal desk with conference top, two box/file 3/4 pedestals, pedestal locking, full modesty, 3" approach overhang
 28" W Kneespace
 30" x 60" x 29"H (305 lbs)
7000CD24 Optional Center Drawer \$374

BASICS 3 SERIES

List Price

Credenzas

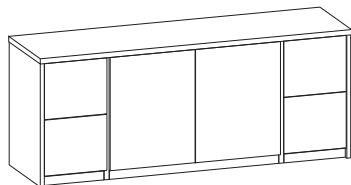

7000DC72-4FP_ _ \$2746

Credenza with hinged door storage, two file/file pedestals (locking), hinged door storage area (non-locking) with one adjustable shelf, wire mgmt grommet in back panel 20" x 72" x 29"H (285 lbs) *Optional pull not available on hinged doors

7000DC72-4FP-24 - 24" x 72" x 29"H \$3164

7000DC66-4FP_ _ \$2542

Credenza with hinged door storage, two file/file pedestals (locking), hinged door storage area (non-locking) with one adjustable shelf, wire mgmt grommet in back panel 20" x 66" x 29"H (265 lbs) *Optional pull not available on hinged doors

7000DC66-4FP-24 - 24" x 66" x 29"H \$2927

7000DC60-4FP_ _ \$2349

Credenza with hinged door storage, two file/file pedestals (locking), hinged door storage area (non-locking) with one adjustable shelf, wire mgmt grommet in back panel 20" x 60" x 29"H (245 lbs) *Optional pull not available on hinged doors

7000DC60-4FP-24 - 24" x 60" x 29"H \$2701

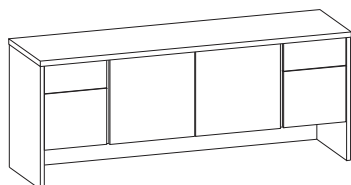

7000DC72-4_ _ \$2433

Credenza with hinged door storage, two box/file 3/4 pedestals (locking), hinged door storage area (non-locking) with one adjustable shelf, wire mgmt grommet in back panel 20" x 72" x 29"H (265 lbs) *Optional pull not available on hinged doors

7000DC72-4-24 - 24" x 72" x 29"H \$2840

7000DC66-4_ _ \$2240

Credenza with hinged door storage, two box/file 3/4 pedestals (locking), hinged door storage area (non-locking) with one adjustable shelf, wire mgmt grommet in back panel 20" x 66" x 29"H (245 lbs) *Optional pull not available on hinged doors

7000DC66-4-24 - 24" x 66" x 29"H \$2614

7000DC60-4_ _ \$2036

Credenza with hinged door storage, two box/file 3/4 pedestals (locking), hinged door storage area (non-locking) with one adjustable shelf, wire mgmt grommet in back panel 20" x 60" x 29"H (225 lbs) *Optional pull not available on hinged doors

7000DC60-4-24 - 24" x 60" x 29"H \$2395

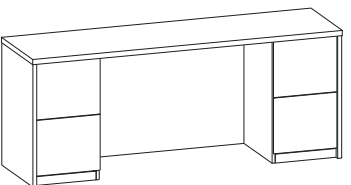

7000DC72-3FP_ _ \$2306

Credenza with kneespace, two file/file pedestals (locking), wire mgmt grommet in back panel 40" W kneespace 20" x 72" x 29"H (260 lbs)

7000DC72-3FP-24 - 24" x 72" x 29"H \$2702



7000DC66-3FP_ _ \$2147

Credenza with kneespace, two file/file pedestals (locking), wire mgmt grommet in back panel 32" W kneespace 20" x 66" x 29"H (240 lbs)

7000DC66-3FP-24 - 24" x 66" x 29"H \$2510



7000DC60-3FP_ _ \$1998

Credenza with kneespace, two file/file pedestals (locking), wire mgmt grommet in back panel 26" W kneespace 20" x 60" x 29"H (210 lbs)

7000DC60-3FP-24 - 24" x 60" x 29"H \$2328

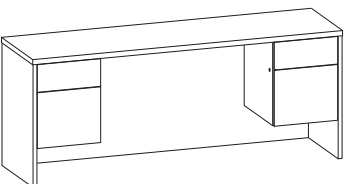

7000DC72-3_ _ \$2066

Credenza with kneespace, two box/file 3/4 pedestals (locking), wire mgmt grommet in back panel 40" W kneespace 20" x 72" x 29"H (235 lbs)

7000DC72-3-24 - 24" x 72" x 29"H \$2451

7000DC66-3_ _ \$1911

Credenza with kneespace, two box/file 3/4 pedestals (locking), wire mgmt grommet in back panel 32" W kneespace 20" x 66" x 29"H (215 lbs)

7000DC66-3-24 - 24" x 66" x 29"H \$2263

7000DC60-3_ _ \$1766

Credenza with kneespace, two box/file 3/4 pedestals (locking), wire mgmt grommet in back panel 26" W kneespace 20" x 60" x 29"H (195 lbs)

7000DC60-3-24 - 24" x 60" x 29"H \$2085

BASICS 3 SERIES

List Price

Storage Units

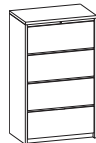

7000LF4V_ _ **\$3101**
 Four drawer lateral file, legal or letter cross filing, central locking
 20" x 32" x 54"H (240 lbs)
7000LF4V-24 - 24" x 32" x 54"H **\$3365**

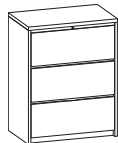

7000LF3_ _ **\$2455**
 Three drawer lateral file, legal or letter cross filing, central locking
 20" x 32" x 42"H (195 lbs)
7000LF3-24 - 24" x 32" x 42"H **\$2697**

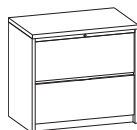

7000LF2_ _ **\$1789**
 Two drawer lateral file, legal or letter cross filing, central locking
 20" x 32" x 29"H (135 lbs)
7000LF2-24 - 24" x 32" x 29"H **\$2009**

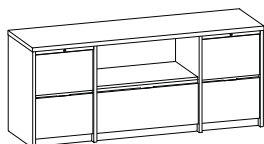

7000LF2CU **\$2697**
 Corner two drawer lateral file - 24" x 32" x 29"H

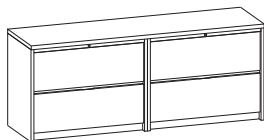

7000FC5BC_ _ **\$2829**
 Open storage/file, left and right file/file pedestal (locking), center - top open storage area, bottom - lateral file (non-locking), legal or letter filing, wire mgmt grommet in back panel
 20" x 72" x 29"H (280 lbs)
7000FC5BC-24 - 24" x 72" x 29"H **\$3104**

7000LF4-72_ _ **\$3574**
 Double unit lateral file, legal or letter cross filing, central locking
 20" x 72" x 29"H (235 lbs)
7000LF4-72-24 - 24" x 72" x 29"H **\$3849**

7000LF4-66_ _ **\$3214**
 Double unit lateral file, legal or letter cross filing, central locking
 20" x 66" x 29"H (215 lbs)
7000LF4-66-24 - 24" x 66" x 29"H **\$3478**

7000LF4-60_ _ **\$2869**
 Double unit lateral file, legal or letter cross filing, central locking
 20" x 60" x 29"H (195 lbs)
7000LF4-60-24 - 24" x 60" x 29"H **\$3122**

7000SC-72_ _ **\$3437**
 Four door hinged door cabinet (non-locking), one adjustable shelf per section
 20" x 72" x 29"H (300 lbs)
 *Optional pull not available
7000SC-72-24 - 24" x 72" x 29"H **\$3712**

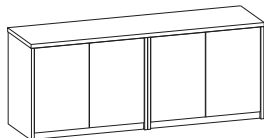

7000SC-66_ _ **\$3067**
 Four door hinged door cabinet (non-locking), one adjustable shelf per section
 20" x 66" x 29"H (260 lbs)
 *Optional pull not available
7000SC-66-24 - 24" x 66" x 29"H **\$3331**

7000SC-60_ _ **\$2729**
 Four door hinged door cabinet (non-locking), one adjustable shelf per section
 20" x 60" x 29"H (200 lbs)
 *Optional pull not available
7000SC-60-24 - 24" x 60" x 29"H **\$2982**

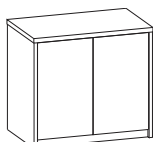

7000SC-32_ _ **\$1893**
 Two door hinged door cabinet (non-locking), one adjustable shelf
 20" x 32" x 29"H (125 lbs)
 *Optional pull not available
7000SC-32-24 - 24" x 32" x 29"H **\$2113**

BASICS 3 SERIES

List Price

Storage Units

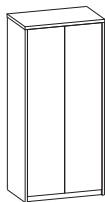

7000WC69__ **\$3390**
 Wardrobe, left side clothing carrier, right side four adjustable shelves, non-locking
 20" x 32" x 69"H (290 lbs)
 Optional locking doors (LK) - add \$55 list
 Optional full wardrobe - full coat rod (FULL) - N/C
7000WC69-24 - 24" x 32" x 69"H **\$3632**



7000WC6918R__ hinged right **\$2768**
7000WC6918L__ hinged left
 Single unit wardrobe, top shelf, coat rod, non-locking left or right hinged door
 20" x 18" x 69"H (145 lbs)
 Optional locking door (LK) - add \$55 list
7000WC6918R-24 - 24" x 18" x 69"H **\$2988**
7000WC6918L-24 - 24" x 18" x 69"H

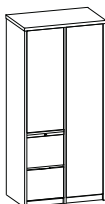

7000WSFFR__ right hand wardrobe (shown) **\$3968**
7000WSFFL__ left hand wardrobe
 Utility cabinet, wardrobe unit with hinged door (non-locking), top shelf, coat rod, file/file pedestal - bottom (locking), hinged door storage area (non-locking) with two adjustable shelves - top
 20" x 32" x 69"H (360 lbs)
 Optional locking doors (LK2) - add \$110 list
7000WSFFR-24 - 24" x 32" x 69"H **\$4188**
7000WSFFL-24 - 24" x 32" x 69"H

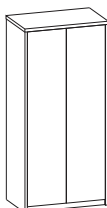

7000SC69__ **\$3337**
 Storage cabinet, hinged doors (non-locking), four adjustable shelves
 20" x 32" x 69"H (300 lbs)
 Optional locking doors (LK) - add \$55 list
7000SC69-24 - 24" x 32" x 69"H **\$3557**

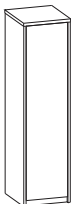

7000SC6918R__ hinged right **\$2715**
7000SC6918L__ hinged left
 Storage cabinet, non-locking left or right hinged door, four adjustable shelves
 20" x 18" x 69"H (155 lbs)
 Optional locking door (LK) - add \$55 list
7000SC6918R-24 - 24" x 18" x 69"H **\$2935**
7000SC6918L-24 - 24" x 18" x 69"H



7000LF/BCW__ **\$4332**
 Storage cabinet / Lateral file, upper hinged door storage (non-locking) with two adjustable shelves, bottom - two lateral file drawers (locking), legal or letter filing
 20" x 32" x 69"H (310 lbs)
 Optional locking doors (LK) - add \$55 list
7000LF/BCW-24 - 24" x 32" x 69"H **\$4574**

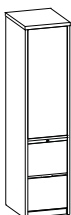

7000SCFF6918L__ hingedleft **\$2907**
7000SCFF6918R__ hingedright
 Utility cabinet, fi le/fi le pedestal - bottom (locking), hinged door storage area (non-locking) with two adjustable shelves - top (left hand hinged door shown)
 20" x 18" x 69"H (155 lbs)
 Optional locking door (LK) - add \$55 list
7000SCFF6918L-24 - 24" x 18" x 69"H **\$3127**
7000SCFF6918R-24 - 24" x 18" x 69"H

BASICS 3 SERIES

List Price

Computer Desk Workstations - Single Pedestal Desks

7000ECWS7242RFP_

Executive single pedestal computer desk (RH), box/box/file pedestal (locking), full modesty, 3" approach overhang, 42" corner unit, with two wire mgmt grommets in top 30"- 42" x 72" x 29"H (345 lbs)

\$2484

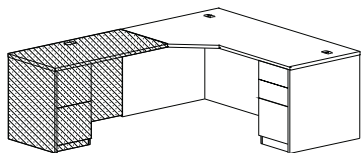

7000ECWS7236RFP_

Executive single pedestal computer desk (RH), box/box/file pedestal (locking), full modesty, 3" approach overhang, 36" corner unit, with two wire mgmt grommets in top 30"- 36" x 72" x 29"H (315 lbs)

\$2298

7000ECWS6636RFP_

Executive single pedestal computer desk (RH), box/box/file pedestal (locking), full modesty, 3" approach overhang, 36" corner unit, with two wire mgmt grommets in top 24"- 36" x 66" x 29"H (290 lbs)

\$2261

7000ECWS7242R_

Executive single pedestal computer desk (RH), box/file 3/4 pedestal (locking), full modesty, 3" approach overhang, 42" corner unit, with two wire mgmt grommets in top 30"- 42" x 72" x 29"H (330 lbs)

\$2285

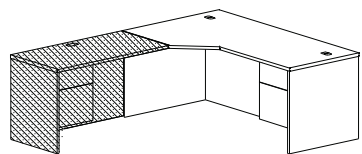

7000ECWS7236R_

Executive single pedestal computer desk (RH), box/file 3/4 pedestal (locking), full modesty, 3" approach overhang, 36" corner unit, with two wire mgmt grommets in top 30"- 36" x 72" x 29"H (300 lbs)

\$2089

7000ECWS6636R_

Executive single pedestal computer desk (RH), box/file 3/4 pedestal (locking), full modesty, 3" approach overhang, 36" corner unit, with two wire mgmt grommets in top 24"- 36" x 66" x 29"H (275 lbs)

\$2077

7000ECWSP76R_

Freestanding P-Top computer desk (RH), 36" diameter end, with 4" dia. black base, 42" corner unit, one wire mgmt grommet in top 30"-42" x 76" x 29"H (330 lbs)

\$1940

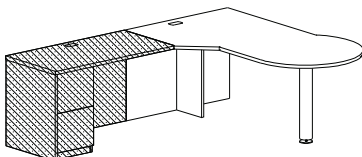

7000ECWSB76R_

Freestanding bullet top computer desk (RH), 30" diameter end, with 4" dia. black base, 42" corner unit, one wire mgmt grommet in top 30"-42" x 76" x 29"H (330 lbs)

\$1792

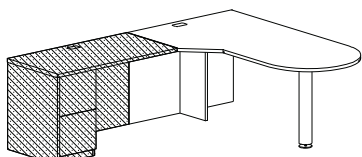

BASICS 3 SERIES

List Price

Computer Desk Workstations - Executive Returns

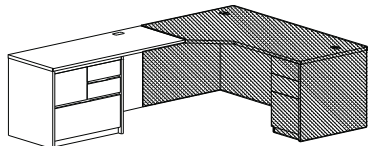

7000ERL72FC_ **\$2372**
 Executive height return (LH), file center pedestal (locking), two box, one file drawer top, one lateral file drawer bottom, one wire mgmt grommet, 42"W kneespace
 24" x 72" x 29"H (250 lbs)

7000ERL60FC_ **\$2242**
 Executive height return (LH), file center pedestal (locking), two box, one file drawer top, one lateral file drawer bottom, one wire mgmt grommet, 30"W kneespace
 24" x 60" x 29"H (220 lbs)

7000ERL54FC_ **\$2148**
 Executive height return (LH), file center pedestal (locking), two box, one file drawer top, one lateral file drawer bottom, one wire mgmt grommet, 24"W kneespace
 24" x 54" x 29"H (180 lbs)

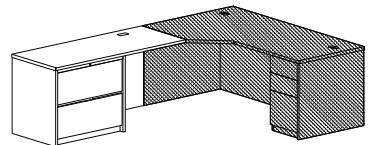

7000ERL72LF_ **\$2062**
 Executive height return (LH), two lateral file drawers (locking), one wire mgmt grommet, 42"W kneespace
 24" x 72" x 29"H (250 lbs)

7000ERL60LF_ **\$1932**
 Executive height return (LH), two lateral file drawers (locking), one wire mgmt grommet, 30"W kneespace
 24" x 60" x 29"H (230 lbs)

7000ERL54LF_ **\$1838**
 Executive height return (LH), two lateral file drawers (locking), one wire mgmt grommet, 24"W kneespace
 24" x 54" x 29"H (180 lbs)

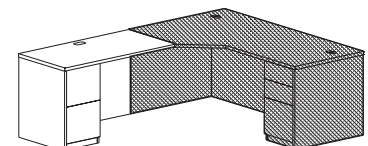

7000ERL48FP_ **\$1230**
 Executive height return (LH), file/file pedestal (locking), one wire mgmt grommet, 32"W kneespace
 24" x 48" x 29"H (175 lbs)



7000ERL42FP_ **\$1136**
 Executive height return (LH), file/file pedestal (locking), one wire mgmt grommet, 26"W kneespace
 24" x 42" x 29"H (165 lbs)

7000ERL36FP_ **\$1051**
 Executive height return (LH), file/file pedestal (locking), one wire mgmt grommet, 20"W kneespace
 24" x 36" x 29"H (155 lbs)

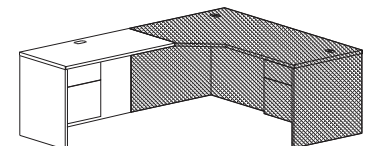

7000ERL48_ **\$1152**
 Executive height return (LH), box/file 3/4 pedestal (locking), one wire mgmt grommet, 32"W kneespace
 24" x 48" x 29"H (155 lbs)

7000ERL42_ **\$1058**
 Executive height return (LH), box/file 3/4 pedestal (locking), one wire mgmt grommet, 26"W kneespace
 24" x 42" x 29"H (130 lbs)

7000ERL36_ **\$968**
 Executive height return (LH), box/file 3/4 pedestal (locking), one wire mgmt grommet, 20"W kneespace
 24" x 36" x 29"H (120 lbs)

BASICS 3 SERIES

List Price

Computer Desk Workstations - Single Pedestal Desks

7000ECWS7242LFP_

\$2484

Executive single pedestal computer desk (LH), box/box/file pedestal (locking), full modesty, 3" approach overhang, 42" corner unit, with two wire mgmt grommets in top 30"- 42" x 72" x 29"H (345 lbs)

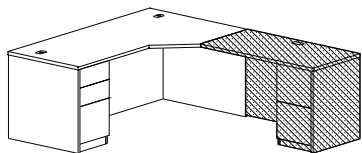

7000ECWS7236LFP_

\$2298

Executive single pedestal computer desk (LH), box/box/file pedestal (locking), full modesty, 3" approach overhang, 36" corner unit, with two wire mgmt grommets in top 30"- 36" x 72" x 29"H (315 lbs)

7000ECWS6636LFP_

\$2261

Executive single pedestal computer desk (LH), box/box/file pedestal (locking), full modesty, 3" approach overhang, 36" corner unit, with two wire mgmt grommets in top 24"- 36" x 66" x 29"H (290 lbs)

7000ECWS7242L_

\$2285

Executive single pedestal computer desk (LH), box/file 3/4 pedestal (locking), full modesty, 3" approach overhang, 42" corner unit, with two wire mgmt grommets in top 30"- 42" x 72" x 29"H (330 lbs)

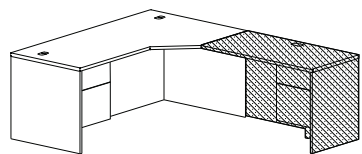

7000ECWS7236L_

\$2089

Executive single pedestal computer desk (LH), box/file 3/4 pedestal (locking), full modesty, 3" approach overhang, 36" corner unit, with two wire mgmt grommets in top 30"- 36" x 72" x 29"H (300 lbs)

7000ECWS6636L_

\$2077

Executive single pedestal computer desk (LH), box/file 3/4 pedestal (locking), full modesty, 3" approach overhang, 36" corner unit, with two wire mgmt grommets in top 24"- 36" x 66" x 29"H (275 lbs)

7000ECWSP76L_

\$1940

Freestanding P-Top computer desk (LH), 36" diameter end, with 4" dia. black base, 42" corner unit, one wire mgmt grommet in top (right) 30"-42" x 76" x 29"H (330 lbs)

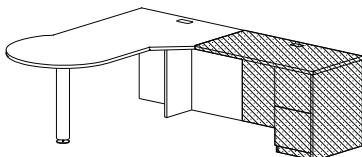

7000ECWSB76L_

\$1792

Freestanding bullet top computer desk (LH), 30" diameter end, with 4" dia. black base, 42" corner unit, one wire mgmt grommet in top (right) 30"-42" x 76" x 29"H (330 lbs)

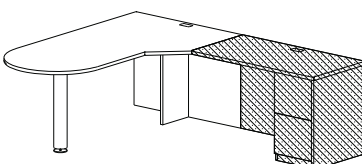

BASICS 3 SERIES

List Price





Computer Desk Workstations - Executive Returns

| | | |
|--|--|--|
| | <p>7000ERR72FC_ \$2372 Executive height return (RH), file center pedestal (locking), two box, one file drawer top, one lateral file drawer bottom, one wire mgmt grommet, 42"W kneespace 24" x 72" x 29"H (250 lbs)</p> | |
| | <p>7000ERR60FC_ \$2242 Executive height return (RH), file center pedestal (locking), two box, one file drawer top, one lateral file drawer bottom, one wire mgmt grommet, 30"W kneespace 24" x 60" x 29"H (220 lbs)</p> | |
| | <p>7000ERR54FC_ \$2148 Executive height return (RH), file center pedestal (locking), two box, one file drawer top, one lateral file drawer bottom, one wire mgmt grommet, 24"W kneespace 24" x 54" x 29"H (180 lbs)</p> | |
| | <p>7000ERR72LF_ \$2062 Executive height return (RH), two lateral file drawers (locking), one wire mgmt grommet, 42"W kneespace 24" x 72" x 29"H (250 lbs)</p> | |
| | <p>7000ERR60LF_ \$1932 Executive height return (RH), two lateral file drawers (locking), one wire mgmt grommet, 30"W kneespace 24" x 60" x 29"H (230 lbs)</p> | |
| | <p>7000ERR54LF_ \$1838 Executive height return (RH), two lateral file drawers (locking), one wire mgmt grommet, 24"W kneespace 24" x 54" x 29"H (180 lbs)</p> | |
| | <p>7000ERR48FP_ \$1230 Executive height return (RH), file/file pedestal (locking), one wire mgmt grommet, 32"W kneespace 24" x 48" x 29"H (175 lbs)</p> | |
| | <p>7000ERR42FP_ \$1136 Executive height return (RH), file/file pedestal (locking), one wire mgmt grommet, 26"W kneespace 24" x 42" x 29"H (165 lbs)</p> | |
| | <p>7000ERR36FP_ \$1051 Executive height return (RH), file/file pedestal (locking), one wire mgmt grommet, 20"W kneespace 24" x 36" x 29"H (155 lbs)</p> | |
| | <p>7000ERR48_ \$1152 Executive height return (RH), box/file 3/4 pedestal (locking), one wire mgmt grommet, 32"W kneespace 24" x 48" x 29"H (155 lbs)</p> | |
| | <p>7000ERR42_ \$1058 Executive height return (RH), box/file 3/4 pedestal (locking), one wire mgmt grommet, 26"W kneespace 24" x 42" x 29"H (130 lbs)</p> | |
| | <p>7000ERR36_ \$968 Executive height return (RH), box/file 3/4 pedestal (locking), one wire mgmt grommet, 20"W kneespace 24" x 36" x 29"H (120 lbs)</p> | |

BASICS 3 SERIES

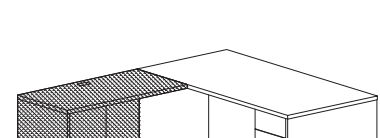
List Price

Executive Workstations - Single Pedestal Desks

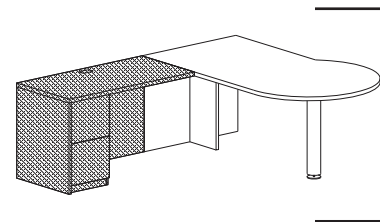
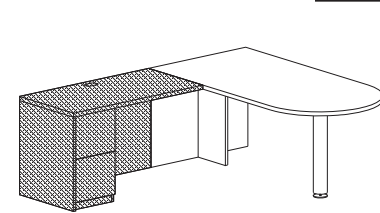
| | | | |
|--|--|--|--|
| | <p>7000KSPR7236FP_ \$2255 Executive single pedestal arc top desk (RH), with box/box/file pedestal (locking), full modesty, 6" approach overhang 36" x 72" x 29"H (290 lbs)</p> | | |
|  | <p>7000SPR72FP_ \$2292 Executive single pedestal desk (RH), with box/box/file pedestal (locking), full modesty, 6" approach overhang 36" x 72" x 29"H (295 lbs)</p> |  | |
| | <p>7000SPR66FP_ \$2066 Executive single pedestal desk (RH), with box/box/file pedestal (locking), full modesty, 3" approach overhang 30" x 66" x 29"H (255 lbs)</p> |  | |
| | <p>7000SPR60FP_ \$1878 Executive single pedestal desk (RH), with box/box/file pedestal (locking), full modesty, 3" approach overhang 10" w pedestal accommodates side-to-side letter or legal filing only. If freestanding option is specified, pedestal will be letter width. 30" x 60" x 29"H (195 lbs)</p> | | |
|  | <p>7000KSPR7236_ \$2050 Executive single pedestal arc top desk (RH), with box/file 3/4 pedestal (locking), full modesty, 6" approach overhang 36" x 72" x 29"H (270 lbs)</p> | | |
| | <p>7000SPR72_ \$2087 Executive single pedestal desk (RH), with box/file 3/4 pedestal (locking), full modesty, 6" approach overhang 36" x 72" x 29"H (275 lbs)</p> | | |
| | <p>7000SPR66_ \$1857 Executive single pedestal desk (RH), with box/file 3/4 pedestal (locking), full modesty, 3" approach overhang 30" x 66" x 29"H (235 lbs)</p> | | |
|  | <p>7000SPR60_ \$1659 Executive single pedestal desk (RH), with box/file 3/4 pedestal (locking), full modesty, 3" approach overhang 10" w pedestal accommodates side-to-side letter or legal filing only. If freestanding option is specified, pedestal will be letter width. 30" x 60" x 29"H (215 lbs)</p> | | |
| |  | <p>7000WSP72R_ \$1284 P-top top desk (RH), 42" radius, 4" dia. black base 36" x 72" x 29"H (160 lbs)</p> | |
| | | <p>7000WSB7236R_ \$1256 Bullet top desk (RH), 4" dia. black base 36" x 72" x 29"H (150 lbs)</p> | |
|  | <p>7000WSB7230R_ \$1036 Bullet top desk (RH), 4" dia. black base 30" x 72" x 29"H (145 lbs)</p> | | |
| | <p>7000WSB6630R_ \$1004 Bullet top desk (RH), 4" dia. black base 30" x 66" x 29"H (130 lbs)</p> | | |

BASICS 3 SERIES

List Price

Executive Workstations - Executive Returns

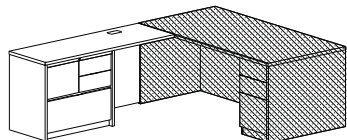

7000ERL72FC_ **\$2372**
 Executive height return (LH), file center pedestal (locking), two box, one file drawer top, one lateral file drawer bottom, one wire mgmt grommet, 42"W kneespace
 24" x 72" x 29"H (250 lbs)

7000ERL60FC_ **\$2242**
 Executive height return (LH), file center pedestal (locking), two box, one file drawer top, one lateral file drawer bottom, one wire mgmt grommet, 30"W kneespace
 24" x 60" x 29"H (220 lbs)

7000ERL54FC_ **\$2148**
 Executive height return (LH), file center pedestal (locking), two box, one file drawer top, one lateral file drawer bottom, one wire mgmt grommet, 24"W kneespace
 24" x 54" x 29"H (180 lbs)

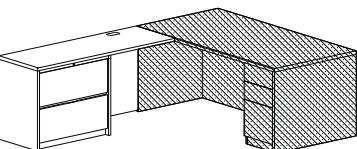

7000ERL72LF_ **\$2062**
 Executive height return (LH), two lateral file drawers (locking), one wire mgmt grommet, 42"W kneespace
 24" x 72" x 29"H (250 lbs)

7000ERL60LF_ **\$1932**
 Executive height return (LH), two lateral file drawers (locking), one wire mgmt grommet, 30"W kneespace
 24" x 60" x 29"H (230 lbs)

7000ERL54LF_ **\$1838**
 Executive height return (LH), two lateral file drawers (locking), one wire mgmt grommet, 24"W kneespace
 24" x 54" x 29"H (180 lbs)

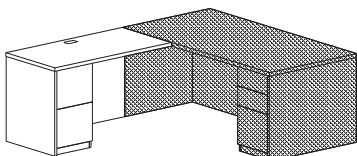

7000ERL48FP_ **\$1230**
 Executive height return (LH), file/file pedestal (locking), one wire mgmt grommet, 32"W kneespace
 24" x 48" x 29"H (175 lbs)



7000ERL42FP_ **\$1136**
 Executive height return (LH), file/file pedestal (locking), one wire mgmt grommet, 26"W kneespace
 24" x 42" x 29"H (165 lbs)

7000ERL36FP_ **\$1051**
 Executive height return (LH), file/file pedestal (locking), one wire mgmt grommet, 20"W kneespace
 24" x 36" x 29"H (155 lbs)

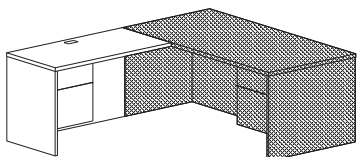

7000ERL48_ **\$1152**
 Executive height return (LH), box/file 3/4 pedestal (locking), one wire mgmt grommet, 32"W kneespace
 24" x 48" x 29"H (155 lbs)

7000ERL42_ **\$1058**
 Executive height return (LH), box/file 3/4 pedestal (locking), one wire mgmt grommet, 26"W kneespace
 24" x 42" x 29"H (130 lbs)

7000ERL36_ **\$968**
 Executive height return (LH), box/file 3/4 pedestal (locking), one wire mgmt grommet, 20"W kneespace
 24" x 36" x 29"H (120 lbs)

BASICS 3 SERIES

List Price

Executive Workstations - Single Pedestal Desks

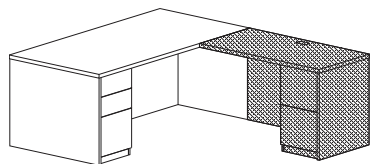

7000KSPL7236FP_ **\$2255**
 Executive single pedestal arc top desk (LH), with box/box/file pedestal (locking), full modesty,
 6" approach overhang
 36" x 72" x 29"H (290 lbs)

7000SPL72FP_ **\$2292**
 Executive single pedestal desk (LH), with box/box/file pedestal (locking), full modesty,
 6" approach overhang 
 36" x 72" x 29"H (295 lbs)

7000SPL66FP_ **\$2066**
 Executive single pedestal desk (LH), with box/box/file pedestal (locking), full modesty,
 3" approach overhang 
 30" x 66" x 29"H (255 lbs)

7000SPL60FP_ **\$1878**
 Executive single pedestal desk (LH), with box/box/file pedestal (locking), full modesty, 3" approach overhang
 10" w pedestal accommodates side-to-side letter or legal filing only. If freestanding option is specified, pedestal
 will be letter width.
 30" x 60" x 29"H (195 lbs)

7000KSPL7236_ **\$2050**
 Executive single pedestal arc top desk (LH), with box/file 3/4 pedestal (locking), full modesty,
 6" approach overhang
 36" x 72" x 29"H (270 lbs)

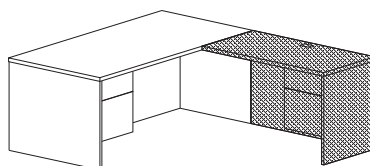

7000SPL72_ **\$2087**
 Executive single pedestal desk (LH), with box/file 3/4 pedestal (locking), full modesty,
 6" approach overhang
 36" x 72" x 29"H (275 lbs)

7000SPL66_ **\$1857**
 Executive single pedestal desk (LH), with box/file 3/4 pedestal (locking), full modesty,
 3" approach overhang
 30" x 66" x 29"H (235 lbs)

7000SPL60_ **\$1659**
 Executive single pedestal desk (LH), with box/file 3/4 pedestal (locking), full modesty, 3" approach overhang
 10" w pedestal accommodates side-to-side letter or legal filing only. If freestanding option is specified, pedestal
 will be letter width.
 30" x 60" x 29"H (215 lbs)

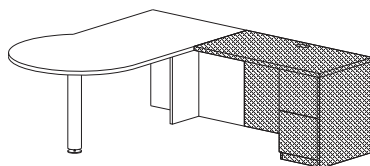

7000WSP72L_ **\$1284**
 P-top top desk (LH), 42" radius, 4" dia. black base
 36" x 72" x 29"H (160 lbs)

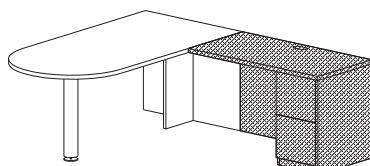

7000WSB7236L_ **\$1256**
 Bullet top desk (LH), 4" dia. black base
 36" x 72" x 29"H (150 lbs)

7000WSB7230L_ **\$1036**
 Bullet top desk (LH), 4" dia. black base
 30" x 72" x 29"H (145 lbs)

7000WSB6630L_ **\$1004**
 Bullet top desk (LH), 4" dia. black base
 30" x 66" x 29"H (130 lbs)

BASICS 3 SERIES

List Price

Executive Workstations - Executive Returns

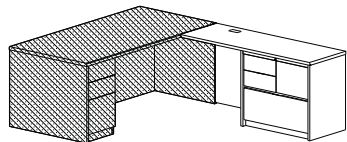

7000ERR72FC_ **\$2372**
 Executive height return (RH), file center pedestal (locking), two box, one file drawer top, one lateral file drawer bottom, one wire mgmt grommet, 42"W kneespace
 24" x 72" x 29"H (250 lbs)

7000ERR60FC_ **\$2242**
 Executive height return (RH), file center pedestal (locking), two box, one file drawer top, one lateral file drawer bottom, one wire mgmt grommet, 30"W kneespace
 24" x 60" x 29"H (220 lbs)

7000ERR54FC_ **\$2148**
 Executive height return (RH), file center pedestal (locking), two box, one file drawer top, one lateral file drawer bottom, one wire mgmt grommet, 24"W kneespace
 24" x 54" x 29"H (180 lbs)

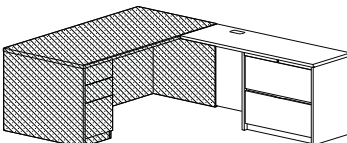

7000ERR72LF_ **\$2062**
 Executive height return (RH), two lateral file drawers (locking), one wire mgmt grommet, 42"W kneespace
 24" x 72" x 29"H (250 lbs)

7000ERR60LF_ **\$1932**
 Executive height return (RH), two lateral file drawers (locking), one wire mgmt grommet, 30"W kneespace
 24" x 60" x 29"H (230 lbs)

7000ERR54LF_ **\$1838**
 Executive height return (RH), two lateral file drawers (locking), one wire mgmt grommet, 24"W kneespace
 24" x 54" x 29"H (180 lbs)

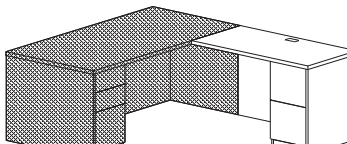

7000ERR48FP_ **\$1230**
 Executive height return (RH), file/file pedestal (locking), one wire mgmt grommet, 32"W kneespace
 24" x 48" x 29"H (175 lbs)



7000ERR42FP_ **\$1136**
 Executive height return (RH), file/file pedestal (locking), one wire mgmt grommet, 26"W kneespace
 24" x 42" x 29"H (165 lbs)

7000ERR36FP_ **\$1051**
 Executive height return (RH), file/file pedestal (locking), one wire mgmt grommet, 20"W kneespace
 24" x 36" x 29"H (155 lbs)

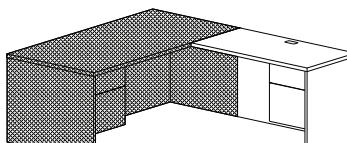

7000ERR48_ **\$1152**
 Executive height return (RH), box/file 3/4 pedestal (locking), one wire mgmt grommet, 32"W kneespace
 24" x 48" x 29"H (155 lbs)

7000ERR42_ **\$1058**
 Executive height return (RH), box/file 3/4 pedestal (locking), one wire mgmt grommet, 26"W kneespace
 24" x 42" x 29"H (130 lbs)

7000ERR36_ **\$968**
 Executive height return (RH), box/file 3/4 pedestal (locking), one wire mgmt grommet, 20"W kneespace
 24" x 36" x 29"H (120 lbs)

BASICS 3 SERIES

List Price

Computer Desk U Workstations - Single Pedestal Desks

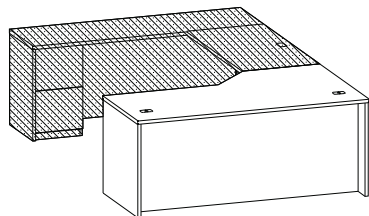

7000ECWS7242RFP_ **\$2484**
 Executive single pedestal computer desk (RH), box/box/file pedestal (locking), full modesty, 3" approach overhang, 42" corner unit, with two wire mgmt grommets
 30"- 42" x 72" x 29"H (345 lbs)

7000ECWS7236RFP_ **\$2298**
 Executive single pedestal computer desk (RH), box/box/file pedestal (locking), full modesty, 3" approach overhang, 36" corner unit, with two wire mgmt grommets
 30"- 36" x 72" x 29"H (315 lbs)

7000ECWS6636RFP_ **\$2261**
 Executive single pedestal computer desk (RH), box/box/file pedestal (locking), full modesty, 3" approach overhang, 36" corner unit, with two wire mgmt grommets
 24"- 36" x 66" x 29"H (290 lbs)

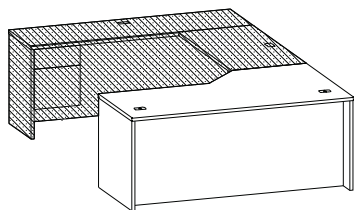

7000ECWS7242R_ **\$2285**
 Executive single pedestal computer desk (RH), box/file 3/4 pedestal (locking), full modesty, 3" approach overhang, 42" corner unit, with two wire mgmt grommets
 30"- 42" x 72" x 29"H (330 lbs)

7000ECWS7236R_ **\$2089**
 Executive single pedestal computer desk (RH), box/file 3/4 pedestal (locking), full modesty, 3" approach overhang, 36" corner unit, with two wire mgmt grommets
 30"- 36" x 72" x 29"H (300 lbs)

7000ECWS6636R_ **\$2077**
 Executive single pedestal computer desk (RH), box/file 3/4 pedestal (locking), full modesty, 3" approach overhang, 36" corner unit, with two wire mgmt grommets
 24"- 36" x 66" x 29"H (275 lbs)

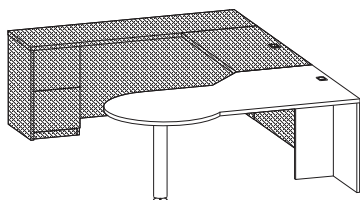

7000ECWSP76R_ **\$1940**
 Freestanding P-Top computer desk (RH), 36" diameter end, with 4" dia. black base, 42" corner unit, one wire mgmt grommet in top (left)
 30"-42" x 76" x 29"H (330 lbs)

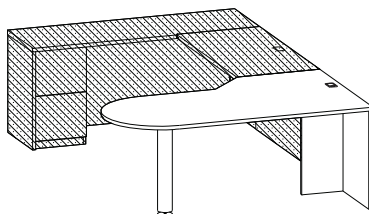

7000ECWSB76R_ **\$1792**
 Freestanding bullet top computer desk (RH), 30" diameter end, with 4" dia. black base, 42" corner unit, one wire mgmt grommet in top (left)
 30"-42" x 76" x 29"H (330 lbs)

BASICS 3 SERIES

List Price

Computer Desk U Workstations - Connecting Bridges

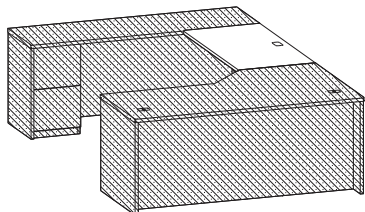

| | |
|---|--------------|
| 7000WS54_ Executive height bridge, full modesty panel, one computer grommet 24" x 54" x 29"H (105 lbs) | \$738 |
| 7000WS54TO_ Bridge Top only | \$363 |
| 7000WS48_ Executive height bridge, full modesty panel, one computer grommet 24" x 48" x 29"H (95 lbs) | \$664 |
| 7000WS48TO_ Bridge Top only | \$340 |
| 7000WS42_ Executive height bridge, full modesty panel, one computer grommet 24" x 42" x 29"H (85 lbs) | \$582 |
| 7000WS42TO_ Bridge Top only | \$323 |
| 7000WS36_ Executive height bridge, full modesty panel, one computer grommet 24" x 36" x 29"H (75 lbs) | \$519 |
| 7000WS36TO_ Bridge Top only | \$303 |



Computer Desk U Workstations - Single Pedestal Credenzas

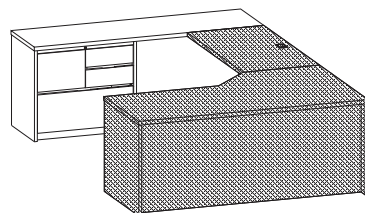

| | |
|---|---------------|
| 7000DCSPL72FC_ Single pedestal credenza (LH), file center pedestal (locking), two box, one file drawer top, one lateral file drawer bottom, one wire mgmt grommet, 39"W kneespace 20" x 72" x 29"H (270 lbs) | \$2248 |
| 7000DCSPL72FC-24 - 24" x 72" x 29"H | \$2644 |
| 7000DCSPL66FC_ Single pedestal credenza (LH), file center pedestal (locking), two box, one file drawer top, one lateral file drawer bottom, one wire mgmt grommet, 33"W kneespace 20" x 66" x 29"H (230 lbs) | \$2221 |
| 7000DCSPL66FC-24 - 24" x 66" x 29"H | \$2584 |

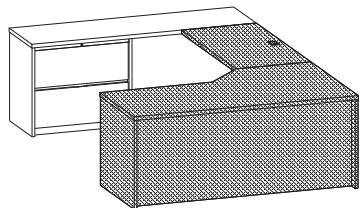

| | |
|---|---------------|
| 7000DCSPL72LF_ Single pedestal credenza (LH), two lateral file drawers (locking), legal or letter filing, one wire mgmt grommet in back panel, 39"W kneespace 20" x 72" x 29"H (250 lbs) | \$2050 |
| 7000DCSPL72LF-24 - 24" x 72" x 29"H | \$2446 |
| 7000DCSPL66LF_ Single pedestal credenza (LH), two lateral file drawers (locking), legal or letter filing, one wire mgmt grommet in back panel, 33"W kneespace 20" x 66" x 29"H (215 lbs) | \$2023 |
| 7000DCSPL66LF-24 - 24" x 66" x 29"H | \$2386 |

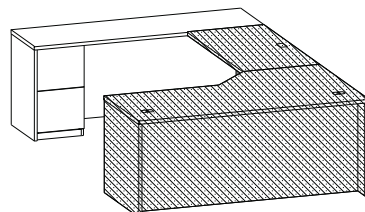

| | |
|---|---------------|
| 7000DCSPL72FP_ Single pedestal credenza (LH), file/file pedestal (locking), one wire mgmt grommet in back panel, 55"W kneespace 20" x 72" x 29"H (240 lbs) | \$1746 |
| 7000DCSPL72FP-24 - 24" x 72" x 29"H | \$2142 |
| 7000DCSPL66FP_ Single pedestal credenza (LH), file/file pedestal (locking), one wire mgmt grommet in back panel, 49"W kneespace 20" x 66" x 29"H (205 lbs) | \$1679 |
| 7000DCSPL66FP-24 - 24" x 66" x 29"H | \$2042 |
| 7000DCSPL60FP_ Single pedestal credenza (LH), file/file pedestal (locking), one wire mgmt grommet in back panel, 41"W kneespace 20" x 60" x 29"H (195 lbs) | \$1585 |
| 7000DCSPL60FP-24 - 24" x 60" x 29"H | \$1915 |



BASICS 3 SERIES

List Price

Computer Desk U Workstations - Single Pedestal Desks

7000ECWS7242LFP_ **\$2484**
 Executive single pedestal computer desk (LH), box/box/file pedestal (locking), full modesty, 3" approach overhang, 42" corner unit, with two wire mgmt grommets
 30"- 42" x 72" x 29"H (345 lbs)

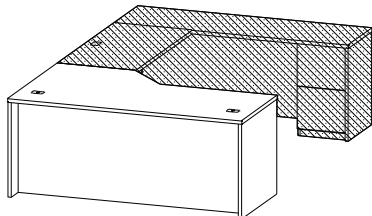

7000ECWS7236LFP_ **\$2298**
 Executive single pedestal computer desk (LH), box/box/file pedestal (locking), full modesty, 3" approach overhang, 36" corner unit, with two wire mgmt grommets
 30"- 36" x 72" x 29"H (315 lbs)

7000ECWS6636LFP_ **\$2261**
 Executive single pedestal computer desk (LH), box/box/file pedestal (locking), full modesty, 3" approach overhang, 36" corner unit, with two wire mgmt grommets
 24"- 36" x 66" x 29"H (290 lbs)

7000ECWS7242L_ **\$2285**
 Executive single pedestal computer desk (LH), box/file 3/4 pedestal (locking), full modesty, 3" approach overhang, 42" corner unit, with two wire mgmt grommets
 30"- 42" x 72" x 29"H (330 lbs)

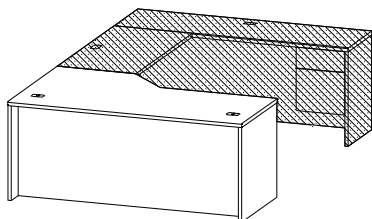

7000ECWS7236L_ **\$2089**
 Executive single pedestal computer desk (LH), box/file 3/4 pedestal (locking), full modesty, 3" approach overhang, 36" corner unit, with two wire mgmt grommets
 30"- 36" x 72" x 29"H (300 lbs)

7000ECWS6636L_ **\$2077**
 Executive single pedestal computer desk (LH), box/file 3/4 pedestal (locking), full modesty, 3" approach overhang, 36" corner unit, with two wire mgmt grommets
 24"- 36" x 66" x 29"H (275 lbs)

7000ECWSP76L_ **\$1940**
 Freestanding P-Top computer desk (LH), 36" diameter end, with 4" dia. black base, 42" corner unit, one wire mgmt grommet in top (right)
 30"-42" x 76" x 29"H (330 lbs)

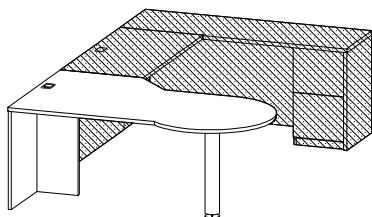

7000ECWSB76L_ **\$1792**
 Freestanding bullet top computer desk (LH), 30" diameter end, with 4" dia. black base, 42" corner unit, one wire mgmt grommet in top (right)
 30"-42" x 76" x 29"H (330 lbs)

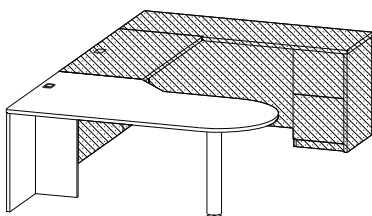

BASICS 3 SERIES

List Price

Computer Desk U Workstations - Connecting Bridges

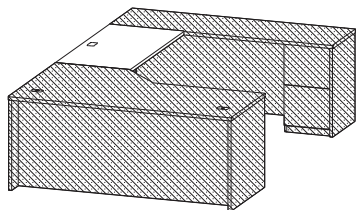

| | |
|---|-------|
| 7000WS54_ Executive height bridge, full modesty panel, one computer grommet 24" x 54" x 29"H (105 lbs) | \$738 |
| 7000WS54TO_ Bridge Top only | \$363 |
| 7000WS48_ Executive height bridge, full modesty panel, one computer grommet 24" x 48" x 29"H (95 lbs) | \$664 |
| 7000WS48TO_ Bridge Top only | \$340 |
| 7000WS42_ Executive height bridge, full modesty panel, one computer grommet 24" x 42" x 29"H (85 lbs) | \$582 |
| 7000WS42TO_ Bridge Top only | \$323 |
| 7000WS36_ Executive height bridge, full modesty panel, one computer grommet 24" x 36" x 29"H (75 lbs) | \$519 |
| 7000WS36TO_ Bridge Top only | \$303 |



Computer Desk U Workstations - Single Pedestal Credenzas

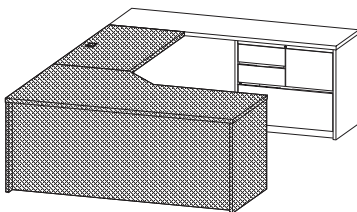

| | |
|---|--------|
| 7000DCSPR72FC_ Single pedestal credenza (RH), file center pedestal (locking), two box, one file drawer top, one lateral file drawer bottom, one wire mgmt grommet, 39"W kneespace 20" x 72" x 29"H (270 lbs) | \$2248 |
| 7000DCSPR72FC-24 - 24" x 72" x 29"H | \$2644 |
| 7000DCSPR66FC_ Single pedestal credenza (RH), file center pedestal (locking), two box, one file drawer top, one lateral file drawer bottom, one wire mgmt grommet, 33"W kneespace 20" x 66" x 29"H (230 lbs) | \$2221 |
| 7000DCSPR66FC-24 - 24" x 66" x 29"H | \$2584 |

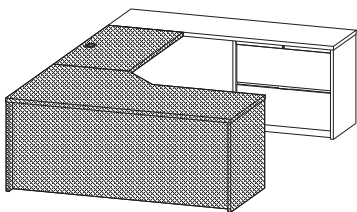

| | |
|---|--------|
| 7000DCSPR72LF_ Single pedestal credenza (RH), two lateral file drawers (locking), legal or letter filing, one wire mgmt grommet in back panel, 39"W kneespace 20" x 72" x 29"H (250 lbs) | \$2050 |
| 7000DCSPR72LF-24 - 24" x 72" x 29"H | \$2446 |
| 7000DCSPR66LF_ Single pedestal credenza (RH), two lateral file drawers (locking), legal or letter filing, one wire mgmt grommet in back panel, 33"W kneespace 20" x 66" x 29"H (215 lbs) | \$2023 |
| 7000DCSPR66LF-24 - 24" x 66" x 29"H | \$2386 |

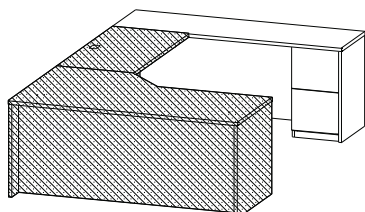

| | |
|---|--------|
| 7000DCSPR72FP_ Single pedestal credenza (RH), file/file pedestal (locking), one wire mgmt grommet in back panel, 55"W kneespace 20" x 72" x 29"H (240 lbs) | \$1746 |
| 7000DCSPR72FP-24 - 24" x 72" x 29"H | \$2142 |
| 7000DCSPR66FP_ Single pedestal credenza (RH), file/file pedestal (locking), one wire mgmt grommet in back panel, 49"W kneespace 20" x 66" x 29"H (205 lbs) | \$1679 |
| 7000DCSPR66FP-24 - 24" x 66" x 29"H | \$2042 |
| 7000DCSPR60FP_ Single pedestal credenza (RH), file/file pedestal (locking), one wire mgmt grommet in back panel, 41"W kneespace 20" x 60" x 29"H (195 lbs) | \$1585 |
| 7000DCSPR60FP-24 - 24" x 60" x 29"H | \$1915 |



BASICS 3 SERIES

List Price

U Configurations - Single Pedestal Desks

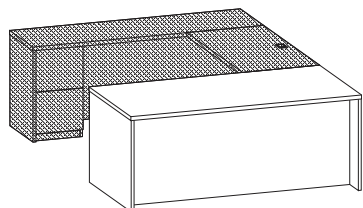

7000KSPR7236FP_ **\$2255**
 Executive single pedestal arc top desk (RH), with box/box/file pedestal (locking), full modesty,
 6" approach overhang
 36" x 72" x 29"H (290 lbs)

7000SPR72FP_ **\$2292**
 Executive single pedestal desk (RH), with box/box/file pedestal (locking), full modesty,
 6" approach overhang
 36" x 72" x 29"H (295 lbs)

7000SPR66FP_ **\$2066**
 Executive single pedestal desk (RH), with box/box/file pedestal (locking), full modesty,
 3" approach overhang
 30" x 66" x 29"H (255 lbs)

7000SPR60FP_ **\$1878**
 Executive single pedestal desk (RH), with box/box/file pedestal (locking), full modesty, 3" approach overhang
 10" w pedestal accommodates side-to-side letter or legal filing only. If freestanding option is specified, pedestal
 will be letter width.
 30" x 60" x 29"H (195 lbs)

7000KSPR7236_ **\$2050**
 Executive single pedestal arc top desk (RH), with box/file 3/4 pedestal (locking), full modesty,
 6" approach overhang
 36" x 72" x 29"H (270 lbs)

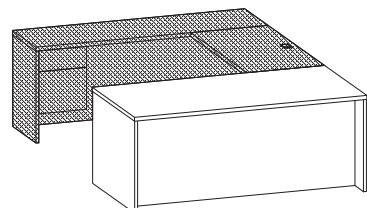

7000SPR72_ **\$2087**
 Executive single pedestal desk (RH), with box/file 3/4 pedestal (locking), full modesty,
 6" approach overhang
 36" x 72" x 29"H (275 lbs)

7000SPR66_ **\$1857**
 Executive single pedestal desk (RH), with box/file 3/4 pedestal (locking), full modesty,
 3" approach overhang
 30" x 66" x 29"H (235 lbs)

7000SPR60_ **\$1659**
 Executive single pedestal desk (RH), with box/file 3/4 pedestal (locking), full modesty, 3" approach overhang
 10" w pedestal accommodates side-to-side letter or legal filing only. If freestanding option is specified, pedestal
 will be letter width.
 30" x 60" x 29"H (215 lbs)

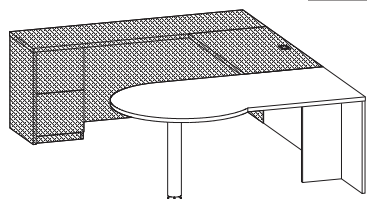

7000WSP72R_ **\$1284**
 P-top top desk (RH), 42" radius, 4" dia. black base
 36" x 72" x 29"H (160 lbs)

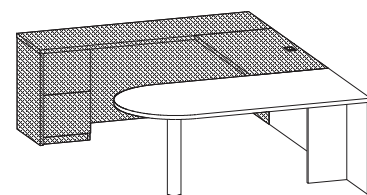

7000WSB7236R_ **\$1256**
 Bullet top desk (RH), 4" dia. black base
 36" x 72" x 29"H (150 lbs)

7000WSB7230R_ **\$1036**
 Bullet top desk (RH), 4" dia. black base
 30" x 72" x 29"H (145 lbs)

7000WSB6630R_ **\$1004**
 Bullet top desk (RH), 4" dia. black base
 30" x 66" x 29"H (130 lbs)

BASICS 3 SERIES

List Price

U Configurations - Connecting Bridges

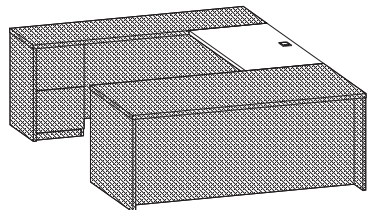

| | | |
|--------------------|---|-------|
| 7000WS54_ | Executive height bridge, full modesty panel, one computer grommet 24" x 54" x 29"H (105 lbs) | \$738 |
| 7000WS54TO_ | Bridge Top only | \$363 |
| 7000WS48_ | Executive height bridge, full modesty panel, one computer grommet 24" x 48" x 29"H (95 lbs) | \$664 |
| 7000WS48TO_ | Bridge Top only | \$340 |
| 7000WS42_ | Executive height bridge, full modesty panel, one computer grommet 24" x 42" x 29"H (85 lbs) | \$582 |
| 7000WS42TO_ | Bridge Top only | \$323 |
| 7000WS36_ | Executive height bridge, full modesty panel, one computer grommet 24" x 36" x 29"H (75 lbs) | \$519 |
| 7000WS36TO_ | Bridge Top only | \$303 |



U Configurations - Single Pedestal Credenzas

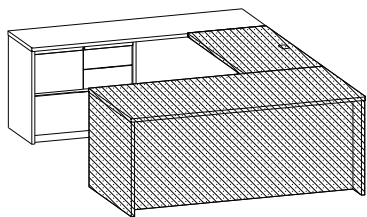

| | | |
|-------------------------|--|--------|
| 7000DCSPL72FC_ | Single pedestal credenza (LH), file center pedestal (locking), two box, one file drawer top, one lateral file drawer bottom, one wire mgmt grommet, 39"W kneespace 20" x 72" x 29"H (270 lbs) | \$2248 |
| 7000DCSPL72FC-24 | - 24" x 72" x 29"H | \$2644 |
| 7000DCSPL66FC_ | Single pedestal credenza (LH), file center pedestal (locking), two box, one file drawer top, one lateral file drawer bottom, one wire mgmt grommet, 33"W kneespace 20" x 66" x 29"H (230 lbs) | \$2221 |
| 7000DCSPL66FC-24 | - 24" x 66" x 29"H | \$2584 |

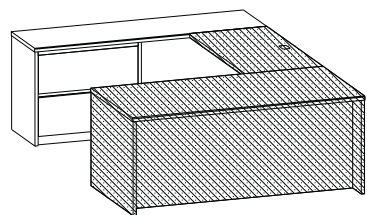

| | | |
|-------------------------|--|--------|
| 7000DCSPL72LF_ | Single pedestal credenza (LH), two lateral file drawers (locking), legal or letter filing, one wire mgmt grommet in back panel, 39"W kneespace 20" x 72" x 29"H (250 lbs) | \$2050 |
| 7000DCSPL72LF-24 | - 24" x 72" x 29"H | \$2446 |
| 7000DCSPL66LF_ | Single pedestal credenza (LH), two lateral file drawers (locking), legal or letter filing, one wire mgmt grommet in back panel, 33"W kneespace 20" x 66" x 29"H (215 lbs) | \$2023 |
| 7000DCSPL66LF-24 | - 24" x 66" x 29"H | \$2386 |

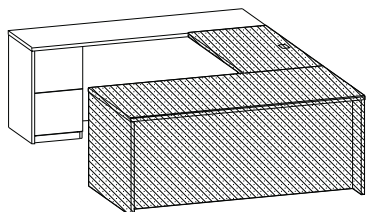

| | | |
|-------------------------|--|--------|
| 7000DCSPL72FP_ | Single pedestal credenza (LH), file/file pedestal (locking), one wire mgmt grommet in back panel, 55"W kneespace 20" x 72" x 29"H (240 lbs) | \$1746 |
| 7000DCSPL72FP-24 | - 24" x 72" x 29"H | \$2142 |



| | | |
|-------------------------|--|--------|
| 7000DCSPL66FP_ | Single pedestal credenza (LH), file/file pedestal (locking), one wire mgmt grommet in back panel, 49"W kneespace 20" x 66" x 29"H (205 lbs) | \$1679 |
| 7000DCSPL66FP-24 | - 24" x 66" x 29"H | \$2042 |



| | | |
|-------------------------|--|--------|
| 7000DCSPL60FP_ | Single pedestal credenza (LH), file/file pedestal (locking), one wire mgmt grommet in back panel, 41"W kneespace 20" x 60" x 29"H (195 lbs) | \$1585 |
| 7000DCSPL60FP-24 | - 24" x 60" x 29"H | \$1915 |

BASICS 3 SERIES

List Price

U Configurations - Single Pedestal Desks

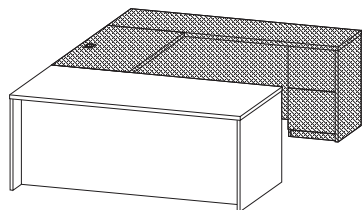

7000KSPL7236FP_ \$2255
 Executive single pedestal arc top desk (LH), with box/box/file pedestal (locking), full modesty, 6" approach overhang
 36" x 72" x 29"H (290 lbs)

7000SPL72FP_ \$2292
 Executive single pedestal desk (LH), with box/box/file pedestal (locking), full modesty, 6" approach overhang
 36" x 72" x 29"H (295 lbs)

7000SPL66FP_ \$2066
 Executive single pedestal desk (LH), with box/box/file pedestal (locking), full modesty, 3" approach overhang
 30" x 66" x 29"H (255 lbs)

7000SPL60FP_ \$1878
 Executive single pedestal desk (LH), with box/box/file pedestal (locking), full modesty, 3" approach overhang
 10" w pedestal accommodates side-to-side letter or legal filing only. If freestanding option is specified, pedestal will be letter width.
 30" x 60" x 29"H (195 lbs)

7000KSPL7236_ \$2050
 Executive single pedestal arc top desk (LH), with box/file 3/4 pedestal (locking), full modesty, 6" approach overhang
 36" x 72" x 29"H (270 lbs)

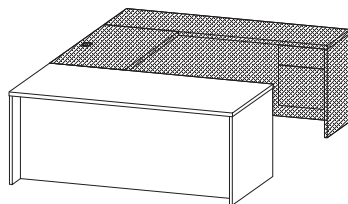

7000SPL72_ \$2087
 Executive single pedestal desk (LH), with box/file 3/4 pedestal (locking), full modesty, 6" approach overhang
 36" x 72" x 29"H (275 lbs)

7000SPL66_ \$1857
 Executive single pedestal desk (LH), with box/file 3/4 pedestal (locking), full modesty, 3" approach overhang
 30" x 66" x 29"H (235 lbs)

7000SPL60_ \$1659
 Executive single pedestal desk (LH), with box/file 3/4 pedestal (locking), full modesty, 3" approach overhang
 10" w pedestal accommodates side-to-side letter or legal filing only. If freestanding option is specified, pedestal will be letter width.
 30" x 60" x 29"H (215 lbs)

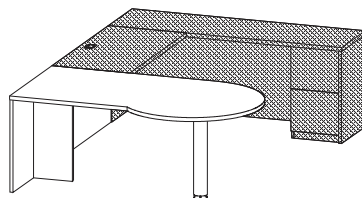

7000WSP72L_ \$1284
 P-top top desk (LH), 42" radius, 4" dia. black base
 36" x 72" x 29"H (160 lbs)

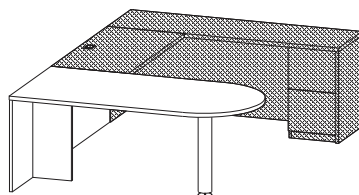

7000WSB7236L_ \$1256
 Bullet top desk (LH), 4" dia. black base
 36" x 72" x 29"H (150 lbs)

7000WSB7230L_ \$1036
 Bullet top desk (LH), 4" dia. black base
 30" x 72" x 29"H (145 lbs)

7000WSB6630L_ \$1004
 Bullet top desk (LH), 4" dia. black base
 30" x 66" x 29"H (130 lbs)

BASICS 3 SERIES

List Price

U Configurations - Connecting Bridges

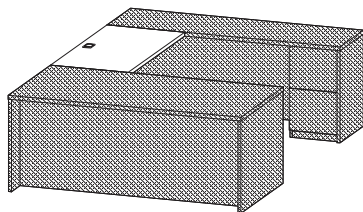

| | | |
|--------------------|---|-------|
| 7000WS54_ | Executive height bridge, full modesty panel, one computer grommet 24" x 54" x 29"H (105 lbs) | \$738 |
| 7000WS54TO_ | Bridge Top only | \$363 |
| 7000WS48_ | Executive height bridge, full modesty panel, one computer grommet 24" x 48" x 29"H (95 lbs) | \$664 |
| 7000WS48TO_ | Bridge Top only | \$340 |
| 7000WS42_ | Executive height bridge, full modesty panel, one computer grommet 24" x 42" x 29"H (85 lbs) | \$582 |
| 7000WS42TO_ | Bridge Top only | \$323 |
| 7000WS36_ | Executive height bridge, full modesty panel, one computer grommet 24" x 36" x 29"H (75 lbs) | \$519 |
| 7000WS36TO_ | Bridge Top only | \$303 |



U Configurations - Single Pedestal Credenzas

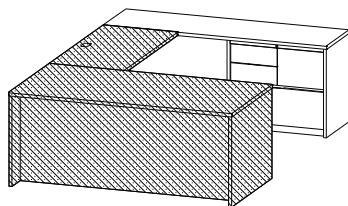

| | | |
|-------------------------|--|--------|
| 7000DCSPR72FC_ | Single pedestal credenza (RH), file center pedestal (locking), two box, one file drawer top, one lateral file drawer bottom, one wire mgmt grommet, 39"W kneespace 20" x 72" x 29"H (270 lbs) | \$2248 |
| 7000DCSPR72FC-24 | - 24" x 72" x 29"H | \$2644 |
| 7000DCSPR66FC_ | Single pedestal credenza (RH), file center pedestal (locking), two box, one file drawer top, one lateral file drawer bottom, one wire mgmt grommet, 33"W kneespace 20" x 66" x 29"H (230 lbs) | \$2221 |
| 7000DCSPR66FC-24 | - 24" x 66" x 29"H | \$2584 |

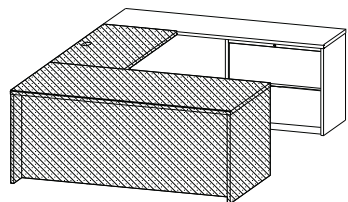

| | | |
|-------------------------|--|--------|
| 7000DCSPR72LF_ | Single pedestal credenza (RH), two lateral file drawers (locking), legal or letter filing, one wire mgmt grommet in back panel, 39"W kneespace 20" x 72" x 29"H (250 lbs) | \$2050 |
| 7000DCSPR72LF-24 | - 24" x 72" x 29"H | \$2446 |
| 7000DCSPR66LF_ | Single pedestal credenza (RH), two lateral file drawers (locking), legal or letter filing, one wire mgmt grommet in back panel, 33"W kneespace 20" x 66" x 29"H (215 lbs) | \$2023 |
| 7000DCSPR66LF-24 | - 24" x 66" x 29"H | \$2386 |

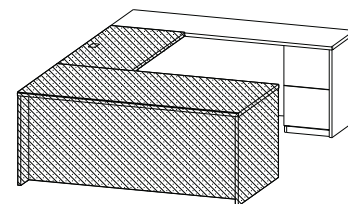

| | | |
|-------------------------|--|--------|
| 7000DCSPR72FP_ | Single pedestal credenza (RH), file/file pedestal (locking), one wire mgmt grommet in back panel, 55"W kneespace 20" x 72" x 29"H (240 lbs) | \$1746 |
| 7000DCSPR72FP-24 | - 24" x 72" x 29"H | \$2142 |
| 7000DCSPR66FP_ | Single pedestal credenza (RH), file/file pedestal (locking), one wire mgmt grommet in back panel, 49"W kneespace 20" x 66" x 29"H (205 lbs) | \$1679 |
| 7000DCSPR66FP-24 | - 24" x 66" x 29"H | \$2042 |
| 7000DCSPR60FP_ | Single pedestal credenza (RH), file/file pedestal (locking), one wire mgmt grommet in back panel, 41"W kneespace 20" x 60" x 29"H (195 lbs) | \$1585 |
| 7000DCSPR60FP-24 | - 24" x 60" x 29"H | \$1915 |



BASICS 3 SERIES

List Price

Corner Configurations - Connecting Corners

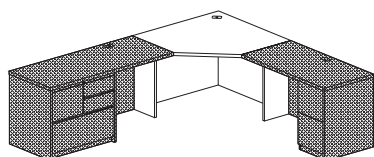

7000CWS42_ \$1785
 Corner unit - 42", one computer grommet
 42" x 42" x 29"H (150 lbs)

7000CWS36_ \$1654
 Corner unit - 36", one computer grommet
 36" x 36" x 29"H (120 lbs)

Corner Configurations - Connecting Units

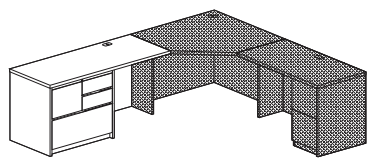

7000ERL60FC_ \$2242
 Executive height return (LH), file center pedestal (locking), two box, one file drawer top, one lateral file drawer bottom, one wire mgmt grommet, 30"W kneespace
 24" x 60" x 29"H (220 lbs)

7000ERL54FC_ \$2148
 Executive height return (LH), file center pedestal (locking), two box, one file drawer top, one lateral file drawer bottom, one wire mgmt grommet, 24"W kneespace
 24" x 54" x 29"H (180 lbs)

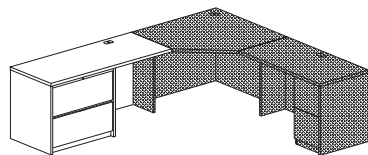

7000ERL60LF_ \$1932
 Executive height return (LH), two lateral file drawers (locking), one wire mgmt grommet, 30"W kneespace
 24" x 60" x 29"H (230 lbs)

7000ERL54LF_ \$1838
 Executive height return (LH), two lateral file drawers (locking), one wire mgmt grommet, 24"W kneespace
 24" x 54" x 29"H (180 lbs)

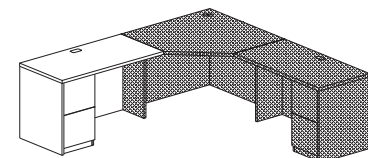

7000ERL48FP_ \$1230
 Executive height return (LH), file/file pedestal (locking), one wire mgmt grommet, 32"W kneespace
 24" x 48" x 29"H (175 lbs)



7000ERL42FP_ \$1136
 Executive height return (LH), file/file pedestal (locking), one wire mgmt grommet, 26"W kneespace
 24" x 42" x 29"H (165 lbs)

7000ERL36FP_ \$1051
 Executive height return (LH), file/file pedestal (locking), one wire mgmt grommet, 20"W kneespace
 24" x 36" x 29"H (155 lbs)

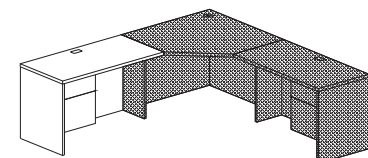

7000ERL48_ \$1152
 Executive height return (LH), box/file 3/4 pedestal (locking), one wire mgmt grommet, 32"W kneespace
 24" x 48" x 29"H (155 lbs)

7000ERL42_ \$1058
 Executive height return (LH), box/file 3/4 pedestal (locking), one wire mgmt grommet, 26"W kneespace
 24" x 42" x 29"H (130 lbs)

7000ERL36_ \$968
 Executive height return (LH), box/file 3/4 pedestal (locking), one wire mgmt grommet, 20"W kneespace
 24" x 36" x 29"H (120 lbs)

BASICS 3 SERIES

List Price

Corner Configurations - Connecting Corners

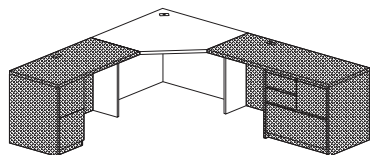

7000CWS42_ \$1785
 Corner unit - 42", one computer grommet
 42" x 42" x 29"H (150 lbs)

7000CWS36_ \$1654
 Corner unit - 36", one computer grommet
 36" x 36" x 29"H (120 lbs)

Corner Configurations - Connecting Units

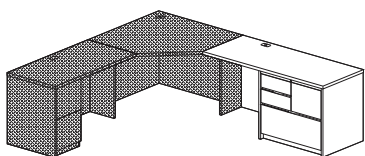

7000ERR60FC_ \$2242
 Executive height return (RH), file center pedestal (locking), two box, one file drawer top, one lateral file drawer bottom, one wire mgmt grommet, 30"W kneespace
 24" x 60" x 29"H (220 lbs)

7000ERR54FC_ \$2148
 Executive height return (RH), file center pedestal (locking), two box, one file drawer top, one lateral file drawer bottom, one wire mgmt grommet, 24"W kneespace
 24" x 54" x 29"H (180 lbs)

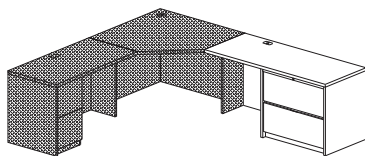

7000ERR60LF_ \$1932
 Executive height return (RH), two lateral file drawers (locking), one wire mgmt grommet, 30"W kneespace
 24" x 60" x 29"H (230 lbs)

7000ERR54LF_ \$1838
 Executive height return (RH), two lateral file drawers (locking), one wire mgmt grommet, 24"W kneespace
 24" x 54" x 29"H (180 lbs)

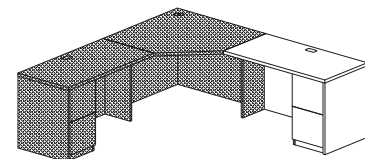

7000ERR48FP_ \$1230
 Executive height return (RH), file/file pedestal (locking), one wire mgmt grommet, 32"W kneespace
 24" x 48" x 29"H (175 lbs)



7000ERR42FP_ \$1136
 Executive height return (RH), file/file pedestal (locking), one wire mgmt grommet, 26"W kneespace
 24" x 42" x 29"H (165 lbs)

7000ERR36FP_ \$1051
 Executive height return (RH), file/file pedestal (locking), one wire mgmt grommet, 20"W kneespace
 24" x 36" x 29"H (155 lbs)

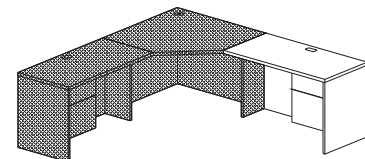

7000ERR48_ \$1152
 Executive height return (RH), box/file 3/4 pedestal (locking), one wire mgmt grommet, 32"W kneespace
 24" x 48" x 29"H (155 lbs)

7000ERR42_ \$1058
 Executive height return (RH), box/file 3/4 pedestal (locking), one wire mgmt grommet, 26"W kneespace
 24" x 42" x 29"H (130 lbs)

7000ERR36_ \$968
 Executive height return (RH), box/file 3/4 pedestal (locking), one wire mgmt grommet, 20"W kneespace
 24" x 36" x 29"H (120 lbs)

BASICS 3 SERIES

List Price

Overhead Storage Units

7000HC84_ **\$2517**

Overhead storage unit with hinged wood doors, two storage areas behind four hinged doors (non-locking), two wire mgmt access grommets in center back panel
 22 3/4" clearance between apron rail & worksurface
 16" x 84" x 39"H (250 lbs)
 Optional Open Storage - no doors (ND) - no price upcharge
 Optional Metallic Frosted Plexiglass doors (MFPD) - add \$759 list
 Optional Clear Glass doors (CGD) - add \$539 list - locks not available
 *Optional pull not available

7000HC78_ **\$2320**

Overhead storage unit with hinged wood doors, two storage areas behind four hinged doors (non-locking), two wire mgmt access grommets in center back panel
 22 3/4" clearance between apron rail & worksurface
 16" x 78" x 39"H (230 lbs)
 Optional Open Storage - no doors (ND) - no price upcharge
 Optional Metallic Frosted Plexiglass doors (MFPD) - add \$759 list
 Optional Clear Glass doors (CGD) - add \$539 list - locks not available
 *Optional pull not available

7000HC72_ **\$2125**

Overhead storage unit with hinged wood doors, two storage areas behind four hinged doors (non-locking), two wire mgmt access grommets in center back panel
 22 3/4" clearance between apron rail & worksurface
 16" x 72" x 39"H (220 lbs)
 Optional Open Storage - no doors (ND) - no price upcharge
 Optional Metallic Frosted Plexiglass doors (MFPD) - add \$759 list
 Optional Clear Glass doors (CGD) - add \$539 list - locks not available
 *Optional pull not available



7000HC66_ **\$1934**

Overhead storage unit with hinged wood doors, two storage areas behind four hinged doors (non-locking), two wire mgmt access grommets in center back panel
 22 3/4" clearance between apron rail & worksurface
 16" x 66" x 39"H (205 lbs)
 Optional Open Storage - no doors (ND) - no price upcharge
 Optional Metallic Frosted Plexiglass doors (MFPD) - add \$759 list
 Optional Clear Glass doors (CGD) - add \$539 list - locks not available
 *Optional pull not available



7000HC60_ **\$1747**

Overhead storage unit with hinged wood doors, two storage areas behind four hinged doors (non-locking), two wire mgmt access grommets in center back panel
 22 3/4" clearance between apron rail & worksurface
 16" x 60" x 39"H (200 lbs)
 Optional Open Storage - no doors (ND) - no price upcharge
 Optional Metallic Frosted Plexiglass doors (MFPD) - add \$759 list
 Optional Clear Glass doors (CGD) - add \$539 list - locks not available
 *Optional pull not available

7000HC48_ **\$1381**

Overhead storage unit with hinged wood doors, one storage area behind two hinged doors (non-locking), two wire mgmt access grommets in center back panel
 22 3/4" clearance between apron rail & worksurface
 16" x 48" x 39"H (146 lbs)
 Optional Open Storage - no doors (ND) - no price upcharge
 Optional Metallic Frosted Plexiglass doors (MFPD) - add \$380 list
 Optional Clear Glass doors (CGD) - add \$270 list - locks not available
 *Optional pull not available

7000HC42_ **\$1337**

Overhead storage unit with hinged wood doors, one storage area behind two hinged doors (non-locking), two wire mgmt access grommets in center back panel
 22 3/4" clearance between apron rail & worksurface
 16" x 42" x 39"H (130 lbs)
 Optional Open Storage - no doors (ND) - no price upcharge
 Optional Metallic Frosted Plexiglass doors (MFPD) - add \$380 list
 Optional Clear Glass doors (CGD) - add \$270 list - locks not available
 *Optional pull not available

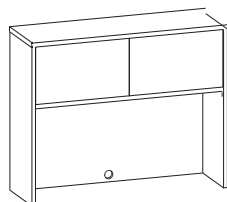
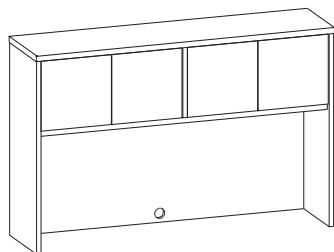

*for tasklights and tackboards, see page 168

BASICS 3 SERIES

List Price

Overhead Storage Units

7000HO84_ **\$3250**

Overhead storage unit with hinged wood doors (non-locking), three storage areas, three adjustable shelves in outer sections, upper center section storage, two wire mgmt access grommets in center back panel
 22 3/4" clearance between apron rail & worksurface
 16" x 84" x 39"H (250 lbs)
 Optional Open Storage - no doors (ND) - no price upcharge
 Optional Metallic Frosted Plexiglass doors (MFPD) - add \$957 list
 Optional Clear Glass doors (CGD) - add \$726 list - locks not available
 *Optional pull not available

7000HO78_ **\$2980**

Overhead storage unit with hinged wood doors (non-locking), three storage areas, three adjustable shelves in outer sections, upper center section storage, two wire mgmt access grommets in center back panel
 22 3/4" clearance between apron rail & worksurface
 16" x 78" x 39"H (230 lbs)
 Optional Open Storage - no doors (ND) - no price upcharge
 Optional Metallic Frosted Plexiglass doors (MFPD) - add \$957 list
 Optional Clear Glass doors (CGD) - add \$726 list - locks not available
 *Optional pull not available

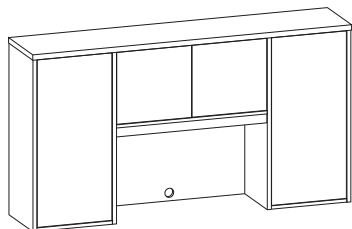

7000HO72_ **\$2763**

Overhead storage unit with hinged wood doors (non-locking), three storage areas, three adjustable shelves in outer sections, upper center section storage, two wire mgmt access grommets in center back panel
 22 3/4" clearance between apron rail & worksurface
 16" x 72" x 39"H (215 lbs)
 Optional Open Storage - no doors (ND) - no price upcharge
 Optional Metallic Frosted Plexiglass doors (MFPD) - add \$957 list
 Optional Clear Glass doors (CGD) - add \$726 list - locks not available
 *Optional pull not available

7000HO66_ **\$2515**

Overhead storage unit with hinged wood doors (non-locking), three storage areas, three adjustable shelves in outer sections, upper center section storage, two wire mgmt access grommets in center back panel
 22 3/4" clearance between apron rail & worksurface
 16" x 66" x 39"H (200 lbs)
 Optional Open Storage - no doors (ND) - no price upcharge
 Optional Metallic Frosted Plexiglass doors (MFPD) - add \$957 list
 Optional Clear Glass doors (CGD) - add \$726 list - locks not available
 *Optional pull not available

7000HO60_ **\$2273**

Overhead storage unit with hinged wood doors (non-locking), three storage areas, three adjustable shelves in outer sections, upper center section storage, two wire mgmt access grommets in center back panel
 22 3/4" clearance between apron rail & worksurface
 16" x 60" x 39"H (185 lbs)
 Optional Open Storage - no doors (ND) - no price upcharge
 Optional Metallic Frosted Plexiglass doors (MFPD) - add \$957 list
 Optional Clear Glass doors (CGD) - add \$726 list - locks not available
 *Optional pull not available

*for tasklights and tackboards, see page 168

BASICS 3 SERIES

List Price

Overhead Storage Units

7000HS84L **\$2886**
7000HS84R

Overhead storage unit with hinged wood doors (non-locking), three storage areas, three adjustable shelves in outer section, upper section storage, two wire mgmt access grommets in center back panel
 22 3/4" clearance between apron rail & worksurface
 16" x 84" x 39"H (250 lbs)
 Optional Open Storage - no doors (ND) - no price upcharge
 Optional Metallic Frosted Plexiglass doors (MFPD) - add \$864 list
 Optional Clear Glass doors (CGD) - add \$644 list - locks not available
 *Optional pull not available

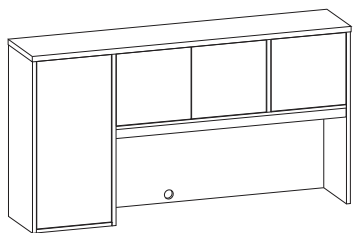

(LH Shown)

7000HS78L **\$2673**
7000HS78R

Overhead storage unit with hinged wood doors (non-locking), three storage areas, three adjustable shelves in outer section, upper section storage, two wire mgmt access grommets in center back panel
 22 3/4" clearance between apron rail & worksurface
 16" x 78" x 39"H (230 lbs)
 Optional Open Storage - no doors (ND) - no price upcharge
 Optional Metallic Frosted Plexiglass doors (MFPD) - add \$864 list
 Optional Clear Glass doors (CGD) - add \$644 list - locks not available
 *Optional pull not available

7000HS72L **\$2450**
7000HS72R

Overhead storage unit with hinged wood doors (non-locking), three storage areas, three adjustable shelves in outer section, upper section storage, two wire mgmt access grommets in center back panel
 22 3/4" clearance between apron rail & worksurface
 16" x 72" x 39"H (215 lbs)
 Optional Open Storage - no doors (ND) - no price upcharge
 Optional Metallic Frosted Plexiglass doors (MFPD) - add \$864 list
 Optional Clear Glass doors (CGD) - add \$644 list - locks not available
 *Optional pull not available

7000HS66L **\$2262**
7000HS66R

Overhead storage unit with hinged wood doors (non-locking), three storage areas, three adjustable shelves in outer section, upper section storage, two wire mgmt access grommets in center back panel
 22 3/4" clearance between apron rail & worksurface
 16" x 66" x 39"H (200 lbs)
 Optional Open Storage - no doors (ND) - no price upcharge
 Optional Metallic Frosted Plexiglass doors (MFPD) - add \$864 list
 Optional Clear Glass doors (CGD) - add \$644 list - locks not available
 *Optional pull not available

7000HS60L **\$2049**
7000HS60R

Overhead storage unit with hinged wood doors (non-locking), two storage areas, three adjustable shelves in outer section, upper section storage, two wire mgmt access grommets in center back panel
 22 3/4" clearance between apron rail & worksurface
 16" x 60" x 39"H (185 lbs)
 Optional Open Storage - no doors (ND) - no price upcharge
 Optional Metallic Frosted Plexiglass doors (MFPD) - add \$864 list
 Optional Clear Glass doors (CGD) - add \$644 list - locks not available
 *Optional pull not available

*for tasklights and tackboards, see page 168

BASICS 3 SERIES

List Price

Bookcases

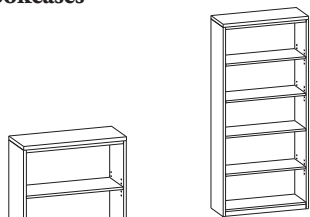

7000BC72

Open bookcase with three adjustable shelves, one fixed middle shelf and one fixed bottom shelf, square edge only, unfinished back
16" x 33" x 72"H (215 lbs)

\$2026

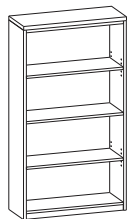

7000BC60

Open bookcase with two adjustable shelves, one fixed middle shelf and one fixed bottom shelf, square edge only, unfinished back
16" x 33" x 60"H (125 lbs)

\$1664

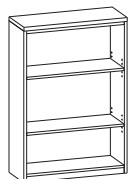

7000BC48

Open bookcase with two adjustable shelves and one fixed bottom shelf, square edge only, unfinished back
16" x 33" x 48"H (90 lbs)

\$1348

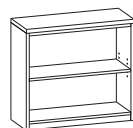

7000BC30

Open bookcase with one adjustable shelf and one fixed bottom shelf, square edge only, unfinished back
16" x 33" x 29"H (80 lbs)

\$995

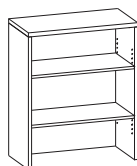

7000BCO39_

Stacking bookcase, two adjustable shelves
16" x 32" x 39"H (70 lbs)

\$1257

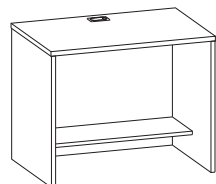

7000CRT36_

Computer table, 10" deep storage shelf, one wire mgmt grommet in top and back panel
24" x 36" x 29"H (105 lbs)
Optional with caster (C) add \$139 list
Optional with one adjustable 10" deep storage shelf (ASF) add \$165 list

\$1106

7000CRT48_

Computer table, 10" deep storage shelf, one wire mgmt grommet in top and back panel
24" x 48" x 29"H (135 lbs)
Optional with caster (C) add \$139 list
Optional with one adjustable 10" deep storage shelf (ASF) add \$193 list

\$1477

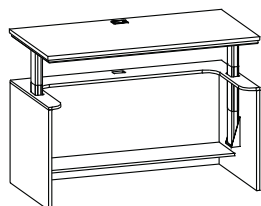

7000CRT60AH_

Height adjustable computer table, 10" deep storage shelf, one wire mgmt grommet in top and back panel, lifting column, control box, control pendant with memory settings, motor cable, main power cable, anti-collision dongle, lower metal lifts and anti tip brackets
30" x 60" x 30"-44"H (265 lbs)

\$7726

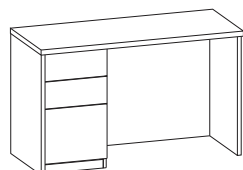

7000DCSPL48FP-FS_

Single pedestal credenza (LH), box/box/file pedestal (locking), one wire mgmt grommet in back panel, 30"W kneespace
20" x 48" x 29"H (160 lbs)

\$1527

7000DCSPL48FP-FS-24 - 24" x 48" x 29"H

\$1747

7000DCSPR48FP-FS_

Single pedestal credenza (RH), box/box/file pedestal (locking), one wire mgmt grommet in back panel, 30"W kneespace
20" x 48" x 29"H (160 lbs)

\$1527

7000DCSPR48FP-FS-24 - 24" x 48" x 29"H

\$1747

BASICS 3 SERIES

List Price

Conference Table Tops (see Contemporary Conference - pg 336-337 for base options)

| | |
|--|--------------|
| 7000MT48DIA_ | \$420 |
| Round conference table top 48" diameter x 1 3/16"H (62 lbs) | |
| 7000MT42DIA_ | \$314 |
| Round conference table top 42" diameter x 1 3/16"H (50 lbs) | |
| 7000MT36DIA_ | \$207 |
| Round conference table top 36" diameter x 1 3/16"H (30 lbs) | |



Accessories

| | |
|--|--------------|
| 7000PSA | \$600 |
| Portable work organizer, with three paper trays 14" x 12" x 17"H (20 lbs) | |

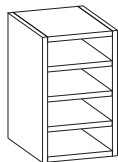

| | |
|--|--------------|
| AKPW | \$472 |
| Articulating keyboard - leverless, with non- handed mouse pad, 5" height adjustment, 25 degree tilt - 360 degree swivel, wooden keyboard tray - specify finish 11 1/4" x 21 1/2" x 2 3/4"H (25 lbs) | |

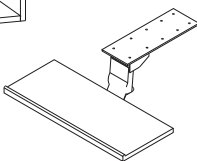

| | |
|---|--------------|
| AKP | \$337 |
| Articulating keyboard - leverless, with non- handed mouse pad, 5" height adjustment, 25 degree tilt - 360 degree swivel, black molded keyboard tray 11" x 25" x 2 3/4"H (21 lbs) | |

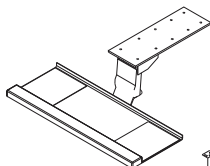

| | |
|--|--------------|
| KD | \$153 |
| Pull-out keyboard - leverless, black molded keyboard tray 10 5/8" x 21 1/2" x 3 5/8"H (8 lbs) | |

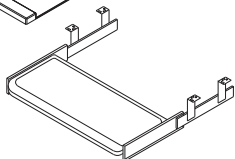

| | |
|---|--------------|
| 7000PD20 | \$234 |
| Pencil Drawer 20"W x 18"D x 3"H *Consider kneespace clearance | |

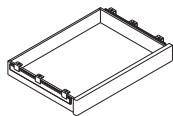

| | |
|---|-------------|
| LH | \$83 |
| Wire mgmt channel, 22" length - set of four, double sided velcro attachment | |



| | |
|--|--------------|
| TB77 | \$474 |
| Fabric tackboard, (COM, Grade A, Grade B) 3/4" x 77" x 15 1/2"H (20 lbs) | |

| | |
|--|--------------|
| TB71 | \$448 |
| Fabric tackboard, (COM, Grade A, Grade B) 3/4" x 71" x 15 1/2"H (18 lbs) | |

| | |
|--|--------------|
| TB65 | \$400 |
| Fabric tackboard, (COM, Grade A, Grade B) 3/4" x 65" x 15 1/2"H (16 lbs) | |

| | |
|--|--------------|
| TB59 | \$386 |
| Fabric tackboard, (COM, Grade A, Grade B) 3/4" x 59" x 15 1/2"H (14 lbs) | |

| | |
|--|--------------|
| TB53 | \$341 |
| Fabric tackboard, (COM, Grade A, Grade B) 3/4" x 53" x 15 1/2"H (12 lbs) | |

| | |
|--|--------------|
| TB41 | \$300 |
| Fabric tackboard, (COM, Grade A, Grade B) 3/4" x 41" x 15 1/2"H (11 lbs) | |

| | |
|--|--------------|
| TB35 | \$233 |
| Fabric tackboard, (COM, Grade A, Grade B) 3/4" x 35" x 15 1/2"H (10 lbs) | |

| | |
|---|--------------|
| TL48 | \$215 |
| Task light (UL approved), 6" x 48" x 1 1/2"H (15 lbs) | |



| | |
|---|--------------|
| TL24 | \$185 |
| Task light (UL approved), 6" x 24" x 1 1/2"H (10 lbs) | |

MONTEBELLO SERIES



Rich traditional design, meticulously hand-crafted. The Montebello Series features solid cherry, maple or walnut rims and moulding with bookmatched veneers accented by antiqued brass drawer pulls. Catalyzed varnish finish, mortise and tenon – groove and tenon construction, full extension file drawers with dovetail construction, center drawers with central locking in all desks are standard on this series. All items are available in a choice of 14 cherry, mahogany, maple and walnut finishes.

MONTEBELLO SERIES

Finishes Available

Walnut

Natural Walnut



Richleigh Walnut



Royal Walnut



Empire Walnut



Old World Mahogany



Crescent Cherry on Walnut

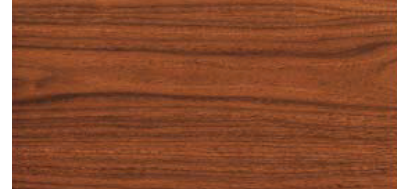

Espresso



Cherry

Natural Cherry



Amber Cherry



Cinnamon Cherry



Collector's Cherry



Mocha Cherry



Mahogany on Cherry



Maple

Sunrise Maple



**The finishes shown on this page have been reproduced as accurately as possible, however, due to the printing process some finishes may vary slightly from the actual finish samples originally photographed. In addition, due to the nature of wood, it is possible that some slight variations in color and grain character may occur naturally (which is the beauty of a natural product). Wood finish chips are available for each of the above finishes if requested (please call customer service).

MONTEBELLO SERIES



Options Available

| | | | |
|-----|---|----|--------------------------|
| HPL | Matching high pressure laminate substituted for wood top - Contact customer service for matching finish selections | \$ | N/C |
| BW | Burl walnut top | \$ | 2102 |
| MBC | Madrone burl top (cherry species only) | \$ | 2074 |
| LTH | Leather inlay (desk tops only) - Black EUR100, Forest Green EUR010 or Blackberry EUR009 | \$ | 2230 |
| GS | Georgian scroll base (replaces standard box base) | \$ | N/C |
| FF | Change PBF pedestal to F/F (no writing slide above pedestal) Change PBF or FF pedestal to | \$ | N/C |
| CPU | CPU pedestal - inside dimensions: 14 3/16"Wx17 13/16"Dx22 3/8"H - hinged door (non-locking) - two ventilation slots in back panel and inside end panel grommet | \$ | 110 |
| PNT | Change lateral file or file center pedestal to printer pedestal - inside dimensions: 27 1/2"Wx17 13/16"Dx22 3/8"H - slide out printer shelf, wall access cut-out in back modesty and inside end panel grommet | \$ | 110 |
| LK | Locking of individual doors, drawers or pedestals (where not standard) | \$ | 55 |
| FS | Freestanding unit - change from connecting unit (notched) to freestanding unit Wire | \$ | 88 |
| GR | mgmt grommet (note location) | \$ | 61 |
| WA | Wall access cut-out (modesty panels on bridges, credenzas, desks and returns) | \$ | N/C |
| AHM | Electronic height adjustable mechanism added to worksurface, lifting column, control box, control pendant, with memory settings, motor cable, main power cable, anti-collision dongle. Lower metal lifts and anti-tip brackets. Adjusts from 30" - 44"H | | Contact Customer Service |
| EA | Laser Engraved Legs - vertical lines with Fluer-de-lis - available on units with post legs | \$ | 165 |
| EB | Laser Engraved Legs - vertical lines - available on units with post legs | \$ | 165 |
| LW | Leather-Wrapped Pulls | \$ | 22 |

MONTEBELLO SERIES

Warranty and Certification

All products listed are warranted against defects of material and workmanship under normal use and service for a minimum of 10 years from the date of installation (see full warranty information). All products listed are Level 2 BIFMA certified.

Veneer

Veneer on all exposed surfaces are "A" grade plain sliced Walnut, Cherry or Maple. Outside surface veneers are book matched to provide proper grain consistency and uniform grain appearance. Drawer fronts are vertical grain walnut, cherry or maple veneers and matched in selected sets to ensure proper veneer balance and uniform grain appearance.

Wood Veneer Tops

1" thick tops utilizing 3-ply construction with solid walnut, cherry or maple lumber rims, shaped with traditional style edge detail. Top cores are high density particle board. Rims on all four sides are precisely mitered on all four corners. Walnut, cherry or maple veneer tops are standard. Burl, leather inlay and high pressure laminate tops are optional.

Modesty Panels and End Panels

Panels are 3/4" thick, 3-ply construction with book matched veneers to provide proper grain consistency and uniform grain appearance. All veneers are vertical grain walnut, cherry or maple veneers matched to ensure proper veneer balance. Decorative panel moulding is crafted from solid walnut, cherry or maple with mitered corners and hand fitted to each panel. Units may be specified with or without decorative panel moulding. Full modesty panels are standard for desk, bridge, and kneespace credenzas with optional half modesty options available.

Drawers

Drawer sides and backs are wood, 7/16" thick. Drawer fronts are 3-ply hardwood construction, 3/4" thick with book matched veneers to provide proper grain consistency and uniform grain appearance. All drawers utilize five sided drawer construction. Drawers are assembled with dovetail construction in all four corners. Drawer bottoms are 7/32" 3-ply hardwood dado construction.

Doors

Doors are 3/4" thick 3-ply construction with vertical grain walnut, cherry or maple veneers and matched in selected sets to ensure proper veneer balance and uniform grain appearance. European style hidden hinges are used on doors where applicable. Tempered glass conforming to ASTM C 1048 is used in all glass doors.

Shelves

Shelves are 3-ply construction with a 1/4" walnut, cherry or maple rim on the front edge. All shelves are full depth of the interior compartment unless specified otherwise. Faces are book matched walnut, cherry or maple veneer. Hutch shelves are walnut, cherry or maple faced on both sides. A minimum of one adjustable or fixed shelf is provided with each cabinet storage unit (see individual unit for details). Adjustable shelves are provided with metal adjustable shelf hardware supports.

Bases

Bases are solid hardwood mitered at all four corners. Units may be specified with conventional or Georgian scroll bases. Height adjustable leveling glides are mounted in each corner with a threaded metal insert capped with a nylon glide that is height adjustable to approx. 1 1/2" to ensure proper leveling of the unit to varying floor conditions.

Hardware

Drawer Suspensions – File, box, pencil and center drawers utilize steel "A" grade heavy duty metal slides for smooth operation. All pedestal drawers have 100 % full extension slides. All suspension systems feature positive and cushioned in/out stops. All box, center, and tray drawers are removable without tools and the suspensions are designed to prevent accidental removal.

Locks – Desk center drawer locks all drawers. Credenzas use pedestal locking. Lateral files are keyed as standard and feature central locking with anti-tip drawer interlock systems. Individual pieces are shipped random keyed. Units may be keyed alike upon special request. A minimum of fifty key changes (numbers) are available. Core lock changes are available (contact customer service).

Drawer Pulls – Traditional style, bail type drawer pulls in antique brass finish are standard. Leather-wrapped pulls are available.

Hinges – European style hidden hinges on hinged doors where applicable.

Wire Management – Black wire management grommets are standard on all returns and bridge work surfaces located in back center of the tops. Black wire management access grommets are standard on all credenzas, hutches, overhead storage units and computer tables located in back panel. Optional additional black wire management grommets, wall access cut-outs, wiring harness and wiring channels along with integrated cable management to conceal power and data cords are also available. Optional data ports accessible at work surface height (see accessories).

Chassis Construction

Construction technique is mortise and tenon, groove and tenon, heavily glue blocked with hardwood cleats for maximum strength.

Filing

File drawers use an easily adjustable filing rail system which can be positioned to accommodate front to back or side to side letter or legal filing.

Finish

All exposed surfaces are finished with a UV inhibitor catalyzed varnish finish to ensure maximum durability, chemical resistance, color retention and clarity. All exterior surfaces are finished in the following multi-step sequence: sap stain, NGR stain, wash coat, wash coat sand, filler spray, filler wipe, sealer spray, sealer sand, varnish spray, varnish sand, varnish spray. Moisture content for all wooden parts is between 5 - 9% prior to sealing. Drawer interiors and exteriors are UV prefinished with sealer, sealer sand, and varnished. Custom finish matches are available, contact customer service for request.

MONTEBELLO SERIES

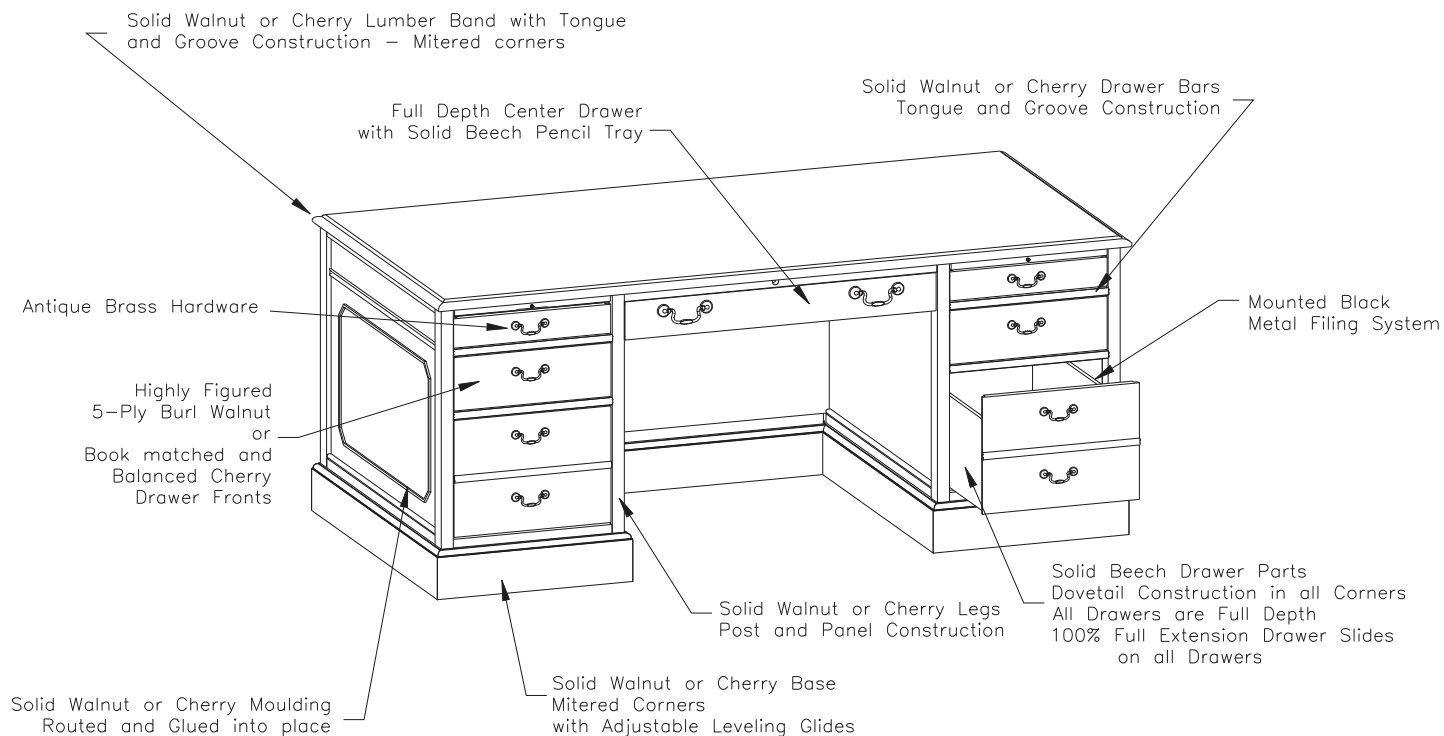

Available in Walnut or Cherry
Standard Central Locking
All units have $\frac{1}{8}$ " thick hardboard security/dust bottoms
Desk has standard Arm slides and Approach Dictation Slide
All surfaces are Catalyzed Lacquer finish
All tops are full-filled and hand rubbed

Ordering Information

Use the following steps to correctly place your order:

1) Determine the correct model number for the item you are selecting - example:

8FC84 = Double pedestal desk, 42" x 84" x 30"H

2) Determine the proper finish selection for the item - example:

8FC84-OW = Double pedestal desk, 42" x 84" x 30"H, in Old World Mahogany

3) Determine any additional options you may wish for the item - example:

8FC84-FFL-OW = Double pedestal desk, 42" x 84" x 30"H, in Old World Mahogany with optional file/file pedestal left

MONTEBELLO SERIES

List Price

Double Pedestal Desks

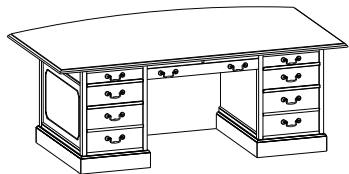

8FK84 \$7096
 Double pedestal desk with arc conference top, two pencil/box/file pedestals,
 center drawer, central locking, left and right hand writing slides.
 6 3/4" approach and side overhang
 32" W Kneespace
 42" x 84" x 30"H (425 lbs)

8FK72 \$6634
 Double pedestal desk with arc conference top, two pencil/box/file pedestals,
 center drawer, central locking, left and right hand writing slides.
 6 3/4" approach overhang
 32" W Kneespace
 42" x 72" x 30"H (405 lbs)

8FK7236 \$6095
 Double pedestal desk with arc conference top, two pencil/box/file pedestals,
 center drawer, central locking, left and right hand writing slides.
 6 3/4" approach overhang
 32" W Kneespace
 36" x 72" x 30"H (395 lbs)

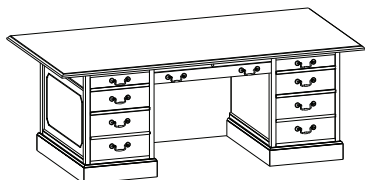

8FC84 \$6902
 Double pedestal desk with conference top, two pencil/box/file pedestals,
 center drawer, central locking, left and right hand writing slides.
 6 3/4" approach and side overhang
 32" W Kneespace
 42" x 84" x 30"H (420 lbs)

8FC72 \$6356
 Double pedestal desk with conference top, two pencil/box/file pedestals,
 center drawer, central locking, left and right hand writing slides.
 6 3/4" approach and side overhang
 32" W Kneespace
 42" x 72" x 30"H (380 lbs)

8FC7236 \$5621
 Double pedestal desk with conference top, two pencil/box/file pedestals,
 center drawer, central locking, left and right hand writing slides.
 6 3/4" approach overhang - left and right side fitted top
 32" W Kneespace
 36" x 72" x 30"H (330 lbs)

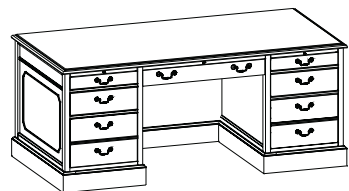

8F72 \$6490
 Double pedestal desk with fitted top, two pencil/box/file pedestals,
 center drawer, central locking, left and right hand writing slides and approach side dictation slide.
 32" W Kneespace
 36" x 72" x 30"H (390 lbs)

8F6636 \$6327
 Double pedestal desk with fitted top, two pencil/box/file pedestals,
 center drawer, central locking, left and right hand writing slides and approach side dictation slide.
 32" W Kneespace
 36" x 66" x 30"H (370 lbs)

MONTEBELLO SERIES

List Price

Double Pedestal Desks

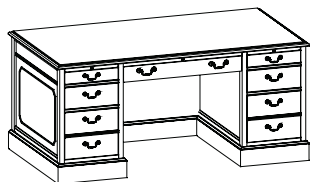

8F66 \$5835
 Double pedestal desk with fitted top, two pencil/box/file pedestals, center drawer, central locking, left and right hand writing slides and approach dictation slide.
 32" W Kneespace
 30" x 66" x 30"H (350 lbs)

8F6030 \$5378
 Double pedestal desk with fitted top, two pencil/box/file pedestals, center drawer, central locking, left and right hand writing slides and approach dictation slide.
 26 1/2" W Kneespace
 30" x 60" x 30"H (300 lbs)

Table Desks

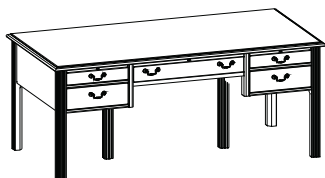

8TD72 \$4538
 Table desk with box/box drawer on each side, writing shelf above each pedestal, dictation slid on approach side, center drawer, central locking
 36" x 72" x 30"H (290 lbs)

8UT7236 \$2883
 Table desk with two drawers (non-locking), solid wood reeded legs
 Chair arm clearance 25"H
 36" x 72" x 30"H (140 lbs)

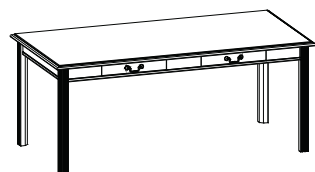

8UT7230 \$2659
 Table desk with two drawers (non-locking), solid wood reeded legs
 Chair arm clearance 25"H
 30" x 72" x 30"H (130 lbs)

8UT6030 \$2387
 Table desk with two drawers (non-locking), solid wood reeded legs
 Chair arm clearance 25"H
 30" x 60" x 30"H (100 lbs)

8UT4830 \$2143
 Table desk with one drawer (non-locking), solid wood reeded legs
 Chair arm clearance 25"H
 30" x 48" x 30"H (85 lbs)

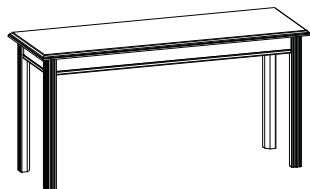

8UT6621 \$1793
 Table desk w/o drawers, solid wood reeded legs

8UT6621WD \$2167
 Table desk with two non-locking drawers, solid wood reeded legs
 Chair arm clearance 25"H
 21" x 66" x 30"H (100 lbs)

8UT4821 \$1612
 Table desk w/o drawers, solid wood reeded legs

8UT4821WD \$1887
 Table desk with one non-locking drawer, solid wood reeded legs
 Chair arm clearance 25"H
 21" x 48" x 30"H (70 lbs)

MONTEBELLO SERIES

List Price

Credenzas

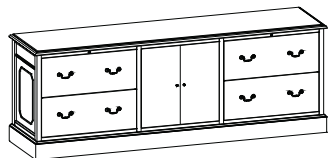

8DC90-4 \$6168

Credenza with hinged door storage, two lateral file pedestals (locking), hinged door storage area (non-locking) with one adjustable shelf, wire mgmt grommet in back panel
21" x 90" x 30"H (380 lbs)

Optional locking doors (LK) - add \$55 list

8DC90-4-24 - 24" x 90" x 30"H \$6630

8DC84-4 \$5991

Credenza with hinged door storage, two lateral file pedestals (locking), hinged door storage area (non-locking) with one adjustable shelf, wire mgmt grommet in back panel
21" x 84" x 30"H (365 lbs)

Optional locking doors (LK) - add \$55 list

8DC84-4-24 - 24" x 84" x 30"H \$6420

8DC72-4 \$5654

Credenza with hinged door storage, two pencil/box/file pedestals (locking), hinged door storage area (non-locking) with one adjustable shelf, center/keyboard drawer over hinged door boocase, wire mgmt grommet in back panel
21" x 72" x 30"H (350 lbs)

Optional locking doors (LK) - add \$55 list

8DC72-4-24 - 24" x 72" x 30"H \$6047

8DC66-4 \$5371

Credenza with hinged door storage, two pencil/box/file pedestals (locking), hinged door storage area (non-locking) with one adjustable shelf, center/keyboard drawer over hinged door boocase, wire mgmt grommet in back panel
21" x 66" x 30"H (330 lbs)

Optional locking doors (LK) - add \$55 list

8DC66-4-24 - 24" x 66" x 30"H \$5734

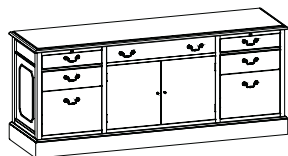

8DC90-3 \$5564

Credenza with kneespace, two lateral file pedestals (locking), wire mgmt grommet in back panel
30 1/2" W kneespace
21" x 90" x 30"H (325 lbs)

8DC90-3-24 - 24" x 90" x 30"H \$6026

8DC84-3 \$5424

Credenza with kneespace, two lateral file pedestals (locking), wire mgmt grommet in back panel
24 1/2" W kneespace
21" x 84" x 30"H (310 lbs)

8DC84-3-24 - 24" x 84" x 30"H \$5853

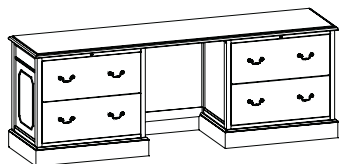

8DC72-3 \$5285

Credenza with kneespace, two pencil/box/file pedestals (locking), wire mgmt grommet in back panel, center/keyboard drawer
32" W kneespace
21" x 72" x 30"H (260 lbs)

8DC72-3-24 - 24" x 72" x 30"H \$5681

8DC66-3 \$5084

Credenza with kneespace, two pencil/box/file pedestals (locking), wire mgmt grommet in back panel, center/keyboard drawer
32" W kneespace
21" x 66" x 30"H (240 lbs)

8DC66-3-24 - 24" x 66" x 30"H \$5447



MONTEBELLO SERIES

List Price

Credenzas

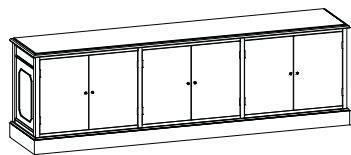

8SC-90 **\$6490**
 Six door hinged door cabinet (non-locking), one adjustable shelf per section
 21" x 90" x 30"H (380 lbs)
 Optional locking doors (LK3) - add \$165 list
8SC-90-24 - 24" x 90" x 30"H **\$6952**

8SC-84 **\$6001**
 Six door hinged door cabinet (non-locking), one adjustable shelf per section
 21" x 84" x 30"H (365 lbs)
 Optional locking doors (LK3) - add \$165 list
8SC-84-24 - 24" x 84" x 30"H **\$6430**

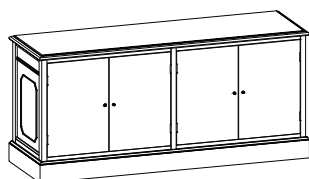

8SC-72 **\$5013**
 Four door hinged door cabinet (non-locking), one adjustable shelf per section
 21" x 72" x 30"H (300 lbs)
 Optional locking doors (LK2) - add \$110 list
8SC-72-24 - 24" x 72" x 30"H **\$5409**

8SC-66 **\$4795**
 Four door hinged door cabinet (non-locking), one adjustable shelf per section
 21" x 66" x 30"H (260 lbs)
 Optional locking doors (LK2) - add \$110 list
8SC-66-24 - 24" x 66" x 30"H **\$5158**

8SC-60 **\$4556**
 Four door hinged door cabinet (non-locking), one adjustable shelf per section
 21" x 60" x 30"H (200 lbs)
 Optional locking doors (LK2) - add \$110 list
8SC-60-24 - 24" x 60" x 30"H **\$4886**

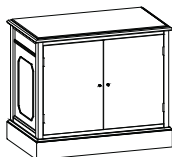

8SC-35 **\$2053**
 Two door hinged door cabinet (non-locking), one adjustable shelf
 21" x 35" x 30"H (125 lbs)
 Optional locking doors (LK) - add \$55 list
8SC-35-24 - 24" x 35" x 30"H **\$2280**

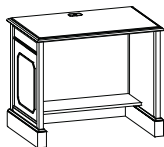

8CRT36 **\$1909**
 Computer table, 10" deep storage shelf, one wire mgmt grommet in top and back panel
 24" x 36" x 30"H (110 lbs)
 Optional with casters (C) - add \$139 list
 Optional with one additional adjustable 10" deep storage shelf (-ASF) - add \$165 list

8CRT48 **\$2195**
 Computer table, 10" deep storage shelf, one wire mgmt grommet in top and back panel
 24" x 48" x 30"H (135 lbs)
 Optional with casters (-C) - add \$139 list
 Optional with one additional adjustable 10" deep storage shelf (-ASF) - add \$193 list

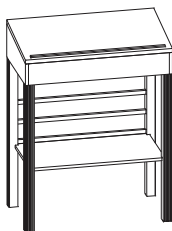

8SUD36 **\$3115**
 Stand-up desk, hinged top with storage, pencil tray, bottom shelf,
 solid wood reeded legs
 20" x 36" x 47"H - back / 42"H front (160 lbs)

MONTEBELLO SERIES

List Price

Storage Units



8LF4V \$4311
 Four drawer vertical lateral file, legal or letter cross filing, central locking
 21" x 35" x 54"H (220 lbs)
8LF4V-24 - 24" x 35" x 54"H \$4704



8LF3 \$3620
 Three drawer lateral file, legal or letter cross filing, central locking
 21" x 35" x 42"H (195 lbs)
8LF3-24 - 24" x 35" x 42"H \$3933



8LF2 \$2932
 Two drawer lateral file, legal or letter cross filing, central locking
 21" x 35" x 30"H (145 lbs)
8LF2-24 - 24" x 35" x 30"H \$3185

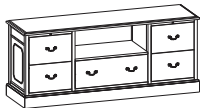

8FC5BC \$4452
 Open storage/file, left and right file/file pedestal (locking), center - top open storage area, bottom - lateral file (locking), legal or letter filing, wire mgmt grommet in back panel
 21" x 72" x 30"H (280 lbs)
8FC5BC-24 - 24" x 72" x 30"H \$4848

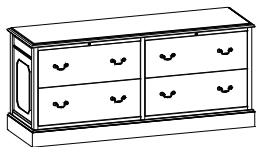

8LF4-72 \$4862
 Double unit lateral file, legal or letter cross filing, central locking
 21" x 72" x 30"H (235 lbs)
8LF4-72-24 - 24" x 72" x 30"H \$5258

8LF4-67 \$4601
 Double unit lateral file, legal or letter cross filing, central locking
 21" x 67 1/4" x 30"H (215 lbs)
8LF4-67-24 - 24" x 67 1/4" x 30"H \$4964

8LF4-60 \$4275
 Double unit lateral file, legal or letter cross filing, central locking
 21" x 60" x 30"H (195 lbs)
8LF4-60-24 - 24" x 60" x 30"H \$4605

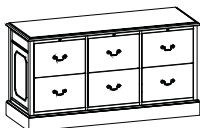

8FC6 \$4223
 Six drawer file (2x3), locking, legal or letter filing
 21" x 58 1/2" x 30"H (260 lbs)
8FC6-24 - 24" x 58 1/2" x 30"H \$4707



8FC4 \$3890
 Four drawer file (2x2), locking, legal or letter filing
 21" x 39" x 30"H (175 lbs)
8FC4-24 - 24" x 39" x 30"H \$4253

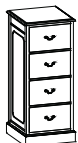

8FC4V \$3900
 Four drawer vertical file (4x1), locking, legal or letter filing
 21" x 23" x 54"H (200 lbs)
FC4V-24 - 24" x 23" x 54"H \$4255







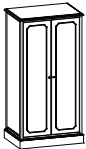
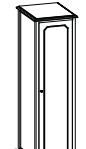
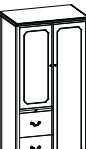
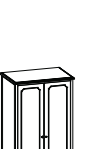

8FC2 \$2742
 Two drawer file (2x1), legal or letter cross filing, central locking
 21" x 23" x 30"H (90 lbs)
8FC2-24 - 24" x 23" x 30"H \$2973

MONTEBELLO SERIES

List Price

Storage Units

| | | |
|---|---|--------|
|  | <p>8WC69 Wardrobe, left side clothing carrier, right side four adjustable shelves, non-locking 24" x 35" x 69"H (330 lbs) Optional locking doors (LK) - add \$55 list Optional full wardrobe - full coat rod (FULL) - N/C</p> | \$5283 |
|  | <p>8WC83 - 83"H with cornice top</p> | \$6218 |
|  | <p>8WC6918R - hinged right (shown) 8WC6918L - hinged left Single unit wardrobe, top shelf, coat rod, non-locking left or right hinged door 24" x 18" x 69"H (18 lbs) Optional locking door (LK) - add \$55 list</p> | \$4270 |
|  | <p>8WC8318R - 83"H with cornice top</p> | \$5040 |
|  | <p>8WC8318L - 83"H with cornice top</p> | \$6012 |
|  | <p>8WSFFL - left hand wardrobe 8WSFFR - right hand wardrobe (shown) Utility cabinet, wardrobe unit with hinged door (non-locking), top shelf, coat rod, file/file pedestal - bottom (locking), hinged door storage area (non-locking) with two adjustable shelves - top (right hand shown) 24" x 35" x 69"H (360 lbs) Optional locking doors (LK2) - add \$110 list</p> | \$6947 |
|  | <p>8WSFFR-83 - 83"H with cornice top</p> | \$5606 |
|  | <p>8SC69 Storage cabinet, hinged doors (non-locking), four adjustable shelves 24" x 35" x 69"H (285 lbs) Optional locking doors (LK) - add \$55 list</p> | \$6541 |
|  | <p>8SC83 - 83"H with cornice top</p> | \$4753 |
|  | <p>8SC6918R - hinged right (shown) 8SC6918L - hinged left Storage cabinet, non-locking left or right hinged door, four adjustable shelves 24" x 18" x 69"H (18 lbs) Optional locking door (LK) - add \$55 list</p> | \$5523 |
| | <p>8SC8318R - 83"H with cornice top</p> | \$6031 |
| | <p>8SC8318L - 83"H with cornice top</p> | \$6965 |
| | <p>8LFB/CW Storage cabinet / Lateral file, upper hinged door storage (non-locking) with two adjustable shelves, bottom - two lateral file drawers (locking), legal or letter filing 24" x 35" x 69"H (310 lbs) Optional locking doors (LK) - add \$55 list</p> | \$5190 |
| | <p>8LFB/CW-83 - 83"H with cornice top</p> | \$5960 |
| | <p>8SCFF6918L - hinged left (shown) 8SCFF6918R - hinged right Utility cabinet, file/file pedestal - bottom (locking), hinged door storage area (non-locking) with two adjustable shelves - top (left hand hinged door shown) 24" x 18" x 69"H (18 lbs) Optional locking door (LK) - add \$55 list</p> | \$5960 |
| | <p>8SCFF8318L - 83"H with cornice top</p> | \$1982 |
| | <p>8SCFF8318R - 83"H with cornice top</p> | |
| | <p>8PCDH Telephone cabinet, box drawer, hinged door storage (locking), one adjustable shelf 17" x 22" x 30"H (85 lbs)</p> | \$1982 |

MONTEBELLO SERIES

List Price

Computer Desk Workstations - Single Pedestal Desks

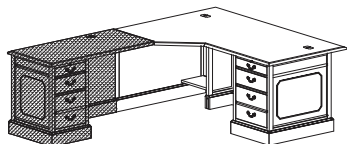

8ECWS8446R **\$5502**
 Executive single pedestal computer desk (RH) with conference top, pencil/box/file pedestal (locking), right hand writing slide, 46" corner unit, 4" approach overhang, two wire mgmt grommets in top
 34"- 46" x 84" x 30"H (385 lbs)

8ECWS7246R **\$5076**
 Executive single pedestal computer desk (RH) with conference top, pencil/box/file pedestal (locking), right hand writing slide, 46" corner unit, 4" approach overhang, two wire mgmt grommets in top
 34"- 46" x 72" x 30"H (360 lbs)

8ECWS6640R **\$4816**
 Executive single pedestal computer desk (RH) with conference top, pencil/box/file pedestal (locking), right hand writing slide, 40" corner unit, 4" approach overhang, two wire mgmt grommets in top
 28"- 40" x 66" x 30"H (280 lbs)

8ECWS8442R **\$5232**
 Executive single pedestal computer desk (RH) with fitted top, pencil/box/file pedestal (locking), right hand writing slide, 42" corner unit, two wire mgmt grommets in top
 30"- 42" x 84" x 30"H (375 lbs)

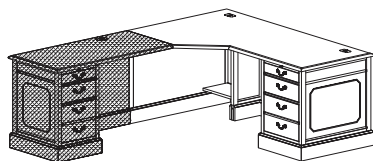

8ECWS7242R **\$4804**
 Executive single pedestal computer desk (RH) with fitted top, pencil/box/file pedestal (locking), right hand writing slide, 42" corner unit, two wire mgmt grommets in top
 30"- 42" x 72" x 30"H (340 lbs)

8ECWS7236R **\$4732**
 Executive single pedestal computer desk (RH) with fitted top, pencil/box/file pedestal (locking), right hand writing slide, 36" corner unit, two wire mgmt grommets in top
 24"- 36" x 72" x 30"H (283 lbs)

8ECWS6636R **\$4535**
 Executive single pedestal computer desk (RH) with fitted top, pencil/box/file pedestal (locking), right hand writing slide, 36" corner unit, two wire mgmt grommets in top
 24"- 36" x 66" x 30"H (260 lbs)

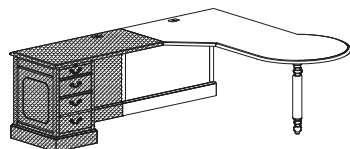

8ECWSP76R **\$3828**
 Freestanding P-Top computer desk (RH), 36" diameter end, with sculptured wood pedestal leg, 42" corner unit, one wire mgmt grommet in top
 30"-42" x 76" x 30"H (330 lbs)

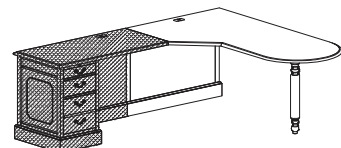

8ECWSB76R **\$3474**
 Freestanding bullet top computer desk (RH), 30" diameter end, with sculptured wood pedestal leg, 42" corner unit, one wire mgmt grommet in top
 30"-42" x 76" x 30"H (330 lbs)

MONTEBELLO SERIES

List Price

Computer Desk Workstations - Executive Returns

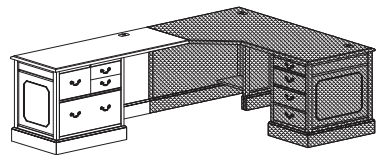

8ERL72FCCU

\$3994

Executive height computer return (LH), file center pedestal (locking), two box, one file drawer top, one lateral file drawer bottom, one wire mgmt grommet, 42"W kneespace
24" x 72" x 30"H (250 lbs)

8ERL60FCCU

\$3817

Executive height computer return (LH), file center pedestal (locking), two box, one file drawer top, one lateral file drawer bottom, one wire mgmt grommet, 30"W kneespace
24" x 60" x 30"H (195 lbs)

8ERL54FCCU

\$3698

Executive height computer return (LH), file center pedestal (locking), two box, one file drawer top, one lateral file drawer bottom, one wire mgmt grommet, 24"W kneespace
24" x 54" x 30"H (180 lbs)

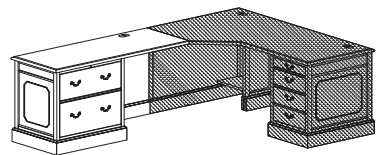

8ERL72LFCU

\$3890

Executive height computer return (LH), two lateral file drawers (locking), one wire mgmt grommet, 42"W kneespace
24" x 72" x 30"H (250 lbs)

8ERL60LFCU

\$3672

Executive height computer return (LH), two lateral file drawers (locking), one wire mgmt grommet, 30"W kneespace
24" x 60" x 30"H (195 lbs)

8ERL54LFCU

\$3547

Executive height computer return (LH), two lateral file drawers (locking), one wire mgmt grommet, 24"W kneespace
24" x 54" x 30"H (180 lbs)

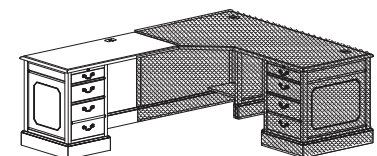

8ERL72CU

\$3646

Executive height computer return (LH), pencil/box/file pedestal (locking), 1/2 support panel on connection end, one wire mgmt grommet, 54"W kneespace
24" x 72" x 30"H (225 lbs)

8ERL48CU

\$3155

Executive height computer return (LH), pencil/box/file pedestal (locking), one wire mgmt grommet, 31"W kneespace
24" x 48" x 30"H (150 lbs)

8ERL42CU

\$2975

Executive height computer return (LH), pencil/box/file pedestal (locking), one wire mgmt grommet, 25"W kneespace
24" x 42" x 30"H (130 lbs)

MONTEBELLO SERIES

List Price

Computer Desk Workstations - Single Pedestal Desks

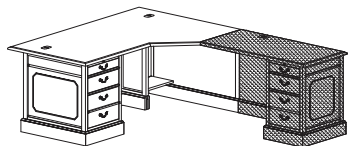

8ECWS8446L **\$5502**
 Executive single pedestal computer desk (LH) with conference top, pencil/box/file pedestal (locking), left hand writing slide, 46" corner unit, 4" approach overhang, two wire mgmt grommets in top
 34"- 46" x 84" x 30"H (385 lbs)

8ECWS7246L **\$5076**
 Executive single pedestal computer desk (LH) with conference top, pencil/box/file pedestal (locking), left hand writing slide, 46" corner unit, 4" approach overhang, two wire mgmt grommets in top
 34"- 46" x 72" x 30"H (360 lbs)

8ECWS6640L **\$4816**
 Executive single pedestal computer desk (LH) with conference top, pencil/box/file pedestal (locking), left hand writing slide, 40" corner unit, 4" approach overhang, two wire mgmt grommets in top
 28"- 40" x 66" x 30"H (280 lbs)

8ECWS8442L **\$5232**
 Executive single pedestal computer desk (LH) with fitted top, pencil/box/file pedestal (locking), left hand writing slide, 42" corner unit, two wire mgmt grommets in top
 30"- 42" x 84" x 30"H (375 lbs)

8ECWS7242L **\$4804**
 Executive single pedestal computer desk (LH) with fitted top, pencil/box/file pedestal (locking), left hand writing slide, 42" corner unit, two wire mgmt grommets in top
 30"- 42" x 72" x 30"H (340 lbs)

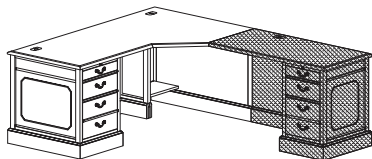

8ECWS7236L **\$4732**
 Executive single pedestal computer desk (LH) with fitted top, pencil/box/file pedestal (locking), left hand writing slide, 36" corner unit, two wire mgmt grommets in top
 24"- 36" x 72" x 30"H (283 lbs)

8ECWS6636L **\$4535**
 Executive single pedestal computer desk (LH) with fitted top, pencil/box/file pedestal (locking), left hand writing slide, 36" corner unit, two wire mgmt grommets in top
 24"- 36" x 66" x 30"H (260 lbs)

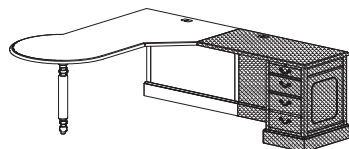

8ECWSP76L **\$3828**
 Freestanding P-Top computer desk (LH), 36" diameter end, with sculptured wood pedestal leg, 42" corner unit, one wire mgmt grommet in top
 30"-42" x 76" x 30"H (330 lbs)

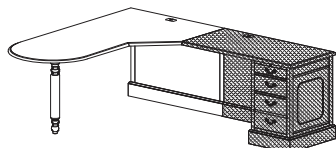

8ECWSB76L **\$3474**
 Freestanding bullet top computer desk (LH), 30" diameter end, with sculptured wood pedestal leg, 42" corner unit, one wire mgmt grommet in top
 30"-42" x 76" x 30"H (330 lbs)

MONTEBELLO SERIES

List Price

Computer Desk Workstations - Executive Returns

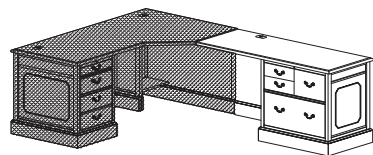

8ERR72FCCU

Executive height computer return (RH), file center pedestal (locking), two box, one file drawer top, one lateral file drawer bottom, one wire mgmt grommet, 42"W kneespace
24" x 72" x 30"H (250 lbs)

\$3994

8ERR60FCCU

Executive height computer return (RH), file center pedestal (locking), two box, one file drawer top, one lateral file drawer bottom, one wire mgmt grommet, 30"W kneespace
24" x 60" x 30"H (195 lbs)

\$3817

8ERR54FCCU

Executive height computer return (RH), file center pedestal (locking), two box, one file drawer top, one lateral file drawer bottom, one wire mgmt grommet, 24"W kneespace
24" x 54" x 30"H (180 lbs)

\$3698

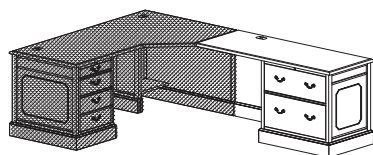

8ERR72LFCU

Executive height computer return (RH), two lateral file drawers (locking), one wire mgmt grommet, 42"W kneespace
24" x 72" x 30"H (250 lbs)

\$3890

8ERR60LFCU

Executive height computer return (RH), two lateral file drawers (locking), one wire mgmt grommet, 30"W kneespace
24" x 60" x 30"H (195 lbs)

\$3672

8ERR54LFCU

Executive height computer return (RH), two lateral file drawers (locking), one wire mgmt grommet, 24"W kneespace
24" x 54" x 30"H (180 lbs)

\$3547

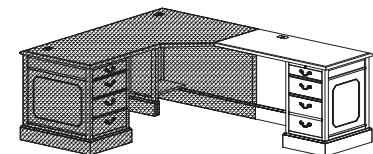

8ERR72CU

Executive height computer return (RH), pencil/box/file pedestal (locking), 1/2 support panel on connection end, one wire mgmt grommet, 54"W kneespace
24" x 72" x 30"H (225 lbs)

\$3646

8ERR48CU

Executive height computer return (RH), pencil/box/file pedestal (locking), one wire mgmt grommet, 31"W kneespace
24" x 48" x 30"H (150 lbs)

\$3155

8ERR42CU

Executive height computer return (RH), pencil/box/file pedestal (locking), one wire mgmt grommet, 25"W kneespace
24" x 42" x 30"H (130 lbs)

\$2975

MONTEBELLO SERIES

List Price

Executive Workstations - Single Pedestal Desks

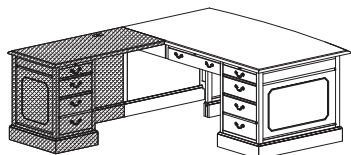

8KSPR84 \$5528
 Executive single pedestal desk (RH) with arc conference top, pencil/box/file pedestal, center drawer, central locking, right hand writing slide, 6" approach overhang
 42" x 84" x 30"H (350 lbs)

8KSPR72 \$5272
 Executive single pedestal desk (RH) with arc conference top, pencil/box/file pedestal, center drawer, central locking, right hand writing slide, 6" approach overhang
 42" x 72" x 30"H (325 lbs)

8KSPR7236 \$5148
 Executive single pedestal desk (RH) with arc conference top, pencil/box/file pedestal, center drawer, central locking, right hand writing slide, 6" approach overhang
 36" x 72" x 30"H (310 lbs)

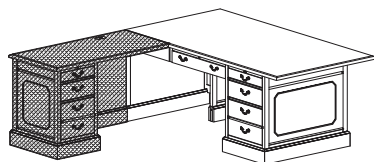

8SPR84 \$5263
 Executive single pedestal desk (RH) with conference top, pencil/box/file pedestal, center drawer, central locking, right hand writing slide, 6" approach and right side overhang
 42" x 84" x 30"H (340 lbs)

8SPR72 \$5180
 Executive single pedestal desk (RH) with conference top, pencil/box/file pedestal, center drawer, central locking, right hand writing slide, 6" approach and right side overhang
 36" x 72" x 30"H (310 lbs)

8SPR6636 \$4805
 Executive single pedestal desk (RH) with conference top, pencil/box/file pedestal, center drawer, central locking, right hand writing slide, 6" approach overhang only
 36" x 66" x 30"H (280 lbs)

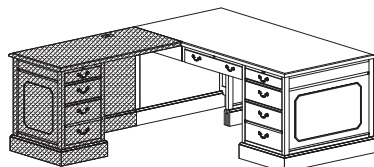

8SPR72F \$5075
 Executive single pedestal desk (RH) with fitted top, pencil/box/file pedestal, center drawer, central locking, right hand writing slide
 36" x 72" x 30"H (300 lbs)

8SPR7230 \$4680
 Executive single pedestal desk (RH) with fitted top, pencil/box/file pedestal, center drawer, central locking, right hand writing slide
 30" x 72" x 30"H (290 lbs)

8SPR66 \$4379
 Executive single pedestal desk (RH) with fitted top, pencil/box/file pedestal, center drawer, central locking, right hand writing slide
 30" x 66" x 30"H (275 lbs)

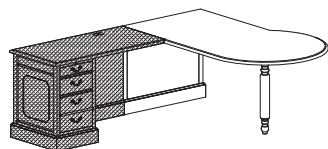

8WSP72R _ \$3229
 P-Top desk (RH), 42" diameter end, with sculptured wood pedestal leg 36"-42" x 72" x 30"H (170 lbs)

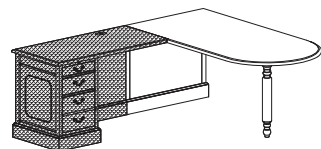

8WSB7236R _ \$2784
 Bullet top desk (RH), 36" diameter end, with sculptured wood pedestal leg, 42" corner unit
 36" x 72" x 30"H (170 lbs)

MONTEBELLO SERIES

List Price

Executive Workstations - Executive Returns

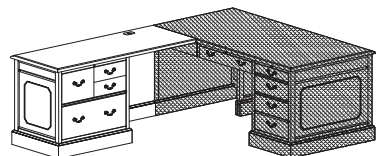

8ERL72FC **\$3994**
 Executive height return (LH), file center pedestal (locking), two box, one file drawer top, one lateral file drawer bottom, one wire mgmt grommet, 42"W kneespace
 24" x 72" x 30"H (250 lbs)

8ERL60FC **\$3817**
 Executive height return (LH), file center pedestal (locking), two box, one file drawer top, one lateral file drawer bottom, one wire mgmt grommet, 30"W kneespace
 24" x 60" x 30"H (195 lbs)

8ERL54FC **\$3698**
 Executive height return (LH), file center pedestal (locking), two box, one file drawer top, one lateral file drawer bottom, one wire mgmt grommet, 24"W kneespace
 24" x 54" x 30"H (180 lbs)

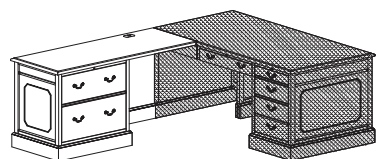

8ERL72LF **\$3890**
 Executive height return (LH), two lateral file drawers (locking), one wire mgmt grommet, 42"W kneespace
 24" x 72" x 30"H (250 lbs)

8ERL60LF **\$3672**
 Executive height return (LH), two lateral file drawers (locking), one wire mgmt grommet, 30"W kneespace
 24" x 60" x 30"H (195 lbs)

8ERL54LF **\$3547**
 Executive height return (LH), two lateral file drawers (locking), one wire mgmt grommet, 24"W kneespace
 24" x 54" x 30"H (180 lbs)

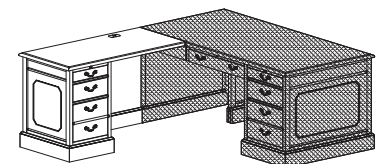

8ERL72 **\$3646**
 Executive height return (LH), pencil/box/file pedestal (locking), 1/2 support panel on connection end, one wire mgmt grommet, 54"W kneespace
 24" x 72" x 30"H (225 lbs)

8ERL48 **\$3155**
 Executive height return (LH), pencil/box/file pedestal (locking), one wire mgmt grommet, 31"W kneespace
 24" x 48" x 30"H (150 lbs)

8ERL42 **\$2975**
 Executive height return (LH), pencil/box/file pedestal (locking), one wire mgmt grommet, 25"W kneespace
 24" x 42" x 30"H (130 lbs)

MONTEBELLO SERIES

List Price

Executive Workstations - Single Pedestal Desks

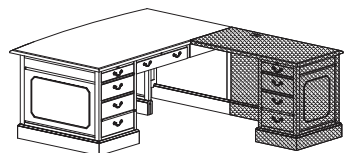

8KSPL84 \$5528
 Executive single pedestal desk (LH) with arc conference top, pencil/box/file pedestal, center drawer, central locking, left hand writing slide, 6" approach overhang
 42" x 84" x 30"H (350 lbs)

8KSPL72 \$5272
 Executive single pedestal desk (LH) with arc conference top, pencil/box/file pedestal, center drawer, central locking, left hand writing slide, 6" approach overhang
 42" x 72" x 30"H (325 lbs)

8KSPL7236 \$5148
 Executive single pedestal desk (LH) with arc conference top, pencil/box/file pedestal, center drawer, central locking, left hand writing slide, 6" approach overhang
 36" x 72" x 30"H (310 lbs)

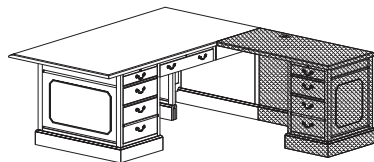

8SPL84 \$5263
 Executive single pedestal desk (LH) with conference top, pencil/box/file pedestal, center drawer, central locking, left hand writing slide, 6" approach and left side overhang
 42" x 84" x 30"H (340 lbs)

8SPL72 \$5180
 Executive single pedestal desk (LH) with conference top, pencil/box/file pedestal, center drawer, central locking, left hand writing slide, 6" approach and left side overhang
 36" x 72" x 30"H (310 lbs)

8SPL6636 \$4805
 Executive single pedestal desk (LH) with conference top, pencil/box/file pedestal, center drawer, central locking, left hand writing slide, 6" approach overhang only
 36" x 66" x 30"H (280 lbs)

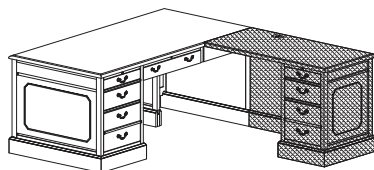

8SPL72F \$5075
 Executive single pedestal desk (LH) with fitted top, pencil/box/file pedestal, center drawer, central locking, left hand writing slide
 36" x 72" x 30"H (300 lbs)

8SPL7230 \$4680
 Executive single pedestal desk (LH) with fitted top, pencil/box/file pedestal, center drawer, central locking, left hand writing slide
 30" x 72" x 30"H (290 lbs)

8SPL66 \$4379
 Executive single pedestal desk (LH) with fitted top, pencil/box/file pedestal, center drawer, central locking, left hand writing slide
 30" x 66" x 30"H (275 lbs)

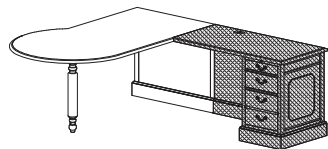

8WSP72L _ \$3229
 P-Top desk (LH), 42" diameter end, with sculptured wood pedestal leg 36"-42" x 72" x 30"H (170 lbs)

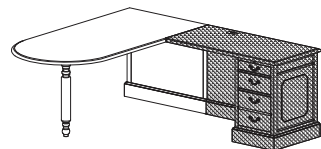

8WSB7236L _ \$2784
 Bullet top desk (LH), 36" diameter end, with sculptured wood pedestal leg, 42" corner unit
 36" x 72" x 30"H (170 lbs)

MONTEBELLO SERIES

List Price

Executive Workstations - Executive Returns

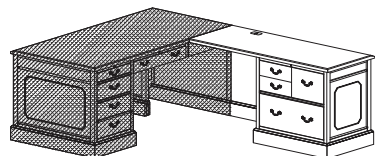

8ERR72FC **\$3994**
 Executive height return (RH), file center pedestal (locking), two box, one file drawer top, one lateral file drawer bottom, one wire mgmt grommet, 42"W kneespace
 24" x 72" x 30"H (250 lbs)

8ERR60FC **\$3817**
 Executive height return (RH), file center pedestal (locking), two box, one file drawer top, one lateral file drawer bottom, one wire mgmt grommet, 30"W kneespace
 24" x 60" x 30"H (195 lbs)

8ERR54FC **\$3698**
 Executive height return (RH), file center pedestal (locking), two box, one file drawer top, one lateral file drawer bottom, one wire mgmt grommet, 24"W kneespace
 24" x 54" x 30"H (180 lbs)

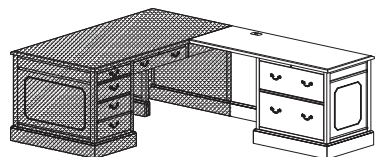

8ERR72LF **\$3890**
 Executive height return (RH), two lateral file drawers (locking), one wire mgmt grommet, 42"W kneespace
 24" x 72" x 30"H (250 lbs)

8ERR60LF **\$3672**
 Executive height return (RH), two lateral file drawers (locking), one wire mgmt grommet, 30"W kneespace
 24" x 60" x 30"H (195 lbs)

8ERR54LF **\$3547**
 Executive height return (RH), two lateral file drawers (locking), one wire mgmt grommet, 24"W kneespace
 24" x 54" x 30"H (180 lbs)

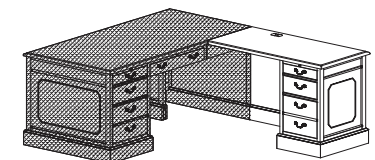

8ERR72 **\$3646**
 Executive height return (RH), pencil/box/file pedestal (locking), 1/2 support panel on connection end, one wire mgmt grommet, 54"W kneespace
 24" x 72" x 30"H (225 lbs)

8ERR48 **\$3155**
 Executive height return (RH), pencil/box/file pedestal (locking), one wire mgmt grommet, 31"W kneespace
 24" x 48" x 30"H (150 lbs)

8ERR42 **\$2975**
 Executive height return (RH), pencil/box/file pedestal (locking), one wire mgmt grommet, 25"W kneespace
 24" x 42" x 30"H (130 lbs)

MONTEBELLO SERIES

List Price

Computer Desk U Workstations - Single Pedestal Desks

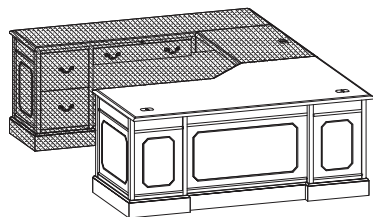

8ECWS8446R **\$5502**
 Executive single pedestal computer desk (RH) with conference top, pencil/box/file pedestal (locking), right hand writing slide, 46" corner unit, 4" approach overhang, two wire mgmt grommets in top
 34"- 46" x 84" x 30"H (385 lbs)

8ECWS7246R **\$5076**
 Executive single pedestal computer desk (RH) with conference top, pencil/box/file pedestal (locking), right hand writing slide, 46" corner unit, 4" approach overhang, two wire mgmt grommets in top
 34"- 46" x 72" x 30"H (360 lbs)

8ECWS6640R **\$4816**
 Executive single pedestal computer desk (RH) with conference top, pencil/box/file pedestal (locking), right hand writing slide, 40" corner unit, 4" approach overhang, two wire mgmt grommets in top
 28"- 40" x 66" x 30"H (280 lbs)

8ECWS8442R **\$5232**
 Executive single pedestal computer desk (RH) with fitted top, pencil/box/file pedestal (locking), right hand writing slide, 42" corner unit, two wire mgmt grommets in top
 30"- 42" x 84" x 30"H (375 lbs)

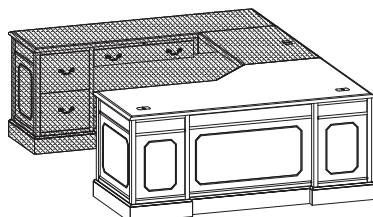

8ECWS7242R **\$4804**
 Executive single pedestal computer desk (RH) with fitted top, pencil/box/file pedestal (locking), right hand writing slide, 42" corner unit, two wire mgmt grommets in top
 30"- 42" x 72" x 30"H (340 lbs)

8ECWS7236R **\$4732**
 Executive single pedestal computer desk (RH) with fitted top, pencil/box/file pedestal (locking), right hand writing slide, 36" corner unit, two wire mgmt grommets in top
 24"- 36" x 72" x 30"H (283 lbs)

8ECWS6636R **\$4535**
 Executive single pedestal computer desk (RH) with fitted top, pencil/box/file pedestal (locking), right hand writing slide, 36" corner unit, two wire mgmt grommets in top
 24"- 36" x 66" x 30"H (260 lbs)

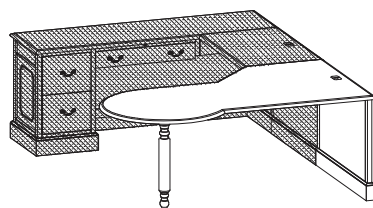

8ECWSP76R **\$3828**
 Freestanding P-Top computer desk (RH), 36" diameter end, with sculptured wood pedestal leg, 42" corner unit, one wire mgmt grommet in top
 30"-42" x 76" x 30"H (330 lbs)

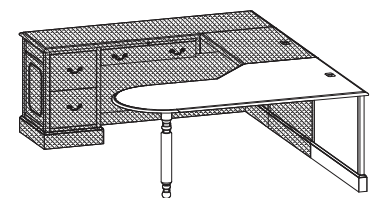

8ECWSB76R **\$3474**
 Freestanding bullet top computer desk (RH), 30" diameter end, with sculptured wood pedestal leg, 42" corner unit, one wire mgmt grommet in top
 30"-42" x 76" x 30"H (330 lbs)

MONTEBELLO SERIES

List Price

Computer Desk U Workstations - Connecting Bridges

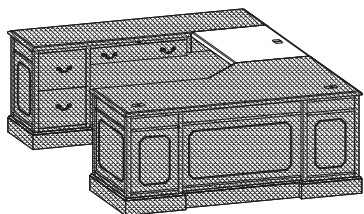

8WS42R \$1498
Executive height corner bridge (RH), one computer grommet
24" x 42" x 30"H (75 lbs)

8WS36R \$1281
Executive height corner bridge (RH), one computer grommet
24" x 36" x 30"H (65 lbs)

Computer Desk U Workstations - Single Pedestal Credenzas

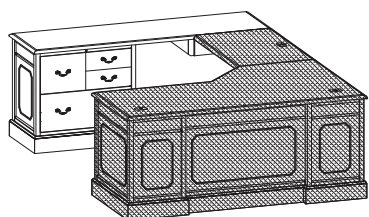

8DCSPL84FC \$4701
Single pedestal credenza (LH), file center pedestal (locking), two box, one file
drawer top, one lateral file drawer bottom, one wire mgmt grommet, 52 3/4"W kneespace
21" x 84" x 30"H (320 lbs)

8DCSPL84FC-24 - 24" x 84" x 30"H \$5130

8DCSPL72FC \$4337
Single pedestal credenza (LH), file center pedestal (locking), two box, one file
drawer top, one lateral file drawer bottom, one wire mgmt grommet, 40 3/4"W kneespace
21" x 72" x 30"H (260 lbs)

8DCSPL72FC-24 - 24" x 72" x 30"H \$4733

8DCSPL66FC \$4098
Single pedestal credenza (LH), file center pedestal (locking), two box, one file
drawer top, one lateral file drawer bottom, one wire mgmt grommet, 34 3/4"W kneespace
21" x 66" x 30"H (215 lbs)

8DCSPL66FC-24 - 24" x 66" x 30"H \$4461

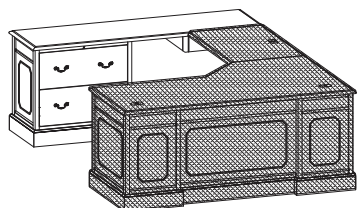

8DCSPL84LF \$4556
Single pedestal credenza (LH), two lateral file drawers (locking), legal or letter filing,
one wire mgmt grommet in back panel, 52 3/4"W kneespace
21" x 84" x 30"H (290 lbs)

8DCSPL84LF-24 - 24" x 84" x 30"H \$4985

8DCSPL72LF \$4226
Single pedestal credenza (LH), two lateral file drawers (locking), legal or letter filing,
one wire mgmt grommet in back panel, 40 3/4"W kneespace
21" x 72" x 30"H (275 lbs)

8DCSPL72LF-24 - 24" x 72" x 30"H \$4622

8DCSPL66LF \$4004
Single pedestal credenza (LH), two lateral file drawers (locking), legal or letter filing,
one wire mgmt grommet in back panel, 34 3/4"W kneespace
21" x 66" x 30"H (260 lbs)

8DCSPL66LF-24 - 24" x 66" x 30"H \$4367

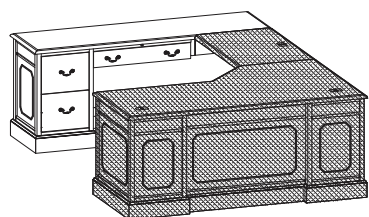

8DCSPL72 \$4212
Single pedestal credenza (LH), file/file pedestal (locking), with center/keyboard drawer in kneespace,
one wire mgmt grommet in back panel, 54"W kneespace
21" x 72" x 30"H (220 lbs)

8DCSPL72-24 - 24" x 72" x 30"H \$4608

8DCSPL66 \$2975
Single pedestal credenza (LH), pencil/box/file pedestal (locking), with center/keyboard drawer in kneespace,
one wire mgmt grommet in back panel, 48"W kneespace
21" x 66" x 30"H (205 lbs)

8DCSPL66-24 - 24" x 66" x 30"H \$3338

MONTEBELLO SERIES

List Price

Computer Desk U Workstations - Single Pedestal Desks

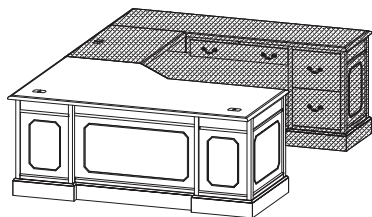

8ECWS8446L **\$5502**
 Executive single pedestal computer desk (LH) with conference top, pencil/box/file pedestal (locking), left hand writing slide, 46" corner unit, 4" approach overhang, two wire mgmt grommets in top
 34"- 46" x 84" x 30"H (385 lbs)

8ECWS7246L **\$5076**
 Executive single pedestal computer desk (LH) with conference top, pencil/box/file pedestal (locking), left hand writing slide, 46" corner unit, 4" approach overhang, two wire mgmt grommets in top
 34"- 46" x 72" x 30"H (360 lbs)

8ECWS6640L **\$4816**
 Executive single pedestal computer desk (LH) with conference top, pencil/box/file pedestal (locking), left hand writing slide, 40" corner unit, 4" approach overhang, two wire mgmt grommets in top
 28"- 40" x 66" x 30"H (280 lbs)

8ECWS8442L **\$5232**
 Executive single pedestal computer desk (LH) with fitted top, pencil/box/file pedestal (locking), left hand writing slide, 42" corner unit, two wire mgmt grommets in top
 30"- 42" x 84" x 30"H (375 lbs)

8ECWS7242L **\$4804**
 Executive single pedestal computer desk (LH) with fitted top, pencil/box/file pedestal (locking), left hand writing slide, 42" corner unit, two wire mgmt grommets in top
 30"- 42" x 72" x 30"H (340 lbs)

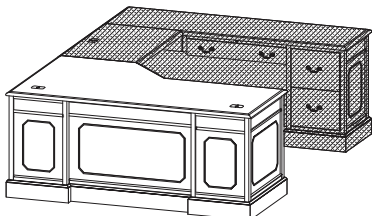

8ECWS7236L **\$4732**
 Executive single pedestal computer desk (LH) with fitted top, pencil/box/file pedestal (locking), left hand writing slide, 36" corner unit, two wire mgmt grommets in top
 24"- 36" x 72" x 30"H (283 lbs)

8ECWS6636L **\$4535**
 Executive single pedestal computer desk (LH) with fitted top, pencil/box/file pedestal (locking), left hand writing slide, 36" corner unit, two wire mgmt grommets in top
 24"- 36" x 66" x 30"H (260 lbs)

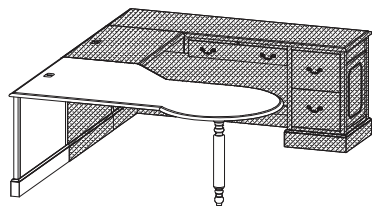

8ECWSP76L **\$3828**
 Freestanding P-Top computer desk (LH), 36" diameter end, with sculptured wood pedestal leg, 42" corner unit, one wire mgmt grommet in top
 30"-42" x 76" x 30"H (330 lbs)

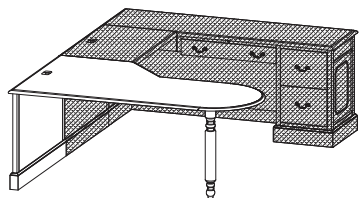

8ECWSB76L **\$3474**
 Freestanding bullet top computer desk (LH), 30" diameter end, with sculptured wood pedestal leg, 42" corner unit, one wire mgmt grommet in top
 30"-42" x 76" x 30"H (330 lbs)

MONTEBELLO SERIES

List Price

Computer Desk U Workstations - Connecting Bridges

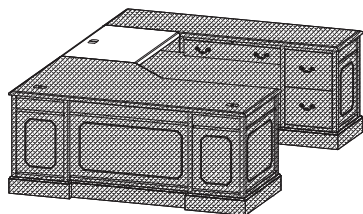

8WS42L
Executive height corner bridge (LH), one computer grommet
24" x 42" x 30"H (65 lbs)

\$1498

8WS36L
Executive height corner bridge (LH), one computer grommet
24" x 36" x 30"H (65 lbs)

\$1281

Computer Desk U Workstations - Single Pedestal Credenzas

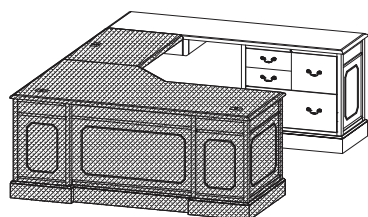

8DCSPR84FC
Single pedestal credenza (RH), file center pedestal (locking), two box, one file drawer top, one lateral file drawer bottom, one wire mgmt grommet, 52 3/4"W kneespace
21" x 84" x 30"H (320 lbs)

\$4701

8DCSPR84FC-24 - 24" x 84" x 30"H

\$5130

8DCSPR72FC
Single pedestal credenza (RH), file center pedestal (locking), two box, one file drawer top, one lateral file drawer bottom, one wire mgmt grommet, 40 3/4"W kneespace
21" x 72" x 30"H (260 lbs)

\$4337

8DCSPR72FC-24 - 24" x 72" x 30"H

\$4733

8DCSPR66FC
Single pedestal credenza (RH), file center pedestal (locking), two box, one file drawer top, one lateral file drawer bottom, one wire mgmt grommet, 34 3/4"W kneespace
21" x 66" x 30"H (215 lbs)

\$4098

8DCSPR66FC-24 - 24" x 66" x 30"H

\$4461

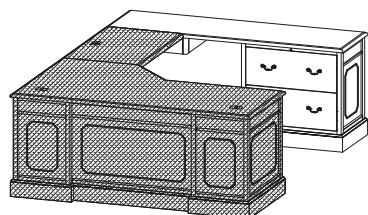

8DCSPR84LF
Single pedestal credenza (RH), two lateral file drawers (locking), legal or letter filing, one wire mgmt grommet in back panel, 52 3/4"W kneespace
21" x 84" x 30"H (290 lbs)

\$4556

8DCSPR84LF-24 - 24" x 84" x 30"H

\$4985

8DCSPR72LF
Single pedestal credenza (RH), two lateral file drawers (locking), legal or letter filing, one wire mgmt grommet in back panel, 40 3/4"W kneespace
21" x 72" x 30"H (275 lbs)

\$4226

8DCSPR72LF-24 - 24" x 72" x 30"H

\$4622

8DCSPR66LF
Single pedestal credenza (RH), two lateral file drawers (locking), legal or letter filing, one wire mgmt grommet in back panel, 34 3/4"W kneespace
21" x 66" x 30"H (260 lbs)

\$4004

8DCSPR66LF-24 - 24" x 66" x 30"H

\$4367

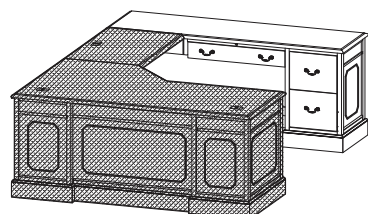

8DCSPR72
Single pedestal credenza (RH), file center pedestal (locking), with center/keyboard drawer in kneespace, one wire mgmt grommet in back panel, 54"W kneespace
21" x 72" x 30"H (220 lbs)

\$4212

8DCSPR72-24 - 24" x 72" x 30"H

\$4608

8DCSPR66
Single pedestal credenza (RH), file center pedestal (locking), with center/keyboard drawer in kneespace, one wire mgmt grommet in back panel, 48"W kneespace
21" x 66" x 30"H (205 lbs)

\$2975

8DCSPR66-24 - 24" x 66" x 30"H

\$3338

MONTEBELLO SERIES

List Price

U Configurations - Single Pedestal Desks

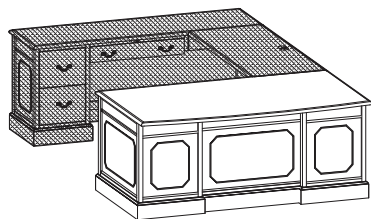

8KSPR84 \$5528
 Executive single pedestal desk (RH) with arc conference top, pencil/box/file pedestal, center drawer, central locking, right hand writing slide, 6" approach overhang
 42" x 84" x 30"H (350 lbs)

8KSPR72 \$5272
 Executive single pedestal desk (RH) with arc conference top, pencil/box/file pedestal, center drawer, central locking, right hand writing slide, 6" approach overhang
 42" x 72" x 30"H (325 lbs)

8KSPR7236 \$5148
 Executive single pedestal desk (RH) with arc conference top, pencil/box/file pedestal, center drawer, central locking, right hand writing slide, 6" approach overhang
 36" x 72" x 30"H (310 lbs)

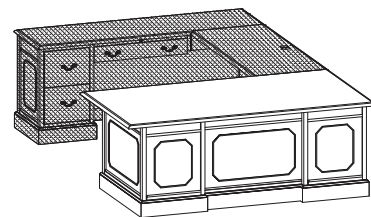

8SPR84 \$5263
 Executive single pedestal desk (RH) with conference top, pencil/box/file pedestal, center drawer, central locking, right hand writing slide, 6" approach and right side overhang
 42" x 84" x 30"H (340 lbs)

8SPR72 \$5180
 Executive single pedestal desk (RH) with conference top, pencil/box/file pedestal, center drawer, central locking, right hand writing slide, 6" approach and right side overhang
 36" x 72" x 30"H (310 lbs)

8SPR6636 \$4805
 Executive single pedestal desk (RH) with conference top, pencil/box/file pedestal, center drawer, central locking, right hand writing slide, 6" approach overhang only
 36" x 66" x 30"H (280 lbs)

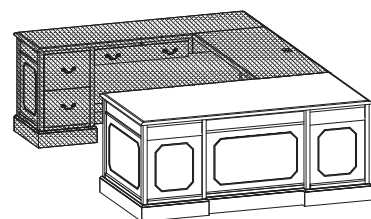

8SPR72F \$5075
 Executive single pedestal desk (RH) with fitted top, pencil/box/file pedestal, center drawer, central locking, right hand writing slide
 36" x 72" x 30"H (300 lbs)

8SPR7230 \$4680
 Executive single pedestal desk (RH) with fitted top, pencil/box/file pedestal, center drawer, central locking, right hand writing slide
 30" x 72" x 30"H (290 lbs)

8SPR66 \$4379
 Executive single pedestal desk (RH) with fitted top, pencil/box/file pedestal, center drawer, central locking, right hand writing slide
 30" x 66" x 30"H (275 lbs)

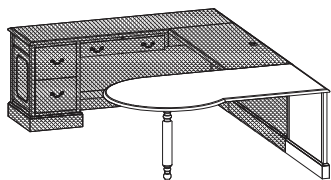

8WSP72R _ \$3229
 P-Top desk (RH), 42" diameter end, with sculptured wood pedestal leg 36"-42" x 72" x 30"H (170 lbs)

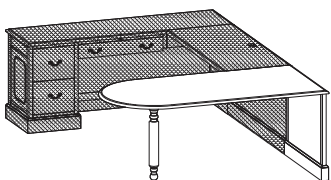

8WSB7236R _ \$2784
 Bullet top desk (RH), 36" diameter end, with sculptured wood pedestal leg, 42" corner unit
 36" x 72" x 30"H (170 lbs)

MONTEBELLO SERIES

List Price

U Configurations - Connecting Bridges

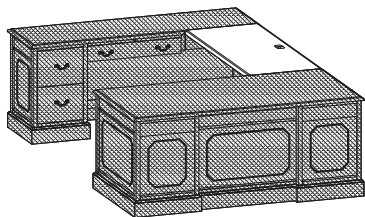

| | |
|---|---------------|
| 8WS54 Executive height bridge, one computer grommet 24" x 54" x 30"H (105 lbs) | \$1874 |
| 8WS48 Executive height bridge, one computer grommet 24" x 48" x 30"H (95 lbs) | \$1649 |
| 8WS42 Executive height bridge, one computer grommet 24" x 42" x 30"H (78 lbs) | \$1472 |

U Configurations - Single Pedestal Credenzas

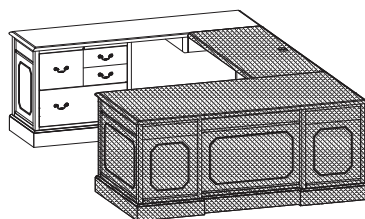

| | |
|---|---------------|
| 8DCSPL84FC Single pedestal credenza (LH), file center pedestal (locking), two box, one file drawer top, one lateral file drawer bottom, one wire mgmt grommet, 52 3/4"W kneespace 21" x 84" x 30"H (320 lbs) | \$4701 |
| 8DCSPL84FC-24 - 24" x 84" x 30"H | \$5130 |
| 8DCSPL72FC Single pedestal credenza (LH), file center pedestal (locking), two box, one file drawer top, one lateral file drawer bottom, one wire mgmt grommet, 40 3/4"W kneespace 21" x 72" x 30"H (260 lbs) | \$4337 |
| 8DCSPL72FC-24 - 24" x 72" x 30"H | \$4733 |
| 8DCSPL66FC Single pedestal credenza (LH), file center pedestal (locking), two box, one file drawer top, one lateral file drawer bottom, one wire mgmt grommet, 34 3/4"W kneespace 21" x 66" x 30"H (215 lbs) | \$4098 |
| 8DCSPL66FC-24 - 24" x 66" x 30"H | \$4461 |

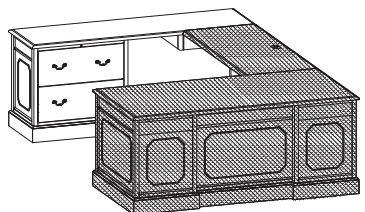

| | |
|---|---------------|
| 8DCSPL84LF Single pedestal credenza (LH), two lateral file drawers (locking), legal or letter filing, one wire mgmt grommet in back panel, 52 3/4"W kneespace 21" x 84" x 30"H (290 lbs) | \$4556 |
| 8DCSPL84LF-24 - 24" x 84" x 30"H | \$4985 |
| 8DCSPL72LF Single pedestal credenza (LH), two lateral file drawers (locking), legal or letter filing, one wire mgmt grommet in back panel, 40 3/4"W kneespace 21" x 72" x 30"H (275 lbs) | \$4226 |
| 8DCSPL72LF-24 - 24" x 72" x 30"H | \$4622 |
| 8DCSPL66LF Single pedestal credenza (LH), two lateral file drawers (locking), legal or letter filing, one wire mgmt grommet in back panel, 34 3/4"W kneespace 21" x 66" x 30"H (260 lbs) | \$4004 |
| 8DCSPL66LF-24 - 24" x 66" x 30"H | \$4367 |

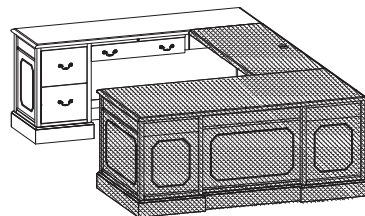

| | |
|---|---------------|
| 8DCSPL72 Single pedestal credenza (LH), file/file pedestal (locking), with center/keyboard drawer in kneespace, one wire mgmt grommet in back panel, 54"W kneespace 21" x 72" x 30"H (220 lbs) | \$4212 |
| 8DCSPL72-24 - 24" x 72" x 30"H | \$4608 |
| 8DCSPL66 Single pedestal credenza (LH), pencil/box/file pedestal (locking), with center/keyboard drawer in kneespace, one wire mgmt grommet in back panel, 48"W kneespace 21" x 66" x 30"H (205 lbs) | \$2975 |
| 8DCSPL66-24 - 24" x 66" x 30"H | \$3338 |

MONTEBELLO SERIES

List Price

U Configurations - Single Pedestal Desks

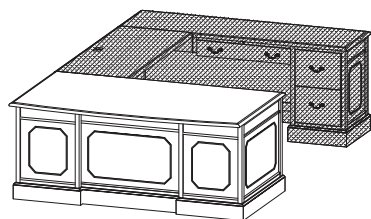

8KSPL84 \$5528
 Executive single pedestal desk (LH) with arc conference top, pencil/box/file pedestal, center drawer, central locking, left hand writing slide, 6" approach overhang
 42" x 84" x 30"H (350 lbs)

8KSPL72 \$5272
 Executive single pedestal desk (LH) with arc conference top, pencil/box/file pedestal, center drawer, central locking, left hand writing slide, 6" approach overhang
 42" x 72" x 30"H (325 lbs)

8KSPL7236 \$5148
 Executive single pedestal desk (LH) with arc conference top, pencil/box/file pedestal, center drawer, central locking, left hand writing slide, 6" approach overhang
 36" x 72" x 30"H (310 lbs)

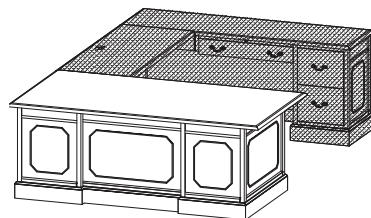

8SPL84 \$5263
 Executive single pedestal desk (LH) with conference top, pencil/box/file pedestal, center drawer, central locking, left hand writing slide, 6" approach and left side overhang
 42" x 84" x 30"H (340 lbs)

8SPL72 \$5180
 Executive single pedestal desk (LH) with conference top, pencil/box/file pedestal, center drawer, central locking, left hand writing slide, 6" approach and left side overhang
 36" x 72" x 30"H (310 lbs)

8SPL6636 \$4805
 Executive single pedestal desk (LH) with conference top, pencil/box/file pedestal, center drawer, central locking, left hand writing slide, 6" approach overhang only
 36" x 66" x 30"H (280 lbs)

8SPL72F \$5075
 Executive single pedestal desk (LH) with fitted top, pencil/box/file pedestal, center drawer, central locking, left hand writing slide
 36" x 72" x 30"H (300 lbs)

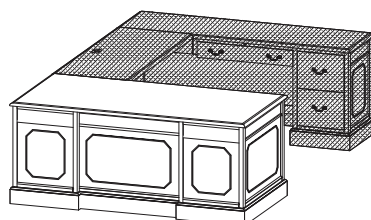

8SPL7230 \$4680
 Executive single pedestal desk (LH) with fitted top, pencil/box/file pedestal, center drawer, central locking, left hand writing slide
 30" x 72" x 30"H (290 lbs)

8SPL66 \$4379
 Executive single pedestal desk (LH) with fitted top, pencil/box/file pedestal, center drawer, central locking, left hand writing slide
 30" x 66" x 30"H (275 lbs)

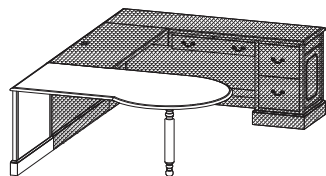

8WSP72L _ \$3229
 P-Top desk (LH), 42" diameter end, with sculptured wood pedestal leg 36"-42" x 72" x 30"H (170 lbs)

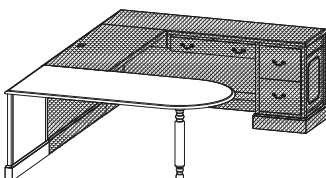

8WSB7236L _ \$2784
 Bullet top desk (LH), 36" diameter end, with sculptured wood pedestal leg, 42" corner unit
 36" x 72" x 30"H (170 lbs)

MONTEBELLO SERIES

List Price

U Configurations - Connecting Bridges

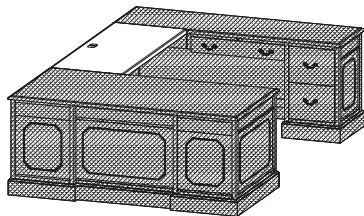

| | |
|---|---------------|
| 8WS54 Executive height bridge, one computer grommet 24" x 54" x 30"H (105 lbs) | \$1874 |
| 8WS48 Executive height bridge, one computer grommet 24" x 48" x 30"H (95 lbs) | \$1649 |
| 8WS42 Executive height bridge, one computer grommet 24" x 42" x 30"H (78 lbs) | \$1472 |

U Configurations - Single Pedestal Credenzas

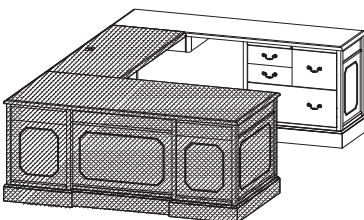

| | |
|---|---------------|
| 8DCSPR84FC Single pedestal credenza (RH), file center pedestal (locking), two box, one file drawer top, one lateral file drawer bottom, one wire mgmt grommet, 52 3/4"W kneespace 21" x 84" x 30"H (320 lbs) | \$4701 |
| 8DCSPR84FC-24 - 24" x 84" x 30"H | \$5130 |
| 8DCSPR72FC Single pedestal credenza (RH), file center pedestal (locking), two box, one file drawer top, one lateral file drawer bottom, one wire mgmt grommet, 40 3/4"W kneespace 21" x 72" x 30"H (260 lbs) | \$4337 |
| 8DCSPR72FC-24 - 24" x 72" x 30"H | \$4733 |
| 8DCSPR66FC Single pedestal credenza (RH), file center pedestal (locking), two box, one file drawer top, one lateral file drawer bottom, one wire mgmt grommet, 34 3/4"W kneespace 21" x 66" x 30"H (215 lbs) | \$4098 |
| 8DCSPR66FC-24 - 24" x 66" x 30"H | \$4461 |

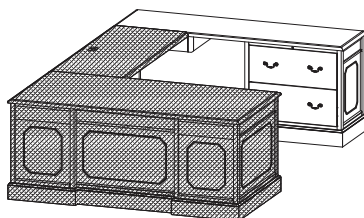

| | |
|---|---------------|
| 8DCSPR84LF Single pedestal credenza (RH), two lateral file drawers (locking), legal or letter filing, one wire mgmt grommet in back panel, 52 3/4"W kneespace 21" x 84" x 30"H (290 lbs) | \$4556 |
| 8DCSPR84LF-24 - 24" x 84" x 30"H | \$4985 |
| 8DCSPR72LF Single pedestal credenza (RH), two lateral file drawers (locking), legal or letter filing, one wire mgmt grommet in back panel, 40 3/4"W kneespace 21" x 72" x 30"H (275 lbs) | \$4226 |
| 8DCSPR72LF-24 - 24" x 72" x 30"H | \$4622 |
| 8DCSPR66LF Single pedestal credenza (RH), two lateral file drawers (locking), legal or letter filing, one wire mgmt grommet in back panel, 34 3/4"W kneespace 21" x 66" x 30"H (260 lbs) | \$4004 |
| 8DCSPR66LF-24 - 24" x 66" x 30"H | \$4367 |

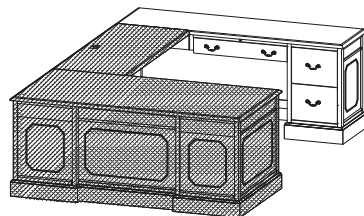

| | |
|---|---------------|
| 8DCSPR72 Single pedestal credenza (RH), file center pedestal (locking), with center/keyboard drawer in kneespace, one wire mgmt grommet in back panel, 54"W kneespace 21" x 72" x 30"H (220 lbs) | \$4212 |
| 8DCSPR72-24 - 24" x 72" x 30"H | \$4608 |
| 8DCSPR66 Single pedestal credenza (RH), file center pedestal (locking), with center/keyboard drawer in kneespace, one wire mgmt grommet in back panel, 48"W kneespace 21" x 66" x 30"H (205 lbs) | \$2975 |
| 8DCSPR66-24 - 24" x 66" x 30"H | \$3338 |

MONTEBELLO SERIES

List Price

Hutches

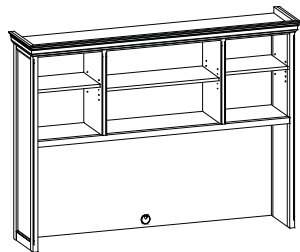

8HO81-O \$4285
 Overhead storage unit, open, three storage areas, one adjustable shelf per section, cornice top, two wire mgmt access grommets in center back panel
 26 3/4" clearance between apron rail & worksurface
 15 1/2" x 81" x 53"H (280 lbs)

8HO69-O \$4140
 Overhead storage unit, open, three storage areas, one adjustable shelf per section, cornice top, two wire mgmt access grommets in center back panel
 26 3/4" clearance between apron rail & worksurface
 15 1/2" x 69" x 53"H (210 lbs)

8HO63-O \$3786
 Overhead storage unit, open, three storage areas, one adjustable shelf per section, cornice top, two wire mgmt access grommets in center back panel
 26 3/4" clearance between apron rail & worksurface
 15 1/2" x 63" x 53"H (180 lbs)

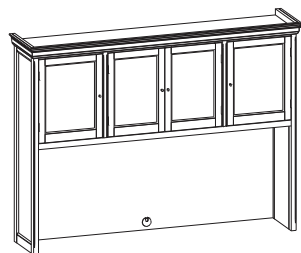

8HO81-W \$5460
 Overhead storage unit with hinged wood doors (non-locking), three storage areas behind four hinged doors, one adjustable shelf per section, cornice top, two wire mgmt access grommets in center back panel
 26 3/4" clearance between apron rail & worksurface
 15 1/2" x 81" x 53"H (280 lbs)

8HO69-W \$4996
 Overhead storage unit with hinged wood doors (non-locking), three storage areas behind four hinged doors, one adjustable shelf per section, cornice top, two wire mgmt access grommets in center back panel
 26 3/4" clearance between apron rail & worksurface
 15 1/2" x 69" x 53"H (210 lbs)

8HO63-W \$4670
 Overhead storage unit with hinged wood doors (non-locking), three storage areas behind four hinged doors, one adjustable shelf per section, cornice top, two wire mgmt access grommets in center back panel
 26 3/4" clearance between apron rail & worksurface
 15 1/2" x 63" x 53"H (180 lbs)

Accessories



TB77 \$474
 Fabric tackboard, (COM, Grade A, Grade B) 3/4" x 77" x 15 1/2"H (20 lbs)

TB65 \$400
 Fabric tackboard, (COM, Grade A, Grade B) 3/4" x 65" x 15 1/2"H (16 lbs)

TB59 \$386
 Fabric tackboard, (COM, Grade A, Grade B) 3/4" x 59" x 15 1/2"H (14 lbs)



TL48 \$215
 Task light (UL approved), 6" x 48" x 1 1/2"H (15 lbs)

TL24 \$185
 Task light (UL approved), 6" x 24" x 1 1/2"H (10 lbs)

MONTEBELLO SERIES

List Price

Hutches

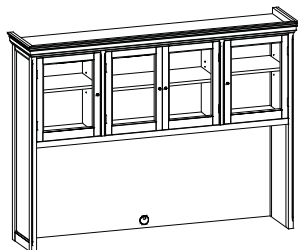

8HO81-G **\$5320**
 Overhead storage unit with hinged glass doors (non-locking), three storage areas behind four hinged doors, one adjustable shelf per section, cornice top, two wire mgmt access grommets in center back panel
 26 3/4" clearance between apron rail & worksurface
 15 1/2" x 81" x 53"H (280 lbs)

8HO69-G **\$5034**
 Overhead storage unit with hinged glass doors (non-locking), three storage areas behind four hinged doors, one adjustable shelf per section, cornice top, two wire mgmt access grommets in center back panel
 26 3/4" clearance between apron rail & worksurface
 15 1/2" x 69" x 53"H (210 lbs)

8HO63-G **\$4753**
 Overhead storage unit with hinged glass doors (non-locking), three storage areas behind four hinged doors, one adjustable shelf per section, cornice top, two wire mgmt access grommets in center back panel
 26 3/4" clearance between apron rail & worksurface
 15 1/2" x 63" x 53"H (180 lbs)

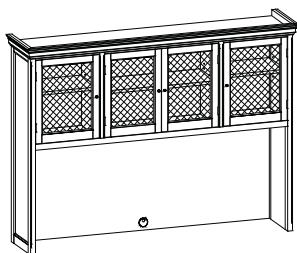

8HO81-M **\$5720**
 Overhead storage unit with hinged woven wire mesh doors (non-locking), three storage areas behind four hinged doors, one adjustable shelf per section, cornice top, two wire mgmt access grommets in center back panel
 26 3/4" clearance between apron rail & worksurface
 15 1/2" x 81" x 53"H (280 lbs)

8HO69-M **\$5450**
 Overhead storage unit with hinged woven wire mesh doors (non-locking), three storage areas behind four hinged doors, one adjustable shelf per section, cornice top, two wire mgmt access grommets in center back panel
 26 3/4" clearance between apron rail & worksurface
 15 1/2" x 69" x 53"H (210 lbs)

8HO63-M **\$5195**
 Overhead storage unit with hinged woven wire mesh doors (non-locking), three storage areas behind four hinged doors, one adjustable shelf per section, cornice top, two wire mgmt access grommets in center back panel
 26 3/4" clearance between apron rail & worksurface
 15 1/2" x 63" x 53"H (180 lbs)

Accessories



TB77 **\$474**
 Fabric tackboard, (COM, Grade A, Grade B) 3/4" x 77" x 15 1/2"H (20 lbs)

TB65 **\$400**
 Fabric tackboard, (COM, Grade A, Grade B) 3/4" x 65" x 15 1/2"H (16 lbs)

TB59 **\$386**
 Fabric tackboard, (COM, Grade A, Grade B) 3/4" x 59" x 15 1/2"H (14 lbs)



TL48 **\$215**
 Task light (UL approved), 6" x 48" x 1 1/2"H (15 lbs)

TL24 **\$185**
 Task light (UL approved), 6" x 24" x 1 1/2"H (10 lbs)

MONTEBELLO SERIES

List Price

Hutches

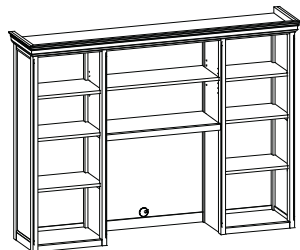

8HC81-O **\$4696**
 Open hutch, three storage areas, three adjustable shelves in outer sections, one adjustable shelf in center section, cornice top, two wire mgmt access grommets in center back panel
 26 3/4" clearance between apron rail & worksurface
 15 1/2" x 81" x 53"H (210 lbs)

8HC69-O **\$4098**
 Open hutch, three storage areas, three adjustable shelves in outer sections, one adjustable shelf in center section, cornice top, two wire mgmt access grommets in center back panel
 26 3/4" clearance between apron rail & worksurface
 15 1/2" x 69" x 53"H (210 lbs)

8HC63-O **\$3822**
 Open hutch, three storage areas, three adjustable shelves in outer sections, one adjustable shelf in center section, cornice top, two wire mgmt access grommets in center back panel
 26 3/4" clearance between apron rail & worksurface
 15 1/2" x 63" x 53"H (180 lbs)

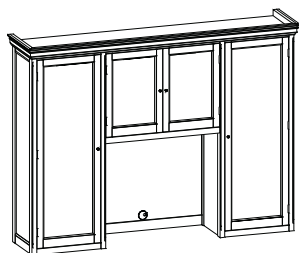

8HC81-W **\$6350**
 Hutch, hinged wooden doors (non-locking), three storage areas, three adjustable shelves in outer sections, one adjustable shelf in center section, cornice top, two wire mgmt access grommets in center back panel, 26 3/4" clearance between apron rail & worksurface
 15 1/2" x 81" x 53"H (280 lbs)

8HC69-W **\$5893**
 Hutch, hinged wooden doors (non-locking), three storage areas, three adjustable shelves in outer sections, one adjustable shelf in center section, cornice top, two wire mgmt access grommets in center back panel, 26 3/4" clearance between apron rail & worksurface
 15 1/2" x 69" x 53"H (210 lbs)

8HC63-W **\$5429**
 Hutch, hinged wooden doors (non-locking), three storage areas, three adjustable shelves in outer sections, one adjustable shelf in center section, cornice top, two wire mgmt access grommets in center back panel, 26 3/4" clearance between apron rail & worksurface
 15 1/2" x 63" x 53"H (180 lbs)

Accessories



TB41 **\$272**
 Fabric tackboard, (COM, Grade A, Grade B) 3/4" x 41" x 15 1/2"H (20 lbs)

TB29 **\$196**
 Fabric tackboard, (COM, Grade A, Grade B) 3/4" x 29" x 15 1/2"H (16 lbs)

TB23 **\$159**
 Fabric tackboard, (COM, Grade A, Grade B) 3/4" x 23" x 15 1/2"H (14 lbs)



TL48 **\$215**
 Task light (UL approved), 6" x 48" x 1 1/2"H (15 lbs)

TL24 **\$185**
 Task light (UL approved), 6" x 24" x 1 1/2"H (10 lbs)

MONTEBELLO SERIES

List Price

Hutches

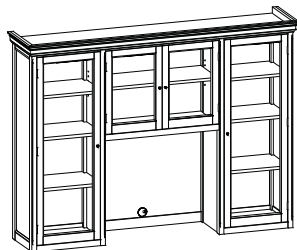

8HC81-G **\$6006**
 Hutch, hinged glass doors (non-locking), three storage areas, three adjustable shelves in outer sections, one adjustable shelf in center section, cornice top, two wire mgmt access grommets in center back panel, 26 3/4" clearance between apron rail & worksurface
 15 1/2" x 81" x 53"H (280 lbs)

8HC69-G **\$5657**
 Hutch, hinged glass doors (non-locking), three storage areas, three adjustable shelves in outer sections, one adjustable shelf in center section, cornice top, two wire mgmt access grommets in center back panel, 26 3/4" clearance between apron rail & worksurface
 15 1/2" x 69" x 53"H (210 lbs)

8HC63-G **\$5211**
 Hutch, hinged glass doors (non-locking), three storage areas, three adjustable shelves in outer sections, one adjustable shelf in center section, cornice top, two wire mgmt access grommets in center back panel, 26 3/4" clearance between apron rail & worksurface
 15 1/2" x 63" x 53"H (180 lbs)

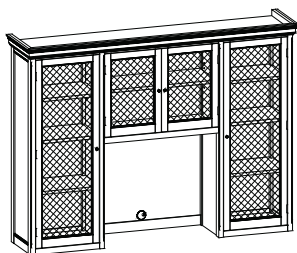

8HC81-M **\$7041**
 Hutch, hinged woven mesh doors (non-locking), three storage areas, three adjustable shelves in outer sections, one adjustable shelf in center section, cornice top, two wire mgmt access grommets in center back panel, 26 3/4" clearance between apron rail & worksurface
 15 1/2" x 81" x 53"H (280 lbs)

8HC69-M **\$6727**
 Hutch, hinged woven mesh doors (non-locking), three storage areas, three adjustable shelves in outer sections, one adjustable shelf in center section, cornice top, two wire mgmt access grommets in center back panel, 26 3/4" clearance between apron rail & worksurface
 15 1/2" x 69" x 53"H (210 lbs)

8HC63-M **\$6220**
 Hutch, hinged woven mesh doors (non-locking), three storage areas, three adjustable shelves in outer sections, one adjustable shelf in center section, cornice top, two wire mgmt access grommets in center back panel, 26 3/4" clearance between apron rail & worksurface
 15 1/2" x 63" x 53"H (180 lbs)

Accessories



TB41 **\$272**
 Fabric tackboard, (COM, Grade A, Grade B) 3/4" x 41" x 15 1/2"H (20 lbs)

TB29 **\$196**
 Fabric tackboard, (COM, Grade A, Grade B) 3/4" x 29" x 15 1/2"H (16 lbs)

TB23 **\$159**
 Fabric tackboard, (COM, Grade A, Grade B) 3/4" x 23" x 15 1/2"H (14 lbs)



TL48 **\$215**
 Task light (UL approved), 6" x 48" x 1 1/2"H (15 lbs)

TL24 **\$185**
 Task light (UL approved), 6" x 24" x 1 1/2"H (10 lbs)

MONTEBELLO SERIES

List Price

Hutches

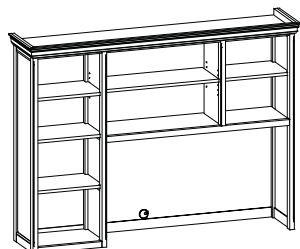

(Left version shown)

8HR81-O (right) \$4795
8HL81-O (left)

Open hutch, three storage areas, three adjustable shelves in outer riser section, one adjustable shelf in each upper overhead section, cornice top, two wire mgmt access grommets in center back panel
 26 3/4" clearance between apron rail & worksurface
 15 1/2" x 81" x 53"H (lbs)

8HR69-O (right) \$4212
8HL69-O (left)

Open hutch, three storage areas, three adjustable shelves in outer riser section, one adjustable shelf in each upper overhead section, cornice top, two wire mgmt access grommets in center back panel
 26 3/4" clearance between apron rail & worksurface
 15 1/2" x 69" x 53"H (lbs)

8HR63-O_ (right) \$4020
8HL63-O_ (left)

Open hutch, three storage areas, three adjustable shelves in outer riser section, one adjustable shelf in each upper overhead section, cornice top, two wire mgmt access grommets in center back panel
 26 3/4" clearance between apron rail & worksurface
 15 1/2" x 63" x 53"H (lbs)

8HR81-W (right) \$6251
8HL81-W (left)

Hutch, hinged wooden doors (non-locking), three storage areas, three adjustable shelves in outer riser section, one adjustable shelf in each upper overhead section, cornice top, two wire mgmt access grommets in center back panel, 26 3/4" clearance between apron rail & worksurface
 15 1/2" x 81" x 53"H (lbs)

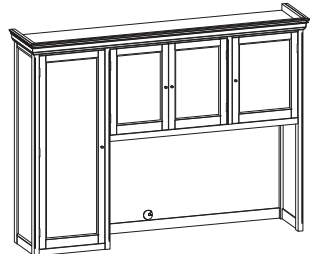

(Left version shown)

8HR69-W (right) \$5471
8HL69-W (left)

Hutch, hinged wooden doors (non-locking), three storage areas, three adjustable shelves in outer riser section, one adjustable shelf in each upper overhead section, cornice top, two wire mgmt access grommets in center back panel, 26 3/4" clearance between apron rail & worksurface
 15 1/2" x 69" x 53"H (lbs)

8HR63-W (right) \$5112
8HL63-W (left)

Hutch, hinged wooden doors (non-locking), three storage areas, three adjustable shelves in outer riser section, one adjustable shelf in each upper overhead section, cornice top, two wire mgmt access grommets in center back panel, 26 3/4" clearance between apron rail & worksurface
 15 1/2" x 63" x 53"H (lbs)

Accessories



TB59 \$386
 Fabric tackboard, (COM, Grade A, Grade B) 3/4" x 59" x 15 1/2"H (14 lbs)

TB47 \$338
 Fabric tackboard, (COM, Grade A, Grade B) 3/4" x 47" x 15 1/2"H (16 lbs)

TB41 \$272
 Fabric tackboard, (COM, Grade A, Grade B) 3/4" x 41" x 15 1/2"H (11 lbs)



TL48 \$215
 Task light (UL approved), 6" x 48" x 1 1/2"H (15 lbs)

TL24 \$185
 Task light (UL approved), 6" x 24" x 1 1/2"H (10 lbs)

MONTEBELLO SERIES

List Price

Hutches

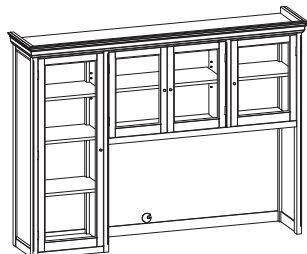

(Left version shown)

8HR81-G (right) \$5736
8HL81-G (left)

Hutch, hinged glass doors (non-locking), three storage areas, three adjustable shelves in outer riser section, one adjustable shelf in each upper overhead section, cornice top, two wire mgmt access grommets in center back panel, 26 3/4" clearance between apron rail & worksurface 15 1/2" x 81" x 53"H (lbs)

8HR69-G (right) \$5242
8HL69-G (left)

Hutch, hinged glass doors (non-locking), three storage areas, three adjustable shelves in outer riser section, one adjustable shelf in each upper overhead section, cornice top, two wire mgmt access grommets in center back panel, 26 3/4" clearance between apron rail & worksurface 15 1/2" x 69" x 53"H (lbs)

8HR63-G (right) \$4961
8HL63-G (left)

Hutch, hinged glass doors (non-locking), three storage areas, three adjustable shelves in outer riser section, one adjustable shelf in each upper overhead section, cornice top, two wire mgmt access grommets in center back panel, 26 3/4" clearance between apron rail & worksurface 15 1/2" x 63" x 53"H (lbs)

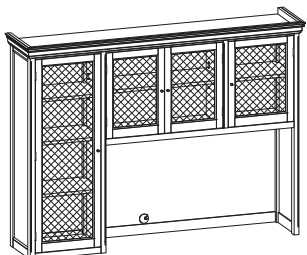

(Left version shown)

8HR81-M (right) \$6781
8HL81-M (left)

Hutch, hinged woven wire mesh doors (non-locking), three storage areas, three adjustable shelves in outer riser section, one adjustable shelf in each upper overhead section, cornice top, two wire mgmt access grommets in center back panel, 26 3/4" clearance between apron rail & worksurface 15 1/2" x 81" x 53"H (lbs)

8HR69-M (right) \$5934
8HL69-M (left)

Hutch, hinged woven wire mesh doors (non-locking), three storage areas, three adjustable shelves in outer riser section, one adjustable shelf in each upper overhead section, cornice top, two wire mgmt access grommets in center back panel, 26 3/4" clearance between apron rail & worksurface 15 1/2" x 69" x 53"H (lbs)

8HR63-M (right) \$5544
8HL63-M (left)

Hutch, hinged woven wire mesh doors (non-locking), three storage areas, three adjustable shelves in outer riser section, one adjustable shelf in each upper overhead section, cornice top, two wire mgmt access grommets in center back panel, 26 3/4" clearance between apron rail & worksurface 15 1/2" x 63" x 53"H (lbs)

Accessories



TB59 \$386
 Fabric tackboard, (COM, Grade A, Grade B) 3/4" x 59" x 15 1/2"H (14 lbs)

TB47 \$338
 Fabric tackboard, (COM, Grade A, Grade B) 3/4" x 47" x 15 1/2"H (16 lbs)

TB41 \$272
 Fabric tackboard, (COM, Grade A, Grade B) 3/4" x 41" x 15 1/2"H (11 lbs)



TL48 \$215
 Task light (UL approved), 6" x 48" x 1 1/2"H (15 lbs)

TL24 \$185
 Task light (UL approved), 6" x 24" x 1 1/2"H (10 lbs)

MONTEBELLO SERIES

List Price

Bookcases

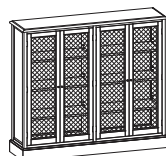
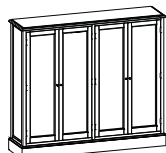
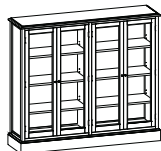
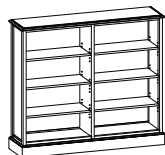

8BCO-84 **\$3609**
 Open bookcase with four adjustable and two fixed shelves (bottom & middle)
 15 1/2" x 39" x 84"H (225 lbs) ****unit must be permanently attached to wall**

8BCO-72 **\$3546**
 Open bookcase with three adjustable and two fixed shelves (bottom & middle)
 15 1/2" x 39" x 72"H (196 lbs)

8BCO-48 **\$2628**
 Open bookcase with three adjustable and one fixed bottom shelf
 15 1/2" x 39" x 48"H (140 lbs)

8BCO-30 **\$1632**
 Open bookcase with one adjustable and one fixed bottom shelf
 15 1/2" x 35" x 30"H (65 lbs)

8BC-G **\$3158**
 Bookcase with glass doors (non-locking), three adjustable shelves and one fixed shelf (bottom)
 15 1/2" x 39" x 48"H (150 lbs)

8BC-W **\$3345**
 Bookcase with wood doors (non-locking), three adjustable shelves and one fixed shelf (bottom)
 15 1/2" x 39" x 48"H (150 lbs)

8BC-M **\$3890**
 Bookcase with woven wire mesh grille doors (non-locking), three adjustable shelves and one fixed shelf (bottom)
 15 1/2" x 39" x 48"H (150 lbs)

8BC2-O **\$4295**
 Double unit open bookcase with three adjustable shelves and one fixed shelf (bottom) in each section
 15 1/2" x 60" x 53"H (230 lbs)

8BC2-G **\$4892**
 Double unit bookcase with glass doors, three adjustable shelves and one fixed shelf (bottom) in each section
 15 1/2" x 60" x 53"H (250 lbs)

8BC2-W **\$5106**
 Double unit bookcase with wood doors, three adjustable shelves and one fixed shelf (bottom) in each section
 15 1/2" x 60" x 53"H (250 lbs)

8BC2-M **\$5471**
 Double unit bookcase with woven wire mesh grille doors, three adjustable shelves and one fixed shelf (bottom) in each section
 15 1/2" x 60" x 53"H (250 lbs)

MONTEBELLO SERIES

List Price

Hutches

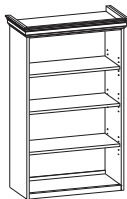

| | | |
|-------------------|---|---------------|
| 8OSU1-32-O | Open (shown) | \$2434 |
| 8OSU1-32-G | Glass doors (non-locking) | \$2985 |
| 8OSU1-32-W | Wood doors (non-locking) | \$3131 |
| 8OSU1-32-M | Woven wire mesh grille doors (non-locking) | \$3495 |

Single unit hutch with three adjustable shelves per section, cornice top
 **properly fits on 32" wide lower unit
 15 1/2" x 31 1/2" x 53"H (110 lbs)
 Optional locking doors (LK) - add \$55 list per set of doors

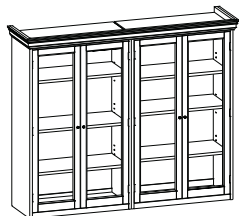

| | | |
|-------------------|---|---------------|
| 8OSU2-60-O | Open | \$4129 |
| 8OSU2-60-G | Glass doors (non-locking) (shown) | \$5008 |
| 8OSU2-60-W | Wood doors (non-locking) | \$5346 |
| 8OSU2-60-M | Woven wire mesh grille doors (non-locking) | \$5726 |

Double unit hutch with three adjustable shelves per section, cornice top
 **properly fits on 60" wide lower unit
 **ships in three (3) pieces
 15 1/2" x 59 1/2" x 53"H (220 lbs)
 Optional locking doors (LK) - add \$55 list per set of doors

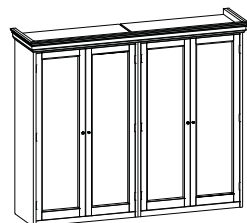

| | | |
|-------------------|---|---------------|
| 8OSU2-66-O | Open | \$4452 |
| 8OSU2-66-G | Glass doors (non-locking) | \$5398 |
| 8OSU2-66-W | Wood doors (non-locking) (shown) | \$5616 |
| 8OSU2-66-M | Woven wire mesh grille doors (non-locking) | \$6048 |

Double unit hutch with three adjustable shelves per section, cornice top
 **properly fits on 66" wide lower unit
 **ships in three (3) pieces
 15 1/2" x 65 1/2" x 53"H (250 lbs)
 Optional locking doors (LK) - add \$55 list per set of doors

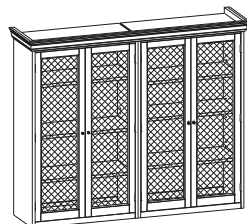

| | | |
|-------------------|---|---------------|
| 8OSU2-72-O | Open | \$4686 |
| 8OSU2-72-G | Glass doors (non-locking) | \$5554 |
| 8OSU2-72-W | Wood doors (non-locking) | \$5835 |
| 8OSU2-72-M | Woven wire mesh grille doors (non-locking) (shown) | \$6240 |

Double unit hutch with three adjustable shelves per section, cornice top
 **properly fits on 72" wide lower unit
 **ships in three (3) pieces
 15 1/2" x 71 1/2" x 53"H (275 lbs)
 Optional locking doors (LK) - add \$55 list per set of doors

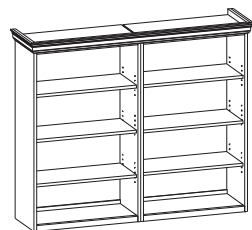

| | | |
|-------------------|---|---------------|
| 8OSU2-84-O | Open (shown) | \$4961 |
| 8OSU2-84-G | Glass doors (non-locking) | \$5809 |
| 8OSU2-84-W | Wood doors (non-locking) | \$6043 |
| 8OSU2-84-M | Woven wire mesh grille doors (non-locking) | \$6474 |

Double unit hutch with three adjustable shelves per section, cornice top
 **properly fits on 84" wide lower unit
 **ships in three (3) pieces
 15 1/2" x 83 1/2" x 53"H (300 lbs)
 Optional locking doors (LK) - add \$55 list per set of doors

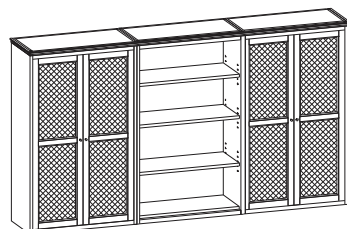

| | | |
|---------------------|---|---------------|
| 8OSU3-90-O | Open | \$5596 |
| 8OSU3-90-G | Glass doors (non-locking) | \$7395 |
| 8OSU3-90-GOG | Glass doors/Open/Glass doors (non-locking) | \$6937 |
| 8OSU3-90-W | Wood doors (non-locking) | \$7712 |
| 8OSU3-90-WOW | Wood/Open/Wood doors (non-locking) | \$7124 |
| 8OSU3-90-M | Woven wire mesh grille doors (non-locking) | \$8102 |
| 8OSU3-90-MOM | Wire mesh/Open/Wire mesh (non-locking) (shown) | \$7572 |

Single unit hutch with three adjustable shelves per section, cornice top
 **properly fits on 90" wide lower unit
 **ships in four (4) pieces
 15 1/2" x 89 1/2" x 53"H (350 lbs)
 Optional locking doors (LK) - add \$55 list per set of doors

MONTEBELLO SERIES

List Price

Accessories

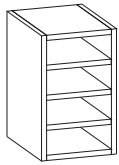

8PSA
 Portable work organizer, with three paper trays
 15" x 12" x 17"H (20 lbs)

\$600



8WB
 Wastebasket, wooden
 12" x 12" x 16"H (14 lbs)

\$579



8C
 Costumer, turned post, solid wood
 66"H (15 lbs)

\$544

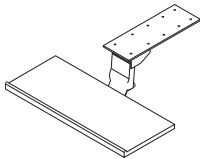

AKPW
 Articulating keyboard - leverless, with non- handed mouse pad, 5" height adjustment, 25 degree tilt - 360 degree swivel, wooden keyboard tray - specify finish
 11 1/4" x 21 1/2" x 2 3/4"H (25 lbs)

\$472

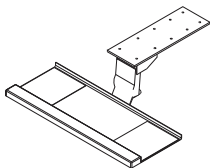

AKP
 Articulating keyboard - leverless, with non- handed mouse pad, 5" height adjustment, 25 degree tilt - 360 degree swivel, black molded keyboard tray
 11" x 25" x 2 3/4"H (21 lbs)

\$337

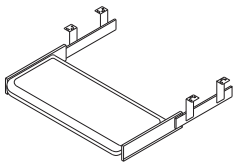

KD
 Pull-out keyboard - leverless, black molded keyboard tray
 10 5/8" x 21 1/2" x 3 5/8"H (8 lbs)

\$153



LH
 Wire mgmt channel, 22" length - set of four, double sided velcro attachment

\$83

GEORGIAN SERIES



Rich traditional design, meticulously hand-crafted. The Georgian Series features solid cherry, oak or walnut rims and moulding with bookmatched veneers accented by antiqued brass drawer pulls. Catalyzed varnish finish, mortise and tenon – groove and tenon construction, full extension file drawers with dovetail construction, center drawers with central locking in all desks are standard on this series. All items are available in a choice of 15 cherry, mahogany, oak and walnut finishes.

GEORGIAN SERIES

Finishes Available

Walnut

Natural Walnut



Richleigh Walnut



Royal Walnut



Empire Walnut



Old World Mahogany



Crescent Cherry on Walnut



Espresso



Cherry

Natural Cherry



Amber Cherry



Cinnamon Cherry



Collector's Cherry



Mocha Cherry



Mahogany on Cherry



Oak

Landmark Oak



Harbor Oak



**The finishes shown on this page have been reproduced as accurately as possible, however, due to the printing process some finishes may vary slightly from the actual finish samples originally photographed. In addition, due to the nature of wood, it is possible that some slight variations in color and grain character may occur naturally (which is the beauty of a natural product). Wood finish chips are available for each of the above finishes if requested (please call customer service).

GEORGIAN SERIES



Options Available

| | | |
|-----|---|--------------------------|
| HPL | Matching high pressure laminate substituted for wood top - Contact customer service for matching finish selections | \$ N/C |
| BW | Burl walnut top | \$ 2102 |
| MBC | Madrone burl top (cherry species only) | \$ 2074 |
| LTH | Leather inlay (desk tops only) – black, burgundy, forest green | \$ 2230 |
| FEP | Franklin top edge profile (replaces standard Georgian profile) | \$ N/C |
| GS | Georgian scroll base (replaces standard box base) | \$ N/C |
| BB | Brushed brass pulls (replace standard antique brass pulls) | \$ 22 per pull |
| FF | Change PBF pedestal to F/F (no writing slide above pedestal) | \$ N/C |
| CPU | Change PBF or FF pedestal to CPU pedestal - inside dimensions: 14 3/16"Wx17 13/16"Dx22 3/8"H - hinged door (non-locking), two ventilation slots in back panel and inside end panel grommet | \$ 110 |
| PNT | Change lateral file or file center pedestal to printer pedestal - inside dimensions: 27 1/2"Wx17 13/16"Dx22 3/8"H - slide out printer shelf, wall access cut-out in back modesty and inside end panel grommet | \$ 110 |
| LK | Locking of individual doors, drawers or pedestals (where not standard) | \$ 55 |
| FS | Freestanding unit - change from connecting unit (notched) to freestanding unit | \$ 88 |
| GR | Wire mgmt grommet (note location) | \$ 61 |
| WA | Wall access cut-out (modesty panels on bridges, credenzas, desks and returns) | \$ N/C |
| AHM | Electronic height adjustable mechanism added to worksurface, lifting column, control box, control pendant, with memory settings, motor cable, main power cable, anti-collision dongle. Lower metal lifts and anti-tip brackets. Adjusts from 30" - 44"H | Contact Customer Service |

GEORGIAN SERIES

Warranty and Certification

All products listed are warranted against defects of material and workmanship under normal use and service for a minimum of 10 years from the date of installation (see full warranty information). All products listed are Level 2 BIFMA certified.

Veneer

Veneer on all exposed surfaces is #1 plain sliced American Black Walnut, Cherry or Oak. Outside surface veneers are book matched to provide proper grain consistency and uniform grain appearance. Drawer fronts are vertical grain walnut, cherry or oak veneers and matched in selected sets to ensure proper veneer balance and uniform grain appearance.

Wood Veneer Tops

1" thick tops utilizing 3-ply construction with solid walnut, cherry or oak lumber rims, shaped with two traditional style edge details. Top cores are high density particle board. Rims on all four sides are precisely mitered on all four corners. Walnut, cherry or oak veneer tops are standard. Burl, leather inlay and high pressure laminate tops are optional.

Modesty Panels and End Panels

Panels are 3/4" thick, 3-ply construction with book matched veneers to provide proper grain consistency and uniform grain appearance. All veneers are vertical grain walnut, cherry or oak veneers matched to ensure proper veneer balance. Decorative panel moulding is crafted from solid walnut, cherry or oak with mitered corners and hand fitted to each panel. Units may be specified with or without decorative panel moulding. Full modesty panels are standard for desk, bridge, and kneespace credenzas with optional half modesty options available.

Drawers

Drawer sides and backs are wood, 7/16" thick. Drawer fronts are 3-ply hardwood construction, 3/4" thick with book matched veneers to provide proper grain consistency and uniform grain appearance. All drawers utilize five sided drawer construction. Drawers are assembled with dovetail construction in all four corners. Drawer bottoms are 7/32" 3-ply hardwood dado construction.

Doors

Doors are 3/4" thick 3-ply construction with vertical grain walnut, cherry or oak veneers and matched in selected sets to ensure proper veneer balance and uniform grain appearance. European style hidden hinges are used on doors where applicable. Tempered glass conforming to ASTM C 1048 is used in all glass doors.

Shelves

Shelves are 3-ply construction with a 1/4" walnut, cherry or oak rim on the front edge. All shelves are full depth of the interior compartment unless specified otherwise. Faces are book matched walnut, cherry or oak veneer. Hutch shelves are walnut, cherry or oak faced on both sides. A minimum of one adjustable or fixed shelf is provided with each cabinet storage unit (see individual unit for details). Adjustable shelves are provided with metal adjustable shelf hardware supports.

Bases

Bases are solid hardwood mitered at all four corners. Units may be specified with conventional or Georgian scroll bases. Height adjustable leveling glides are mounted in each corner with a threaded metal insert capped with a nylon glide that is height adjustable to approx. 1 1/2" to ensure proper leveling of the unit to varying floor conditions.

Hardware

Drawer Suspensions – File, box, pencil and center drawers utilize steel "A" grade heavy duty metal slides for smooth operation. All pedestal drawers have 100 % full extension slides. All suspension systems feature positive and cushioned in/out stops. All box, center, and tray drawers are removable without tools and the suspensions are designed to prevent accidental removal.

Locks – Desk center drawer locks all drawers. Credenzas use pedestal locking. Lateral files are keyed as standard and feature central locking with anti-tip drawer interlock systems. Individual pieces are shipped random keyed. Units may be keyed alike upon special request. A minimum of fifty key changes (numbers) are available. Core lock changes are available (contact customer service).

Drawer Pulls – Traditional style, bail type drawer pulls in antique brass finish are standard.

Hinges – European style hidden hinges on hinged doors where applicable.

Wire Management – Black wire management grommets are standard on all returns and bridge work surfaces located in back center of the tops. Black wire management access grommets are standard on all credenzas, hutches, overhead storage units and computer tables located in back panel. Optional additional black wire management grommets, wall access cut-outs, wiring harness and wiring channels along with integrated cable management to conceal power and data cords are also available. Optional data ports accessible at work surface height (see accessories).

Chassis Construction

Construction technique is mortise and tenon, groove and tenon, heavily glue blocked with hardwood cleats for maximum strength.

Filing

File drawers use an easily adjustable filing rail system which can be positioned to accommodate front to back or side to side letter or legal filing.

Finish

All exposed surfaces are finished with a UV inhibitor catalyzed varnish finish to ensure maximum durability, chemical resistance, color retention and clarity. All exterior surfaces are finished in the following multi-step sequence: sap stain, NGR stain, wash coat, wash coat sand, filler spray, filler wipe, sealer spray, sealer sand, varnish spray, varnish sand, varnish spray. Moisture content for all wooden parts is between 5 - 9% prior to sealing. Drawer interiors and exteriors are UV prefinished with sealer, sealer sand, and varnished. Custom finish matches are available, contact customer service for request.

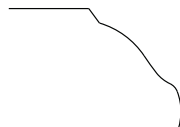

Georgian Profile - GEP

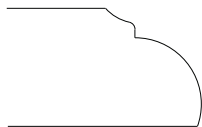

Franklin Profile - FEP

GEORGIAN SERIES

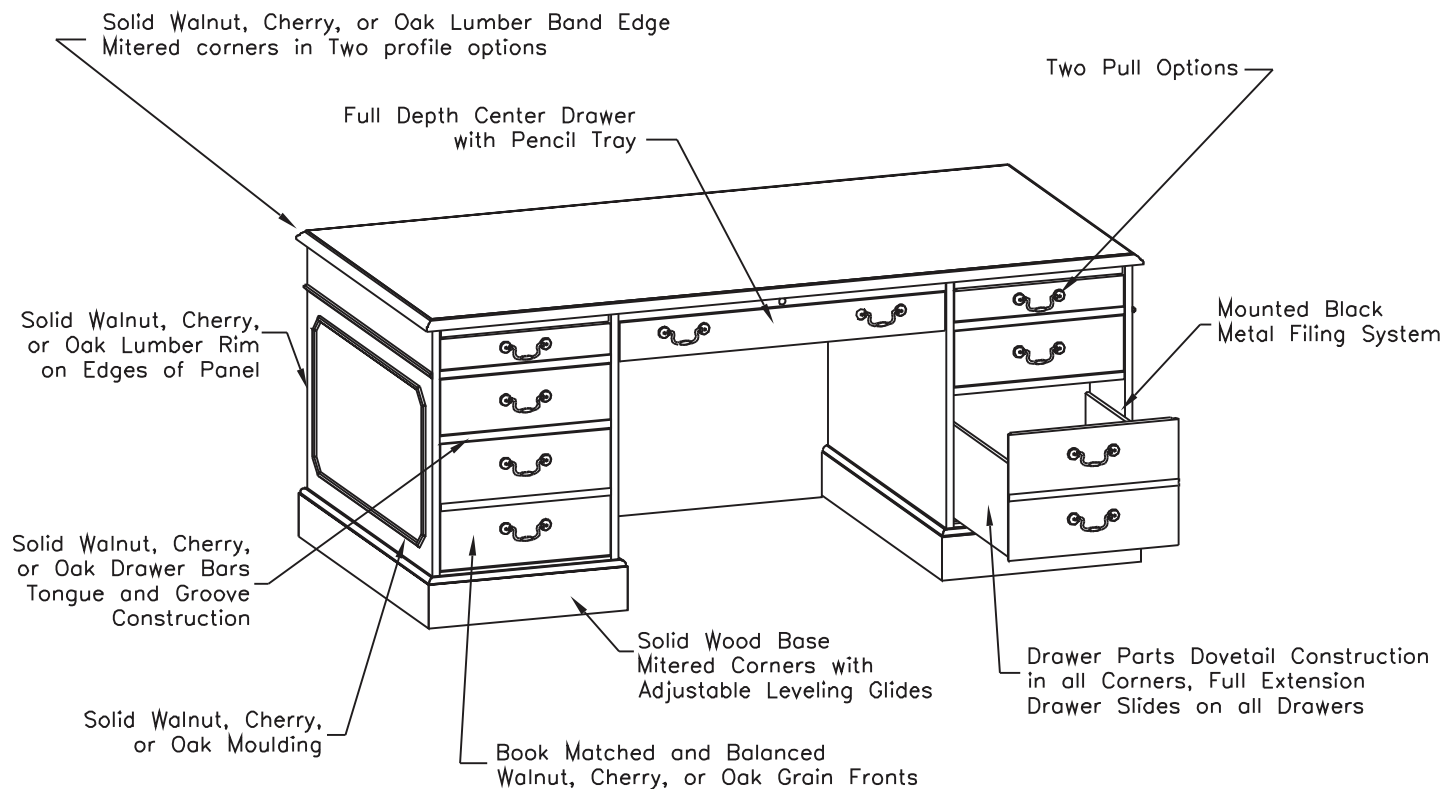

Available in Walnut, Cherry, or Oak
Standard Central Locking
All units have $\frac{1}{8}$ " thick hardboard security/dust bottoms
Desk has standard Arm slides and Approach Dictation Slide
All surfaces are Catalyzed Varnish finish

Ordering Information

Use the following steps to correctly place your order:

1) Determine the correct model number for the item you are selecting - example:

55FC84 = Double pedestal desk, 42" x 84" x 30"H

2) Determine the proper finish selection for the item - example:

55FC84-OW = Double pedestal desk, 42" x 84" x 30"H, in Old World Mahogany

3) Determine any additional options you may wish for the item - example:

**55FC84-FFL-OW = Double pedestal desk, 42" x 84" x 30"H, in Old World Mahogany
with optional file/file pedestal left**

GEORGIAN SERIES

List Price

Double Pedestal Desks

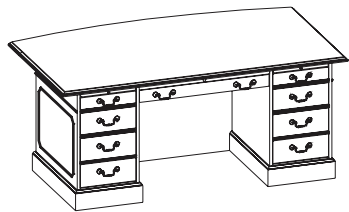

55FK84_ _ **\$5764**
 Double pedestal desk with arc conference top, two pencil/box/file pedestals,
 center drawer, central locking, left and right hand writing slides.
 6 3/4" approach and side overhang
 32" W Kneespace
 42" x 84" x 30"H (435 lbs)

55FK72_ _ **\$5262**
 Double pedestal desk with arc conference top, two pencil/box/file pedestals,
 center drawer, central locking, left and right hand writing slides.
 6 3/4" approach overhang
 32" W Kneespace
 42" x 72" x 30"H (405 lbs)

55FK7236_ _ **\$4920**
 Double pedestal desk with arc conference top, two pencil/box/file pedestals,
 center drawer, central locking, left and right hand writing slides.
 6 3/4" approach overhang
 32" W Kneespace
 36" x 72" x 30"H (395 lbs)

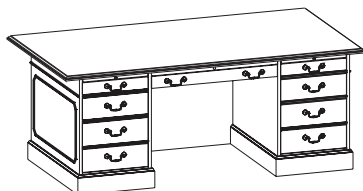

55FC84_ _ **\$5712**
 Double pedestal desk with conference top, two pencil/box/file pedestals,
 center drawer, central locking, left and right hand writing slides.
 6 3/4" approach and side overhang
 32" W Kneespace
 42" x 84" x 30"H (425 lbs)

55FC72_ _ **\$5205**
 Double pedestal desk with conference top, two pencil/box/file pedestals,
 center drawer, central locking, left and right hand writing slides.
 6 3/4" approach and side overhang
 32" W Kneespace
 36" x 72" x 30"H (345 lbs)

55FC6636_ _ **\$5109**
 Double pedestal desk with conference top, two pencil/box/file pedestals,
 center drawer, central locking, left and right hand writing slides.
 6 3/4" approach overhang - left and right side fitted top
 32" W Kneespace
 36" x 66" x 30"H (335 lbs)

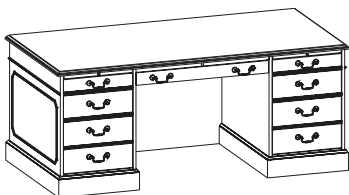

55F72_ _ **\$5405**
 Double pedestal desk with fitted top, two pencil/box/file pedestals,
 center drawer, central locking, left and right hand writing slides and approach side dictation slide.
 32" W Kneespace
 36" x 72" x 30"H (380 lbs)

55F6636_ _ **\$5356**
 Double pedestal desk with fitted top, two pencil/box/file pedestals,
 center drawer, central locking, left and right hand writing slides and approach side dictation slide.
 32" W Kneespace
 36" x 66" x 30"H (335 lbs)

GEORGIAN SERIES

List Price

Double Pedestal Desks

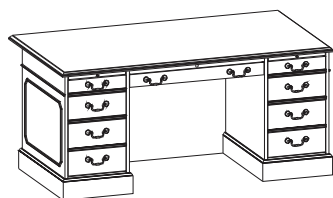

55F66_ _ **\$5065**
 Double pedestal desk with fitted top, two pencil/box/file pedestals,
 center drawer, central locking, left and right hand writing slides and approach dictation slide.
 32" W Kneespace
 30" x 66" x 30"H (325 lbs)

55F60_ _ **\$4736**
 Double pedestal desk with fitted top, two pencil/box/file pedestals,
 center drawer, central locking, left and right hand writing slides and approach dictation slide.
 26 1/2" W Kneespace
 30" x 60" x 30"H (305 lbs)

Table Desks

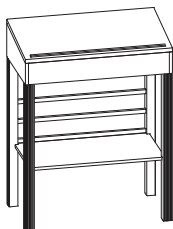

55SUD36 **\$2851**
 Stand-up desk, hinged top with storage, pencil tray, bottom shelf,
 solid wood reeded legs
 20" x 36" x 47"H - back / 42"H front (160 lbs)

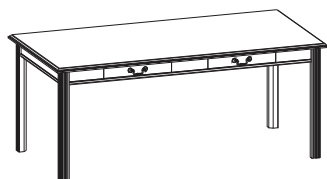

55UT7236_ _ **\$2554**
 Table desk with two drawers (non-locking), solid wood reeded legs
 Chair arm clearance 25"H
 36" x 72" x 30"H (140 lbs)

55UT7230_ _ **\$2400**
 Table desk with two drawers (non-locking), solid wood reeded legs
 Chair arm clearance 25"H
 30" x 72" x 30"H (130 lbs)

55UT6030_ _ **\$2123**
 Table desk with two drawers (non-locking), solid wood reeded legs
 Chair arm clearance 25"H
 30" x 60" x 30"H (100 lbs)

55UT4830_ _ **\$2028**
 Table desk with one drawer (non-locking), solid wood reeded legs
 Chair arm clearance 25"H
 30" x 48" x 30"H (85 lbs)

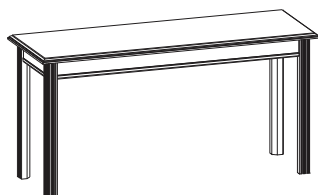

55UT6621_ _ **\$1753**
 Table desk w/o drawers, solid wood reeded legs

55UT6621WD **\$2127**
 Table desk with two non-locking drawers, solid wood reeded legs
 Chair arm clearance 25"H
 21" x 66" x 30"H (100 lbs)

55UT4821_ _ **\$1529**
 Table desk w/o drawers, solid wood reeded legs

55UT4821WD **\$1804**
 Table desk with one non-locking drawer, solid wood reeded legs
 Chair arm clearance 25"H
 21" x 48" x 30"H (70 lbs)

GEORGIAN SERIES

List Price

Credenzas

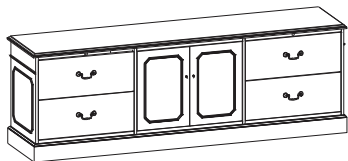

55DC90-4_ _ \$5173
 Credenza with hinged door storage, two lateral file pedestals (locking), hinged door storage area (non-locking) with one adjustable shelf, wire mgmt grommet in back panel
 21" x 90" x 30"H (380 lbs)
 Optional locking doors (LK) - add \$55 list
55DC90-4-24 - 24" x 90" x 30"H \$5635

55DC84-4_ _ \$4956
 Credenza with hinged door storage, two lateral file pedestals (locking), hinged door storage area (non-locking) with one adjustable shelf, wire mgmt grommet in back panel
 21" x 84" x 30"H (365 lbs)
 Optional locking doors (LK) - add \$55 list
55DC84-4-24 - 24" x 84" x 30"H \$5385

55DC72-4_ _ \$4592
 Credenza with hinged door storage, two pencil/box/file pedestals (locking), hinged door storage area (non-locking) with one adjustable shelf, wire mgmt grommet in back panel
 21" x 72" x 30"H (350 lbs)
 Optional locking doors (LK) - add \$55 list
55DC72-4-24 - 24" x 72" x 30"H \$4988

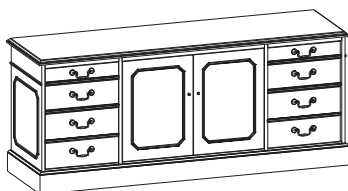

55DC66-4_ _ \$4364
 Credenza with hinged door storage, two pencil/box/file pedestals (locking), hinged door storage area (non-locking) with one adjustable shelf, wire mgmt grommet in back panel
 21" x 66" x 30"H (330 lbs)
 Optional locking doors (LK) - add \$55 list
55DC66-4-24 - 24" x 66" x 30"H \$4727

55DC60-4_ _ \$4129
 Credenza with hinged door storage, two pencil/box/file pedestals (locking), hinged door storage area (non-locking) with one adjustable shelf, wire mgmt grommet in back panel
 21" x 60" x 30"H (310 lbs)
 Optional locking doors (LK) - add \$55 list
55DC60-4-24 - 24" x 60" x 30"H \$4459

55DC90-3_ _ \$4514
 Credenza with kneespace, two lateral file pedestals (locking), wire mgmt grommet in back panel
 30 1/2" W kneespace
 21" x 90" x 30"H (325 lbs)
55DC90-3-24 - 24" x 90" x 30"H \$4976

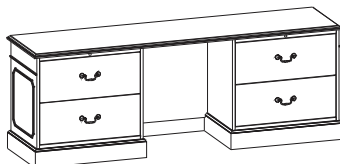

55DC84-3_ _ \$4441
 Credenza with kneespace, two lateral file pedestals (locking), wire mgmt grommet in back panel
 24 1/2" W kneespace
 21" x 84" x 30"H (310 lbs)
55DC84-3-24 - 24" x 84" x 30"H \$4870

55DC72-3_ _ \$4182
 Credenza with kneespace, two pencil/box/file pedestals (locking), wire mgmt grommet in back panel
 32" W kneespace
 21" x 72" x 30"H (260 lbs)
55DC72-3-24 - 24" x 72" x 30"H \$4578

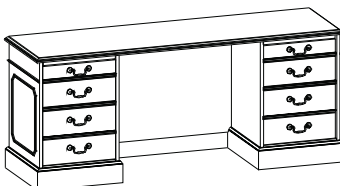

55DC66-3_ _ \$4000
 Credenza with kneespace, two pencil/box/file pedestals (locking), wire mgmt grommet in back panel
 32" W kneespace
 21" x 66" x 30"H (240 lbs)
55DC66-3-24 - 24" x 66" x 30"H \$4363

55DC60-3_ _ \$3822
 Credenza with kneespace, two pencil/box/file pedestals (locking), wire mgmt grommet in back panel.
 26" W kneespace
 21" x 60" x 30"H (210 lbs)
55DC60-3-24 - 24" x 60" x 30"H \$4152

GEORGIAN SERIES

List Price

Credenzas

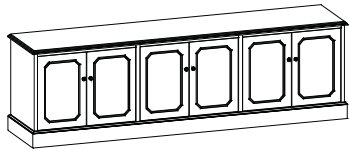

55SC-90_ _ \$5575
 Six door hinged door cabinet (non-locking), one adjustable shelf per section
 21" x 90" x 30"H (380 lbs)
 Optional locking doors (LK3) - add \$165 list
55SC-90-24 - 24" x 90" x 30"H \$6037

55SC-84_ _ \$5034
 Six door hinged door cabinet (non-locking), one adjustable shelf per section
 21" x 84" x 30"H (365 lbs)
 Optional locking doors (LK3) - add \$165 list
55SC-84-24 - 24" x 84" x 30"H \$5463

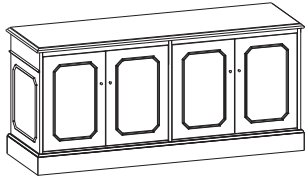

55SC-72_ _ \$3586
 Four door hinged door cabinet (non-locking), one adjustable shelf per section
 21" x 72" x 30"H (300 lbs)
 Optional locking doors (LK2) - add \$110 list
55SC-72-24 - 24" x 72" x 30"H \$3982

55SC-66_ _ \$3391
 Four door hinged door cabinet (non-locking), one adjustable shelf per section
 21" x 66" x 30"H (260 lbs)
 Optional locking doors (LK2) - add \$110 list
55SC-66-24 - 24" x 66" x 30"H \$3754

55SC-60_ _ \$3125
 Four door hinged door cabinet (non-locking), one adjustable shelf per section
 21" x 60" x 30"H (200 lbs)
 Optional locking doors (LK2) - add \$110 list
55SC-60-24 - 24" x 60" x 30"H \$3455

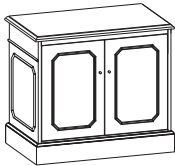

55SC-31_ _ \$1913
 Two door hinged door cabinet (non-locking), one adjustable shelf per section
 21" x 30 1/2" x 30"H (125 lbs)
 Optional locking doors (LK) - add \$55 list
55SC-31-24 - 24" x 30 1/2" x 30"H \$2140

55CRT36_ _ \$1666
 Computer table, 10" deep storage shelf, one wire mgmt grommet in top and back panel
 24" x 36" x 30"H (115 lbs)
 Optional with casters (C) - add \$139 list
 Optional with one additional adjustable 10" deep storage shelf (-ASF) - add \$165 list

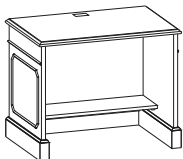

55CRT48_ _ \$1877
 Computer table, 10" deep storage shelf, one wire mgmt grommet in top and back panel
 24" x 48" x 30"H (135 lbs)
 Optional with casters (-C) - add \$139 list
 Optional with one additional adjustable 10" deep storage shelf (-ASF) - add \$193 list

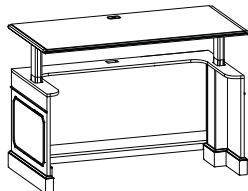

55CRT60AH_ _ \$8285
 Height adjustable computer table, 10" deep storage shelf, one wire mgmt grommet in top and back panel, lifting column, control box, control pendant with memory settings, motor cable, main power cable, anti-collision dongle, lower metal lift brackets and upper metal frame and anti-tip brackets
 30" x 60" x 30-44"H (265 lbs)

55DCSPL48FS_ _ \$2902
 Single pedestal credenza (LH), pencil/box/file pedestal (locking), wire mgmt grommet in back panel
 30" W kneespace
 21" x 48" x 30"H (146 lbs)
 Optional CPU Pedestal in place of pencil/box/file pedestal (CPU) - add \$110 list
55DCSPL48FS-24 - 24" x 48" x 30"H \$3210

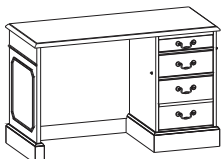

55DCSPR48FS_ _ \$2902
 Single pedestal credenza (RH), pencil/box/file pedestal (locking), wire mgmt grommet in back panel
 30" W kneespace
 21" x 48" x 30"H (146 lbs)
 Optional CPU Pedestal in place of pencil/box/file pedestal (CPU) - add \$110 list
55DCSPR48FS-24 - 24" x 48" x 30"H \$3210

GEORGIAN SERIES

List Price

Storage Units



55LF4V_ _ \$3711
 Four drawer vertical lateral file, legal or letter cross filing, central locking
 21" x 34" x 54"H (215 lbs)
55LF4V-24 - 24" x 34" x 54"H \$4104



55LF3_ _ \$2954
 Three drawer lateral file, legal or letter cross filing, central locking
 21" x 34" x 42"H (195 lbs)
55LF3-24 - 24" x 34" x 42"H \$3267



55LF2_ _ \$2392
 Two drawer lateral file, legal or letter cross filing, central locking
 21" x 34" x 30"H (145 lbs)
55LF2-24 - 24" x 34" x 30"H \$2645



55FC5BC_ _ \$4152
 Open storage/file, left and right file/file pedestal (locking), center - top open storage area, bottom - lateral file (locking), legal or letter filing, wire mgmt grommet in back panel
 21" x 72" x 30"H (280 lbs)
55FC5BC-24 - 24" x 72" x 30"H \$4548

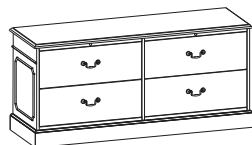

55LF4-72_ _ \$4163
 Double unit lateral file, legal or letter cross filing, central locking
 21" x 72" x 30"H (235 lbs)
55LF4-72-24 - 24" x 72" x 30"H \$4559

55LF4-66_ _ \$3910
 Double unit lateral file, legal or letter cross filing, central locking
 21" x 66" x 30"H (215 lbs)
55LF4-66-24 - 24" x 66" x 30"H \$4273

55LF4-60_ _ \$3670
 Double unit lateral file, legal or letter cross filing, central locking
 21" x 60" x 30"H (195 lbs)
55LF4-60-24 - 24" x 60" x 30"H \$4000

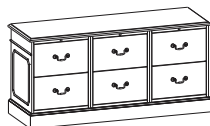

55FC6_ _ \$4617
 Six drawer file (2x3), locking, legal or letter filing
 21" x 58 1/2" x 30"H (260 lbs)
55FC6-24 - 24" x 58 1/2" x 30"H \$5101



55FC4_ _ \$3411
 Four drawer file (2x2), locking, legal or letter filing
 21" x 39" x 30"H (175 lbs)
55FC4-24 - 24" x 39" x 30"H \$3774



55FC4V_ _ \$3346
 Four drawer vertical file (4x1), locking, legal or letter filing
 21" x 20 1/4" x 54"H (200 lbs)
55FC4V-24 - 24" x 20 1/4" x 54"H \$3701



55FC2_ _ \$2188
 Two drawer file (2x1), legal or letter cross filing, central locking
 21" x 20 1/4" x 30"H (90 lbs)
55FC2-24 - 24" x 20 1/4" x 30"H \$2419

GEORGIAN SERIES

List Price

Storage Units

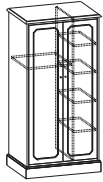

55WC69_ _ \$5152
 Wardrobe, left side clothing carrier, right side four adjustable shelves, non-locking
 24" x 34" x 69"H (330 lbs)
 Optional locking doors (LK) - add \$55 list
 Optional full wardrobe - full coat rod (FULL) - N/C
55WC80 - 80"H with cornice top \$6087

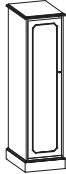

55WC6918R_ _ hinged right \$4153
55WC6918L_ _ hinged left (shown)
 Single unit wardrobe, top shelf, coat rod, non-locking left or right hinged door
 24" x 18" x 69"H (155 lbs)
 Optional locking door (LK) - add \$55 list
55WC8018R - 80"H with cornice top \$4923
55WC8018L - 80"H with cornice top

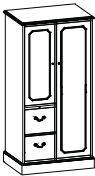

55WSFFL_ _ left hand wardrobe \$5567
55WSFFR_ _ right hand wardrobe (shown)
 Utility cabinet, wardrobe unit with hinged door (non-locking), top shelf, coat rod, file/file pedestal - bottom (locking), hinged door storage area (non-locking) with two adjustable shelves - top (right hand shown)
 24" x 34" x 69"H (360 lbs)
 Optional locking doors (LK2) - add \$110 list
55WSFFL-80 - 80"H with cornice top \$6502
55WSFFR-80 - 80"H with cornice top



55SC69_ _ \$5052
 Storage cabinet, hinged doors (non-locking), four adjustable shelves
 24" x 34" x 69"H (285 lbs)
 Optional locking doors (LK) - add \$55 list
55SC80 - 80"H with cornice top \$5987



55SC6918R_ _ hinged right \$4170
55SC6918L_ _ hinged left (shown)
 Storage cabinet, non-locking left or right hinged door, four adjustable shelves
 24" x 18" x 69"H (155 lbs)
 Optional locking door (LK) - add \$55 list
55SC8018R - 80"H with cornice top \$4940
55SC8018L - 80"H with cornice top

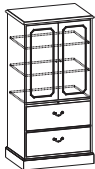

55LF/BCW_ _ \$5448
 Storage cabinet / Lateral file, upper hinged door storage (non-locking) with two adjustable shelves, bottom - two lateral file drawers (locking), legal or letter filing
 24" x 34" x 69"H (310 lbs)
 Optional locking doors (LK) - add \$55 list
55LF/BCW-80 - 80"H with cornice top \$6383

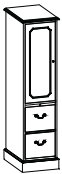

55SCFF6918L_ _ hinged left (shown) \$4611
55SCFF6918R_ _ hinged right
 Utility cabinet, file/file pedestal - bottom (locking), hinged door storage area (non-locking) with two adjustable shelves - top (left hand hinged door shown)
 24" x 18" x 69"H (155 lbs)
 Optional locking door (LK) - add \$55 list
55SCFF8018L - 80"H with cornice top \$5381
55SCFF8018R - 80"H with cornice top

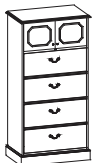

55LF4VHD_ _ \$4591
 Four drawer lateral file with hinged door, hinged door storage (non-locking) - top, four drawer lateral file - bottom, legal or letter cross filing, central locking
 24" x 34" x 69"H (235 lbs)
 Optional locking doors (LK) - add \$55 list



55PCDH_ _ \$1680
 Telephone cabinet, box drawer, hinged door storage (locking), one adjustable shelf
 17" x 22" x 30"H (85 lbs)

GEORGIAN SERIES

List Price

Computer Desk Workstations - Single Pedestal Desks

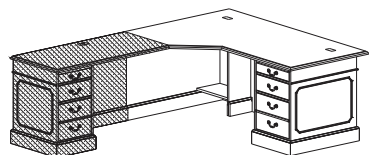

55ECWS8446R_ _ **\$4483**
 Executive single pedestal computer desk (RH) with conference top, pencil/box/file pedestal (locking), right hand writing slide, 46" corner unit, 4" approach overhang, two wire mgmt grommets in top
 34"- 46" x 84" x 30"H (385 lbs)

55ECWS7246R_ _ **\$4243**
 Executive single pedestal computer desk (RH) with conference top, pencil/box/file pedestal (locking), right hand writing slide, 46" corner unit, 4" approach overhang, two wire mgmt grommets in top
 34"- 46" x 72" x 30"H (360 lbs)

55ECWS6640R_ _ **\$3955**
 Executive single pedestal computer desk (RH) with conference top, pencil/box/file pedestal (locking), right hand writing slide, 40" corner unit, 4" approach overhang, two wire mgmt grommets in top
 28"- 40" x 66" x 30"H (280 lbs)

55ECWS8442R_ _ **\$4316**
 Executive single pedestal computer desk (RH) with fitted top, pencil/box/file pedestal (locking), right hand writing slide, 42" corner unit, two wire mgmt grommets in top
 30"- 42" x 84" x 30"H (375 lbs)

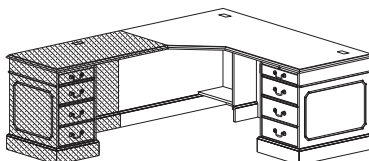

55ECWS7242R_ _ **\$4111**
 Executive single pedestal computer desk (RH) with fitted top, pencil/box/file pedestal (locking), right hand writing slide, 42" corner unit, two wire mgmt grommets in top
 30"- 42" x 72" x 30"H (340 lbs)

55ECWS7236R_ _ **\$4063**
 Executive single pedestal computer desk (RH) with fitted top, pencil/box/file pedestal (locking), right hand writing slide, 36" corner unit, two wire mgmt grommets in top
 24"- 36" x 72" x 30"H (283 lbs)

55ECWS6636R_ _ **\$3923**
 Executive single pedestal computer desk (RH) with fitted top, pencil/box/file pedestal (locking), right hand writing slide, 36" corner unit, two wire mgmt grommets in top
 24"- 36" x 66" x 30"H (260 lbs)

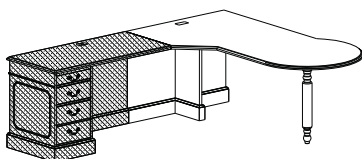

55ECWSP76R_ _ **\$3253**
 Freestanding P-Top computer desk (RH), 36" diameter end, with sculptured wood pedestal leg, 42" corner unit, one wire mgmt grommet in top
 30"-42" x 76" x 30"H (330 lbs)

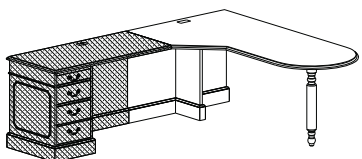

55ECWSB76R_ _ **\$2934**
 Freestanding bullet top computer desk (RH), 30" diameter end, with sculptured wood pedestal leg, 42" corner unit, one wire mgmt grommet in top
 30"-42" x 76" x 30"H (330 lbs)

GEORGIAN SERIES

List Price

Computer Desk Workstations - Executive Returns

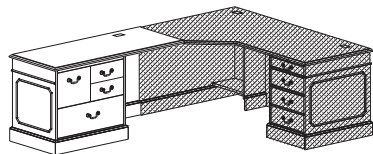

55ERL72FCCU__ **\$3109**
 Executive height computer return (LH), file center pedestal (locking), two box, one file drawer top, one lateral file drawer bottom, one wire mgmt grommet, 42"W kneespace
 24" x 72" x 30"H (250 lbs)

55ERL60FCCU__ **\$2937**
 Executive height computer return (LH), file center pedestal (locking), two box, one file drawer top, one lateral file drawer bottom, one wire mgmt grommet, 30"W kneespace
 24" x 60" x 30"H (195 lbs)

55ERL54FCCU__ **\$2811**
 Executive height computer return (LH), file center pedestal (locking), two box, one file drawer top, one lateral file drawer bottom, one wire mgmt grommet, 24"W kneespace
 24" x 54" x 30"H (180 lbs)

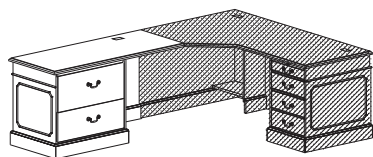

55ERL72LFCU__ **\$3014**
 Executive height computer return (LH), two lateral file drawers (locking), one wire mgmt grommet, 42"W kneespace
 24" x 72" x 30"H (250 lbs)

55ERL60LFCU__ **\$2836**
 Executive height computer return (LH), two lateral file drawers (locking), one wire mgmt grommet, 30"W kneespace
 24" x 60" x 30"H (195 lbs)

55ERL54LFCU__ **\$2709**
 Executive height computer return (LH), two lateral file drawers (locking), one wire mgmt grommet, 24"W kneespace
 24" x 54" x 30"H (180 lbs)

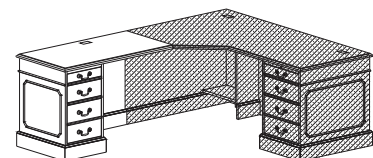

55ERL72CU__ **\$2796**
 Executive height computer return (LH), pencil/box/file pedestal (locking), 1/2 support panel on connection end, one wire mgmt grommet, 54"W kneespace
 24" x 72" x 30"H (225 lbs)

55ERL48CU__ **\$2202**
 Executive height computer return (LH), pencil/box/file pedestal (locking), one wire mgmt grommet, 31"W kneespace
 24" x 48" x 30"H (150 lbs)

55ERL42CU__ **\$2013**
 Executive height computer return (LH), pencil/box/file pedestal (locking), one wire mgmt grommet, 25"W kneespace
 24" x 42" x 30"H (130 lbs)

55ERL36CU__ **\$1851**
 Executive height computer return (LH), pencil/box/file pedestal (locking), one wire mgmt grommet, 19"W kneespace
 24" x 36" x 30"H (120 lbs)

GEORGIAN SERIES

List Price

Computer Desk Workstations - Single Pedestal Desks

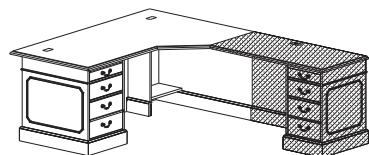

55ECWS8446L __ **\$4483**
 Executive single pedestal computer desk (LH) with conference top, pencil/box/file pedestal (locking), left hand writing slide, 46" corner unit, 4" approach overhang, two wire mgmt grommets in top
 34"- 46" x 84" x 30"H (385 lbs)

55ECWS7246L __ **\$4243**
 Executive single pedestal computer desk (LH) with conference top, pencil/box/file pedestal (locking), left hand writing slide, 46" corner unit, 4" approach overhang, two wire mgmt grommets in top
 34"- 46" x 72" x 30"H (360 lbs)

55ECWS6640L __ **\$3955**
 Executive single pedestal computer desk (LH) with conference top, pencil/box/file pedestal (locking), left hand writing slide, 40" corner unit, 4" approach overhang, two wire mgmt grommets in top
 28"- 40" x 66" x 30"H (280 lbs)

55ECWS8442L __ **\$4316**
 Executive single pedestal computer desk (LH) with fitted top, pencil/box/file pedestal (locking), left hand writing slide, 42" corner unit, two wire mgmt grommets in top
 30"- 42" x 84" x 30"H (375 lbs)

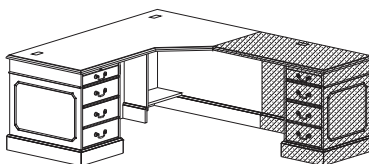

55ECWS7242L __ **\$4111**
 Executive single pedestal computer desk (LH) with fitted top, pencil/box/file pedestal (locking), left hand writing slide, 42" corner unit, two wire mgmt grommets in top
 30"- 42" x 72" x 30"H (340 lbs)

55ECWS7236L __ **\$4063**
 Executive single pedestal computer desk (LH) with fitted top, pencil/box/file pedestal (locking), left hand writing slide, 36" corner unit, two wire mgmt grommets in top
 24"- 36" x 72" x 30"H (283 lbs)

55ECWS6636L __ **\$3923**
 Executive single pedestal computer desk (LH) with fitted top, pencil/box/file pedestal (locking), left hand writing slide, 36" corner unit, two wire mgmt grommets in top
 24"- 36" x 66" x 30"H (260 lbs)

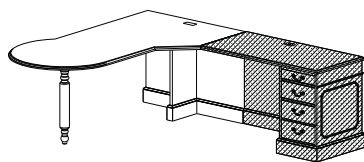

55ECWSP76L __ **\$3253**
 Freestanding P-Top computer desk (LH), 36" diameter end, with sculptured wood pedestal leg, 42" corner unit, one wire mgmt grommet in top
 30"-42" x 76" x 30"H (330 lbs)

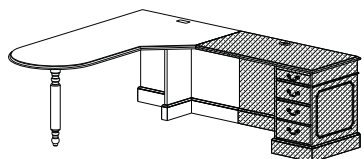

55ECWSB76L __ **\$2934**
 Freestanding bullet top computer desk (LH), 30" diameter end, with sculptured wood pedestal leg, 42" corner unit, one wire mgmt grommet in top
 30"-42" x 76" x 30"H (330 lbs)

GEORGIAN SERIES

List Price

Computer Desk Workstations - Executive Returns

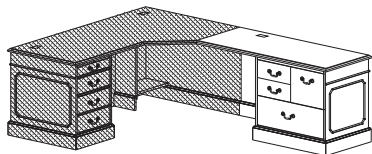

55ERR72FCCU__ **\$3109**
 Executive height computer return (RH), file center pedestal (locking), two box, one file drawer top, one lateral file drawer bottom, one wire mgmt grommet, 42"W kneespace
 24" x 72" x 30"H (250 lbs)

55ERR60FCCU__ **\$2937**
 Executive height computer return (RH), file center pedestal (locking), two box, one file drawer top, one lateral file drawer bottom, one wire mgmt grommet, 30"W kneespace
 24" x 60" x 30"H (195 lbs)

55ERR54FCCU__ **\$2811**
 Executive height computer return (RH), file center pedestal (locking), two box, one file drawer top, one lateral file drawer bottom, one wire mgmt grommet, 24"W kneespace
 24" x 54" x 30"H (180 lbs)

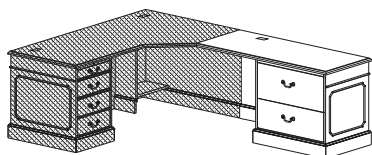

55ERR72LFCU__ **\$3014**
 Executive height computer return (RH), two lateral file drawers (locking), one wire mgmt grommet, 42"W kneespace
 24" x 72" x 30"H (250 lbs)

55ERR60LFCU__ **\$2836**
 Executive height computer return (RH), two lateral file drawers (locking), one wire mgmt grommet, 30"W kneespace
 24" x 60" x 30"H (195 lbs)

55ERR54LFCU__ **\$2709**
 Executive height computer return (RH), two lateral file drawers (locking), one wire mgmt grommet, 24"W kneespace
 24" x 54" x 30"H (180 lbs)

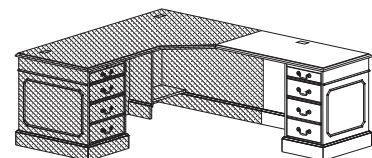

55ERR72CU__ **\$2796**
 Executive height computer return (RH), pencil/box/file pedestal (locking), 1/2 support panel on connection end, one wire mgmt grommet, 54"W kneespace
 24" x 72" x 30"H (225 lbs)

55ERR48CU__ **\$2202**
 Executive height computer return (RH), pencil/box/file pedestal (locking), one wire mgmt grommet, 31"W kneespace
 24" x 48" x 30"H (150 lbs)

55ERR42CU__ **\$2013**
 Executive height computer return (RH), pencil/box/file pedestal (locking), one wire mgmt grommet, 25"W kneespace
 24" x 42" x 30"H (130 lbs)

55ERR36CU__ **\$1851**
 Executive height computer return (RH), pencil/box/file pedestal (locking), one wire mgmt grommet, 19"W kneespace
 24" x 36" x 30"H (120 lbs)

GEORGIAN SERIES

List Price

Executive Workstations - Single Pedestal Desks

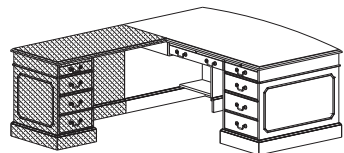

55KSPR84 __ __ **\$4834**
 Executive single pedestal desk (RH) with arc conference top, pencil/box/file pedestal, center drawer, central locking, right hand writing slide, 6" approach overhang
 42" x 84" x 30"H (350 lbs)

55KSPR72 __ __ **\$4583**
 Executive single pedestal desk (RH) with arc conference top, pencil/box/file pedestal, center drawer, central locking, right hand writing slide, 6" approach overhang
 42" x 72" x 30"H (325 lbs)

55KSPR7236 __ __ **\$4470**
 Executive single pedestal desk (RH) with arc conference top, pencil/box/file pedestal, center drawer, central locking, right hand writing slide, 6" approach overhang
 36" x 72" x 30"H (310 lbs)

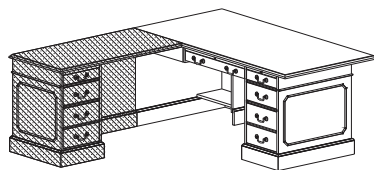

55SPR84 __ __ **\$4689**
 Executive single pedestal desk (RH) with conference top, pencil/box/file pedestal, center drawer, central locking, right hand writing slide, 6" approach and right side overhang
 42" x 84" x 30"H (340 lbs)

55SPR72 __ __ **\$4403**
 Executive single pedestal desk (RH) with conference top, pencil/box/file pedestal, center drawer, central locking, right hand writing slide, 6" approach and right side overhang
 36" x 72" x 30"H (310 lbs)

55SPR6636 __ __ **\$4004**
 Executive single pedestal desk (RH) with conference top, pencil/box/file pedestal, center drawer, central locking, right hand writing slide, 6" approach overhang only
 36" x 66" x 30"H (280 lbs)

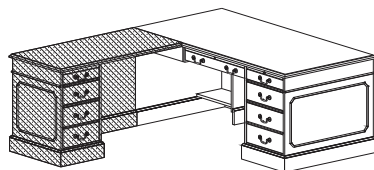

55SPR72F __ __ **\$4575**
 Executive single pedestal desk (RH) with fitted top, pencil/box/file pedestal, center drawer, central locking, right hand writing slide
 36" x 72" x 30"H (300 lbs)

55SPR7230F __ __ **\$4167**
 Executive single pedestal desk (RH) with fitted top, pencil/box/file pedestal, center drawer, central locking, right hand writing slide
 30" x 72" x 30"H (290 lbs)

55SPR66F __ __ **\$3866**
 Executive single pedestal desk (RH) with fitted top, pencil/box/file pedestal, center drawer, central locking, right hand writing slide
 30" x 66" x 30"H (275 lbs)

55SPR60F __ __ **\$3692**
 Executive single pedestal desk (RH) with fitted top, pencil/box/file pedestal, center drawer, central locking, right hand writing slide, 10" w pedestal accommodates side-to-side letter or legal filing only. If freestanding option is specified, pedestal will be letter width.
 30" x 60" x 30"H (250 lbs)

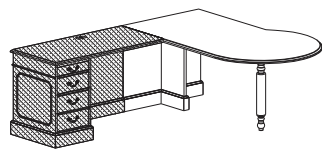

55WSP72R _ **\$3058**
 P-Top desk (RH), 42" diameter end, with sculptured wood pedestal leg 36"-42" x 72" x 30"H (170 lbs)

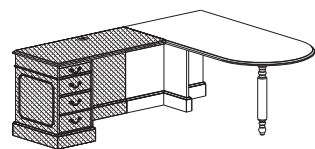

55WSB7236R _ **\$2689**
 Bullet top desk (RH), 36" diameter end, with sculptured wood pedestal leg, 42" corner unit
 36" x 72" x 30"H (170 lbs)

GEORGIAN SERIES

List Price

Executive Workstations - Executive Returns

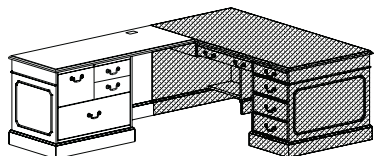

55ERL72FC_ _ **\$3109**
 Executive height return (LH), file center pedestal (locking), two box, one file drawer top, one lateral file drawer bottom, one wire mgmt grommet, 42"W kneespace
 24" x 72" x 30"H (250 lbs)

55ERL60FC_ _ **\$2937**
 Executive height return (LH), file center pedestal (locking), two box, one file drawer top, one lateral file drawer bottom, one wire mgmt grommet, 30"W kneespace
 24" x 60" x 30"H (195 lbs)

55ERL54FC_ _ **\$2811**
 Executive height return (LH), file center pedestal (locking), two box, one file drawer top, one lateral file drawer bottom, one wire mgmt grommet, 24"W kneespace
 24" x 54" x 30"H (180 lbs)

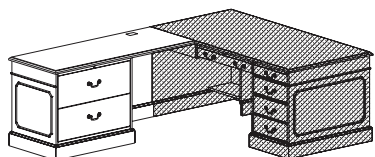

55ERL72LF_ _ **\$3014**
 Executive height return (LH), two lateral file drawers (locking), one wire mgmt grommet, 42"W kneespace
 24" x 72" x 30"H (250 lbs)

55ERL60LF_ _ **\$2836**
 Executive height return (LH), two lateral file drawers (locking), one wire mgmt grommet, 30"W kneespace
 24" x 60" x 30"H (195 lbs)

55ERL54LF_ _ **\$2709**
 Executive height return (LH), two lateral file drawers (locking), one wire mgmt grommet, 24"W kneespace
 24" x 54" x 30"H (180 lbs)

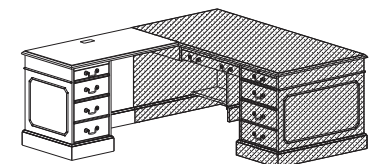

55ERL72_ _ **\$2796**
 Executive height return (LH), pencil/box/file pedestal (locking), 1/2 support panel on connection end, one wire mgmt grommet, 54"W kneespace
 24" x 72" x 30"H (225 lbs)

55ERL48_ _ **\$2202**
 Executive height return (LH), pencil/box/file pedestal (locking), one wire mgmt grommet, 31"W kneespace
 24" x 48" x 30"H (150 lbs)

55ERL42_ _ **\$2013**
 Executive height return (LH), pencil/box/file pedestal (locking), one wire mgmt grommet, 25"W kneespace
 24" x 42" x 30"H (130 lbs)

55ERL36_ _ **\$1851**
 Executive height return (LH), pencil/box/file pedestal (locking), one wire mgmt grommet, 19"W kneespace
 24" x 36" x 30"H (120 lbs)

GEORGIAN SERIES

List Price

Executive Workstations - Single Pedestal Desks

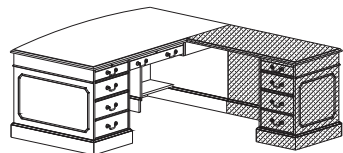

55KSPL84 __ _ \$4834
 Executive single pedestal desk (LH) with arc conference top, pencil/box/file pedestal, center drawer, central locking, left hand writing slide, 6" approach overhang
 42" x 84" x 30"H (350 lbs)

55KSPL72 __ _ \$4583
 Executive single pedestal desk (LH) with arc conference top, pencil/box/file pedestal, center drawer, central locking, left hand writing slide, 6" approach overhang
 42" x 72" x 30"H (325 lbs)

55KSPL7236 __ _ \$4470
 Executive single pedestal desk (LH) with arc conference top, pencil/box/file pedestal, center drawer, central locking, left hand writing slide, 6" approach overhang
 36" x 72" x 30"H (310 lbs)

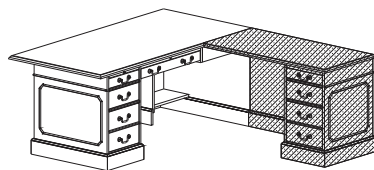

55SPL84 __ _ \$4689
 Executive single pedestal desk (LH) with conference top, pencil/box/file pedestal, center drawer, central locking, left hand writing slide, 6" approach and left side overhang
 42" x 84" x 30"H (340 lbs)

55SPL72 __ _ \$4403
 Executive single pedestal desk (LH) with conference top, pencil/box/file pedestal, center drawer, central locking, left hand writing slide, 6" approach and left side overhang
 36" x 72" x 30"H (310 lbs)

55SPL6636 __ _ \$4004
 Executive single pedestal desk (LH) with conference top, pencil/box/file pedestal, center drawer, central locking, right hand writing slide, 6" approach overhang only
 36" x 66" x 30"H (280 lbs)

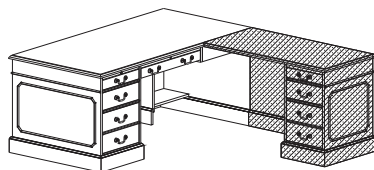

55SPL72F __ _ \$4575
 Executive single pedestal desk (LH) with fitted top, pencil/box/file pedestal, center drawer, central locking, left hand writing slide
 36" x 72" x 30"H (300 lbs)

55SPL7230F __ _ \$4167
 Executive single pedestal desk (LH) with fitted top, pencil/box/file pedestal, center drawer, central locking, left hand writing slide
 30" x 72" x 30"H (290 lbs)

55SPL66F __ _ \$3866
 Executive single pedestal desk (LH) with fitted top, pencil/box/file pedestal, center drawer, central locking, left hand writing slide
 30" x 66" x 30"H (275 lbs)

55SPL60F __ _ \$3692
 Executive single pedestal desk (LH) with fitted top, pencil/box/file pedestal, center drawer, central locking, left hand writing slide, 10" w pedestal accommodates side-to-side letter or legal filing only. If freestanding option is specified, pedestal will be letter width.
 30" x 60" x 30"H (250 lbs)

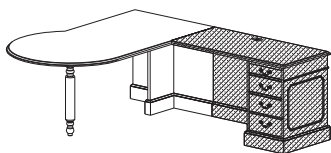

55WSP72L __ _ \$3058
 P-Top desk (LH), 42" diameter end, with sculptured wood pedestal leg 36"-42" x 72" x 30"H (170 lbs)

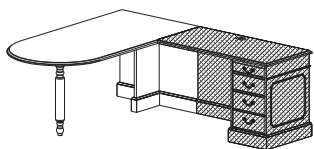

55WSB7236L __ _ \$2689
 Bullet top desk (LH), 36" diameter end, with sculptured wood pedestal leg, 42" corner unit
 36" x 72" x 30"H (170 lbs)

GEORGIAN SERIES

List Price

Executive Workstations - Executive Returns

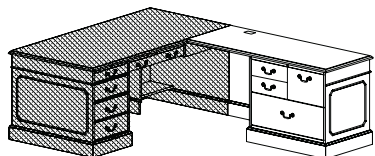

55ERR72FC_ _ **\$3109**
 Executive height return (RH), file center pedestal (locking), two box, one file drawer top, one lateral file drawer bottom, one wire mgmt grommet, 42"W kneespace
 24" x 72" x 30"H (250 lbs)

55ERR60FC_ _ **\$2937**
 Executive height return (RH), file center pedestal (locking), two box, one file drawer top, one lateral file drawer bottom, one wire mgmt grommet, 30"W kneespace
 24" x 60" x 30"H (195 lbs)

55ERR54FC_ _ **\$2811**
 Executive height return (RH), file center pedestal (locking), two box, one file drawer top, one lateral file drawer bottom, one wire mgmt grommet, 24"W kneespace
 24" x 54" x 30"H (180 lbs)

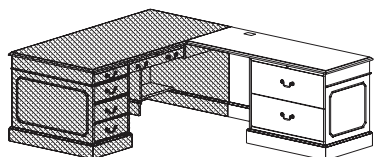

55ERR72LF_ _ **\$3014**
 Executive height return (RH), two lateral file drawers (locking), one wire mgmt grommet, 42"W kneespace
 24" x 72" x 30"H (250 lbs)

55ERR60LF_ _ **\$2836**
 Executive height return (RH), two lateral file drawers (locking), one wire mgmt grommet, 30"W kneespace
 24" x 60" x 30"H (195 lbs)

55ERR54LF_ _ **\$2709**
 Executive height return (RH), two lateral file drawers (locking), one wire mgmt grommet, 24"W kneespace
 24" x 54" x 30"H (180 lbs)

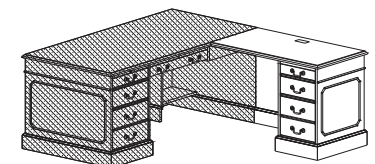

55ERR72_ _ **\$2796**
 Executive height return (RH), pencil/box/file pedestal (locking), 1/2 support panel on connection end, one wire mgmt grommet, 54"W kneespace
 24" x 72" x 30"H (225 lbs)

55ERR48_ _ **\$2202**
 Executive height return (RH), pencil/box/file pedestal (locking), one wire mgmt grommet, 31"W kneespace
 24" x 48" x 30"H (150 lbs)

55ERR42_ _ **\$2013**
 Executive height return (RH), pencil/box/file pedestal (locking), one wire mgmt grommet, 25"W kneespace
 24" x 42" x 30"H (130 lbs)

55ERR36_ _ **\$1851**
 Executive height return (RH), pencil/box/file pedestal (locking), one wire mgmt grommet, 19"W kneespace
 24" x 36" x 30"H (120 lbs)

GEORGIAN SERIES

List Price

Computer Desk U Workstations - Single Pedestal Desks

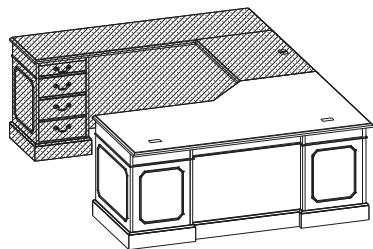

55ECWS8446R_ _ **\$4483**
 Executive single pedestal computer desk (RH) with conference top, pencil/box/file pedestal (locking), right hand writing slide, 46" corner unit, 4" approach overhang, two wire mgmt grommets in top
 34"- 46" x 84" x 30"H (385 lbs)

55ECWS7246R_ _ **\$4243**
 Executive single pedestal computer desk (RH) with conference top, pencil/box/file pedestal (locking), right hand writing slide, 46" corner unit, 4" approach overhang, two wire mgmt grommets in top
 34"- 46" x 72" x 30"H (360 lbs)

55ECWS6640R_ _ **\$3955**
 Executive single pedestal computer desk (RH) with conference top, pencil/box/file pedestal (locking), right hand writing slide, 40" corner unit, 4" approach overhang, two wire mgmt grommets in top
 28"- 40" x 66" x 30"H (280 lbs)

55ECWS8442R_ _ **\$4316**
 Executive single pedestal computer desk (RH) with fitted top, pencil/box/file pedestal (locking), right hand writing slide, 42" corner unit, two wire mgmt grommets in top
 30"- 42" x 84" x 30"H (375 lbs)

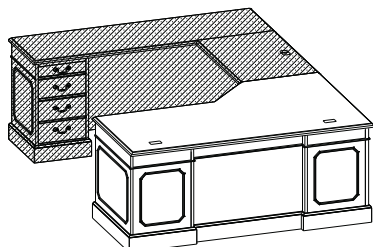

55ECWS7242R_ _ **\$4111**
 Executive single pedestal computer desk (RH) with fitted top, pencil/box/file pedestal (locking), right hand writing slide, 42" corner unit, two wire mgmt grommets in top
 30"- 42" x 72" x 30"H (340 lbs)

55ECWS7236R_ _ **\$4063**
 Executive single pedestal computer desk (RH) with fitted top, pencil/box/file pedestal (locking), right hand writing slide, 36" corner unit, two wire mgmt grommets in top
 24"- 36" x 72" x 30"H (283 lbs)

55ECWS6636R_ _ **\$3923**
 Executive single pedestal computer desk (RH) with fitted top, pencil/box/file pedestal (locking), right hand writing slide, 36" corner unit, two wire mgmt grommets in top
 24"- 36" x 66" x 30"H (260 lbs)

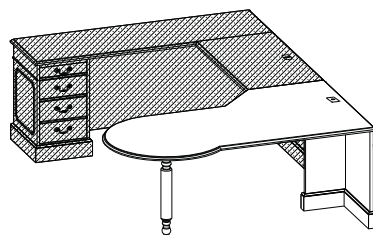

55ECWSP76R_ _ **\$3253**
 Freestanding P-Top computer desk (RH), 36" diameter end, with sculptured wood pedestal leg, 42" corner unit, one wire mgmt grommet in top
 30"-42" x 76" x 30"H (330 lbs)

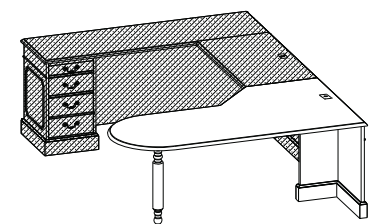

55ECWSB76R_ _ **\$2934**
 Freestanding bullet top computer desk (RH), 30" diameter end, with sculptured wood pedestal leg, 42" corner unit, one wire mgmt grommet in top
 30"-42" x 76" x 30"H (330 lbs)

GEORGIAN SERIES

List Price

Computer Desk U Workstations - Connecting Bridges

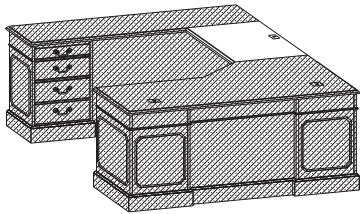

| | |
|--|---------------|
| 55WS36R _ | \$1139 |
| Executive height corner bridge (RH), one computer grommet 24" x 36" x 30"H (65 lbs) | |
| 55WS42R _ | \$1352 |
| Executive height corner bridge (RH), one computer grommet 24" x 42" x 30"H (65 lbs) | |
| 55WS48R _ | \$1513 |
| Executive height corner bridge (RH), one computer grommet 24" x 48" x 30"H (65 lbs) | |

Computer Desk U Workstations - Single Pedestal Credenzas

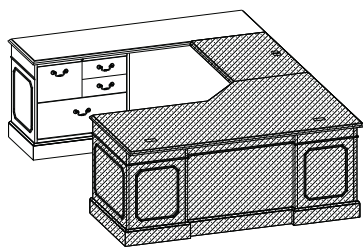

| | |
|--|---------------|
| 55DCSPL84FC _ _ | \$3994 |
| Single pedestal credenza (LH), file center pedestal (locking), two box, one file drawer top, one lateral file drawer bottom, one wire mgmt grommet, 52 3/4"W kneespace 21" x 84" x 30"H (320 lbs) | |
| 55DCSPL84FC-24 | \$4423 |
| 24" x 84" x 30"H | |
| 55DCSPL72FC _ _ | \$3734 |
| Single pedestal credenza (LH), file center pedestal (locking), two box, one file drawer top, one lateral file drawer bottom, one wire mgmt grommet, 40 3/4"W kneespace 21" x 72" x 30"H (260 lbs) | |
| 55DCSPL72FC-24 | \$4130 |
| 24" x 72" x 30"H | |
| 55DCSPL66FC _ _ | \$3495 |
| Single pedestal credenza (LH), file center pedestal (locking), two box, one file drawer top, one lateral file drawer bottom, one wire mgmt grommet, 34 3/4"W kneespace 21" x 66" x 30"H (215 lbs) | |
| 55DCSPL66FC-24 | \$3858 |
| 24" x 66" x 30"H | |

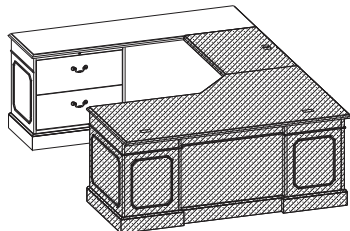

| | |
|--|---------------|
| 55DCSPL84LF _ _ | \$3791 |
| Single pedestal credenza (LH), two lateral file drawers (locking), legal or letter filing, one wire mgmt grommet in back panel, 52 3/4"W kneespace 21" x 84" x 30"H (290 lbs) | |
| 55DCSPL84LF-24 | \$4220 |
| 24" x 84" x 30"H | |
| 55DCSPL72LF _ _ | \$3471 |
| Single pedestal credenza (LH), two lateral file drawers (locking), legal or letter filing, one wire mgmt grommet in back panel, 40 3/4"W kneespace 21" x 72" x 30"H (275 lbs) | |
| 55DCSPL72LF-24 | \$3867 |
| 24" x 72" x 30"H | |
| 55DCSPL66LF _ _ | \$3237 |
| Single pedestal credenza (LH), two lateral file drawers (locking), legal or letter filing, one wire mgmt grommet in back panel, 34 3/4"W kneespace 21" x 66" x 30"H (260 lbs) | |
| 55DCSPL66LF-24 | \$3600 |
| 24" x 66" x 30"H | |

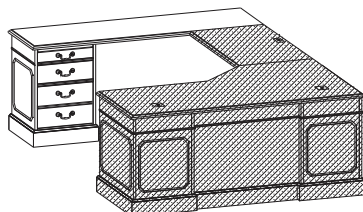

| | |
|--|---------------|
| 55DCSPL72 _ _ | \$3498 |
| Single pedestal credenza (LH), pencil/box/file pedestal (locking), one wire mgmt grommet in back panel, 54"W kneespace 21" x 72" x 30"H (220 lbs) | |
| 55DCSPL72-24 | \$3890 |
| 24" x 72" x 30"H | |
| 55DCSPL66 _ _ | \$3345 |
| Single pedestal credenza (LH), pencil/box/file pedestal (locking), one wire mgmt grommet in back panel, 48"W kneespace 21" x 66" x 30"H (205 lbs) | |
| 55DCSPL66-24 | \$3708 |
| 24" x 66" x 30"H | |
| 55DCSPL60 _ _ | \$3276 |
| Single pedestal credenza (LH), pencil/box/file pedestal (locking), one wire mgmt grommet in back panel, 42"W kneespace 21" x 60" x 30"H (195 lbs) | |
| 55DCSPL60-24 | \$3606 |
| 24" x 60" x 30"H | |

GEORGIAN SERIES

List Price

Computer Desk U Workstations - Single Pedestal Desks

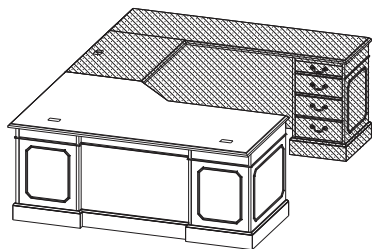

55ECWS8446L_ _ **\$4483**
 Executive single pedestal computer desk (LH) with conference top, pencil/box/file pedestal (locking), left hand writing slide, 46" corner unit, 4" approach overhang, two wire mgmt grommets in top
 34"- 46" x 84" x 30"H (385 lbs)

55ECWS7246L_ _ **\$4243**
 Executive single pedestal computer desk (LH) with conference top, pencil/box/file pedestal (locking), left hand writing slide, 46" corner unit, 4" approach overhang, two wire mgmt grommets in top
 34"- 46" x 72" x 30"H (360 lbs)

55ECWS6640L_ _ **\$3955**
 Executive single pedestal computer desk (LH) with conference top, pencil/box/file pedestal (locking), left hand writing slide, 40" corner unit, 4" approach overhang, two wire mgmt grommets in top
 28"- 40" x 66" x 30"H (280 lbs)

55ECWS8442L_ _ **\$4316**
 Executive single pedestal computer desk (LH) with fitted top, pencil/box/file pedestal (locking), left hand writing slide, 42" corner unit, two wire mgmt grommets in top
 30"- 42" x 84" x 30"H (375 lbs)

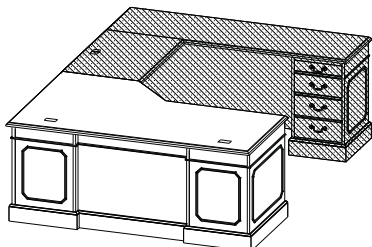

55ECWS7242L_ _ **\$4111**
 Executive single pedestal computer desk (LH) with fitted top, pencil/box/file pedestal (locking), left hand writing slide, 42" corner unit, two wire mgmt grommets in top
 30"- 42" x 72" x 30"H (340 lbs)

55ECWS7236L_ _ **\$4063**
 Executive single pedestal computer desk (LH) with fitted top, pencil/box/file pedestal (locking), left hand writing slide, 36" corner unit, two wire mgmt grommets in top
 24"- 36" x 72" x 30"H (283 lbs)

55ECWS6636L_ _ **\$3923**
 Executive single pedestal computer desk (LH) with fitted top, pencil/box/file pedestal (locking), left hand writing slide, 36" corner unit, two wire mgmt grommets in top
 24"- 36" x 66" x 30"H (260 lbs)

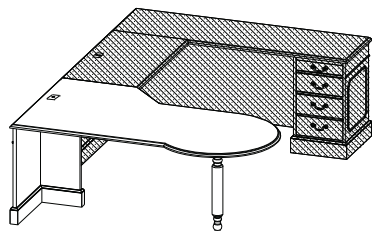

55ECWSP76L_ _ **\$3253**
 Freestanding P-Top computer desk (LH), 36" diameter end, with sculptured wood pedestal leg, 42" corner unit, one wire mgmt grommet in top
 30"-42" x 76" x 30"H (330 lbs)

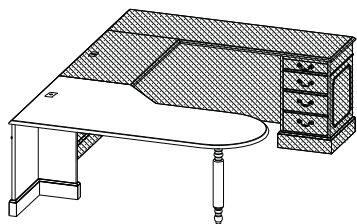

55ECWSB76L_ _ **\$2934**
 Freestanding bullet top computer desk (LH), 30" diameter end, with sculptured wood pedestal leg, 42" corner unit, one wire mgmt grommet in top
 30"-42" x 76" x 30"H (330 lbs)

GEORGIAN SERIES

List Price

Computer Desk U Workstations - Connecting Bridges

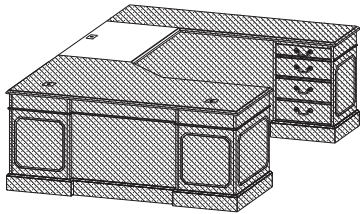

| | |
|--|---------------|
| 55WS36L _ | \$1139 |
| Executive height corner bridge (LH), one computer grommet 24" x 36" x 30"H (65 lbs) | |
| 55WS42L _ | \$1352 |
| Executive height corner bridge (LH), one computer grommet 24" x 42" x 30"H (65 lbs) | |
| 55WS48L _ | \$1513 |
| Executive height corner bridge (LH), one computer grommet 24" x 48" x 30"H (65 lbs) | |

Computer Desk U Workstations - Single Pedestal Credenzas

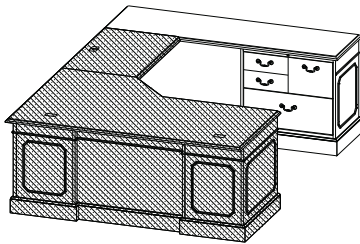

| | |
|--|---------------|
| 55DCSPR84FC _ _ | \$3994 |
| Single pedestal credenza (RH), file center pedestal (locking), two box, one file drawer top, one lateral file drawer bottom, one wire mgmt grommet, 52 3/4"W kneespace 21" x 84" x 30"H (320 lbs) | |
| 55DCSPR84FC-24 - 24" x 84" x 30"H | \$4423 |
| 55DCSPR72FC _ _ | \$3734 |
| Single pedestal credenza (RH), file center pedestal (locking), two box, one file drawer top, one lateral file drawer bottom, one wire mgmt grommet, 40 3/4"W kneespace 21" x 72" x 30"H (260 lbs) | |
| 55DCSPR72FC-24 - 24" x 72" x 30"H | \$4130 |
| 55DCSPR66FC _ _ | \$3495 |
| Single pedestal credenza (RH), file center pedestal (locking), two box, one file drawer top, one lateral file drawer bottom, one wire mgmt grommet, 34 3/4"W kneespace 21" x 66" x 30"H (215 lbs) | |
| 55DCSPR66FC-24 - 24" x 66" x 30"H | \$3858 |

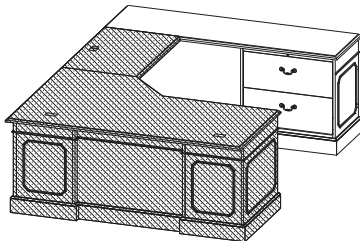

| | |
|--|---------------|
| 55DCSPR84LF _ _ | \$3791 |
| Single pedestal credenza (RH), two lateral file drawers (locking), legal or letter filing, one wire mgmt grommet in back panel, 52 3/4"W kneespace 21" x 84" x 30"H (290 lbs) | |
| 55DCSPR84LF-24 - 24" x 84" x 30"H | \$4220 |
| 55DCSPR72LF _ _ | \$3471 |
| Single pedestal credenza (RH), two lateral file drawers (locking), legal or letter filing, one wire mgmt grommet in back panel, 40 3/4"W kneespace 21" x 72" x 30"H (275 lbs) | |
| 55DCSPR72LF-24 - 24" x 72" x 30"H | \$3867 |
| 55DCSPR66LF _ _ | \$3237 |
| Single pedestal credenza (RH), two lateral file drawers (locking), legal or letter filing, one wire mgmt grommet in back panel, 34 3/4"W kneespace 21" x 66" x 30"H (260 lbs) | |
| 55DCSPR66LF-24 - 24" x 66" x 30"H | \$3600 |

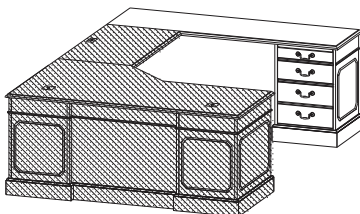

| | |
|--|---------------|
| 55DCSPR72 _ _ | \$3498 |
| Single pedestal credenza (RH), pencil/box/file pedestal (locking), one wire mgmt grommet in back panel, 54"W kneespace 21" x 72" x 30"H (220 lbs) | |
| 55DCSPR72-24 - 24" x 72" x 30"H | \$3890 |
| 55DCSPR66 _ _ | \$3345 |
| Single pedestal credenza (RH), pencil/box/file pedestal (locking), one wire mgmt grommet in back panel, 48"W kneespace 21" x 66" x 30"H (205 lbs) | |
| 55DCSPR66-24 - 24" x 66" x 30"H | \$3708 |
| 55DCSPR60 _ _ | \$3276 |
| Single pedestal credenza (RH), pencil/box/file pedestal (locking), one wire mgmt grommet in back panel, 42"W kneespace 21" x 60" x 30"H (195 lbs) | |
| 55DCSPR60-24 - 24" x 60" x 30"H | \$3606 |

GEORGIAN SERIES

List Price

U Configurations - Single Pedestal Desks

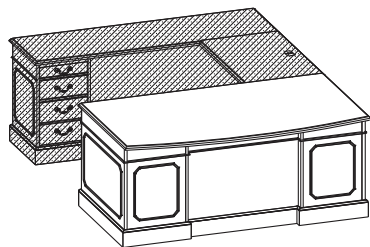

55KSPR84 __ __ \$4834
 Executive single pedestal desk (RH) with arc conference top, pencil/box/file pedestal, center drawer, central locking, right hand writing slide, 6" approach overhang
 42" x 84" x 30"H (350 lbs)

55KSPR72 __ __ \$4583
 Executive single pedestal desk (RH) with arc conference top, pencil/box/file pedestal, center drawer, central locking, right hand writing slide, 6" approach overhang
 42" x 72" x 30"H (325 lbs)

55KSPR7236 __ __ \$4470
 Executive single pedestal desk (RH) with arc conference top, pencil/box/file pedestal, center drawer, central locking, right hand writing slide, 6" approach overhang
 36" x 72" x 30"H (310 lbs)

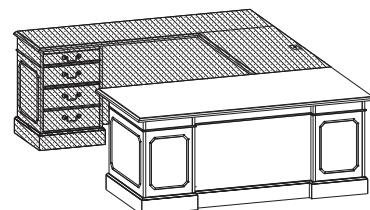

55SPR84 __ __ \$4689
 Executive single pedestal desk (RH) with conference top, pencil/box/file pedestal, center drawer, central locking, right hand writing slide, 6" approach and right side overhang
 42" x 84" x 30"H (340 lbs)

55SPR72 __ __ \$4403
 Executive single pedestal desk (RH) with conference top, pencil/box/file pedestal, center drawer, central locking, right hand writing slide, 6" approach and right side overhang
 36" x 72" x 30"H (310 lbs)

55SPR6636 __ __ \$4004
 Executive single pedestal desk (RH) with conference top, pencil/box/file pedestal, center drawer, central locking, right hand writing slide, 6" approach overhang only
 36" x 66" x 30"H (280 lbs)

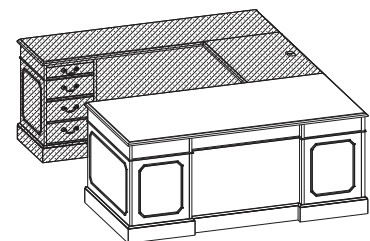

55SPR72F __ __ \$4575
 Executive single pedestal desk (RH) with fitted top, pencil/box/file pedestal, center drawer, central locking, right hand writing slide
 36" x 72" x 30"H (300 lbs)

55SPR7230F __ __ \$4167
 Executive single pedestal desk (RH) with fitted top, pencil/box/file pedestal, center drawer, central locking, right hand writing slide
 30" x 72" x 30"H (290 lbs)

55SPR66F __ __ \$3866
 Executive single pedestal desk (RH) with fitted top, pencil/box/file pedestal, center drawer, central locking, right hand writing slide
 30" x 66" x 30"H (275 lbs)

55SPR60F __ __ \$3692
 Executive single pedestal desk (RH) with fitted top, pencil/box/file pedestal, center drawer, central locking, right hand writing slide, 10" w pedestal accommodates side-to-side letter or legal filing only. If freestanding option is specified, pedestal will be letter width.
 30" x 60" x 30"H (250 lbs)

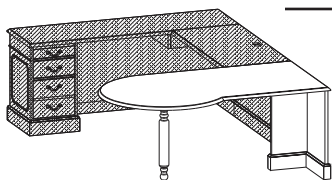

55WSP72R _ \$3058
 P-Top desk (RH), 42" diameter end, with sculptured wood pedestal leg 36"-42" x 72" x 30"H (170 lbs)

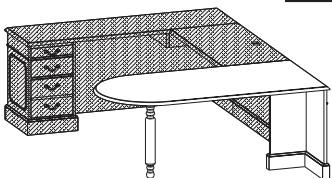

55WSB7236R _ \$2689
 Bullet top desk (RH), 36" diameter end, with sculptured wood pedestal leg, 42" corner unit
 36" x 72" x 30"H (170 lbs)

GEORGIAN SERIES

List Price

U Configurations - Connecting Bridges

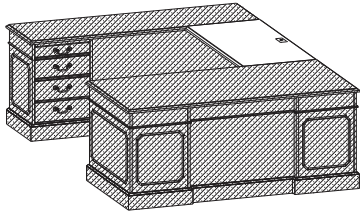

| | | |
|-----------------|---|---------------|
| 55WS54 _ | Executive height bridge, one computer grommet 24" x 54" x 30"H (105 lbs) | \$1693 |
| 55WS48 _ | Executive height bridge, one computer grommet 24" x 48" x 30"H (95 lbs) | \$1513 |
| 55WS42 _ | Executive height bridge, one computer grommet 24" x 42" x 30"H (78 lbs) | \$1352 |

U Configurations - Single Pedestal Credenzas

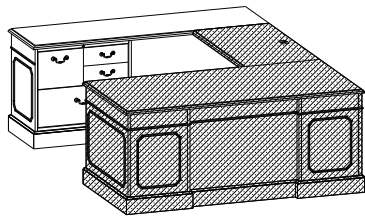

| | | |
|-------------------------|--|---------------|
| 55DCSPL84FC _ | Single pedestal credenza (LH), file center pedestal (locking), two box, one file drawer top, one lateral file drawer bottom, one wire mgmt grommet, 52 3/4"W kneespace 21" x 84" x 30"H (320 lbs) | \$3994 |
| 55DCSPL84FC-24 - | 24" x 84" x 30"H | \$4423 |
| 55DCSPL72FC _ | Single pedestal credenza (LH), file center pedestal (locking), two box, one file drawer top, one lateral file drawer bottom, one wire mgmt grommet, 40 3/4"W kneespace 21" x 72" x 30"H (260 lbs) | \$3734 |
| 55DCSPL72FC-24 - | 24" x 72" x 30"H | \$4130 |
| 55DCSPL66FC _ | Single pedestal credenza (LH), file center pedestal (locking), two box, one file drawer top, one lateral file drawer bottom, one wire mgmt grommet, 34 3/4"W kneespace 21" x 66" x 30"H (215 lbs) | \$3495 |
| 55DCSPL66FC-24 - | 24" x 66" x 30"H | \$3858 |

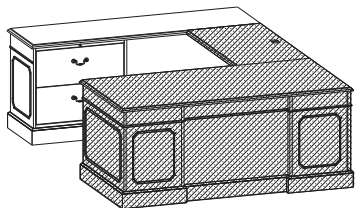

| | | |
|-------------------------|--|---------------|
| 55DCSPL84LF _ | Single pedestal credenza (LH), two lateral file drawers (locking), legal or letter filing, one wire mgmt grommet in back panel, 52 3/4"W kneespace 21" x 84" x 30"H (290 lbs) | \$3791 |
| 55DCSPL84LF-24 - | 24" x 84" x 30"H | \$4220 |
| 55DCSPL72LF _ | Single pedestal credenza (LH), two lateral file drawers (locking), legal or letter filing, one wire mgmt grommet in back panel, 40 3/4"W kneespace 21" x 72" x 30"H (275 lbs) | \$3471 |
| 55DCSPL72LF-24 - | 24" x 72" x 30"H | \$3867 |
| 55DCSPL66LF _ | Single pedestal credenza (LH), two lateral file drawers (locking), legal or letter filing, one wire mgmt grommet in back panel, 34 3/4"W kneespace 21" x 66" x 30"H (260 lbs) | \$3237 |
| 55DCSPL66LF-24 - | 24" x 66" x 30"H | \$3600 |

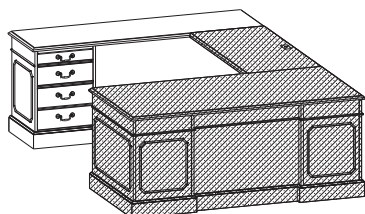

| | | |
|-----------------------|--|---------------|
| 55DCSPL72 _ | Single pedestal credenza (LH), pencil/box/file pedestal (locking), one wire mgmt grommet in back panel, 54"W kneespace 21" x 72" x 30"H (220 lbs) | \$3498 |
| 55DCSPL72-24 - | 24" x 72" x 30"H | \$3890 |
| 55DCSPL66 _ | Single pedestal credenza (LH), pencil/box/file pedestal (locking), one wire mgmt grommet in back panel, 48"W kneespace 21" x 66" x 30"H (205 lbs) | \$3345 |
| 55DCSPL66-24 - | 24" x 66" x 30"H | \$3708 |
| 55DCSPL60 _ | Single pedestal credenza (LH), pencil/box/file pedestal (locking), one wire mgmt grommet in back panel, 42"W kneespace 21" x 60" x 30"H (195 lbs) | \$3276 |
| 55DCSPL60-24 - | 24" x 60" x 30"H | \$3606 |

GEORGIAN SERIES

List Price

U Configurations - Single Pedestal Desks

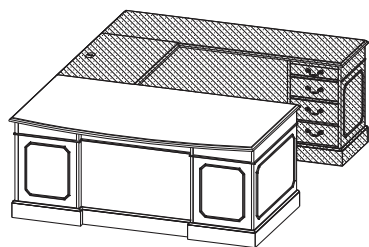

55KSPL84 __ _ \$4834
 Executive single pedestal desk (LH) with arc conference top, pencil/box/file pedestal, center drawer, central locking, left hand writing slide, 6" approach overhang
 42" x 84" x 30"H (350 lbs)

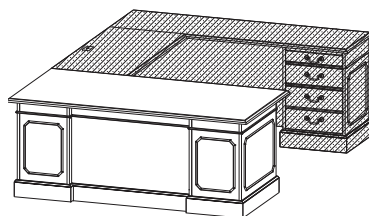

55KSPL72 __ _ \$4583
 Executive single pedestal desk (LH) with arc conference top, pencil/box/file pedestal, center drawer, central locking, left hand writing slide, 6" approach overhang
 42" x 72" x 30"H (325 lbs)

55KSPL7236 __ _ \$4470
 Executive single pedestal desk (LH) with arc conference top, pencil/box/file pedestal, center drawer, central locking, left hand writing slide, 6" approach overhang
 36" x 72" x 30"H (310 lbs)

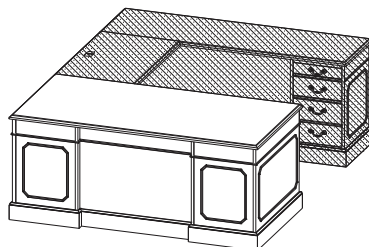

55SPL84 __ _ \$4689
 Executive single pedestal desk (LH) with conference top, pencil/box/file pedestal, center drawer, central locking, left hand writing slide, 6" approach and left side overhang
 42" x 84" x 30"H (340 lbs)

55SPL72 __ _ \$4403
 Executive single pedestal desk (LH) with conference top, pencil/box/file pedestal, center drawer, central locking, left hand writing slide, 6" approach and left side overhang
 36" x 72" x 30"H (310 lbs)

55SPL6636 __ _ \$4004
 Executive single pedestal desk (LH) with conference top, pencil/box/file pedestal, center drawer, central locking, right hand writing slide, 6" approach overhang only
 36" x 66" x 30"H (280 lbs)

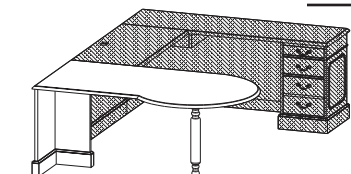

55SPL72F __ _ \$4575
 Executive single pedestal desk (LH) with fitted top, pencil/box/file pedestal, center drawer, central locking, left hand writing slide
 36" x 72" x 30"H (300 lbs)

55SPL7230F __ _ \$4167
 Executive single pedestal desk (LH) with fitted top, pencil/box/file pedestal, center drawer, central locking, left hand writing slide
 30" x 72" x 30"H (290 lbs)

55SPL66F __ _ \$3866
 Executive single pedestal desk (LH) with fitted top, pencil/box/file pedestal, center drawer, central locking, left hand writing slide
 30" x 66" x 30"H (275 lbs)

55SPL60F __ _ \$3692
 Executive single pedestal desk (LH) with fitted top, pencil/box/file pedestal, center drawer, central locking, left hand writing slide, 10" w pedestal accommodates side-to-side letter or legal filing only. If freestanding option is specified, pedestal will be letter width.
 30" x 60" x 30"H (250 lbs)

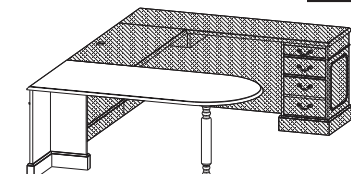

55WSP72L __ _ \$3058
 P-Top desk (LH), 42" diameter end, with sculptured wood pedestal leg 36"-42" x 72" x 30"H (170 lbs)

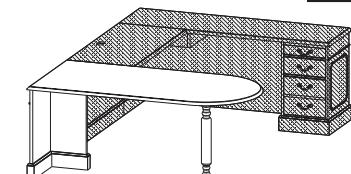

55WSB7236L __ _ \$2689
 Bullet top desk (LH), 36" diameter end, with sculptured wood pedestal leg, 42" corner unit
 36" x 72" x 30"H (170 lbs)

GEORGIAN SERIES

List Price

U Configurations - Connecting Bridges

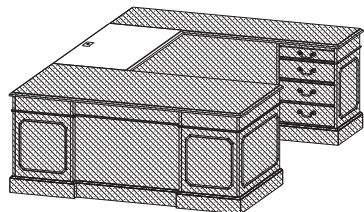

| | | |
|-----------------|---|---------------|
| 55WS54 _ | Executive height bridge, one computer grommet 24" x 54" x 30"H (105 lbs) | \$1693 |
| 55WS48 _ | Executive height bridge, one computer grommet 24" x 48" x 30"H (95 lbs) | \$1513 |
| 55WS42 _ | Executive height bridge, one computer grommet 24" x 42" x 30"H (78 lbs) | \$1352 |

U Configurations - Single Pedestal Credenzas

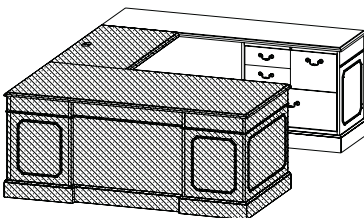

| | | |
|-----------------------|--|---------------|
| 55DCSPR84FC _ | Single pedestal credenza (RH), file center pedestal (locking), two box, one file drawer top, one lateral file drawer bottom, one wire mgmt grommet, 52 3/4"W kneespace 21" x 84" x 30"H (320 lbs) | \$3994 |
| 55DCSPR84FC-24 | 24" x 84" x 30"H | \$4423 |
| 55DCSPR72FC _ | Single pedestal credenza (RH), file center pedestal (locking), two box, one file drawer top, one lateral file drawer bottom, one wire mgmt grommet, 40 3/4"W kneespace 21" x 72" x 30"H (260 lbs) | \$3734 |
| 55DCSPR72FC-24 | 24" x 72" x 30"H | \$4130 |
| 55DCSPR66FC _ | Single pedestal credenza (RH), file center pedestal (locking), two box, one file drawer top, one lateral file drawer bottom, one wire mgmt grommet, 34 3/4"W kneespace 21" x 66" x 30"H (215 lbs) | \$3495 |
| 55DCSPR66FC-24 | 24" x 66" x 30"H | \$3858 |

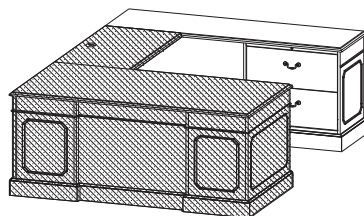

| | | |
|-----------------------|--|---------------|
| 55DCSPR84LF _ | Single pedestal credenza (RH), two lateral file drawers (locking), legal or letter filing, one wire mgmt grommet in back panel, 52 3/4"W kneespace 21" x 84" x 30"H (290 lbs) | \$3791 |
| 55DCSPR84LF-24 | 24" x 84" x 30"H | \$4220 |
| 55DCSPR72LF _ | Single pedestal credenza (RH), two lateral file drawers (locking), legal or letter filing, one wire mgmt grommet in back panel, 40 3/4"W kneespace 21" x 72" x 30"H (275 lbs) | \$3471 |
| 55DCSPR72LF-24 | 24" x 72" x 30"H | \$3867 |
| 55DCSPR66LF _ | Single pedestal credenza (RH), two lateral file drawers (locking), legal or letter filing, one wire mgmt grommet in back panel, 34 3/4"W kneespace 21" x 66" x 30"H (260 lbs) | \$3237 |
| 55DCSPR66LF-24 | 24" x 66" x 30"H | \$3600 |

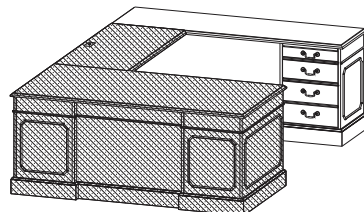

| | | |
|---------------------|--|---------------|
| 55DCSPR72 _ | Single pedestal credenza (RH), pencil/box/file pedestal (locking), one wire mgmt grommet in back panel, 54"W kneespace 21" x 72" x 30"H (220 lbs) | \$3498 |
| 55DCSPR72-24 | 24" x 72" x 30"H | \$3890 |
| 55DCSPR66 _ | Single pedestal credenza (RH), pencil/box/file pedestal (locking), one wire mgmt grommet in back panel, 48"W kneespace 21" x 66" x 30"H (205 lbs) | \$3345 |
| 55DCSPR66-24 | 24" x 66" x 30"H | \$3708 |
| 55DCSPR60 _ | Single pedestal credenza (RH), pencil/box/file pedestal (locking), one wire mgmt grommet in back panel, 42"W kneespace 21" x 60" x 30"H (195 lbs) | \$3276 |
| 55DCSPR60-24 | 24" x 60" x 30"H | \$3606 |

GEORGIAN SERIES

List Price

Corner Configurations - Connecting Corners

55CWS42_ \$2492

Corner unit - 42", one computer grommet
42" x 42" x 30"H (160 lbs)

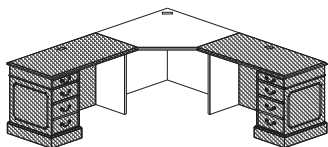

55CWS36_ \$2059

Corner unit - 36", one computer grommet
36" x 36" x 30"H (140 lbs)

Corner Configurations - Connecting Units

55ERR60FCCU_ _ \$2937

Executive height return (RH), file center pedestal (locking), two box, one file drawer top, one lateral file drawer bottom, one wire mgmt grommet, 30"W kneespace
24" x 60" x 30"H (195 lbs)

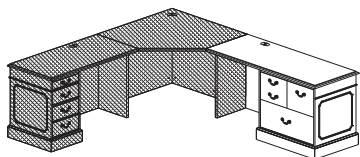

55ERR54FCCU_ _ \$2811

Executive height return (RH), file center pedestal (locking), two box, one file drawer top, one lateral file drawer bottom, one wire mgmt grommet, 24"W kneespace
24" x 54" x 30"H (180 lbs)

55ERR60LFCU_ _ \$2836

Executive height return (RH), two lateral file drawers (locking), one wire mgmt grommet, 30"W kneespace
24" x 60" x 30"H (195 lbs)

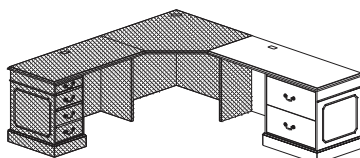

55ERR54LFCU_ _ \$2709

Executive height return (RH), two lateral file drawers (locking), one wire mgmt grommet, 24"W kneespace
24" x 54" x 30"H (180 lbs)

55ERR72CU_ _ \$2796

Executive height return (RH), pencil/box/file pedestal (locking), 1/2 support panel on connection end, one wire mgmt grommet, 54"W kneespace
24" x 72" x 30"H (225 lbs)

55ERR48CU_ _ \$2202

Executive height return (RH), pencil/box/file pedestal (locking), one wire mgmt grommet, 31"W kneespace
24" x 48" x 30"H (150 lbs)

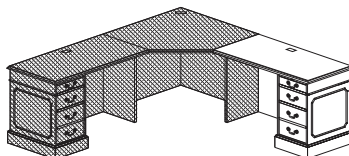

55ERR42CU_ _ \$2013

Executive height return (RH), pencil/box/file pedestal (locking), one wire mgmt grommet, 25"W kneespace
24" x 42" x 30"H (140 lbs)

55ERR36CU_ _ \$1851

Executive height return (RH), pencil/box/file pedestal (locking), one wire mgmt grommet, 19"W kneespace
24" x 36" x 30"H (120 lbs)

GEORGIAN SERIES

List Price

Corner Configurations - Connecting Corners

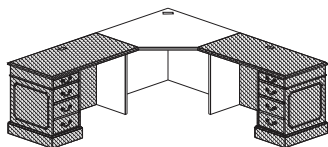

55CWS42_ **\$2492**
 Corner unit - 42", one computer grommet
 42" x 42" x 30"H (160 lbs)

55CWS36_ **\$2059**
 Corner unit - 36", one computer grommet
 36" x 36" x 30"H (140 lbs)

Corner Configurations - Connecting Units

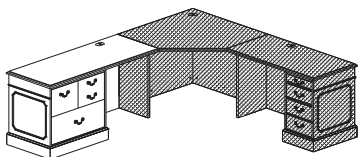

55ERL60FCCU_ _ **\$2937**
 Executive height return (LH), file center pedestal (locking), two box, one file drawer top, one lateral file drawer bottom, one wire mgmt grommet, 30"W kneespace
 24" x 60" x 30"H (195 lbs)

55ERL54FCCU_ _ **\$2811**
 Executive height return (LH), file center pedestal (locking), two box, one file drawer top, one lateral file drawer bottom, one wire mgmt grommet, 24"W kneespace
 24" x 54" x 30"H (180 lbs)

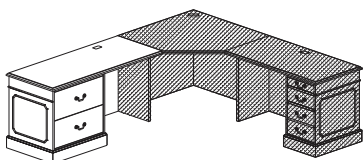

55ERL60LFCU_ _ **\$2836**
 Executive height return (LH), two lateral file drawers (locking), one wire mgmt grommet, 30"W kneespace
 24" x 60" x 30"H (195 lbs)

55ERL54LFCU_ _ **\$2709**
 Executive height return (LH), two lateral file drawers (locking), one wire mgmt grommet, 24"W kneespace
 24" x 54" x 30"H (180 lbs)

55ERL72CU_ _ **\$2796**
 Executive height return (LH), pencil/box/file pedestal (locking), 1/2 support panel on connection end, one wire mgmt grommet, 54"W kneespace
 24" x 72" x 30"H (225 lbs)

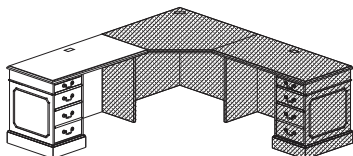

55ERL48CU_ _ **\$2202**
 Executive height return (LH), pencil/box/file pedestal (locking), one wire mgmt grommet, 31"W kneespace
 24" x 48" x 30"H (150 lbs)

55ERL42CU_ _ **\$2013**
 Executive height return (LH), pencil/box/file pedestal (locking), one wire mgmt grommet, 25"W kneespace
 24" x 42" x 30"H (140 lbs)

55ERL36CU_ _ **\$1851**
 Executive height return (LH), pencil/box/file pedestal (locking), one wire mgmt grommet, 19"W kneespace
 24" x 36" x 30"H (120 lbs)

GEORGIAN SERIES

List Price

Modular Overhead Storage Units

Modular hutches are used when you are ganging units together. Left units are used on the left side of the desk (flat or modular on right hand side), right units are used on right side of the desk (flat or modular on left hand side), and center units are used between a right and left hand unit (flat or modular on both sides)

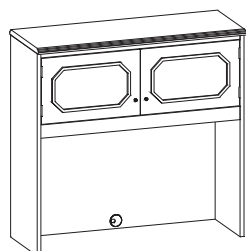
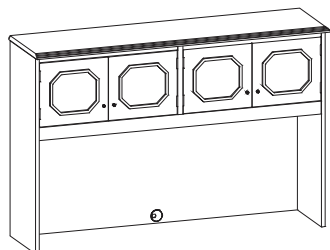
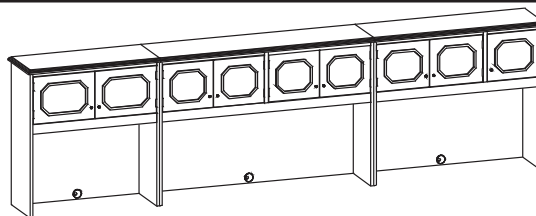

55MH70(R,L or C)_ _ **\$3119**
 Overhead storage unit with hinged wood doors, two storage areas behind four hinged doors (non-locking), two wire mgmt access grommets in center back panel
 22" clearance between apron rail & worksurface
 15" x 70" x 39"H (210 lbs)

55MH58(R,L or C)_ _ **\$2881**
 Overhead storage unit with hinged wood doors, two storage areas behind four hinged doors (non-locking), two wire mgmt access grommets in center back panel
 22" clearance between apron rail & worksurface
 15" x 58" x 39"H (175 lbs)

55MH46(R,L or C)_ _ **\$2659**
 Overhead storage unit with hinged wood doors, two storage areas behind three hinged doors (non-locking), two wire mgmt access grommets in center back panel
 22" clearance between apron rail & worksurface
 15" x 46" x 39"H (140 lbs)

55MH40(R,L or C)_ _ **\$2531**
 Overhead storage unit with hinged wood doors, one storage area behind two hinged doors (non-locking), two wire mgmt access grommets in center back panel
 22" clearance between apron rail & worksurface
 15" x 40" x 39"H (125 lbs)

55MH35(R,L or C)_ _ **\$2387**
 Overhead storage unit with hinged wood doors, one storage area behind two hinged doors (non-locking), two wire mgmt access grommets in center back panel
 22" clearance between apron rail & worksurface
 15" x 35" x 39"H (105 lbs)

Wall Mounted Storage Units

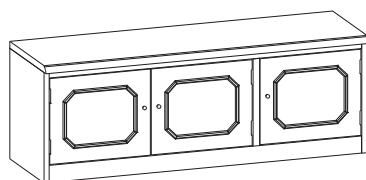

55WM48_ _ **\$1533**
 Wall mounted storage unit with three hinged doors
 16" x 48" x 16"H (89 lbs) **attaching wall bracket included

55WM42_ _ **\$1298**
 Wall mounted storage unit with three hinged doors
 16" x 42" x 16"H (80 lbs) **attaching wall bracket included

55WM36_ _ **\$1148**
 Wall mounted storage unit with two hinged doors
 16" x 36" x 16"H (70 lbs) **attaching wall bracket included

55WM30_ _ **\$1082**
 Wall mounted storage unit with two hinged doors
 16" x 30" x 16"H (60 lbs) **attaching wall bracket included

Accessories



TB48-12 **\$299**
 Fabric tackboard, (COM, Grade A, Grade B) 3/4" x 48" x 12"H (18 lbs)

TB42-12 **\$256**
 Fabric tackboard, (COM, Grade A, Grade B) 3/4" x 42" x 12"H (17 lbs)

TB36-12 **\$223**
 Fabric tackboard, (COM, Grade A, Grade B) 3/4" x 36" x 12"H (16 lbs)

TB30-12 **\$203**
 Fabric tackboard, (COM, Grade A, Grade B) 3/4" x 30" x 12"H (15 lbs)

TL48 **\$215**
 Task light (UL approved), 6" x 48" x 1 1/2"H (15 lbs)

TL24 **\$185**
 Task light (UL approved), 6" x 24" x 1 1/2"H (10 lbs)

GEORGIAN SERIES

List Price

Overhead Storage Units

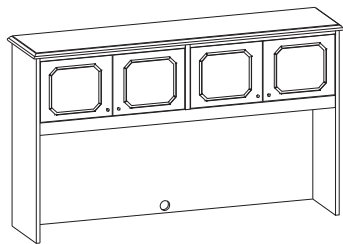

55HC82_ _ **\$3294**
 Overhead storage unit with hinged wood doors, two storage areas behind four hinged doors (non-locking), two wire mgmt access grommets in center back panel
 22" clearance between apron rail & worksurface
 15" x 81" x 39"H (253 lbs)

55HC76_ _ **\$3161**
 Overhead storage unit with hinged wood doors, two storage areas behind four hinged doors (non-locking), two wire mgmt access grommets in center back panel
 22" clearance between apron rail & worksurface
 15" x 75" x 39"H (235 lbs)

55HC70_ _ **\$3126**
 Overhead storage unit with hinged wood doors, two storage areas behind four hinged doors (non-locking), two wire mgmt access grommets in center back panel
 22" clearance between apron rail & worksurface
 15" x 69" x 39"H (215 lbs)

55HC64_ _ **\$2909**
 Overhead storage unit with hinged wood doors, two storage areas behind four hinged doors (non-locking), two wire mgmt access grommets in center back panel
 22" clearance between apron rail & worksurface
 15" x 63" x 39"H (200 lbs)

55HC58_ _ **\$2684**
 Overhead storage unit with hinged wood doors, two storage areas behind four hinged doors (non-locking), two wire mgmt access grommets in center back panel
 22" clearance between apron rail & worksurface
 15" x 57" x 39"H (188 lbs)

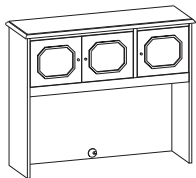

55HC46_ _ **\$2356**
 Overhead storage unit with hinged wood doors, two storage areas behind three hinged doors (non-locking), two wire mgmt access grommets in center back panel
 22" clearance between apron rail & worksurface
 15" x 45" x 39"H (145 lbs)

55HC40_ _ **\$2130**
 Overhead storage unit with hinged wood doors, two storage areas behind three hinged doors (non-locking), two wire mgmt access grommets in center back panel
 22" clearance between apron rail & worksurface
 15" x 39" x 39"H (130 lbs)

Accessories



TB77 **\$474**
 Fabric tackboard, (COM, Grade A, Grade B) 3/4" x 77" x 15 1/2"H (20 lbs)

TB71 **\$448**
 Fabric tackboard, (COM, Grade A, Grade B) 3/4" x 71" x 15 1/2"H (18 lbs)

TB65 **\$400**
 Fabric tackboard, (COM, Grade A, Grade B) 3/4" x 65" x 15 1/2"H (16 lbs)

TB59 **\$386**
 Fabric tackboard, (COM, Grade A, Grade B) 3/4" x 59" x 15 1/2"H (14 lbs)

TB53 **\$341**
 Fabric tackboard, (COM, Grade A, Grade B) 3/4" x 53" x 15 1/2"H (12 lbs)

TB41 **\$300**
 Fabric tackboard, (COM, Grade A, Grade B) 3/4" x 41" x 15 1/2"H (11 lbs)

TB35 **\$233**
 Fabric tackboard, (COM, Grade A, Grade B) 3/4" x 35" x 15 1/2"H (10 lbs)



TL48 **\$215**
 Task light (UL approved), 6" x 48" x 1 1/2"H (15 lbs)

TL24 **\$185**
 Task light (UL approved), 6" x 24" x 1 1/2"H (10 lbs)

GEORGIAN SERIES

List Price

Hutches

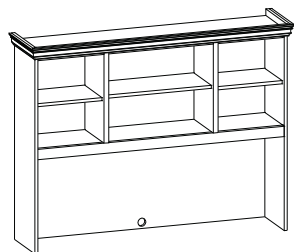

55HO81-O \$3507
 Overhead storage unit, open, three storage areas, one adjustable shelf per section, cornice top, two wire mgmt access grommets in center back panel
 23 1/2" clearance between apron rail & worksurface
 15 1/2" x 81" x 50"H (280 lbs)

55HO69-O \$3244
 Overhead storage unit, open, three storage areas, one adjustable shelf per section, cornice top, two wire mgmt access grommets in center back panel
 23 1/2" clearance between apron rail & worksurface
 15 1/2" x 69" x 50"H (210 lbs)

55HO63-O \$2971
 Overhead storage unit, open, three storage areas, one adjustable shelf per section, cornice top, two wire mgmt access grommets in center back panel
 23 1/2" clearance between apron rail & worksurface
 15 1/2" x 63" x 50"H (180 lbs)

55HO57-O \$2708
 Overhead storage unit, open, three storage areas, one adjustable shelf per section, cornice top, two wire mgmt access grommets in center back panel
 23 1/2" clearance between apron rail & worksurface
 15 1/2" x 57" x 50"H (165 lbs)

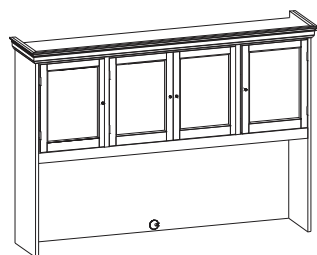

55HO81-W \$4520
 Overhead storage unit with hinged wood doors, three storage areas behind four hinged doors, one adjustable shelf per section, cornice top, two wire mgmt access grommets in center back panel
 23 1/2" clearance between apron rail & worksurface
 15 1/2" x 81" x 50"H (280 lbs)

55HO69-W \$3973
 Overhead storage unit with hinged wood doors, three storage areas behind four hinged doors, one adjustable shelf per section, cornice top, two wire mgmt access grommets in center back panel
 23 1/2" clearance between apron rail & worksurface
 15 1/2" x 69" x 50"H (210 lbs)

55HO63-W \$3700
 Overhead storage unit with hinged wood doors, three storage areas behind four hinged doors, one adjustable shelf per section, cornice top, two wire mgmt access grommets in center back panel
 23 1/2" clearance between apron rail & worksurface
 15 1/2" x 63" x 50"H (180 lbs)

55HO57-W \$3510
 Overhead storage unit with hinged wood doors, three storage areas behind four hinged doors, one adjustable shelf per section, cornice top, two wire mgmt access grommets in center back panel
 23 1/2" clearance between apron rail & worksurface
 15 1/2" x 57" x 50"H (165 lbs)

Accessories



TB77 \$474
 Fabric tackboard, (COM, Grade A, Grade B) 3/4" x 77" x 15 1/2"H (20 lbs)

TB65 \$400
 Fabric tackboard, (COM, Grade A, Grade B) 3/4" x 65" x 15 1/2"H (16 lbs)

TB59 \$386
 Fabric tackboard, (COM, Grade A, Grade B) 3/4" x 59" x 15 1/2"H (14 lbs)

TB53 \$341
 Fabric tackboard, (COM, Grade A, Grade B) 3/4" x 53" x 15 1/2"H (12 lbs)



TL48 \$215
 Task light (UL approved), 6" x 48" x 1 1/2"H (15 lbs)

TL24 \$185
 Task light (UL approved), 6" x 24" x 1 1/2"H (10 lbs)

GEORGIAN SERIES

List Price

Hutches

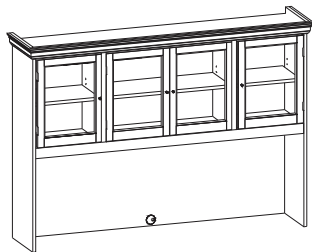

55HO81-G **\$4171**
 Overhead storage unit with hinged glass doors, three storage areas behind four hinged doors, one adjustable shelf per section, cornice top, two wire mgmt access grommets in center back panel
 23 1/2" clearance between apron rail & worksurface
 15 1/2" x 81" x 50"H (280 lbs)

55HO69-G **\$3878**
 Overhead storage unit with hinged glass doors, three storage areas behind four hinged doors, one adjustable shelf per section, cornice top, two wire mgmt access grommets in center back panel
 23 1/2" clearance between apron rail & worksurface
 15 1/2" x 69" x 50"H (210 lbs)

55HO63-G **\$3612**
 Overhead storage unit with hinged glass doors, three storage areas behind four hinged doors, one adjustable shelf per section, cornice top, two wire mgmt access grommets in center back panel
 23 1/2" clearance between apron rail & worksurface
 15 1/2" x 63" x 50"H (180 lbs)

55HO57-G **\$3370**
 Overhead storage unit with hinged glass doors, three storage areas behind four hinged doors, one adjustable shelf per section, cornice top, two wire mgmt access grommets in center back panel
 23 1/2" clearance between apron rail & worksurface
 15 1/2" x 57" x 50"H (165 lbs)

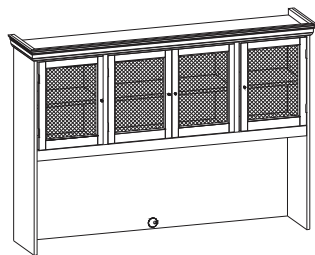

55HO81-M **\$4545**
 Overhead storage unit with hinged woven wire mesh doors, three storage areas behind four hinged doors, one adjustable shelf per section, cornice top, two wire mgmt access grommets in center back panel
 23 1/2" clearance between apron rail & worksurface
 15 1/2" x 81" x 50"H (280 lbs)

55HO69-M **\$4258**
 Overhead storage unit with hinged woven wire mesh doors, three storage areas behind four hinged doors, one adjustable shelf per section, cornice top, two wire mgmt access grommets in center back panel
 23 1/2" clearance between apron rail & worksurface
 15 1/2" x 69" x 50"H (210 lbs)

55HO63-M **\$3965**
 Overhead storage unit with hinged woven wire mesh doors, three storage areas behind four hinged doors, one adjustable shelf per section, cornice top, two wire mgmt access grommets in center back panel
 23 1/2" clearance between apron rail & worksurface
 15 1/2" x 63" x 50"H (180 lbs)

55HO57-M **\$3807**
 Overhead storage unit with hinged woven wire mesh doors, three storage areas behind four hinged doors, one adjustable shelf per section, cornice top, two wire mgmt access grommets in center back panel
 23 1/2" clearance between apron rail & worksurface
 15 1/2" x 57" x 50"H (165 lbs)

Accessories



TB77 **\$474**
 Fabric tackboard, (COM, Grade A, Grade B) 3/4" x 77" x 15 1/2"H (20 lbs)

TB65 **\$400**
 Fabric tackboard, (COM, Grade A, Grade B) 3/4" x 65" x 15 1/2"H (16 lbs)

TB59 **\$386**
 Fabric tackboard, (COM, Grade A, Grade B) 3/4" x 59" x 15 1/2"H (14 lbs)

TB53 **\$341**
 Fabric tackboard, (COM, Grade A, Grade B) 3/4" x 53" x 15 1/2"H (12 lbs)



TL48 **\$215**
 Task light (UL approved), 6" x 48" x 1 1/2"H (15 lbs)

TL24 **\$185**
 Task light (UL approved), 6" x 24" x 1 1/2"H (10 lbs)

GEORGIAN SERIES

List Price

Hutches

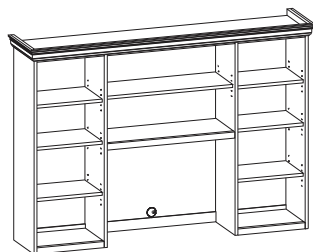

55HC81-O **\$4195**
 Open hutch, three storage areas, three adjustable shelves in outer sections, one adjustable shelf in center section, cornice top, two wire mgmt access grommets in center back panel
 23 1/2" clearance between apron rail & worksurface
 15 1/2" x 81" x 50"H (210 lbs)

55HC69-O **\$3600**
 Open hutch, three storage areas, three adjustable shelves in outer sections, one adjustable shelf in center section, cornice top, two wire mgmt access grommets in center back panel
 23 1/2" clearance between apron rail & worksurface
 15 1/2" x 69" x 50"H (210 lbs)

55HC63-O **\$3302**
 Open hutch, three storage areas, three adjustable shelves in outer sections, one adjustable shelf in center section, cornice top, two wire mgmt access grommets in center back panel
 23 1/2" clearance between apron rail & worksurface
 15 1/2" x 63" x 50"H (180 lbs)

55HC57-O **\$3005**
 Open hutch, three storage areas, three adjustable shelves in outer sections, one adjustable shelf in center section, cornice top, two wire mgmt access grommets in center back panel
 23 1/2" clearance between apron rail & worksurface
 15 1/2" x 57" x 50"H (165 lbs)

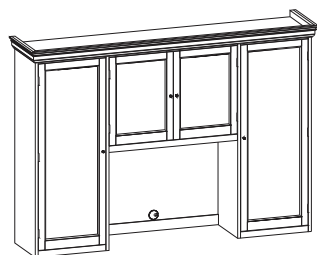

55HC81-W **\$5913**
 Hutch, hinged wooden doors (non-locking), three storage areas, three adjustable shelves in outer sections, one adjustable shelf in center section, cornice top, two wire mgmt access grommets in center back panel, 23 1/2" clearance between apron rail & worksurface
 15 1/2" x 81" x 50"H (280 lbs)

55HC69-W **\$5446**
 Hutch, hinged wooden doors (non-locking), three storage areas, three adjustable shelves in outer sections, one adjustable shelf in center section, cornice top, two wire mgmt access grommets in center back panel, 23 1/2" clearance between apron rail & worksurface
 15 1/2" x 69" x 50"H (210 lbs)

55HC63-W **\$4979**
 Hutch, hinged wooden doors (non-locking), three storage areas, three adjustable shelves in outer sections, one adjustable shelf in center section, cornice top, two wire mgmt access grommets in center back panel, 23 1/2" clearance between apron rail & worksurface
 15 1/2" x 63" x 50"H (180 lbs)

55HC57-W **\$4512**
 Hutch, hinged wooden doors (non-locking), three storage areas, three adjustable shelves in outer sections, one adjustable shelf in center section, cornice top, two wire mgmt access grommets in center back panel, 23 1/2" clearance between apron rail & worksurface
 15 1/2" x 57" x 50"H (165 lbs)

Accessories



TB43 **\$272**
 Fabric tackboard, (COM, Grade A, Grade B) 3/4" x 43" x 15 1/2"H (20 lbs)

TB31 **\$196**
 Fabric tackboard, (COM, Grade A, Grade B) 3/4" x 31" x 15 1/2"H (16 lbs)

TB25 **\$159**
 Fabric tackboard, (COM, Grade A, Grade B) 3/4" x 25" x 15 1/2"H (14 lbs)

TB19 **\$125**
 Fabric tackboard, (COM, Grade A, Grade B) 3/4" x 19" x 15 1/2"H (12 lbs)



TL48 **\$215**
 Task light (UL approved), 6" x 48" x 1 1/2"H (15 lbs)

TL24 **\$185**
 Task light (UL approved), 6" x 24" x 1 1/2"H (10 lbs)

GEORGIAN SERIES

List Price

Hutches

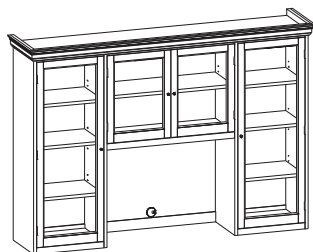

55HC81-G \$5533
 Hutch, hinged glass doors (non-locking), three storage areas, three adjustable shelves in outer sections, one adjustable shelf in center section, cornice top, two wire mgmt access grommets in center back panel, 23 1/2" clearance between apron rail & worksurface
 15 1/2" x 81" x 50"H (280 lbs)

55HC69-G \$5151
 Hutch, hinged glass doors (non-locking), three storage areas, three adjustable shelves in outer sections, one adjustable shelf in center section, cornice top, two wire mgmt access grommets in center back panel, 23 1/2" clearance between apron rail & worksurface
 15 1/2" x 69" x 50"H (210 lbs)

55HC63-G \$4726
 Hutch, hinged glass doors (non-locking), three storage areas, three adjustable shelves in outer sections, one adjustable shelf in center section, cornice top, two wire mgmt access grommets in center back panel, 23 1/2" clearance between apron rail & worksurface
 15 1/2" x 63" x 50"H (180 lbs)

55HC57-G \$4493
 Hutch, hinged glass doors (non-locking), three storage areas, three adjustable shelves in outer sections, one adjustable shelf in center section, cornice top, two wire mgmt access grommets in center back panel, 23 1/2" clearance between apron rail & worksurface
 15 1/2" x 57" x 50"H (165 lbs)

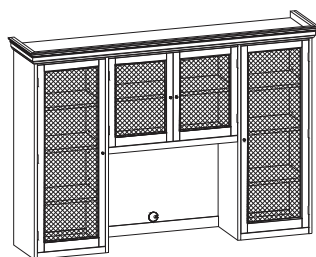

55HC81-M \$6147
 Hutch, hinged woven mesh doors (non-locking), three storage areas, three adjustable shelves in outer sections, one adjustable shelf in center section, cornice top, two wire mgmt access grommets in center back panel, 23 1/2" clearance between apron rail & worksurface
 15 1/2" x 81" x 50"H (280 lbs)

55HC69-M \$5923
 Hutch, hinged woven mesh doors (non-locking), three storage areas, three adjustable shelves in outer sections, one adjustable shelf in center section, cornice top, two wire mgmt access grommets in center back panel, 23 1/2" clearance between apron rail & worksurface
 15 1/2" x 69" x 50"H (210 lbs)

55HC63-M \$5433
 Hutch, hinged woven mesh doors (non-locking), three storage areas, three adjustable shelves in outer sections, one adjustable shelf in center section, cornice top, two wire mgmt access grommets in center back panel, 23 1/2" clearance between apron rail & worksurface
 15 1/2" x 63" x 50"H (180 lbs)

55HC57-M \$5206
 Hutch, hinged woven mesh doors (non-locking), three storage areas, three adjustable shelves in outer sections, one adjustable shelf in center section, cornice top, two wire mgmt access grommets in center back panel, 23 1/2" clearance between apron rail & worksurface
 15 1/2" x 57" x 50"H (165 lbs)

Accessories



TB43 \$272
 Fabric tackboard, (COM, Grade A, Grade B) 3/4" x 43" x 15 1/2"H (20 lbs)

TB31 \$196
 Fabric tackboard, (COM, Grade A, Grade B) 3/4" x 31" x 15 1/2"H (16 lbs)

TB25 \$159
 Fabric tackboard, (COM, Grade A, Grade B) 3/4" x 25" x 15 1/2"H (14 lbs)

TB19 \$125
 Fabric tackboard, (COM, Grade A, Grade B) 3/4" x 19" x 15 1/2"H (12 lbs)



TL48 \$215
 Task light (UL approved), 6" x 48" x 1 1/2"H (15 lbs)

TL24 \$185
 Task light (UL approved), 6" x 24" x 1 1/2"H (10 lbs)

GEORGIAN SERIES

List Price

Hutches

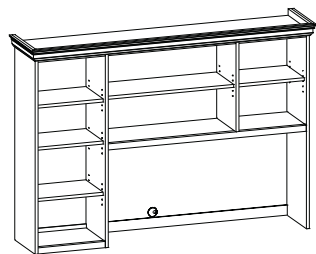

(Left version shown)

55HR81-O_ (right) \$3992

55HL81-O_ (left)

Open hutch, three storage areas, three adjustable shelves in outer riser section, one adjustable shelf in each upper overhead section, cornice top, two wire mgmt access grommets in center back panel
23 1/2" clearance between apron rail & worksurface
15 1/2" x 81" x 50"H (lbs)

55HR69-O_ (right) \$3422

55HL69-O_ (left)

Open hutch, three storage areas, three adjustable shelves in outer riser section, one adjustable shelf in each upper overhead section, cornice top, two wire mgmt access grommets in center back panel
23 1/2" clearance between apron rail & worksurface
15 1/2" x 69" x 50"H (lbs)

55HR63-O_ (right) \$3137

55HL63-O_ (left)

Open hutch, three storage areas, three adjustable shelves in outer riser section, one adjustable shelf in each upper overhead section, cornice top, two wire mgmt access grommets in center back panel
23 1/2" clearance between apron rail & worksurface
15 1/2" x 63" x 50"H (lbs)

55HR57-O_ (right) \$2852

55HL57-O_ (left)

Open hutch, three storage areas, three adjustable shelves in outer riser section, one adjustable shelf in each upper overhead section, cornice top, two wire mgmt access grommets in center back panel
23 1/2" clearance between apron rail & worksurface
15 1/2" x 57" x 50"H (lbs)

55HR81-W_ (right) \$5450

55HL81-W_ (left)

Hutch, hinged wooden doors (non-locking), three storage areas, three adjustable shelves in outer riser section, one adjustable shelf in each upper overhead section, cornice top, two wire mgmt access grommets in center back panel, 23 1/2" clearance between apron rail & worksurface
15 1/2" x 81" x 50"H (lbs)

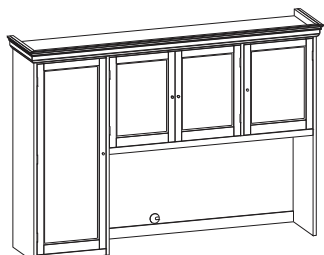

(Left version shown)

55HR69-W_ (right) \$4710

55HL69-W_ (left)

Hutch, hinged wooden doors (non-locking), three storage areas, three adjustable shelves in outer riser section, one adjustable shelf in each upper overhead section, cornice top, two wire mgmt access grommets in center back panel, 23 1/2" clearance between apron rail & worksurface
15 1/2" x 69" x 50"H (lbs)

55HR63-W_ (right) \$4339

55HL63-W_ (left)

Hutch, hinged wooden doors (non-locking), three storage areas, three adjustable shelves in outer riser section, one adjustable shelf in each upper overhead section, cornice top, two wire mgmt access grommets in center back panel, 23 1/2" clearance between apron rail & worksurface
15 1/2" x 63" x 50"H (lbs)

55HR57-W_ (right) \$3969

55HL57-W_ (left)

Hutch, hinged wooden doors (non-locking), three storage areas, three adjustable shelves in outer riser section, one adjustable shelf in each upper overhead section, cornice top, two wire mgmt access grommets in center back panel, 23 1/2" clearance between apron rail & worksurface
15 1/2" x 57" x 50"H (lbs)

Accessories



TB59 \$386

Fabric tackboard, (COM, Grade A, Grade B) 3/4" x 59" x 15 1/2"H (14 lbs)

TB47 \$338

Fabric tackboard, (COM, Grade A, Grade B) 3/4" x 47" x 15 1/2"H (16 lbs)

TB41 \$272

Fabric tackboard, (COM, Grade A, Grade B) 3/4" x 41" x 15 1/2"H (11 lbs)

TB36 \$233

Fabric tackboard, (COM, Grade A, Grade B) 3/4" x 36" x 15 1/2"H (10 lbs)



TL48 \$215

Task light (UL approved), 6" x 48" x 1 1/2"H (15 lbs)

TL24 \$185

Task light (UL approved), 6" x 24" x 1 1/2"H (10 lbs)

GEORGIAN SERIES

List Price

Hutches

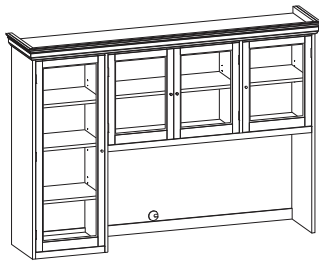

(Left version shown)

55HR81-G_ (right) \$4959

55HL81-G_ (left)

Hutch, hinged glass doors (non-locking), three storage areas, three adjustable shelves in outer riser section, one adjustable shelf in each upper overhead section, cornice top, two wire mgmt access grommets in center back panel, 23 1/2" clearance between apron rail & worksurface
15 1/2" x 81" x 50"H (lbs)

55HR69-G_ (right) \$4460

55HL69-G_ (left)

Hutch, hinged glass doors (non-locking), three storage areas, three adjustable shelves in outer riser section, one adjustable shelf in each upper overhead section, cornice top, two wire mgmt access grommets in center back panel, 23 1/2" clearance between apron rail & worksurface
15 1/2" x 69" x 50"H (lbs)

55HR63-G_ (right) \$4090

55HL63-G_ (left)

Hutch, hinged glass doors (non-locking), three storage areas, three adjustable shelves in outer riser section, one adjustable shelf in each upper overhead section, cornice top, two wire mgmt access grommets in center back panel, 23 1/2" clearance between apron rail & worksurface
15 1/2" x 63" x 50"H (lbs)

55HR57-G_ (right) \$3668

55HL57-G_ (left)

Hutch, hinged glass doors (non-locking), three storage areas, three adjustable shelves in outer riser section, one adjustable shelf in each upper overhead section, cornice top, two wire mgmt access grommets in center back panel, 23 1/2" clearance between apron rail & worksurface
15 1/2" x 57" x 50"H (lbs)

55HR81-M_ (right) \$6029

55HL81-M_ (left)

Hutch, hinged woven wire mesh doors (non-locking), three storage areas, three adjustable shelves in outer riser section, one adjustable shelf in each upper overhead section, cornice top, two wire mgmt access grommets in center back panel, 23 1/2" clearance between apron rail & worksurface
15 1/2" x 81" x 50"H (lbs)

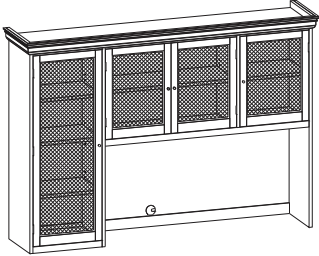

(Left version shown)

55HR69-M_ (right) \$5164

55HL69-M_ (left)

Hutch, hinged woven wire mesh doors (non-locking), three storage areas, three adjustable shelves in outer riser section, one adjustable shelf in each upper overhead section, cornice top, two wire mgmt access grommets in center back panel, 23 1/2" clearance between apron rail & worksurface
15 1/2" x 69" x 50"H (lbs)

55HR63-M_ (right) \$4772

55HL63-M_ (left)

Hutch, hinged woven wire mesh doors (non-locking), three storage areas, three adjustable shelves in outer riser section, one adjustable shelf in each upper overhead section, cornice top, two wire mgmt access grommets in center back panel, 23 1/2" clearance between apron rail & worksurface
15 1/2" x 63" x 50"H (lbs)

55HR57-M_ (right) \$4402

55HL57-M_ (left)

Hutch, hinged woven wire mesh doors (non-locking), three storage areas, three adjustable shelves in outer riser section, one adjustable shelf in each upper overhead section, cornice top, two wire mgmt access grommets in center back panel, 23 1/2" clearance between apron rail & worksurface
15 1/2" x 57" x 50"H (lbs)

Accessories



TB59 \$386

Fabric tackboard, (COM, Grade A, Grade B) 3/4" x 59" x 15 1/2"H (14 lbs)

TB47 \$338

Fabric tackboard, (COM, Grade A, Grade B) 3/4" x 47" x 15 1/2"H (16 lbs)

TB41 \$272

Fabric tackboard, (COM, Grade A, Grade B) 3/4" x 41" x 15 1/2"H (11 lbs)

TB36 \$233

Fabric tackboard, (COM, Grade A, Grade B) 3/4" x 36" x 15 1/2"H (10 lbs)



TL48 \$215

Task light (UL approved), 6" x 48" x 1 1/2"H (15 lbs)

TL24 \$185

Task light (UL approved), 6" x 24" x 1 1/2"H (10 lbs)

GEORGIAN SERIES

List Price

Bookcases

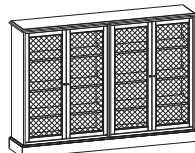
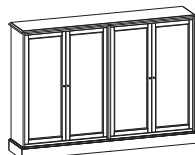
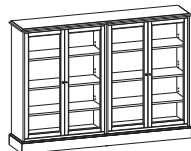
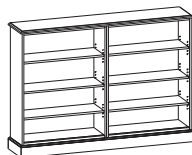
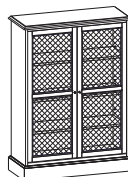
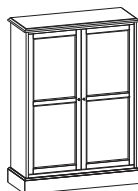
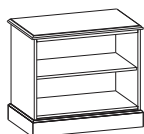
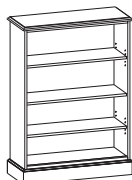
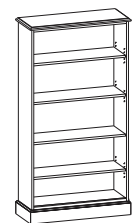

55BCO-84_ _ **\$2796**
 Open bookcase with four adjustable and two fixed shelves (bottom & middle)
 15 1/2" x 38" x 84"H (225 lbs) ****unit must be permanently attached to wall**

55BCO-72_ _ **\$2736**
 Open bookcase with three adjustable and two fixed shelves (bottom & middle)
 15 1/2" x 38" x 72"H (196 lbs)

55BCO-52_ _ **\$1788**
 Open bookcase with three adjustable and one fixed bottom shelf
 15 1/2" x 38" x 52"H (140 lbs)

55BCO-30_ _ **\$1374**
 Open bookcase with one adjustable and one fixed bottom shelf
 21" x 30 1/2" x 30"H (85 lbs)

55BC-G_ _ **\$2400**
 Bookcase with glass doors (non-locking), three adjustable shelves and one fixed shelf (bottom)
 15 1/2" x 38" x 52"H (150 lbs)

55BC-W_ _ **\$2552**
 Bookcase with wood doors (non-locking), three adjustable shelves and one fixed shelf (bottom)
 15 1/2" x 38" x 52"H (150 lbs)

55BC-M_ _ **\$3049**
 Bookcase with woven wire mesh grille doors (non-locking), three adjustable shelves and
 one fixed shelf (bottom)
 15 1/2" x 38" x 52"H (150 lbs)

55BC2-O_ _ **\$3503**
 Double unit open bookcase with three adjustable shelves and one fixed shelf (bottom) in each section
 15 1/2" x 60" x 52"H (230 lbs)

55BC2-G_ _ **\$4321**
 Double unit bookcase with glass doors, three adjustable shelves and one fixed shelf (bottom) in each section
 15 1/2" x 60" x 52"H (250 lbs)

55BC2-W_ _ **\$4600**
 Double unit bookcase with wood doors, three adjustable shelves and one fixed shelf (bottom) in each section
 15 1/2" x 60" x 52"H (250 lbs)

55BC2-M_ _ **\$4950**
 Double unit bookcase with woven wire mesh grille doors, three adjustable shelves and
 one fixed shelf (bottom) in each section
 15 1/2" x 60" x 52"H (250 lbs)

GEORGIAN SERIES

List Price

Hutches



| | | |
|-------------|--|--------|
| 55OSU1-32-O | Open (shown) | \$1575 |
| 55OSU1-32-G | Glass doors (non-locking) | \$2149 |
| 55OSU1-32-W | Wood doors (non-locking) | \$2285 |
| 55OSU1-32-M | Woven wire mesh grille doors (non-locking) | \$2512 |

Single unit hutch with three adjustable shelves per section, cornice top
 **properly fits on 32" wide lower unit
 15 1/2" x 31 1/2" x 50"H (110 lbs)
 Optional locking doors (LK) - add \$55 list per set of doors

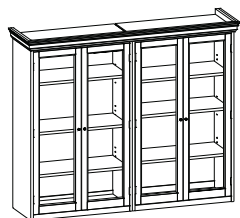

| | | |
|-------------|--|--------|
| 55OSU2-60-O | Open | \$3245 |
| 55OSU2-60-G | Glass doors (non-locking) (shown) | \$4119 |
| 55OSU2-60-W | Wood doors (non-locking) | \$4391 |
| 55OSU2-60-M | Woven wire mesh grille doors (non-locking) | \$4845 |

Double unit hutch with three adjustable shelves per section, cornice top
 **properly fits on 60" wide lower unit
 **ships in three (3) pieces
 15 1/2" x 59 1/2" x 50"H (220 lbs)
 Optional locking doors (LK) - add \$55 list per set of doors

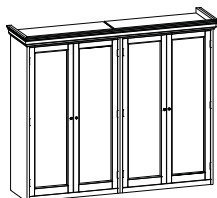

| | | |
|-------------|--|--------|
| 55OSU2-66-O | Open | \$3609 |
| 55OSU2-66-G | Glass doors (non-locking) | \$4483 |
| 55OSU2-66-W | Wood doors (non-locking) (shown) | \$4755 |
| 55OSU2-66-M | Woven wire mesh grille doors (non-locking) | \$5178 |

Double unit hutch with three adjustable shelves per section, cornice top
 **properly fits on 66" wide lower unit
 **ships in three (3) pieces
 15 1/2" x 65 1/2" x 50"H (250 lbs)
 Optional locking doors (LK) - add \$55 list per set of doors

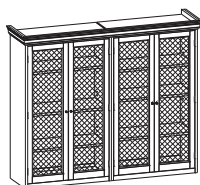

| | | |
|-------------|--|--------|
| 55OSU2-72-O | Open | \$3973 |
| 55OSU2-72-G | Glass doors (non-locking) | \$4847 |
| 55OSU2-72-W | Wood doors (non-locking) | \$5119 |
| 55OSU2-72-M | Woven wire mesh grille doors (non-locking) (shown) | \$5542 |

Double unit hutch with three adjustable shelves per section, cornice top
 **properly fits on 72" wide lower unit
 **ships in three (3) pieces
 15 1/2" x 71 1/2" x 50"H (275 lbs)
 Optional locking doors (LK) - add \$55 list per set of doors

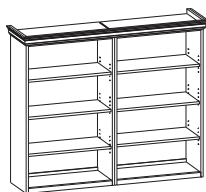

| | | |
|-------------|--|--------|
| 55OSU2-84-O | Open (shown) | \$4337 |
| 55OSU2-84-G | Glass doors (non-locking) | \$5211 |
| 55OSU2-84-W | Wood doors (non-locking) | \$5483 |
| 55OSU2-84-M | Woven wire mesh grille doors (non-locking) | \$5906 |

Double unit hutch with three adjustable shelves per section, cornice top
 **properly fits on 84" wide lower unit
 **ships in three (3) pieces
 15 1/2" x 83 1/2" x 50"H (300 lbs)
 Optional locking doors (LK) - add \$55 list per set of doors

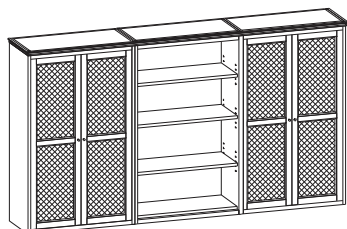

| | | |
|---------------|--|--------|
| 55OSU3-90-O | Open | \$4771 |
| 55OSU3-90-G | Glass doors (non-locking) | \$6446 |
| 55OSU3-90-GOG | Glass doors/Open/Glass doors (non-locking) | \$5872 |
| 55OSU3-90-W | Wood doors (non-locking) | \$6861 |
| 55OSU3-90-WOW | Wood/Open/Wood doors (non-locking) | \$6145 |
| 55OSU3-90-M | Woven wire mesh grille doors (non-locking) | \$7168 |
| 55OSU3-90-MOM | Wire mesh/Open/Wire mesh (non-locking) (shown) | \$6598 |

Single unit hutch with three adjustable shelves per section, cornice top
 **properly fits on 90" wide lower unit
 **ships in four (4) pieces
 15 1/2" x 89 1/2" x 50"H (350 lbs)
 Optional locking doors (LK) - add \$55 list per set of doors

GEORGIAN SERIES

List Price

Transaction Counter - Desk



| | |
|----------|--------|
| 55TC72__ | \$1123 |
| 55TC66__ | \$1066 |
| 55TC60__ | \$1043 |

Transaction Counter - Return



| | |
|-------------------|--------|
| 55TCL88__ (shown) | \$1123 |
| 55TCR88__ | |
| 55TCL82__ (shown) | \$1100 |
| 55TCR82__ | |
| 55TCL76__ (shown) | \$1077 |
| 55TCR76__ | |
| 55TCL70__ (shown) | \$1054 |
| 55TCR70__ | |
| 55TCL64__ (shown) | \$1036 |
| 55TCR64__ | |
| 55TCL58__ (shown) | \$1013 |
| 55TCR58__ | |

Accessories

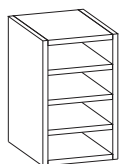

| | |
|--|-------|
| 55PSA Portable work organizer, with three paper trays 15" x 12" x 17"H (20 lbs) | \$600 |
|--|-------|



| | |
|---|-------|
| 55WB Wastebasket, wooden 12" x 12" x 16"H (14 lbs) | \$538 |
|---|-------|



| | |
|--|-------|
| 55C Costumer, turned post, solid wood 66"H (15 lbs) | \$544 |
|--|-------|

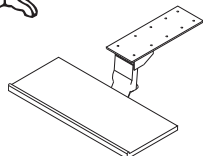

| | |
|---|-------|
| AKPW Articulating keyboard - leverless, with non- handed mouse pad, 5" height adjustment, 25 degree tilt - 360 degree swivel, wooden keyboard tray - specify finish 11 1/4" x 21 1/2" x 2 3/4"H (25 lbs) | \$472 |
|---|-------|

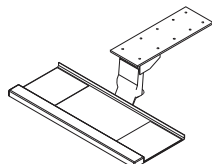

| | |
|---|-------|
| AKP Articulating keyboard - leverless, with non- handed mouse pad, 5" height adjustment, 25 degree tilt - 360 degree swivel, black molded keyboard tray 11" x 25" x 2 3/4"H (21 lbs) | \$337 |
|---|-------|

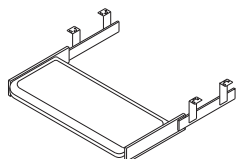

| | |
|---|-------|
| KD Pull-out keyboard - leverless, black molded keyboard tray 10 5/8" x 21 1/2" x 3 5/8"H (8 lbs) | \$153 |
|---|-------|



| | |
|--|------|
| LH Wire mgmt channel, 22" length - set of four, double sided velcro attachment | \$83 |
|--|------|

HERITAGE II SERIES



Classic traditional styling to fit any office environment. The Heritage Series features a wide range of components with or without decorative panel moulding. Catalyzed varnish finish, mortise and tenon - groove and tenon construction. Full extension drawers with dovetail construction and antique brass pulls are standard. All items are available in a choice of 11 cherry and walnut finishes.

HERITAGE II SERIES

Finishes Available

Walnut

Empire Walnut



Richleigh Walnut



Royal Walnut



Espresso



Old World Mahogany



Crescent Cherry on Walnut



Cherry

Collector's Cherry



Amber Cherry



Cinnamon Cherry



Mocha Cherry



Mahogany on Cherry



**The finishes shown on this page have been reproduced as accurately as possible, however, due to the printing process some finishes may vary slightly from the actual finish samples originally photographed. In addition, due to the nature of wood, it is possible that some slight variations in color and grain character may occur naturally (which is the beauty of a natural product). Wood finish chips are available for each of the above finishes if requested (please call customer service).

HERITAGE II SERIES



Options Available

| | | |
|------|---|--------------------------|
| HPL | Matching high pressure laminate substituted for wood top - Contact customer service for matching finish selections | \$ N/C |
| BW | Burl walnut top | \$ 2102 |
| MBC | Madrone burl top (cherry species only) | \$ 2074 |
| LTH | Leather inlay (desk tops only) – black, burgundy, forest green | \$ 2230 |
| PM | Optional panel moulding added | \$ 86 |
| CD | Center drawer (non-locking) | \$ 374 |
| CDCL | Center drawer and central locking for desk | \$ 413 |
| WSL | Arm slide (left) added to standard box/file pedestal - desk only | \$ 94 |
| WSR | Arm slide (right) added to standard box/file pedestal - desk only | \$ 94 |
| FF | Change BF pedestal to FF | \$ 83 |
| BB | Brushed brass pulls (replaces standard antique brass pulls) | \$ 22 per pull |
| CPU | Change BF or FF pedestal to CPU pedestal - inside dimensions: 14 3/16"W x 17 13/16"D x 22 3/8"H - hinged door (non-locking), two ventilation slots in back panel and inside end panel grommet | \$ 110 |
| PNT | Change lateral file or file center pedestal to printer pedestal - inside dimensions: 27 1/2"Wx17 13/16"Dx22 3/8"H - slide out printer shelf, wall access cut-out in back modesty and inside end panel grommet | \$ 110 |
| BBF | Change BF or FF pedestal to BBF | \$ 110 |
| LK | Locking of individual doors, drawers or pedestals (where not standard) | \$ 55 |
| GR | Wire mgmt grommet (note location) | \$ 61 |
| WA | Wall access cut-out (modesty panels on bridges, credenzas, desks and returns) | \$ N/C |
| FS | Freestanding unit - change from connecting unit (notched) to freestanding unit | \$ 88 |
| AHM | Electronic height adjustable mechanism added to worksurface, lifting column, control box, control pendant, with memory settings, motor cable, main power cable, anti-collision dongle. Lower metal lifts and anti-tip brackets. Adjusts from 30" - 44"H | Contact Customer Service |

HERITAGE II SERIES

Warranty and Certification

All products listed are warranted against defects of material and workmanship under normal use and service for a minimum of 10 years from the date of installation (see full warranty information). All products listed are Level 2 BIFMA certified.

Veneer

Veneer on all exposed surfaces is #1 plain sliced American Black Walnut or Cherry. Outside surface veneers are book matched to provide proper grain consistency and uniform grain appearance. Drawer fronts are vertical grain walnut, cherry or oak veneers and matched in selected sets to ensure proper veneer balance and uniform grain appearance.

Wood Veneer Tops

1 3/16" thick tops utilizing 3-ply construction, shaped with a traditional style edge detail. Top cores are high density MDF fiberboard. Walnut or cherry veneer tops are standard. High pressure laminate tops are optional, with many standard finishes having matching laminate tops available (call customer service for options).

Modesty Panels and End Panels

Panels are 3/4" thick, 3-ply construction with book matched veneers to provide proper grain consistency and uniform grain appearance. All veneers are vertical grain walnut, cherry or oak veneers matched to ensure proper veneer balance. Decorative panel moulding is crafted from solid walnut, cherry or oak with mitered corners and hand fitted to each panel. Units may be specified with or without decorative panel moulding. Full modesty panels are standard for desk, bridge, and kneespace credenzas with optional half modesty options available.

Drawers

Drawer sides and backs are solid plywood 7/16" thick. Drawer fronts are 3-ply hardwood construction, 3/4" thick with book matched veneers to provide proper grain consistency and uniform grain appearance. All drawers utilize five sided drawer construction. Drawers are assembled with dovetail construction in all four corners. Drawer bottoms are 7/32" 3-ply hardwood dado construction.

Doors

Doors are 3/4" thick 3-ply construction with vertical grain walnut, cherry or oak veneers and matched in selected sets to ensure proper veneer balance and uniform grain appearance. European style hidden hinges are used on doors where applicable. Tempered glass conforming to ASTM C 1048 is used in all glass doors.

Shelves

Shelves are 3-ply construction with a 1/4" walnut, cherry or oak rim on the front edge. All shelves are full depth of the interior compartment unless specified otherwise. Faces are book matched walnut, cherry or oak veneer. Hutch shelves are walnut, cherry or oak faced on both sides. A minimum of one adjustable or fixed shelf is provided with each cabinet storage unit (see individual unit for details). Adjustable shelves are provided with metal adjustable shelf hardware supports.

Bases

Bases are solid hardwood mitered at all four corners. Height adjustable leveling glides are mounted in each corner with a threaded metal insert capped with a nylon glide that is height adjustable to approx. 1 1/2" to ensure proper leveling of the unit to varying floor conditions.

Hardware

Drawer Suspensions – File, box, pencil and center drawers utilize steel "A" grade heavy duty metal slides for smooth operation. All pedestal drawers have 100 % full extension slides. All suspension systems feature positive and cushioned in/out stops. All box, center, and tray drawers are removable without tools and the suspensions are designed to prevent accidental removal.

Locks – All desks, returns and credenzas utilize pedestal locking. Lateral files are keyed as standard and feature central locking with anti-tip drawer interlock systems. Individual pieces are shipped random keyed. Units may be keyed alike upon special request. A minimum of fifty key changes (numbers) are available. Core lock changes are available (contact customer service).

Drawer Pulls – Traditional style, bail type drawer pulls in antique brass finish are standard.

Hinges – European style hidden hinges are used on doors where applicable.

Wire Management – Black wire management grommets are standard on all returns and bridge work surfaces located in back center of the tops. Black wire management access grommets are standard on all credenzas, hutches, overhead storage units and computer tables located in back panel. Optional additional black wire management grommets, wall access cut-outs, wiring harness and wiring channels along with integrated cable management to conceal power and data cords are also available. Optional data ports accessible at work surface height (see accessories).

Chassis Construction

Construction technique is mortise and tenon, groove and tenon, heavily glue blocked with hardwood cleats for maximum strength.

Filing

File drawers use an easily adjustable filing rail system which can be positioned to accommodate front to back or side to side letter or legal filing.

Finish

All exposed surfaces are finished with a UV inhibitor catalyzed varnish finish to ensure maximum durability, chemical resistance, color retention and clarity. All exterior surfaces are finished in the following multi-step sequence: sap stain, NGR stain, wash coat, wash coat sand, filler spray, filler wipe, sealer spray, sealer sand, varnish spray, varnish sand, varnish spray. Moisture content for all wooden parts is between 5 - 9% prior to sealing. Drawer interiors and exteriors are UV prefinished with sealer, sealer sand, and varnished. Custom finish matches are available, contact customer service for request.

HERITAGE II SERIES

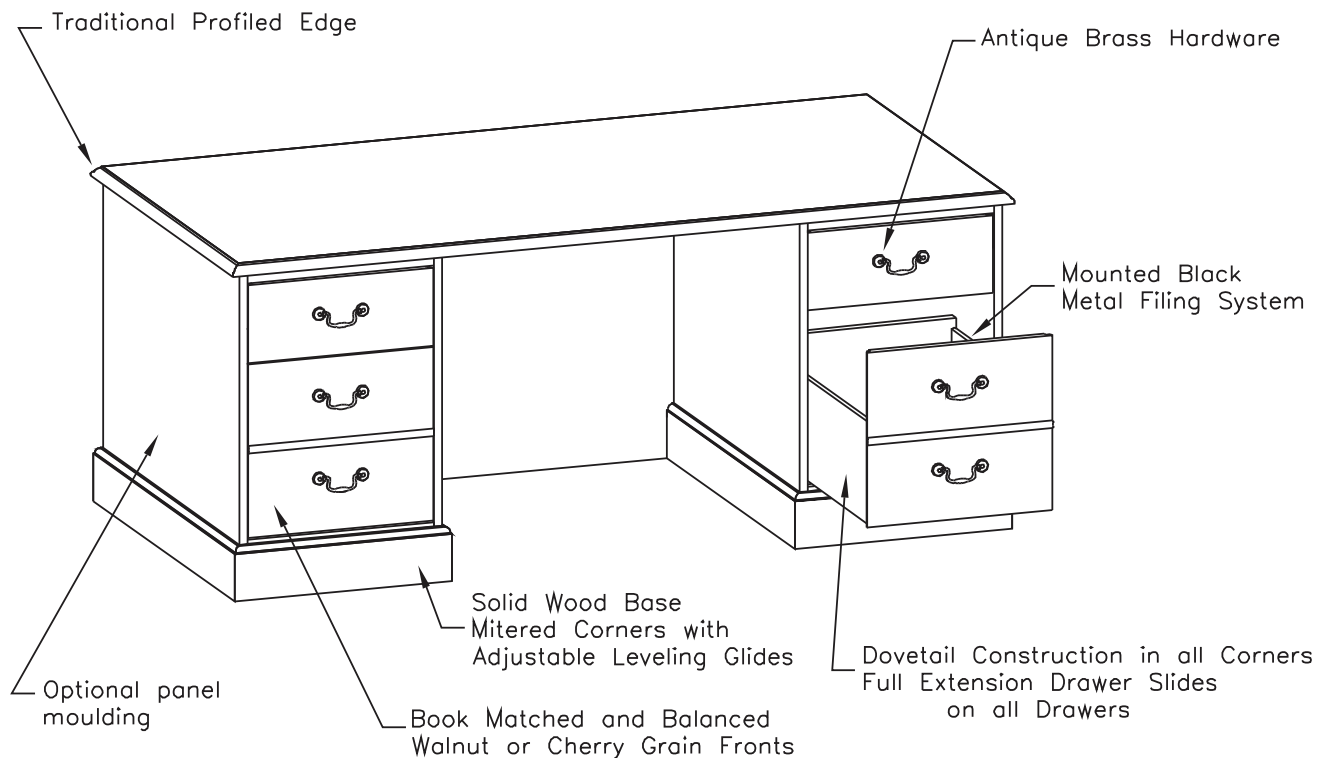

Available in Walnut or Cherry
All units have 1/8" thick hardboard security/dust bottoms
All surfaces are Catalyzed Varnish finish

Ordering Information

Use the following steps to correctly place your order:

1) Determine the correct model number for the item you are selecting - example:

50FC84 = Double pedestal desk, 42" x 84" x 30"H

2) Determine the proper finish selection for the item - example:

50FC84-OW = Double pedestal desk, 42" x 84" x 30"H, in Old World Mahogany

3) Determine any additional options you may wish for the item - example:

50FC84-PM-OW = Double pedestal desk, 42" x 84" x 30"H, in Old World Mahogany with optional panel moulding

HERITAGE II SERIES

List Price

Double Pedestal Desks

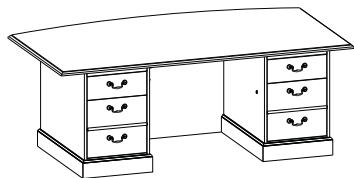

50FK84 \$4488
 Double pedestal desk with arc conference top, two box/file pedestals (locking),
 6" approach and side overhang, tray/organizer in box drawer
 32" W Kneespace
 42" x 84" x 30"H (435 lbs)
50CD32 Optional non-locking center drawer \$374

50FK72 \$4050
 Double pedestal desk with arc conference top, two box/file pedestals (locking),
 6" approach overhang, tray/organizer in box drawer
 32" W Kneespace
 42" x 72" x 30"H (345 lbs)
50CD32 Optional non-locking center drawer \$374

50FK7236 \$3703
 Double pedestal desk with arc conference top, two box/file pedestals (locking),
 6" approach overhang, tray/organizer in box drawer
 32" W Kneespace
 36" x 72" x 30"H (325 lbs)
50CD32 Optional non-locking center drawer \$374

50FC84 \$4319
 Double pedestal desk with conference top, two box/file pedestals (locking),
 6" approach and side overhang, tray/organizer in box drawer
 32" W Kneespace
 42" x 84" x 30"H (390 lbs)
50CD32 Optional non-locking center drawer \$374

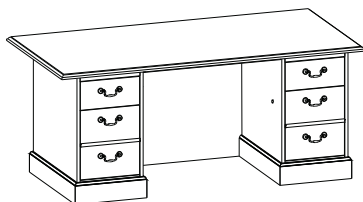

50FC72 \$3812
 Double pedestal desk with conference top, two box/file pedestals (locking),
 6" approach and side overhang, tray/organizer in box drawer
 32" W Kneespace
 36" x 72" x 30"H (345 lbs)
50CD32 Optional non-locking center drawer \$374



50FC6636 \$3734
 Double pedestal desk with conference top, two box/file pedestals (locking),
 6" approach overhang, tray/organizer in box drawer
 32" W Kneespace
 36" x 66" x 30"H (335 lbs)
50CD24 Optional non-locking center drawer \$374

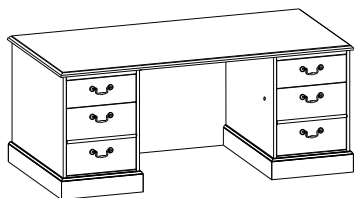

50F72 \$3882
 Double pedestal desk with fitted top, two box/file pedestals (locking),
 32" W Kneespace, tray/organizer in box drawer
 36" x 72" x 30"H (380 lbs)
50CD32 Optional non-locking center drawer \$374

50F6636 \$3703
 Double pedestal desk with fitted top, two box/file pedestals (locking),
 32" W Kneespace, tray/organizer in box drawer
 36" x 66" x 30"H (335 lbs)
50CD32 Optional non-locking center drawer \$374

HERITAGE II SERIES

List Price

Double Pedestal Desks

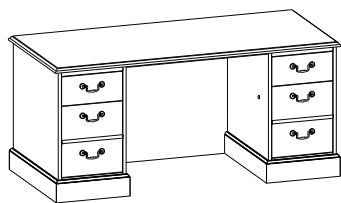

50F66 \$3640
 Double pedestal desk with fitted top, two box/file pedestals (locking),
 32" W Kneespace, tray/organizer in box drawer
 30" x 66" x 30"H (325 lbs)



50CD24 Optional non-locking center drawer \$374

50F60 \$3344
 Double pedestal desk with fitted top, two box/file pedestals (locking),
 26 1/2" W Kneespace, tray/organizer in box drawer
 30" x 60" x 30"H (300 lbs)

50CD24 Optional non-locking center drawer \$374

Table Desks

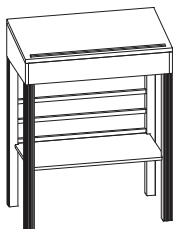

50SUD36 \$2278
 Stand-up desk, hinged top with storage, pencil tray, bottom shelf,
 solid wood reeded legs
 20" x 36" x 47"H - back / 42"H front (150 lbs)

50UT7236 \$2346
 Table desk with two drawers (non-locking), solid wood reeded legs
 Chair arm clearance 25"H
 36" x 72" x 30"H (140 lbs)

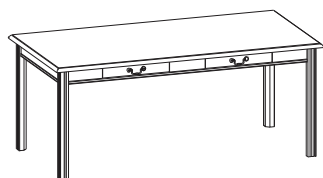

50UT7230 \$2199
 Table desk with two drawers (non-locking), solid wood reeded legs
 Chair arm clearance 25"H
 30" x 72" x 30"H (130 lbs)

50UT6030 \$2049
 Table desk with two drawers (non-locking), solid wood reeded legs
 Chair arm clearance 25"H
 30" x 60" x 30"H (100 lbs)

50UT4830 \$1966
 Table desk with one drawer (non-locking), solid wood reeded legs
 Chair arm clearance 25"H
 30" x 48" x 30"H (85 lbs)

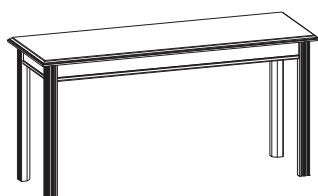

50UT6621 \$1654
 Table desk w/o drawers, solid wood reeded legs

50UT6621WD \$2028
 Table desk with two non-locking drawers, solid wood reeded legs
 Chair arm clearance 25"H
 21" x 66" x 30"H (100 lbs)

50UT4821 \$1430
 Table desk w/o drawers, solid wood reeded legs

50UT4821WD \$1705
 Table desk with one non-locking drawer, solid wood reeded legs
 Chair arm clearance 25"H
 21" x 48" x 30"H (70 lbs)

HERITAGE II SERIES

List Price

Credenzas

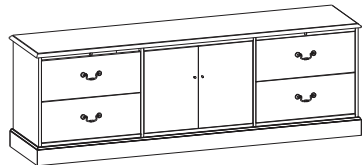

50DC90-4 \$4566
 Credenza with hinged door storage, two lateral file pedestals (locking), hinged door storage area (non-locking) with one adjustable shelf, wire mgmt grommet in back panel 21" x 90" x 30"H (380 lbs)
 Optional locking doors (LK) - add \$55 list
50DC90-4-24 - 24" x 90" x 30"H \$5028

50DC84-4 \$4290
 Credenza with hinged door storage, two lateral file pedestals (locking), hinged door storage area (non-locking) with one adjustable shelf, wire mgmt grommet in back panel 21" x 84" x 30"H (365 lbs)
 Optional locking doors (LK) - add \$55 list
50DC84-4-24 - 24" x 84" x 30"H \$4719

50DC72-4 \$3918
 Credenza with hinged door storage, two box/file pedestals (locking), hinged door storage area (non-locking) with one adjustable shelf, wire mgmt grommet in back panel 21" x 72" x 30"H (350 lbs)
 Optional locking doors (LK) - add \$55 list
50DC72-4-24 - 24" x 72" x 30"H \$4314

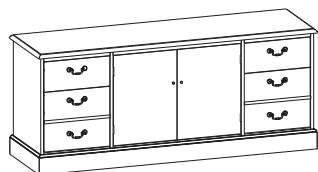

50DC66-4 \$3591
 Credenza with hinged door storage, two box/file pedestals (locking), hinged door storage area (non-locking) with one adjustable shelf, wire mgmt grommet in back panel 21" x 66" x 30"H (330 lbs)
 Optional locking doors (LK) - add \$55 list
50DC66-4-24 - 24" x 66" x 30"H \$3954

50DC60-4 \$3287
 Credenza with hinged door storage, two box/file pedestals (locking), hinged door storage area (non-locking) with one adjustable shelf, wire mgmt grommet in back panel 21" x 60" x 30"H (330 lbs)
 Optional locking doors (LK) - add \$55 list
50DC60-4-24 - 24" x 60" x 30"H \$3617

50DC90-3 \$3994
 Credenza with kneespace, two lateral file pedestals (locking), wire mgmt grommet in back panel
 30 1/2" W kneespace
 21" x 90" x 30"H (325 lbs)
50DC90-3-24 - 24" x 90" x 30"H \$4456

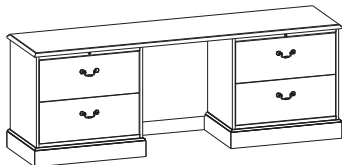

50DC84-3 \$3704
 Credenza with kneespace, two lateral file pedestals (locking), wire mgmt grommet in back panel
 24 1/2" W kneespace
 21" x 84" x 30"H (310 lbs)
50DC84-3-24 - 24" x 84" x 30"H \$4133

50DC72-3 \$3229
 Credenza with kneespace, two box/file pedestals (locking), wire mgmt grommet in back panel
 32" W kneespace
 21" x 72" x 30"H (260 lbs)
50DC72-3-24 - 24" x 72" x 30"H \$3625

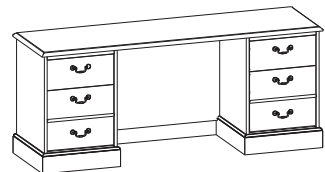

50DC66-3 \$2915
 Credenza with kneespace, two box/file pedestals (locking), wire mgmt grommet in back panel
 32" W kneespace
 21" x 66" x 30"H (240 lbs)
50DC66-3-24 - 24" x 66" x 30"H \$3278

50DC60-3 \$2663
 Credenza with kneespace, two box/file pedestals (locking), wire mgmt grommet in back panel.
 26" W kneespace
 21" x 60" x 30"H (210 lbs)
50DC60-3-24 - 24" x 60" x 30"H \$2993

HERITAGE II SERIES

List Price

Credenzas

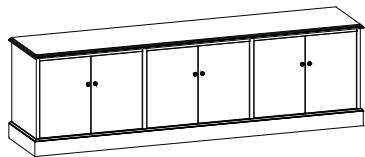

50SC-90 \$4909

Six door hinged door cabinet (non-locking), one adjustable shelf per section
21" x 90" x 30"H (380 lbs)

Optional locking doors (LK3) - add \$165 list

50SC-90-24 - 24" x 90" x 30"H \$5371

50SC-84 \$4483

Six door hinged door cabinet (non-locking), one adjustable shelf per section
21" x 84" x 30"H (365 lbs)

Optional locking doors (LK3) - add \$165 list

50SC-84-24 - 24" x 84" x 30"H \$4912

50SC-72 \$3131

Four door hinged door cabinet (non-locking), one adjustable shelf per section
21" x 72" x 30"H (300 lbs)

Optional locking doors (LK2) - add \$110 list

50SC-72-24 - 24" x 72" x 30"H \$3527

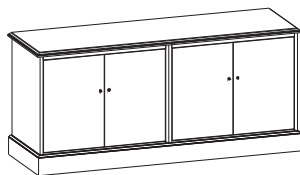

50SC-66 \$2736

Four door hinged door cabinet (non-locking), one adjustable shelf per section
21" x 66" x 30"H (260 lbs)

Optional locking doors (LK2) - add \$110 list

50SC-66-24 - 24" x 66" x 30"H \$3099

50SC-60 \$2538

Four door hinged door cabinet (non-locking), one adjustable shelf per section
21" x 60" x 30"H (200 lbs)

Optional locking doors (LK2) - add \$110 list

50SC-60-24 - 24" x 60" x 30"H \$2868

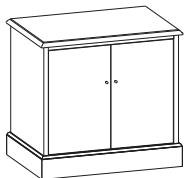

50SC-31 \$1519

Two door hinged door cabinet (non-locking), one adjustable shelf
21" x 31" x 30"H (125 lbs)

Optional locking doors (LK) - add \$55 list

50SC-31-24 - 24" x 31" x 30"H \$1746

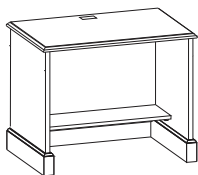

50CRT36 \$1315

Computer table, 10" deep storage shelf, one wire mgmt grommet in top and back panel
24" x 36" x 30"H (100 lbs)

Optional with casters (-C) - add \$139 list

Optional with one additional adjustable 10" deep storage shelf (-ASF) - add \$165 list



50CRT48 \$1560

Computer table, 10" deep storage shelf, one wire mgmt grommet in top and back panel
24" x 48" x 30"H (135 lbs)

Optional with casters (-C) - add \$139 list

Optional with one additional adjustable 10" deep storage shelf (-ASF) - add \$193 list

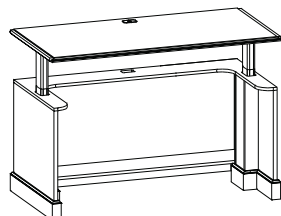

50CRT60AH \$7426

Height adjustable computer table, 10" deep storage shelf, one wire mgmt grommet in top and back panel, lifting colum, control box, control pendant with memory settings, motor cable, main power cable, anti-collision dongle, lower metal lift brackets and upper metal frame
30" x 60" x 30-44"H (265 lbs)

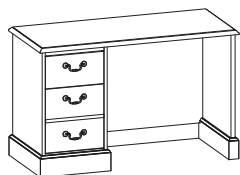

50DCSPR48FS (right hand) \$2004

50DCSPL48FS (left hand - shown) \$2004

Single pedestal credenza, box/file pedestal (locking), wire mgmt grommet in back panel
30" W kneespace

21" x 48" x 30"H (146 lbs)

Optional CPU Pedestal in place of box/file pedestal (CPU) - add \$110 list

50DCSPR48FS-24 - 24" x 48" x 30"H \$2312

50DCSPL48FS-24 - 24" x 48" x 30"H \$2312

HERITAGE II SERIES

List Price

Storage Units



50LF4V
Four drawer vertical lateral file, legal or letter cross filing, central locking
21" x 34" x 54"H (215 lbs)
50LF4V-24 - 24" x 34" x 54"H



\$3128
\$3521



50LF3
Three drawer lateral file, legal or letter cross filing, central locking
21" x 34" x 42"H (195 lbs)
50LF3-24 - 24" x 34" x 42"H

\$2538
\$2751



50LF2
Two drawer lateral file, legal or letter cross filing, central locking
21" x 34" x 30"H (145 lbs)
50LF2-24 - 24" x 34" x 30"H



\$2007
\$2260

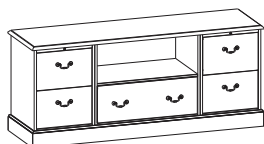

50FC5BC
Open storage/file, left and right file/file pedestal (locking), center - top open storage area, bottom - lateral file (locking), legal or letter filing, wire mgmt grommet in back panel
21" x 72" x 30"H (280 lbs)
50FC5BC-24 - 24" x 72" x 30"H

\$3505
\$3901

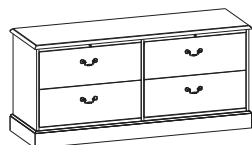

50LF4-72
Double unit lateral file, legal or letter cross filing, central locking
21" x 72" x 30"H (275 lbs)
50LF4-72-24 - 24" x 72" x 30"H

\$3516
\$3912

50LF4-66
Double unit lateral file, legal or letter cross filing, central locking
21" x 66" x 30"H (255 lbs)
50LF4-66-24 - 24" x 66" x 30"H

\$3272
\$3635

50LF4-60
Double unit lateral file, legal or letter cross filing, central locking
21" x 60" x 30"H (235 lbs)
50LF4-60-24 - 24" x 60" x 30"H

\$3100
\$3430

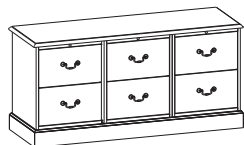

50FC6
Six drawer file (2x3) (locking), legal or letter filing
21" x 57 1/2" x 30"H (260 lbs)
50FC6-24 - 24" x 57 1/2" x 30"H

\$3994
\$4478



50FC4
Four drawer file (2x2) (locking), legal or letter filing
21" x 39" x 30"H (175 lbs)
50FC4-24 - 24" x 39" x 30"H

\$2767
\$3130



50FC4V
Four drawer vertical file (4x1) (locking), legal or letter filing
21" x 20 1/4" x 54"H (200 lbs)
50FC4V-24 - 24" x 20 1/4" x 54"H

\$2725
\$3080



50FC2
Two drawer file (2x1), legal or letter cross filing, central locking
21" x 20 1/4" x 30"H (90 lbs)
50FC2-24 - 24" x 20 1/4" x 30"H

\$1737
\$1968

HERITAGE II SERIES

List Price

Storage Units

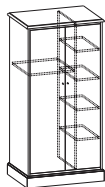

50WC69 **\$4607**
 Wardrobe, left side clothing carrier, right side four adjustable shelves, non-locking
 24" x 34" x 69"H (330 lbs)
 Optional locking doors (LK) - add \$55 list
 Optional full wardrobe - full coat rod (FULL) - NC
50WC80 - 24" x 34" x 80"H with cornice top **\$5542**



50WC6918R - hinged right **\$3542**
50WC6918L - hinged left (shown)
 Single unit wardrobe, top shelf, coat rod, non-locking, left or right hinged door
 24" x 18" x 69"H (150 lbs)
 Optional locking door (LK) - add \$55 list
50WC8018R - 24" x 18" x 80"H with cornice top **\$4312**
50WC8018L - 24" x 18" x 80"H with cornice top **\$4312**

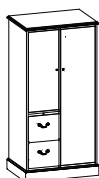

50WSFFL - left hand wardrobe **\$4920**
50WSFFR - right hand wardrobe (shown)
 Utility cabinet, wardrobe unit with hinged door (non-locking), top shelf, coat rod, file/file pedestal - bottom (locking), hinged door storage area (non-locking) with two adjustable shelves - top (right hand shown)
 24" x 34" x 69"H (360 lbs)
 Optional locking doors (LK2) - add \$110 list
50WSFFL-80 - 24" x 34" x 80"H with cornice top **\$5855**
50WSFFR-80 - 24" x 34" x 80"H with cornice top **\$5855**

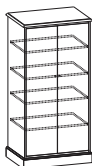

50SC69 **\$4379**
 Storage cabinet, hinged doors (non-locking), four adjustable shelves
 24" x 34" x 69"H (285 lbs)
 Optional locking doors (LK) - add \$55 list
50SC80 - 24" x 34" x 80"H with cornice top **\$5314**



50SC6918R - hinged right **\$3734**
50SC6918L - hinged left (shown)
 Storage cabinet, non-locking left or right hinged door, four adjustable shelves
 24" x 18" x 69"H (150 lbs)
 Optional locking door (LK) - add \$55 list
50SC8018R - 24" x 18" x 80"H with cornice top **\$4504**
50SC8018L - 24" x 18" x 80"H with cornice top **\$4504**



50LF/BCW **\$4939**
 Storage cabinet / Lateral file, upper hinged door storage (non-locking) with two adjustable shelves, bottom - two lateral file drawers (locking), legal or letter filing
 24" x 34" x 69"H (330 lbs)
 Optional locking doors (LK) - add \$55 list
50LF/BCW-80 - 24" x 34" x 80"H with cornice top **\$5874**

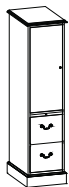

50SCFF6918L - hinged left (shown) **\$4129**
50SCFF6918R - hinged right
 Utility cabinet, file/file pedestal - bottom (locking), hinged door storage area (non-locking) with two adjustable shelves - top (left hand hinged door shown)
 24" x 18" x 69"H (150 lbs)
 Optional locking door (LK) - add \$55 list
50SCFF8018L - 24" x 18" x 80"H with cornice top **\$4899**
50SCFF8018R - 24" x 18" x 80"H with cornice top **\$4899**



50LF4VHD **\$4067**
 Four drawer lateral file with hinged door, hinged door storage (non-locking) - top, four drawer lateral file - bottom, legal or letter cross filing, central locking
 24" x 34" x 69"H (235 lbs)
 Optional locking doors (LK) - add \$55 list



50PCDH **\$1318**
 Telephone cabinet, box drawer, hinged door storage (non-locking), one adjustable shelf
 17" x 22" x 30"H (85 lbs)

HERITAGE II SERIES

List Price

Computer Desk Workstations - Single Pedestal Desks

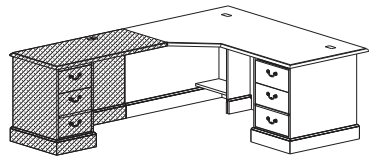

50ECWS8446R \$3578
 Executive single pedestal computer desk (RH) with conference top, box/file pedestal (locking), 46" corner unit, 4" approach overhang, two wire mgmt grommets in top, tray/organizer in box drawer
 34"- 46" x 84" x 30"H (385 lbs)

50ECWS7246R \$3135
 Executive single pedestal computer desk (RH) with conference top, box/file pedestal (locking), 46" corner unit, 4" approach overhang, two wire mgmt grommets in top, tray/organizer in box drawer
 34"- 46" x 72" x 30"H (360 lbs)

50ECWS6640R \$2725
 Executive single pedestal computer desk (RH) with conference top, box/file pedestal (locking), 40" corner unit, 4" approach overhang, two wire mgmt grommets in top, tray/organizer in box drawer
 28"- 40" x 66" x 30"H (280 lbs)

50ECWS8442R \$3287
 Executive single pedestal computer desk (RH) with fitted top, box/file pedestal (locking), 42" corner unit, two wire mgmt grommets in top, tray/organizer in box drawer
 30"- 42" x 84" x 30"H (375 lbs)

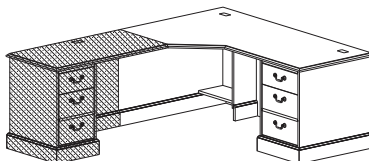

50ECWS7242R \$2992
 Executive single pedestal computer desk (RH) with fitted top, box/file pedestal (locking), 42" corner unit, two wire mgmt grommets in top, tray/organizer in box drawer
 30"- 42" x 72" x 30"H (340 lbs)

50ECWS7236R \$2954
 Executive single pedestal computer desk (RH) with fitted top, box/file pedestal (locking), 36" corner unit, two wire mgmt grommets in top, tray/organizer in box drawer
 24"- 36" x 72" x 30"H (283 lbs)

50ECWS6636R \$2713
 Executive single pedestal computer desk (RH) with fitted top, box/file pedestal (locking), 36" corner unit, two wire mgmt grommets in top, tray/organizer in box drawer
 24"- 36" x 66" x 30"H (260 lbs)

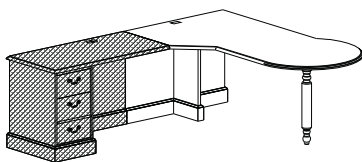

50ECWSP76R \$2941
 P-Top computer desk (RH), 36" diameter end, with sculptured wood pedestal leg, 42" corner unit, one wire mgmt grommet in top (left)
 30"-42" x 76" x 30"H (330 lbs)

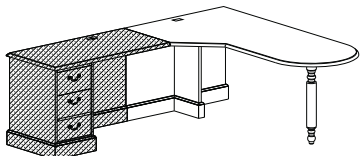

50ECWSB76R \$2609
 Bullet top computer desk (RH), 30" diameter end, with sculptured wood pedestal leg, 42" corner unit, one wire mgmt grommet in top (left)
 30"-42" x 76" x 30"H (330 lbs)

HERITAGE II SERIES

List Price

Computer Desk Workstations - Executive Returns

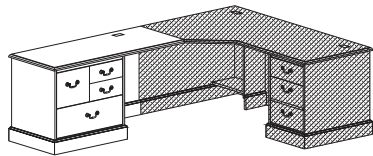

50ERL72FCCU **\$2684**
 Executive height computer return (LH), file center pedestal (locking), two box, one file drawer top, one lateral file drawer bottom, one wire mgmt grommet, 42"W kneespace
 24" x 72" x 30"H (250 lbs)

50ERL60FCCU **\$2534**
 Executive height computer return (LH), file center pedestal (locking), two box, one file drawer top, one lateral file drawer bottom, one wire mgmt grommet, 30"W kneespace
 24" x 60" x 30"H (195 lbs)

50ERL54FCCU **\$2398**
 Executive height computer return (LH), file center pedestal (locking), two box, one file drawer top, one lateral file drawer bottom, one wire mgmt grommet, 24"W kneespace
 24" x 54" x 30"H (180 lbs)

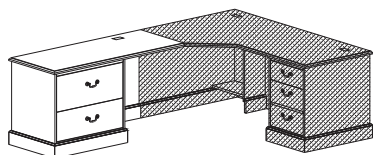

50ERL72LFCU **\$2470**
 Executive height computer return (LH), two lateral file drawers (locking), one wire mgmt grommet, 42"W kneespace
 24" x 72" x 30"H (250 lbs)

50ERL60LFCU **\$2298**
 Executive height computer return (LH), two lateral file drawers (locking), one wire mgmt grommet, 30"W kneespace
 24" x 60" x 30"H (195 lbs)

50ERL54LFCU **\$2164**
 Executive height computer return (LH), two lateral file drawers (locking), one wire mgmt grommet, 24"W kneespace
 24" x 54" x 30"H (180 lbs)

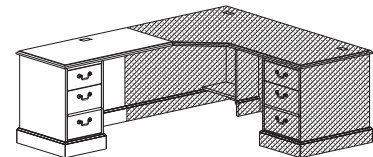

50ERL72CU **\$2060**
 Executive height computer return (LH), box/file pedestal (locking), 1/2 support panel on connection end, one wire mgmt grommet, 54"W kneespace
 24" x 72" x 30"H (225 lbs)

50ERL48CU **\$1605**
 Executive height computer return (LH), box/file pedestal (locking), one wire mgmt grommet, 31"W kneespace
 24" x 48" x 30"H (150 lbs)

50ERL42CU **\$1560**
 Executive height computer return (LH), box/file pedestal (locking), one wire mgmt grommet, 25"W kneespace
 24" x 42" x 30"H (130 lbs)

50ERL36CU **\$1477**
 Executive height computer return (LH), box/file pedestal (locking), one wire mgmt grommet, 19"W kneespace
 24" x 36" x 30"H (120 lbs)

HERITAGE II SERIES

List Price

Computer Desk Workstations - Single Pedestal Desks

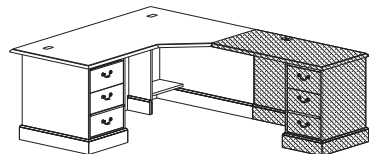

50ECWS8446L \$3578
 Executive single pedestal computer desk (LH) with conference top, box/file pedestal (locking), 46" corner unit, 4" approach overhang, two wire mgmt grommets in top, tray/organizer in box drawer
 34"- 46" x 84" x 30"H (385 lbs)

50ECWS7246L \$3135
 Executive single pedestal computer desk (LH) with conference top, box/file pedestal (locking), 46" corner unit, 4" approach overhang, two wire mgmt grommets in top, tray/organizer in box drawer
 34"- 46" x 72" x 30"H (360 lbs)

50ECWS6640L \$2725
 Executive single pedestal computer desk (LH) with conference top, box/file pedestal (locking), 40" corner unit, 4" approach overhang, two wire mgmt grommets in top, tray/organizer in box drawer
 28"- 40" x 66" x 30"H (280 lbs)

50ECWS8442L \$3287
 Executive single pedestal computer desk (LH) with fitted top, box/file pedestal (locking), 42" corner unit, two wire mgmt grommets in top, tray/organizer in box drawer
 30"- 42" x 84" x 30"H (375 lbs)

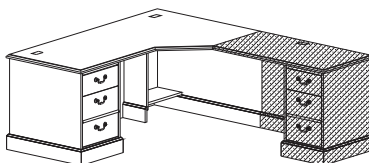

50ECWS7242L \$2992
 Executive single pedestal computer desk (LH) with fitted top, box/file pedestal (locking), 42" corner unit, two wire mgmt grommets in top, tray/organizer in box drawer
 30"- 42" x 72" x 30"H (340 lbs)

50ECWS7236L \$2954
 Executive single pedestal computer desk (LH) with fitted top, box/file pedestal (locking), 36" corner unit, two wire mgmt grommets in top, tray/organizer in box drawer
 24"- 36" x 72" x 30"H (283 lbs)

50ECWS6636L \$2713
 Executive single pedestal computer desk (LH) with fitted top, box/file pedestal (locking), 36" corner unit, two wire mgmt grommets in top, tray/organizer in box drawer
 24"- 36" x 66" x 30"H (260 lbs)

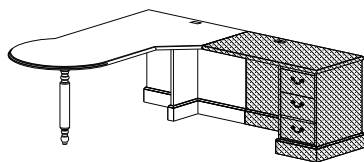

50ECWSP76L \$2941
 P-Top computer desk (LH), 36" diameter end, with sculptured wood pedestal leg, 42" corner unit, one wire mgmt grommet in top (right)
 30"-42" x 76" x 30"H (330 lbs)

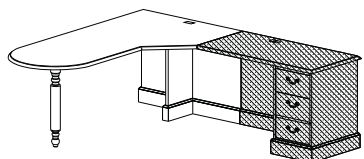

50ECWSB76L \$2609
 Bullet top computer desk (LH), 30" diameter end, with sculptured wood pedestal leg, 42" corner unit, one wire mgmt grommet in top (right)
 30"-42" x 76" x 30"H (330 lbs)

HERITAGE II SERIES

List Price

Computer Desk Workstations - Executive Returns

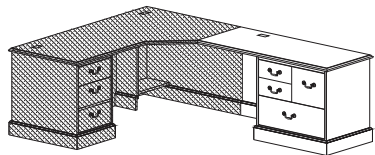

50ERR72FCCU **\$2684**
 Executive height computer return (RH), file center pedestal (locking), two box, one file drawer top, one lateral file drawer bottom, one wire mgmt grommet, 42"W kneespace
 24" x 72" x 30"H (250 lbs)

50ERR60FCCU **\$2534**
 Executive height computer return (RH), file center pedestal (locking), two box, one file drawer top, one lateral file drawer bottom, one wire mgmt grommet, 30"W kneespace
 24" x 60" x 30"H (195 lbs)

50ERR54FCCU **\$2398**
 Executive height computer return (RH), file center pedestal (locking), two box, one file drawer top, one lateral file drawer bottom, one wire mgmt grommet, 24"W kneespace
 24" x 54" x 30"H (180 lbs)

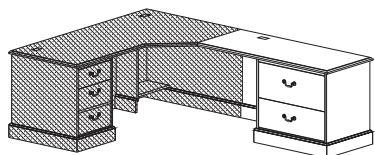

50ERR72LFCU **\$2470**
 Executive height computer return (RH), two lateral file drawers (locking), one wire mgmt grommet, 42"W kneespace
 24" x 72" x 30"H (250 lbs)

50ERR60LFCU **\$2298**
 Executive height computer return (RH), two lateral file drawers (locking), one wire mgmt grommet, 30"W kneespace
 24" x 60" x 30"H (195 lbs)

50ERR54LFCU **\$2164**
 Executive height computer return (RH), two lateral file drawers (locking), one wire mgmt grommet, 24"W kneespace
 24" x 54" x 30"H (180 lbs)

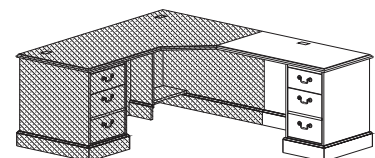

50ERR72CU **\$2060**
 Executive height computer return (RH), box/file pedestal (locking), 1/2 support panel on connection end, one wire mgmt grommet, 54"W kneespace
 24" x 72" x 30"H (225 lbs)

50ERR48CU **\$1605**
 Executive height computer return (RH), box/file pedestal (locking), one wire mgmt grommet, 31"W kneespace
 24" x 48" x 30"H (150 lbs)

50ERR42CU **\$1560**
 Executive height computer return (RH), box/file pedestal (locking), one wire mgmt grommet, 25"W kneespace
 24" x 42" x 30"H (130 lbs)

50ERR36CU **\$1477**
 Executive height computer return (RH), box/file pedestal (locking), one wire mgmt grommet, 19"W kneespace
 24" x 36" x 30"H (120 lbs)

HERITAGE II SERIES

List Price

Executive Workstations - Single Pedestal Desks

| | | |
|--|--|--------|
| | <p>50KSPR84 Executive single pedestal desk (RH) with arc conference top, box/file pedestal (locking), 6" approach overhang, tray/organizer in box drawer 42" x 84" x 30"H (350 lbs)</p> | \$3557 |
| | <p>50KSPR72 Executive single pedestal desk (RH) with arc conference top, box/file pedestal (locking), 6" approach overhang, tray/organizer in box drawer 42" x 72" x 30"H (325 lbs)</p> | \$3200 |
| | <p>50KSPR7236 Executive single pedestal desk (RH) with arc conference top, box/file pedestal (locking), 6" approach overhang, tray/organizer in box drawer 36" x 72" x 30"H (310 lbs)</p> | \$3048 |
| | <p>50SPR84 Executive single pedestal desk (RH) with conference top, box/file pedestal (locking), 6" approach and right side overhang, tray/organizer in box drawer 42" x 84" x 30"H (340 lbs)</p> | \$3235 |
| | <p>50SPR72 Executive single pedestal desk (RH) with conference top, box/file pedestal (locking), 6" approach and right side overhang, tray/organizer in box drawer 36" x 72" x 30"H (310 lbs)</p> | \$2949 |
| | | |
| | <p>50SPR6636 Executive single pedestal desk (RH) with conference top, box/file pedestal (locking), 6" approach overhang only, tray/organizer in box drawer 36" x 66" x 30"H (305 lbs)</p> | \$2720 |
| | <p>50SPR72F Executive single pedestal desk (RH) with fitted top, box/file pedestal (locking), tray/organizer in box drawer 36" x 72" x 30"H (300 lbs)</p> | \$3214 |
| | <p>50SPR7230F Executive single pedestal desk (RH) with fitted top, box/file pedestal (locking), tray/organizer in box drawer 30" x 72" x 30"H (290 lbs)</p> | \$2886 |
| | <p>50SPR66F Executive single pedestal desk (RH) with fitted top, box/file pedestal (locking), tray/organizer in box drawer 30" x 66" x 30"H (275 lbs)</p> | \$2687 |
| | | |
| | <p>50WSP72R P-Top desk (RH), 42" diameter end, with sculptured wood pedestal leg 36"-42" x 72" x 30"H (170 lbs)</p> | \$2460 |
| | <p>50WSB7236R Bullet top desk (RH), 36" diameter end, with sculptured wood pedestal leg, 42" corner unit 36" x 72" x 30"H (170 lbs)</p> | \$2285 |

HERITAGE II SERIES

List Price

Executive Workstations - Executive Returns

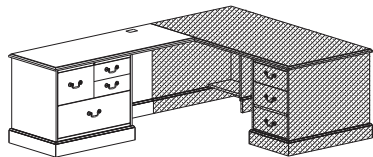

50ERL72FC **\$2684**
 Executive height return (LH), file center pedestal (locking), two box, one file drawer top, one lateral file drawer bottom, one wire mgmt grommet, 42"W kneespace
 24" x 72" x 30"H (250 lbs)

50ERL60FC **\$2534**
 Executive height return (LH), file center pedestal (locking), two box, one file drawer top, one lateral file drawer bottom, one wire mgmt grommet, 30"W kneespace
 24" x 60" x 30"H (195 lbs)

50ERL54FC **\$2398**
 Executive height return (LH), file center pedestal (locking), two box, one file drawer top, one lateral file drawer bottom, one wire mgmt grommet, 24"W kneespace
 24" x 54" x 30"H (180 lbs)

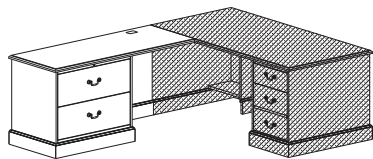

50ERL72LF **\$2470**
 Executive height return (LH), two lateral file drawers (locking), one wire mgmt grommet, 42"W kneespace
 24" x 72" x 30"H (250 lbs)

50ERL60LF **\$2298**
 Executive height return (LH), two lateral file drawers (locking), one wire mgmt grommet, 30"W kneespace
 24" x 60" x 30"H (195 lbs)

50ERL54LF **\$2164**
 Executive height return (LH), two lateral file drawers (locking), one wire mgmt grommet, 24"W kneespace
 24" x 54" x 30"H (180 lbs)

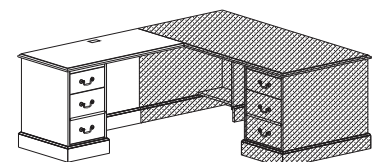

50ERL72 **\$2060**
 Executive height return (LH), box/file pedestal (locking), 1/2 support panel on connection end, one wire mgmt grommet, 54"W kneespace
 24" x 72" x 30"H (225 lbs)

50ERL48 **\$1605**
 Executive height return (LH), box/file pedestal (locking), one wire mgmt grommet, 31"W kneespace
 24" x 48" x 30"H (150 lbs)



50ERL42 **\$1560**
 Executive height return (LH), box/file pedestal (locking), one wire mgmt grommet, 25"W kneespace
 24" x 42" x 30"H (130 lbs)

50ERL36 **\$1477**
 Executive height return (LH), box/file pedestal (locking), one wire mgmt grommet, 19"W kneespace
 24" x 36" x 30"H (120 lbs)

HERITAGE II SERIES

List Price

Executive Workstations - Single Pedestal Desks

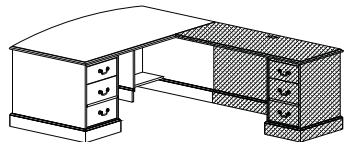

50KSPL84 \$3557
 Executive single pedestal desk (LH) with arc conference top, box/file pedestal (locking),
 6" approach overhang, tray/organizer in box drawer
 42" x 84" x 30"H (350 lbs)

50KSPL72 \$3200
 Executive single pedestal desk (LH) with arc conference top, box/file pedestal (locking),
 6" approach overhang, tray/organizer in box drawer
 42" x 72" x 30"H (325 lbs)

50KSPL7236 \$3048
 Executive single pedestal desk (LH) with arc conference top, box/file pedestal (locking),
 6" approach overhang, tray/organizer in box drawer
 36" x 72" x 30"H (310 lbs)

50SPL84 \$3235
 Executive single pedestal desk (LH) with conference top, box/file pedestal (locking),
 6" approach and left side overhang, tray/organizer in box drawer
 42" x 84" x 30"H (340 lbs)

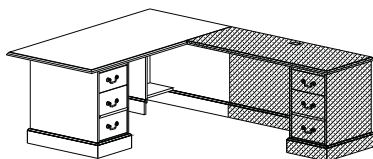

50SPL72 \$2949
 Executive single pedestal desk (LH) with conference top, box/file pedestal (locking),
 6" approach and left side overhang, tray/organizer in box drawer
 36" x 72" x 30"H (310 lbs)



50SPL6636 \$2720
 Executive single pedestal desk (LH) with conference top, box/file pedestal (locking),
 6" approach overhang only, tray/organizer in box drawer
 36" x 66" x 30"H (305 lbs)

50SPL72F \$3214
 Executive single pedestal desk (LH) with fitted top, box/file pedestal (locking),
 tray/organizer in box drawer
 36" x 72" x 30"H (300 lbs)

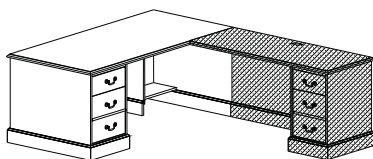

50SPL7230F \$2886
 Executive single pedestal desk (LH) with fitted top, box/file pedestal (locking),
 tray/organizer in box drawer
 30" x 72" x 30"H (290 lbs)

50SPL66F \$2687
 Executive single pedestal desk (LH) with fitted top, box/file pedestal (locking),
 tray/organizer in box drawer
 30" x 66" x 30"H (275 lbs)



50SPL60F \$2460
 Executive single pedestal desk (LH) with fitted top, box/file pedestal (locking), tray/organizer in box drawer
 10" w pedestal accommodates side-to-side letter or legal filing only. If freestanding option is specified,
 pedestal will be letter width.
 30" x 60" x 30"H (250 lbs)

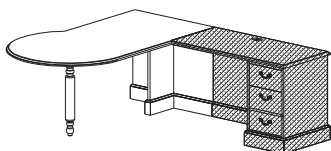

50WSP72L \$2615
 P-Top desk (LH), 42" diameter end, with sculptured wood pedestal leg 36"-42" x
 72" x 30"H (170 lbs)

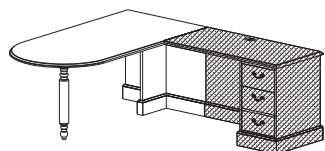

50WSB7236L \$2285
 Bullet top desk (LH), 36" diameter end, with sculptured wood pedestal leg,
 42" corner unit
 36" x 72" x 30"H (170 lbs)

HERITAGE II SERIES

List Price

Executive Workstations - Executive Returns

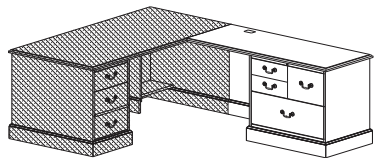

50ERR72FC **\$2684**
 Executive height return (RH), file center pedestal (locking), two box, one file drawer top, one lateral file drawer bottom, one wire mgmt grommet, 42"W kneespace
 24" x 72" x 30"H (250 lbs)

50ERR60FC **\$2534**
 Executive height return (RH), file center pedestal (locking), two box, one file drawer top, one lateral file drawer bottom, one wire mgmt grommet, 30"W kneespace
 24" x 60" x 30"H (195 lbs)

50ERR54FC **\$2398**
 Executive height return (RH), file center pedestal (locking), two box, one file drawer top, one lateral file drawer bottom, one wire mgmt grommet, 24"W kneespace
 24" x 54" x 30"H (180 lbs)

50ERR72LF **\$2470**
 Executive height return (RH), two lateral file drawers (locking), one wire mgmt grommet, 42"W kneespace
 24" x 72" x 30"H (250 lbs)

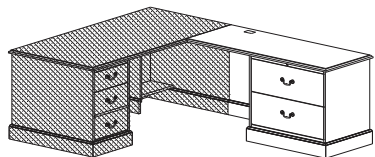

50ERR60LF **\$2298**
 Executive height return (RH), two lateral file drawers (locking), one wire mgmt grommet, 30"W kneespace
 24" x 60" x 30"H (195 lbs)

50ERR54LF **\$2164**
 Executive height return (RH), two lateral file drawers (locking), one wire mgmt grommet, 24"W kneespace
 24" x 54" x 30"H (180 lbs)

50ERR72 **\$2060**
 Executive height return (RH), box/file pedestal (locking), 1/2 support panel on connection end, one wire mgmt grommet, 54"W kneespace
 24" x 72" x 30"H (225 lbs)

50ERR48 **\$1605**
 Executive height return (RH), box/file pedestal (locking), one wire mgmt grommet, 31"W kneespace
 24" x 48" x 30"H (150 lbs)

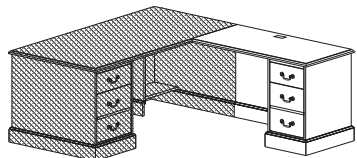

50ERR42 **\$1560**
 Executive height return (RH), box/file pedestal (locking), one wire mgmt grommet, 25"W kneespace
 24" x 42" x 30"H (130 lbs)

50ERR36 **\$1477**
 Executive height return (RH), box/file pedestal (locking), one wire mgmt grommet, 19"W kneespace
 24" x 36" x 30"H (120 lbs)

HERITAGE II SERIES

List Price

Computer Desk U Workstations - Single Pedestal Desks

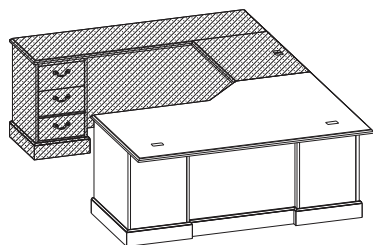

50ECWS8446R **\$3578**
 Executive single pedestal computer desk (RH) with conference top, box/file pedestal (locking), 46" corner unit, 4" approach overhang, tray/organizer in box drawer, two wire mgmt grommets in top
 34"- 46" x 84" x 30"H (385 lbs)

50ECWS7246R **\$3135**
 Executive single pedestal computer desk (RH) with conference top, box/file pedestal (locking), 46" corner unit, 4" approach overhang, tray/organizer in box drawer, two wire mgmt grommets in top
 34"- 46" x 72" x 30"H (360 lbs)

50ECWS6640R **\$2725**
 Executive single pedestal computer desk (RH) with conference top, box/file pedestal (locking), 40" corner unit, 4" approach overhang, tray/organizer in box drawer, two wire mgmt grommets in top
 28"- 40" x 66" x 30"H (280 lbs)

50ECWS8442R **\$3287**
 Executive single pedestal computer desk (RH) with fitted top, box/file pedestal (locking), 42" corner unit, tray/organizer in box drawer, two wire mgmt grommets in top
 30"- 42" x 84" x 30"H (375 lbs)

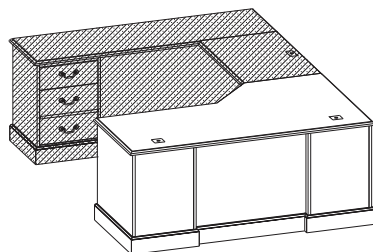

50ECWS7242R **\$2992**
 Executive single pedestal computer desk (RH) with fitted top, box/file pedestal (locking), 42" corner unit, tray/organizer in box drawer, two wire mgmt grommets in top
 30"- 42" x 72" x 30"H (340 lbs)

50ECWS7236R **\$2954**
 Executive single pedestal computer desk (RH) with fitted top, box/file pedestal (locking), 36" corner unit, tray/organizer in box drawer, two wire mgmt grommets in top
 24"- 36" x 72" x 30"H (283 lbs)

50ECWS6636R **\$2713**
 Executive single pedestal computer desk (RH) with fitted top, box/file pedestal (locking), 36" corner unit, tray/organizer in box drawer, two wire mgmt grommets in top
 24"- 36" x 66" x 30"H (260 lbs)

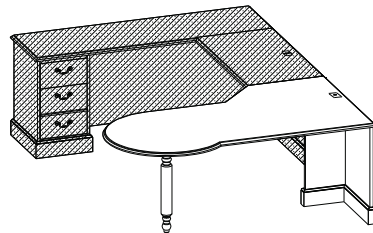

50ECWSP76R **\$2941**
 P-Top computer desk (RH), 36" diameter end, with sculptured wood pedestal leg, 42" corner unit, one wire mgmt grommet in top (left)
 30"-42" x 76" x 30"H (330 lbs)

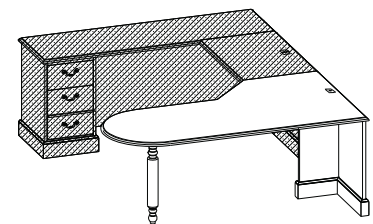

50ECWSB76R **\$2609**
 Bullet top computer desk (RH), 30" diameter end, with sculptured wood pedestal leg, 42" corner unit, one wire mgmt grommet in top (left)
 30"-42" x 76" x 30"H (330 lbs)

HERITAGE II SERIES

List Price

Computer Desk U Workstations - Connecting Bridges

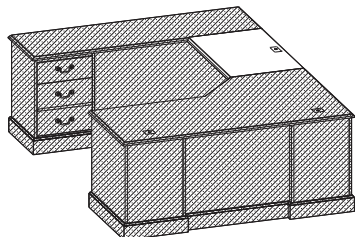

| | |
|---|---------------|
| 50WS48R Executive height corner bridge (RH), one computer grommet 24" x 48" x 30"H (105 lbs) | \$1091 |
| 50WS42R Executive height corner bridge (RH), one computer grommet 24" x 42" x 30"H (85 lbs) | \$1049 |
| 50WS36R Executive height corner bridge (RH), one computer grommet 24" x 36" x 30"H (65 lbs) | \$958 |

Computer Desk U Workstations - Single Pedestal Credenzas

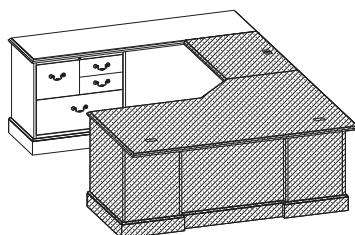

| | |
|--|---------------|
| 50DCSPL84FC Single pedestal credenza (LH), file center pedestal (locking), two box, one file drawer top, one lateral file drawer bottom, one wire mgmt grommet, 52 3/4"W kneespace 21" x 84" x 30"H (295 lbs) | \$3510 |
| 50DCSPL84FC-24 - 24" x 84" x 30"H | \$3939 |
| 50DCSPL72FC Single pedestal credenza (LH), file center pedestal (locking), two box, one file drawer top, one lateral file drawer bottom, one wire mgmt grommet, 40 3/4"W kneespace 21" x 72" x 30"H (280 lbs) | \$3183 |
| 50DCSPL72FC-24 - 24" x 72" x 30"H | \$3579 |
| 50DCSPL66FC Single pedestal credenza (LH), file center pedestal (locking), two box, one file drawer top, one lateral file drawer bottom, one wire mgmt grommet, 34 3/4"W kneespace 21" x 66" x 30"H (265 lbs) | \$3006 |
| 50DCSPL66FC-24 - 24" x 66" x 30"H | \$3369 |

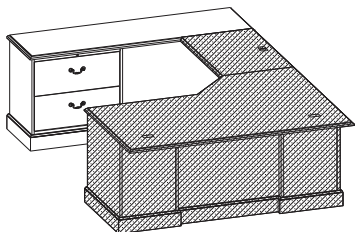

| | |
|--|---------------|
| 50DCSPL84LF Single pedestal credenza (LH), two lateral file drawers (locking), legal or letter filing, one wire mgmt grommet in back panel, 52 3/4"W kneespace 21" x 84" x 30"H (290 lbs) | \$3110 |
| 50DCSPL84LF-24 - 24" x 84" x 30"H | \$3539 |
| 50DCSPL72LF Single pedestal credenza (LH), two lateral file drawers (locking), legal or letter filing, one wire mgmt grommet in back panel, 40 3/4"W kneespace 21" x 72" x 30"H (275 lbs) | \$3000 |
| 50DCSPL72LF-24 - 24" x 72" x 30"H | \$3396 |
| 50DCSPL66LF Single pedestal credenza (LH), two lateral file drawers (locking), legal or letter filing, one wire mgmt grommet in back panel, 34 3/4"W kneespace 21" x 66" x 30"H (260 lbs) | \$2880 |
| 50DCSPL66LF-24 - 24" x 66" x 30"H | \$3243 |

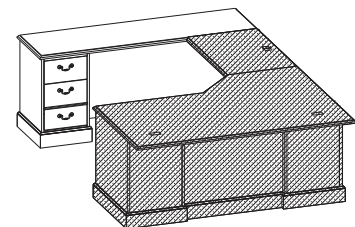

| | |
|---|---------------|
| 50DCSPL72 Single pedestal credenza (LH), box/file pedestal (locking), one wire mgmt grommet in back panel, 54"W kneespace 21" x 72" x 30"H (220 lbs) | \$2536 |
| 50DCSPL72-24 - 24" x 72" x 30"H | \$2932 |
| 50DCSPL66 Single pedestal credenza (LH), box/file pedestal (locking), one wire mgmt grommet in back panel, 48"W kneespace 21" x 66" x 30"H (205 lbs) | \$2390 |
| 50DCSPL66-24 - 24" x 66" x 30"H | \$2753 |
| 50DCSPL60 Single pedestal credenza (LH), box/file pedestal (locking), one wire mgmt grommet in back panel, 42"W kneespace 21" x 60" x 30"H (195 lbs) | \$2122 |
| 50DCSPL60-24 - 24" x 60" x 30"H | \$2452 |



HERITAGE II SERIES

List Price

Computer Desk U Workstations - Single Pedestal Desks

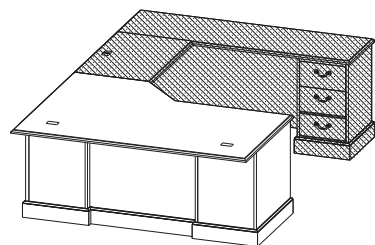

50ECWS8446L **\$3578**
 Executive single pedestal computer desk (LH) with conference top, box/file pedestal (locking), 46" corner unit, 4" approach overhang, tray/organizer in box drawer, two wire mgmt grommets in top
 34"- 46" x 84" x 30"H (385 lbs)

50ECWS7246L **\$3135**
 Executive single pedestal computer desk (LH) with conference top, box/file pedestal (locking), 46" corner unit, 4" approach overhang, tray/organizer in box drawer, two wire mgmt grommets in top
 34"- 46" x 72" x 30"H (360 lbs)

50ECWS6640L **\$2725**
 Executive single pedestal computer desk (LH) with conference top, box/file pedestal (locking), 40" corner unit, 4" approach overhang, tray/organizer in box drawer, two wire mgmt grommets in top
 28"- 40" x 66" x 30"H (280 lbs)

50ECWS8442L **\$3287**
 Executive single pedestal computer desk (LH) with fitted top, box/file pedestal (locking), 42" corner unit, tray/organizer in box drawer, two wire mgmt grommets in top
 30"- 42" x 84" x 30"H (375 lbs)

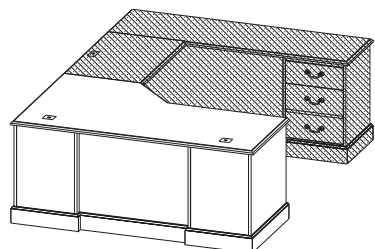

50ECWS7242L **\$2992**
 Executive single pedestal computer desk (LH) with fitted top, box/file pedestal (locking), 42" corner unit, tray/organizer in box drawer, two wire mgmt grommets in top
 30"- 42" x 72" x 30"H (340 lbs)

50ECWS7236L **\$2954**
 Executive single pedestal computer desk (LH) with fitted top, box/file pedestal (locking), 36" corner unit, tray/organizer in box drawer, two wire mgmt grommets in top
 24"- 36" x 72" x 30"H (283 lbs)

50ECWS6636L **\$2713**
 Executive single pedestal computer desk (LH) with fitted top, box/file pedestal (locking), 36" corner unit, tray/organizer in box drawer, two wire mgmt grommets in top
 24"- 36" x 66" x 30"H (260 lbs)

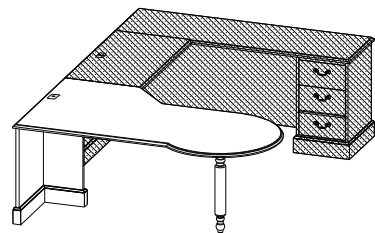

50ECWSP76L **\$2941**
 P-Top computer desk (LH), 36" diameter end, with sculptured wood pedestal leg, 42" corner unit, one wire mgmt grommet in top (right)
 30"-42" x 76" x 30"H (330 lbs)

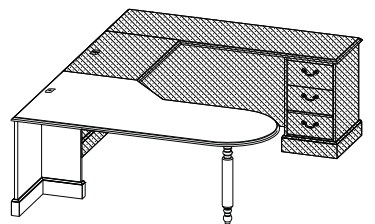

50ECWSB76L **\$2609**
 Bullet top computer desk (LH), 30" diameter end, with sculptured wood pedestal leg, 42" corner unit, one wire mgmt grommet in top (right)
 30"-42" x 76" x 30"H (330 lbs)

HERITAGE II SERIES

List Price

Computer Desk U Workstations - Connecting Bridges

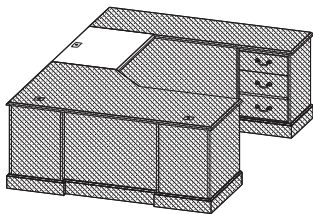

| | |
|---|---------------|
| 50WS48L Executive height corner bridge (LH), one computer grommet 24" x 48" x 30"H (105 lbs) | \$1091 |
| 50WS42L Executive height corner bridge (LH), one computer grommet 24" x 42" x 30"H (85 lbs) | \$1049 |
| 50WS36L Executive height corner bridge (LH), one computer grommet 24" x 36" x 30"H (65 lbs) | \$958 |

Computer Desk U Workstations - Single Pedestal Credenzas

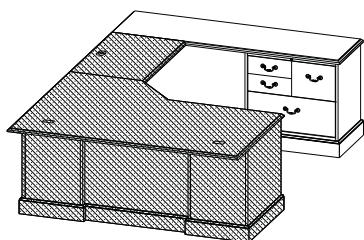

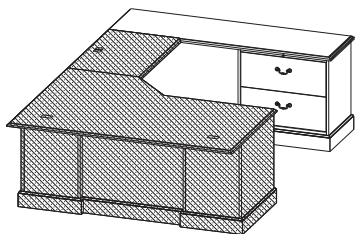

| | |
|--|---------------|
| 50DCSPR84FC Single pedestal credenza (RH), file center pedestal (locking), two box, one file drawer top, one lateral file drawer bottom, one wire mgmt grommet, 52 3/4"W kneespace 21" x 84" x 30"H (295 lbs) | \$3510 |
| 50DCSPR84FC-24 -24" x84"x30"H | \$3939 |
| 50DCSPR72FC Single pedestal credenza (RH), file center pedestal (locking), two box, one file drawer top, one lateral file drawer bottom, one wire mgmt grommet, 40 3/4"W kneespace 21" x 72" x 30"H (280 lbs) | \$3183 |
| 50DCSPR72FC-24 -24" x72"x30"H | \$3579 |
| 50DCSPR66FC Single pedestal credenza (RH), file center pedestal (locking), two box, one file drawer top, one lateral file drawer bottom, one wire mgmt grommet, 34 3/4"W kneespace 21" x 66" x 30"H (265 lbs) | \$3006 |
| 50DCSPR66FC-24 -24" x66"x30"H | \$3369 |

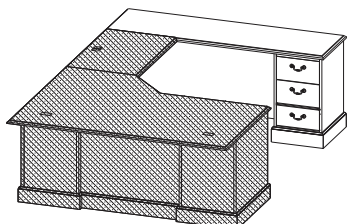

| | |
|--|---------------|
| 50DCSPR84LF Single pedestal credenza (RH), two lateral file drawers (locking), legal or letter filing, one wire mgmt grommet in back panel, 52 3/4"W kneespace 21" x 84" x 30"H (290 lbs) | \$3110 |
| 50DCSPR84LF-24 -24" x84"x30"H | \$3539 |
| 50DCSPR72LF Single pedestal credenza (RH), two lateral file drawers (locking), legal or letter filing, one wire mgmt grommet in back panel, 40 3/4"W kneespace 21" x 72" x 30"H (275 lbs) | \$3000 |
| 50DCSPR72LF-24 -24"x72"x30"H | \$3396 |
| 50DCSPR66LF Single pedestal credenza (RH), two lateral file drawers (locking), legal or letter filing, one wire mgmt grommet in back panel, 34 3/4"W kneespace 21" x 66" x 30"H (260 lbs) | \$2880 |
| 50DCSPR66LF-24 -24" x66"x30"H | \$3243 |



| | | |
|---|---------------|---|
| 50DCSPR72 Single pedestal credenza (RH), box/file pedestal (locking), one wire mgmt grommet in back panel, 54"W kneespace 21" x 72" x 30"H (220 lbs) | \$2536 |  |
| 50DCSPR72-24 -24" x72"x30"H | \$2932 | |
| 50DCSPR66 Single pedestal credenza (RH), box/file pedestal (locking), one wire mgmt grommet in back panel, 48"W kneespace 21" x 66" x 30"H (205 lbs) | \$2390 |  |
| 50DCSPR66-24 -24" x66"x30"H | \$2753 | |
| 50DCSPR60 Single pedestal credenza (RH), box/file pedestal (locking), one wire mgmt grommet in back panel, 42"W kneespace 21" x 60" x 30"H (195 lbs) | \$2122 | |
| 50DCSPR60-24 -24" x60"x30"H | \$2452 | |

HERITAGE II SERIES

List Price

U Configurations - Single Pedestal Desks

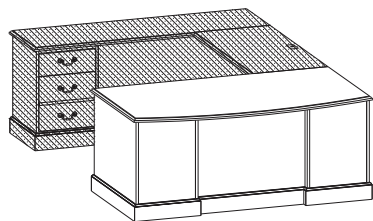

50KSPR84 \$3557

Executive single pedestal desk (RH) with arc conference top, box/file pedestal (locking), 6" approach overhang, tray/organizer in box drawer
42" x 84" x 30"H (350 lbs)

50KSPR72 \$3200

Executive single pedestal desk (RH) with arc conference top, box/file pedestal (locking), 6" approach overhang, tray/organizer in box drawer
42" x 72" x 30"H (325 lbs)

50KSPR7236 \$3048

Executive single pedestal desk (RH) with arc conference top, box/file pedestal (locking), 6" approach overhang, tray/organizer in box drawer
36" x 72" x 30"H (310 lbs)

50SPR84 \$3235

Executive single pedestal desk (RH) with conference top, box/file pedestal (locking), 6" approach and right side overhang, tray/organizer in box drawer
42" x 84" x 30"H (340 lbs)

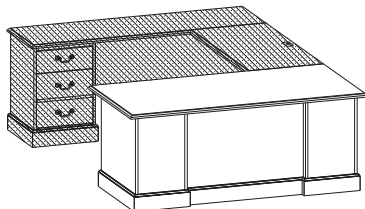

50SPR72 \$2949

Executive single pedestal desk (RH) with conference top, box/file pedestal (locking), 6" approach and right side overhang, tray/organizer in box drawer
36" x 72" x 30"H (310 lbs)



50SPR6636 \$2720

Executive single pedestal desk (RH) with conference top, box/file pedestal (locking), 6" approach overhang only, tray/organizer in box drawer
36" x 66" x 30"H (305 lbs)

50SPR72F \$3214

Executive single pedestal desk (RH) with fitted top, box/file pedestal (locking), tray/organizer in box drawer
36" x 72" x 30"H (300 lbs)

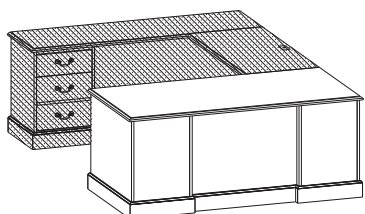

50SPR7230F \$2886

Executive single pedestal desk (RH) with fitted top, box/file pedestal (locking), tray/organizer in box drawer
30" x 72" x 30"H (290 lbs)

50SPR66F \$2687

Executive single pedestal desk (RH) with fitted top, box/file pedestal (locking), tray/organizer in box drawer
30" x 66" x 30"H (275 lbs)



50SPR60F \$2460

Executive single pedestal desk (RH) with fitted top, box/file pedestal (locking), tray/organizer in box drawer
10" w pedestal accommodates side-to-side letter or legal filing only. If freestanding option is specified, pedestal will be letter width.
30" x 60" x 30"H (250 lbs)

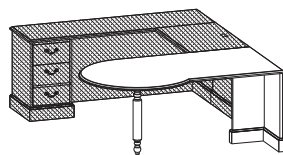

50WSP72R \$2615

P-Top desk (RH), 42" diameter end, with sculptured wood pedestal leg 36"-42" x 72" x 30"H (170 lbs)

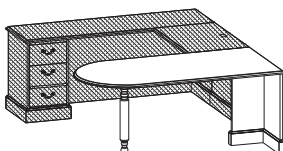

50WSB7236R \$2285

Bullet top desk (RH), 36" diameter end, with sculptured wood pedestal leg, 42" corner unit
36" x 72" x 30"H (170 lbs)

HERITAGE II SERIES

List Price

U Configurations - Connecting Bridges

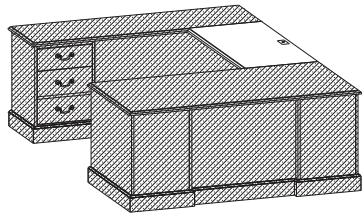

| | |
|--|--------|
| 50WS54 Executive height bridge, one computer grommet 24" x 54" x 30"H (105 lbs) | \$1229 |
| 50WS48 Executive height bridge, one computer grommet 24" x 48" x 30"H (95 lbs) | \$1091 |
| 50WS42 Executive height bridge, one computer grommet 24" x 42" x 30"H (78 lbs) | \$1049 |



U Configurations - Single Pedestal Credenzas

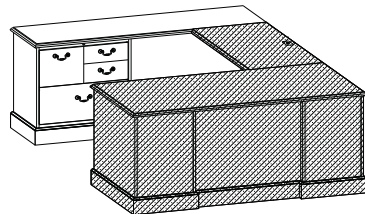

| | |
|--|--------|
| 50DCSPL84FC Single pedestal credenza (LH), file center pedestal (locking), two box, one file drawer top, one lateral file drawer bottom, one wire mgmt grommet, 52 3/4"W kneespace 21" x 84" x 30"H (295 lbs) | \$3510 |
| 50DCSPL84FC-24 - 24" x 84" x 30"H | \$3939 |
| 50DCSPL72FC Single pedestal credenza (LH), file center pedestal (locking), two box, one file drawer top, one lateral file drawer bottom, one wire mgmt grommet, 40 3/4"W kneespace 21" x 72" x 30"H (280 lbs) | \$3183 |
| 50DCSPL72FC-24 - 24" x 72" x 30"H | \$3579 |
| 50DCSPL66FC Single pedestal credenza (LH), file center pedestal (locking), two box, one file drawer top, one lateral top, one wire mgmt grommet, 34 3/4"W kneespace 21" x 66" x 30"H (265 lbs) | \$3006 |
| 50DCSPL66FC-24 - 24" x 66" x 30"H | \$3369 |

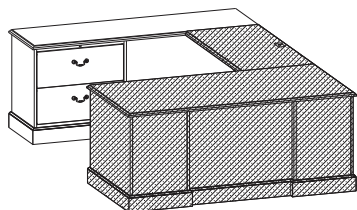

| | |
|--|--------|
| 50DCSPL84LF Single pedestal credenza (LH), two lateral file drawers (locking), legal or letter filing, one wire mgmt grommet in back panel, 52 3/4"W kneespace 21" x 84" x 30"H (290 lbs) | \$3110 |
| 50DCSPL84LF-24 - 24" x 84" x 30"H | \$3539 |
| 50DCSPL72LF Single pedestal credenza (LH), two lateral file drawers (locking), legal or letter filing, one wire mgmt grommet in back panel, 40 3/4"W kneespace 21" x 72" x 30"H (275 lbs) | \$3000 |
| 50DCSPL72LF-24 - 24" x 72" x 30"H | \$3396 |
| 50DCSPL66LF Single pedestal credenza (LH), two lateral file drawers (locking), legal or letter filing, one wire mgmt grommet in back panel, 34 3/4"W kneespace 21" x 66" x 30"H (260 lbs) | \$2880 |
| 50DCSPL66LF-24 - 24" x 66" x 30"H | \$3243 |

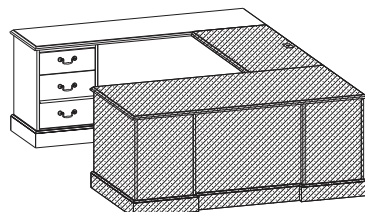

| | |
|---|--------|
| 50DCSPL72 Single pedestal credenza (LH), box/file pedestal (locking), one wire mgmt grommet in back panel, 54"W kneespace 21" x 72" x 30"H (220 lbs) | \$2536 |
| 50DCSPL72-24 - 24" x 72" x 30"H | \$2932 |
| 50DCSPL66 Single pedestal credenza (LH), box/file pedestal (locking), one wire mgmt grommet in back panel, 48"W kneespace 21" x 66" x 30"H (205 lbs) | \$2390 |
| 50DCSPL66-24 - 24" x 66" x 30"H | \$2753 |
| 50DCSPL60 Single pedestal credenza (LH), box/file pedestal (locking), one wire mgmt grommet in back panel, 42"W kneespace 21" x 60" x 30"H (195 lbs) | \$2122 |
| 50DCSPL60-24 - 24" x 60" x 30"H | \$2452 |



HERITAGE II SERIES

List Price

U Configurations - Single Pedestal Desks

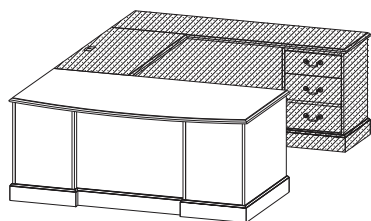

50KSPL84 \$3557
 Executive single pedestal desk (LH) with arc conference top, box/file pedestal (locking),
 6" approach overhang, tray/organizer in box drawer
 42" x 84" x 30"H (350 lbs)

50KSPL72 \$3200
 Executive single pedestal desk (LH) with arc conference top, box/file pedestal (locking),
 6" approach overhang, tray/organizer in box drawer
 42" x 72" x 30"H (325 lbs)

50KSPL7236 \$3048
 Executive single pedestal desk (LH) with arc conference top, box/file pedestal (locking),
 6" approach overhang, tray/organizer in box drawer
 36" x 72" x 30"H (310 lbs)

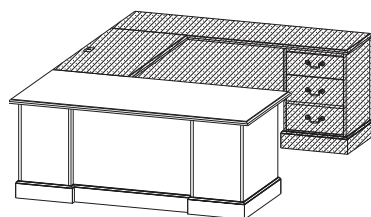

50SPL84 \$3235
 Executive single pedestal desk (LH) with conference top, box/file pedestal (locking),
 6" approach and left side overhang, tray/organizer in box drawer
 42" x 84" x 30"H (340 lbs)

50SPL72 \$2949
 Executive single pedestal desk (LH) with conference top, box/file pedestal (locking),
 6" approach and left side overhang, tray/organizer in box drawer
 36" x 72" x 30"H (310 lbs)



50SPL6636 \$2720
 Executive single pedestal desk (LH) with conference top, box/file pedestal (locking),
 6" approach overhang only, tray/organizer in box drawer
 36" x 66" x 30"H (305 lbs)

50SPL72F \$3214
 Executive single pedestal desk (LH) with fitted top, box/file pedestal (locking),
 tray/organizer in box drawer
 36" x 72" x 30"H (300 lbs)

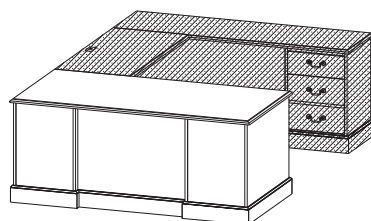

50SPL7230F \$2886
 Executive single pedestal desk (LH) with fitted top, box/file pedestal (locking),
 tray/organizer in box drawer
 30" x 72" x 30"H (290 lbs)

50SPL66F \$2687
 Executive single pedestal desk (LH) with fitted top, box/file pedestal (locking),
 tray/organizer in box drawer
 30" x 66" x 30"H (275 lbs)



50SPL60F \$2460
 Executive single pedestal desk (LH) with fitted top, box/file pedestal (locking), tray/organizer in box drawer
 10" w pedestal accommodates side-to-side letter or legal filing only. If freestanding option is specified,
 pedestal will be letter width.
 30" x 60" x 30"H (250 lbs)

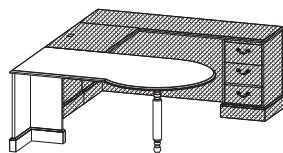

50WSP72L \$2615
 P-Top desk (LH), 42" diameter end, with sculptured wood pedestal leg 36"-42" x
 72" x 30"H (170 lbs)

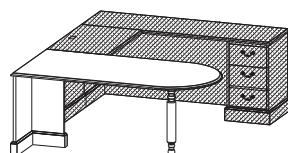

50WSB7236L \$2285
 Bullet top desk (LH), 36" diameter end, with sculptured wood pedestal leg,
 42" corner unit
 36" x 72" x 30"H (170 lbs)

HERITAGE II SERIES

List Price

U Configurations - Connecting Bridges

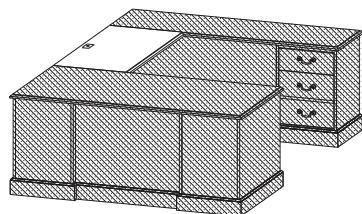

| | |
|--|--------|
| 50WS54 Executive height bridge, one computer grommet 24" x 54" x 30"H (105 lbs) | \$1229 |
| 50WS48 Executive height bridge, one computer grommet 24" x 48" x 30"H (95 lbs) | \$1091 |
| 50WS42 Executive height bridge, one computer grommet 24" x 42" x 30"H (78 lbs) | \$1049 |



U Configurations - Single Pedestal Credenzas

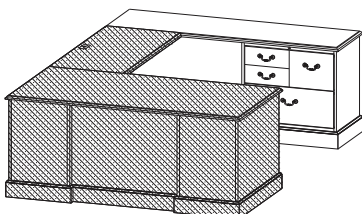

| | |
|--|--------|
| 50DCSPR84FC Single pedestal credenza (RH), file center pedestal (locking), two box, one file drawer top, one lateral file drawer bottom, one wire mgmt grommet, 52 3/4"W kneespace 21" x 84" x 30"H (295 lbs) | \$3510 |
| 50DCSPR84FC-24 -24" x84"x30"H | \$3939 |
| 50DCSPR72FC Single pedestal credenza (RH), file center pedestal (locking), two box, one file drawer top, one lateral file drawer bottom, one wire mgmt grommet, 40 3/4"W kneespace 21" x 72" x 30"H (280 lbs) | \$3183 |
| 50DCSPR72FC-24 -24" x72"x30"H | \$3579 |
| 50DCSPR66FC Single pedestal credenza (RH), file center pedestal (locking), two box, one file drawer top, one lateral file drawer bottom, one wire mgmt grommet, 34 3/4"W kneespace 21" x 66" x 30"H (265 lbs) | \$3006 |
| 50DCSPR66FC-24 -24" x66"x30"H | \$3369 |

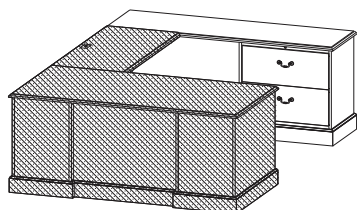

| | |
|--|--------|
| 50DCSPR84LF Single pedestal credenza (RH), two lateral file drawers (locking), legal or letter filing, one wire mgmt grommet in back panel, 52 3/4"W kneespace 21" x 84" x 30"H (290 lbs) | \$3110 |
| 50DCSPR84LF-24 -24" x84"x30"H | \$3539 |
| 50DCSPR72LF Single pedestal credenza (RH), two lateral file drawers (locking), legal or letter filing, one wire mgmt grommet in back panel, 40 3/4"W kneespace 21" x 72" x 30"H (275 lbs) | \$3000 |
| 50DCSPR72LF-24 -24" x72"x30"H | \$3396 |
| 50DCSPR66LF Single pedestal credenza (RH), two lateral file drawers (locking), legal or letter filing, one wire mgmt grommet in back panel, 34 3/4"W kneespace 21" x 66" x 30"H (260 lbs) | \$2880 |
| 50DCSPR66LF-24 -24" x66"x30"H | \$3243 |

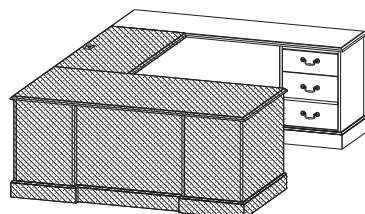

| | |
|---|--------|
| 50DCSPR72 Single pedestal credenza (RH), box/file pedestal (locking), one wire mgmt grommet in back panel, 54"W kneespace 21" x 72" x 30"H (220 lbs) | \$2536 |
| 50DCSPR72-24 -24" x72"x30"H | \$2932 |
| 50DCSPR66 Single pedestal credenza (RH), box/file pedestal (locking), one wire mgmt grommet in back panel, 48"W kneespace 21" x 66" x 30"H (205 lbs) | \$2390 |
| 50DCSPR66-24 -24" x66"x30"H | \$2753 |
| 50DCSPR60 Single pedestal credenza (RH), box/file pedestal (locking), one wire mgmt grommet in back panel, 42"W kneespace 21" x 60" x 30"H (195 lbs) | \$2122 |
| 50DCSPR60-24 -24" x60"x30"H | \$2452 |



HERITAGE II SERIES

List Price

Corner Configurations - Connecting Corners

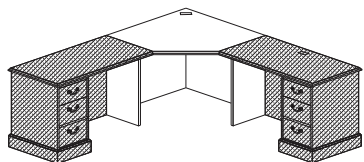

50CWS42 \$1945
 Corner unit - 42", one computer grommet
 42" x 42" x 30"H (160 lbs)

50CWS36 \$1685
 Corner unit - 36", one computer grommet
 36" x 36" x 30"H (160 lbs)

Corner Configurations - Connecting Units

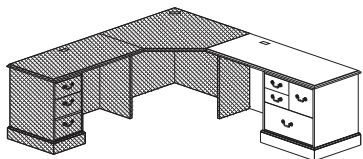

50ERR60FCCU_ _ \$2534
 Executive height return (RH), file center pedestal (locking), two box, one file drawer top, one lateral file drawer bottom, one wire mgmt grommet, 30"W kneespace
 24" x 60" x 30"H (195 lbs)

50ERR54FCCU \$2398
 Executive height return (RH), file center pedestal (locking), two box, one file drawer top, one lateral file drawer bottom, one wire mgmt grommet, 24"W kneespace
 24" x 54" x 30"H (180 lbs)

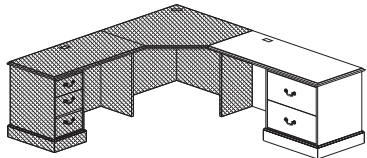

50ERR60LFCU \$2298
 Executive height return (RH), two lateral file drawers (locking), one wire mgmt grommet, 30"W kneespace
 24" x 60" x 30"H (195 lbs)

50ERR54LFCU \$2164
 Executive height return (RH), two lateral file drawers (locking), one wire mgmt grommet, 24"W kneespace
 24" x 54" x 30"H (180 lbs)

50ERR72CU \$2060
 Executive height return (RH), box/file pedestal (locking), 1/2 support panel on connection end, one wire mgmt grommet, 54"W kneespace
 24" x 72" x 30"H (225 lbs)

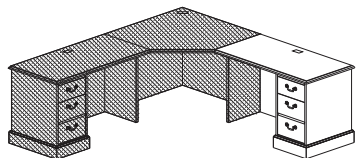

50ERR48CU \$1605
 Executive height return (RH), box/file pedestal (locking), one wire mgmt grommet, 31"W kneespace
 24" x 48" x 30"H (150 lbs)

50ERR42CU \$1560
 Executive height return (RH), box/file pedestal (locking), one wire mgmt grommet, 25"W kneespace
 24" x 42" x 30"H (130 lbs)

50ERR36CU \$1477
 Executive height return (RH), box/file pedestal (locking), one wire mgmt grommet, 19"W kneespace
 24" x 36" x 30"H (120 lbs)

HERITAGE II SERIES

List Price

Corner Configurations - Connecting Corners

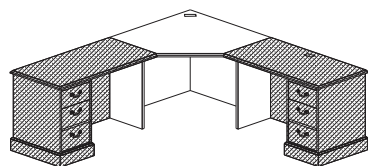

50CWS42
 Corner unit - 42", one computer grommet
 42" x 42" x 30"H (160 lbs)

\$1945

50CWS36
 Corner unit - 36", one computer grommet
 36" x 36" x 30"H (160 lbs)

\$1685

Corner Configurations - Connecting Units

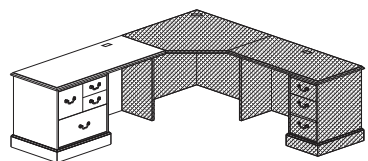

50ERL60FCCU
 Executive height return (LH), file center pedestal (locking), two box, one file drawer top, one lateral file drawer bottom, one wire mgmt grommet, 30"W kneespace
 24" x 60" x 30"H (195 lbs)

\$2534

50ERL54FCCU
 Executive height return (LH), file center pedestal (locking), two box, one file drawer top, one lateral file drawer bottom, one wire mgmt grommet, 24"W kneespace
 24" x 54" x 30"H (180 lbs)

\$2398

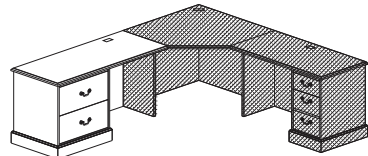

50ERL60LFCU
 Executive height return (LH), two lateral file drawers (locking), one wire mgmt grommet, 30"W kneespace
 24" x 60" x 30"H (195 lbs)

\$2298

50ERL54LFCU
 Executive height return (LH), two lateral file drawers (locking), one wire mgmt grommet, 24"W kneespace
 24" x 54" x 30"H (180 lbs)

\$2164

50ERL72CU
 Executive height return (LH), box/file pedestal (locking), 1/2 support panel on connection end, one wire mgmt grommet, 54"W kneespace
 24" x 72" x 30"H (225 lbs)

\$2060

50ERL48CU
 Executive height return (LH), box/file pedestal (locking), one wire mgmt grommet, 31"W kneespace
 24" x 48" x 30"H (150 lbs)

\$1605

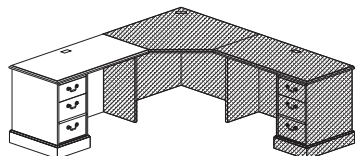

50ERL42CU
 Executive height return (LH), box/file pedestal (locking), one wire mgmt grommet, 25"W kneespace
 24" x 42" x 30"H (130 lbs)

\$1560

50ERL36CU
 Executive height return (LH), box/file pedestal (locking), one wire mgmt grommet, 19"W kneespace
 24" x 36" x 30"H (120 lbs)

\$1477

HERITAGE II SERIES

List Price

Modular Overhead Storage Units

Modular hutches are used when you are ganging units together. Left units are used on the left side of the desk (flat or modular on right hand side), right units are used on right side of the desk (flat or modular on left hand side), and center units are used between a right and left hand unit (flat or modular on both sides)

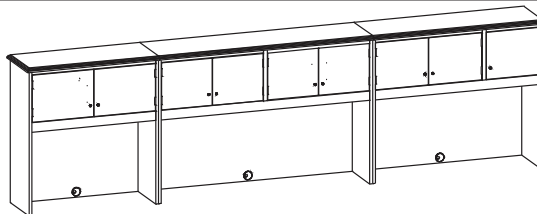

50MH70R, 50MH70L or 50MH70C **\$3004**

Overhead storage unit with hinged wood doors, two storage areas behind four hinged doors (non-locking), two wire mgmt access grommets in center back panel
22" clearance between apron rail & worksurface
15" x 70" x 39"H (210 lbs)

50MH58R, 50MH58L or 50MH58C **\$2710**

Overhead storage unit with hinged wood doors, two storage areas behind four hinged doors (non-locking), two wire mgmt access grommets in center back panel
22" clearance between apron rail & worksurface
15" x 58" x 39"H (175 lbs)

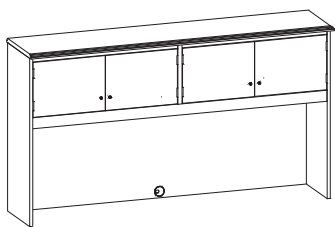

50MH46R, 50MH46L or 50MH46C **\$2455**

Overhead storage unit with hinged wood doors, two storage areas behind three hinged doors (non-locking), two wire mgmt access grommets in center back panel
22" clearance between apron rail & worksurface
15" x 46" x 39"H (140 lbs)

50MH40R, 50MH40L or 50MH40C **\$2122**

Overhead storage unit with hinged wood doors, one storage areas behind two hinged doors (non-locking), two wire mgmt access grommets in center back panel
22" clearance between apron rail & worksurface
15" x 40" x 39"H (125 lbs)

50MH35R, 50MH35L or 50MH35C **\$1952**

Overhead storage unit with hinged wood doors, one storage areas behind two hinged doors (non-locking), two wire mgmt access grommets in center back panel
22" clearance between apron rail & worksurface
15" x 35" x 39"H (105 lbs)

Wall Mounted Storage Units

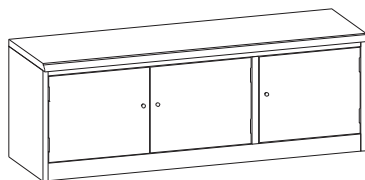

50WM48 **\$1335**

Wall mounted storage unit with three hinged doors
16" x 48" x 16"H (89 lbs) **attaching wall bracket included

50WM42 **\$1118**

Wall mounted storage unit with three hinged doors
16" x 42" x 16"H (80 lbs) **attaching wall bracket included

50WM36 **\$985**

Wall mounted storage unit with two hinged doors
16" x 36" x 16"H (70 lbs) **attaching wall bracket included

50WM30 **\$864**

Wall mounted storage unit with two hinged doors
16" x 30" x 16"H (60 lbs) **attaching wall bracket included

Accessories



TB48-12 **\$299**

Fabric tackboard, (COM, Grade A, Grade B) 3/4" x 48" x 12"H (18 lbs)

TB42-12 **\$256**

Fabric tackboard, (COM, Grade A, Grade B) 3/4" x 42" x 12"H (17 lbs)

TB36-12 **\$223**

Fabric tackboard, (COM, Grade A, Grade B) 3/4" x 36" x 12"H (16 lbs)

TB30-12 **\$203**

Fabric tackboard, (COM, Grade A, Grade B) 3/4" x 30" x 12"H (15 lbs)



TL48 **\$215**

Task light (UL approved), 6" x 48" x 1 1/2"H (15 lbs)

TL24 **\$185**

Task light (UL approved), 6" x 24" x 1 1/2"H (10 lbs)

HERITAGE II SERIES

List Price

Overhead Storage Units

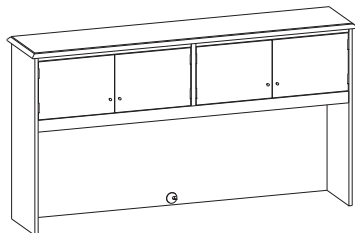

50HC82 \$3120
 Overhead storage unit with hinged wood doors, two storage areas behind four hinged doors (non-locking), two wire mgmt access grommets in center back panel
 22" clearance between apron rail & worksurface
 15" x 81" x 39"H (253 lbs)

50HC76 \$2989
 Overhead storage unit with hinged wood doors, two storage areas behind four hinged doors (non-locking), two wire mgmt access grommets in center back panel
 22" clearance between apron rail & worksurface
 15" x 75" x 39"H (235 lbs)

50HC70 \$2784
 Overhead storage unit with hinged wood doors, two storage areas behind four hinged doors (non-locking), two wire mgmt access grommets in center back panel
 22" clearance between apron rail & worksurface
 15" x 69" x 39"H (215 lbs)



50HC64 \$2668
 Overhead storage unit with hinged wood doors, two storage areas behind four hinged doors (non-locking), two wire mgmt access grommets in center back panel
 22" clearance between apron rail & worksurface
 15" x 63" x 39"H (200 lbs)

50HC58 \$2568
 Overhead storage unit with hinged wood doors, two storage areas behind four hinged doors (non-locking), two wire mgmt access grommets in center back panel
 22" clearance between apron rail & worksurface
 15" x 57" x 39"H (188 lbs)

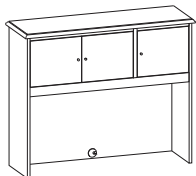

50HC46 \$2455
 Overhead storage unit with hinged wood doors, two storage areas behind three hinged doors (non-locking), two wire mgmt access grommets in center back panel
 22" clearance between apron rail & worksurface
 15" x 45" x 39"H (145 lbs)

50HC40 \$2257
 Overhead storage unit with hinged wood doors, two storage areas behind three hinged doors (non-locking), two wire mgmt access grommets in center back panel
 22" clearance between apron rail & worksurface
 15" x 39" x 39"H (130 lbs)

Accessories



TB77 \$474
 Fabric tackboard, (COM, Grade A, Grade B) 3/4" x 77" x 15 1/2"H (20 lbs)

TB71 \$448
 Fabric tackboard, (COM, Grade A, Grade B) 3/4" x 71" x 15 1/2"H (18 lbs)

TB65 \$400
 Fabric tackboard, (COM, Grade A, Grade B) 3/4" x 65" x 15 1/2"H (16 lbs)

TB59 \$386
 Fabric tackboard, (COM, Grade A, Grade B) 3/4" x 59" x 15 1/2"H (14 lbs)

TB53 \$341
 Fabric tackboard, (COM, Grade A, Grade B) 3/4" x 53" x 15 1/2"H (12 lbs)

TB41 \$300
 Fabric tackboard, (COM, Grade A, Grade B) 3/4" x 41" x 15 1/2"H (11 lbs)

TB35 \$233
 Fabric tackboard, (COM, Grade A, Grade B) 3/4" x 35" x 15 1/2"H (10 lbs)



TL48 \$215
 Task light (UL approved), 6" x 48" x 1 1/2"H (15 lbs)

TL24 \$185
 Task light (UL approved), 6" x 24" x 1 1/2"H (10 lbs)

HERITAGE II SERIES

List Price

Hutches

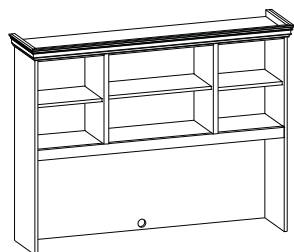

50HO81-O **\$3318**
 Overhead storage unit, open, three storage areas, one adjustable shelf per section, cornice top, two wire mgmt access grommets in center back panel
 23 1/2" clearance between apron rail & worksurface
 15 1/2" x 81" x 50"H (280 lbs)

50HO69-O **\$3089**
 Overhead storage unit, open, three storage areas, one adjustable shelf per section, cornice top, two wire mgmt access grommets in center back panel
 23 1/2" clearance between apron rail & worksurface
 15 1/2" x 69" x 50"H (210 lbs)

50HO63-O **\$2840**
 Overhead storage unit, open, three storage areas, one adjustable shelf per section, cornice top, two wire mgmt access grommets in center back panel
 23 1/2" clearance between apron rail & worksurface
 15 1/2" x 63" x 50"H (180 lbs)

50HO57-O **\$2590**
 Overhead storage unit, open, three storage areas, one adjustable shelf per section, cornice top, two wire mgmt access grommets in center back panel
 23 1/2" clearance between apron rail & worksurface
 15 1/2" x 57" x 50"H (165 lbs)

50HO81-W **\$4150**
 Overhead storage unit with hinged wood doors, three storage areas behind four hinged doors, one adjustable shelf per section, cornice top, two wire mgmt access grommets in center back panel
 23 1/2" clearance between apron rail & worksurface
 15 1/2" x 81" x 50"H (280 lbs)

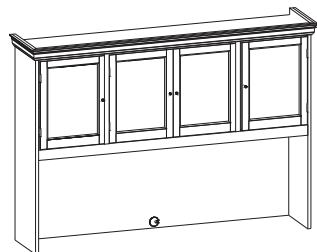

50HO69-W **\$3677**
 Overhead storage unit with hinged wood doors, three storage areas behind four hinged doors, one adjustable shelf per section, cornice top, two wire mgmt access grommets in center back panel
 23 1/2" clearance between apron rail & worksurface
 15 1/2" x 69" x 50"H (210 lbs)

50HO63-W **\$3455**
 Overhead storage unit with hinged wood doors, three storage areas behind four hinged doors, one adjustable shelf per section, cornice top, two wire mgmt access grommets in center back panel
 23 1/2" clearance between apron rail & worksurface
 15 1/2" x 63" x 50"H (180 lbs)

50HO57-W **\$3193**
 Overhead storage unit with hinged wood doors, three storage areas behind four hinged doors, one adjustable shelf per section, cornice top, two wire mgmt access grommets in center back panel
 23 1/2" clearance between apron rail & worksurface
 15 1/2" x 57" x 50"H (165 lbs)

Accessories



TB77 **\$474**
 Fabric tackboard, (COM, Grade A, Grade B) 3/4" x 77" x 15 1/2"H (20 lbs)

TB65 **\$400**
 Fabric tackboard, (COM, Grade A, Grade B) 3/4" x 65" x 15 1/2"H (16 lbs)

TB59 **\$386**
 Fabric tackboard, (COM, Grade A, Grade B) 3/4" x 59" x 15 1/2"H (14 lbs)

TB53 **\$341**
 Fabric tackboard, (COM, Grade A, Grade B) 3/4" x 53" x 15 1/2"H (12 lbs)



TL48 **\$215**
 Task light (UL approved), 6" x 48" x 1 1/2"H (15 lbs)

TL24 **\$185**
 Task light (UL approved), 6" x 24" x 1 1/2"H (10 lbs)

HERITAGE II SERIES

List Price

Hutches

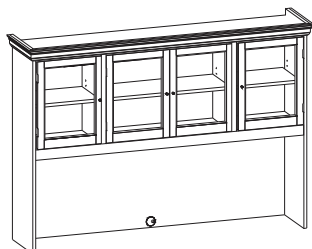

50HO81-G **\$3963**
 Overhead storage unit with hinged glass doors, three storage areas behind four hinged doors, one adjustable shelf per section, cornice top, two wire mgmt access grommets in center back panel
 23 1/2" clearance between apron rail & worksurface
 15 1/2" x 81" x 50"H (280 lbs)

50HO69-G **\$3609**
 Overhead storage unit with hinged glass doors, three storage areas behind four hinged doors, one adjustable shelf per section, cornice top, two wire mgmt access grommets in center back panel
 23 1/2" clearance between apron rail & worksurface
 15 1/2" x 69" x 50"H (210 lbs)

50HO63-G **\$3392**
 Overhead storage unit with hinged glass doors, three storage areas behind four hinged doors, one adjustable shelf per section, cornice top, two wire mgmt access grommets in center back panel
 23 1/2" clearance between apron rail & worksurface
 15 1/2" x 63" x 50"H (180 lbs)

50HO57-G **\$3204**
 Overhead storage unit with hinged glass doors, three storage areas behind four hinged doors, one adjustable shelf per section, cornice top, two wire mgmt access grommets in center back panel
 23 1/2" clearance between apron rail & worksurface
 15 1/2" x 57" x 50"H (165 lbs)

50HO81-M **\$4212**
 Overhead storage unit with hinged woven wire mesh doors, three storage areas behind four hinged doors, one adjustable shelf per section, cornice top, two wire mgmt access grommets in center back panel
 23 1/2" clearance between apron rail & worksurface
 15 1/2" x 81" x 50"H (280 lbs)

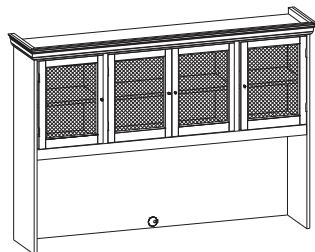

50HO69-M **\$4139**
 Overhead storage unit with hinged woven wire mesh doors, three storage areas behind four hinged doors, one adjustable shelf per section, cornice top, two wire mgmt access grommets in center back panel
 23 1/2" clearance between apron rail & worksurface
 15 1/2" x 69" x 50"H (210 lbs)

50HO63-M **\$3455**
 Overhead storage unit with hinged woven wire mesh doors, three storage areas behind four hinged doors, one adjustable shelf per section, cornice top, two wire mgmt access grommets in center back panel
 23 1/2" clearance between apron rail & worksurface
 15 1/2" x 63" x 50"H (180 lbs)

50HO57-M **\$3302**
 Overhead storage unit with hinged woven wire mesh doors, three storage areas behind four hinged doors, one adjustable shelf per section, cornice top, two wire mgmt access grommets in center back panel
 23 1/2" clearance between apron rail & worksurface
 15 1/2" x 57" x 50"H (165 lbs)

Accessories



TB77 **\$474**
 Fabric tackboard, (COM, Grade A, Grade B) 3/4" x 77" x 15 1/2"H (20 lbs)

TB65 **\$400**
 Fabric tackboard, (COM, Grade A, Grade B) 3/4" x 65" x 15 1/2"H (16 lbs)

TB59 **\$386**
 Fabric tackboard, (COM, Grade A, Grade B) 3/4" x 59" x 15 1/2"H (14 lbs)

TB53 **\$341**
 Fabric tackboard, (COM, Grade A, Grade B) 3/4" x 53" x 15 1/2"H (12 lbs)



TL48 **\$215**
 Task light (UL approved), 6" x 48" x 1 1/2"H (15 lbs)

TL24 **\$185**
 Task light (UL approved), 6" x 24" x 1 1/2"H (10 lbs)

HERITAGE II SERIES

List Price

Hutches

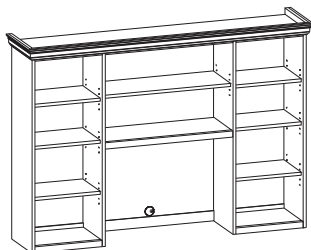

50HC81-O **\$4010**
 Open hutch, three storage areas, three adjustable shelves in outer sections, one adjustable shelf in center section, cornice top, two wire mgmt access grommets in center back panel
 23 1/2" clearance between apron rail & worksurface
 15 1/2" x 81" x 50"H (210 lbs)

50HC69-O **\$3505**
 Open hutch, three storage areas, three adjustable shelves in outer sections, one adjustable shelf in center section, cornice top, two wire mgmt access grommets in center back panel
 23 1/2" clearance between apron rail & worksurface
 15 1/2" x 69" x 50"H (210 lbs)

50HC63-O **\$3141**
 Open hutch, three storage areas, three adjustable shelves in outer sections, one adjustable shelf in center section, cornice top, two wire mgmt access grommets in center back panel
 23 1/2" clearance between apron rail & worksurface
 15 1/2" x 63" x 50"H (180 lbs)

50HC57-O **\$2850**
 Open hutch, three storage areas, three adjustable shelves in outer sections, one adjustable shelf in center section, cornice top, two wire mgmt access grommets in center back panel
 23 1/2" clearance between apron rail & worksurface
 15 1/2" x 57" x 50"H (165 lbs)

50HC81-W **\$5367**
 Hutch, hinged wooden doors (non-locking), three storage areas, three adjustable shelves in outer sections, one adjustable shelf in center section, cornice top, two wire mgmt access grommets in center back panel, 23 1/2" clearance between apron rail & worksurface
 15 1/2" x 81" x 50"H (280 lbs)

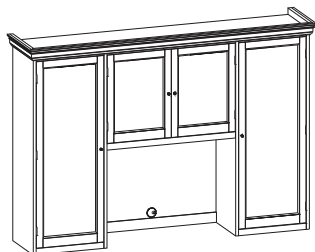

50HC69-W **\$4946**
 Hutch, hinged wooden doors (non-locking), three storage areas, three adjustable shelves in outer sections, one adjustable shelf in center section, cornice top, two wire mgmt access grommets in center back panel, 23 1/2" clearance between apron rail & worksurface
 15 1/2" x 69" x 50"H (210 lbs)

50HC63-W **\$4452**
 Hutch, hinged wooden doors (non-locking), three storage areas, three adjustable shelves in outer sections, one adjustable shelf in center section, cornice top, two wire mgmt access grommets in center back panel, 23 1/2" clearance between apron rail & worksurface
 15 1/2" x 63" x 50"H (180 lbs)

50HC57-W **\$4015**
 Hutch, hinged wooden doors (non-locking), three storage areas, three adjustable shelves in outer sections, one adjustable shelf in center section, cornice top, two wire mgmt access grommets in center back panel, 23 1/2" clearance between apron rail & worksurface
 15 1/2" x 57" x 50"H (165 lbs)

Accessories



TB43 **\$272**
 Fabric tackboard, (COM, Grade A, Grade B) 3/4" x 43" x 15 1/2"H (14 lbs)

TB31 **\$196**
 Fabric tackboard, (COM, Grade A, Grade B) 3/4" x 31" x 15 1/2"H (12 lbs)

TB25 **\$159**
 Fabric tackboard, (COM, Grade A, Grade B) 3/4" x 25" x 15 1/2"H (10 lbs)

TB19 **\$125**
 Fabric tackboard, (COM, Grade A, Grade B) 3/4" x 19" x 15 1/2"H (8 lbs)



TL48 **\$215**
 Task light (UL approved), 6" x 48" x 1 1/2"H (15 lbs)

TL24 **\$185**
 Task light (UL approved), 6" x 24" x 1 1/2"H (10 lbs)

HERITAGE II SERIES

List Price

Hutches

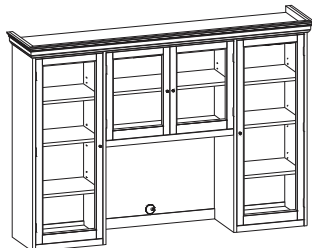

50HC81-G **\$5076**
 Hutch, hinged glass doors (non-locking), three storage areas, three adjustable shelves in outer sections, one adjustable shelf in center section, cornice top, two wire mgmt access grommets in center back panel, 23 1/2" clearance between apron rail & worksurface
 15 1/2" x 81" x 50"H (280 lbs)

50HC69-G **\$4628**
 Hutch, hinged glass doors (non-locking), three storage areas, three adjustable shelves in outer sections, one adjustable shelf in center section, cornice top, two wire mgmt access grommets in center back panel, 23 1/2" clearance between apron rail & worksurface
 15 1/2" x 69" x 50"H (210 lbs)

50HC63-G **\$4244**
 Hutch, hinged glass doors (non-locking), three storage areas, three adjustable shelves in outer sections, one adjustable shelf in center section, cornice top, two wire mgmt access grommets in center back panel, 23 1/2" clearance between apron rail & worksurface
 15 1/2" x 63" x 50"H (180 lbs)

50HC57-G **\$4020**
 Hutch, hinged glass doors (non-locking), three storage areas, three adjustable shelves in outer sections, one adjustable shelf in center section, cornice top, two wire mgmt access grommets in center back panel, 23 1/2" clearance between apron rail & worksurface
 15 1/2" x 57" x 50"H (165 lbs)

50HC81-M **\$5731**
 Hutch, hinged woven mesh doors (non-locking), three storage areas, three adjustable shelves in outer sections, one adjustable shelf in center section, cornice top, two wire mgmt access grommets in center back panel, 23 1/2" clearance between apron rail & worksurface
 15 1/2" x 81" x 50"H (280 lbs)

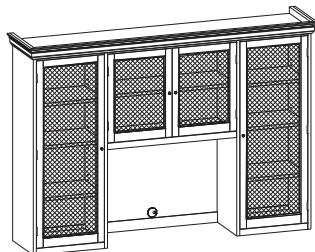

50HC69-M **\$5492**
 Hutch, hinged woven mesh doors (non-locking), three storage areas, three adjustable shelves in outer sections, one adjustable shelf in center section, cornice top, two wire mgmt access grommets in center back panel, 23 1/2" clearance between apron rail & worksurface
 15 1/2" x 69" x 50"H (210 lbs)

50HC63-M **\$5153**
 Hutch, hinged woven mesh doors (non-locking), three storage areas, three adjustable shelves in outer sections, one adjustable shelf in center section, cornice top, two wire mgmt access grommets in center back panel, 23 1/2" clearance between apron rail & worksurface
 15 1/2" x 63" x 50"H (180 lbs)

50HC57-M **\$4821**
 Hutch, hinged woven mesh doors (non-locking), three storage areas, three adjustable shelves in outer sections, one adjustable shelf in center section, cornice top, two wire mgmt access grommets in center back panel, 23 1/2" clearance between apron rail & worksurface
 15 1/2" x 57" x 50"H (165 lbs)

Accessories



TB43 **\$272**
 Fabric tackboard, (COM, Grade A, Grade B) 3/4" x 43" x 15 1/2"H (14 lbs)

TB31 **\$196**
 Fabric tackboard, (COM, Grade A, Grade B) 3/4" x 31" x 15 1/2"H (12 lbs)

TB25 **\$159**
 Fabric tackboard, (COM, Grade A, Grade B) 3/4" x 25" x 15 1/2"H (10 lbs)

TB19 **\$125**
 Fabric tackboard, (COM, Grade A, Grade B) 3/4" x 19" x 15 1/2"H (8 lbs)



TL48 **\$215**
 Task light (UL approved), 6" x 48" x 1 1/2"H (15 lbs)

TL24 **\$185**
 Task light (UL approved), 6" x 24" x 1 1/2"H (10 lbs)

HERITAGE II SERIES

List Price

Hutches

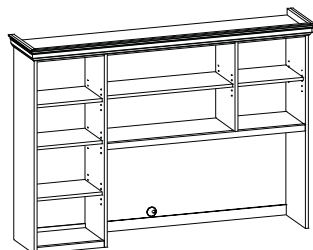

50HR81-O (right) **\$3599**

50HL81-O (left - shown)

Open hutch, three storage areas, three adjustable shelves in outer riser section, one adjustable shelf in each upper overhead section, cornice top, two wire mgmt access grommets in center back panel
23 1/2" clearance between apron rail & worksurface
15 1/2" x 81" x 50"H (lbs)

50HR69-O (right) **\$3011**

50HL69-O (left - shown)

Open hutch, three storage areas, three adjustable shelves in outer riser section, one adjustable shelf in each upper overhead section, cornice top, two wire mgmt access grommets in center back panel
23 1/2" clearance between apron rail & worksurface
15 1/2" x 69" x 50"H (lbs)

50HR63-O (right) **\$2798**

50HL63-O (left - shown)

Open hutch, three storage areas, three adjustable shelves in outer riser section, one adjustable shelf in each upper overhead section, cornice top, two wire mgmt access grommets in center back panel
23 1/2" clearance between apron rail & worksurface
15 1/2" x 63" x 50"H (lbs)

50HR57-O (right) **\$2465**

50HL57-O (left - shown)

Open hutch, three storage areas, three adjustable shelves in outer riser section, one adjustable shelf in each upper overhead section, cornice top, two wire mgmt access grommets in center back panel
23 1/2" clearance between apron rail & worksurface
15 1/2" x 57" x 50"H (lbs)

50HR81-W (right) **\$4961**

50HL81-W (left - shown)

Hutch, hinged wooden doors (non-locking), three storage areas, three adjustable shelves in outer riser section, one adjustable shelf in each upper overhead section, cornice top, two wire mgmt access grommets in center back panel, 23 1/2" clearance between apron rail & worksurface
15 1/2" x 81" x 50"H (lbs)

50HR69-W (right) **\$4244**

50HL69-W (left - shown)

Hutch, hinged wooden doors (non-locking), three storage areas, three adjustable shelves in outer riser section, one adjustable shelf in each upper overhead section, cornice top, two wire mgmt access grommets in center back panel, 23 1/2" clearance between apron rail & worksurface
15 1/2" x 69" x 50"H (lbs)

50HR63-W (right) **\$3807**

50HL63-W (left - shown)

Hutch, hinged wooden doors (non-locking), three storage areas, three adjustable shelves in outer riser section, one adjustable shelf in each upper overhead section, cornice top, two wire mgmt access grommets in center back panel, 23 1/2" clearance between apron rail & worksurface
15 1/2" x 63" x 50"H (lbs)

50HR57-W (right) **\$3547**

50HL57-W (left - shown)

Hutch, hinged wooden doors (non-locking), three storage areas, three adjustable shelves in outer riser section, one adjustable shelf in each upper overhead section, cornice top, two wire mgmt access grommets in center back panel, 23 1/2" clearance between apron rail & worksurface
15 1/2" x 57" x 50"H (lbs)

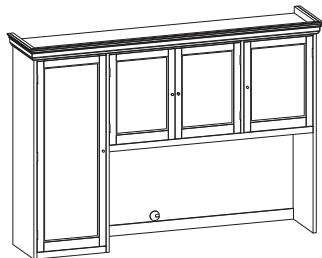

Accessories



TB59 **\$386**

Fabric tackboard, (COM, Grade A, Grade B) 3/4" x 59" x 15 1/2"H (14 lbs)

TB47 **\$338**

Fabric tackboard, (COM, Grade A, Grade B) 3/4" x 47" x 15 1/2"H (16 lbs)

TB41 **\$272**

Fabric tackboard, (COM, Grade A, Grade B) 3/4" x 41" x 15 1/2"H (11 lbs)

TB36 **\$233**

Fabric tackboard, (COM, Grade A, Grade B) 3/4" x 36" x 15 1/2"H (10 lbs)



TL48 **\$215**

Task light (UL approved), 6" x 48" x 1 1/2"H (15 lbs)

TL24 **\$185**

Task light (UL approved), 6" x 24" x 1 1/2"H (10 lbs)

HERITAGE II SERIES

List Price

Hutches

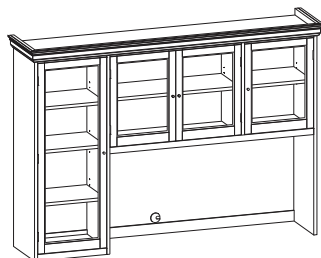

50HR81-G (right) \$4410
50HL81-G (left - shown)
 Hutch, hinged glass doors (non-locking), three storage areas, three adjustable shelves in outer riser section, one adjustable shelf in each upper overhead section, cornice top, two wire mgmt access grommets in center back panel, 23 1/2" clearance between apron rail & worksurface
 15 1/2" x 81" x 50"H (lbs)

50HR69-G (right) \$3942
50HL69-G (left - shown)
 Hutch, hinged glass doors (non-locking), three storage areas, three adjustable shelves in outer riser section, one adjustable shelf in each upper overhead section, cornice top, two wire mgmt access grommets in center back panel, 23 1/2" clearance between apron rail & worksurface
 15 1/2" x 69" x 50"H (lbs)

50HR63-G (right) \$3692
50HL63-G (left - shown)
 Hutch, hinged glass doors (non-locking), three storage areas, three adjustable shelves in outer riser section, one adjustable shelf in each upper overhead section, cornice top, two wire mgmt access grommets in center back panel, 23 1/2" clearance between apron rail & worksurface
 15 1/2" x 63" x 50"H (lbs)

50HR57-G (right) \$3256
50HL57-G (left - shown)
 Hutch, hinged glass doors (non-locking), three storage areas, three adjustable shelves in outer riser section, one adjustable shelf in each upper overhead section, cornice top, two wire mgmt access grommets in center back panel, 23 1/2" clearance between apron rail & worksurface
 15 1/2" x 57" x 50"H (lbs)

50HR81-M (right) \$5502
50HL81-M (left - shown)
 Hutch, hinged woven wire mesh doors (non-locking), three storage areas, three adjustable shelves in outer riser section, one adjustable shelf in each upper overhead section, cornice top, two wire mgmt access grommets in center back panel, 23 1/2" clearance between apron rail & worksurface
 15 1/2" x 81" x 50"H (lbs)

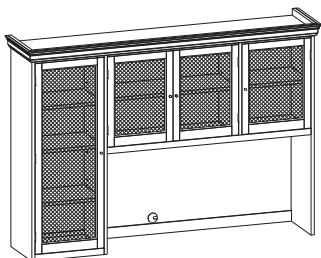

50HR69-M (right) \$4847
50HL69-M (left - shown)
 Hutch, hinged woven wire mesh doors (non-locking), three storage areas, three adjustable shelves in outer riser section, one adjustable shelf in each upper overhead section, cornice top, two wire mgmt access grommets in center back panel, 23 1/2" clearance between apron rail & worksurface
 15 1/2" x 69" x 50"H (lbs)

50HR63-M (right) \$4462
50HL63-M (left - shown)
 Hutch, hinged woven wire mesh doors (non-locking), three storage areas, three adjustable shelves in outer riser section, one adjustable shelf in each upper overhead section, cornice top, two wire mgmt access grommets in center back panel, 23 1/2" clearance between apron rail & worksurface
 15 1/2" x 63" x 50"H (lbs)

50HR57-M (right) \$4098
50HL57-M (left - shown)
 Hutch, hinged woven wire mesh doors (non-locking), three storage areas, three adjustable shelves in outer riser section, one adjustable shelf in each upper overhead section, cornice top, two wire mgmt access grommets in center back panel, 23 1/2" clearance between apron rail & worksurface
 15 1/2" x 57" x 50"H (lbs)

Accessories



TB59 \$386
 Fabric tackboard, (COM, Grade A, Grade B) 3/4" x 59" x 15 1/2"H (14 lbs)

TB47 \$338
 Fabric tackboard, (COM, Grade A, Grade B) 3/4" x 47" x 15 1/2"H (16 lbs)

TB41 \$272
 Fabric tackboard, (COM, Grade A, Grade B) 3/4" x 41" x 15 1/2"H (11 lbs)

TB36 \$233
 Fabric tackboard, (COM, Grade A, Grade B) 3/4" x 36" x 15 1/2"H (10 lbs)



TL48 \$215
 Task light (UL approved), 6" x 48" x 1 1/2"H (15 lbs)

TL24 \$185
 Task light (UL approved), 6" x 24" x 1 1/2"H (10 lbs)

HERITAGE II SERIES

List Price

Bookcases

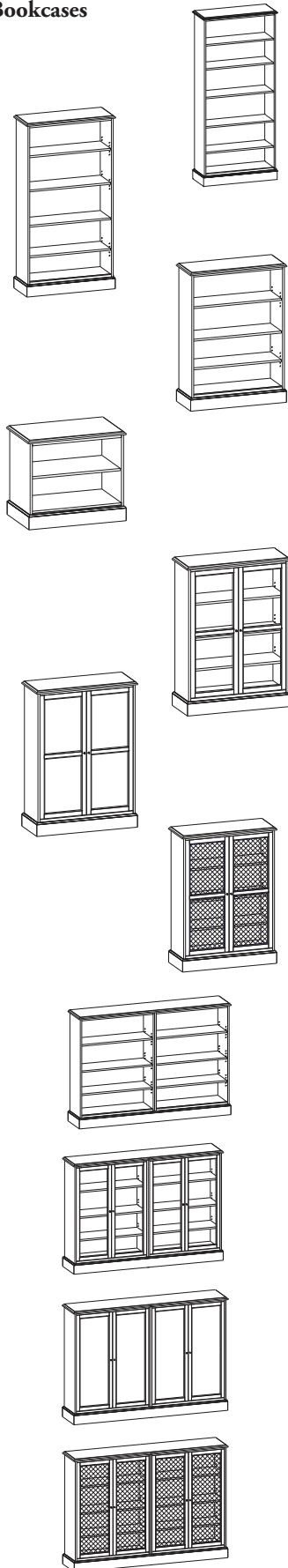

50BCO-84_ _ \$2417
 Open bookcase with four adjustable and two fixed shelves (bottom & middle)
 15 1/2" x 38" x 84"H (225 lbs) ****unit must be permanently attached to wall**

50BCO-72_ _ \$2384
 Open bookcase with three adjustable and two fixed shelves (bottom & middle)
 15 1/2" x 38" x 72"H (196 lbs)

50BCO-52_ _ \$1527
 Open bookcase with three adjustable and one fixed shelf (bottom)
 15 1/2" x 38" x 52"H (140 lbs)

50BCO-30_ _ \$1025
 Open bookcase with one adjustable and one fixed shelf (bottom)
 21" x 30 1/2" x 30"H (85 lbs)

50BC-G_ _ \$2128
 Bookcase with glass doors (non-locking), three adjustable shelves and one fixed shelf (bottom)
 15 1/2" x 38" x 52"H (150 lbs)

50BC-W_ _ \$2265
 Bookcase with wood doors (non-locking), three adjustable shelves and one fixed shelf (bottom)
 15 1/2" x 38" x 52"H (150 lbs)

50BC-M_ _ \$2715
 Bookcase with woven wire mesh grille doors (non-locking), three adjustable shelves and one fixed shelf (bottom)
 15 1/2" x 38" x 52"H (150 lbs)

50BC2-O_ _ \$3308
 Double unit open bookcase with three adjustable shelves and one fixed shelf (bottom), in each section
 15 1/2" x 60" x 52"H (230 lbs)

50BC2-G_ _ \$4033
 Double unit bookcase with glass doors, three adjustable shelves and one fixed shelf (bottom), in each section
 15 1/2" x 60" x 52"H (250 lbs)

50BC2-W_ _ \$4384
 Double unit bookcase with wood doors, three adjustable shelves and one fixed shelf (bottom), in each section
 15 1/2" x 60" x 52"H (250 lbs)

50BC2-M_ _ \$4556
 Double unit bookcase with woven wire mesh grille doors, three adjustable shelves and one fixed shelf (bottom), in each section
 15 1/2" x 60" x 52"H (250 lbs)

HERITAGE II SERIES

List Price

Hutches

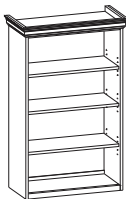

| | | |
|--------------------|---|---------------|
| 50OSU1-32-O | Open (shown) | \$1486 |
| 50OSU1-32-G | Glass doors (non-locking) | \$2070 |
| 50OSU1-32-W | Wood doors (non-locking) | \$2226 |
| 50OSU1-32-M | Woven wire mesh grille doors (non-locking) | \$2476 |

Single unit hutch with three adjustable shelves per section, cornice top
 **properly fits on 32" wide lower unit
 15 1/2" x 31 1/2" x 50"H (110 lbs)
 Optional locking doors (LK) - add \$55 list per set of doors

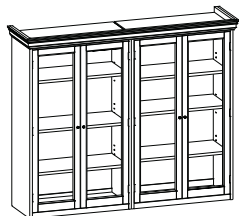

| | | |
|--------------------|---|---------------|
| 50OSU2-60-O | Open | \$3131 |
| 50OSU2-60-G | Glass doors (non-locking) (shown) | \$4030 |
| 50OSU2-60-W | Wood doors (non-locking) | \$4358 |
| 50OSU2-60-M | Woven wire mesh grille doors (non-locking) | \$4764 |

Double unit hutch with three adjustable shelves per section, cornice top
 **properly fits on 60" wide lower unit
 **ships in three (3) pieces
 15 1/2" x 59 1/2" x 50"H (220 lbs)
 Optional locking doors (LK) - add \$55 list per set of doors

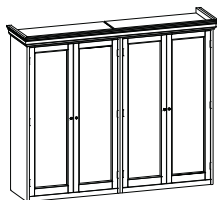

| | | |
|--------------------|---|---------------|
| 50OSU2-66-O | Open | \$3453 |
| 50OSU2-66-G | Glass doors (non-locking) | \$4348 |
| 50OSU2-66-W | Wood doors (non-locking) (shown) | \$4602 |
| 50OSU2-66-M | Woven wire mesh grille doors (non-locking) | \$5003 |

Double unit hutch with three adjustable shelves per section, cornice top
 **properly fits on 66" wide lower unit
 **ships in three (3) pieces
 15 1/2" x 65 1/2" x 50"H (250 lbs)
 Optional locking doors (LK) - add \$55 list per set of doors

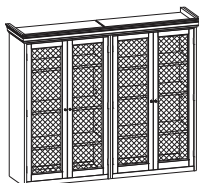

| | | |
|--------------------|---|---------------|
| 50OSU2-72-O | Open | \$3828 |
| 50OSU2-72-G | Glass doors (non-locking) | \$4722 |
| 50OSU2-72-W | Wood doors (non-locking) | \$4961 |
| 50OSU2-72-M | Woven wire mesh grille doors (non-locking) (shown) | \$5388 |

Double unit hutch with three adjustable shelves per section, cornice top
 **properly fits on 72" wide lower unit
 **ships in three (3) pieces
 15 1/2" x 71 1/2" x 50"H (275 lbs)
 Optional locking doors (LK) - add \$55 list per set of doors

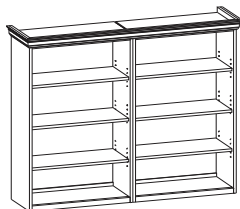

| | | |
|--------------------|---|---------------|
| 50OSU2-84-O | Open (shown) | \$4176 |
| 50OSU2-84-G | Glass doors (non-locking) | \$5076 |
| 50OSU2-84-W | Wood doors (non-locking) | \$5346 |
| 50OSU2-84-M | Woven wire mesh grille doors (non-locking) | \$5726 |

Double unit hutch with three adjustable shelves per section, cornice top
 **properly fits on 84" wide lower unit
 **ships in three (3) pieces
 15 1/2" x 83 1/2" x 50"H (300 lbs)
 Optional locking doors (LK) - add \$55 list per set of doors

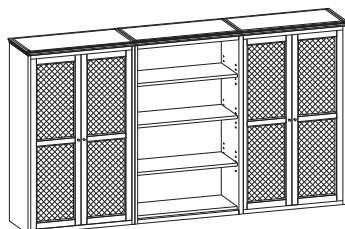

| | | |
|----------------------|---|---------------|
| 50OSU3-90-O | Open | \$4535 |
| 50OSU3-90-G | Glass doors (non-locking) | \$6246 |
| 50OSU3-90-GOG | Glass doors/Open/Glass doors (non-locking) | \$5700 |
| 50OSU3-90-W | Wood doors (non-locking) | \$6673 |
| 50OSU3-90-WOW | Wood/Open/Wood doors (non-locking) | \$5798 |
| 50OSU3-90-M | Woven wire mesh grille doors (non-locking) | \$6885 |
| 50OSU3-90-MOM | Wire mesh/Open/Wire mesh (non-locking) (shown) | \$6428 |

Triple unit hutch with three adjustable shelves per section, cornice top
 **properly fits on 90" wide lower unit
 **ships in four (4) pieces
 15 1/2" x 89 1/2" x 50"H (350 lbs)
 Optional locking doors (LK) - add \$55 list per set of doors

HERITAGE II SERIES

List Price

Accessories

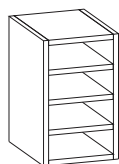

50PSA
 Portable work organizer, with three paper trays
 15" x 12" x 17"H (20 lbs)

\$588

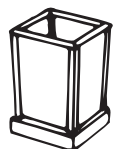

50WB
 Wastebasket, wooden
 12" x 12" x 16"H (14 lbs)

\$538



50C
 Costumer, turned post, solid wood
 66"H (15 lbs)

\$544

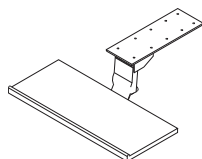

AKPW
 Articulating keyboard - leverless, with non- handed mouse pad, 5" height adjustment, 25 degree tilt - 360 degree swivel, wooden keyboard tray - specify finish
 11 1/4" x 21 1/2" x 2 3/4"H (25 lbs)

\$472

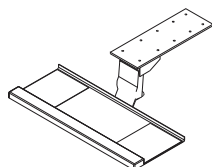

AKP
 Articulating keyboard - leverless, with non- handed mouse pad, 5" height adjustment, 25 degree tilt - 360 degree swivel, black molded keyboard tray
 11" x 25" x 2 3/4"H (21 lbs)

\$337

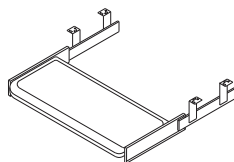

KD
 Pull-out keyboard - leverless, black molded keyboard tray
 10 5/8" x 21 1/2" x 3 5/8"H (8 lbs)

\$153



LH
 Wire mgmt channel, 22" length - set of four, double sided velcro attachment

\$83

Communique J A S P E R D E S K

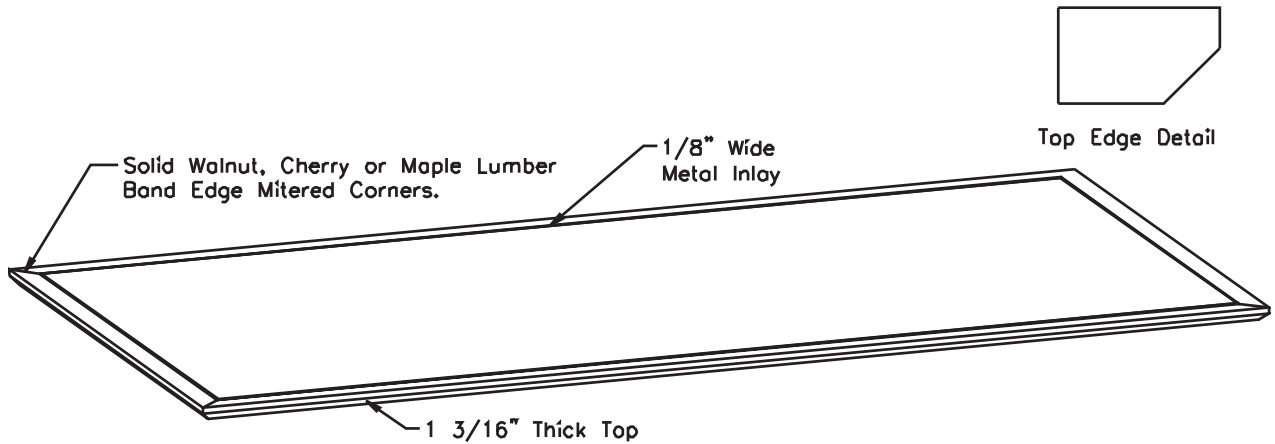

Square Bases Available in 3 Sizes
18", 24", and 30" SQ. 28 1/4" Tall

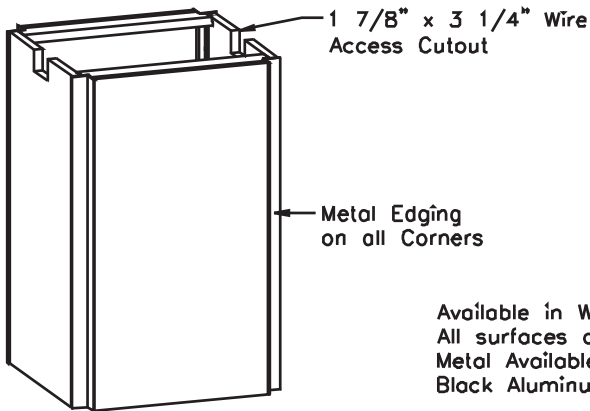

Panel Bases Available in 3 Sizes
18", 24", and 30" x 7" Wide
28 1/4" Tall

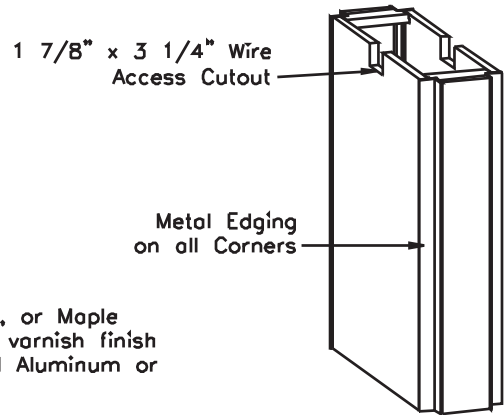

Available in Walnut, Cherry, or Maple
All surfaces are catalyzed varnish finish
Metal Available in Anodized Aluminum or Black Aluminum

**Bases can be specified with an optional access door
add \$193 per base - Must be specified when placing
order**

Communique

J A S P E R D E S K

PRODUCT SPECIFICATIONS

Veneers

Veneer on all exposed surfaces are select plain sliced American Black Walnut, Cherry or Maple. Outside surface veneers are bookmatched to provide proper grain consistency. Drawer fronts are vertical grain and matched in selected sets to insure proper veneer balance. Inside faces of end panels and back panels are random matched.

Conference Table Tops

Tops are 1 3/16" thick, 3-ply construction with solid walnut, cherry or maple rims on all four sides with a reverse bevel profile.

End Panels

End panels are 1" thick, 3-ply construction with veneer band on vertical edges and along the top edge. Wing end panels feature a solid lumber band on the bottom edge of the panel to prevent glide tear out.

Drawers

Drawer sides and backs are solid lumber beech 7/16" thick. Drawer fronts are 3-ply construction, 3/4" thick. Drawer bottoms are of 3-ply hardwood construction. Drawers are assembled with dovetail construction in all four corners of the drawer box. Fronts are securely mounted onto the drawer box. Drawer pulls are standard on pedestals. There are two finish options available: Black and Anodized Aluminum.

Hardware

Drawer Suspensions - all drawers utilize steel "A" grade heavy duty metal slides and feature cushioned in and out stops for smooth operation. All file drawers have 100% full extension slides.

Locking

Pedestals are pedestal locking keyed randomly. Locking on some units may be optional.

Electrical Accessories

Power Accessories - Jasper Desk offers power, communication, and wire management products to address today's office needs. Pleaser refer to pages 340-341 for information on these products.

Chassis Construction

Construction technique is mortise and tenon, groove and tenon, heavily glue blocked for maximum strength.

Filing

File drawers use an easily adjustable filing system which can be positioned to accommodate letter or legal filing.

Finish

All surfaces are catalyzed varnish full fill finish to ensure maximum durability, chemical resistance, color retention, and clarity. All exterior surfaces are finished in the following multi-step sequence: sap stain, NGR stain, washcoat, washcoat sand, filler spray and wipe, sealer spray, sealer sand, varnish spray, varnish sand and varnish spray.

Drawer interiors and exteriors are finished with sealer, sealer sand, and varnished.

Communique
J A S P E R D E S K



Communique conference room furniture features either a black or anodized aluminum metal inlay. This product enhancement is standard on all media walls, upper side cabinets, buffet credenzas, media cabinets and tables.

However, for table tops only, without metal inlay, there is an option for a price deduction (NI after model number) if this feature is not required. The metal inlay is 1/8" wide and has a minimal (3/32") rise above the top surface. Panel base (PB) and square base (SB) have a metal edging on all corners, and as with the top, must be specified in either black (LX) or Aluminum (AL).

Ordering Examples

1500VT120PB - AL - Natural Walnut

Walnut Vision Table with aluminum inlay-panel bases with aluminum accent

1500VT120PB - NI - LX - Natural Walnut

Walnut Vision Table - no metal inlay in top - panel base with black metal accent

Communique

J A S P E R D E S K

For top and base designate metal inlay finish after model #
 LX - Black AL - Aluminum

Designate Wood Species before Model #
 00 - Walnut 20 - Cherry 30 - Maple

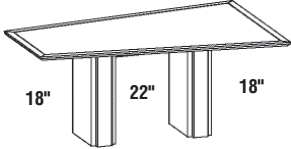
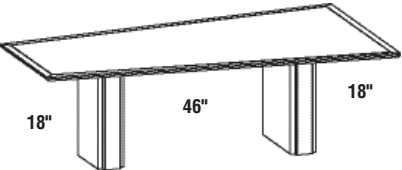
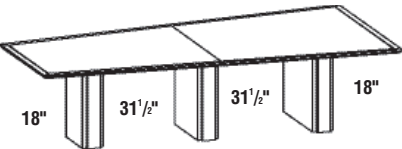
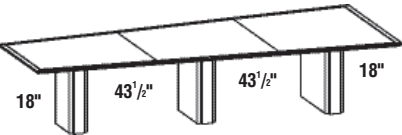
| Model # | Description/Dimension | Wood Finishes | Price |
|--|---|--|----------------------------------|
| Vision Tables Panel Bases 1500VT72PB__ 218 lbs. | Vision Table - 6 ft. 72" length x 30" high 48" wide one end 30" wide narrow end One piece top Two panel bases Seats 5-7 Bases L to R 18"D x 7"W 18"D x 7"W 22" between bases 18" at ends | Walnut Natural Walnut Royale Walnut Richleigh Walnut Empire Walnut Old World Mahogany Crescent Cherry on Walnut Espresso | \$4569 \$3883 no top inlay |
|  | Vision Table - 8 ft. 96" length x 30" high 54" wide one end 36" wide narrow end One piece top Two panel bases Seats 7-9 Bases L to R 18"D x 7"W 24"D x 7"W 46" between bases 18" at ends | Cherry Natural Cherry Amber Cherry Cinnamon Cherry Collectors Cherry Mocha Cherry Mahogany on Cherry | \$5094 \$4331 no top inlay |
| 1500VT96PB__ 303 lbs. |  | Maple Sunrise | |
| 1500VT120PB__ 373 lbs. | Vision Table - 10 ft. 120" length x 30" high 60" wide narrowing down to 42" Two piece top Three panel bases Seats 9-11 Bases L to R 18"D x 7"W 24"D x 7"W 30"D x 7"W 31 1/2" between bases 18" at ends | | \$5931 \$5041 no top inlay |
|  | Vision Table - 12 ft. 144" length x 30" high 60" wide narrowing down to 42" Three piece top Three panel bases Seats 11-13 Bases L to R 18"D x 7"W 24"D x 7"W 30"D x 7"W 43 1/2" between bases 18" at ends | | \$6582 \$5595 no top inlay |
| 1500VT144PB__ 435 lbs. |  | | |

Communique

J A S P E R D E S K

For top and base designate metal inlay finish after model #
 LX - Black AL - Aluminum

Designate Wood Species before Model #
 00 - Walnut 20 - Cherry 30 - Maple

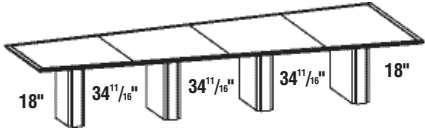
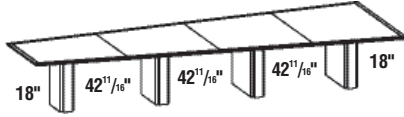
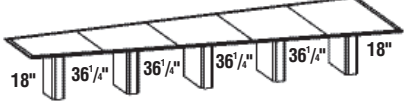
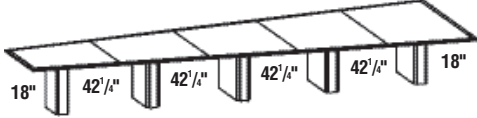
| | Model # | Description/Dimension | Wood Finishes | Price |
|------------------------------|---|--|--|-----------------------------------|
| Vision Tables Panel Bases | 1500VT168PB_ _ 588 lbs. | Vision Table - 14 ft. 168" length x 30" high 66" wide narrowing down to 42" Four piece top Four panel bases Seats 13-15 <u>Bases L to R</u> 18"D x 7"W 24"D x 7"W 24"D x 7"W 30"D x 7"W 34 ¹¹ / ₁₆ " between bases 18" at ends | Walnut Natural Walnut Royale Walnut Richleigh Walnut Empire Walnut Old World Mahogany Crescent Cherry on Walnut Espresso | \$7946 \$6755 no top inlay |
| |  | | | |
| | 1500VT192PB_ _ 668 lbs. | Vision Table - 16 ft. 192" length x 30" high 72" wide narrowing down to 42" Four piece top Four panel bases Seats 15-17 <u>Bases L to R</u> 18"D x 7"W 24"D x 7"W 30"D x 7"W 30"D x 7"W 42 ¹¹ / ₁₆ " between bases 18" at ends | Cherry Natural Cherry Amber Cherry Cinnamon Cherry Collectors Cherry Mocha Cherry Mahogany on Cherry | \$8349 \$7096 no top inlay |
| |  | | Maple Sunrise | |
| | 1500VT216PB_ _ 756 lbs. | Vision Table - 18 ft. 216" length x 30" high 78" wide narrowing down to 42" Five piece top Five panel bases Seats 17-19 <u>Bases L to R</u> 18"D x 7"W 24"D x 7"W 30"D x 7"W 30"D x 7"W 30"D x 7"W 36 ¹ / ₄ " between bases 18" at ends | | \$9617 \$8175 no top inlay |
| |  | | | |
| | 1500VT240PB_ _ 803 lbs. | Vision Table - 20 ft. 240" length x 30" high 84" wide narrowing down to 42" Five piece top Five panel bases Seats 19-21 <u>Bases L to R</u> 18"D x 7"W 24"D x 7"W 30"D x 7"W 30"D x 7"W 30"D x 7"W 42 ¹ / ₄ " between bases 18" at ends | | \$10015 \$8513 no top inlay |
| |  | | | |

Communique

J A S P E R D E S K

Designate Wood Species before Model #

00 - Walnut 20 - Cherry 30 - Maple

For top and base designate metal inlay finish after model #

LX - Black AL - Aluminum

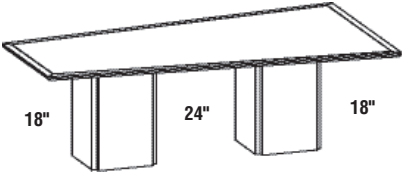
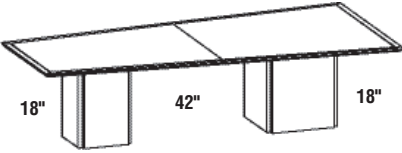
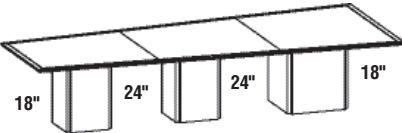
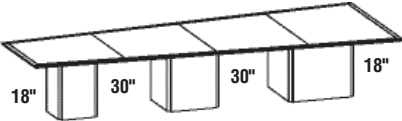
| Model # | Description/Dimension | Wood Finishes | Price |
|--|---|--|---|
| Vision Tables Square Bases | | | |
| 1500VT96SB__ 316 lbs. | Vision Table - 8 ft. 96" length x 30" high 54" wide one end 36" wide narrow end One piece top Two square bases Seats 7-9 Bases L to R 18"D x 18"W 18"D x 18"W 24" between bases 18" at ends | Walnut Natural Walnut Royale Walnut Richleigh Walnut Empire Walnut Old World Mahogany Crescent Cherry on Walnut Espresso | \$5140 \$4368 no top inlay |
|  | | | |
| 1500VT120SB__ 368 lbs. | Vision Table - 10 ft. 120" length x 30" high 60" wide narrowing down to 42" Two piece top Two square bases Seats 9-11 Bases L to R 18"D x 18"W 24"D x 24"W 42" between bases 18" at ends | Cherry Natural Cherry Amber Cherry Cinnamon Cherry Collectors Cherry Mocha Cherry Mahogany on Cherry | \$5734 \$4875 no top inlay |
|  | | Maple Sunrise | |
| 1500VT144SB__ 466 lbs. | Vision Table - 12 ft. 144" length x 30" high 60" wide narrowing down to 42" Three piece top Three square bases Seats 11-13 Bases L to R 18"D x 18"W 18"D x 18"W 24"D x 24"W 24" between bases 18" at ends | | \$6557 \$5574 no top inlay |
|  | | | |
| 1500VT168SB__ 574 lbs. | Vision Table - 14 ft. 168" length x 30" high 66" wide narrowing down to 42" Four piece top Three square bases Seats 13-15 Bases L to R 18"D x 18"W 24"D x 24"W 30"D x 30"W 30" between bases 18" at ends | | \$7653 \$6505 no top inlay |
|  | | | |

Communique

J A S P E R D E S K

For top and base designate metal inlay finish after model #
 LX - Black AL - Aluminum

Designate Wood Species before Model #
 00 - Walnut 20 - Cherry 30 - Maple

| Model # | Description/Dimension | Wood Finishes | Price |
|---------|-----------------------|---------------|-------|
|---------|-----------------------|---------------|-------|

Vision Tables
 Square Bases

1500VT192SB_ _
 714 lbs.

Vision Table - 16 ft.
192" length x 30" high
72" wide narrowing down to 42"
 Four piece top
 Three square bases
 Seats 15-17
Bases L to R
 18"D x 18"W
 24"D x 24"W
 30"D x 30"W
 42" between bases
 18" at ends

Walnut
 Natural Walnut
 Royale Walnut
 Richleigh Walnut
 Empire Walnut
 Old World Mahogany
 Crescent Cherry on Walnut
 Espresso

\$8041

\$6834
 no top inlay

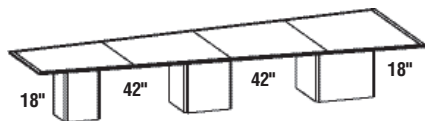

Cherry
 Natural Cherry
 Amber Cherry
 Cinnamon Cherry
 Collectors Cherry
 Mocha Cherry
 Mahogany on Cherry

Maple
 Sunrise

1500VT216SB_ _
 764 lbs.

Vision Table - 18 ft.
216" length x 30" high
78" wide narrowing down to 42"
 Five piece top
 Four square bases
 Seats 17-19
Bases L to R
 18"D x 18"W
 18"D x 18"W
 24"D x 24"W
 30"D x 30"W
 30" between bases
 18" at ends

\$9195

\$7816
 no top inlay

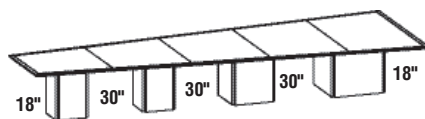

1500VT240SB_ _
 852 lbs.

Vision Table - 20 ft.
240" length x 30" high
84" wide narrowing down to 42"
 Five piece top
 Four square bases
 Seats 19-21
Bases L to R
 18"D x 18"W
 18"D x 18"W
 24"D x 24"W
 30"D x 30"W
 38" between bases
 18" at ends

\$10665

\$9064
 no top inlay

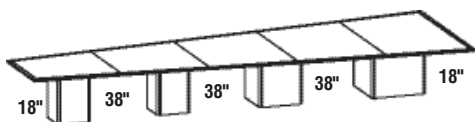

Communique

J A S P E R D E S K

Designate Wood Species before Model #
00 - Walnut 20 - Cherry 30 - Maple

For top and base designate metal
inlay finish after model #
LX - Black AL - Aluminum

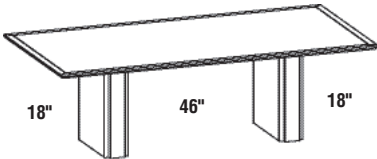
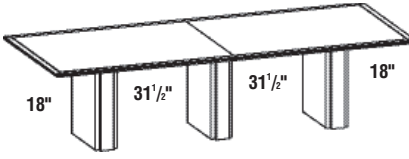
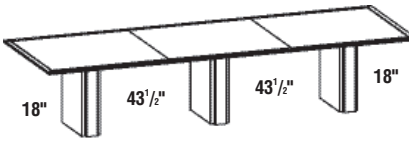
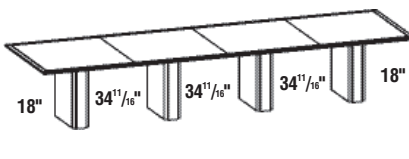
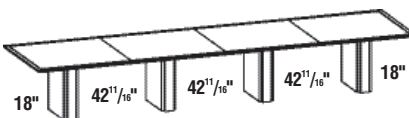
| Model # | Description/Dimension | Wood Finishes | Price |
|---|--|---|----------------------------------|
| Rectangular Tables Panel Bases | 8 ft. Conference Table 96"W x 48"D x 30"H One piece top Two panel bases Seats 8 Bases 2 - 24"D x 7"W 46" between bases 18" at ends | Walnut Natural Walnut Royale Walnut Richleigh Walnut Empire Walnut Old World Mahogany Crescent Cherry on Walnut Espresso | \$5034 \$4279 no top inlay |
|  | | | |
| 1500RET96PB_ _ 260 lbs. | | | |
| 10 ft. Conference Table 120"W x 48"D x 30"H Two piece top Three panel bases Seats 10 Bases 3 - 24"D x 7"W 31 1/2" between bases 18" at ends | Cherry Natural Cherry Amber Cherry Cinnamon Cherry Collectors Cherry Mocha Cherry Mahogany on Cherry | \$5742 \$4881 no top inlay | |
|  | | | |
| 1500RET120PB_ _ 364 lbs. | | | |
| 12 ft. Conference Table 144"W x 48"D x 30"H Three piece top Three panel bases Seats 12 Bases 3 - 24"D x 7"W 43 1/2" between bases 18" at ends | Maple Sunrise | \$6366 \$5412 no top inlay | |
|  | | | |
| 1500RET144PB_ _ 414 lbs. | | | |
| 14 ft. Conference Table 168"W x 48"D x 30"H Four piece top Four panel bases Seats 14 Bases 4 - 24"D x 7"W 34 11/16" between bases 18" at ends | | \$7633 \$6489 no top inlay | |
|  | | | |
| 1500RET168PB_ _ 502 lbs. | | | |
| 16 ft. Conference Table 192"W x 48"D x 30"H Four piece top Four panel bases Seats 16 Bases 4 - 24"D x 7"W 42 11/16" between bases 18" at ends | | \$7887 \$6703 no top inlay | |
|  | | | |
| 1500RET192PB_ _ 552 lbs. | | | |

Communique

J A S P E R D E S K

For top and base designate metal inlay finish after model #
 LX - Black AL - Aluminum

Designate Wood Species before Model #
 00 - Walnut 20 - Cherry 30 - Maple

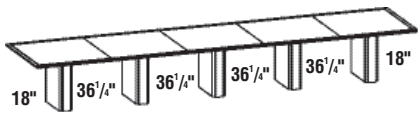
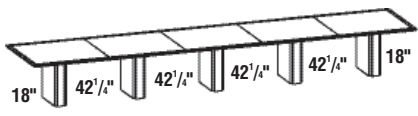
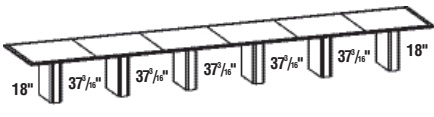
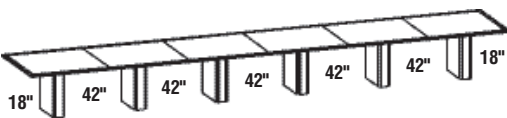
| | Model # | Description/Dimension | Wood Finishes | Price |
|-----------------------------------|----------------------------|--|--|-----------------------------------|
| Rectangular Tables Panel Bases | 1500RET216PB__ 640 lbs. | 18 ft. Conference Table 216"W x 48"D x 30"H Five piece top Five panel bases Seats 18 Bases 5 - 24"D x 7"W 36 ¹ / ₄ " between bases 18" at ends | Walnut Natural Walnut Royale Walnut Richleigh Walnut Empire Walnut Old World Mahogany Crescent Cherry on Walnut Espresso | \$8954 \$7611 no top inlay |
| | |  | | |
| | 1500RET240PB__ 690 lbs. | 20 ft. Conference Table 240"W x 48"D x 30"H Five piece top Five panel bases Seats 20 Bases 5 - 24"D x 7"W 42 ¹ / ₄ " between bases 18" at ends | Cherry Natural Cherry Amber Cherry Cinnamon Cherry Collectors Cherry Mocha Cherry Mahogany on Cherry | \$9212 \$7831 no top inlay |
| | |  | Maple Sunrise | |
| | 1500RET264PB__ 778 lbs. | 22 ft. Conference Table 264"W x 48"D x 30"H Six piece top Six panel bases Seats 22 Bases 6 - 24"D x 7"W 37 ³ / ₁₆ " between bases 18" at ends | | \$10173 \$8647 no top inlay |
| | |  | | |
| | 1500RET288PB__ 828 lbs. | 24 ft. Conference Table 288"W x 48"D x 30"H Six piece top Six panel bases Seats 24 Bases 6 - 24"D x 7"W 42" between bases 18" at ends | | \$10473 \$8903 no top inlay |
| | |  | | |

Communique

J A S P E R D E S K

Designate Wood Species before Model #
00 - Walnut 20 - Cherry 30 - Maple

For top and base designate metal
inlay finish after model #
LX - Black AL - Aluminum

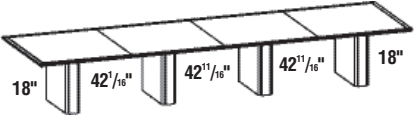
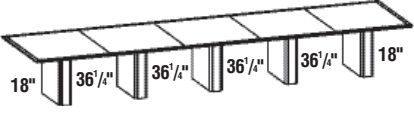
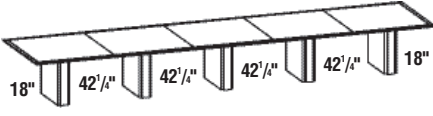
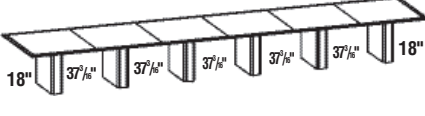
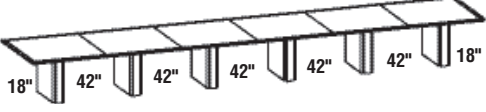
| Model # | Description/Dimension | Wood Finishes | Price |
|--|---|--|---|
| Rectangular Tables Panel Bases  | 1500RET54192PB_ _ 614 lbs. 16 ft. Conference Table 192"W x 54"D x 30"H Four piece top Four panel bases Seats 16 <u>Bases</u> 4 - 30"D x 7"W 42 ¹¹ / ₁₆ " between bases 18" at ends | Walnut Natural Walnut Royale Walnut Richleigh Walnut Empire Walnut Old World Mahogany Crescent Cherry on Walnut Espresso | \$8202 \$6972 no top inlay |
|  | 1500RET54216PB_ _ 713 lbs. 18 ft. Conference Table 216"W x 54"D x 30"H Five piece top Five panel bases Seats 18 <u>Bases</u> 5 - 30"D x 7"W 36 ¹ / ₄ " between bases 18" at ends | Cherry Natural Cherry Amber Cherry Cinnamon Cherry Collectors Cherry Mocha Cherry Mahogany on Cherry | \$9063 \$7704 no top inlay |
|  | 1500RET54240PB_ _ 767 lbs. 20 ft. Conference Table 240"W x 54"D x 30"H Five piece top Five panel bases Seats 20 <u>Bases</u> 5 - 30"D x 7"W 42 ¹ / ₄ " between bases 18" at ends | Maple Sunrise | \$9561 \$8127 no top inlay |
|  | 1500RET54264PB_ _ 866 lbs. 22 ft. Conference Table 264"W x 54"D x 30"H Six piece top Six panel bases Seats 22 <u>Bases</u> 6 - 30"D x 7"W 37 ³ / ₁₆ " between bases 18" at ends | | \$10564 \$8980 no top inlay |
|  | 1500RET54288PB_ _ 920 lbs. 24 ft. Conference Table 288"W x 54"D x 30"H Six piece top Six panel bases Seats 24 <u>Bases</u> 6 - 30"D x 7"W 42" between bases 18" at ends | | \$10874 \$9244 no top inlay |

Communique

J A S P E R D E S K

Designate Wood Species before Model #

00 - Walnut 20 - Cherry 30 - Maple

For top and base designate metal

inlay finish after model #

LX - Black

AL - Aluminum

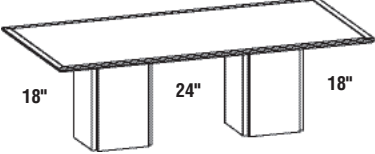
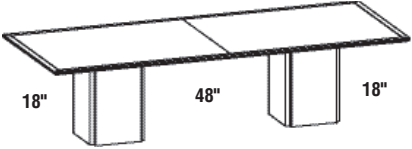
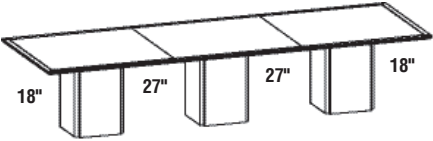
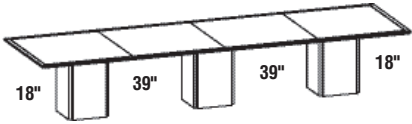
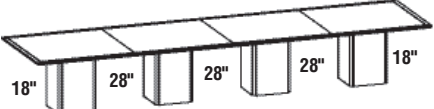
| | Model # | Description/Dimension | Wood Finishes | Price |
|------------------------------------|---|---|---|----------------------------------|
| Rectangular Tables Square Bases | 1500RET96SB_ _ 272 lbs. | 8 ft. Conference Table 96"W x 48"D x 30"H One piece top Two square bases Seats 8 Bases 2 - 18"D x 18"W 24" between bases 18" at ends | Walnut Natural Walnut Royale Walnut Richleigh Walnut Empire Walnut Old World Mahogany Crescent Cherry on Walnut Espresso | \$5136 \$4365 no top inlay |
| |  | | | |
| | 1500RET120SB_ _ 394 lbs. | 10 ft. Conference Table 120"W x 48"D x 30"H Two piece top Two square bases Seats 10 Bases 2 - 18"D x 18"W 48" between bases 18" at ends | Cherry Natural Cherry Amber Cherry Cinnamon Cherry Collectors Cherry Mocha Cherry Mahogany on Cherry | \$5546 \$4714 no top inlay |
| |  | | | |
| | 1500RET144SB_ _ 444 lbs. | 12 ft. Conference Table 144"W x 48"D x 30"H Three piece top Three square bases Seats 12 Bases 3 - 18"D x 18"W 27" between bases 18" at ends | Maple Sunrise | \$6261 \$5322 no top inlay |
| |  | | | |
| | 1500RET168SB_ _ 542 lbs. | 14 ft. Conference Table 168"W x 48"D x 30"H Four piece top Three square bases Seats 14 Bases 3 - 18"D x 18"W 39" between bases 18" at ends | | \$7214 \$6131 no top inlay |
| |  | | | |
| | 1500RET192SB_ _ 592 lbs. | 16 ft. Conference Table 192"W x 48"D x 30"H Four piece top Four square bases Seats 16 Bases 4 - 18"D x 18"W 28" between bases 18" at ends | | \$7814 \$6643 no top inlay |
| |  | | | |

Communique

J A S P E R D E S K

Designate Wood Species before Model #
 00 - Walnut 20 - Cherry 30 - Maple

For top and base designate metal
 inlay finish after model #
 LX - Black AL - Aluminum

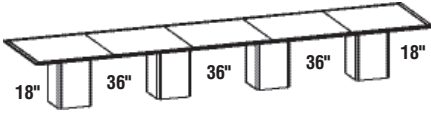
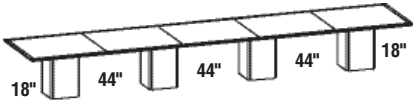
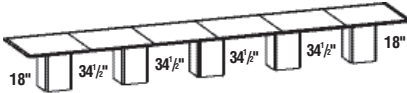
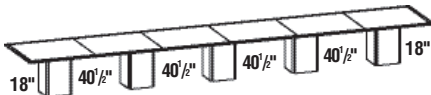
| | Model # | Description/Dimension | Wood Finishes | Price |
|------------------------------------|-----------------------------|--|---|-----------------------------------|
| Rectangular Tables Square Bases | 1500RET216SB_ _ 640 lbs. | 18 ft. Conference Table 216"W x 48"D x 30"H Five piece top Four square bases Seats 18 Bases 4 - 18"D x 18"W 36" between bases 18" at ends | Walnut Natural Walnut Royale Walnut Richleigh Walnut Empire Walnut Old World Mahogany Crescent Cherry on Walnut Espresso | \$8500 \$7225 no top inlay |
| | |  | | |
| | 1500RET240SB_ _ 690 lbs. | 20 ft. Conference Table 240"W x 48"D x 30"H Five piece top Four square bases Seats 20 Bases 4 - 18"D x 18"W 44" between bases 18" at ends | Cherry Natural Cherry Amber Cherry Cinnamon Cherry Collectors Cherry Mocha Cherry Mahogany on Cherry | \$8767 \$7452 no top inlay |
| | |  | Maple Sunrise | |
| | 1500RET264SB_ _ 778 lbs. | 22 ft. Conference Table 264"W x 48"D x 30"H Six piece top Five square bases Seats 22 Bases 5 - 18"D x 18"W 34 1/2" between bases 18" at ends | | \$9703 \$8247 no top inlay |
| | |  | | |
| | 1500RET288SB_ _ 828 lbs. | 24 ft. Conference Table 288"W x 48"D x 30"H Six piece top Five square bases Seats 24 Bases 5 - 18"D x 18"W 40 1/2" between bases 18" at ends | | \$10007 \$8507 no top inlay |
| | |  | | |

Communique

J A S P E R D E S K

Designate Wood Species before Model #

00 - Walnut 20 - Cherry 30 - Maple

For top and base designate metal inlay finish after model #

LX - Black AL - Aluminum

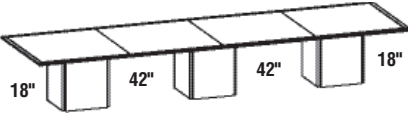
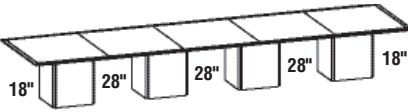
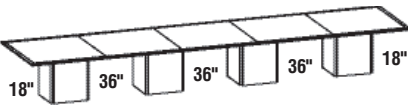
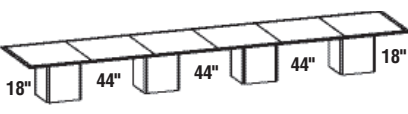
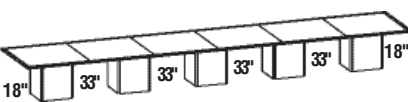
| | Model # | Description/Dimension | Wood Finishes | Price |
|------------------------------------|-------------------------------|--|--|-----------------------------------|
| Rectangular Tables Square Bases | 1500RET54192SB_ _ 614 lbs. | 16 ft. Conference Table 192"W x 54"D x 30"H Four piece top Three square bases Seats 16 Bases 3 - 24"D x 24"W 42" between bases 18" at ends | Walnut Natural Walnut Royale Walnut Richleigh Walnut Empire Walnut Old World Mahogany Crescent Cherry on Walnut Espresso | \$7829 \$6654 no top inlay |
| | |  | | |
| | 1500RET54216SB_ _ 668 lbs. | 18 ft. Conference Table 216"W x 54"D x 30"H Five piece top Four square bases Seats 18 Bases 4 - 24"D x 24"W 28" between bases 18" at ends | Cherry Natural Cherry Amber Cherry Cinnamon Cherry Collectors Cherry Mocha Cherry Mahogany on Cherry | \$8941 \$7600 no top inlay |
| | |  | | |
| | 1500RET54240SB_ _ 767 lbs. | 20 ft. Conference Table 240"W x 54"D x 30"H Five piece top Four square bases Seats 20 Bases 4 - 24"D x 24"W 36" between bases 18" at ends | Maple Sunrise | \$9219 \$7836 no top inlay |
| | |  | | |
| | 1500RET54264SB_ _ 821 lbs. | 22 ft. Conference Table 264"W x 54"D x 30"H Six piece top Four square bases Seats 22 Bases 4 - 24"D x 24"W 44" between bases 18" at ends | | \$9813 \$8340 no top inlay |
| | |  | | |
| | 1500RET54288SB_ _ 875 lbs. | 24 ft. Conference Table 288"W x 54"D x 30"H Six piece top Five square bases Seats 24 Bases 5 - 24"D x 24"W 33" between bases 18" at ends | | \$10545 \$8964 no top inlay |
| | |  | | |

Communique

J A S P E R D E S K

For top and base designate metal
inlay finish after model #
LX - Black AL - Aluminum

Designate Wood Species before Model #
00 - Walnut 20 - Cherry 30 - Maple

| | Model # | Description/Dimension | Wood Finishes | Price |
|-----------------------------------|----------------------------|---|---|---|
| Boat-Shaped Tables Panel Bases | 1500BST96PB__ 245 lbs. | 8 ft. Conference Table 96"W x 48"D x 30"H Tapers to 36" on ends One piece top Two panel bases Seats 8 Bases 2 - 24"D x 7"W 46" between bases 18" at ends | Walnut Natural Walnut Royale Walnut Richleigh Walnut Empire Walnut Old World Mahogany Crescent Cherry on Walnut Espresso | \$5040 \$4285 no top inlay |
| | | | | |
| | 1500BST120PB__ 328 lbs. | 10 ft. Conference Table 120"W x 48"D x 30"H Tapers to 36" on ends Two piece top Three panel bases Seats 10 Bases 3 - 24"D x 7"W 31 1/2" between bases 18" at ends | Cherry Natural Cherry Amber Cherry Cinnamon Cherry Collectors Cherry Mocha Cherry Mahogany on Cherry | \$5763 \$4899 no top inlay |
| | | | | |
| | 1500BST144PB__ 374 lbs. | 12 ft. Conference Table 144"W x 48"D x 30"H Tapers to 36" on ends Three piece top Three panel bases Seats 12 Bases 3 - 24"D x 7"W 43 1/2" between bases 18" at ends | Maple Sunrise | \$6404 \$5444 no top inlay |
| | | | | |
| | 1500BST168PB__ 458 lbs. | 14 ft. Conference Table 168"W x 48"D x 30"H Tapers to 36" on ends Four piece top Four panel bases Seats 14 Bases 4 - 24"D x 7"W 34 11/16" between bases 18" at ends | | \$7583 \$6446 no top inlay |
| | | | | |
| | 1500BST192PB__ 504 lbs. | 16 ft. Conference Table 192"W x 48"D x 30"H Tapers to 36" on ends Four piece top Four panel bases Seats 16 Bases 4 - 24"D x 7"W 42 11/16" between bases 18" at ends | | \$7907 \$6721 no top inlay |
| | | | | |

Communique

J A S P E R D E S K

For top and base designate metal inlay finish after model #
LX - Black AL - Aluminum

Designate Wood Species before Model #

00 - Walnut 20 - Cherry 30 - Maple

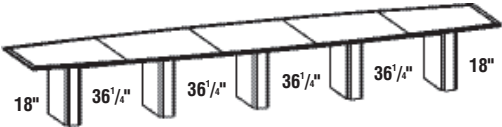
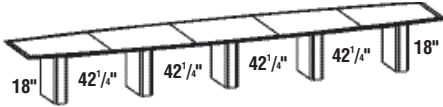
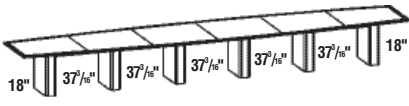
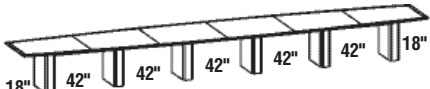

| | Model # | Description/Dimension | Wood Finishes | Price |
|-----------------------------------|-----------------------------|--|--|-----------------------------------|
| Boat-Shaped Tables Panel Bases | 1500BST216PB_ _ 588 lbs. | 18 ft. Conference Table 216"W x 48"D x 30"H Tapers to 36" on ends Five piece top Five panel bases Seats 18 Bases 5 - 24"D x 7"W 36 ¹ / ₄ " between bases 18" at ends | Walnut Natural Walnut Royale Walnut Richleigh Walnut Empire Walnut Old World Mahogany Crescent Cherry on Walnut Espresso | \$8871 \$7540 no top inlay |
| | |  | | |
| | 1500BST240PB_ _ 634 lbs. | 20 ft. Conference Table 240"W x 48"D x 30"H Tapers to 36" on ends Five piece top Five panel bases Seats 20 Bases 5 - 24"D x 7"W 42 ¹ / ₄ " between bases 18" at ends | Cherry Natural Cherry Amber Cherry Cinnamon Cherry Collectors Cherry Mocha Cherry Mahogany on Cherry | \$9219 \$7836 no top inlay |
| | |  | Maple Sunrise | |
| | 1500BST264PB_ _ 718 lbs. | 22 ft. Conference Table 264"W x 48"D x 30"H Tapers to 36" on ends Six piece top Six panel bases Seats 22 Bases 6 - 24"D x 7"W 37 ³ / ₁₆ " between bases 18" at ends | | \$10165 \$8641 no top inlay |
| | |  | | |
| | 1500BST288PB_ _ 764 lbs. | 24 ft. Conference Table 288"W x 48"D x 30"H Tapers to 36" on ends Six piece top Six panel bases Seats 24 Bases 6 - 24"D x 7"W 42" between bases 18" at ends | | \$10465 \$8896 no top inlay |
| | |  | | |

Communique

J A S P E R D E S K

Designate Wood Species before Model #
00 - Walnut 20 - Cherry 30 - Maple

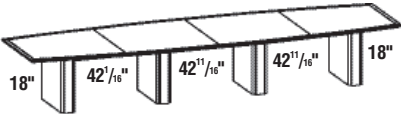
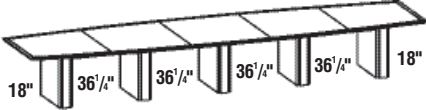
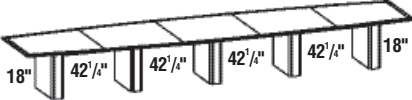
For top and base designate metal
inlay finish after model #
LX - Black AL - Aluminum

| Model # | Description/Dimension | Wood Finishes | Price |
|---|--|--|-----------------------------------|
| Boat-Shaped Tables Panel Bases  | 1500BST54192PB_ _ 566 lbs. 16 ft. Conference Table 192"W x 54"D x 30"H Tapers to 42" on ends Four piece top Four panel bases Seats 16 Bases 4 - 30"D x 7"W 42 ¹¹ / ₁₆ " between bases 18" at ends | Walnut Natural Walnut Royale Walnut Richleigh Walnut Empire Walnut Old World Mahogany Crescent Cherry on Walnut Espresso | \$8171 \$6945 no top inlay |
|  | 1500BST54216PB_ _ 586 lbs. 18 ft. Conference Table 216"W x 54"D x 30"H Tapers to 42" on ends Five piece top Five panel bases Seats 18 Bases 5 - 30"D x 7"W 36 ¹ / ₄ " between bases 18" at ends | Cherry Natural Cherry Amber Cherry Cinnamon Cherry Collectors Cherry Mocha Cherry Mahogany on Cherry | \$9173 \$7797 no top inlay |
|  | 1500BST54240PB_ _ 711 lbs. 20 ft. Conference Table 240"W x 54"D x 30"H Tapers to 42" on ends Five piece top Five panel bases Seats 20 Bases 5 - 30"D x 7"W 42 ¹ / ₄ " between bases 18" at ends | Maple Sunrise | \$9532 \$8102 no top inlay |
|  | 1500BST54264PB_ _ 806 lbs. 22 ft. Conference Table 264"W x 54"D x 30"H Tapers to 42" on ends Six piece top Six panel bases Seats 22 Bases 6 - 30"D x 7"W 37 ³ / ₁₆ " between bases 18" at ends | | \$10519 \$8941 no top inlay |
|  | 1500BST54288PB_ _ 856 lbs. 24 ft. Conference Table 288"W x 54"D x 30"H Tapers to 42" on ends Six piece top Six panel bases Seats 24 Bases 6 - 30"D x 7"W 42" between bases 18" at ends | | \$10830 \$9207 no top inlay |

Communique

J A S P E R D E S K

For top and base designate metal inlay finish after model #
 LX - Black AL - Aluminum

Designate Wood Species before Model #
 00 - Walnut 20 - Cherry 30 - Maple

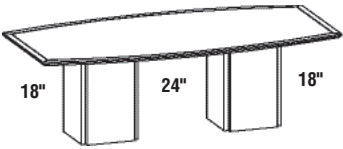
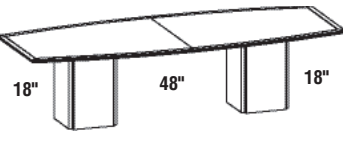
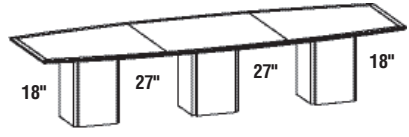
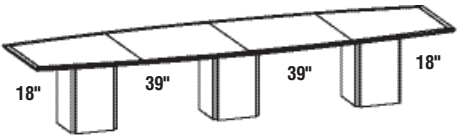
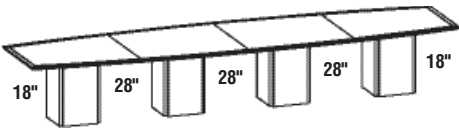
| Model # | Description/Dimension | Wood Finishes | Price |
|---|---|--|----------------------------------|
| Boat-Shaped Tables Square Bases 1500BST96SB__ 257 lbs. | 8 ft. Conference Table 96"W x 48"D x 30"H Tapers to 36" on ends One piece top Two square bases Seats 8 Bases 2 - 18"D x 18"W 24" between bases 18" at ends | Walnut Natural Walnut Royale Walnut Richleigh Walnut Empire Walnut Old World Mahogany Crescent Cherry on Walnut Espresso | \$5142 \$4372 no top inlay |
|  | 10 ft. Conference Table 120"W x 48"D x 30"H Tapers to 36" on ends Two piece top Two square bases Seats 10 Bases 2 - 18"D x 18"W 48" between bases 18" at ends | Cherry Natural Cherry Amber Cherry Cinnamon Cherry Collectors Cherry Mocha Cherry Mahogany on Cherry | \$5622 \$4778 no top inlay |
| 1500BST120SB__ 350 lbs. |  | Maple Sunrise | |
| 1500BST144SB__ 396 lbs. | 12 ft. Conference Table 144"W x 48"D x 30"H Tapers to 36" on ends Three piece top Three square bases Seats 12 Bases 3 - 18"D x 18"W 27" between bases 18" at ends | | \$6298 \$5353 no top inlay |
|  | 14 ft. Conference Table 168"W x 48"D x 30"H Tapers to 36" on ends Four piece top Three square bases Seats 14 Bases 3 - 18"D x 18"W 39" between bases 18" at ends | | \$7290 \$6197 no top inlay |
| 1500BST168SB__ 490 lbs. |  | | |
| 1500BST192SB__ 536 lbs. | 16 ft. Conference Table 192"W x 48"D x 30"H Tapers to 36" on ends Four piece top Four square bases Seats 16 Bases 4 - 18"D x 18"W 28" between bases 18" at ends | | \$7835 \$6660 no top inlay |
|  | | | |

Communique

J A S P E R D E S K

For top and base designate metal inlay finish after model #
 LX - Black AL - Aluminum

Designate Wood Species before Model #
 00 - Walnut 20 - Cherry 30 - Maple

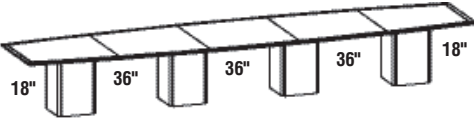
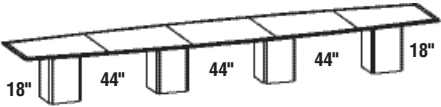
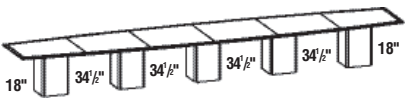
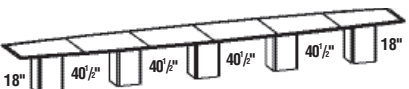
| | Model # | Description/Dimension | Wood Finishes | Price |
|------------------------------------|-----------------------------|--|--|----------------------------------|
| Boat-Shaped Tables Square Bases | 1500BST216SB_ _ 630 lbs. | 18 ft. Conference Table 216"W x 48"D x 30"H Tapers to 36" on ends Five piece top Four square bases Seats 18 Bases 4 - 18"D x 18"W 36" between bases 18" at ends | Walnut Natural Walnut Royale Walnut Richleigh Walnut Empire Walnut Old World Mahogany Crescent Cherry on Walnut Espresso | \$8542 \$7261 no top inlay |
| | |  | | |
| | 1500BST240SB_ _ 676 lbs. | 20 ft. Conference Table 240"W x 48"D x 30"H Tapers to 36" on ends Five piece top Four square bases Seats 20 Bases 4 - 18"D x 18"W 44" between bases 18" at ends | Cherry Natural Cherry Amber Cherry Cinnamon Cherry Collectors Cherry Mocha Cherry Mahogany on Cherry | \$8790 \$7472 no top inlay |
| | |  | Maple Sunrise | |
| | 1500BST264SB_ _ 770 lbs. | 22 ft. Conference Table 264"W x 48"D x 30"H Tapers to 36" on ends Six piece top Five square bases Seats 22 Bases 5 - 18"D x 18"W 34 1/2" between bases 18" at ends | | \$9694 \$8241 no top inlay |
| | |  | | |
| | 1500BST288SB_ _ 816 lbs. | 24 ft. Conference Table 288"W x 48"D x 30"H Tapers to 36" on ends Six piece top Five square bases Seats 24 Bases 5 - 18"D x 18"W 40 1/2" between bases 18" at ends | | \$9998 \$8499 no top inlay |
| | |  | | |

Communique

J A S P E R D E S K

Designate Wood Species before Model #

00 - Walnut 20 - Cherry 30 - Maple

For top and base designate metal

inlay finish after model #

LX - Black

AL - Aluminum

| | Model # | Description/Dimension | Wood Finishes | Price |
|------------------------------------|-------------------------------|--|---|--|
| Boat-Shaped Tables Square Bases | 1500BST54192SB_ _ 616 lbs. | 16 ft. Conference Table 192"W x 54"D x 30"H Tapers to 42" on ends Four piece top Three square bases Seats 16 Bases 3 - 24"D x 24"W 42" between bases 18" at ends | Walnut Natural Walnut Royale Walnut Richleigh Walnut Empire Walnut Old World Mahogany Crescent Cherry on Walnut Espresso | \$7912 \$6724 no top inlay |
| | 1500BST54216SB_ _ 666 lbs. | 18 ft. Conference Table 216"W x 54"D x 30"H Tapers to 42" on ends Five piece top Four square bases Seats 18 Bases 4 - 24"D x 24"W 28" between bases 18" at ends | Cherry Natural Cherry Amber Cherry Cinnamon Cherry Collectors Cherry Mocha Cherry Mahogany on Cherry | \$8811 \$7490 no top inlay |
| | 1500BST54240SB_ _ 776 lbs. | 20 ft. Conference Table 240"W x 54"D x 30"H Tapers to 42" on ends Five piece top Four square bases Seats 20 Bases 4 - 24"D x 24"W 36" between bases 18" at ends | Maple Sunrise | \$9271 \$7881 no top inlay |
| | 1500BST54264SB_ _ 826 lbs. | 22 ft. Conference Table 264"W x 54"D x 30"H Tapers to 42" on ends Six piece top Four square bases Seats 22 Bases 4 - 24"D x 24"W 44" between bases 18" at ends | | \$9835 \$8359 no top inlay |
| | 1500BST54288SB_ _ 876 lbs. | 24 ft. Conference Table 288"W x 54"D x 30"H Tapers to 42" on ends Six piece top Five square bases Seats 24 Bases 5 - 24"D x 24"W 33" between bases 18" at ends | | \$10489 \$8915 no top inlay |

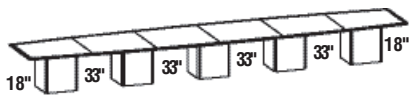
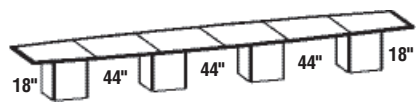
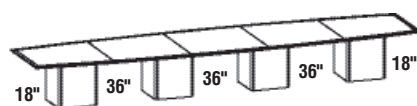
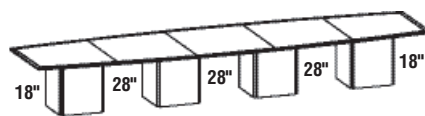
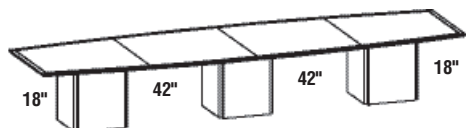

Communique

J A S P E R D E S K

Designate Wood Species before Model #
 00 - Walnut 20 - Cherry 30 - Maple

Designate inlay and pull/base finish after model #
 LX - Black AL - Aluminum

| Model # | Description/Dimension | Wood Finishes | Price |
|---------|-----------------------|---------------|-------|
|---------|-----------------------|---------------|-------|

1500RET42SB_ _
 96 lbs.

Square Conference Table
42"W x 42"D x 30"H
 18" square base

Walnut
 Natural Walnut
 Royale Walnut
 Richeigh Walnut
 Empire Walnut
 Old World Mahogany
 Crescent Cherry on Walnut
 Espresso

\$3633
\$3088
no top inlay

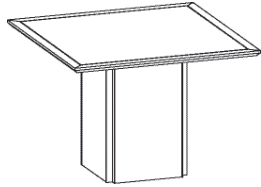

1500RET48SB_ _
 111 lbs.

Square Conference Table
48"W x 48"D x 30"H
 18" square base

Cherry
 Natural Cherry
 Amber Cherry
 Cinnamon Cherry
 Collectors Cherry
 Mocha Cherry
 Mahogany on Cherry

\$3740
\$3179
no top inlay

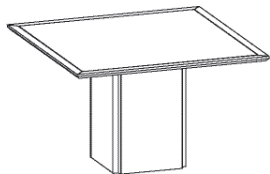

1500RET54SB_ _
 138 lbs.

Square Conference Table
54"W x 54"D x 30"H
 24" square base

Maple
 Sunrise

\$4043
\$3437
no top inlay

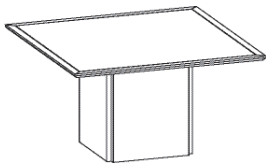

1500RET60SB_ _
 160 lbs.

Square Conference Table
60"W x 60"D x 30"H
 30" square base
 Two piece top

\$4266
\$3625
no top inlay

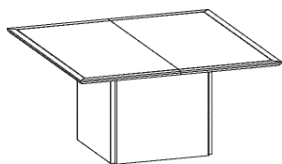

Communique



J A S P E R D E S K

Designate Wood Species before Model #

00 - Walnut 20 - Cherry 30 - Maple

Designate inlay finish after model #

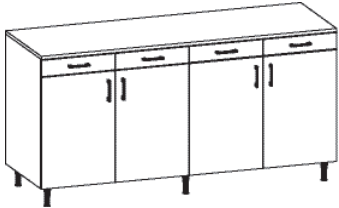
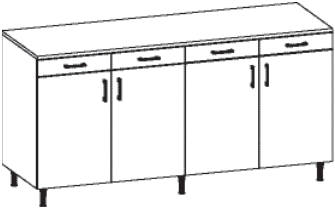
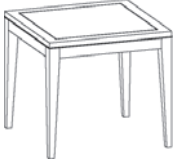
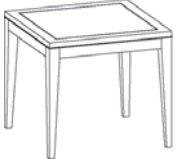
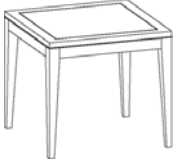
LX - Black AL - Aluminum

| Model # | Description/Dimension | Wood Finishes | Price |
|---|---|--|--|
|  <p>1500BSC72__ 370 lbs.</p> | <p>Buffet Credenza 72"W x 24"D x 36"H Four drawers-top Four doors concealing two storage compartments each with an adjustable shelf</p> | <p>Walnut Natural Walnut Royale Walnut Richleigh Walnut Empire Walnut Old World Mahogany Crescent Cherry on Walnut Espresso</p> | <p>\$4514</p> |
|  <p>1500BSC66__ 340 lbs.</p> | <p>Buffet Credenza 66"W x 24"D x 36"H Four drawers-top Four doors concealing two storage compartments each with an adjustable shelf</p> | <p>Cherry Natural Cherry Amber Cherry Cinnamon Cherry Collectors Cherry Mocha Cherry Mahogany on Cherry</p> <p>Maple Sunrise</p> | <p>\$4259</p> |
|  <p>1500ET2020__ 26 lbs.</p> | <p>Occasional Table - Square 20"W x 20"D x 21"H</p> | | <p>\$944 \$802 no top inlay</p> |
|  <p>1500ET2424__ 34 lbs.</p> | <p>Occasional Table - Square 24"W x 24"D x 21"H</p> | | <p>\$1018 \$865 no top inlay</p> |
|  <p>1500ET3030__ 50 lbs.</p> | <p>Occasional Table - Square 30"W x 30"D x 21"H</p> | | <p>\$1086 \$923 no top inlay</p> |
|  <p>1500CT3636__ 63 lbs.</p> | <p>Occasional Coffee Table 36"W x 36"D x 16"H</p> | | <p>\$1141</p> |
|  <p>1500CT2448__ 65 lbs.</p> | <p>Occasional Coffee Table 48"W x 24"D x 16"H</p> | | <p>\$1177</p> |

Communique

J A S P E R D E S K

Designate Wood Species before Model #
00 - Walnut 20 - Cherry 30 - Maple

Designate inlay finish after model #
LX - Black AL - Aluminum

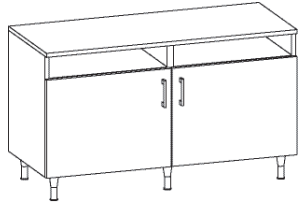
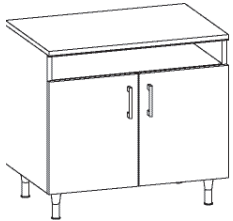
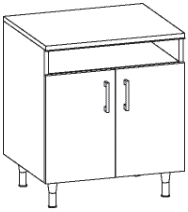
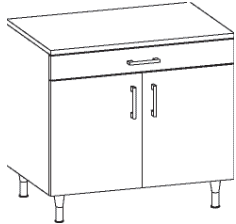
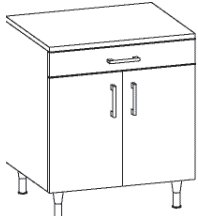
| Model # | Description/Dimension | Wood Finishes | Price |
|---|--|--|--------|
| <p>1500MC28-48__ 185 lbs.</p>  | <p>Media Cabinet - Center Section 48"W x 20"D x 28"H Two open storage compartments-top Two doors with one adjustable shelf in each section</p> | <p>Walnut Natural Walnut Royale Walnut Richleigh Walnut Empire Walnut Old World Mahogany Crescent Cherry on Walnut Espresso</p> | \$2853 |
| <p>1500MC28-30__ 115 lbs.</p>  | <p>Media Cabinet 30"W x 20"D x 28"H One open storage compartment-top Two doors with one storage compartment with an adjustable shelf</p> | <p>Cherry Natural Cherry Amber Cherry Cinnamon Cherry Collectors Cherry Mocha Cherry Mahogany on Cherry</p> <p>Maple Sunrise</p> | \$1973 |
| <p>1500MC28-24__ 92 lbs.</p>  | <p>Media Cabinet 24"W x 20"D x 28"H One open storage compartment-top Two doors with one storage compartment with an adjustable shelf</p> | | \$1832 |
| <p>1500SC28-30__ 123 lbs.</p>  | <p>Media Cabinet 30"W x 20"D x 28"H Storage drawer-top Two doors with one storage compartment with an adjustable shelf</p> | | \$2156 |
| <p>1500SC28-24__ 120 lbs.</p>  | <p>Media Cabinet 24"W x 20"D x 28"H Storage drawer-top Two doors with one storage compartment with an adjustable shelf</p> | | \$2024 |

Communique

J A S P E R D E S K

Designate Wood Species before Model #

00 - Walnut 20 - Cherry 30 - Maple

Designate inlay finish after model #

LX - Black AL - Aluminum

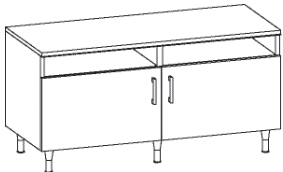
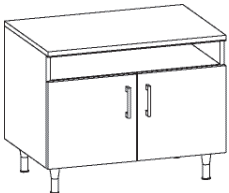
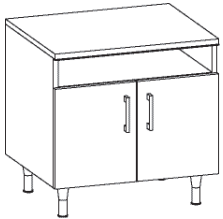
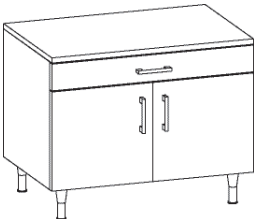
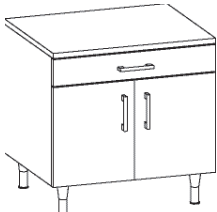
| Model # | Description/Dimension | Wood Finishes | Price |
|---|--|--|---------------|
| <p>1500MC24-48__ 175 lbs.</p>  | <p>Media Cabinet - Center Section 48" W x 20"D x 24"H - low profile Two open storage compartments-top Two doors with an adjustable shelf in each storage section</p> | <p>Walnut Natural Walnut Royale Walnut Richleigh Walnut Empire Walnut Old World Mahogany Crescent Cherry on Walnut Espresso</p> | <p>\$2754</p> |
| <p>1500MC24-30__ 105 lbs.</p>  | <p>Media Cabinet 30"W x 20"D x 24"H - low profile One open storage compartment-top Two doors with one storage compartment with an adjustable shelf</p> | <p>Cherry Natural Cherry Amber Cherry Cinnamon Cherry Collectors Cherry Mocha Cherry Mahogany on Cherry</p> <p>Maple Sunrise</p> | <p>\$1942</p> |
| <p>1500MC24-24__ 88 lbs.</p>  | <p>Media Cabinet 24"W x 20"D x 24"H - low profile One open storage compartment-top Two doors with one storage compartment with an adjustable shelf</p> | | <p>\$1804</p> |
| <p>1500SC24-30__ 113 lbs.</p>  | <p>Media Cabinet 30"W x 20"D x 24"H - low profile Storage drawer-top Two doors with one storage compartment with an adjustable shelf</p> | | <p>\$2195</p> |
| <p>1500SC24-24__ 110 lbs.</p>  | <p>Media Cabinet 24"W x 20"D x 24"H - low profile Storage drawer-top Two doors with one storage compartment with an adjustable shelf</p> | | <p>\$2046</p> |

Communique J A S P E R D E S K

| Model # | Description/Dimension | Wood Finishes | Price |
|---------|-----------------------|---------------|-------|
|---------|-----------------------|---------------|-------|

1500DW48_ _
70 lbs.

Display Wall
48"W x 2"D x 50"H

To be used as centerpiece for mounting flat screen television in conjunction with adjoining media wall cabinets and storage cabinet. Mounting hardware for flat screen included and can accommodate a screen up to 47". Mount is tilt adjustable, has built-in level, wire management and safety lock bar.

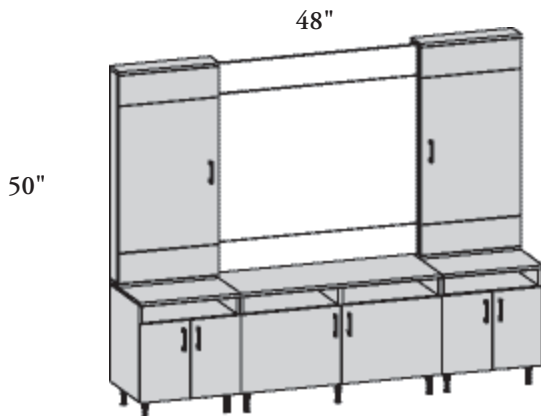

Walnut
Natural Walnut
Royale Walnut
Richeigh Walnut
Empire Walnut
Old World Mahogany
Crescent Cherry on Walnut
Espresso

Cherry
Natural Cherry
Amber Cherry
Cinnamon Cherry
Collectors Cherry
Mocha Cherry
Mahogany on Cherry

Maple
Sunrise

\$1541

MM-3300TV

Flat screen mounting hardware only

\$327

1500MW24L_ _
1500MW24R_ _
50 lbs.

Media Wall Upper Side Cabinet-left (shown)
Media Wall Upper Side Cabinet-right
24"W x 6"D x 50"H
Door conceals white board writing surface
To be used above 24" wide media storage cabinets
Hinged left



\$2139

1500MW30L_ _
1500MW30R_ _
63 lbs.

Media Wall Upper Side Cabinet-left (shown)
Media Wall Upper Side Cabinet-right
30"W x 6"D x 50"H
Door conceals white board writing surface
To be used above 30" wide media storage cabinets
Hinged left

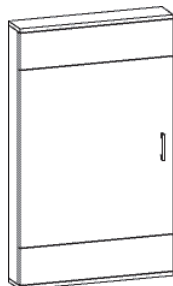

\$2217

TRADITIONAL CONFERENCE ROOM FURNITURE



Standard Profile Options

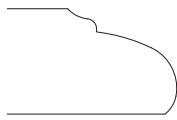

MEP - Montebello
Profile

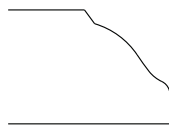

GEP - Georgian
Profile

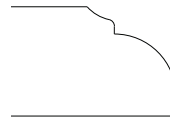

FEP - Franklin
Profile

Traditional styling available in a wide variety of sizes and configurations. Edge details and bases are available in a selection of 15 walnut, cherry, oak, maple and mahogany finishes.

TRADITIONAL CONFERENCE ROOM FURNITURE

Finishes Available

Walnut

Natural Walnut



Richleigh Walnut

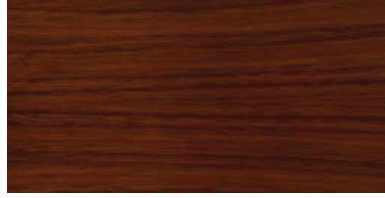

Royal Walnut

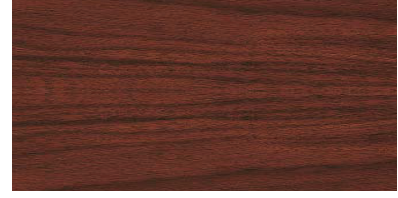

Empire Walnut



Old World Mahogany



Crescent Cherry on Walnut

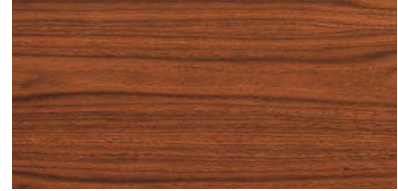

Espresso



Cherry

Natural Cherry



Amber Cherry



Cinnamon Cherry



Collector's Cherry



Mocha Cherry



Mahogany on Cherry



Oak

Landmark Oak

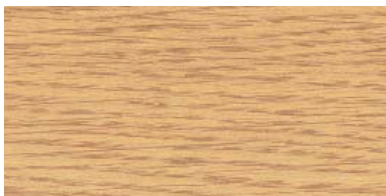

Harbor Oak

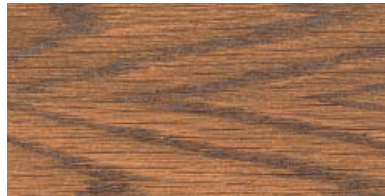

**The finishes shown on this page have been reproduced as accurately as possible, however, due to the printing process some finishes may vary slightly from the actual finish samples originally photographed. In addition, due to the nature of wood, it is possible that some slight variations in color and grain character may occur naturally (which is the beauty of a natural product). Wood finish chips are available for each of the above finishes if requested (please call customer service).

TRADITIONAL CONFERENCE ROOM FURNITURE

Warranty and Certification

All products listed are warranted against defects of material and workmanship under normal use and service for a minimum of 10 years from the date of installation (see full warranty information). All products listed are Level 2 BIFMA certified.

Veneer

Veneer on all exposed surfaces is #1 plain sliced American Black Walnut, Cherry or Oak. Outside surface veneers are book matched to provide proper grain consistency and uniform grain appearance.

Wood Veneer Tops

1 1/2" thick tops utilizing 3-ply construction utilizing #1 select plain sliced American Black Walnut, #1 plain sliced Cherry or book matched figured flat cut White Oak. Solid walnut, cherry or oak lumber rims, shaped with a complimentary traditional style edge detail. Top cores are high density particle board. Rims on all four sides are precisely mitered on all four corners. High pressure laminate tops are optional.

Panel Base and Square Base Construction

Construction technique is mortise and tenon, groove and tenon, heavily glue blocked with hardwood cleats for maximum strength. Bases are solid hardwood mitered at all four corners. Height adjustable leveling glides are mounted in each corner with a threaded metal insert capped with a nylon glide that is height adjustable to approx. 1 1/2" to ensure proper leveling of the unit to varying floor conditions.

Queen Ann Base and Reeded Leg Base Construction

Solid hard wood finished to match top as required. Height adjustable leveling glides are mounted in each corner with a threaded metal insert capped with a nylon glide that is height adjustable to approx. 1 1/2" to ensure proper leveling of the unit to varying floor conditions.

Electrical Options

Various electrical wiring options are available (please see following standard accessories pages for full details). Please note locations when ordering. Panel base and square base conference table may also be specified with or without optional wire management access doors. Wiring access channels will be provided on panel bases and square bases when requested (please note when ordering).

Finish

All exposed surfaces are finished with a UV inhibitor catalyzed varnish finish to ensure maximum durability, chemical resistance, color retention and clarity. All exterior surfaces are finished in the following multi-step sequence: sap stain, NGR stain, wash coat, wash coat sand, filler spray, filler wipe, sealer spray, sealer sand, varnish spray, varnish sand, varnish spray. Moisture content for all wooden parts is between 5 - 9% prior to sealing. Drawer interiors and exteriors are UV prefinished with sealer, sealer sand, and varnished. Custom finish matches are available, contact customer service for request



Ordering Information

Use the following steps to correctly place your order:

- 1) Determine the correct model number for the item you are selecting - example:
7RET72 / 7PBA72 = Rectangular conference table with panel bases, 36" x 72" x 30"H
- 2) Determine the proper finish selection for the item - example:
7RET72 / 7PBA72 - HO = Rectangular conference table with panel bases, 36" x 72" x 30"H, in Harbor Oak finish
- 3) Determine the edge profile you may wish for the item - example:
7RET72 / 7PBA72 - HO - V = Rectangular conference table with panel bases, 36" x 72" x 30"H, in Harbor Oak finish, with bevel edge detail
- 4) Determine any additional options you may wish for the item - example:
7RET72 / 7PBA72 - HO - V @ 200RPO centered = Rectangular conference table with panel bases, 36" x 72" x 30"H, in Harbor Oak finish, with bevel edge detail, with optional retractable power center, centered in the above table

TRADITIONAL CONFERENCE ROOM FURNITURE

List Price

Visual Presentation Board

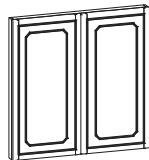

| | |
|--|---------------|
| 7VPB | \$3703 |
| Visual presentation board, magnetic white porcelain writing surface, cork tackboard mounted on the inside of each door (writing accessories not included), doors open to 96" x 48" | |
| 4 1/4" x 48" x 48"H (160 lbs) | |
| Options: FT - Fabric tackboard (sand) | \$66 |
| CL - Cabinet door lock | \$55 |
| FC - Flip Chart | \$72 |

Lecterns

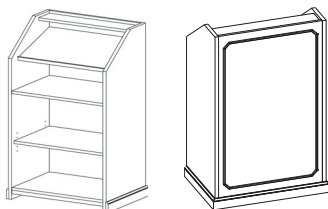

| | |
|---------------------------------|---------------|
| 7OPL2130 | \$3258 |
| 7OPL2148 | \$4116 |
| One piece lectern, with casters | |
| 21" x 30" x 48"H (150 lbs) | |

| | |
|---|---------------|
| 7OPLADJ2130 | \$3718 |
| 7OPLADJ2430 | \$4048 |
| Height adjustable one piece lectern, with casters | |
| Angled platform height adjustable | |
| 21" x 30" x 48"H (150 lbs) | |

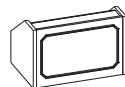

| | |
|-------------------------------|--------------|
| 7TTL | \$780 |
| Table top lectern | |
| 18 1/2" x 28" x 18"H (45 lbs) | |

Media Cabinets

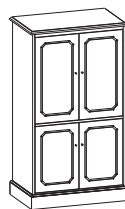

| | |
|--|---------------|
| 7VCR/TV2 | \$5875 |
| Media cabinet, upper TV storage has two pocket doors, Lower section has one pull-out media shelf and one adjustable shelf, two grommet holes in back panel and ventilation slots, self closing doors | |
| Upper storage area dimensions: 23" x 30" x 36 3/4"H | |
| 25" x 35" x 69"H (330 lbs) | |
| Optional locking doors (LK2) add \$110 list | |

| | |
|--|---------------|
| 7VCR/TV2-48 | \$6386 |
| Media cabinet, upper TV storage has two pocket doors, Lower section has one pull-out media shelf and one adjustable shelf, two grommet holes in back panel and ventilation slots, self closing doors | |
| Upper storage area dimensions: 23" x 42" x 36 3/4"H | |
| 25" x 48" x 69"H (390 lbs) | |
| Optional locking doors (LK2) add \$110 list | |

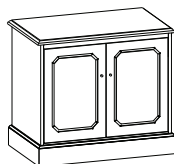

| | |
|--|---------------|
| 7VCR/TV1 | \$3005 |
| Mobile media cabinet, pull-out media shelf and one adjustable shelf, grommet hole in back panel and ventilation slots, casters, self closing doors | |
| 25" x 35" x 30"H (160 lbs) | |
| Optional locking doors (LK) - add \$55 list | |

| | |
|--|---------------|
| 7VCR/TV1-48 | \$3297 |
| Mobile media cabinet, pull-out media shelf and one adjustable shelf, grommet hole in back panel and ventilation slots, casters, self closing doors | |
| 25" x 48" x 30"H (175 lbs) | |
| Optional locking doors (LK) - add \$55 list | |

TRADITIONAL CONFERENCE ROOM FURNITURE

List Price

Storage Cabinets

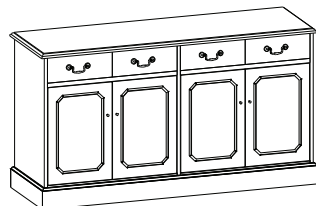

7BSC-84_ \$5388
 Buffet credenza with hinged doors (non-locking), two storage compartments,
 one adjustable shelf per storage compartment, four drawers
 21" x 84" x 36"H (410 lbs)

7BSC-84-24 - 24" x 84" x 36"H \$5839
 Optional locking doors (LK2) add \$110 list

7BSC-72_ \$4847
 Buffet credenza with hinged doors (non-locking), two storage compartments,
 one adjustable shelf per storage compartment, four drawers
 21" x 72" x 36"H (375 lbs)

7BSC-72-24 - 24" x 72" x 36"H \$5265
 Optional locking doors (LK2) add \$110 list

7BSC-66_ \$4410
 Buffet credenza with hinged doors (non-locking), two storage compartments,
 one adjustable shelf per storage compartment, four drawers
 21" x 66" x 36"H (325 lbs)

7BSC-66-24 - 24" x 66" x 36"H \$4795
 Optional locking doors (LK2) add \$110 list

7BSC-60_ \$3809
 Buffet credenza with hinged doors (non-locking), two storage compartments,
 one adjustable shelf per storage compartment, four drawers
 20" x 60" x 36"H (275 lbs)

7BSC-60-24 - 24" x 60" x 36"H \$4161
 Optional locking doors (LK2) add \$110 list



7BSC-30_ \$2288
 Buffet credenza with hinged doors (non-locking), storage compartment with
 one adjustable shelf, two drawers
 21" x 30 1/2" x 36"H (160 lbs)

7BSC-30-24 - 24" x 30 1/2" x 36"H \$2596
 Optional locking doors (LK) add \$55 list

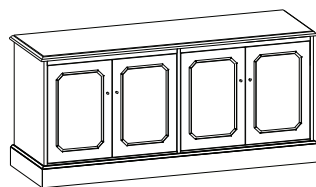

7SC-84_ \$4660
 Four door hinged door cabinet (non-locking), one adjustable shelf per storage compartment
 21" x 84" x 30"H (365 lbs)

7SC-84-24 - 24" x 84" x 30"H \$5089
 Optional locking doors (LK2) add \$110 list

7SC-72_ \$4201
 Four door hinged door cabinet (non-locking), one adjustable shelf per storage compartment
 21" x 72" x 30"H (7 lbs)

7SC-72-24 - 24" x 72" x 30"H \$4597
 Optional locking doors (LK2) add \$110 list

7SC-66_ \$3703
 Four door hinged door cabinet (non-locking), one adjustable shelf per storage compartment
 21" x 66" x 30"H (260 lbs)

7SC-66-24 - 24" x 66" x 30"H \$4066
 Optional locking doors (LK2) add \$110 list

7SC-60_ \$3235
 Four door hinged door cabinet (non-locking), one adjustable shelf per storage compartment
 21" x 60" x 30"H (200 lbs)

7SC-60-24 - 24" x 60" x 30"H \$3565
 Optional locking doors (LK2) add \$110 list

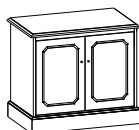

7SC-30_ \$1947
 Two door hinged door cabinet (non-locking), one adjustable shelf
 21" x 30 1/2" x 30"H (125lbs)

7SC-30-24 - 24" x 30 1/2" x 30"H \$2233
 Optional locking doors (LK) add \$55 list

TRADITIONAL CONFERENCE ROOM FURNITURE

List Price

Rectangular Conference Tables with Panel Bases

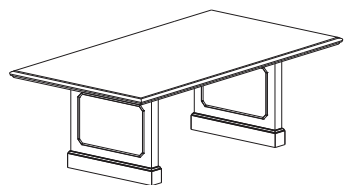

7PT72RE_ (36" x 72" x 30"H 217 lbs) **\$4746**
 Rectangular conference table top with panel bases with panel moulding,
 one piece top, two panel bases - Chair arm clearance (27 1/4")
 Optional Wire mgmt bases with hinged door (WM) - add \$385 list

7PT84RE_ (42" x 84" x 30"H 260 lbs) **\$5186**
 Rectangular conference table top with panel bases with panel moulding,
 one piece top, two panel bases - Chair arm clearance (27 1/4")
 Optional Wire mgmt bases with hinged door (WM) - add \$385 list

7PT96RE_ (42" x 96" x 30"H 272 lbs) **\$5622**
7PT9648RE_ (48" x 96" x 30"H 290 lbs) **\$5850**
 Rectangular conference table top with panel bases with panel moulding,
 one piece top, two panel bases - Chair arm clearance (27 1/4")
 Optional Wire mgmt bases with hinged door (WM) - add \$385 list

7PT120RE_ (48" x 120" x 30"H 398 lbs) **\$7039**
7PT12054RE_ (54" x 120" x 30"H 420 lbs) **\$7533**
 Rectangular conference table top with panel bases with panel moulding,
 two piece top, three panel bases - Chair arm clearance (27 1/4")
 Optional Wire mgmt bases with hinged door (WM) - add \$578 list

7PT144RE_ (48" x 144" x 30"H 435 lbs) **\$8448**
7PT14454RE_ (54" x 144" x 30"H 480 lbs) **\$9041**
 Rectangular conference table top with panel bases with panel moulding,
 two piece top, three panel bases - Chair arm clearance (27 1/4")
 Optional Wire mgmt bases with hinged door (WM) - add \$578 list

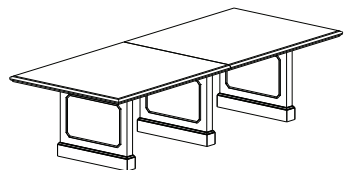

7PT168RE_ (48" x 168" x 30"H 500 lbs) **\$9785**
7PT16854RE_ (54" x 168" x 30"H 560 lbs) **\$10,471**
 Rectangular conference table top with panel bases with panel moulding,
 two piece top, three panel bases - Chair arm clearance (27 1/4")
 Optional Wire mgmt bases with hinged door (WM) - add \$578 list

7PT192RE_ (48" x 192" x 30"H 535 lbs) **\$10,651**
7PT19254RE_ (54" x 192" x 30"H 585 lbs) **\$11,400**
 Rectangular conference table top with panel bases with panel moulding,
 two piece top, three panel bases - Chair arm clearance (27 1/4")
 Optional Wire mgmt bases with hinged door (WM) - add \$578 list

7PT216RE_ (48" x 216" x 30"H 600 lbs) **\$11,925**
7PT21654RE_ (54" x 216" x 30"H 650 lbs) **\$12,757**
 Rectangular conference table top with panel bases with panel moulding,
 two piece top, three panel bases - Chair arm clearance (27 1/4")
 Optional Wire mgmt bases with hinged door (WM) - add \$578 list

7PT240RE_ (48" x 240" x 30"H 690 lbs) **\$13,104**
7PT24054RE_ (54" x 240" x 30"H 775 lbs) **\$14,020**
 Rectangular conference table top with panel bases with panel moulding,
 three piece top, four panel bases - Chair arm clearance (27 1/4")
 Optional Wire mgmt bases with hinged door (WM) - add 770 list

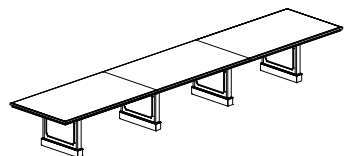

7PT288RE_ (48" x 288" x 30"H 750 lbs) **\$14,581**
7PT28854RE_ (54" x 288" x 30"H 825 lbs) **\$15,600**
 Rectangular conference table top with panel bases with panel moulding,
 three piece top, four panel bases - Chair arm clearance (27 1/4")
 Optional Wire mgmt bases with hinged door (WM) - add \$770 list

TRADITIONAL CONFERENCE ROOM FURNITURE

List Price

Rectangular Conference Tables with Queen Anne Bases

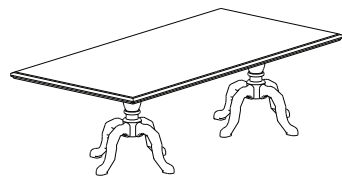

7PDB72RE_ (36" x 72" x 30"H 195 lbs) **\$4636**
 Rectangular conference table top with Queen Anne bases,
 one piece top, two Queen Anne bases - Chair arm clearance (27 1/4")

7PDB84RE_ (42" x 84" x 30"H 235 lbs) **\$5066**
 Rectangular conference table top with Queen Anne bases,
 one piece top, two Queen Anne bases - Chair arm clearance (27 1/4")

7PDB96RE_ (42" x 96" x 30"H 245 lbs) **\$5492**

7PDB9648RE_ (48" x 96" x 30"H 285 lbs) **\$6344**

Rectangular conference table top with Queen Anne bases,
 one piece top, two Queen Anne bases - Chair arm clearance (27 1/4")

7PDB120RE_ (48" x 120" x 30"H 330 lbs) **\$7381**

7PDB12054RE_ (54" x 120" x 30"H 380 lbs) **\$9123**

Rectangular conference table top with Queen Anne bases,
 two piece top, three Queen Anne bases - Chair arm clearance (27 1/4")

7PDB144RE_ (48" x 144" x 30"H 420 lbs) **\$8746**

7PDB14454RE_ (54" x 144" x 30"H 480 lbs) **\$10,587**

Rectangular conference table top with Queen Anne bases,
 two piece top, three Queen Anne bases - Chair arm clearance (27 1/4")

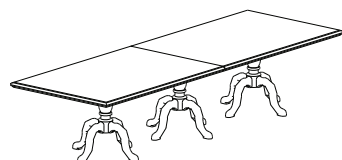

7PDB168RE_ (48" x 168" x 30"H 500 lbs) **\$10,071**

7PDB16854RE_ (54" x 168" x 30"H 560 lbs) **\$12,192**

Rectangular conference table top with Queen Anne bases,
 two piece top, three Queen Anne bases - Chair arm clearance (27 1/4")

7PDB192RE_ (48" x 192" x 30"H 535 lbs) **\$10,931**

7PDB19254RE_ (54" x 192" x 30"H 585 lbs) **\$12,928**

Rectangular conference table top with Queen Anne bases,
 two piece top, three Queen Anne bases - Chair arm clearance (27 1/4")

7PDB216RE_ (48" x 216" x 30"H 600 lbs) **\$12,197**

7PDB21654RE_ (54" x 216" x 30"H 650 lbs) **\$14,277**

Rectangular conference table top with Queen Anne bases,
 two piece top, three Queen Anne bases - Chair arm clearance (27 1/4")

7PDB240RE_ (48" x 240" x 30"H 690 lbs) **\$13,375**

7PDB24054RE_ (54" x 240" x 30"H 775 lbs) **\$16,162**

Rectangular conference table top with Queen Anne bases,
 three piece top, four Queen Anne bases - Chair arm clearance (27 1/4")

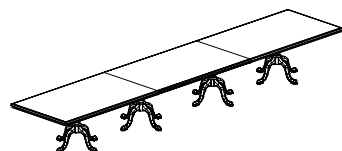

7PDB288RE_ (48" x 288" x 30"H 750 lbs) **\$14,768**

7PDB28854RE_ (54" x 288" x 30"H 825 lbs) **\$17,660**

Rectangular conference table top with Queen Anne bases,
 three piece top, four Queen Anne bases - Chair arm clearance (27 1/4")

TRADITIONAL CONFERENCE ROOM FURNITURE

List Price

Rectangular Conference Tables with Square Bases

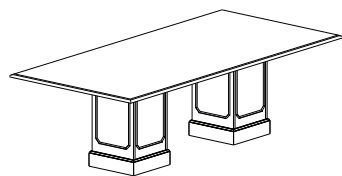

7SQB72RE_ (36" x 72" x 30"H 217 lbs) **\$4542**
 Rectangular conference table top with square bases with panel moulding,
 one piece top, two square bases - Chair arm clearance (27 1/4")
 Optional Wire mgmt bases with hinged door (WM) - add \$385 list

7SQB84RE_ (42" x 84" x 30"H 260 lbs) **\$4973**
 Rectangular conference table top with square bases with panel moulding,
 one piece top, two square bases - Chair arm clearance (27 1/4")
 Optional Wire mgmt bases with hinged door (WM) - add \$385 list

7SQB96RE_ (42" x 96" x 30"H 272 lbs) **\$5398**
7SQB9648RE_ (48" x 96" x 30"H 290 lbs) **\$5710**
 Rectangular conference table top with square bases with panel moulding,
 one piece top, two square bases - Chair arm clearance (27 1/4")
 Optional Wire mgmt bases with hinged door (WM) - add \$385 list

7SQB120RE_ (48" x 120" x 30"H 398 lbs) **\$7519**
7SQB12054RE_ (54" x 120" x 30"H 420 lbs) **\$8039**
 Rectangular conference table top with square bases with panel moulding,
 two piece top, three square bases - Chair arm clearance (27 1/4")
 Optional Wire mgmt bases with hinged door (WM) - add \$578 list

7SQB144RE_ (48" x 144" x 30"H 435 lbs) **\$8883**
7SQB14454RE_ (54" x 144" x 30"H 480 lbs) **\$9507**
 Rectangular conference table top with square bases with panel moulding,
 two piece top, three square bases - Chair arm clearance (27 1/4")
 Optional Wire mgmt bases with hinged door (WM) - add \$578 list

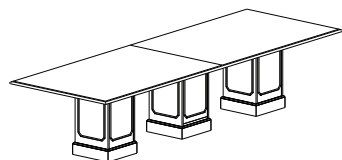

7SQB168RE_ (48" x 168" x 30"H 500 lbs) **\$10,208**
7SQB16854RE_ (54" x 168" x 30"H 560 lbs) **\$10,926**
 Rectangular conference table top with square bases with panel moulding,
 two piece top, three square bases - Chair arm clearance (27 1/4")
 Optional Wire mgmt bases with hinged door (WM) - add \$578 list

7SQB192RE_ (48" x 192" x 30"H 535 lbs) **\$11,068**
7SQB19254RE_ (54" x 192" x 30"H 585 lbs) **\$11,848**
 Rectangular conference table top with square bases with panel moulding,
 two piece top, three square bases - Chair arm clearance (27 1/4")
 Optional Wire mgmt bases with hinged door (WM) - add \$578 list

7SQB216RE_ (48" x 216" x 30"H 600 lbs) **\$12,334**
7SQB21654RE_ (54" x 216" x 30"H 650 lbs) **\$13,197**
 Rectangular conference table top with square bases with panel moulding,
 two piece top, three square bases - Chair arm clearance (27 1/4")
 Optional Wire mgmt bases with hinged door (WM) - add \$578 list

7SQB240RE_ (48" x 240" x 30"H 690 lbs) **\$13,531**
7SQB24054RE_ (54" x 240" x 30"H 775 lbs) **\$14,477**
 Rectangular conference table top with square bases with panel moulding,
 three piece top, four square bases - Chair arm clearance (27 1/4")
 Optional Wire mgmt bases with hinged door (WM) - add \$770 list

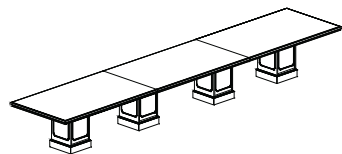

7SQB288RE_ (48" x 288" x 30"H 750 lbs) **\$15,091**
7SQB28854RE_ (54" x 288" x 30"H 825 lbs) **\$15,819**
 Rectangular conference table top with square bases with panel moulding,
 three piece top, four square bases - Chair arm clearance (27 1/4")
 Optional Wire mgmt bases with hinged door (WM) - add \$770 list

TRADITIONAL CONFERENCE ROOM FURNITURE

List Price

Boat-Shaped Conference Tables with Panel Bases

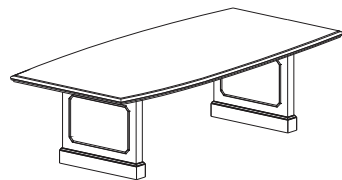

7PT72BS_ (36" x 72" x 30"H 217 lbs) **\$5388**
 Boat-Shaped conference table top with panel bases with panel moulding,
 one piece top, two panel bases - Chair arm clearance (27 1/4")
 Optional Wire mgmt bases with hinged door (WM) - add \$385 list

7PT84BS_ (42" x 84" x 30"H 260 lbs) **\$5772**
 Boat-Shaped conference table top with panel bases with panel moulding,
 one piece top, two panel bases - Chair arm clearance (27 1/4")
 Optional Wire mgmt bases with hinged door (WM) - add \$385 list

7PT96BS_ (42" x 96" x 30"H 272 lbs) **\$6213**
7PT9648BS_ (48" x 96" x 30"H 290 lbs) **\$6499**
 Boat-Shaped conference table top with panel bases with panel moulding,
 one piece top, two panel bases - Chair arm clearance (27 1/4")
 Optional Wire mgmt bases with hinged door (WM) - add \$385 list

7PT120BS_ (48" x 120" x 30"H 398 lbs) **\$8206**
7PT12054BS_ (54" x 120" x 30"H 420 lbs) **\$8778**
 Boat-Shaped conference table top with panel bases with panel moulding,
 two piece top, three panel bases - Chair arm clearance (27 1/4")
 Optional Wire mgmt bases with hinged door (WM) - add \$578 list

7PT144BS_ (48" x 144" x 30"H 435 lbs) **\$9504**
7PT14454BS_ (54" x 144" x 30"H 480 lbs) **\$10,180**
 Boat-Shaped conference table top with panel bases with panel moulding,
 two piece top, three panel bases - Chair arm clearance (27 1/4")
 Optional Wire mgmt bases with hinged door (WM) - add \$578 list

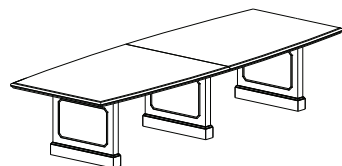

7PT168BS_ (48" x 168" x 30"H 500 lbs) **\$11,017**
7PT16854BS_ (54" x 168" x 30"H 560 lbs) **\$11,797**
 Boat-Shaped conference table top with panel bases with panel moulding,
 two piece top, three panel bases - Chair arm clearance (27 1/4")
 Optional Wire mgmt bases with hinged door (WM) - add \$578 list

7PT192BS_ (48" x 192" x 30"H 535 lbs) **\$12,070**
7PT19254BS_ (54" x 192" x 30"H 585 lbs) **\$12,912**
 Boat-Shaped conference table top with panel bases with panel moulding,
 two piece top, three panel bases - Chair arm clearance (27 1/4")
 Optional Wire mgmt bases with hinged door (WM) - add \$578 list

7PT216BS_ (48" x 216" x 30"H 600 lbs) **\$13,689**
7PT21654BS_ (54" x 216" x 30"H 650 lbs) **\$14,625**
 Boat-Shaped conference table top with panel bases with panel moulding,
 two piece top, three panel bases - Chair arm clearance (27 1/4")
 Optional Wire mgmt bases with hinged door (WM) - add \$578 list

7PT240BS_ (48" x 240" x 30"H 690 lbs) **\$15,366**
7PT24054BS_ (54" x 240" x 30"H 775 lbs) **\$16,406**
 Boat-Shaped conference table top with panel bases with panel moulding,
 three piece top, four panel bases - Chair arm clearance (27 1/4")
 Optional Wire mgmt bases with hinged door (WM) - add \$770 list

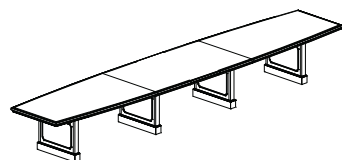

7PT288BS_ (48" x 288" x 30"H 750 lbs) **\$17,067**
7PT28854BS_ (54" x 288" x 30"H 825 lbs) **\$18,315**
 Boat-Shaped conference table top with panel bases with panel moulding,
 three piece top, four panel bases - Chair arm clearance (27 1/4")
 Optional Wire mgmt bases with hinged door (WM) - add \$770 list

TRADITIONAL CONFERENCE ROOM FURNITURE

List Price

Boat-Shaped Conference Tables with Queen Anne Bases

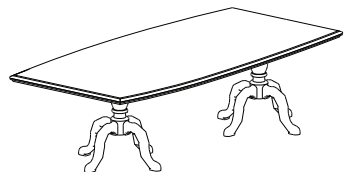

7PDB72BS_ (36" x 72" x 30"H 195 lbs) **\$5086**
Boat-Shaped conference table top with Queen Anne bases,
one piece top, two Queen Anne bases - Chair arm clearance (27 1/4")

7PDB84BS_ (42" x 84" x 30"H 235 lbs) **\$5419**
Boat-Shaped conference table top with Queen Anne bases,
one piece top, two Queen Anne bases - Chair arm clearance (27 1/4")

7PDB96BS_ (42" x 96" x 30"H 245 lbs) **\$6083**
7PDB9648BS_ (48" x 96" x 30"H 285 lbs) **\$6994**
Boat-Shaped conference table top with Queen Anne bases,
one piece top, two Queen Anne bases - Chair arm clearance (27 1/4")

7PDB120BS_ (48" x 120" x 30"H 330 lbs) **\$8548**
7PDB12054BS_ (54" x 120" x 30"H 380 lbs) **\$10,368**
Boat-Shaped conference table top with Queen Anne bases,
two piece top, three Queen Anne bases - Chair arm clearance (27 1/4")

7PDB144BS_ (48" x 144" x 30"H 420 lbs) **\$9801**
7PDB14454BS_ (54" x 144" x 30"H 480 lbs) **\$11,725**
Boat-Shaped conference table top with Queen Anne bases,
two piece top, three Queen Anne bases - Chair arm clearance (27 1/4")

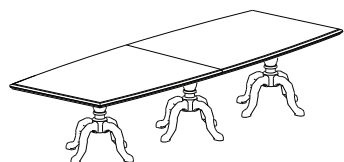

7PDB168BS_ (48" x 168" x 30"H 500 lbs) **\$11,303**
7PDB16854BS_ (54" x 168" x 30"H 560 lbs) **\$13,331**
Boat-Shaped conference table top with Queen Anne bases,
two piece top, three Queen Anne bases - Chair arm clearance (27 1/4")

7PDB192BS_ (48" x 192" x 30"H 535 lbs) **\$12,349**
7PDB19254BS_ (54" x 192" x 30"H 585 lbs) **\$14,440**
Boat-Shaped conference table top with Queen Anne bases,
two piece top, three Queen Anne bases - Chair arm clearance (27 1/4")

7PDB216BS_ (48" x 216" x 30"H 600 lbs) **\$13,960**
7PDB21654BS_ (54" x 216" x 30"H 650 lbs) **\$16,144**
Boat-Shaped conference table top with Queen Anne bases,
two piece top, three Queen Anne bases - Chair arm clearance (27 1/4")

7PDB240BS_ (48" x 240" x 30"H 690 lbs) **\$15,829**
7PDB24054BS_ (54" x 240" x 30"H 775 lbs) **\$18,741**
Boat-Shaped conference table top with Queen Anne bases,
three piece top, four Queen Anne bases - Chair arm clearance (27 1/4")

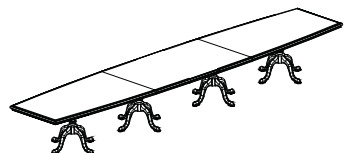

7PDB288BS_ (48" x 288" x 30"H 750 lbs) **\$17,368**
7PDB28854BS_ (54" x 288" x 30"H 825 lbs) **\$20,280**
Boat-Shaped conference table top with Queen Anne bases,
three piece top, four Queen Anne bases - Chair arm clearance (27 1/4")

TRADITIONAL CONFERENCE ROOM FURNITURE

List Price

Boat-Shaped Conference Tables with Square Bases

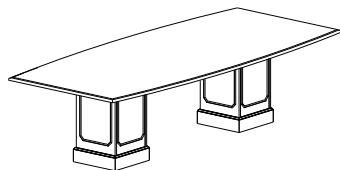

7SQB72BS_ (36" x 72" x 30"H 217 lbs) **\$4992**
 Boat-Shaped conference table top with square bases with panel moulding,
 one piece top, two square bases - Chair arm clearance (27 1/4")
 Optional Wire mgmt bases with hinged door (WM) - add \$385 list

7SQB84BS_ (42" x 84" x 30"H 260 lbs) **\$5325**
 Boat-Shaped conference table top with square bases with panel moulding,
 one piece top, two square bases - Chair arm clearance (27 1/4")
 Optional Wire mgmt bases with hinged door (WM) - add \$385 list

7SQB96BS_ (42" x 96" x 30"H 272 lbs) **\$5990**
7SQB9648BS_ (48" x 96" x 30"H 290 lbs) **\$6302**
 Boat-Shaped conference table top with square bases with panel moulding,
 one piece top, two square bases - Chair arm clearance (27 1/4")
 Optional Wire mgmt bases with hinged door (WM) - add \$385 list

7SQB120BS_ (48" x 120" x 30"H 398 lbs) **\$8686**
7SQB12054BS_ (54" x 120" x 30"H 420 lbs) **\$9294**
 Boat-Shaped conference table top with square bases with panel moulding,
 two piece top, three square bases - Chair arm clearance (27 1/4")
 Optional Wire mgmt bases with hinged door (WM) - add \$578 list

7SQB144BS_ (48" x 144" x 30"H 435 lbs) **\$9939**
7SQB14454BS_ (54" x 144" x 30"H 480 lbs) **\$10,636**
 Boat-Shaped conference table top with square bases with panel moulding,
 two piece top, three square bases - Chair arm clearance (27 1/4")
 Optional Wire mgmt bases with hinged door (WM) - add \$578 list

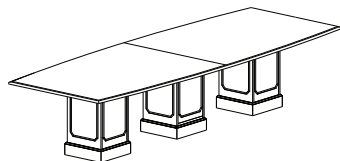

7SQB168BS_ (48" x 168" x 30"H 500 lbs) **\$11,440**
7SQB16854BS_ (54" x 168" x 30"H 560 lbs) **\$12,241**
 Boat-Shaped conference table top with square bases with panel moulding,
 two piece top, three square bases - Chair arm clearance (27 1/4")
 Optional Wire mgmt bases with hinged door (WM) - add \$578 list

7SQB192BS_ (48" x 192" x 30"H 535 lbs) **\$12,487**
7SQB19254BS_ (54" x 192" x 30"H 585 lbs) **\$13,360**
 Boat-Shaped conference table top with square bases with panel moulding,
 two piece top, three square bases - Chair arm clearance (27 1/4")
 Optional Wire mgmt bases with hinged door (WM) - add \$578 list

7SQB216BS_ (48" x 216" x 30"H 600 lbs) **\$14,098**
7SQB21654BS_ (54" x 216" x 30"H 650 lbs) **\$15,086**
 Boat-Shaped conference table top with square bases with panel moulding,
 two piece top, three square bases - Chair arm clearance (27 1/4")
 Optional Wire mgmt bases with hinged door (WM) - add \$578 list

7SQB240BS_ (48" x 240" x 30"H 690 lbs) **\$15,975**
7SQB24054BS_ (54" x 240" x 30"H 775 lbs) **\$17,093**
 Boat-Shaped conference table top with square bases with panel moulding,
 three piece top, four square bases - Chair arm clearance (27 1/4")
 Optional Wire mgmt bases with hinged door (WM) - add \$770 list

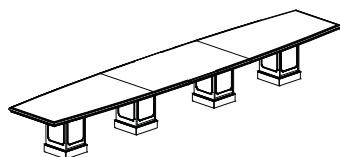

7SQB288BS_ (48" x 288" x 30"H 750 lbs) **\$17,504**
7SQB28854BS_ (54" x 288" x 30"H 825 lbs) **\$18,752**
 Boat-Shaped conference table top with square bases with panel moulding,
 three piece top, four square bases - Chair arm clearance (27 1/4")
 Optional Wire mgmt bases with hinged door (WM) - add \$770 list

TRADITIONAL CONFERENCE ROOM FURNITURE

List Price

Racetrack Conference Tables with Panel Bases

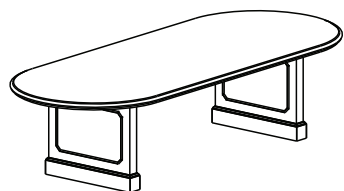

7PT72RT_ (36" x 72" x 30"H 217 lbs) **\$5159**
 Racetrack conference table top with panel bases with panel moulding,
 one piece top, two panel bases - Chair arm clearance (27 1/4")
 Optional Wire mgmt bases with hinged door (WM) - add \$385 list

7PT84RT_ (42" x 84" x 30"H 260 lbs) **\$5720**
 Racetrack conference table top with panel bases with panel moulding,
 one piece top, two panel bases - Chair arm clearance (27 1/4")
 Optional Wire mgmt bases with hinged door (WM) - add \$385 list

7PT96RT_ (42" x 96" x 30"H 272 lbs) **\$6242**
7PT9648RT_ (48" x 96" x 30"H 290 lbs) **\$6533**
 Racetrack conference table top with panel bases with panel moulding,
 one piece top, two panel bases - Chair arm clearance (27 1/4")
 Optional Wire mgmt bases with hinged door (WM) - add \$385 list

7PT120RT_ (48" x 120" x 30"H 398 lbs) **\$8031**
7PT12054RT_ (54" x 120" x 30"H 420 lbs) **\$8593**
 Racetrack conference table top with panel bases with panel moulding,
 two piece top, three panel bases - Chair arm clearance (27 1/4")
 Optional Wire mgmt bases with hinged door (WM) - add \$578 list

7PT144RT_ (48" x 144" x 30"H 435 lbs) **\$9531**
7PT14454RT_ (54" x 144" x 30"H 480 lbs) **\$10,207**
 Racetrack conference table top with panel bases with panel moulding,
 two piece top, three panel bases - Chair arm clearance (27 1/4")
 Optional Wire mgmt bases with hinged door (WM) - add \$578 list

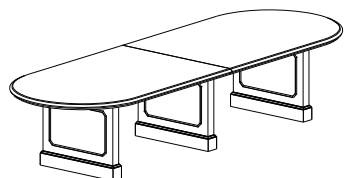

7PT168RT_ (48" x 168" x 30"H 500 lbs) **\$11,274**
7PT16854RT_ (54" x 168" x 30"H 560 lbs) **\$12,054**
 Racetrack conference table top with panel bases with panel moulding,
 two piece top, three panel bases - Chair arm clearance (27 1/4")
 Optional Wire mgmt bases with hinged door (WM) - add \$578 list

7PT192RT_ (48" x 192" x 30"H 535 lbs) **\$13,011**
7PT19254RT_ (54" x 192" x 30"H 585 lbs) **\$13,921**
 Racetrack conference table top with panel bases with panel moulding,
 two piece top, three panel bases - Chair arm clearance (27 1/4")
 Optional Wire mgmt bases with hinged door (WM) - add \$578 list

7PT216RT_ (48" x 216" x 30"H 600 lbs) **\$14,852**
7PT21654RT_ (54" x 216" x 30"H 650 lbs) **\$15,892**
 Racetrack conference table top with panel bases with panel moulding,
 two piece top, three panel bases - Chair arm clearance (27 1/4")
 Optional Wire mgmt bases with hinged door (WM) - add \$578 list

7PT240RT_ (48" x 240" x 30"H 690 lbs) **\$16,536**
7PT24054RT_ (54" x 240" x 30"H 775 lbs) **\$17,680**
 Racetrack conference table top with panel bases with panel moulding,
 three piece top, four panel bases - Chair arm clearance (27 1/4")
 Optional Wire mgmt bases with hinged door (WM) - add \$770 list

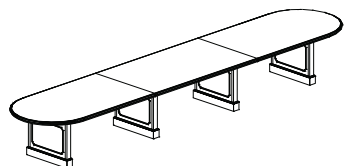

7PT288RT_ (48" x 288" x 30"H 750 lbs) **\$18,289**
7PT28854RT_ (54" x 288" x 30"H 825 lbs) **\$19,537**
 Racetrack conference table top with panel bases with panel moulding,
 three piece top, four panel bases - Chair arm clearance (27 1/4")
 Optional Wire mgmt bases with hinged door (WM) - add \$770 list

TRADITIONAL CONFERENCE ROOM FURNITURE

List Price

Racetrack Conference Tables with Queen Anne Bases

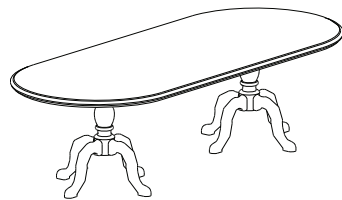

7PDB72RT_ (36" x 72" x 30"H 195 lbs) **\$5049**
 Racetrack conference table top with Queen Anne bases,
 one piece top, two Queen Anne bases - Chair arm clearance (27 1/4")

7PDB84RT_ (42" x 84" x 30"H 235 lbs) **\$5601**
 Racetrack conference table top with Queen Anne bases,
 one piece top, two Queen Anne bases - Chair arm clearance (27 1/4")

7PDB96RT_ (42" x 96" x 30"H 245 lbs) **\$6112**
7PDB9648RT_ (48" x 96" x 30"H 285 lbs) **\$7048**
 Racetrack conference table top with Queen Anne bases,
 one piece top, two Queen Anne bases - Chair arm clearance (27 1/4")

7PDB120RT_ (48" x 120" x 30"H 330 lbs) **\$8374**
7PDB12054RT_ (54" x 120" x 30"H 380 lbs) **\$9366**
 Racetrack conference table top with Queen Anne bases,
 two piece top, three Queen Anne bases - Chair arm clearance (27 1/4")

7PDB144RT_ (48" x 144" x 30"H 420 lbs) **\$9828**
7PDB14454RT_ (54" x 144" x 30"H 480 lbs) **\$11,752**
 Racetrack conference table top with Queen Anne bases,
 two piece top, three Queen Anne bases - Chair arm clearance (27 1/4")

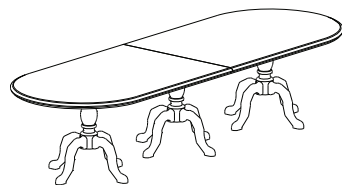

7PDB168RT_ (48" x 168" x 30"H 500 lbs) **\$11,503**
7PDB16854RT_ (54" x 168" x 30"H 560 lbs) **\$13,536**
 Racetrack conference table top with Queen Anne bases,
 two piece top, three Queen Anne bases - Chair arm clearance (27 1/4")

7PDB192RT_ (48" x 192" x 30"H 535 lbs) **\$13,354**
7PDB19254RT_ (54" x 192" x 30"H 585 lbs) **\$15,486**
 Racetrack conference table top with Queen Anne bases,
 two piece top, three Queen Anne bases - Chair arm clearance (27 1/4")

7PDB216RT_ (48" x 216" x 30"H 600 lbs) **\$15,101**
7PDB21654RT_ (54" x 216" x 30"H 650 lbs) **\$17,337**
 Racetrack conference table top with Queen Anne bases,
 two piece top, three Queen Anne bases - Chair arm clearance (27 1/4")

7PDB240RT_ (48" x 240" x 30"H 690 lbs) **\$16,828**
7PDB24054RT_ (54" x 240" x 30"H 775 lbs) **\$19,740**
 Racetrack conference table top with Queen Anne bases,
 three piece top, four Queen Anne bases - Chair arm clearance (27 1/4")

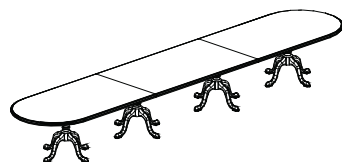

7PDB288RT_ (48" x 288" x 30"H 750 lbs) **\$18,596**
7PDB28854RT_ (54" x 288" x 30"H 825 lbs) **\$21,716**
 Racetrack conference table top with Queen Anne bases,
 three piece top, four Queen Anne bases - Chair arm clearance (27 1/4")

TRADITIONAL CONFERENCE ROOM FURNITURE

List Price

Racetrack Conference Tables with Square Bases

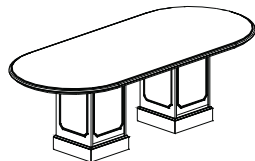

7SQB72RT_ (36" x 72" x 30"H 217 lbs) **\$4955**
 Racetrack conference table top with square bases with panel moulding,
 one piece top, two square bases - Chair arm clearance (27 1/4")
 Optional Wire mgmt bases with hinged door (WM) - add \$385 list

7SQB84RT_ (42" x 84" x 30"H 260 lbs) **\$5507**
 Racetrack conference table top with square bases with panel moulding,
 one piece top, two square bases - Chair arm clearance (27 1/4")
 Optional Wire mgmt bases with hinged door (WM) - add \$385 list

7SQB96RT_ (42" x 96" x 30"H 272 lbs) **\$6018**
7SQB9648RT_ (48" x 96" x 30"H 290 lbs) **\$6330**
 Racetrack conference table top with square bases with panel moulding,
 one piece top, two square bases - Chair arm clearance (27 1/4")
 Optional Wire mgmt bases with hinged door (WM) - add \$385 list

7SQB120RT_ (48" x 120" x 30"H 398 lbs) **\$8233**
7SQB12054RT_ (54" x 120" x 30"H 420 lbs) **\$8805**
 Racetrack conference table top with square bases with panel moulding,
 two piece top, three square bases - Chair arm clearance (27 1/4")
 Optional Wire mgmt bases with hinged door (WM) - add \$578 list

7SQB144RT_ (48" x 144" x 30"H 435 lbs) **\$9688**
7SQB14454RT_ (54" x 144" x 30"H 480 lbs) **\$10,364**
 Racetrack conference table top with square bases with panel moulding,
 two piece top, three square bases - Chair arm clearance (27 1/4")
 Optional Wire mgmt bases with hinged door (WM) - add \$578 list

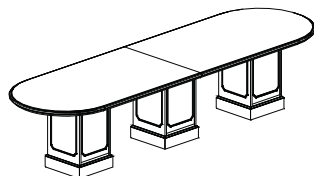

7SQB168RT_ (48" x 168" x 30"H 500 lbs) **\$11,149**
7SQB16854RT_ (54" x 168" x 30"H 560 lbs) **\$11,929**
 Racetrack conference table top with square bases with panel moulding,
 two piece top, three square bases - Chair arm clearance (27 1/4")
 Optional Wire mgmt bases with hinged door (WM) - add \$578 list

7SQB192RT_ (48" x 192" x 30"H 535 lbs) **\$12,605**
7SQB19254RT_ (54" x 192" x 30"H 585 lbs) **\$13,489**
 Racetrack conference table top with square bases with panel moulding,
 two piece top, three square bases - Chair arm clearance (27 1/4")
 Optional Wire mgmt bases with hinged door (WM) - add \$578 list

7SQB216RT_ (48" x 216" x 30"H 600 lbs) **\$14,082**
7SQB21654RT_ (54" x 216" x 30"H 650 lbs) **\$15,070**
 Racetrack conference table top with square bases with panel moulding,
 two piece top, three square bases - Chair arm clearance (27 1/4")
 Optional Wire mgmt bases with hinged door (WM) - add \$578 list

7SQB240RT_ (48" x 240" x 30"H 690 lbs) **\$15,507**
7SQB24054RT_ (54" x 240" x 30"H 775 lbs) **\$16,547**
 Racetrack conference table top with square bases with panel moulding,
 three piece top, four square bases - Chair arm clearance (27 1/4")
 Optional Wire mgmt bases with hinged door (WM) - add \$770 list

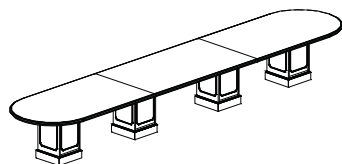

7SQB288RT_ (48" x 288" x 30"H 750 lbs) **\$16,984**
7SQB28854RT_ (54" x 288" x 30"H 825 lbs) **\$18,232**
 Racetrack conference table top with square bases with panel moulding,
 three piece top, four square bases - Chair arm clearance (27 1/4")
 Optional Wire mgmt bases with hinged door (WM) - add \$770 list

TRADITIONAL CONFERENCE ROOM FURNITURE

List Price

Office Tables

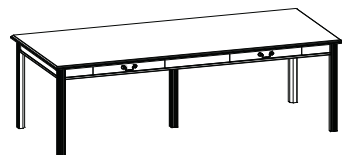

7UT9642_ **\$4419**
 Table desk with two drawers (non-locking), solid wood reeded legs
 Chair arm clearance 25" H
 42" x 96" x 30"H (250 lbs)

7UT9636_ **\$3996**
 Table desk with two drawers (non-locking), solid wood reeded legs
 Chair arm clearance 25" H
 36" x 96" x 30"H (220 lbs)

7UT8442_ **\$3920**
 Table desk with two drawers (non-locking), solid wood reeded legs
 Chair arm clearance 25" H
 42" x 84" x 30"H (180 lbs)

7UT8436_ **\$3496**
 Table desk with two drawers (non-locking), solid wood reeded legs
 Chair arm clearance 25" H
 36" x 84" x 30"H (160 lbs)

7UT7236_ **\$2883**
 Table desk with two drawers (non-locking), solid wood reeded legs
 Chair arm clearance 25" H
 36" x 72" x 30"H (140 lbs)

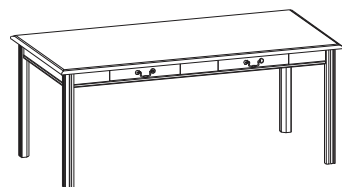

7UT7230_ **\$2659**
 Table desk with two drawers (non-locking), solid wood reeded legs
 Chair arm clearance 25" H
 30" x 72" x 30"H (130 lbs)

7UT6030_ **\$2387**
 Table desk with two drawers (non-locking), solid wood reeded legs
 Chair arm clearance 25" H
 30" x 60" x 30"H (100 lbs)

7UT4830_ **\$2143**
 Table desk with one drawer (non-locking), solid wood reeded legs
 Chair arm clearance 25" H
 30" x 48" x 30"H (85 lbs)

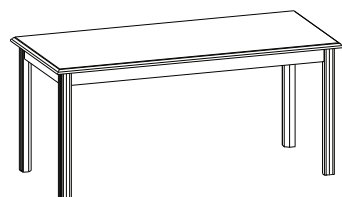

7UT6621_ **\$1793**
 Table desk w/o drawer, solid wood reeded legs

7UT6621WD **\$2167**
 Table desk with two drawers, solid wood reeded legs
 Chair arm clearance 25" H
 21" x 66" x 30"H (85 lbs)

TRADITIONAL CONFERENCE ROOM FURNITURE

List Price

Round Conference Tables

7PDB60RO_ **\$3883**
 Round conference table with Queen Anne base - Chair arm clearance 27 1/4" H
 **accommodates up to 6 chairs
 60" diameter x 30"H (115 lbs)

7PDB54RO_ **\$3500**
 Round conference table with Queen Anne base - Chair arm clearance 27 1/4" H
 **accommodates up to 5 chairs
 54" diameter x 30"H (105 lbs)

7PDB48RO_ **\$2664**
 Round conference table with Queen Anne base - Chair arm clearance 27 1/4" H
 **accommodates up to 4 chairs
 48" diameter x 30"H (85 lbs)

7PDB42RO_ **\$2423**
 Round conference table with Queen Anne base - Chair arm clearance 27 1/4" H
 **accommodates up to 4 chairs
 42" diameter x 30"H (75 lbs)

7PDB36RO_ **\$2208**
 Round conference table with Queen Anne base - Chair arm clearance 27 1/4" H
 **accommodates up to 3 chairs
 36" diameter x 30"H (65 lbs)

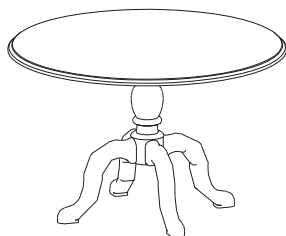

Square Conference Tables

7PDB48SQ_ **\$2560**
 Square conference table with Queen Anne base - Chair arm clearance 27 1/4" H
 **accommodates up to 4 chairs
 48" x 48" x 30"H (85 lbs)

7PDB42SQ_ **\$2319**
 Square conference table with Queen Anne base - Chair arm clearance 27 1/4" H
 **accommodates up to 4 chairs
 42" x 42" x 30"H (75 lbs)

7PDB36SQ_ **\$2104**
 Square conference table with Queen Anne base - Chair arm clearance 27 1/4" H
 **accommodates up to 4 chairs
 36" x 36" x 30"H (65 lbs)

7SQB48SQ_ **\$2605**
 Square conference table with Square base - Chair arm clearance 27 1/4" H
 **accommodates up to 4 chairs
 48" x 48" x 30"H (105 lbs)

7SQB42SQ_ **\$2487**
 Square conference table with Square base - Chair arm clearance 27 1/4" H
 **accommodates up to 4 chairs
 42" x 42" x 30"H (95 lbs)

7SQB36SQ_ **\$2057**
 Square conference table with Square base - Chair arm clearance 27 1/4" H
 **accommodates up to 4 chairs
 36" x 36" x 30"H (85 lbs)

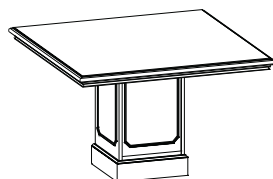
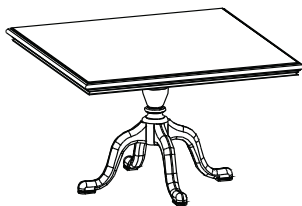

TRADITIONAL CONFERENCE ROOM FURNITURE

List Price

Occasional Tables

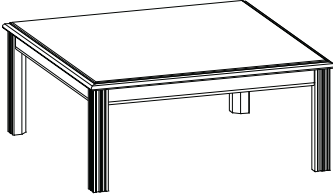
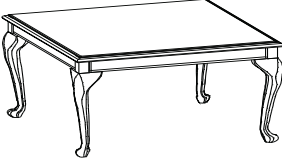
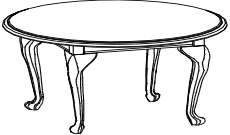
| | | |
|---|--|--------|
|  | 7MTS48OV_ (with shelf) | \$1724 |
| | 7MT48OV_ (without shelf) | \$1334 |
| | Oval magazine table, solid wood reeded legs 24" x 48" x 16"H (70 lbs) | |
| | 7MT48OVQA_ | \$1415 |
| | Oval magazine table with Queen Anne legs 24" x 48" x 16"H (70 lbs) | |
|  | 7MTS36SQ_ (with shelf) | \$1624 |
| | 7MT36SQ_ (without shelf) | \$1274 |
| | Square magazine table, solid wood reeded legs 36" x 36" x 16"H (70 lbs) | |
| | 7MTS30SQ_ (with shelf) | \$1570 |
| | 7MT30SQ_ (without shelf) | \$1237 |
| | Square magazine table, solid wood reeded legs 30" x 30" x 16"H (70 lbs) | |
|  | 7MT36SQQA_ | \$1701 |
| | Square magazine table with Queen Anne legs 36" x 36" x 16"H (70 lbs) | |
| | 7MT30SQQA_ | \$1663 |
| | Square magazine table with Queen Anne legs 30" x 30" x 16"H (70 lbs) | |
|  | 7MTS36RO_ (with shelf) | \$1787 |
| | 7MT36RO_ (without shelf) | \$1402 |
| | Round magazine table, solid wood reeded legs 36" x 36" x 16"H (70 lbs) | |
| | 7MTS30RO_ (with shelf) | \$1727 |
| | 7MT30RO_ (without shelf) | \$1361 |
| | Round magazine table, solid wood reeded legs 30" x 30" x 16"H (70 lbs) | |
|  | 7MT36ROQA_ | \$1829 |
| | Round magazine table, with Queen Anne legs 36" x 36" x 16"H (70 lbs) | |
| | 7MT30ROQA_ | \$1787 |
| | Round magazine table, with Queen Anne legs 30" x 30" x 16"H (70 lbs) | |
|  | 7MTS48_ (with shelf) | \$1566 |
| | 7MT48_ (without shelf) | \$1212 |
| | Magazine table, solid wood reeded legs 20" x 48" x 16"H (70 lbs) | |
| | 7MT48QA_ | \$1638 |
| | Magazine table, with Queen Anne legs 20" x 48" x 16"H (40 lbs) | |

TRADITIONAL CONFERENCE ROOM FURNITURE

List Price

Occasional Tables

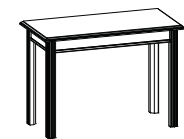

7UT4821_ **\$1641**
 Reception table, with solid wood reeded legs
 21" x 48" x 30"H (85 lbs)

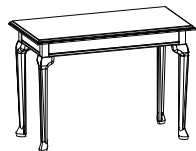

7UT4821QA_ **\$2370**
 Reception table, with Queen Anne base
 21" x 48" x 30"H (85 lbs)bs



7CTS24RO_ (with shelf) **\$1522**
7CT24RO_ (without shelf) **\$1188**
 Round occasional table, solid wood reeded legs
 24" x 24" x 23"H (70 lbs)



7CT24ROQA_ **\$1671**
 Round occasional table, with Queen Anne legs
 24" x 24" x 23"H (70 lbs)

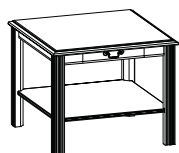

7CTS22WD_ (with shelf) **\$1254**
 End table with shelf & drawer (non-locking), solid wood reeded legs
 22" x 22" x 23"H (38 lbs)



7CTS28_ (with shelf) **\$1384**
7CT28_ (without shelf) **\$1080**
 Corner table, solid wood reeded legs
 28" x 28" x 23"H (58 lbs)

7CTS22_ (with shelf) **\$1082**
7CT22_ (without shelf) **\$909**
 Corner table, solid wood reeded legs
 22" x 22" x 23"H (35 lbs)



7CTS28QA_ **\$1563**
 Corner table, with Queen Anne legs
 28" x 28" x 23"H (58 lbs)

7CTS22QA_ **\$1392**
 Corner table, with Queen Anne legs
 22" x 22" x 23"H (35 lbs)

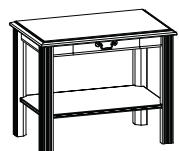

7ETS18WD_ (with shelf) **\$1304**
7ET18WD_ (without shelf) **\$1103**
 End table with shelf & drawer (non-locking), solid wood reeded legs
 18" x 28" x 23"H (38 lbs)

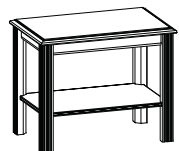

7ETS18_ (with shelf) **\$1083**
7ET18_ (without shelf) **\$882**
 End table with shelf, solid wood reeded legs
 18" x 28" x 23"H (35 lbs)

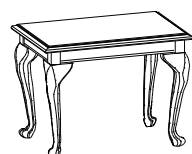

7ET18QA_ **\$1365**
 End table, with Queen Anne legs
 18" x 28" x 23"H (38 lbs)

CONTEMPORARY - TRANSITIONAL CONFERENCE ROOM FURNITURE



Transitional and contemporary styling available in a wide variety of sizes and configurations. Edge details and bases are available in a selection of 16 walnut, cherry, oak, maple and mahogany finishes.

CONTEMPORARY - TRANSITIONAL CONFERENCE ROOM FURNITURE

Finishes Available

Walnut

Natural Walnut



Richleigh Walnut

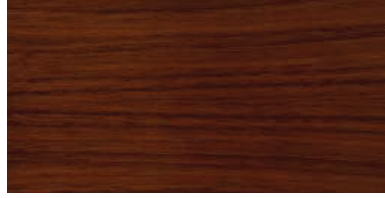

Royal Walnut



Empire Walnut



Old World Mahogany



Crescent Cherry on Walnut

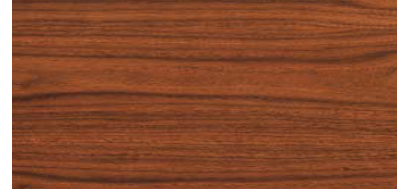

Espresso



Cherry

Natural Cherry



Amber Cherry



Cinnamon Cherry

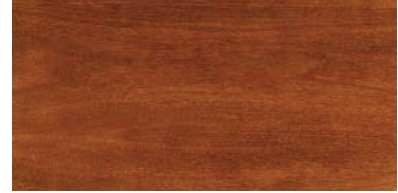

Collector's Cherry



Mocha Cherry

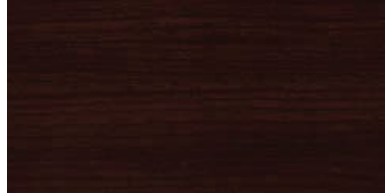

Mahogany on Cherry



Oak

Landmark Oak

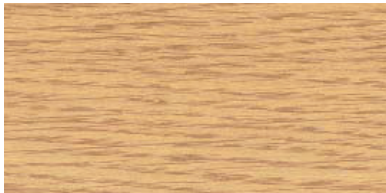

Harbor Oak



Maple

Sunrise Maple



**The finishes shown on this page have been reproduced as accurately as possible, however, due to the printing process some finishes may vary slightly from the actual finish samples originally photographed. In addition, due to the nature of wood, it is possible that some slight variations in color and grain character may occur naturally (which is the beauty of a natural product). Wood finish chips are available for each of the above finishes if requested (please call customer service).

CONTEMPORARY - TRANSITIONAL CONFERENCE ROOM FURNITURE

Warranty and Certification

All products listed are warranted against defects of material and workmanship under normal use and service for a minimum of 10 years from the date of installation (see full warranty information). All products listed are Level 2 BIFMA certified.

Veneer

Veneer on all exposed surfaces is American Black Walnut, Cherry, Maple or White Oak. Outside surface veneers are book matched to provide proper grain consistency and uniform grain appearance.

Wood Veneer Tops

1 1/2" thick tops utilizing 3-ply construction utilizing American Black Walnut, Cherry, Maple or White Oak. Solid cherry, maple, oak or walnut lumber rims, shaped with a six (6) Contemporary or Transitional style edge details available. Top cores are high density particle board. Rims on all four sides are precisely mitered on all four corners. High pressure laminate tops are optional.

Panel Base and Square Base Construction

Construction technique is mortise and tenon, groove and tenon, heavily glue blocked with hardwood cleats for maximum strength. Bases are solid hardwood mitered at all four corners.

Height adjustable leveling glides are mounted in each corner with a threaded metal insert capped with a nylon glide that is height adjustable to approx. 1 1/2" to ensure proper leveling of the unit to varying floor conditions.

Electrical Options

Various electrical wiring options are available (please see following standard accessories pages for full details). Please note locations when ordering. Panel base and square base conference table may also be specified with or without optional wire management access doors. Wiring access channels will be provided on panel bases and square bases when requested (please note when ordering).

Finish

All exposed surfaces are finished with a UV inhibitor catalyzed varnish finish to ensure maximum durability, chemical resistance, color retention and clarity. All exterior surfaces are finished in the following multi-step sequence: sap stain, NGR stain, wash coat, wash coat sand, filler spray, filler wipe, sealer spray, sealer sand, varnish spray, varnish sand, varnish spray. Moisture content for all wooden parts is between 5 - 9% prior to sealing. Drawer interiors and exteriors are UV prefinished with sealer, sealer sand, and varnished. Custom finish matches are available, contact customer service for request.



Standard Profile Options

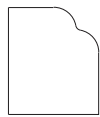

Duet - H

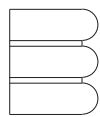

Reeded - D

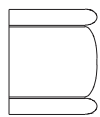

Tri-Oval - C

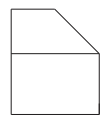

Bevel - V



Square - A

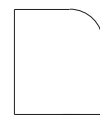

Radius - R

Ordering Information

Use the following steps to correctly place your order:

- 1) Determine the correct model number for the item you are selecting - example:
300RET72 / 300PBA72 = Rectangular conference table with panel bases, 36" x 72" x 30"H
- 2) Determine the proper finish selection for the item - example:
300RET72 / 300PBA72 - HO = Rectangular conference table with panel bases, 36" x 72" x 30"H, in Harbor Oak finish
- 3) Determine the edge profile you may wish for the item - example:
300RET72 / 300PBA72 - HO - V = Rectangular conference table with panel bases, 36" x 72" x 30"H, in Harbor Oak finish, with bevel edge detail
- 4) Determine any additional options you may wish for the item - example:
300RET72 / 300PBA72 - HO - V @ 200RPO centered = Rectangular conference table with panel bases, 36" x 72" x 30"H, in Harbor Oak finish, with bevel edge detail, with optional retractable power center, centered in the above table

CONTEMPORARY - TRANSITIONAL CONFERENCE ROOM FURNITURE

List Price

Visual Presentation Board

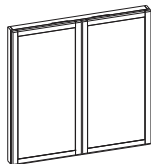

| | |
|---|---------------|
| 300VPB | \$3310 |
| Visual presentation board, magnetic white porcelain writing surface, cork tackboard mounted on the inside of each door (writing accessories not included), doors open to 96" x 48" 4 1/4" x 48" x 48"H (160 lbs) | |
| Options: FT - Fabric tackboard (sand) | \$66 |
| CL - Cabinet door lock | \$55 |
| FC - Flip Chart | \$72 |

Lecterns

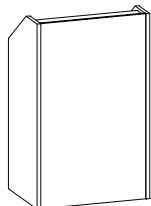

| | |
|---|---------------|
| 300OPL2130 | \$2743 |
| 300OPL2148 | \$3601 |
| One piece lectern, with casters 21" x 30" x 48"H (150 lbs) | |

| | |
|--|---------------|
| 300OPLADJ2130 | \$3131 |
| 300OPLADJ2430 | \$3406 |
| Height adjustable one piece lectern, with casters Angled platform height adjustable 21" x 30" x 48"H (150 lbs) | |

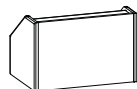

| | |
|--|--------------|
| 300TTL | \$784 |
| Table top lectern 18 1/2" x 28" x 18"H (45 lbs) | |

Media Cabinets

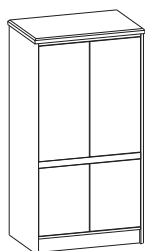

| | |
|---|---------------|
| 300VCR/TV2 | \$5126 |
| Media cabinet, upper TV storage has two pocket doors, Lower section has one pull-out media shelf and one adjustable shelf, two grommet holes in back panel and ventilation slots, touch latch doors Upper storage area dimensions: 23" x 30" x 36 3/4"H 25" x 35" x 69"H (330 lbs) Optional locking doors (LK2) - add \$110 list | |

| | |
|---|---------------|
| 300VCR/TV2-48 | \$7031 |
| Media cabinet, upper TV storage has two pocket doors, Lower section has one pull-out media shelf and one adjustable shelf, two grommet holes in back panel and ventilation slots, touch latch doors Upper storage area dimensions: 23" x 42" x 36 3/4"H 25" x 48" x 69"H (390 lbs) Optional locking doors (LK2) - add \$110 list | |

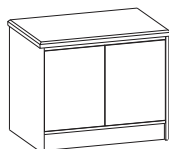

| | |
|--|---------------|
| 300VCR/TV1 | \$2538 |
| Mobile media cabinet, pull-out media shelf and one adjustable shelf, grommet hole in back panel and ventilation slots, casters, touch latch doors 25" x 35" x 30"H (160 lbs) Optional locking doors (LK) - add \$55 list | |

| | |
|--|---------------|
| 300VCR/TV1-48 | \$3484 |
| Mobile media cabinet, pull-out media shelf and one adjustable shelf, grommet hole in back panel and ventilation slots, casters, touch latch doors 25" x 48" x 30"H (175 lbs) Optional locking doors (LK) - add \$55 list | |

CONTEMPORARY - TRANSITIONAL CONFERENCE ROOM FURNITURE

List Price

Storage Cabinets

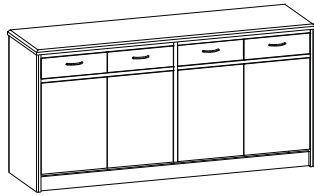

300BSC-84_ \$4831
Buffet credenza with hinged doors (non-locking), two storage compartments, one adjustable shelf per storage compartment, four drawers, arc black pulls standard
20" x 84" x 36"H (410 lbs)

300BSC-84-24 - 24" x 84" x 36"H \$5282
Optional locking doors (LK2) - add \$110 list

300BSC-72_ \$4295
Buffet credenza with hinged doors (non-locking), two storage compartments, one adjustable shelf per storage compartment, four drawers, arc black pulls standard
20" x 72" x 36"H (375 lbs)

300BSC-72-24 - 24" x 72" x 36"H \$4713
Optional locking doors (LK2) - add \$110 list

300BSC-66_ \$3958
Buffet credenza with hinged doors (non-locking), two storage compartments, one adjustable shelf per storage compartment, four drawers, arc black pulls standard
20" x 66" x 36"H (300 lbs)

300BSC-66-24 - 24" x 66" x 36"H \$4343
Optional locking doors (LK2) - add \$110 list

300BSC-60_ \$3533
Buffet credenza with hinged doors (non-locking), two storage compartments, one adjustable shelf per storage compartment, four drawers, arc black pulls standard
20" x 60" x 36"H (275 lbs)

300BSC-60-24 - 24" x 60" x 36"H \$3885
Optional locking doors (LK2) - add \$110 list



300BSC-30_ \$2004
Buffet credenza with hinged doors (non-locking), storage compartment with one adjustable shelf, two drawers, arc black pulls standard
20" x 30 1/2" x 36"H (160 lbs)

300BSC-30-24 - 24" x 30 1/2" x 36"H \$2312
Optional locking doors (LK) - add \$55 list

300SC-84_ \$4254
Four door hinged door cabinet (non-locking), one adjustable shelf per storage compartment
20" x 84" x 30"H (365 lbs)

300SC-84-24 - 24" x 84" x 30"H \$4683
Optional locking doors (LK2) - add \$110 list

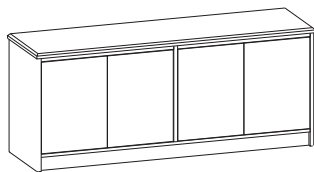

300SC-72_ \$3782
Four door hinged door cabinet (non-locking), one adjustable shelf per storage compartment
20" x 72" x 30"H (300 lbs)

300SC-72-24 - 24" x 72" x 30"H \$4178
Optional locking doors (LK2) - add \$110 list

300SC-66_ \$3396
Four door hinged door cabinet (non-locking), one adjustable shelf per storage compartment
20" x 66" x 30"H (260 lbs)

300SC-66-24 - 24" x 66" x 30"H \$3759
Optional locking doors (LK2) - add \$110 list

300SC-60_ \$3031
Four door hinged door cabinet (non-locking), one adjustable shelf per storage compartment
20" x 60" x 30"H (200 lbs)

300SC-60-24 - 24" x 60" x 30"H \$3361
Optional locking doors (LK2) - add \$110 list

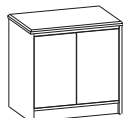

300SC-30_ \$1650
Two door hinged door cabinet (non-locking), one adjustable shelf
20" x 30 1/2" x 30"H (125lbs)

300SC-30-24 - 24" x 30 1/2" x 30"H \$1936
Optional locking doors (LK) - add \$55 list

CONTEMPORARY - TRANSITIONAL CONFERENCE ROOM FURNITURE

List Price

Rectangular Conference Table Tops

300RET72_ \$1542

Rectangular conference table top (one piece) - accomodates up to 6 chairs
36" x 72" x 1 1/2"H (140 lbs)
**Requires minimum of two (2) appropriately sized bases



300RET84_ \$1799

Rectangular conference table top (one piece) - accomodates up to 6 chairs
42" x 84" x 1 1/2"H (160 lbs)
**Requires minimum of two (2) appropriately sized bases

300RET96_ (42" x 96" x 1 1/2"H 215 lbs) \$2231

300RET96-48_ (48" x 96" x 1 1/2"H 230 lbs) \$2508

Rectangular conference table top (one piece) - accomodates up to 8 chairs
**Requires minimum of two (2) appropriately sized bases

300RET120_ (48" x 120" x 1 1/2"H 250 lbs) \$2625

300RET120-54_ (54" x 120" x 1 1/2"H 280 lbs) \$2954

Rectangular conference table top (two piece) - accomodates up to 10 chairs
**Requires minimum of three (3) appropriately sized bases

300RET144_ (48" x 144" x 1 1/2"H 300 lbs) \$3016

300RET144-54_ (54" x 144" x 1 1/2"H 335 lbs) \$3396

Rectangular conference table top (two piece) - accomodates up to 12 chairs
**Requires minimum of three (3) appropriately sized bases

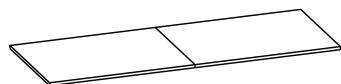

300RET168_ (48" x 168" x 1 1/2"H 350 lbs) \$3298

300RET168-54_ (54" x 168" x 1 1/2"H 395 lbs) \$3711

Rectangular conference table top (two piece) - accomodates up to 14 chairs
**Requires minimum of three (3) appropriately sized bases

300RET192_ (48" x 192" x 1 1/2"H 400 lbs) \$4017

300RET192-54_ (54" x 192" x 1 1/2"H 450 lbs) \$4415

Rectangular conference table top (two piece) - accomodates up to 16 chairs
**Requires minimum of three (3) appropriately sized bases

300RET216_ (48" x 216" x 1 1/2"H 450 lbs) \$4478

300RET216-54_ (54" x 216" x 1 1/2"H 505 lbs) \$5039

Rectangular conference table top (two piece) - accomodates up to 18 chairs
**Requires minimum of three (3) appropriately sized bases

300RET240_ (48" x 240" x 1 1/2"H 505 lbs) \$5075

300RET240-54_ (54" x 240" x 1 1/2"H 570 lbs) \$5715

Rectangular conference table top (three piece) - accomodates up to 20 chairs
**Requires minimum of four (4) appropriately sized bases



300RET288_ (48" x 288" x 1 1/2"H 605 lbs) \$6225





300RET288-54_ (54" x 288" x 1 1/2"H 680 lbs) \$7015

Rectangular conference table top (three piece) - accomodates up to 24 chairs
**Requires minimum of four (4) appropriately sized bases

CONTEMPORARY - TRANSITIONAL CONFERENCE ROOM FURNITURE

List Price

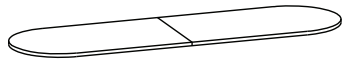
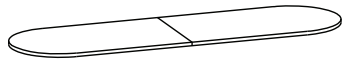
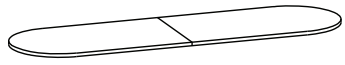
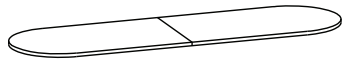
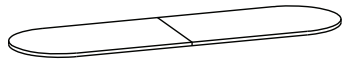
Racetrack Conference Table Tops

| | | |
|--|---|----------|
|  | 300RAT72_ | \$2127 |
| | Racetrack conference table top (one piece) - accomodates up to 6 chairs 36" x 72" x 1 1/2"H (135 lbs) **Requires minimum of two (2) appropriately sized bases | |
|  | 300RAT84_ | \$2491 |
| | Racetrack conference table top (one piece) - accomodates up to 6 chairs 42" x 84" x 1 1/2"H (160 lbs) **Requires minimum of two (2) appropriately sized bases | |
|  | 300RAT96_ (42" x 96" x 1 1/2"H 200 lbs) | \$3862 |
| | 300RAT96-48_ (48" x 96" x 1 1/2"H 230 lbs) | \$4415 |
| Racetrack conference table top (one piece) - accomodates up to 8 chairs **Requires minimum of two (2) appropriately sized bases | | |
|  | 300RAT120_ (48" x 120" x 1 1/2"H 250 lbs) | \$4389 |
| | 300RAT120-54_ (54" x 120" x 1 1/2"H 280 lbs) | \$4940 |
| Racetrack conference table top (two piece) - accomodates up to 10 chairs **Requires minimum of three (3) appropriately sized bases | | |
|  | 300RAT144_ (48" x 144" x 1 1/2"H 300 lbs) | \$5582 |
| | 300RAT144-54_ (54" x 144" x 1 1/2"H 335 lbs) | \$6282 |
| Racetrack conference table top (two piece) - accomodates up to 12 chairs **Requires minimum of three (3) appropriately sized bases | | |
|  | 300RAT168_ (48" x 168" x 1 1/2"H 350 lbs) | \$6513 |
| | 300RAT168-54_ (54" x 168" x 1 1/2"H 395 lbs) | \$7332 |
| Racetrack conference table top (two piece) - accomodates up to 14 chairs **Requires minimum of three (3) appropriately sized bases | | |
|  | 300RAT192_ (48" x 192" x 1 1/2"H 400 lbs) | \$7444 |
| | 300RAT192-54_ (54" x 192" x 1 1/2"H 450 lbs) | \$8378 |
| Racetrack conference table top (two piece) - accomodates up to 16 chairs **Requires minimum of three (3) appropriately sized bases | | |
|  | 300RAT216_ (48" x 216" x 1 1/2"H 450 lbs) | \$8375 |
| | 300RAT216-54_ (54" x 216" x 1 1/2"H 505 lbs) | \$9423 |
| Racetrack conference table top (two piece) - accomodates up to 18 chairs **Requires minimum of three (3) appropriately sized bases | | |
|  | 300RAT240_ (48" x 240" x 1 1/2"H 505 lbs) | \$9324 |
| | 300RAT240-54_ (54" x 240" x 1 1/2"H 570 lbs) | \$10,494 |
| Racetrack conference table top (three piece) - accomodates up to 20 chairs **Requires minimum of four (4) appropriately sized bases | | |
|  | 300RAT288_ (48" x 288" x 1 1/2"H 605 lbs) | \$11,414 |
| | 300RAT288-54_ (54" x 288" x 1 1/2"H 680 lbs) | \$12,844 |
| Racetrack conference table top (three piece) - accomodates up to 24 chairs **Requires minimum of four (4) appropriately sized bases | | |

CONTEMPORARY - TRANSITIONAL CONFERENCE ROOM FURNITURE

List Price

Boat-Shaped Conference Table Tops



300BST72_ \$2158
Boat-Shaped conference table top (one piece) - accomodates up to 6 chairs
36" x 72" x 1 1/2"H (140 lbs)
**Requires minimum of two (2) appropriately sized bases

300BST84_ \$2974
Boat-Shaped conference table top (one piece) - accomodates up to 6 chairs
42" x 84" x 1 1/2"H (160 lbs)
**Requires minimum of two (2) appropriately sized bases

300BST96_ (42" x 96" x 1 1/2"H 215 lbs) \$3789
300BST96-48_ (48" x 96" x 1 1/2"H 230 lbs) \$4332
Boat-Shaped conference table top (one piece) - accomodates up to 8 chairs
**Requires minimum of two (2) appropriately sized bases

300BST120_ (48" x 120" x 1 1/2"H 250 lbs) \$4292
300BST120-54_ (54" x 120" x 1 1/2"H 280 lbs) \$4831
Boat-Shaped conference table top (two piece) - accomodates up to 10 chairs
**Requires minimum of three (3) appropriately sized bases

300BST144_ (48" x 144" x 1 1/2"H 300 lbs) \$5426
300BST144-54_ (54" x 144" x 1 1/2"H 335 lbs) \$6110
Boat-Shaped conference table top (two piece) - accomodates up to 12 chairs
**Requires minimum of three (3) appropriately sized bases

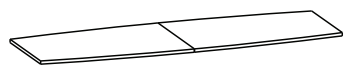

300BST168_ (48" x 168" x 1 1/2"H 350 lbs) \$6312
300BST168-54_ (54" x 168" x 1 1/2"H 395 lbs) \$7104
Boat-Shaped conference table top (two piece) - accomodates up to 14 chairs
**Requires minimum of three (3) appropriately sized bases

300BST192_ (48" x 192" x 1 1/2"H 400 lbs) \$7199
300BST192-54_ (54" x 192" x 1 1/2"H 450 lbs) \$8102
Boat-Shaped conference table top (two piece) - accomodates up to 16 chairs
**Requires minimum of three (3) appropriately sized bases

300BST216_ (48" x 216" x 1 1/2"H 450 lbs) \$8086
300BST216-54_ (54" x 216" x 1 1/2"H 505 lbs) \$9100
Boat-Shaped conference table top (two piece) - accomodates up to 18 chairs
**Requires minimum of three (3) appropriately sized bases

300BST240_ (48" x 240" x 1 1/2"H 505 lbs) \$9168
300BST240-54_ (54" x 240" x 1 1/2"H 570 lbs) \$10,317
Boat-Shaped conference table top (three piece) - accomodates up to 20 chairs
**Requires minimum of four (4) appropriately sized bases



300BST288_ (48" x 288" x 1 1/2"H 605 lbs) \$11,232
300BST288-54_ (54" x 288" x 1 1/2"H 680 lbs) \$12,668
Boat-Shaped conference table top (three piece) - accomodates up to 24 chairs
**Requires minimum of four (4) appropriately sized bases

CONTEMPORARY - TRANSITIONAL CONFERENCE ROOM FURNITURE

List Price

Round Conference Table Tops

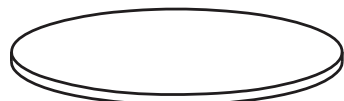

300ROT60_ \$1774

Round conference table top
**accomodates up to 6 chairs
60" diameter x 1 1/2"H (95 lbs)

300ROT54_ \$1534

Round conference table top
**accomodates up to 5 chairs
54" diameter x 1 1/2"H (85 lbs)

300ROT48_ \$1297

Round conference table top
**accomodates up to 4 chairs
48" diameter x 1 1/2"H (75 lbs)

300ROT42_ \$1118

Round conference table top
**accomodates up to 4 chairs
42" diameter x 1 1/2"H (62 lbs)

300ROT36_ \$940

Round conference table top
**accomodates up to 3 chairs
36" diameter x 1 1/2"H (50 lbs)

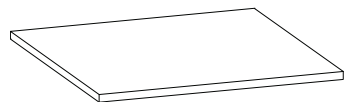

300SQT48_ \$1130

Square conference table top
**accomodates up to 4 chairs
48" x 48" x 1 1/2"H (75 lbs)

300SQT42_ \$951

Square conference table top
**accomodates up to 4 chairs
42" x 42" x 1 1/2"H (65 lbs)

300SQT36_ \$772

Square conference table top
**accomodates up to 4 chairs
36" x 36" x 1 1/2"H (55 lbs)

300SQT30_ \$593

Square conference table top
**accomodates up to 4 chairs
30" x 30" x 1 1/2"H (45 lbs)

CONTEMPORARY - TRANSITIONAL CONFERENCE ROOM FURNITURE

List Price

Table Bases

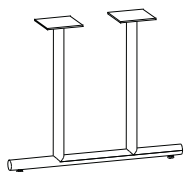

12CRDTB (chrome finish) \$642
12PWDTB (black finish) \$528
 Double T-base (for use with 48"-54" depth tops only)
 34" x 34" x 27 3/4"H (36 lbs)

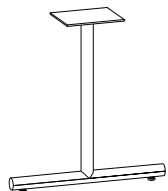

12CRTB (chrome finish) \$440
12PWTB (black finish) \$363
 T-base (for use with 36"-42" depth tops only)
 26" x 26" x 27 3/4"H (20 lbs)

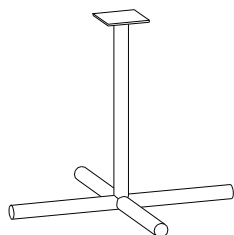

12CRFPB38 (chrome finish) \$670
12PWFPB38 (black finish) \$536
 X-base (for use with 54" depth tops only)
 38" x 38" x 27 3/4"H (35 lbs)

12CRFPB32 (chrome finish) \$592
12PWFPB32 (black finish) \$511
 X-base (for use with 42"-48" depth tops only)
 32" x 32" x 27 3/4"H (30 lbs)

12CRFPB26 (chrome finish) \$458
12PWFPB26 (black finish) \$390
 X-base (for use with 36" depth tops only)
 26" x 26" x 27 3/4"H (20 lbs)

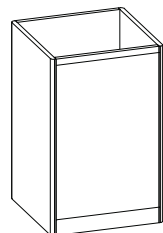

300WSB28WM \$1108
 Square wire mgmt base (for use with 54" & 60" depth tops only)
 hinged door with 26" x 26" opening in base for wire mgmt
 28" x 28" x 27 3/4"H (75 lbs)

300WSB22WM \$978
 Square wire mgmt base (for use with 48" depth tops only)
 hinged door with 20" x 20" opening in base for wire mgmt
 22" x 22" x 27 3/4"H (50 lbs)

300WSB18WM \$886
 Square wire mgmt base (for use with 36"-42" depth tops only)
 hinged door with 16" x 16" opening in base for wire mgmt
 18" x 18" x 27 3/4"H (40 lbs)

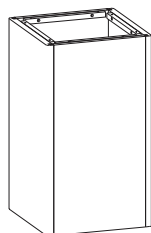

300WSB28 \$1025
 Square base (for use with 54" & 60" depth tops only)
 softened edges
 28" x 28" x 27 3/4"H (75 lbs)

300WSB22 \$891
 Square base (for use with 48" depth tops only)
 softened edges
 22" x 22" x 27 3/4"H (50 lbs)

300WSB18 \$805
 Square base (for use with 36"-42" depth tops only)
 softened edges
 18" x 18" x 27 3/4"H (40 lbs)

CONTEMPORARY - TRANSITIONAL CONFERENCE ROOM FURNITURE

List Price

Table Bases

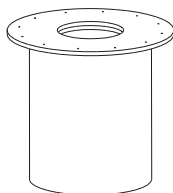

300WCB28 \$1513

Full cylinder base (for use with 54" & 60" depth tops)
28" diameter x 27 3/4"H (90 lbs)

300WCB28WM with wire management access panel \$1706

300WCB22 \$948

Full cylinder base (for use with 48" depth tops)
22" diameter x 27 3/4"H (90 lbs)

300WCB22WM with wire management access panel \$1141

300WCB18 \$787

Full cylinder base (for use with 36"-42" depth tops)
18" diameter x 27 3/4"H (90 lbs)

300WCB18WM with wire management access panel \$980

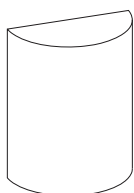

300WHCB28 \$1868

Half cylinder base (for use with 54" depth tops)
28" diameter x 27 3/4"H (40 lbs)

300WHCB28WM with wire management access panel \$2061

300WHCB22 \$1118

Half cylinder base (for use with 48" depth tops)
22" diameter x 27 3/4"H (34 lbs)

300WHCB22WM with wire management access panel \$1311

300WHCB18 \$944

Half cylinder base (for use with 36"-42" depth tops)
18" diameter x 27 3/4"H (30 lbs)

300WHCB18WM with wire management access panel \$1137

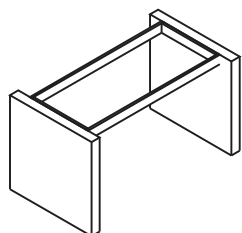

300PBA72 (24" x 45 3/4" x 27 3/4"H) 105 lbs \$1429

Two panel base with apron rails for use with 72" tops
Optional wire management bases with hinged door (WM) - add \$385

300PBA84 (24" x 51 3/4" x 27 3/4"H) 107 lbs \$1436

Two panel base with apron rails for use with 84" tops
Optional wire management bases with hinged door (WM) - add \$385

300PBA96 (24" x 51 3/4" x 27 3/4"H) 108 lbs \$1445

300PBA96-48 (36" x 51 3/4" x 27 3/4"H) \$1586

Two panel base with apron rails for use with 96" tops
Optional wire management bases with hinged door (WM) - add \$385

300PBA120 (30" x 88 1/2" x 27 3/4"H) 157 lbs \$1760

300PBA120-54 (36" x 88 1/2" x 27 3/4"H) \$1940

Three panel base with apron rails for use with 120" tops
Optional wire management bases with hinged door (WM) - add \$578

300PBA144 (30" x 112 1/2" x 27 3/4"H) 160 lbs \$1765

300PBA144-54 (36" x 112 1/2" x 27 3/4"H) \$1947

Three panel base with apron rails for use with 144" tops
Optional wire management bases with hinged door (WM) - add \$578

300PBA168 (30" x 136 1/2" x 27 3/4"H) 163 lbs \$1775

300PBA168-54 (36" x 136 1/2" x 27 3/4"H) \$1955

Three panel base with apron rails for use with 168" tops
Optional wire management bases with hinged door (WM) - add \$578

300PBA192 (30" x 160 1/2" x 27 3/4"H) 166 lbs \$1782

300PBA192-54 (36" x 160 1/2" x 27 3/4"H) \$1962

Three panel base with apron rails for use with 192" tops
Optional wire management bases with hinged door (WM) - add \$578

300PBA216 (30" x 184 1/2" x 27 3/4"H) 169 lbs \$1794

300PBA216-54 (36" x 184 1/2" x 27 3/4"H) \$1974

Three panel base with apron rails for use with 216" tops
Optional wire management bases with hinged door (WM) - add \$578

300PBA240 (30" x 213 3/4" x 27 3/4"H) \$2068

300PBA240-54 (36" x 213 3/4" x 27 3/4"H) \$2286

Four panel base with apron rails for use with 240" tops
Optional wire management bases with hinged door (WM) - add \$770

300PBA288 (30" x 240 3/4" x 27 3/4"H) \$2099

300PBA288-54 (36" x 240 3/4" x 27 3/4"H) \$2317

Four panel base with apron rails for use with 288" tops
Optional wire management bases with hinged door (WM) - add \$770

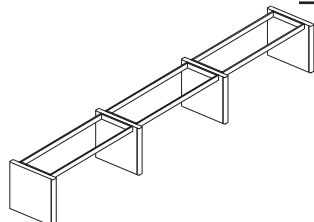
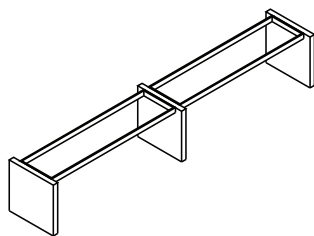

CONTEMPORARY - TRANSITIONAL CONFERENCE ROOM FURNITURE

List Price

Work Tables

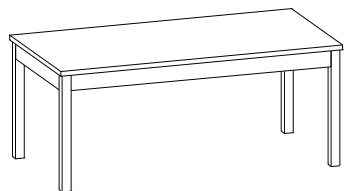

300WLT84_ \$2818
Work table, solid wood legs
42" x 84" x 29"H (200 lbs)

300WLT72_ \$2417
Work table, solid wood legs
36" x 72" x 29"H (145 lbs)

300WLT60_ \$2087
Work table, solid wood legs
30" x 60" x 29"H (110 lbs)

300WLT4830_ \$1670
Work table, solid wood legs
30" x 48" x 29"H (75 lbs)

300WLT48_ \$1337
Work table, solid wood legs
24" x 48" x 29"H (60 lbs)

Occasional Tables

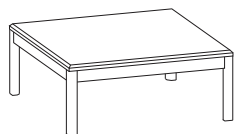

300MT36SQ_ \$1633
Square magazine table, solid wood legs
36" x 36" x 16"H (70 lbs)

300MT30SQ_ \$1472
Square magazine table, solid wood legs
30" x 30" x 16"H (60 lbs)

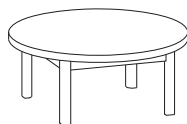

300MT36RO_ \$1685
Round magazine table, solid wood legs
36" x 36" x 16"H (70 lbs)

300MT30RO_ \$1517
Round magazine table, solid wood legs
30" x 30" x 16"H (60 lbs)

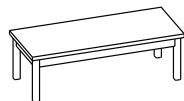

300MT48_ \$1206
Magazine table, solid wood legs
20" x 48" x 16"H (58 lbs)



300CT24RO_ \$942
Round occasional table, solid wood legs
24" x 24" x 23"H (40 lbs)

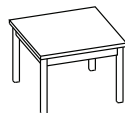

300CT2828_ \$985
Corner table, solid wood legs
28" x 28" x 23"H (47 lbs)

300CT2222_ \$812
Corner table, solid wood legs
22" x 22" x 23"H (40 lbs)



300ET2028_ \$932
Corner table, solid wood legs
20" x 28" x 23"H (40 lbs)

ACCESSORIES



Various accessories may be added to any of the series offerings to enhance storage, data, electrical or wiring capabilities as needed. Most accessories can be factory installed (contact customer service for additional information)

ACCESSORIES

List Price

Power Options



EC-PD01SP (silver pearl) \$1926
EC-PD01PB (black) \$1926
 15" x 9 1/8"
 Decorative table trough w/ retractable doors, 6 power receptacles and 2 telecom plate cutouts.
 108" power cord w/molded plug.
 Factory installed (note location on order)
 (15lbs)



EC-PD02SP (silver pearl) \$3311
EC-PD02PB (black) \$3311
 30" x 9 1/8"
 Decorative table trough w/retractable doors, 12 power receptacles and 4 telecom plate cutouts.
 108" power cord w/molded plug.
 Factory installed (note location on order)
 (21lbs)



EC-PD03SP (silver pearl) \$582
EC-PD03PB (black) \$582
 9" x 5 3/8"
 2 power receptacles, 2 - 2.1 amp USB, 1 telecom plate cutout, knockouts for
 2 RJ45 Cat6 data and 2 cord pass throughs. 1 Convenience Outlet. 72" corded.
 Factory installed (note location on order)
 (7lbs)

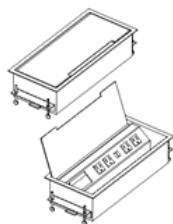

EC-PD04SP (silver pearl) \$1203
EC-PD04PB (black) \$1203
 14 1/4" x 6 3/8"
 4 power receptacles, 2 - 2.1 amp USB and 3 telecom plate cutouts.
 1 Convenience Outlet. 72" corded.
 Factory installed (note location on order)
 (11lbs)

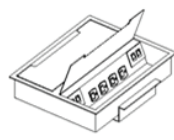

EC-PD05SP (silver pearl) \$1629
EC-PD05PB (black) \$1629
 14 1/4" x 11 1/2"
 Double Sided Tabletop Unit with 8 power receptacles and 8 telecom plate cutouts.
 Two 72" cords.
 Factory installed (note location on order)
 (18lbs)

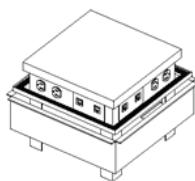

EC-PD06 \$2569
 13 1/8" x 13 1/8"
 Gas spring manual lift with 8 power receptacles and 4 telecom plate cutouts.
 Black trim kit bezel with wire management brush included. Wood top cap. 72" corded.
 Unit must be installed within a properly sized square or cylinder base.
 Factory installed (note location on order)
 (33lbs)

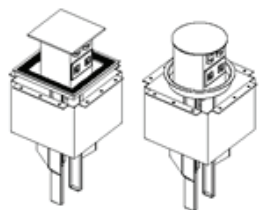

EC-PD07BLRD (round top w/ black finish) \$1341
EC-PD07SSRD (round top w/ brushed stainless steel finish) \$1962
 7 1/4" x 7 1/4"

EC-PD07BLSQ (square top w/ black finish) \$1532
EC-PD07SSSQ (square top w/ brushed stainless steel finish) \$2200
 5 13/16" dia

Manual lift with 4 power receptacles and 2 telecom plate cutouts.
 Includes top and trim kit. 72" corded.
 Unit must be installed within a properly sized square or cylinder base.
 Factory installed (note location on order)
 (15lbs)

ACCESSORIES

List Price

Power Options



BE-PD08AL (silver anodized aluminum)

\$466

BE-PD08BL (black anodized aluminum)

\$606

8 3/8" X 4 3/8"

Fluid one touch to open door that remains open during use. Two 120 volt, 15 amp power receptacles and two open data ports. Includes adapter kit to accept most voice/data connections from port manufacturers. 72" power cord with molded plug. UL listed component.

Factory installed (note location on order) (4lbs)

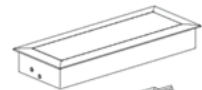

BE-PD09AL (silver anodized aluminum)

\$514

BE-PD09BL (black anodized aluminum)

\$668

11 3/8" X 4 3/8"

Fluid one touch to open door that remains open during use. Three 120 volt, 15 amp power receptacles and three open data ports. Includes adapter kit to accept most voice/data connections from port manufacturers. 72" power cord with molded plug. UL listed component.

Factory installed (note location on order) (5lbs)

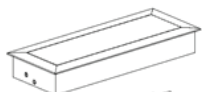

BE-PD10AL (silver anodized aluminum)

\$637

BE-PD10BL (black anodized aluminum)

\$794

11 3/8" X 4 3/8"

Fluid one touch to open door that remains open during use. Two 120 volt, 15 amp power receptacles, one USB 2-Port Simplex Charger and three open data ports. Includes adapter kit to accept most voice/data connections from port manufacturers. 72" power cord with molded plug. UL listed component.

Factory installed (note location on order) (5lbs)

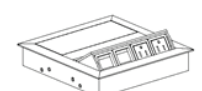

BE-PD14AL (silver anodized aluminum)

\$965

BE-PD14BL (black anodized aluminum)

\$1255

8 3/8" X 8 1/16"

Fluid one touch to open doors that remains open during use. Two 120 volt, 15 amp power receptacles and two open data ports each side. Includes adapter kit to accept most voice/data connections from port manufacturers. Two 72" power cords with molded plug. UL listed component.

Factory installed (note location on order) (7lbs)



BE-PD15AL (silver anodized aluminum)

\$1232

BE-PD15BL (black anodized aluminum)

\$1602

11 3/8" X 8 1/16"

Fluid one touch to open doors that remains open during use. Three 120 volt, 15 amp power receptacles and three open data ports each side. Includes adapter kit to accept most voice/data connections from port manufacturers. Two 72" power cords with molded plug. UL listed component.

Factory installed (note location on order) (8lbs)

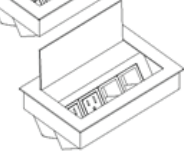
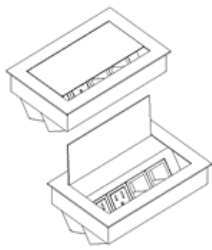

BE-PD16AL (silver anodized aluminum)

\$551

BE-PD16BL (black anodized aluminum)

\$715

8 3/8" X 5 3/8"

Two 120 volt, 15 amp power receptacles and two open data ports. Includes adapter kit to accept most voice/data connections from port manufacturers. 72" power cord with molded plug. UL listed component.

Factory installed (note location on order) (4lbs)

ACCESSORIES

List Price

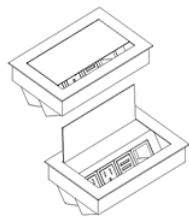

BE-PD17AL (silver anodized aluminum) \$665
BE-PD17BL (black anodized aluminum) \$830
 8 3/8" X 5 3/8"
 Two 120 volt, 15 amp power receptacles, one USB 2-Port Simplex Charger and one open data port. Includes adapter kit to accept most voice/data connections from port manufacturers. 72" power cord with molded plug. UL listed component. Factory installed (note location on order) (5lbs)

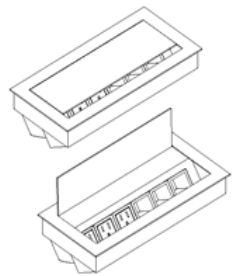

BE-PD18AL (silver anodized aluminum) \$592
BE-PD18BL (black anodized aluminum) \$770
 11 3/8" X 5 3/8"
 Three 120 volt, 15 amp power receptacles and three open data ports. Includes adapter kit to accept most voice/data connections from port manufacturers. 72" power cord with molded plug. UL listed component. Factory installed (note location on order) (5lbs)

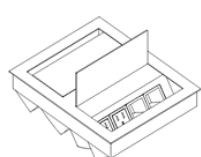

BE-PD19AL (silver anodized aluminum) \$957
BE-PD19BL (black anodized aluminum) \$1244
 8 3/8" X 10 3/16"
 Two 120 volt, 15 amp power receptacles and two open data ports. Includes adapter kit to accept most voice/data connections from port manufacturers. 72" power cord with molded plug. UL listed component. Factory installed (note location on order) (7lbs)

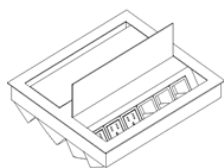

BE-PD20AL (silver anodized aluminum) \$1070
BE-PD20BL (black anodized aluminum) \$1391
 11 3/8" X 10 3/16"
 Three 120 volt, 15 amp power receptacles and three open data ports. Includes adapter kit to accept most voice/data connections from port manufacturers. 72" power cord with molded plug. UL listed component. Factory installed (note location on order) (8lbs)

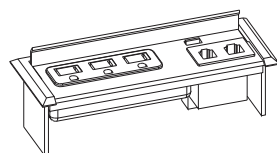

FC-727 (black) \$386
 7 9/16" x 2 7/8" Power/communication center - black with door. Surface mounted with one RJ-45 (data), one RJ-11 (phone), one USB port and three simplex outlets. Factory installed (note location on order) 2 lbs

Wire Management Options



200GR \$61
 Wire management grommet
 4 1/8" x 2 11/16" x 1 1/8"H - black
 factory installed (note location on order)



LH \$83
 Wire management channel, 22" length - set of four, double sided velcro attachment (4 lbs)



CL \$65
 Velcro wire management (secures wires) - set of four, double sided table attachment (1 lbs)



WA No charge
 Wall access cut-out (modesty panels on bridges, credenzas, desks and return) specify location on order.

Type 1 Telecom Plates/Jacks

List Price

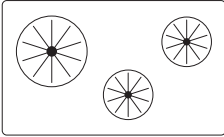
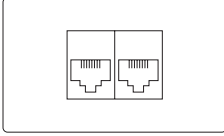
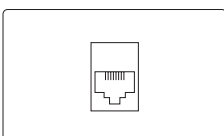
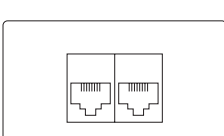
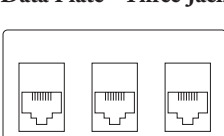
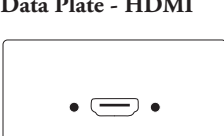
| | | | | |
|--|---|-------|----------------|--------------|
| Data Plate - Blank Cap | 1 3/4 | 3 1/8 | EC-TP01 | \$9 |
|  | <ul style="list-style-type: none"> • for use in any EC-PD_____ power module | | | |
| Data Plate - Three Cord Bushings | 1 3/4 | 3 1/8 | EC-TP02 | \$43 |
|  | <ul style="list-style-type: none"> • for use in any EC-PD_____ power module | | | |
| Data Plate - Two Jacks | 1 3/4 | 3 1/8 | EC-TP03 | \$108 |
|  | <ul style="list-style-type: none"> • one RJ11 Cat3 Jack • one RJ-45 Cat6 Jack • for use in any EC-PD_____ power module | | | |
| Data Plate - One Jack | 1 3/4 | 3 1/8 | EC-TP04 | \$76 |
|  | <ul style="list-style-type: none"> • one RJ-45 Cat6 jack • for use in any EC-PD_____ power module | | | |
| Data Plate - Two Jacks | 1 3/4 | 3 1/8 | EC-TP05 | \$144 |
|  | <ul style="list-style-type: none"> • two RJ-45 Cat6 jacks • for use in any EC-PD_____ power module | | | |
| Data Plate - Three Jacks | 1 3/4 | 3 1/8 | EC-TP06 | \$210 |
|  | <ul style="list-style-type: none"> • three RJ-45 Cat6 jacks • for use in any EC-PD_____ power module | | | |
| Data Plate - HDMI | 1 3/4 | 3 1/8 | EC-TP07 | \$167 |
|  | <ul style="list-style-type: none"> • one HDMI female to female with 36" cord • for use in any EC-PD_____ power module | | | |

Type 1 Telecom Plates/Jacks

List Price

Data Plate - VGA and Mini-Stereo

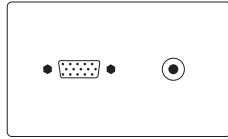

| | | | |
|-------|-------|---------|-------|
| 1 3/4 | 3 1/8 | EC-TP08 | \$173 |
|-------|-------|---------|-------|

- one VGA female to female with 72" cord
- one Mini-Stereo Inline
- for use in any EC-PD_ _ _ _ power module

Data Plate - VGA, HDMI and Mini-Stereo

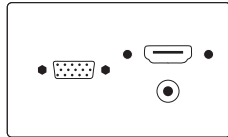

| | | | |
|-------|-------|---------|-------|
| 1 3/4 | 3 1/8 | EC-TP09 | \$327 |
|-------|-------|---------|-------|

- one VGA female to female with 72" cord
- one HDMI female to female with 36" cord
- one Mini-Stereo Inline
- for use in any EC-PD_ _ _ _ power module

Data Plate - USB 3.0

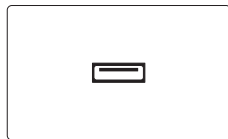

| | | | |
|-------|-------|---------|-------|
| 1 3/4 | 3 1/8 | EC-TP10 | \$193 |
|-------|-------|---------|-------|

- one USB 3.0 Type A/A with 36" patch cord with male end
- for use in any EC-PD_ _ _ _ power module
- data transfer port
- can become powered USB charging port with addition of EC-TP10-POW power supply

USB Charging - Power Supply

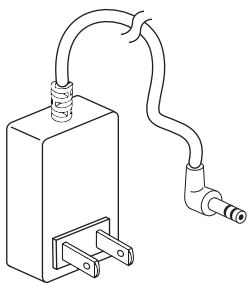

| | | | |
|--|--|-------------|-------|
| | | EC-TP10-POW | \$117 |
|--|--|-------------|-------|

- USB power supply
- for use with EC-TP10
- converts EC-TP10 into USB charging port
- power source under table or from building required to power unit

Type 3 Telecom Jacks

List Price

HDMI Connector

BE-VD01

\$86

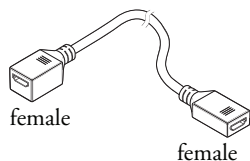

- HDMI coupler
- 18" cord
- female to female connection
- for use in any BE-PD_ _ _ _ power module
- uses data adapter kit BB adapter plate

Mini Stereo Jack

BE-VD02

\$24

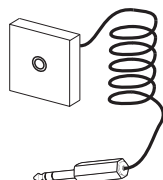

- 3.5 mm Mini Stereo Jack
- 10 foot cord
- female to male connection
- for use in any BE-PD_ _ _ _ power module
- installs directly into unit without need of data adapter kit

Network Jack

BE-VD03

\$78

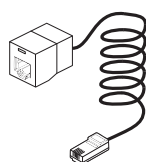

- Cat6 RJ-45 Panduit Jack
- Pre-terminated
- 10 foot cord
- 8-Pin
- for use in any BE-PD_ _ _ _ power module. also for use in EC-PD03_ _.
- uses data adapter kit FF adapter plate

Voice Coupler

BE-VD04

\$78

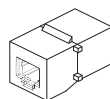

- AMP Category 3, RJ-11
- 6-Pin
- connects to standard phone cord
- for use in any BE-PD_ _ _ _ power module
- uses data adapter kit CC adapter plate

Data Jack - VGA 15 Pin

BE-VD05

\$108

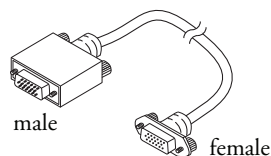

- 120" M/F cable - female-to-male connection
- 15 pin connections
- provides electronic device to remove display connection
- for use in any BE-PD_ _ _ _ power module
- uses data adapter kit HH adapter plate

Dual Powered USB Charging

BE-VD06

\$144

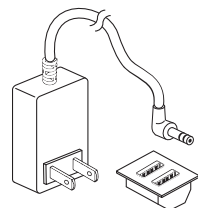

- two (2) USB-A connections for USB powered devices or charging mobile electronics
- 2000mA (2 amp) charging power per USB port
- black or white option
- for use in any BE-PD_ _ _ _ power module
- installs directly into unit without need of data adapter kit

Data Jack - USB 3.0

BE-VD07

\$78

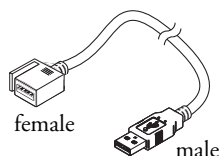

- USB 3.0 data jack with 10' cord and male plug
- for use in any BE-PD_ _ _ _ power module
- data transfer port - no USB charging capability
- data transfer speed up to 5gbs/sec
- uses data adapter kit HH adapter plate

Data Adapter Applications

Data Adapter Applications

Data adapter kits ship with each power and data unit.

Adapter plates are marked on the back with letter designators to indicate the data jack manufacturer, series and style. Websites are listed below for quick reference to verify data jack series or style.

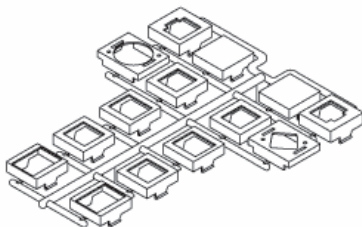

Included with any BE-PD_____power module

NOTE: Verify fit of data jack in adapter before ordering large quantities as manufacturer designs may change without notice.

| Adapter | Manufacturer | Website |
|---------|--|--|
| AA | Uniprise/Systemax/Avaya | www.unipriseresolutions.com |
| BB | Tyco SL and 100 Connect Series Modular Jacks | www.ampconnect.com |
| BB | Siemon Keystone Style | www.siemon.com |
| BB | Allen Tel Versa Tap Series | www.allentel.com |
| BB | Leviton Quick Port® Series | www.leviton.com |
| BB | Nordx Keystone Style | www.nordx.com |
| CC | Tyco SL Coupler Series | www.ampconnect.com |
| CC | Krone 6000 Series | www.adc.com |
| CC | Hubbell Xcelerator™ Keystone Series | www.hubbell.com |
| DD | Blank (no coupler/jack) | |
| EE | Ortronics TracJack Series | www.ortronics.com |
| FF | Panduit Mini-Com Series | www.panduit.com |
| GG | Microphone jack/3-pin XLR, solder type only | |
| HH | Video Monitor jack/DB-15, panel mount solder style | |

ACCESSORIES

List Price

Lighting Options



TL48 \$215
Task light, high efficiency (UL approved)
6" x 48" x 1 1/2"H (15 lbs)

TL36 \$197
Task light, high efficiency (UL approved)
6" x 36" x 1 1/2"H (15 lbs)

TL24 \$185
Task light, high efficiency (UL approved)
6" x 24" x 1 1/2"H (15 lbs)



TL31LED-S \$560
31" stand-alone or starter LED energy efficient light. ETL listed. Soft-touch switching with instant on to fade way off. Infinite dimming with last state memory. Automatic off after 10 hours. Includes power supply.
31" x 2" x 1 1/2"H (4 lbs)

TL17LED-S \$454
17" stand-alone or starter LED energy efficient light. ETL listed. Soft-touch switching with instant on to fade way off. Infinite dimming with last state memory. Automatic off after 10 hours. Includes power supply.
17" x 2" x 1 1/2"H (2 lbs)



TL31LED-A \$494
31" adder LED energy efficient light for linking to a starter task light. ETL listed. Soft-touch switching with instant on to fade way off. Infinite dimming with last state memory. Automatic off after 10 hours.
31" x 2" x 1 1/2"H (4 lbs)

TL17LED-A \$311
17" adder LED energy efficient light for linking to a starter task light. ETL listed. Soft-touch switching with instant on to fade way off. Infinite dimming with last state memory. Automatic off after 10 hours.
17" x 2" x 1 1/2"H (2 lbs)



TL03-OCPS \$305
Occupancy sensor, integrates with above LED light options. Automatic off after 30 minutes of inactivity. Connects to end of light fixture (adds 3" to length of fixture). One sensor controls starter and connected adders.
3" x 2" x 1 1/2"H (1 lbs)

Monitor Mount Options

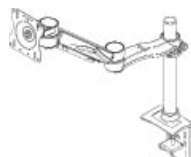

SSM-7815H \$388
Single-screen Monitor adjustable mount, double extension with one height adjustable segment, quick connect clamp, available in silver or black finish (10 lbs)



DSM-7815H \$738
Double-screen Monitor adjustable mount, two double extension with one height adjustable segment per screen, quick connect clamp, available in silver or black finish (15 lbs)

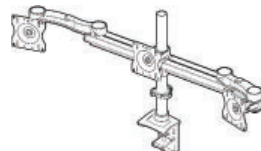

TSM-7815H \$780
Triple-screen Monitor adjustable mount, two single extension arms, one pole mounted arm on a single beam, quick connect clamp, available in silver or black finish (10 lbs)

Desk Systems / Toolbars



CPFS-48 \$360
Worksurface mounted desk system / toolbar, 48" slat wall section - that can be combined into multi sectional desking system. Two paper trays, one binder holder, one accessory tray and one folder sorter standard per 4' section. Connects with two end post clamps, 90 degree post are available - contact customer service for ordering.
48"W x 16 5/8"H, black finish (25 lbs)

ACCESSORIES

List Price

Printer Stands / Keyboards and CPU Holders

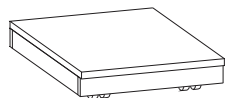

MPS
Mobile printer stand (on casters) - specify finish
19"W x 19"D x 6"H (20 lbs)

\$928

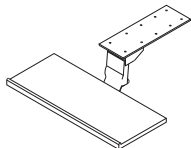

AKPW
Articulating keyboard - leverless, with non- handed mouse pad, 5" height adjustment, 25 degree tilt - 360 degree swivel, wooden keyboard tray - specify finish
11 1/4" x 21 1/2" x 2 3/4"H (25 lbs)

\$472

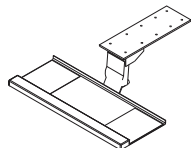

AKP
Articulating keyboard - leverless, with non- handed mouse pad, 5" height adjustment, 25 degree tilt - 360 degree swivel, black molded keyboard tray
11" x 25" x 2 3/4"H (21 lbs)

\$337

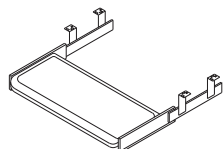

KD
Pull-out keyboard - leverless, black molded keyboard tray
10 5/8" x 21 1/2" x 3 5/8"H (15 lbs)

\$153

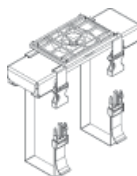

CPU-7325D
CPU holder, accomodates CPU's up to 75 lbs, 360 degree swivel, 17" track
(15 lbs)

\$92

Fabric Tackboards (Refer to desk fabric card for fabric selections)



TB48-12
Fabric tackboard, (COM, Grade A, Grade B) 3/4" x 48" x 12"H (11 lbs)

\$290

TB42-12
Fabric tackboard, (COM, Grade A, Grade B) 3/4" x 42" x 12"H (10 lbs)

\$256

TB84-8
Fabric tackboard, (COM, Grade A, Grade B) 3/4" x 84" x 8 3/4"H (20 lbs)

\$415

TB78-8
Fabric tackboard, (COM, Grade A, Grade B) 3/4" x 78" x 8 3/4"H (18 lbs)

\$394

TB72-8
Fabric tackboard, (COM, Grade A, Grade B) 3/4" x 72" x 8 3/4"H (16 lbs)

\$352

TB66-8
Fabric tackboard, (COM, Grade A, Grade B) 3/4" x 66" x 8 3/4"H (14 lbs)

\$325

TB60-8
Fabric tackboard, (COM, Grade A, Grade B) 3/4" x 60" x 8 3/4"H (12 lbs)

\$311

TB48-8
Fabric tackboard, (COM, Grade A, Grade B) 3/4" x 48" x 8 3/4"H (11 lbs)

\$293

TB42-8
Fabric tackboard, (COM, Grade A, Grade B) 3/4" x 42" x 8 3/4"H (10 lbs)

\$277



TRADITIONAL RECEPTION STATIONS



Reception stations, the first impression expressed to visitors in your office. Traditional styling to coordinate with your other office settings, available in a selection of 15 walnut, cherry, oak and mahogany finishes.

TRADITIONAL RECEPTION STATIONS

Finishes Available

Walnut

Natural Walnut



Richleigh Walnut



Royal Walnut



Empire Walnut



Old World Mahogany



Crescent Cherry on Walnut

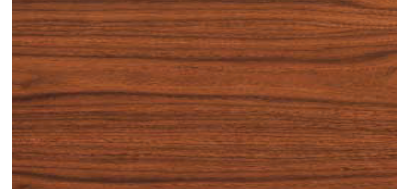

Espresso



Cherry

Natural Cherry



Amber Cherry



Cinnamon Cherry

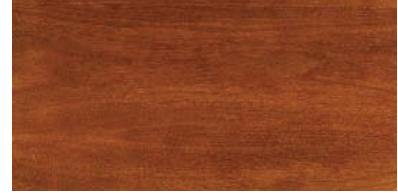

Collector's Cherry



Mocha Cherry



Mahogany on Cherry



Oak

Landmark Oak



Harbor Oak



**The finishes shown on this page have been reproduced as accurately as possible, however, due to the printing process some finishes may vary slightly from the actual finish samples originally photographed. In addition, due to the nature of wood, it is possible that some slight variations in color and grain character may occur naturally (which is the beauty of a natural product). Wood finish chips are available for each of the above finishes if requested (please call customer service).

TRADITIONAL RECEPTION STATIONS

Warranty and Certification

All products listed are warranted against defects of material and workmanship under normal use and service for a minimum of 10 years from the date of installation (see full warranty information). All products listed are Level 2 BIFMA certified.

Veneer

Veneer on all exposed surfaces is American Black Walnut, Cherry, Maple or White Oak. Outside surface veneers are book matched to provide proper grain consistency and uniform grain appearance.

Wood Veneer Tops

1" thick tops utilizing 3-ply construction utilizing American Black Walnut, Cherry or White Oak. Solid cherry, oak or walnut lumber rims, shaped with a Traditional style edge detail. Top cores are high density particle board. Rims on all four sides are precisely mitered on all four corners. High pressure laminate tops are optional.

Drawers

Drawer sides and backs are wood, 7/16" thick. Drawer fronts are 3-ply hardwood construction, 3/4" thick with book matched veneers to provide proper grain consistency and uniform grain appearance. All drawers utilize five sided drawer construction. Drawers are assembled with dovetail construction in all four corners. Drawer bottoms are 7/32" 3-ply hardwood dado construction.

Doors

Doors are 3/4" thick 3-ply construction with vertical grain walnut, cherry or oak veneers and matched in selected sets to ensure proper veneer balance and uniform grain appearance. European style hidden hinges are used on doors where applicable. Tempered glass conforming to ASTM C 1048 is used in all glass doors.

Bases

Bases are solid hardwood mitered at all four corners. Units may be specified with conventional or Georgian scroll bases. Height adjustable leveling glides are mounted in each corner with a threaded metal insert capped with a nylon glide that is height adjustable to approx. 1 1/2" to ensure proper leveling of the unit to varying floor conditions.

Chassis Construction

Construction technique is mortise and tenon, groove and tenon, heavily glue blocked with hardwood cleats for maximum strength.

Filing

File drawers use an easily adjustable filing rail system which can be positioned to accommodate front to back or side to side letter or legal filing.

Finish

All exposed surfaces are finished with a UV inhibitor catalyzed varnish finish to ensure maximum durability, chemical resistance, color retention and clarity. All exterior surfaces are finished in the following multi-step sequence: sap stain, NGR stain, wash coat, wash coat sand, filler spray, filler wipe, sealer spray, sealer sand, varnish spray, varnish sand, varnish spray. Moisture content for all wooden parts is between 5 - 9% prior to sealing. Drawer interiors and exteriors are UV prefinished with sealer, sealer sand, and varnished. Custom finish matches are available, contact customer service for request.

Ordering Information

Use the following steps to correctly place your order:

- 1) Determine the correct model number for the item you are selecting - example:
55RSD8432 = Double pedestal reception desk
- 2) Determine the proper finish selection for the item - example:
**55RSD8432 - OW = Double pedestal reception desk
32" x 84" x 42"H, in Old World Mahogany finish**

TRADITIONAL RECEPTION STATIONS

List Price

Freestanding Reception Stations

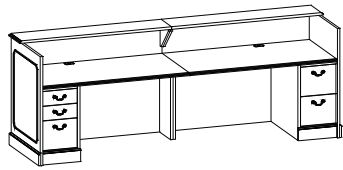

55RSD12032 **\$10,679**
 Double pedestal reception desk, box/box/file pedestal (LH), file/file pedestal (RH), pedestallocking, full modesty panel, two wire mgmt grommets in top, 87" kneespace
 30" worksurface height, 30"D worksurface, 12"D transaction counter
 32" x 120" x 42"H (420 lbs) **ships in two pieces
 Optional Glass Transaction Counter Riser (Specify Clear - add \$2332 list or Frosted - add \$3446 list)
 OptionalwithoutTransactionCounter(NTC)nocharge

55RSD10832 **\$9932**
 Double pedestal reception desk, box/box/file pedestal (LH), file/file pedestal (RH), pedestallocking, full modesty panel, two wire mgmt grommets in top, 75" kneespace
 30" worksurface height, 30"D worksurface, 12"D transaction counter
 32" x 108" x 42"H (360 lbs) **ships in two pieces
 Optional Glass Transaction Counter Riser (Specify Clear - add \$2275 list or Frosted - add \$3234 list)
 OptionalwithoutTransactionCounter(NTC)nocharge

55RSD9632 **\$9241**
 Double pedestal reception desk, box/box/file pedestal (LH), file/file pedestal (RH), pedestallocking, full modesty panel, two wire mgmt grommets in top, 63" kneespace
 30" worksurface height, 30"D worksurface, 12"D transaction counter
 32" x 96" x 42"H (300 lbs)
 Optional Glass Transaction Counter Riser (Specify Clear - add \$1580 list or Frosted - add \$2418 list)
 OptionalwithoutTransactionCounter(NTC)nocharge



55RSD8432 **\$8449**
 Double pedestal reception desk, box/box/file pedestal (LH), file/file pedestal (RH), pedestallocking, full modesty panel, two wire mgmt grommets in top, 51" kneespace
 30" worksurface height, 30"D worksurface, 12"D transaction counter
 32" x 84" x 42"H (264 lbs)
 Optional Glass Transaction Counter Riser (Specify Clear - add \$1280 list or Frosted - add \$2016 list)
 OptionalwithoutTransactionCounter(NTC)nocharge

55RSD7232 **\$7659**
 Double pedestal reception desk, box/box/file pedestal (LH), file/file pedestal (RH), pedestallocking, full modesty panel, two wire mgmt grommets in top, 39" kneespace
 30" worksurface height, 30"D worksurface, 12"D transaction counter
 32" x 72" x 42"H (310 lbs)
 Optional Glass Transaction Counter Riser (Specify Clear - add \$1195 list or Frosted - add \$1828 list)
 OptionalwithoutTransactionCounter(NTC)nocharge

Freestanding Dual Riser Reception Stations

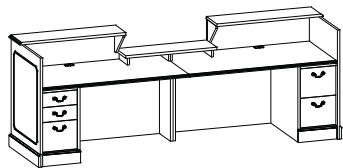

55RSDRR12032 **\$11,432**
 Double pedestal dual riser reception desk, box/box/file pedestal (LH), file/file pedestal (RH), pedestal locking, full modesty panel, two wire mgmt grommets in top, 87" kneespace
 30" worksurface height, 30"D worksurface, 12"D transaction counter
 32" x 120" x 42"H (420 lbs) **ships in two pieces
 Optional Glass Transaction Counter Riser (Specify Clear - add \$2258 list or Frosted - add \$3336 list)
 OptionalwithoutTransactionCounter(NTC)nocharge

55RSDRR10832 **\$10,685**
 Double pedestal dual riser reception desk, box/box/file pedestal (LH), file/file pedestal (RH), pedestal locking, full modesty panel, two wire mgmt grommets in top, 75" kneespace
 30" worksurface height, 30"D worksurface, 12"D transaction counter
 32" x 108" x 42"H (360 lbs) **ships in two pieces
 Optional Glass Transaction Counter Riser (Specify Clear - add \$2172 list or Frosted - add \$3149 list)
 OptionalwithoutTransactionCounter(NTC)nocharge

55RSDRR9632 **\$9999**
 Double pedestal dual riser reception desk, box/box/file pedestal (LH), file/file pedestal (RH), pedestal locking, full modesty panel, two wire mgmt grommets in top, 63" kneespace
 30" worksurface height, 30"D worksurface, 12"D transaction counter
 32" x 96" x 42"H (300 lbs)
 Optional Glass Transaction Counter Riser (Specify Clear - add \$2095 list or Frosted - add \$2984 list)
 OptionalwithoutTransactionCounter(NTC)nocharge

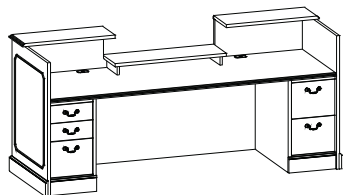

55RSDRR8432 **\$9210**
 Double pedestal dual riser reception desk, box/box/file pedestal (LH), file/file pedestal (RH), pedestal locking, full modesty panel, two wire mgmt grommets in top, 51" kneespace
 30" worksurface height, 30"D worksurface, 12"D transaction counter
 32" x 84" x 42"H (264 lbs)
 Optional Glass Transaction Counter Riser (Specify Clear - add \$2027 list or Frosted - add \$2832 list)
 OptionalwithoutTransactionCounter(NTC)nocharge

55RSDRR7232 **\$8421**
 Double pedestal dual riser reception desk, box/box/file pedestal (LH), file/file pedestal (RH), pedestal locking, full modesty panel, two wire mgmt grommets in top, 39" kneespace
 30" worksurface height, 30"D worksurface, 12"D transaction counter
 32" x 72" x 42"H (240 lbs)
 Optional Glass Transaction Counter Riser (Specify Clear - add \$1965 list or Frosted - add \$2695 list)
 OptionalwithoutTransactionCounter(NTC)nocharge

TRADITIONAL RECEPTION STATIONS

List Price

Computer Corner Reception Stations



55RSERL54FC / 55RSERL54FCCU (use with corner unit only) **\$4727**
 Transaction return (LH), file center pedestal (locking), two box, one file drawer top,
 one lateral file drawer bottom, one wire mgmt grommet in top
 21 1/2"W kneespace, 30"H worksurface height, 12"D transaction counter
 24" x 54" x 42"H (180 lbs)
 Optional Glass Transaction Counter Riser (Specify Clear - add \$1138 list or Frosted - add \$1617 list)
 Optional without Transaction Counter (NTC) - no upcharge



55RSERL48 / 55RSERL48CU (use with corner unit only) **\$4032**
 Transaction return (LH), box/box/file pedestal (locking), one wire mgmt grommet in top
 31 1/2"W kneespace, 30"H worksurface height, 12"D transaction counter
 24" x 48" x 42"H (150 lbs)
 Optional Glass Transaction Counter Riser (Specify Clear - add \$812 list or Frosted - add \$1247 list)
 Optional without Transaction Counter (NTC) - no upcharge

55RSERL42 / 55RSERL42CU (use with corner unit only) **\$3735**
 Transaction return (LH), box/box/file pedestal (locking), one wire mgmt grommet in top
 25 1/2"W kneespace, 30"H worksurface height, 12"D transaction counter
 24" x 42" x 42"H (135 lbs)
 Optional Glass Transaction Counter Riser (Specify Clear - add \$767 list or Frosted - add \$1143 list)
 Optional without Transaction Counter (NTC) - no upcharge

55RSERL36 / 55RSERL36 CU (use with corner unit only) **\$3440**
 Transaction return (LH), box/box/file pedestal (locking), one wire mgmt grommet in top
 19 1/2"W kneespace, 30"H worksurface height, 12"D transaction counter
 24" x 36" x 42"H (120 lbs)
 Optional Glass Transaction Counter Riser (Specify Clear - add \$724 list or Frosted - add \$1050 list)
 Optional without Transaction Counter (NTC) - no upcharge

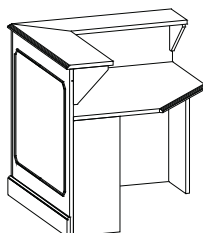

55RSCWS42 **\$4090**
 Corner unit - 42", one wire mgmt grommet in top
 30"H worksurface height, 12"D transaction counter
 42" x 42" x 42"H (200 lbs)
 Optional Glass Transaction Counter Riser (Specify Clear - add \$1950 list or Frosted - add \$2702 list)
 Optional without Transaction Counter (NTC) - no upcharge

55RSCWS36 **\$3639**
 Corner unit - 36", one wire mgmt grommet in top
 30"H worksurface height, 12"D transaction counter
 36" x 36" x 42"H (180 lbs)
 Optional Glass Transaction Counter Riser (Specify Clear - add \$1866 list or Frosted - add \$2515 list)
 Optional without Transaction Counter (NTC) - no upcharge

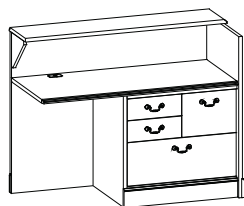

55RSERR54FC / 55RSERR54FCCU (use with corner unit only) **\$4727**
 Transaction return (RH), file center pedestal (locking), two box, one file drawer top,
 one lateral file drawer bottom, one wire mgmt grommet in top
 21 1/2"W kneespace, 30"H worksurface height, 12"D transaction counter
 24" x 54" x 42"H (180 lbs)
 Optional Glass Transaction Counter Riser (Specify Clear - add \$1138 list or Frosted - add \$1617 list)
 Optional without Transaction Counter (NTC) - no upcharge

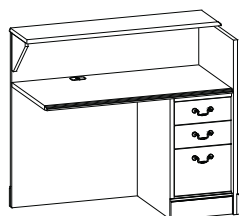

55RSERR48 / 55RSERR48CU (use with corner unit only) **\$4032**
 Transaction return (RH), box/box/file pedestal (locking), one wire mgmt grommet in top
 31 1/2"W kneespace, 30"H worksurface height, 12"D transaction counter
 24" x 48" x 42"H (150 lbs)
 Optional Glass Transaction Counter Riser (Specify Clear - add \$812 list or Frosted - add \$1247 list)
 Optional without Transaction Counter (NTC) - no upcharge

55RSERR42 / 55RSERR42CU (use with corner unit only) **\$3735**
 Transaction return (RH), box/box/file pedestal (locking), one wire mgmt grommet in top
 25 1/2"W kneespace, 30"H worksurface height, 12"D transaction counter
 24" x 42" x 42"H (135 lbs)
 Optional Glass Transaction Counter Riser (Specify Clear - add \$767 list or Frosted - add \$1143 list)
 Optional without Transaction Counter (NTC) - no upcharge

55RSERR36 / 55RSERR36CU (use with corner unit only) **\$3440**
 Transaction return (RH), box/box/file pedestal (locking), one wire mgmt grommet in top
 19 1/2"W kneespace, 30"H worksurface height, 12"D transaction counter
 24" x 36" x 42"H (120 lbs)
 Optional Glass Transaction Counter Riser (Specify Clear - add \$724 list or Frosted - add \$1050 list)
 Optional without Transaction Counter (NTC) - no upcharge

TRADITIONAL RECEPTION STATIONS

List Price

Reception Stations - Desk Shells

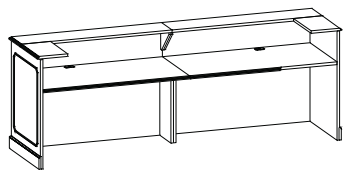

55RSD12031SH / 55RSD12031SHL (left) / 55RSD12031SHC (center) / 55RSD12031SHR (right) **\$7743**
 Single riser reception desk shell, two wire mgmt grommets in top,
 30" H work surface, 30" work surface, 12" D transaction counter
 31" x 120" x 42" H (334 lbs) **ships in two pieces
 Optional Glass Transaction Counter Riser (Specify Clear - add \$4198 list or Frosted - add \$5960 list)
 Optional without Transaction Counter (NTC) - no upcharge
 Optional Approach Transaction Counter Only (ATC) - no upcharge

55RSD10831SH / 55RSD10831SHL (left) / 55RSD10831SHC (center) / 55RSD10831SHR (right) **\$6999**
 Single riser reception desk shell, two wire mgmt grommets in top,
 30" H work surface, 30" work surface, 12" D transaction counter
 31" x 108" x 42" H (307 lbs) **ships in two pieces
 Optional Glass Transaction Counter Riser (Specify Clear - add \$4141 list or Frosted - add \$5749 list)
 Optional without Transaction Counter (NTC) - no upcharge
 Optional Approach Transaction Counter Only (ATC) - no upcharge

55RSD9631SH / 55RSD9631SHL (left) / 55RSD9631SHC (center) / 55RSD9631SHR (right) **\$6305**
 Single riser reception desk shell, two wire mgmt grommets in top,
 30" H work surface, 30" work surface, 12" D transaction counter
 31" x 96" x 42" H (281 lbs)
 Optional Glass Transaction Counter Riser (Specify Clear - add \$3446 list or Frosted - add \$4933 list)
 Optional without Transaction Counter (NTC) - no upcharge
 Optional Approach Transaction Counter Only (ATC) - no upcharge

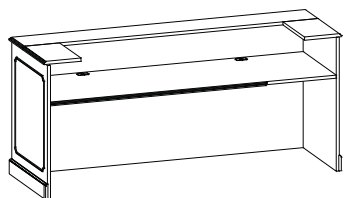

55RSD8431SH / 55RSD8431SHL (left) / 55RSD8431SHC (center) / 55RSD8431SHR (right) **\$5514**
 Single riser reception desk shell, two wire mgmt grommets in top,
 30" H work surface, 30" work surface, 12" D transaction counter
 31" x 84" x 42" H (260 lbs)
 Optional Glass Transaction Counter Riser (Specify Clear - add \$3145 list or Frosted - add \$4530 list)
 Optional without Transaction Counter (NTC) - no upcharge
 Optional Approach Transaction Counter Only (ATC) - no upcharge

55RSD7231SH / 55RSD7231SHL (left) / 55RSD7231SHC (center) / 55RSD7231SHR (right) **\$4722**
 Single riser reception desk shell, two wire mgmt grommets in top,
 30" H work surface, 30" work surface, 12" D transaction counter
 31" x 72" x 42" H (228 lbs)
 Optional Glass Transaction Counter Riser (Specify Clear - add \$3061 list or Frosted - add \$4342 list)
 Optional without Transaction Counter (NTC) - no upcharge
 Optional Approach Transaction Counter Only (ATC) - no upcharge

Dual Riser Reception Stations - Desk Shells

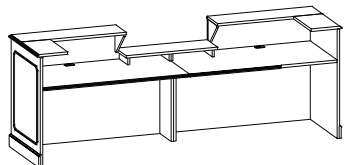

55RSDRR12031SH / 55RSDRR12031SHL (left) / 55RSDRR12031SHC (center) / 55RSDRR12031SHR (right) **\$8496**
 Dual riser reception desk shell, two wire mgmt grommets in top,
 30" H work surface, 30" work surface, 12" D transaction counter
 31" x 120" x 42" H (334 lbs) **ships in two pieces
 Optional Glass Transaction Counter Riser (Specify Clear - add \$4123 list or Frosted - add \$5850 list)
 Optional without Transaction Counter (NTC) - no upcharge
 Optional Approach Transaction Counter Only (ATC) - no upcharge

55RSDRR10831SH / 55RSDRR10831SHL (left) / 55RSDRR10831SHC (center) / 55RSDRR10831SHR (right) **\$7751**
 Dual riser reception desk shell, two wire mgmt grommets in top,
 30" H work surface, 30" work surface, 12" D transaction counter
 31" x 108" x 42" H (307 lbs) **ships in two pieces
 Optional Glass Transaction Counter Riser (Specify Clear - add \$4037 list or Frosted - add \$5663 list)
 Optional without Transaction Counter (NTC) - no upcharge
 Optional Approach Transaction Counter Only (ATC) - no upcharge

55RSDRR9631SH / 55RSDRR9631SHL (left) / 55RSDRR9631SHC (center) / 55RSDRR9631SHR (right) **\$7063**
 Dual riser reception desk shell, two wire mgmt grommets in top,
 30" H work surface, 30" work surface, 12" D transaction counter
 31" x 96" x 42" H (281 lbs)
 Optional Glass Transaction Counter Riser (Specify Clear - add \$3960 list or Frosted - add \$5498 list)
 Optional without Transaction Counter (NTC) - no upcharge
 Optional Approach Transaction Counter Only (ATC) - no upcharge

55RSDRR8431SH / 55RSDRR8431SHL (left) / 55RSDRR8431SHC (center) / 55RSDRR8431SHR (right) **\$6275**
 Dual riser reception desk shell, two wire mgmt grommets in top,
 30" H work surface, 30" work surface, 12" D transaction counter
 31" x 84" x 42" H (254 lbs)
 Optional Glass Transaction Counter Riser (Specify Clear - add \$3892 list or Frosted - add \$5346 list)
 Optional without Transaction Counter (NTC) - no upcharge
 Optional Approach Transaction Counter Only (ATC) - no upcharge

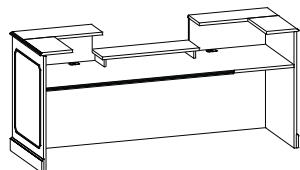

55RSDRR7231SH / 55RSDRR7231SHL (left) / 55RSDRR7231SHC (center) / 55RSDRR7231SHR (right) **\$5485**
 Dual riser reception desk shell, two wire mgmt grommets in top,
 30" H work surface, 30" work surface, 12" D transaction counter
 31" x 72" x 42" H (228 lbs)
 Optional Glass Transaction Counter Riser (Specify Clear - add \$3831 list or Frosted - add \$5210 list)
 Optional without Transaction Counter (NTC) - no upcharge
 Optional Approach Transaction Counter Only (ATC) - no upcharge

TRADITIONAL RECEPTION STATIONS

List Price

L Configuration Reception Stations - Executive Return Shells

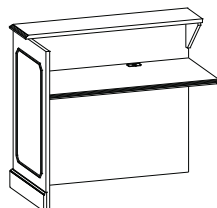

| | |
|--|---------------|
| 55RSERL72SH (left - shown) / 55RSERL72SHCU (use with corner unit only) | \$4070 |
| 55RSERR72SH (right) / 55RSERR72SHCU (use with corner unit only) | \$4070 |
| Executive height return shell, one wire mgmt grommet in top, 30"H worksurface, 23" worksurface, 12"D transaction counter 24" x 72" x 42"H (173 lbs) Optional Glass Transaction Counter Riser (Specify Clear - add \$1195 list or Frosted - add \$1828 list) Optional without Transaction Counter (NTC) - no upcharge | |
| 55RSERL60SH (left - shown) / 55RSERL60SHCU (use with corner unit only) | \$3435 |
| 55RSERR60SH (right) / 55RSERR60SHCU (use with corner unit only) | \$3435 |
| Executive height return shell, one wire mgmt grommet in top, 30"H worksurface, 23" worksurface, 12"D transaction counter 24" x 60" x 42"H (149 lbs) Optional Glass Transaction Counter Riser (Specify Clear - add \$1166 list or Frosted - add \$1723 list) Optional without Transaction Counter (NTC) - no upcharge | |
| 55RSERL54SH (left - shown) / 55RSERL54SHCU (use with corner unit only) | \$3117 |
| 55RSERR54SH (right) / 55RSERR54SHCU (use with corner unit only) | \$3117 |
| Executive height return shell, one wire mgmt grommet in top, 30"H worksurface, 23" worksurface, 12"D transaction counter 24" x 54" x 42"H (180 lbs) Optional Glass Transaction Counter Riser (Specify Clear - add \$1138 list or Frosted - add \$1617 list) Optional without Transaction Counter (NTC) - no upcharge | |
| 55RSERL48SH (left - shown) / 55RSERL48SHCU (use with corner unit only) | \$2799 |
| 55RSERR48SH (right) / 55RSERR48SHCU (use with corner unit only) | \$2799 |
| Executive height return shell, one wire mgmt grommet in top, 30"H worksurface, 23" worksurface, 12"D transaction counter 24" x 48" x 42"H (140 lbs) Optional Glass Transaction Counter Riser (Specify Clear - add \$812 list or Frosted - add \$1247 list) Optional without Transaction Counter (NTC) - no upcharge | |
| 55RSERL42SH (left - shown) / 55RSERL42SHCU (use with corner unit only) | \$2503 |
| 55RSERR42SH (right) / 55RSERR42SHCU (use with corner unit only) | \$2503 |
| Executive height return shell, one wire mgmt grommet in top, 30"H worksurface, 23" worksurface, 12"D transaction counter 24" x 42" x 42"H (120 lbs) Optional Glass Transaction Counter Riser (Specify Clear - add \$767 list or Frosted - add \$1143 list) Optional without Transaction Counter (NTC) - no upcharge | |

U Configuration Reception Stations - Bridge



| | |
|--|---------------|
| 55RSWS54 / 55RSWS54CUL (notched left for corner unit) / 55RSWS54CUR (notched right for corner unit) | \$2702 |
| Executive height bridge shell, one wire mgmt grommet in top, 30"H worksurface, 23" worksurface, 12"D transaction counter 24" x 54" x 42"H (110 lbs) Optional Glass Transaction Counter Riser (Specify Clear - add \$1138 list or Frosted - add \$1617 list) Optional without Transaction Counter (NTC) - no upcharge | |
| 55RSWS48 / 55RSWS48CUL (notched left for corner unit) / 55RSWS48CUR (notched right for corner unit) | \$2408 |
| Executive height bridge shell, one wire mgmt grommet in top, 30"H worksurface, 23" worksurface, 12"D transaction counter 24" x 48" x 42"H (98 lbs) Optional Glass Transaction Counter Riser (Specify Clear - add \$812 list or Frosted - add \$1247 list) Optional without Transaction Counter (NTC) - no upcharge | |
| 55RSWS42 / 55RSWS42CUL (notched left for corner unit) / 55RSWS42CUR (notched right for corner unit) | \$2113 |
| Executive height bridge shell, one wire mgmt grommet in top, 30"H worksurface, 23" worksurface, 12"D transaction counter 24" x 42" x 42"H (85 lbs) Optional Glass Transaction Counter Riser (Specify Clear - add \$767 list or Frosted - add \$1143 list) Optional without Transaction Counter (NTC) - no upcharge | |

U Configuration Reception Stations - Credenza Shells

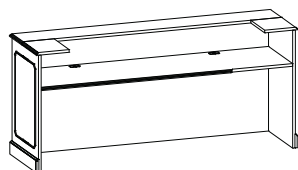

| | |
|---|---------------|
| 55RSC8424SH / 55RSC8424SHL (left) / 55RSC8424SHC (center) / 55RSC8424SHR (right) | \$5094 |
| Single riser reception credenza shell, two wire mgmt grommets in top, 30"H worksurface, 23" worksurface, 12"D transaction counter 24" x 84" x 42"H (224 lbs) Optional Glass Transaction Counter Riser (Specify Clear - add \$3062 list or Frosted - add \$4343 list) Optional without Transaction Counter (NTC) - no upcharge Optional Approach Transaction Counter Only (ATC) - no upcharge | |
| 55RSC7224SH / 55RSC7224SHL (left) / 55RSC7224SHC (center) / 55RSC7224SHR (right) | \$4335 |
| Single riser reception credenza shell, two wire mgmt grommets in top, 30"H worksurface, 23" worksurface, 12"D transaction counter 24" x 72" x 42"H (199 lbs) Optional Glass Transaction Counter Riser (Specify Clear - add \$2977 list or Frosted - add \$4155 list) Optional without Transaction Counter (NTC) - no upcharge Optional Approach Transaction Counter Only (ATC) - no upcharge | |

TRADITIONAL RECEPTION STATIONS

List Price

L Configuration Reception Stations - Modular Pedestals



55MPBBF3016 \$1648
 Modular box/box/file pedestal (locking), open back, to be used under 30"D worksurfaces
 29 3/4"D x 16"W x 29"H (81 lbs)

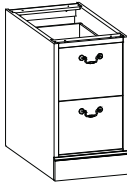

55MPBBF2416 \$1367
 Modular box/box/file pedestal (locking), open back, to be used under 24"D worksurfaces
 22 3/4"D x 16"W x 29"H (70 lbs)

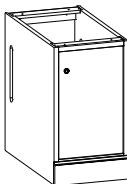

55MPFF3016 \$1447
 Modular file/file pedestal (locking), open back, to be used under 30"D worksurfaces
 29 3/4"D x 16"W x 29"H (81 lbs)

55MPFF2416 \$1303
 Modular file/file pedestal (locking), open back, to be used under 24"D worksurfaces
 22 3/4"D x 16"W x 29"H (70 lbs)



55MPCPHD3016 \$1319
 Modular CPU pedestal, hinged door front - open back, to be used under 30"D worksurfaces,
 ventilations slots on right and left sides (back)
 29 3/4"D x 16"W x 29"H (55 lbs)
 Optional with out hinged door (WHD) - deduct \$275 list

55MPCPHD2416 \$1306
 Modular CPU pedestal, hinged door front - open back, to be used under 24"D worksurfaces,
 ventilations slots on right and left sides (back)
 22 3/4"D x 16"W x 29"H (45 lbs)
 Optional with out hinged door (WHD) - deduct \$275 list



55MPLF22432 \$1744
 Modular lateral file pedestal (locking), open back, to be used under 24"D worksurfaces,
 accommodates legal or letter filing
 22 3/4"D x 16"W x 29"H (115 lbs)

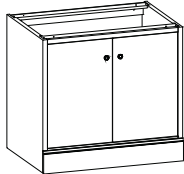

55MPFC2432 \$2144
 Modular file center pedestal (locking), open back, to be used under 24"D worksurfaces,
 two box, one file drawer - top, one lateral file - bottom
 22 3/4"D x 32"W x 29"H (145 lbs)

55MPHD2432 \$1862
 Modular hinged door storage pedestal (non-locking), open back, to be used under 24"D worksurfaces,
 one adjustable shelf
 22 3/4"D x 32"W x 29"H (145 lbs)
 Optional with out hinged door (WHD) - deduct \$275 list

L Configuration Reception Stations - Mobile Pedestals



55MOBFF2216 \$1518
 Mobile pedestal with file/file pedestal (locking)
 22"D x 16"W x 28 3/4"H (95 lbs)



55MOBBBF2216 \$1564
 Mobile pedestal with box/box/file pedestal (locking)
 22"D x 16"W x 28 3/4"H (95 lbs)

Center Drawer

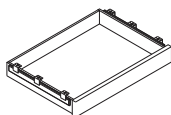

55PD24 \$354
 Pencil Drawer
 24"W x 18"D x 3"H
 *Consider kneespace clearance

3% Price Increase Effective June 1, 2018. Round up to the next full dollar. Excludes Power Modules and Telecom Jacks on p340-341.5

CONTEMPORARY - TRANSITIONAL RECEPTION STATIONS



Reception stations, the first impression expressed to visitors in your office. Transitional styling to coordinate with your other office settings, available in a selection of 16 walnut, cherry, oak, maple and mahogany finishes.

CONTEMPORARY - TRANSITIONAL RECEPTION STATIONS

Finishes Available

Walnut

Natural Walnut



Richleigh Walnut



Royal Walnut



Empire Walnut



Old World Mahogany



Crescent Cherry on Walnut

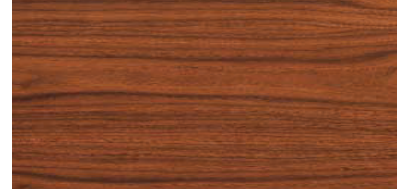

Espresso



Cherry

Natural Cherry



Amber Cherry



Cinnamon Cherry



Collector's Cherry



Mocha Cherry



Mahogany on Cherry



Oak

Landmark Oak

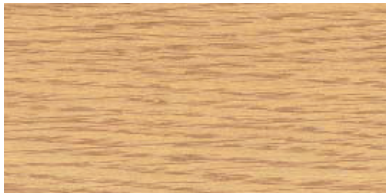

Harbor Oak



Maple

Sunrise Maple



**The finishes shown on this page have been reproduced as accurately as possible, however, due to the printing process some finishes may vary slightly from the actual finish samples originally photographed. In addition, due to the nature of wood, it is possible that some slight variations in color and grain character may occur naturally (which is the beauty of a natural product). Wood finish chips are available for each of the above finishes if requested (please call customer service).

CONTEMPORARY - TRANSITIONAL RECEPTION STATIONS

Warranty and Certification

All products listed are warranted against defects of material and workmanship under normal use and service for a minimum of 10 years from the date of installation (see full warranty information). All products listed are Level 2 BIFMA certified.

Veneer

Veneer on all exposed surfaces is American Black Walnut, Cherry, Oak or Maple. Outside surface veneers are book matched to provide proper grain consistency and uniform grain appearance. Drawer fronts are vertical grain cherry, maple, oak or walnut veneers and matched in selected sets to ensure proper veneer balance and uniform grain appearance.

Wood Veneer Tops

1 3/16" thick tops utilizing 3-ply construction with solid cherry, maple, oak or walnut wood band edging, shaped with six edge details. Top cores are high density particle board. Cherry, maple, oak or walnut veneer tops are standard. High pressure laminate tops are optional, with many standard finishes having matching laminate tops available (call customer service for options).

Drawers

Drawer sides and backs are solid plywood, 7/16" thick. Drawer fronts are 3-ply hardwood construction, 3/4" thick with book matched veneers to provide proper grain consistency and uniform grain appearance. All drawers utilize five sided drawer construction. Drawers are assembled with dovetail construction in all four corners. All desk drawers are grooved for drawer partitions. Drawer bottoms are 7/32" 3-ply hardwood dado construction.

Doors

Doors are 3/4" thick, 3-ply construction with vertical grain cherry, maple, oak or walnut veneers and matched in selected sets to ensure proper veneer balance and uniform grain appearance. European style hidden hinges are used on all doors.

Hardware

Drawer Suspensions – File, box, pencil and center drawers utilize steel "A" grade heavy duty metal slides for smooth operation. All pedestal drawers have 100 % full extension slides. All suspension systems feature positive and cushioned in/out stops. All box, center, and tray drawers are removable without tools and the suspensions are designed to prevent accidental removal.

Locks – All desks and credenzas utilize pedestal locking. Lateral files are keyed as standard and feature central locking with anti-tip drawer interlock systems. Individual pieces are shipped random keyed. Units may be keyed alike upon special request. A minimum of fifty key changes (numbers) are available. Core lock changes are available (contact customer service).

Drawer Pulls – Four drawer pull options are available in either black or nickel finish and one drawer pull option is available in brass (see attached for details).

Hinges – European style hidden hinges on all hinged doors.

Chassis Construction

Construction technique is mortise and tenon, groove and tenon, heavily glue blocked with hardwood cleats for maximum strength.

Filing

File drawers use an easily adjustable filing rail system which can be positioned to accommodate front to back or side to side letter or legal filing.

Finish

All exposed surfaces are finished with a UV inhibitor catalyzed varnish finish to ensure maximum durability, chemical resistance, color retention and clarity. All exterior surfaces are finished in the following multi-step sequence: sap stain, NGR stain, wash coat, wash coat sand, filler spray, filler wipe, sealer spray, sealer sand, varnish spray, varnish sand, varnish spray. Moisture content for all wooden parts is between 5 - 9% prior to sealing. Drawer interiors and exteriors are UV prefinished with sealer, sealer sand, and varnished. Custom finish matches are available, contact customer service for request.

Standard Profile Options

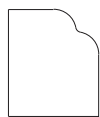

Duet - H

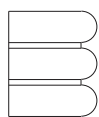

Reeded - D

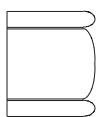

Tri-Oval - C

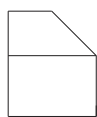

Bevel - V



Square - A

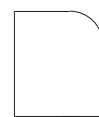

Radius - R

Standard Pull Options



LB - Bar Black



AB - Arc Black



CB - Crescent Black



JB - Wave Black



KB - Classic Brass



LN - Bar Nickel



AN - Arc Nickel



CN - Crescent Nickel



JN - Wave Nickel

CONTEMPORARY - TRANSITIONAL RECEPTION STATIONS

List Price

Freestanding Reception Stations

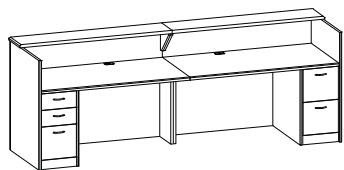

300RSD12032 **\$10,292**
 Double pedestal reception desk, box/box/file pedestal (LH), file/file pedestal (RH), pedestal locking, full modesty panel, two wire mgmt grommets in top, 87" kneespace
 30" worksurface height, 30"D worksurface, 12"D transaction counter
 32" x 120" x 42"H (420 lbs) **ships in two pieces
 Optional Glass Transaction Counter Riser (Specify Clear - add \$2332 list or Frosted - add \$3446 list) Optional without Transaction Counter (NTC) - no upcharge

300RSD10832 **\$9574**
 Double pedestal reception desk, box/box/file pedestal (LH), file/file pedestal (RH), pedestal locking, full modesty panel, two wire mgmt grommets in top, 75" kneespace
 30" worksurface height, 30"D worksurface, 12"D transaction counter
 32" x 108" x 42"H (360 lbs) **ships in two pieces
 Optional Glass Transaction Counter Riser (Specify Clear - add \$2275 list or Frosted - add \$3234 list) Optional without Transaction Counter (NTC) - no upcharge

300RSD9632 **\$8911**
 Double pedestal reception desk, box/box/file pedestal (LH), file/file pedestal (RH), pedestal locking, full modesty panel, two wire mgmt grommets in top, 63" kneespace
 30" worksurface height, 30"D worksurface, 12"D transaction counter
 32" x 96" x 42"H (300 lbs)
 Optional Glass Transaction Counter Riser (Specify Clear - add \$1580 list or Frosted - add \$2418 list) Optional without Transaction Counter (NTC) - no upcharge

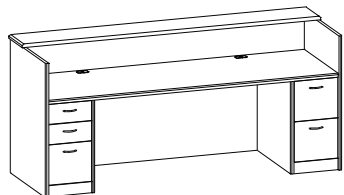

300RSD8432 **\$8144**
 Double pedestal reception desk, box/box/file pedestal (LH), file/file pedestal (RH), pedestal locking, full modesty panel, two wire mgmt grommets in top, 51" kneespace
 30" worksurface height, 30"D worksurface, 12"D transaction counter
 32" x 84" x 42"H (270 lbs)
 Optional Glass Transaction Counter Riser (Specify Clear - add \$1280 list or Frosted - add \$2016 list) Optional without Transaction Counter (NTC) - no upcharge

300RSD7232 **\$7381**
 Double pedestal reception desk, box/box/file pedestal (LH), file/file pedestal (RH), pedestal locking, full modesty panel, two wire mgmt grommets in top, 39" kneespace
 30" worksurface height, 30"D worksurface, 12"D transaction counter
 32" x 72" x 42"H (240 lbs)
 Optional Glass Transaction Counter Riser (Specify Clear - add \$1195 list or Frosted - add \$1828 list) Optional without Transaction Counter (NTC) - no upcharge

Freestanding Dual Riser Reception Stations

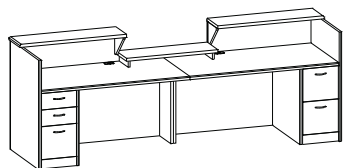

300RSDRR12032 **\$11,018**
 Double pedestal dual riser reception desk, box/box/file pedestal (LH), file/file pedestal (RH), pedestal locking, full modesty panel, two wire mgmt grommets in top, 87" kneespace
 30" worksurface height, 30"D worksurface, 12"D transaction counter
 32" x 120" x 42"H (420 lbs) **ships in two pieces
 Optional Glass Transaction Counter Riser (Specify Clear - add \$2258 list or Frosted - add \$3336 list)
 Optional without Transaction Counter (NTC) - no upcharge

300RSDRR10832 **\$10,299**
 Double pedestal dual riser reception desk, box/box/file pedestal (LH), file/file pedestal (RH), pedestal locking, full modesty panel, two wire mgmt grommets in top, 75" kneespace
 30" worksurface height, 30"D worksurface, 12"D transaction counter
 32" x 108" x 42"H (360 lbs) **ships in two pieces
 Optional Glass Transaction Counter Riser (Specify Clear - add \$2172 list or Frosted - add \$3149 list)
 Optional without Transaction Counter (NTC) - no upcharge

300RSDRR9632 **\$9637**
 Double pedestal dual riser reception desk, box/box/file pedestal (LH), file/file pedestal (RH), pedestal locking, full modesty panel, two wire mgmt grommets in top, 63" kneespace
 30" worksurface height, 30"D worksurface, 12"D transaction counter
 32" x 96" x 42"H (300 lbs)
 Optional Glass Transaction Counter Riser (Specify Clear - add \$2095 list or Frosted - add \$2984 list)
 Optional without Transaction Counter (NTC) - no upcharge

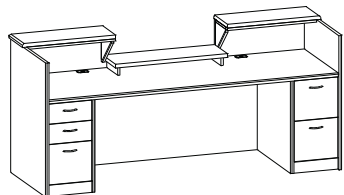

300RSDRR8432 **\$8877**
 Double pedestal dual riser reception desk, box/box/file pedestal (LH), file/file pedestal (RH), pedestal locking, full modesty panel, two wire mgmt grommets in top, 51" kneespace
 30" worksurface height, 30"D worksurface, 12"D transaction counter
 32" x 84" x 42"H (270 lbs)
 Optional Glass Transaction Counter Riser (Specify Clear - add \$2027 list or Frosted - add \$2832 list)
 Optional without Transaction Counter (NTC) - no upcharge

300RSDRR7232 **\$8117**
 Double pedestal dual riser reception desk, box/box/file pedestal (LH), file/file pedestal (RH), pedestal locking, full modesty panel, two wire mgmt grommets in top, 39" kneespace
 30" worksurface height, 30"D worksurface, 12"D transaction counter
 32" x 72" x 42"H (240 lbs)
 Optional Glass Transaction Counter Riser (Specify Clear - add \$1965 list or Frosted - add \$2695 list)
 Optional without Transaction Counter (NTC) - no upcharge

CONTEMPORARY - TRANSITIONAL RECEPTION STATIONS

List Price

Computer Corner Reception Stations



300RSERL54FC / 300RSERL54FCCU (use with corner unit only) **\$4556**
 Transaction return (LH), file center pedestal (locking), two box, one file drawer top,
 one lateral file drawer bottom, one wire mgmt grommet in top
 21 1/2"W kneespace, 30"H worksurface height, 12"D transaction counter
 24" x 54" x 42"H (180 lbs)
 Optional Glass Transaction Counter Riser (Specify Clear - add \$1138 list or Frosted - add \$1617 list)
 Optional without Transaction Counter (NTC) - no upcharge



300RSERL48 / 300RSERL48CU (use with corner unit only) **\$3885**
 Transaction return (LH), box/box/file pedestal (locking), one wire mgmt grommet in top
 31 1/2"W kneespace, 30"H worksurface height, 12"D transaction counter
 24" x 48" x 42"H (150 lbs)
 Optional Glass Transaction Counter Riser (Specify Clear - add \$812 list or Frosted - add \$1247 list)
 Optional without Transaction Counter (NTC) - no upcharge

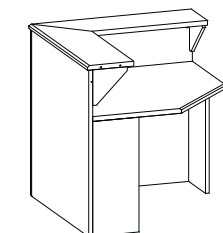

300RSERL42 / 300RSERL42CU (use with corner unit only) **\$3600**
 Transaction return (LH), box/box/file pedestal (locking), one wire mgmt grommet in top
 25 1/2"W kneespace, 30"H worksurface height, 12"D transaction counter
 24" x 42" x 42"H (135 lbs)
 Optional Glass Transaction Counter Riser (Specify Clear - add \$767 list or Frosted - add \$1143 list)
 Optional without Transaction Counter (NTC) - no upcharge

300RSERL36 / 300RSERL36CU (use with corner unit only) **\$3315**
 Transaction return (LH), box/box/file pedestal (locking), one wire mgmt grommet in top
 19 1/2"W kneespace, 30"H worksurface height, 12"D transaction counter
 24" x 36" x 42"H (120 lbs)
 Optional Glass Transaction Counter Riser (Specify Clear - add \$724 list or Frosted - add \$1050 list)
 Optional without Transaction Counter (NTC) - no upcharge

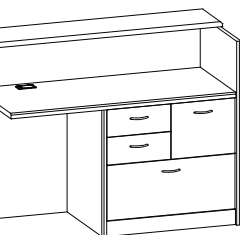

300RSCWS42 **\$3941**
 Corner unit - 42", one wire mgmt grommet in top
 30"H worksurface height, 12"D transaction counter
 42" x 42" x 42"H (200 lbs)
 Optional Glass Transaction Counter Riser (Specify Clear - add \$1950 list or Frosted - add \$2702 list)
 Optional without Transaction Counter (NTC) - no upcharge

300RSCWS36 **\$3506**
 Corner unit - 36", one wire mgmt grommet in top
 30"H worksurface height, 12"D transaction counter
 36" x 36" x 42"H (180 lbs)
 Optional Glass Transaction Counter Riser (Specify Clear - add \$1866 list or Frosted - add \$2515 list)
 Optional without Transaction Counter (NTC) - no upcharge

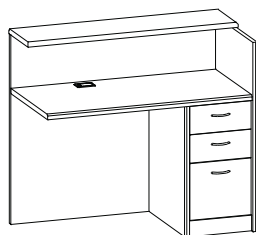

300RSERR54FC / 300RSERR54FCCU (use with corner unit only) **\$4557**
 Transaction return (RH), file center pedestal (locking), two box, one file drawer top,
 one lateral file drawer bottom, one wire mgmt grommet in top
 21 1/2"W kneespace, 30"H worksurface height, 12"D transaction counter
 24" x 54" x 42"H (180 lbs)
 Optional Glass Transaction Counter Riser (Specify Clear - add \$1138 list or Frosted - add \$1617 list)
 Optional without Transaction Counter (NTC) - no upcharge

300RSERR48 / 300RSERR48CU (use with corner unit only) **\$3885**
 Transaction return (RH), box/box/file pedestal (locking), one wire mgmt grommet in top
 31 1/2"W kneespace, 30"H worksurface height, 12"D transaction counter
 24" x 48" x 42"H (150 lbs)
 Optional Glass Transaction Counter Riser (Specify Clear - add \$812 list or Frosted - add \$1247 list)
 Optional without Transaction Counter (NTC) - no upcharge

300RSERR42 / 300RSERR42 CU (use with corner unit only) **\$3600**
 Transaction return (RH), box/box/file pedestal (locking), one wire mgmt grommet in top
 25 1/2"W kneespace, 30"H worksurface height, 12"D transaction counter
 24" x 42" x 42"H (135 lbs)
 Optional Glass Transaction Counter Riser (Specify Clear - add \$767 list or Frosted - add \$1143 list)
 Optional without Transaction Counter (NTC) - no upcharge

300RSERR36 / 300RSERR36CU (use with corner unit only) **\$3315**
 Transaction return (RH), box/box/file pedestal (locking), one wire mgmt grommet in top
 19 1/2"W kneespace, 30"H worksurface height, 12"D transaction counter
 24" x 36" x 42"H (120 lbs)
 Optional Glass Transaction Counter Riser (Specify Clear - add \$724 list or Frosted - add \$1050 list)
 Optional without Transaction Counter (NTC) - no upcharge

CONTEMPORARY - TRANSITIONAL RECEPTION STATIONS

List Price

Hook up Configuration Reception Stations - Desk Shells

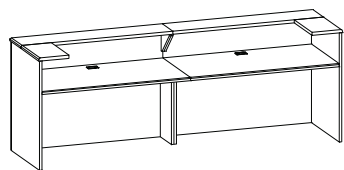

300RSD12031SH / 300RSD12031SHL (left) / 300RSD12031SHC (center) / 300RSD12031SHR (right) \$7462
 Single riser reception desk shell, two wire mgmt grommets in top,
 30"H worksurface, 30" worksurface, 12"D transaction counter
 31" x 120" x 42"H (334 lbs) **ships in two pieces
 Optional Glass Transaction Counter Riser (Specify Clear - add \$4198 list or Frosted - add \$5960 list)
 Optional without Transaction Counter (NTC) - no upcharge
 Optional Approach Transaction Counter Only (ATC) - no upcharge

300RSD10831SH / 300RSD10831SHL (left) / 300RSD10831SHC (center) / 300RSD10831SHR (right) \$6745
 Single riser reception desk shell, two wire mgmt grommets in top,
 30"H worksurface, 30" worksurface, 12"D transaction counter
 31" x 108" x 42"H (307 lbs) **ships in two pieces
 Optional Glass Transaction Counter Riser (Specify Clear - add \$4141 list or Frosted - add \$5749 list)
 Optional without Transaction Counter (NTC) - no upcharge
 Optional Approach Transaction Counter Only (ATC) - no upcharge

300RSD9631SH / 300RSD9631SHL (left) / 300RSD9631SHC (center) / 300RSD9631SHR (right) \$6076
 Single riser reception desk shell, two wire mgmt grommets in top,
 30"H worksurface, 30" worksurface, 12"D transaction counter
 31" x 96" x 42"H (280 lbs)
 Optional Glass Transaction Counter Riser (Specify Clear - add \$3446 list or Frosted - add \$4933 list)
 Optional without Transaction Counter (NTC) - no upcharge
 Optional Approach Transaction Counter Only (ATC) - no upcharge

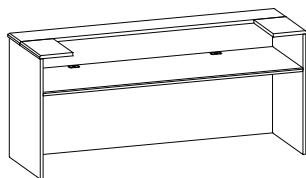

300RSD8431SH / 300RSD8431SHL (left) / 300RSD8431SHC (center) / 300RSD8431SHR (right) \$5314
 Single riser reception desk shell, two wire mgmt grommets in top,
 30"H worksurface, 30" worksurface, 12"D transaction counter
 31" x 84" x 42"H (254 lbs)
 Optional Glass Transaction Counter Riser (Specify Clear - add \$3145 list or Frosted - add \$4530 list)
 Optional without Transaction Counter (NTC) - no upcharge
 Optional Approach Transaction Counter Only (ATC) - no upcharge

300RSD7231SH / 300RSD7231SHL (left) / 300RSD7231SHC (center) / 300RSD7231SHR (right) \$4552
 Single riser reception desk shell, two wire mgmt grommets in top,
 30"H worksurface, 30" worksurface, 12"D transaction counter
 31" x 72" x 42"H (228 lbs)
 Optional Glass Transaction Counter Riser (Specify Clear - add \$3061 list or Frosted - add \$4342 list)
 Optional without Transaction Counter (NTC) - no upcharge
 Optional Approach Transaction Counter Only (ATC) - no upcharge

Hook up Configuration Dual Riser Reception Stations - Desk Shells

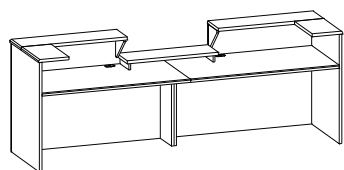

300RSDRR12031SH / 300RSDRR12031SHL (left) / 300RSDRR12031SHC (center) / 300RSDRR12031SHR (right) \$8188
 Dual riser reception desk shell, two wire mgmt grommets in top,
 30"H worksurface, 30" worksurface, 12"D transaction counter
 31" x 120" x 42"H (334 lbs) **ships in two pieces
 Optional Glass Transaction Counter Riser (Specify Clear - add \$4123 list or Frosted - add \$5850 list)
 Optional without Transaction Counter (NTC) - no upcharge
 Optional Approach Transaction Counter Only (ATC) - no upcharge

300RSDRR10831SH / 300RSDRR10831SHL (left) / 300RSDRR10831SHC (center) / 300RSDRR10831SHR (right) \$7470
 Dual riser reception desk shell, two wire mgmt grommets in top,
 30"H worksurface, 30" worksurface, 12"D transaction counter
 31" x 108" x 42"H (317 lbs) **ships in two pieces
 Optional Glass Transaction Counter Riser (Specify Clear - add \$4037 list or Frosted - add \$5663 list)
 Optional without Transaction Counter (NTC) - no upcharge
 Optional Approach Transaction Counter Only (ATC) - no upcharge

300RSDRR9631SH / 300RSDRR9631SHL (left) / 300RSDRR9631SHC (center) / 300RSDRR9631SHR (right) \$6807
 Dual riser reception desk shell, two wire mgmt grommets in top,
 30"H worksurface, 30" worksurface, 12"D transaction counter
 31" x 96" x 42"H (300 lbs)
 Optional Glass Transaction Counter Riser (Specify Clear - add \$3960 list or Frosted - add \$5498 list)
 Optional without Transaction Counter (NTC) - no upcharge
 Optional Approach Transaction Counter Only (ATC) - no upcharge

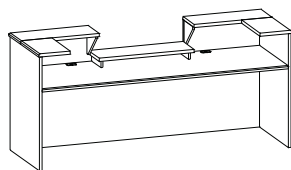

300RSDRR8431SH / 300RSDRR8431SHL (left) / 300RSDRR8431SHC (center) / 300RSDRR8431SHR (right) \$6047
 Dual riser reception desk shell, two wire mgmt grommets in top,
 30"H worksurface, 30" worksurface, 12"D transaction counter
 31" x 84" x 42"H (254 lbs)
 Optional Glass Transaction Counter Riser (Specify Clear - add \$3892 list or Frosted - add \$5346 list)
 Optional without Transaction Counter (NTC) - no upcharge
 Optional Approach Transaction Counter Only (ATC) - no upcharge

300RSDRR7231SH / 300RSDRR7231SHL (left) / 300RSDRR7231SHC (center) / 300RSDRR7231SHR (right) \$5287
 Dual riser reception desk shell, two wire mgmt grommets in top,
 30"H worksurface, 30" worksurface, 12"D transaction counter
 31" x 72" x 42"H (228 lbs)
 Optional Glass Transaction Counter Riser (Specify Clear - add \$3831 list or Frosted - add \$5210 list)
 Optional without Transaction Counter (NTC) - no upcharge
 Optional Approach Transaction Counter Only (ATC) - no upcharge

CONTEMPORARY - TRANSITIONAL RECEPTION STATIONS

List Price

L Configuration Reception Stations - Executive Return Shells

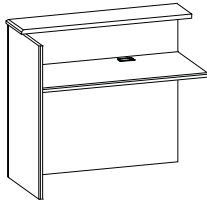

| | |
|--|---------------|
| 300RSERL72SH (left - shown) / 300RSERL72SHCU (use with corner unit only) | \$3922 |
| 300RSERR72SH (right) / 300RSERR72SHCU (use with corner unit only) | \$3922 |
| Executive height return shell, one wire mgmt grommet in top, 30"H worksurface, 23" worksurface, 12"D transaction counter 24" x 72" x 42"H (173 lbs) Optional Glass Transaction Counter Riser (Specify Clear - add \$1195 list or Frosted - add \$1828 list) Optional without Transaction Counter (NTC) - no upcharge | |
| 300RSERL60SH (left - shown) / 300RSERL60SHCU (use with corner unit only) | \$3310 |
| 300RSERR60SH (right) / 300RSERR60SHCU (use with corner unit only) | \$3310 |
| Executive height return shell, one wire mgmt grommet in top, 30"H worksurface, 23" worksurface, 12"D transaction counter 24" x 60" x 42"H (149 lbs) Optional Glass Transaction Counter Riser (Specify Clear - add \$1166 list or Frosted - add \$1723 list) Optional without Transaction Counter (NTC) - no upcharge | |
| 300RSERL54SH (left - shown) / 300RSERL54SHCU (use with corner unit only) | \$3004 |
| 300RSERR54SH (right) / 300RSERR54SHCU (use with corner unit only) | \$3004 |
| Executive height return shell, one wire mgmt grommet in top, 30"H worksurface, 23" worksurface, 12"D transaction counter 24" x 54" x 42"H (136 lbs) Optional Glass Transaction Counter Riser (Specify Clear - add \$1138 list or Frosted - add \$1617 list) Optional without Transaction Counter (NTC) - no upcharge | |
| 300RSERL48SH (left - shown) / 300RSERL48SHCU (use with corner unit only) | \$2697 |
| 300RSERR48SH (right) / 300RSERR48SHCU (use with corner unit only) | \$2697 |
| Executive height return shell, one wire mgmt grommet in top, 30"H worksurface, 23" worksurface, 12"D transaction counter 24" x 48" x 42"H (124 lbs) Optional Glass Transaction Counter Riser (Specify Clear - add \$812 list or Frosted - add \$1247 list) Optional without Transaction Counter (NTC) - no upcharge | |
| 300RSERL42SH (left - shown) / 300RSERL42SHCU (use with corner unit only) | \$2412 |
| 300RSERR42SH (right) / 300RSERR42SHCU (use with corner unit only) | \$2412 |
| Executive height return shell, one wire mgmt grommet in top, 30"H worksurface, 23" worksurface, 12"D transaction counter 24" x 42" x 42"H (112 lbs) Optional Glass Transaction Counter Riser (Specify Clear - add \$767 list or Frosted - add \$1143 list) Optional without Transaction Counter (NTC) - no upcharge | |

U Configuration Reception Stations - Bridge

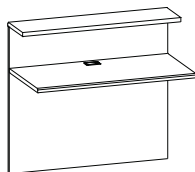

| | |
|--|---------------|
| 300RSWS54 / 300RSWS54CUL (notched left for corner unit) / 300RSWS54CUR (notched right for corner unit) | \$2605 |
| Executive height bridge shell, one wire mgmt grommet in top, 30"H worksurface, 23" worksurface, 12"D transaction counter 24" x 54" x 42"H (110 lbs) Optional Glass Transaction Counter Riser (Specify Clear - add \$1138 list or Frosted - add \$1617 list) Optional without Transaction Counter (NTC) - no upcharge | |
| 300RSWS48 / 300RSWS48CUL (notched left for corner unit) / 300RSWS48CUR (notched right for corner unit) | \$2322 |
| Executive height bridge shell, one wire mgmt grommet in top, 30"H worksurface, 23" worksurface, 12"D transaction counter 24" x 48" x 42"H (98 lbs) Optional Glass Transaction Counter Riser (Specify Clear - add \$812 list or Frosted - add \$1247 list) Optional without Transaction Counter (NTC) - no upcharge | |
| 300RSWS42 / 300RSWS42CUL (notched left for corner unit) / 300RSWS42CUR (notched right for corner unit) | \$2037 |
| Executive height bridge shell, one wire mgmt grommet in top, 30"H worksurface, 23" worksurface, 12"D transaction counter 24" x 42" x 42"H (85 lbs) Optional Glass Transaction Counter Riser (Specify Clear - add \$767 list or Frosted - add \$1143 list) Optional without Transaction Counter (NTC) - no upcharge | |

U Configuration Reception Stations - Credenza Shells

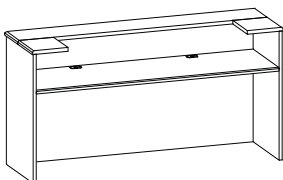

| | |
|---|---------------|
| 300RSC8424SH / 300RSC8424SHL (left) / 300RSC8424SHC (center) / 300RSC8424SHR (right) | \$4909 |
| Single riser reception credenza shell, two wire mgmt grommets in top, 30"H worksurface, 23" worksurface, 12"D transaction counter 24" x 84" x 42"H (224 lbs) Optional Glass Transaction Counter Riser (Specify Clear - add \$3062 list or Frosted - add \$4343 list) Optional without Transaction Counter (NTC) - no upcharge Optional Approach Transaction Counter Only (ATC) - no upcharge | |
| 300RSC7224SH / 300RSC7224SHL (left) / 300RSC7224SHC (center) / 300RSC7224SHR (right) | \$4178 |
| Single riser reception credenza shell, two wire mgmt grommets in top, 30"H worksurface, 23" worksurface, 12"D transaction counter 24" x 72" x 42"H (199 lbs) Optional Glass Transaction Counter Riser (Specify Clear - add \$2977 list or Frosted - add \$4155 list) Optional without Transaction Counter (NTC) - no upcharge Optional Approach Transaction Counter Only (ATC) - no upcharge | |

CONTEMPORARY - TRANSITIONAL RECEPTION STATIONS

List Price

L Configuration Reception Stations - Modular Pedestals



300MPBBF3016 **\$1588**
 Modular box/box/file pedestal (locking), open back, to be used under 30"D worksurfaces
 29 3/4"D x 16"W x 29"H (81 lbs)



300MPBBF2416 **\$1317**
 Modular box/box/file pedestal (locking), open back, to be used under 24"D worksurfaces
 22 3/4"D x 16"W x 29"H (70 lbs)

300MPFF3016 **\$1394**
 Modular file/file pedestal (locking), open back, to be used under 30"D worksurfaces
 29 3/4"D x 16"W x 29"H (81 lbs)

300MPFF2416 **\$1255**
 Modular file/file pedestal (locking), open back, to be used under 24"D worksurfaces
 22 3/4"D x 16"W x 29"H (70 lbs)



300MPCPHD3016L / 300MPCPHD3016R **\$1271**
 Modular CPU pedestal, hinged door front - open back, to be used under 30"D worksurfaces,
 ventilations slots on right and left sides (back)
 29 3/4"D x 16"W x 29"H (55 lbs)
 Optional with out hinged door (WHD) - deduct \$275 list

300MPCPHD2416L / 300MPCPHD2416R **\$1228**
 Modular CPU pedestal, hinged door front - open back, to be used under 24"D worksurfaces,
 ventilations slots on right and left sides (back)
 22 3/4"D x 16"W x 29"H (45 lbs)
 Optional with out hinged door (WHD) - deduct \$275 list

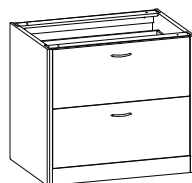

300MPLF22432 **\$1680**
 Modular lateral file pedestal (locking), open back, to be used under 24"D worksurfaces,
 accommodates legal or letter filing
 22 3/4"D x 16"W x 29"H (115 lbs)

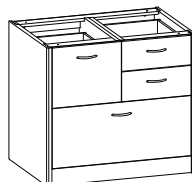

300MPFC2432 **\$2066**
 Modular file center pedestal (locking), open back, to be used under 24"D worksurfaces,
 two box, one file drawer - top, one lateral file - bottom
 22 3/4"D x 32"W x 29"H (145 lbs)

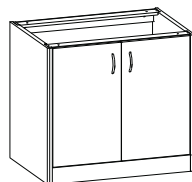

300MPHD2432 **\$1794**
 Modular hinged door storage pedestal (non-locking), open back, to be used under 24"D worksurfaces,
 one adjustable shelf
 22 3/4"D x 32"W x 29"H (145 lbs)
 Optional with out hinged door (WHD) - deduct \$275 list

L Configuration Reception Stations - Mobile Pedestals

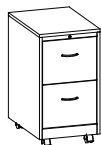

300MOBFF2216 **\$1463**
 Mobile pedestal with file/file pedestal (locking)
 22"D x 16"W x 28 3/4"H (95 lbs)



300MOBBBF2216 **\$1506**
 Mobile pedestal with box/box/file pedestal (locking)
 22"D x 16"W x 28 3/4"H (95 lbs)

Center Drawer

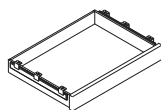

300PD24 **\$354**
 Pencil Drawer
 24"W x 18"D x 3"H
 *Consider kneespace clearance