

Products

2017
LP31 UK

1st edition

 COSENTINO®

SILESTONE® DEKTON® SENSEA



Content

Silestone® Polished	8
Silestone® Suede & Volcano	9
INTEGRITY	13
SENSA by Cosentino®	14
DEKTON® Collection	17
Aura15 Book Match	23
COMPLEMENTARY PRODUCTS by Cosentino®	26
GENERAL TERMS AND CONDITIONS	30

SILESTONE® COLLECTION

ICONIC WHITE



BLANCO ZEUS EXT.



CLASSIC WHITE

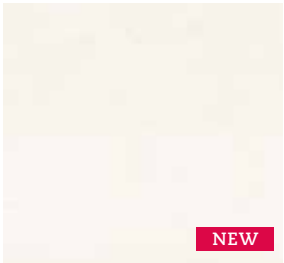

SNOWY IBIZA



ARIEL



ETERNAL CALACATTA GOLD

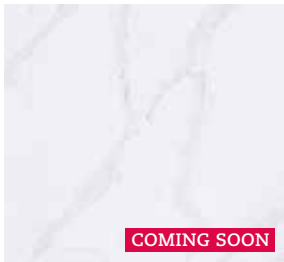

ETERNAL STATUARIO

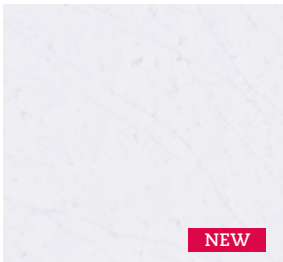

BLANCO ORION



WHITE STORM 14



YUKON



WHITE DIAMOND



BLANCO MAPLE 14



BLANCO NORTE 14



BLANCO STELLAR 13



LUNA 14



BIANCO RIVERS



LUSSO



LAGOON



LYRA



DARIA



HAIKU



VORTIUM



BLANCO CITY



ROYAL REEF



NYMBUS



BLANCO CAPRI



TIGRIS SAND



CREMA MINERVA 16



WHITE PLATINUM



CHROME

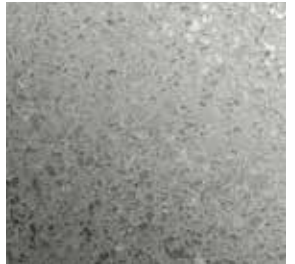

NIEBLA



ETERNAL SERENA



NEW

KENSHO



ALUMINIO NUBE

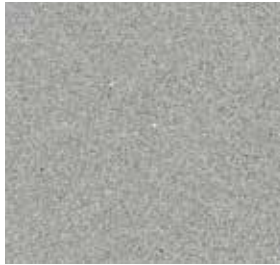

ALPINA WHITE 08

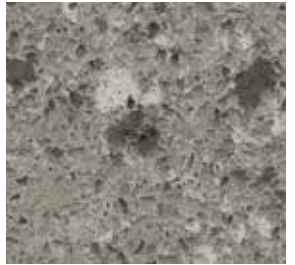

CREMA STELLAR



BAMBOO 08



ROUGUI



CORAL CLAY



NOKA



SILESTONE® COLLECTION

UNSUI



AMAZON



IRONBARK



CALYPSO



CYGNUS 15



GREY STELLAR

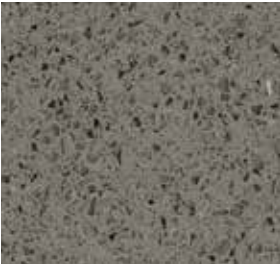

GRIS EXPO



CEMENTO SPA

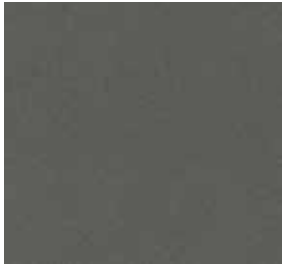

MARENGO



CARBONO



ZIRCONIUM

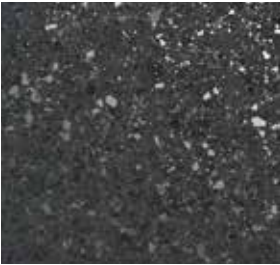

ARDEN BLUE

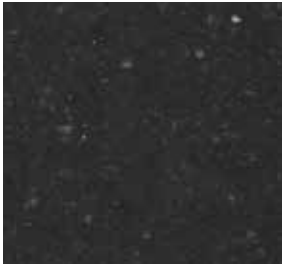

MEROPE



NEGRO STELLAR



NEGRO TEBAS



CHARCOAL SOAPSTONE



ETERNAL MARQUINA



ICONIC BLACK





Presents

The **New Generation**
of **Quartz Surfaces** with

N-BOOST

by SILESTONE

N-Boost is an innovation patented by Cosentino that modifies the surface of the material at a molecular level and offers an even greater improvement to the technical and aesthetic properties of Silestone

Silestone® N-Boost allows for an easier cleaning and maintenance of Silestone®. It also achieves a greater intensity on the colours and an extraordinary shine. Along with the mechanical properties that define the brand, Silestone® N-Boost offers greater resistance to impact and scratch, plus large format installation and versatility of applications

Superior Resistance
to Stains



Easier cleaning. Its water-repellent properties make the cleaning and maintenance of Silestone® easier.

Enhanced
Colours

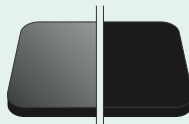

It achieves an even greater intensity of Silestone® colours.

Increased
Luster













It achieves an even greater shine in Silestone® quartz surfaces.

*Check price-list to find colours that feature this quality (only in polished finish).

A product designed by **COSENTINO**

SILESTONE® and ECO Texture Polished

GROUP 1	GROUP 2	GROUP 3	GROUP 3.5	GROUP 4	GROUP 5	GROUP 6
BLANCO CITY  	ARDEN BLUE 	ALUMINIO NUBE 	ALPINA WHITE 08 	AMAZON 	ARIEL 	CARBONO 
GRIS EXPO  	BLANCO NORTE 14  	BLANCO CAPRI  	BLANCO STELLAR 13  	BAMBOO 08 	BLANCO ORION 	CHROME 
MARENGO 	CEMENTO SPA  	BLANCO MAPLE 14  	CREMA STELLAR 	BIANCO RIVERS 	CALYPSO 	ETERNAL CALACATTA GOLD  
NOKA 	CORAL CLAY 	CYGNUS 15 	CLASSIC WHITE 	BLANCO ZEUS EXTREME  	CHARCOAL SOAPSTONE  	ETERNAL STATUARIO  
ROUGUI 	CREMA MINERVA 16  	WHITE STORM 14  	GREY STELLAR 	HAIKU 	DARIA 	WHITE DIAMOND  
	IRONBARK 		NEGRO STELLAR  	ICONIC BLACK  	ICONIC WHITE   	WHITE PLATINUM 
	NEGRO TEBAS   			KENSHO 	ETERNAL MARQUINA  	ZIRCONIUM 
	NIEBLA 			LUSSO 	ETERNAL SERENA  	
	NYMBUS 			SNOWY IBIZA 	LAGOON  	
	ROYAL REEF 			TIGRIS SAND 	LUNA 14  	
				UNSUI  	LYRA  	
				YUKON 	MEROPE 	
					VORTIUM 	

GROUP 3.5	GROUP 5	GROUP 6
MOUNTAIN MIST 12 	PULSAR 	IRON ORE 
		RIVERBED 

 COLOURS WITH N-BOOST PROPERTY ONLY IN POLISHED FINISH
ETERNAL COLOURS AND ICONIC BLACK COMING SOON

FOR 1.2cm AVAILABILITY PLEASE CONTACT YOUR COSENTINO CENTRE
MINIMUM DELIVERY TIME 3 WEEKS

ADDITIONAL COLOURS/C GRADE
MATERIALS TAKE MINIMUM 3 WEEKS



SLAB WEIGHTS

THICKNESS	WEIGHTS (Kg/m ²)
1.2 cm	30
2.0 cm	50
3.0 cm	75

REFERENCES

-  Available in Normal Size (up to 304cm x 138cm)
-  Available in Jumbo size (up to 325cm x 159cm)

SILESTONE® and ECO Texture Suede & Volcano

GROUP 1	GROUP 2	GROUP 3	GROUP 4	GROUP 5
ARDEN BLUE 	ALPINA WHITE 08 	AMAZON 	ARIEL 	CARBONO 
BLANCO CITY 	ALUMINIO NUBE 	BIANCO RIVERS 	BLANCO ORION 	CHROME 
BLANCO NORTE 14 	BLANCO CAPRI 	BLANCO ZEUS EXTREME 	CALYPSO 	ETERNAL CALACATTA GOLD 
CEMENTO SPA 	BLANCO MAPLE 14 	CLASSIC WHITE 	CHARCOAL SOAPSTONE 	ETERNAL STATUARIO 
CORAL CLAY 	BLANCO STELLAR 13 	HAIKU 	DARIA 	ZIRCONIUM 
CREMA MINERVA 16 	CYGNUS 15 	KENSHO 	ETERNAL MARQUINA 	
GRIS EXPO 	WHITE STORM 14 	SNOWY IBIZA 	ETERNAL SERENA 	
IRONBARK 		TIGRIS SAND 	ICONIC WHITE 	
MARENGO 		UNSUI 	LAGOON 	
NEGRO TEBAS 		YUKON 	LYRA 	
			MEROPE 	
			VORTIUM 	

ETERNAL COLOURS COMING SOON



DIMENSIONS (cm)
 SUEDE available in same sizes as Polished
 VOLCANO only available in Normal size
 VOLCANO can be requested in Jumbo size with minimum order of 40 slabs

Please ask for availability of other colours:
 SUEDE: minimum order 20 slabs
 VOLCANO: minimum order 40 slabs

SLAB WEIGHTS

THICKNESS	WEIGHTS (Kg/m ²)
1.2 cm	30
2.0 cm	50
3.0 cm	75

REFERENCES

-  Also available in VOLCANO texture
-  Available in Normal Size (up to 304cm x 138cm)
-  Available in Jumbo size (up to 325cm x 159cm)

FOR 1.2cm AVAILABILITY PLEASE CONTACT YOUR COSENTINO CENTRE

SUEDE & VOLCANO ARE NOT STOCKED PRODUCTS. PLEASE ALLOW MINIMUM 3 WEEKS



©

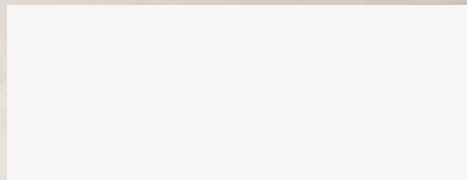

ETERNAL STATUARIO



ICONIC WHITE





integrity
by COSENTINO

SILESTONE® INTEGRITY

AVAILABLE COLOURS

COLOURS	INTEGRITY ONE	INTEGRITY DUE S	INTEGRITY DUE L	INTEGRITY DUE XL
DIMENSIONS (CM)	51 x 41	34 x 37	51 x 37	67 X 43.5
ALUMINIO NUBE	✓	✓	✓	-
ARDEN BLUE	-	✓	✓	-
BLANCO CAPRI	✓	✓	✓	-
BLANCO NORTE 14	✓	✓	✓	-
CEMENTO SPA	✓	✓	✓	-
CORAL CLAY	-	✓	✓	-
GRIS EXPO	✓	✓	✓	-
IRONBARK	-	✓	✓	-
MARENGO	-	✓	✓	-
NEGRO TEBAS	✓	✓	✓	-
NIEBLA	-	✓	✓	-
NOKA	-	✓	✓	-
WHITE STORM	-	✓	✓	-
AMAZON	✓	✓	✓	✓
BIANCO RIVER	✓	✓	✓	-
BLANCO MAPLE14	-	✓	✓	-
BLANCO STELLAR13	-	✓	✓	-
HAIKU	✓	✓	✓	-
KENSHO	✓	✓	✓	-
STELLAR NEGRO	✓	✓	✓	-
TIGRIS SAND	✓	✓	✓	✓
UNSUI	✓	✓	✓	✓
YUKON	✓	✓	✓	-
ARIEL	-	✓	✓	-
BLANCO ORION	-	✓	✓	-
BLANCO ZEUS	✓	✓	✓	✓
CALYPSO	-	✓	✓	-
DARIA	-	✓	✓	-
ICONIC WHITE	-	✓	✓	-
LAGOON	-	✓	✓	✓
LYRA	-	✓	✓	✓
MEROPE	-	✓	✓	-
VORTIUM	-	✓	✓	-
WHITE PLATINUM	-	✓	✓	-
ZIRCONIUM	-	✓	✓	-



CHECK AVAILABILITY OF OTHER COLOURS*

INTEGRITY SINKS ARE MADE TO ORDER. PLEASE ALLOW 3-4 WEEKS FROM DATE OF ORDER FOR DELIVERY.

THIS COSENTINO PRODUCT IS DISTRIBUTED BY OUR PREMIUM DISTRIBUTOR THE 1810 COMPANY. PLEASE MAKE CONTACT WITH: THE 1810 COMPANY SALES@THE1810COMPANY.CO.UK / 01978 660770

EXTRAS

ID SAP	MATERIAL
900796	BELT FIXING KIT SINK REF. 31970026
318947	SINK VALVE WITH LID (SATIN) SIL 003
323087	KIT OVERFLOW
325529	CLAMPING PROFILE SYSTEM (TO INSTALL THE SINK)

IN THE BOX

- ▶ Impact resistant packaging
- ▶ Drain valve
- ▶ Overflow with Silestone logo
- ▶ Installation and use & care manuals
- ▶ Silicon to closely match sink colour
- ▶ Cardboard template for countertop cut-out
- ▶ Kit belt fixing sink
- ▶ Installation Manual

SENSA

by COSENTINO®



WITH SENSA



WITHOUT SENSA

Sensa by Cosentino® consists of maintenance-free, high-quality, natural granite offered by Cosentino, a global leader in the natural stone industry for more than 80 years. Sensa™ granite has a revolutionary protective treatment that provides high stain resistance along with a 15-year warranty.

SENSA by Cosentino® PREMIUM COLLECTION

BIANCO ANTICO



BLACK BEAUTY



COLONIAL WHITE



GLACIAL BLUE



ICE BLUE



INDIAN BLACK

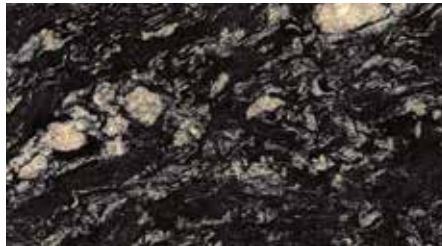

MOAK BLACK



ORINOCO

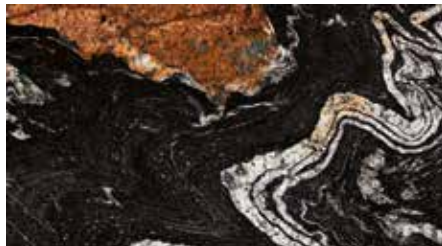

SENSA
15 YEARS
WARRANTY



INDIAN BLACK - MIRAGE



DEKTON® COLLECTION

ZENITH

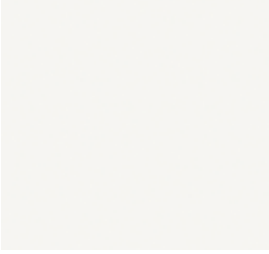

KAIROS



ENTZO



AURA 15



BLANC CONCRETE



MAKAI



GADA



IROK



DANAE



EDORA



VALTERRA



ALDEM



KEON



VENTUS



GALEMA



KORUS



STRATO



SIROCCO



VEGHA



TRILIUM



KADUM



KERANIUM



KELYA



ANANKE



BOREA



DEKTON® COLLECTION

SIRIUS

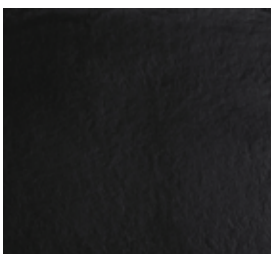

DOMOOS

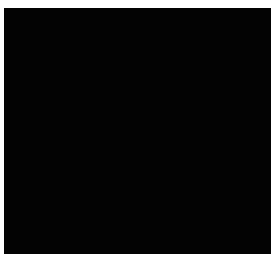

NAYLA

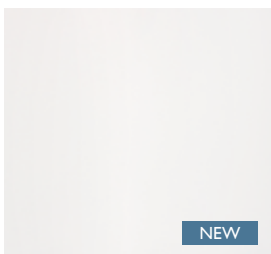

FOSSIL



DEKTON® XGLOSS

HALO

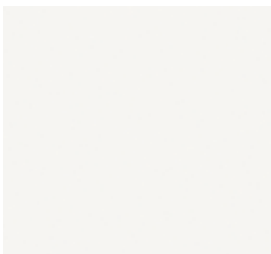

TUNDRA



GLACIER



FIORD



SPLENDOR

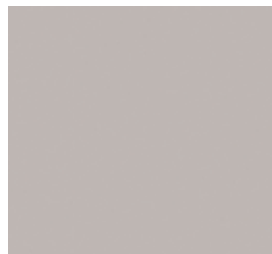

QATAR

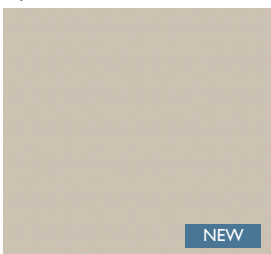

LUMINA



BLAZE



MANHATTAN

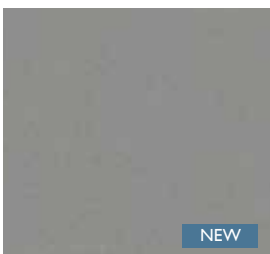

SPECTRA

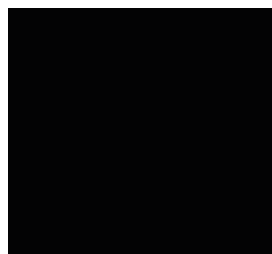



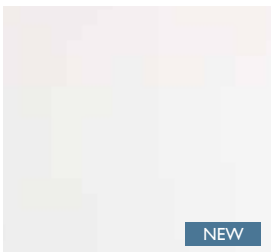







































VIENNA

















DUE TO ITS INTENSE SHINE DEKTON XGLOSS REQUIRES SPECIAL MAINTENANCE AND CARE, PARTICULARLY WITH THE DARKER SHADES, SUCH AS SPECTRA, WHERE ITS INTENSE BLACK COLOUR CAN REVEAL SMALL DETAILS.

DEKTON® COLLECTION

	GROUP 1	GROUP 2	GROUP 3	GROUP 4
SOLID COLLECTION	ANANKÉ 	DOMOOS 	ZENITH 	
		GALEMA  		
	SIRIUS 	KORUS  		
		VENTUS  		
NATURAL COLLECTION	DANAE  	GADA 	AURA 15 	AURA 15 BOOKMATCH
	SIROCCO  	IROK  	KAIRO5 	
	VEGHA 	KELYA 	ENTZO 	
	EDORA 			
	FOSSIL  			
	NAYLA  			
TECH COLLECTION	KADUM 	BLANC CONCRETE  		
		KEON  		
		KERANIUM 		
		STRATO  		
		TRILIUM  		
WILD COLLECTION		ALDEM 		
		BOREA 		
		MAKAI  		
		VALTERRA  		

DEKTON® XGLOSS

	GROUP 2	GROUP 4
SOLID COLLECTION		BLAZE 
		HALO 
		LUMINA 
		SPECTRA 
		SPLENDOR 
NATURAL COLLECTION		FIORD 
		GLACIER 
		TUNDRA 
BASIQ COLLECTION	QATAR  	
	MANHATTAN  	
	VIENNA  	

Max. normal size: 320 x 144cm.

White background colours (Zenith, Entzo, Halo, Kairos, Aura 15, Fiord, Tundra and Glacier), will have a maximum dimension of 317 x 142cm

 Polished  Smooth matte finish  Textured finish



DEKTON GRIP Dekton Grip, the anti-slip solution for wet areas

Antislip treatment is only recommended for barefoot areas, such as pools or Spas. This treatment can produce a slight variation in the colour tone.

3CM MATERIAL COMING SOON, ONLY AVAILABLE IN THESE COLOURS:
ZENITH, SIRIUS, DOMOOS, DANAE AND HALO.

SLAB WEIGHTS

THICKNESS	WEIGHTS (kg/m²)
0.8 cm	21
1.2 cm	32
2.0 cm	53
3.0 cm	75



8mm

12mm

20mm

30mm

COMING SOON

Available soon in 3cm
Dekton becomes the ultracompact surface available also in 3cm thickness*

The new thickness is ideal to complement the material range for worktops and high-traffic floorings.

*Available in limited colours initially.



cm

A product designed by **COSENTINO**

FACADES AND EXTERIOR CLADDING

FORMAT	USE		THICKNESS (MM)	DEPTH (MM)	PIECE THICKNESS (MM)	UN	
CONTINUOUS GROOVE	VENTILATED FAÇADE	CR1	a	4	10	20	M
			b	4	10	12	
			c	4	15	20	
			d	4	15	12	
PUNCTUAL GROOVE	BONDED FAÇADE	CR2	a	1.5	Z	12	UN
			b	1.5	Z	8	
BACK GROOVE	VENTILATED FAÇADE	CR3			12	M	
BACK PUNCTUAL GROOVE	BONDED FAÇADE	CR4	1,5	6	8 and 12	UN	
UNDERCUT DRILL	VENTILATED FAÇADE	TK	1	6.4	8, 12 and 20	UN	
DRILLED HOLES	BONDED FAÇADE	T1			12 and 20	UN	
MESH		A26				M2	

- ▶ The size will be evaluated for each project
- ▶ The thickness depends on the systems selected and on the project
- ▶ Cosentino does not have responsibility of the structural solution
- ▶ Material by order. Minimum orders apply

- ▶ The pieces for ventilated façade will incorporate a mesh on the back side
- ▶ Take care about the direction of the pattern in some references: Ananké, Aura, Danae, Kairos, Makai, Kelya, Borea, Entzo, Valterra, Aldem, Glacier, Fiord, Tundra and Trilium.

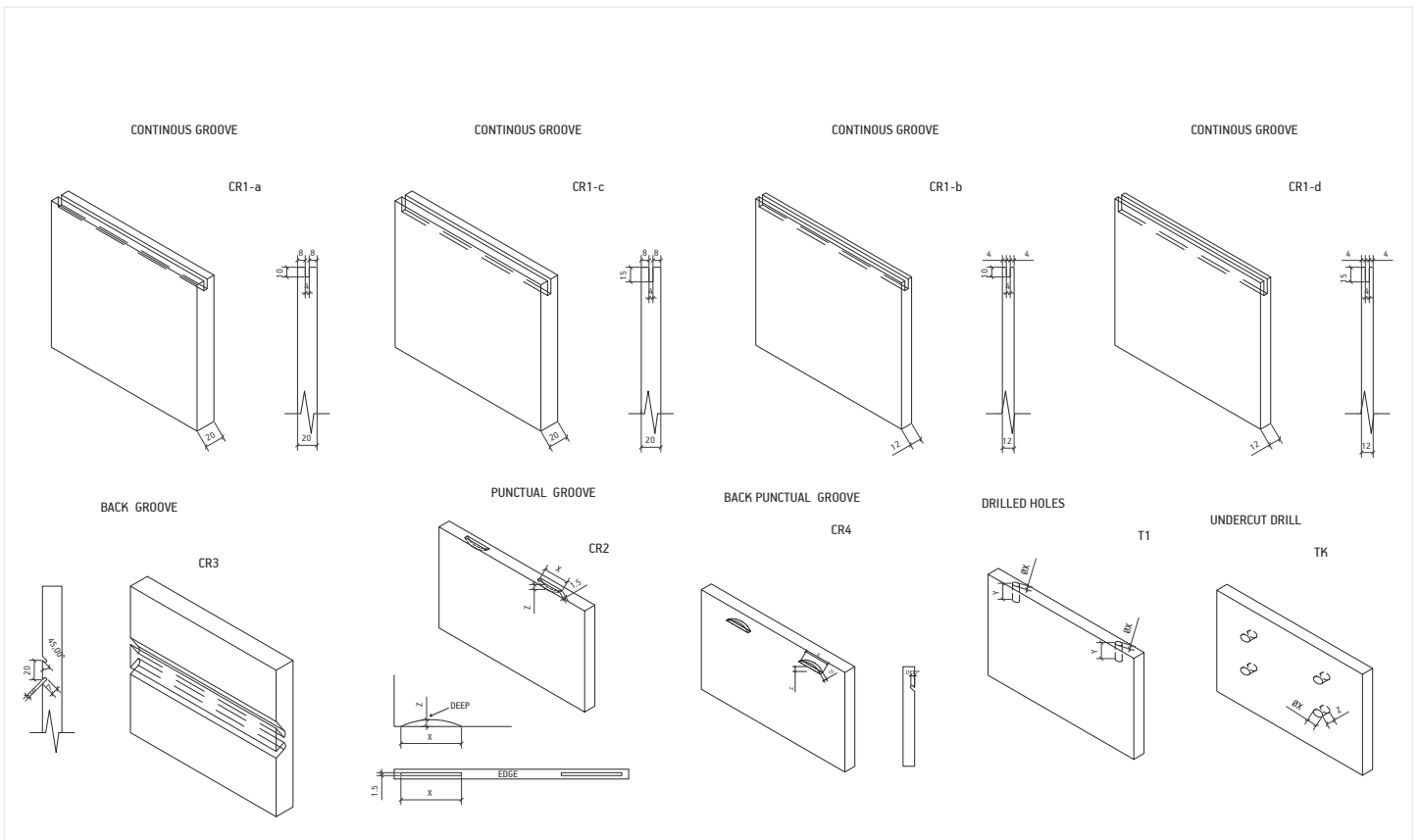



PORSCHE DESIGN



DOM00S



KERANIUM





THICKNESS

0.8 cm

1.2 cm

2.0 cm

The cut to size rate in Aura Bookmatch is not applied if the wastage is greater than 40%

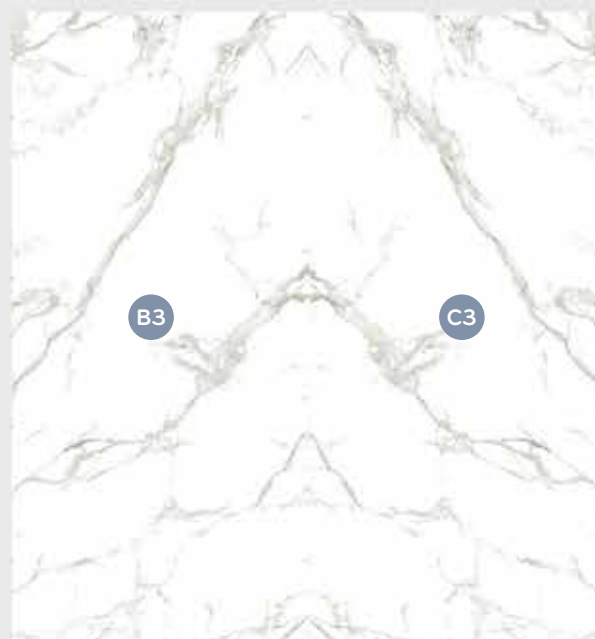

SYMMETRICAL PATTERN

With Aura we have evolved from a single slab design to an endless symmetrical pattern. With 8 unique designs we can reproduce matching compositions that allow continuous vein matching from slab to slab.

There are 2 possible ways to order Aura:

Regular Aura slabs. You will receive a random pattern and the slabs are available in our warehouse.

Book and Vein matched Aura slabs. These slabs are available on demand and will be stocked at our HUB facilities.

Aura is matched vertically and horizontally; we have a system with letters and numbers so you can select the pattern that better fits your needs. Notice that you can choose different combinations depending on the amount of vein you like in your design. You may also choose from vertical or horizontal matching as well as traditional mirror bookmatching effect or vein matching.



Aura 15 book match will take 3-4 weeks from order

COMPLEMENTARY PRODUCTS by Cosentino®

DEKTON CUTTING TOOLS

CODE	DESCRIPTION	UNIT
907004	CUTTING BLADE DEKTON EVOGRES D.400 AXIS 60	UD
323972	CUTTING BLADE DEKTON ITALDIAMANT EVOGRES 350MM	UD
322902	CUTTING BLADE DIAMAN 400 B0-R/2COS3 TECNODIAMANT	UD
322901	CUTTING BLADE DIAMAN 350 B0-R/2COS3 TECNODIAMANT	UD
905642	CUTTING BLADE 45° Z1CRD2260	UD
905985	MANUAL CUTTING BLADE D. 180MM	UD
905624	CUTTING BLADE MANUAL MACHINE D125	UD
906925	CONCAVE BLADE 125MM	UD
906444	MILLING CUTTER CNC 6.FRE26L48	UD
906933	ROUTER FOR INCREMENTAL CUTTING	UD
905702	DRILL BIT DEKTOOL 35 M14 REF 08416.NE02 DKT	UD
906923	DRILL BIT DEKTOOL 20MM	UD

OTHER CUTTING TOOLS

CODE	DESCRIPTION	UNIT
309146	WET AIR GRINDER 7000RPM GPW 216C	UD
906934	ELECTROLYTIC DIAMOND WHEEL GR50	UD
906924	DIAMOND DRUM WHEEL	UD
323274	SHARPENING STONE	UD

DEKTON POLISHING TOOLS

CODE	DESCRIPTION	UNIT
905682	DEKTON POLISHING PAD D100 GR60	UD
905683	DEKTON POLISHING PAD D100 GR200	UD
905686	DEKTON POLISHING PAD D100 GR1000	UD
905687	DEKTON POLISHING PAD D100 GR2000	UD
905688	DEKTON POLISHING PAD D100 GR3000	UD
905685	DEKTON POLISHING PAD D100 GR5000	UD
905633	TWINCUR-RESIN EG2 125 MM 100 R	UD
905634	TWINCUR-RESIN EG2 125 MM 200 R	UD
905636	TWINCUR-RESIN EG2 125 MM 500 R	UD
905635	TWINCUR-RESIN EG2 125 MM 1000 R	UD
905637	TWINCUR-RESIN EG2 125 MM 2000 R	UD
905638	TWINCUR-RESIN EG2 125 MM 3000 R	UD
905639	TWINCUR-RESIN EG2 125 MM TSUYA	UD
905640	VELCRO ATTACHMENT TRAY FOR POLISHING MACHINES D125	UD

SILESTONE POLISHING TOOLS

CODE	DESCRIPTION	UNIT
901550	SILESPAD GR50	UD
901551	SILESPAD GR60	UD
901552	SILESPAD GR120	UD
901553	SILESPAD GR200	UD
901554	SILESPAD GR400	UD
901555	SILESPAD GR800	UD
901556	SILESPAD GR1500	UD
901557	SILESPAD GR3000	UD
901724	BOX SILESEEDGER STRAIGHT EDGE 60 PT	BOX
901733	BOX SILESEEDGER STRAIGHT EDGE 120 PT	BOX
901734	BOX SILESEEDGER STRAIGHT EDGE 220 PT	BOX
901717	BOX SILESEEDGER STRAIGHT EDGE 400 PT	BOX
901718	BOX SILESEEDGER STRAIGHT EDGE 600 PT	BOX
901725	BOX SILESEEDGER STRAIGHT EDGE 800 PT	BOX
901719	BOX SILESEEDGER STRAIGHT EDGE 1.500 PT	BOX
901720	BOX SILESEEDGER STRAIGHT EDGE 3.000 PT	BOX
901722	BOX SILESEEDGER SPECIAL EDGE GR.220 PT	BOX
901713	BOX SILESEEDGER SPECIAL EDGE GR.400 PT	BOX
901715	BOX SILESEEDGER SPECIAL EDGE GR.600 PT	BOX
901716	BOX SILESEEDGER SPECIAL EDGE GR.800 PT	BOX
901732	BOX SILESEEDGER SPECIAL EDGE GR 1500 PT	BOX
901723	BOX SILESEEDGER SPECIAL EDGE GR 3000 PT	BOX
91206	PADS FOR SUEDE GRAIN 36	UD
91207	PADS FOR SUEDE GRAIN 46	UD
91208	PADS FOR SUEDE GRAIN 60	UD
91209	PADS FOR SUEDE GRAIN 120	UD
91210	PADS FOR SUEDE GRAIN 220	UD
91211	PADS FOR SUEDE GRAIN 300	UD
91212	PADS FOR SUEDE GRAIN 400	UD

OTHER POLISHING TOOLS

CODE	DESCRIPTION	UNIT
905316	MACHINE UFO (LEGEND COUNTERTOP 290)	UD
905323	KIT PADS UFO	UD
310200	PNEUMATIC RADIAL WET AIR SANDER/P GPW-218L	UD
905626	PADS SR00038, 100MM	UD
905625	PADS SR00039, 100MM	UD
905628	PADS SR00040, 100MM	UD
90017	MANUAL POLISHING PADS (SET OF 6 PADS)	UD
90019	RIGID TRAY FOR WET POLISHING PNEUMATIC RADIAL	UD
318396	FLEXIBLE TRAY FOR POLISHING PNEUMATIC RADIAL	UD

COMPLEMENTARY PRODUCTS by Cosentino®

SILESTONE ADHESIVES

CODE	DESCRIPTION	UNIT
VARIOUS	SOLUMASTIK SILESTONE (PUTTIES)	UD
VARIOUS	COLORSIL, COLOURED (SILICONE)	UD
90947	COLORSIL, TRANSPARENT	UD

DEKTON ADHESIVES

CODE	DESCRIPTION	UNIT
VARIOUS	MASTIDEK (PUTTIES)	UD
VARIOUS	COLORDEK, COLOURED (SILICONE)	UD
905609	COLORDEK, TRANSPARENT (SILICONE)	UD
906247	CAULKING GUN MASTIDEK	UD

CLEANING AND MAINTENANCE

CODE	DESCRIPTION	UNIT
90012	DISHWASHER INSULATION (UD)	BOX
901406	INSULATION SILESTAPE 30X3 MM	ROL
901405	INSULATION SILESTAPE 20X3 MM	ROL
90004	CARE KIT (CLEANPACK)	UD
91191	Q-ACTION 500ML	UD
90951	CLEAN COLORSIL	UD

TREATMENTS

CODE	DESCRIPTION	UNIT
323528	TLS1040 SENGUARD BOTTLE 375 ML	UD
237260	KIT COLOR ON	UD

OTHERS

CODE	DESCRIPTION	UNIT
901563	PERFECT SEAMS	UD
905992	SUCTION OCTOPUS 150	UD



imagine & anticipate

GENERAL TERMS AND CONDITIONS

SCOPE OF GENERAL TERMS AND CONDITIONS

All contracts between Cosentino UK Ltd. ("the Company") registered at Unit 10 Bartley Point, Osborn Way RG27 9GX, Hook, Hampshire and the person, firm or company who accepts the quotation from the Company for the sale of the goods or whose order of the goods is accepted by the Company ("the Customer") shall be governed exclusively by these terms and conditions of sale. No variation or addition to these conditions shall be binding unless agreed in writing by the authorised representatives of the Company.

ORDERS AND SPECIFICATIONS

The Customer shall make the orders to the Company either by fax or email, as previously agreed. It will be responsibility of the Customer to ensure that the specifications put in the order correctly reflects their requirements.

A quotation by the Company does not constitute an offer and the Company reserves the right to withdraw or amend the same at any time prior to the Company's acceptance of the Customer order.

The quality, quantity and specification of the goods shall be those set out in the order form, subject always to the following: a) All natural materials supplied such as marble, stone and granite are subject to their natural markings, veinings, variations in colour, cracks and vents. These are supplied clamped, stopped or reinforced where necessary and no claim on this account can be made. b) When samples of natural stone have been submitted, identical resemblance of the product supplied to the sample cannot be guaranteed. c) Any descriptions of material offered are for guidance only and do not imply suitability for any particular purpose. d) All thicknesses quoted are nominal and no liability is accepted for reasonable variations of whatsoever nature.

Any alterations the Customer makes after templates have been made may be subject to an extra charge.

PAYMENT CONDITIONS

With exception of those particular conditions stipulated in writing with the Customer, Customers shall pay the goods provided by 30 days after to the invoice date.

In case of default of payment (either in total or in part) by the Customer, the Company shall have the right to cancel any outstanding order with the Client without prejudice of the possible damages and interests to be claim.

The Company reserves the right to charge interest at the legal rate in force per month on unpaid balances (whether before or after any judgment).

DELIVERY OF GOODS

Delivery of goods shall be upon physical delivery by the Company or collection by the Customer or authorised agent from the Company. Any dates quoted for delivery of the goods are approximate only and the Company shall not be liable for any delay in delivery of goods howsoever caused. The Company will endeavor to fulfill its agreed commitments to its Customers, however due to the vagaries of the availability of materials used the Company can only offer an expected time. Time for delivery shall not be of the essence of the contract unless expressly agreed by the Company in writing.

The Company shall not accept any return once the Customer has signed the POD without prejudice of those situations regulated in other provisions of these general conditions.

Notwithstanding any other provision of these conditions, the property in the goods shall not pass to the Customer until The Company has received full payment for the goods. Until such time, as the property in the goods passes to the Customer (and provided the goods are still in existence and have not been re-sold), the Company shall be entitled at any time to require the Customer to deliver up the goods to the Company, and if the Customer fails to do so forthwith, to enter upon any premises of the Customer or any third party where the goods are stored and repossess the goods. If the Customer shall have resold the goods, the proceeds of such sale shall be held by the Customer as trustee for and to the account of the Company.

WARRANTIES AND LIABILITY

The Company warrants that the goods will correspond with their description at the time of delivery. The Company shall not be liable for failure to deliver the goods if the failure is due to reasons beyond the Company's reasonable control.

Risk of damage to or loss of the goods shall pass to the Customer at the time of delivery or, if the Customer wrongly fails to take delivery of the goods, the time when the Company has tendered delivery of the goods. The Company shall be under no liability in respect of any defect in the goods arising from any sample drawing, design, specification or template supplied by or on behalf of the Customer. The Company shall be under no liability in 1013 respect of any defect arising from wear and tear, willful damage, negligence, abnormal working conditions, failure to follow the Company's instructions (whether oral or in writing), misuse or alteration or repair of the goods without the Company's approval.

Subject as expressly provided in the conditions, and except where the goods are sold to a person dealing as a Customer (within the meaning of the Unfair Contract Terms Act 1977) all warranties, conditions or other terms implied by statute or company law are excluded to the fullest extent permitted by law.

Where the goods are sold under a Consumer Transactions (Restrictions on Statements) Order 1976 the statutory rights of the Customer are not affected by these conditions.

Any claim by the Customer which is based on any defect on the quality or condition of the goods or their failure to correspond with their description shall (whether or not delivery is refused by the Customer) be notified to the Company within three days from the date of delivery and, in any event, prior to the fabrication of the final product. If delivery is not refused, and the Customer does not notify the Company accordingly, the Customer shall be entitled to reject the goods and the Company shall have no liability for such defect or failure, and the Customer shall be bound to pay the price as if the goods had been delivered in accordance with the contract.

Where the Customer deals as a consumer, the provisions of s35 of the Sale of Goods Act 1979 (as amended) shall replace the provisions referred to in clause above. Where any valid claim in respect of the goods which is based on any defect in the quality or condition of the goods or their failure to match their description is notified the Company in accordance with these conditions, the Company shall be entitled to replace the goods (or the part in question) free of charge or, at the discretion of the Company, refund to the Customer the price of the goods (or a proportionate amount of the price) but the Company shall have no further liability to the Customer.

Except in respect of death or personal injury caused by the Company's negligence, the Company shall not be liable to the Customer by reason of any representation (unless fraudulent) or any implied warranty condition or any other term or any duty at common law, or under the express terms of contract, for any indirect special or consequential loss or damage (whether for loss of profit or otherwise) cost expenses or other claims for compensation whatsoever (whether caused by the negligence of the Company, its employees or agent otherwise) which arise out of or in connection with the supply of the goods, their installation by the Company, their use, and the entire liability of the Company under or in connection with the contract shall not exceed the price of the goods, except as expressly provided in these conditions. In no event shall the Company be liable to the Customer for any incidental or consequential loss, damage or injury.

The Company reserves the right to change these terms and conditions from time to time and when they affect current Customer orders the Company will advise the Customer accordingly in sufficient time to allow the Customer to amend or terminate the contract by written notice.

SALVEGUARD CLAUSE

If any provision of these terms and conditions is held by any competent authority to be invalid or unenforceable in whole or in part the validity of the other provisions of these conditions and the remainder of the provision in question shall not be affected.

APPLICABLE LAW AND JURISDICTION

The contract shall be governed by the laws of England and the Customer agrees to submit to the non exclusive jurisdiction of the English courts.



COSENTINO NETWORK

AUSTRALIA

Cosentino Brisbane
Cosentino City Sydney
Cosentino Melbourne South
Cosentino Melbourne North
Cosentino Sidney
Cosentino Lo Adelaide
Cosentino Perth
Cosentino Hub Sydney

AUSTRIA

Cosentino Viena

BELGIUM

Cosentino Belgium

BRAZIL

Cosentino Belo Horizonte
Cosentino Fortaleza
Cosentino Goiânia
Cosentino Latina Vitoria
Cosentino Recife
Cosentino Sao Paulo
Cosentino Santa Catarina

CANADA

Cosentino Calgary
Cosentino Vancouver
Cosentino Toronto
Cosentino Quebec
Cosentino City Toronto
Cosentino City Montreal

FINLAND

Cosentino Helsinki

FRANCE

Cosentino Paris
Cosentino Lyon
Cosentino Rennes
Cosentino Toulouse

DENMARK

Cosentino Hedensted

GERMANY

Cosentino Munchen
Cosentino Berlin
Cosentino Düsseldorf
Cosentino Stuttgart

HOLLAND

Cosentino The Netherlands

IRELAND

Cosentino Dublin

ISRAEL

Cosentino Tel Aviv

ITALY

Cosentino Venezia
Cosentino Cattolica
Cosentino Milano
Cosentino City Milano

JAPAN

Cosentino Tokio

MALAYSIA

Cosentino Kuala Lumpur

MEXICO

Cosentino Mexico DF

NEW ZEALAND

Cosentino Auckland

NORWAY

Cosentino Oslo

PORTUGAL

Cosentino Lisboa
Cosentino Porto

SINGAPORE

Cosentino LO Singapore
Cosentino City Singapore

SOUTH AFRICA

Cosentino Cape Town
Cosentino Johannesburgo

SPAIN

Cosentino A Coruña
Cosentino Bilbao
Cosentino Barcelona
Cosentino Castellón
Cosentino Mérida
Cosentino Madrid
Cosentino City Madrid
Cosentino Murcia
Cosentino San Sebastian
Cosentino Santander
Cosentino Sevilla
Cosentino Toledo
Cosentino Valencia
Cosentino Valladolid
Cosentino Zaragoza
Cosentino Girona
Cosentino Granada
Cosentino Almería
Cosentino Vigo

SWEDEN

Cosentino Göteborg

SWITZERLAND

Cosentino Zurich

TURKEY

Cosentino Ankara
Cosentino Estambul
Cosentino Izmir

UK

Cosentino Darlington
Cosentino East London
Cosentino Gloucester
Cosentino Hook
Cosentino City London
Cosentino Manchester
Cosentino Scotland

UNITED ARAB EMIRATES

Cosentino LO Dubai
Cosentino City Dubai

USA

Cosentino Anaheim
Cosentino Atlanta
Cosentino Austin
Cosentino Boston
Cosentino Charlotte
Cosentino Chicago
Cosentino Cincinnati
Cosentino Dallas
Cosentino Denver
Cosentino Detroit
Cosentino Fort Lauderdale
Cosentino Hawaii
Cosentino Houston
Cosentino Kansas City
Cosentino Long Island
Cosentino Los Angeles
Cosentino Milwaukee
Cosentino Minneapolis
Cosentino New Jersey
Cosentino New Orleans
Cosentino Orlando
Cosentino Philadelphia
Cosentino Phoenix
Cosentino Pittsburg
Cosentino Portland
Cosentino Raleigh
Cosentino Rochester
Cosentino Sacramento
Cosentino Saint Louis
Cosentino San Diego
Cosentino San Francisco
Cosentino Seattle
Cosentino Spokane
Cosentino Washington DC
Cosentino Westchester
Cosentino Virginia
Cosentino City Manhattan
Cosentino City Miami
Cosentino City San Francisco
Cosentino Hub Houston
Cosentino Hub Norfolk



COSENTINO HQ HOOK
Unit 10 Bartley Point / Osborn Way
Hook / Hampshire / RG27 9GX
Phone: 01256 761229
Info.uk@cosentino.com

COSENTINO DARLINGTON
Unit 2 / Faverdale East Business Park
Darlington / County Durham / DL3 0UR
Phone: 01325 361010
darlington@cosentino.com

COSENTINO E. LONDON
Unit 6a Waterglade Industrial Estate
Weston Avenue / West Thurrock / RM20 3FJ
Phone: 01708 869102
eastlondon@cosentino.com

COSENTINO GLOUCESTER
Unit F. Nexus 2 / Gloucester Business Park
Gloucester / GL3 4AG
Phone: 01452 651180
gloucester@cosentino.com

COSENTINO MANCHESTER
Unit C/D Guinness Circle
Trafford Park / Manchester / M17 1EB
Phone: 01618 886270
manchester@cosentino.com

COSENTINO SCOTLAND
Unit 2 Kingsthorne Park
Houston Industrial Estate
Livingston / Scotland / EH54 5DB
Phone: 01506 432817
scotland@cosentino.com

www.cosentino.com / www.silestone.com / www.dekton.com

 [cosentinouk.ie](https://www.facebook.com/cosentinouk)  [CosentinoUK](https://twitter.com/CosentinoUK)



*Check terms and conditions ** To obtain more information about colours with NSF certificate please visit www.nsf.org