

AA006000

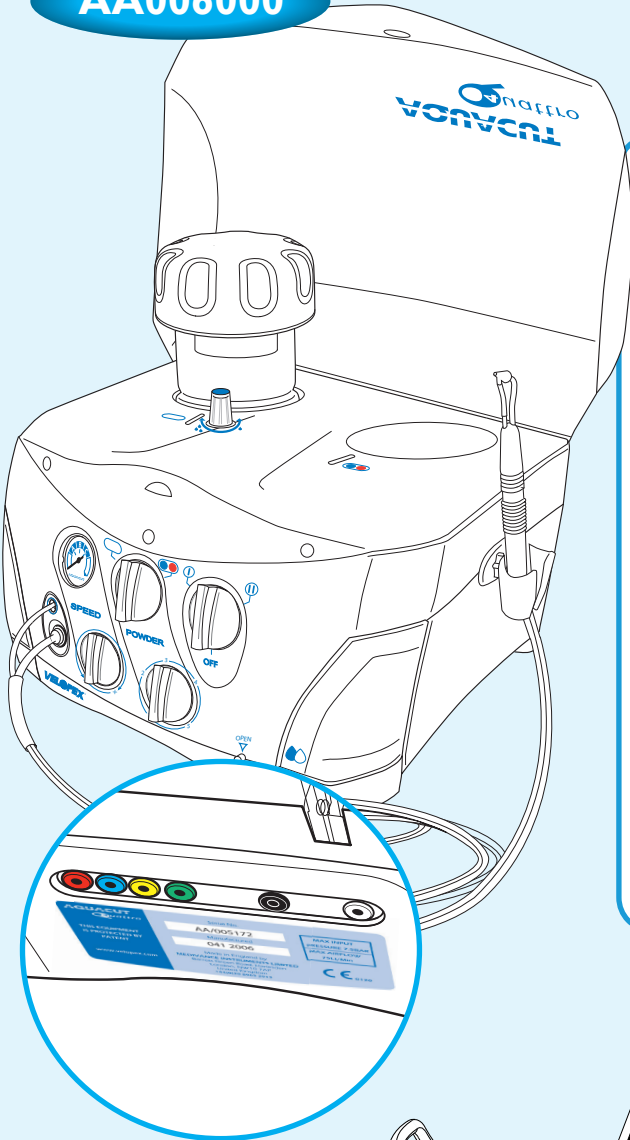

Contents

Sommaire\Lieferumfang\Contenuti\Contenido\Содержание

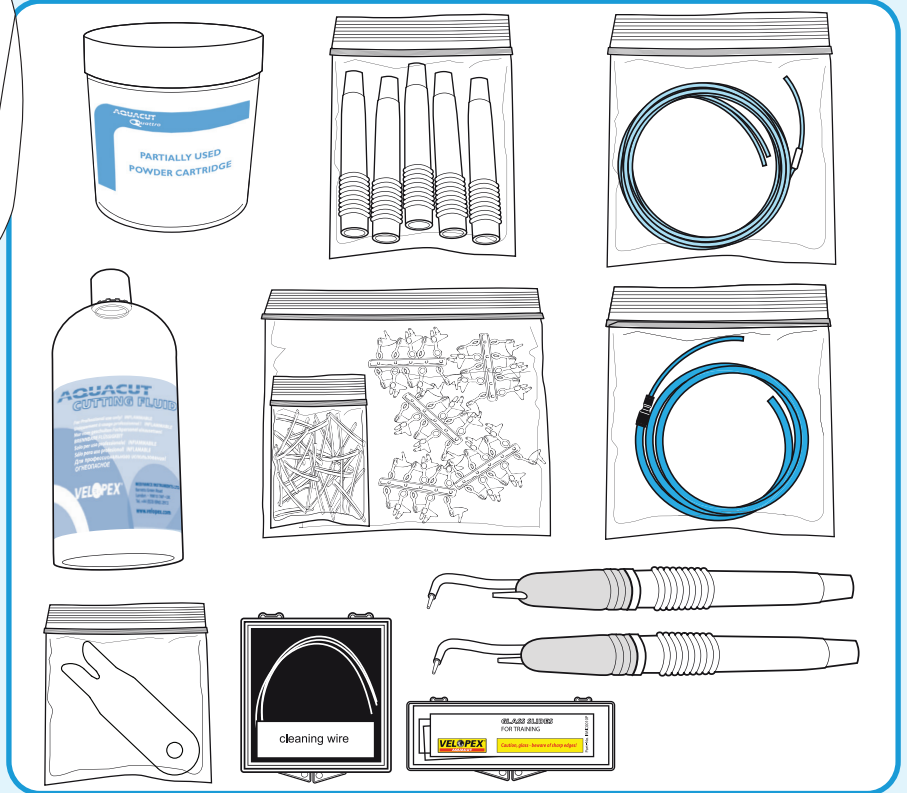

Symbols

Symboles\Symbole\Simboli\Símbolos\Обозначения

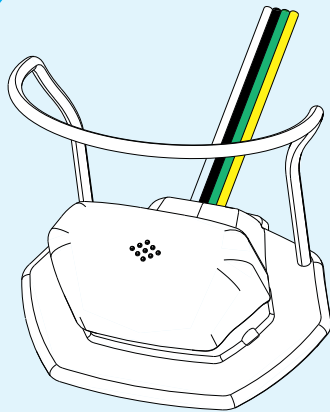

Sylc for
Aquacut

Sodium
Bicarbonate

29 micron
Aluminium Oxide

53 micron
Aluminium Oxide

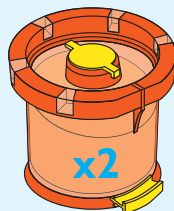
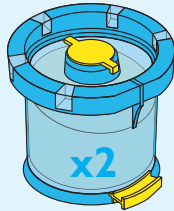
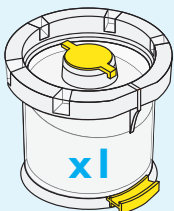
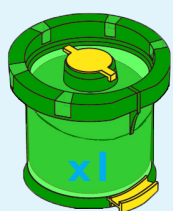

VELPEX

CE
0120

OFF	Air supply off/Distribution d'air arrêt/Luftzufuhr aus/Alimentazione dell'aria spenta (posizione 'off')/Suministro de aire 'apagado'/выключено
I	Air supply on/Distribution de l'air marche/Luftzufuhr an/Alimentazione dell'aria accesa (posizione 'on')/Suministro de aire 'encendido'/включено. Сжатый воздух
II	Secondary gas on/Seconde alimentation de gaz marche/Sekundäre Gasversorgung an/Alimentazione del gas secundario accesa (posizione 'on')/Suministro secundario de gas 'encendido'/Включено. Сжатый газ
	Polishing powder select/Sélecteur poudre de polissage/das Polieren von ausgesuchtem Puder/Selezione polvere da lucidatura/Selección del polvo de pulido/сода бикарбонат
	Cutting powder select/Sélecteur poudre de coupe/der Ausschnitt von ausgesuchtem Puder/Selezione polvere da taglio/Selección del polvo de corte/порошок для препарирования
I—5	Powder volume control/Contrôle de volume de poudre/Puder-Fluss-Volumen-Kontrolle/Controllo volume flusso della polvere/Control del volumen de flujo de polvo/Регулировка количества порошка
-- +	Cutting speed control/Contrôle de vitesse de coupe/der Ausschnitt der Geschwindigkeitsvolumen-Kontrolle/Controllo volume velocità' del taglio/Control de la velocidad de corte/Регулировка скорости
	Fluid tank/Cuve alimentation liquide/Flüssiger Versorgungstopf/Contenitore di alimentazione del liquido/Cubo de suministro de líquido/Резервуар для жидкости
	Pressure gauge/Jauge apport en alimentation/Druckanzeige/Misurazione della potenza di immissione/Nivel de potencia de entrada/манометр
	Fluid volume control/Contrôle du volume de fluide/Steuerung der Flüssigkeitsmenge/Controllo del volume del liquido/Control de volumen de fluido/Регулировка количества воды

Safety

Sécurité\Sicherheit\Sicurezza\Seguridad\Безопасность

Wear goggles



Portez des lunettes de protection\Tragen Sie eine Schutzbrille\Indossare occhiali di protezione\Utilice gafas protectoras\Наденьте защитные очки

Wear a mask



Portez un masque\Tragen Sie eine Atemschutzmaske\Indossare una mascherina\Utilice mascarilla\Наденьте маску

Use an aspirator



Utilisez un aspirateur\Verwenden Sie ein Absauggerät\Usare un aspiratore\Use aspirador\Используйте aspirатор

Protect sensitive equipment from dust

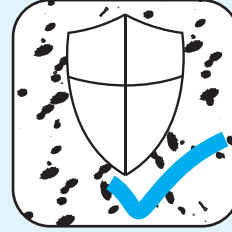

Protégez les équipements sensibles de poudre\Schützen empfindliche Geräte von Pulver\Proteggere le apparecchiature sensibili da Polvere\Proteger equipo sensible de Polvo\защиту чувствительного оборудования

Sterilise handpiece between treatments

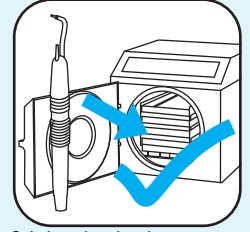

Stérilisez la pièce à main entre traitements\Das Handstück muss zwischen den Behandlungen sterilisiert werden\Sterilizzare tra trattamenti il manipo\o\ Esterilice las piezas manuales entre tratamientos\Стерилизуйте регулярно насадки

Don't step on tubes



Ne marchez pas sur les conduites\Nicht auf Leitungen treten\Non calpestare i tubi\No pise los tubos\Не наступайте на трубки

Don't place in sunlight

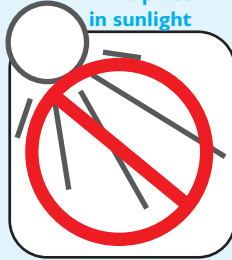

Ne l'exposez pas à la lumière directe du soleil\Vor Sonneneinstrahlung schützen\Non esporre direttamente alla luce del sole\No exponga al sol\Не переводите в режим естественного освещения

Replace feedline & tip between treatments



Remplacez la ligne d'alimentation et l'embout entre traitements\Luftzuleitung und Düse müssen zwischen Behandlungen getauscht werden\Sostituire tra trattamenti i tubicini ed i puntali\Reemplace las puntas y cables de alimentación entre tratamientos\Заменяйте регулярно трубку подачи и наконечник

Use Velopex parts

VELOPEX

Utilisez des pièces Velopex\Es müssen Velopex Ersatzteile verwendet werden\Usare i componenti Velopex\Utilice piezas Velopex\Используйте детали Velopex

Training

Formation\Schulung\Collaudo\Preparación\Подготовка

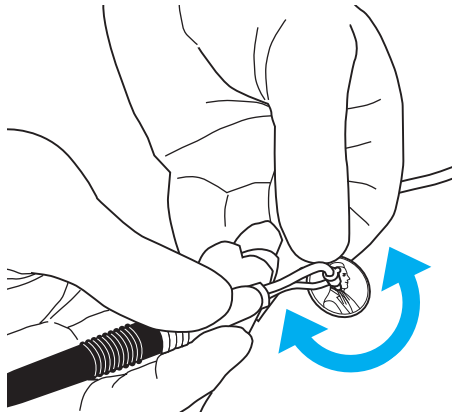
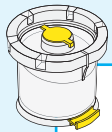

Clean\Nettoyage\Reinigung\Pulizia\Limpieza\Чистка

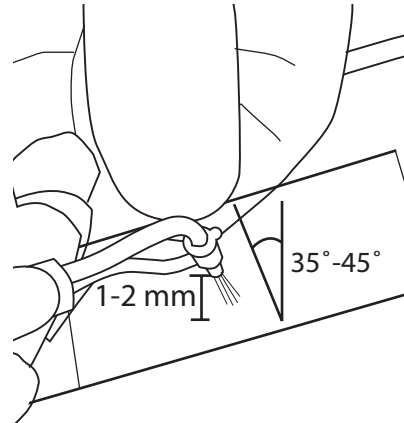
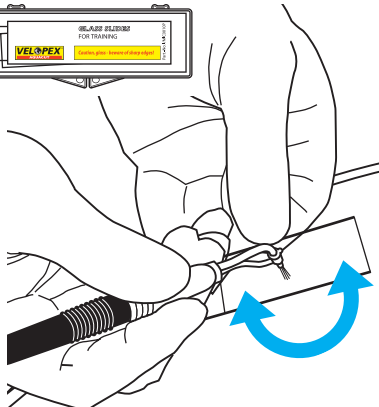
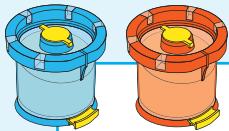

Cut\Couper\Schneiden\Taglio\Cortar\СНИМАТЬ

1

Attaching the foot pedal\Mise en place de la pédale à pied\Anschließen des Fußschalters\
Aggiungere il pedale\Colocación del pedal\Подсоедините ножную педаль

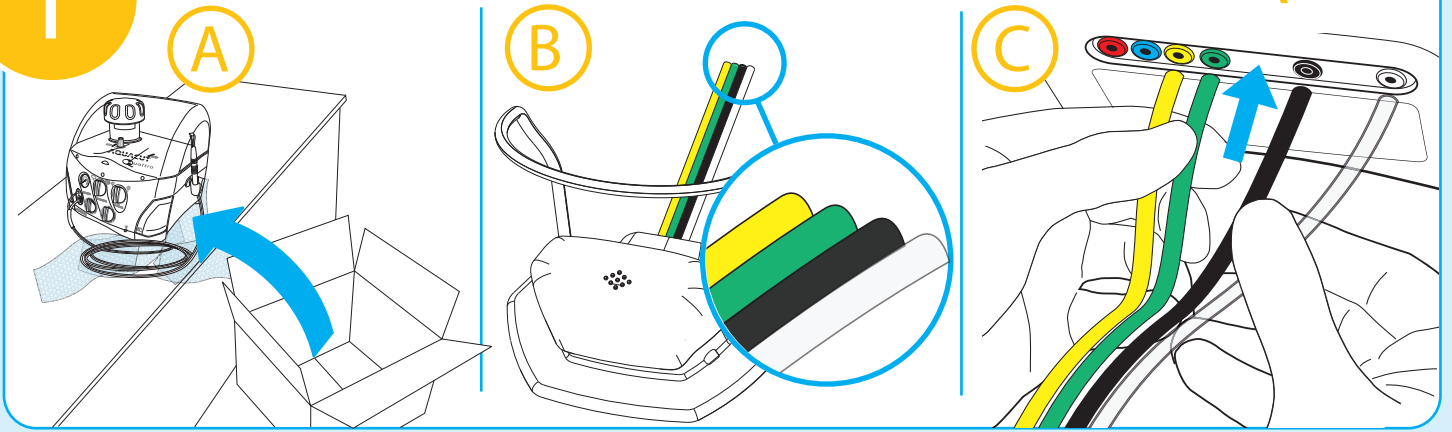

2

Filling the fluid tank\Remplissage du réservoir d'eau\Wassertank füllen\
Riempire il serbatoio dell'acqua\Lenado del depósito de agua\Заполните резервуар водой

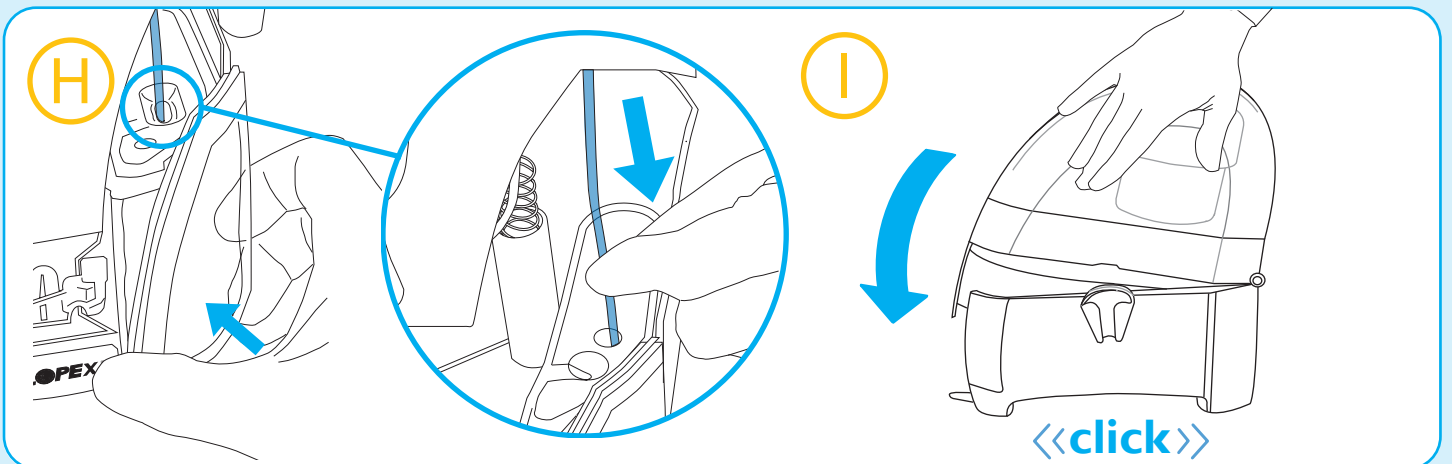
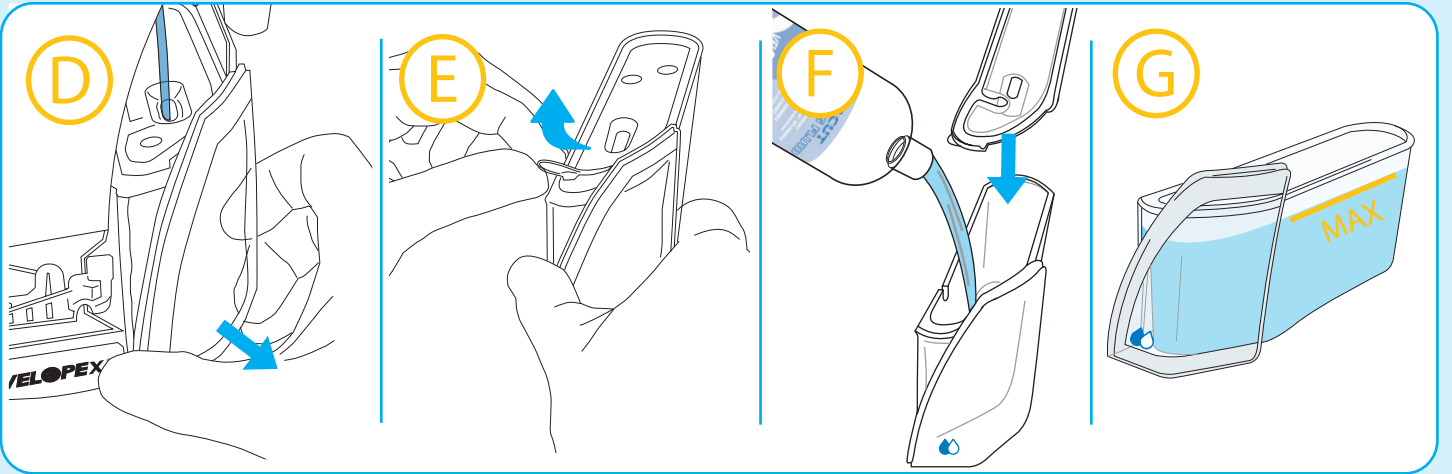
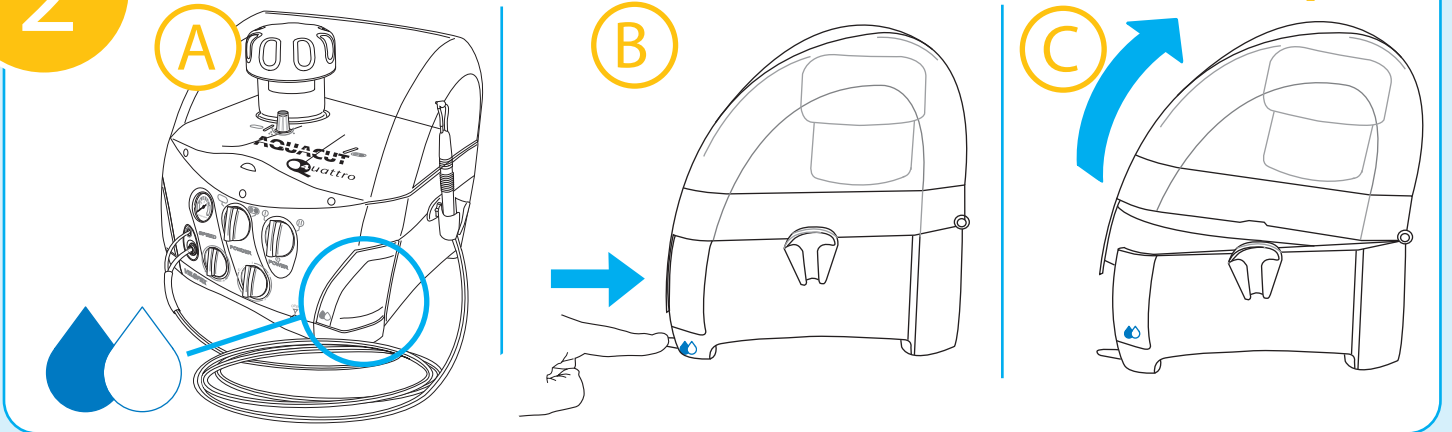

<<click>>

3

Assembling the handpiece\Montage de la pièce à main\Anschluß des Handstücks\
Montare il manipolo\Colocación de las piezas manuales\Присоедините наконечник

A

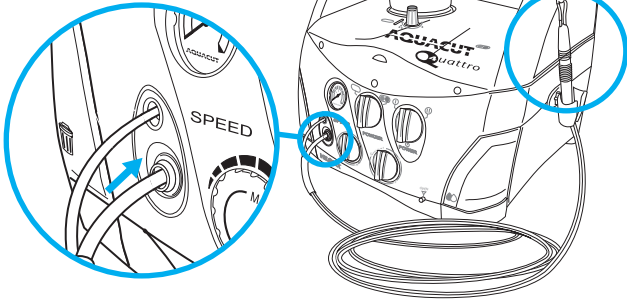

B

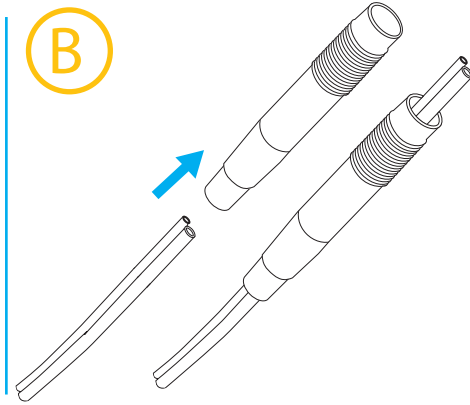

C



D

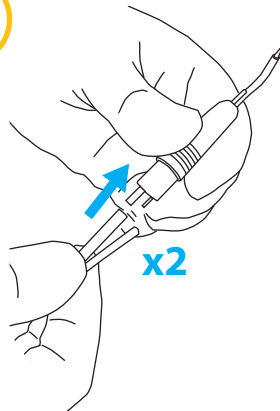

E

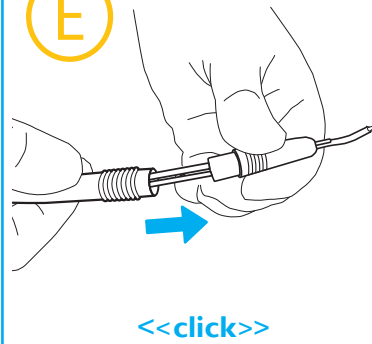

F

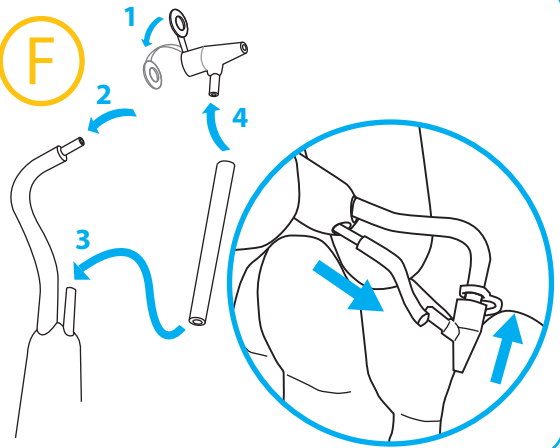

4

Connecting the air supply\Connexion de l'alimentation en air\Anschluss der Luftzufuhr\
Collegare il generatore d'aria\Conexión del suministro de aire\подключите подачу сжатого воздуха

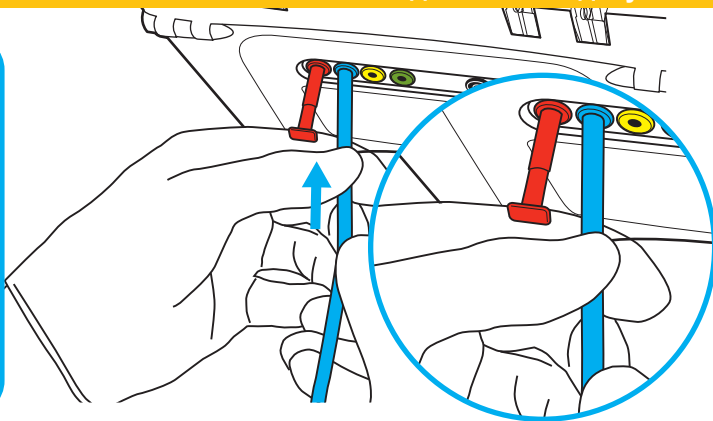
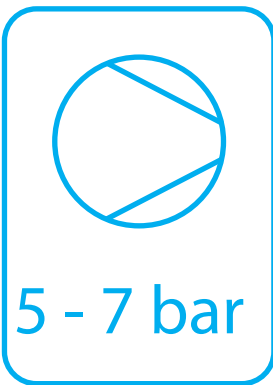

5

Fitting the powder cartridges\Mise en place des cartouches de poudre\Montage der Pulverkartuschen\
Sistemare le cartucce di polvere\Colocación de los cartuchos de polvos\вставьте картридж с порошками

A

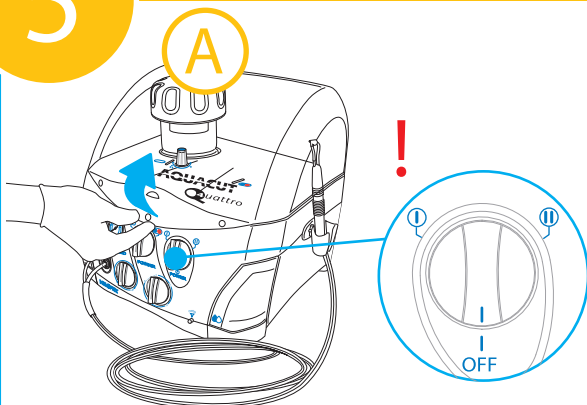

B

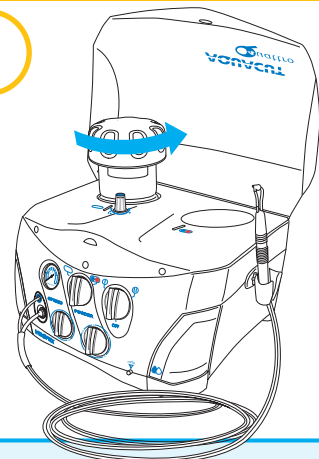

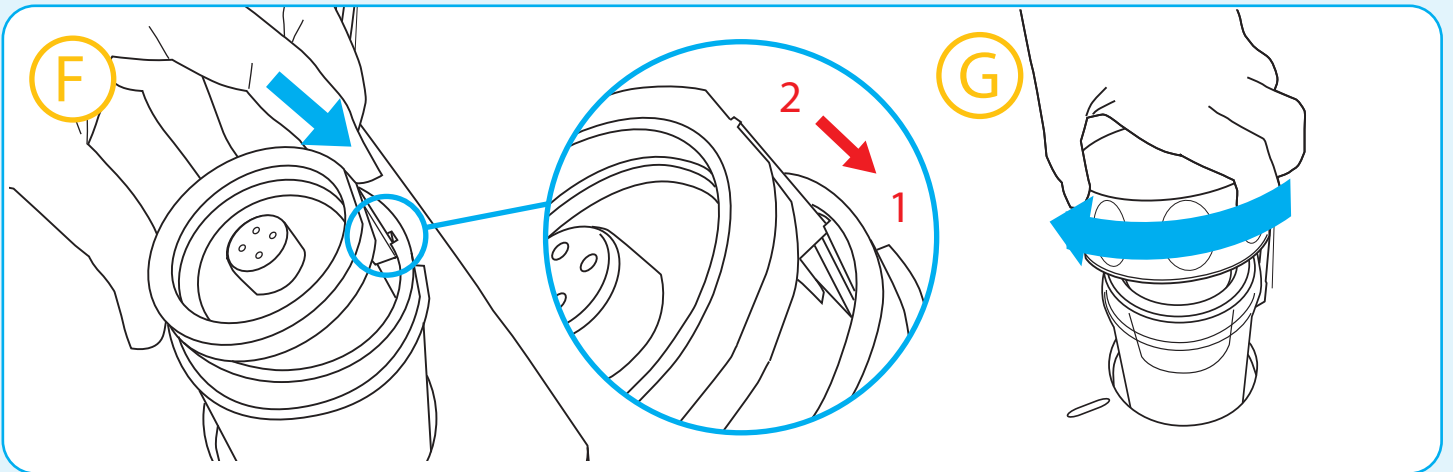
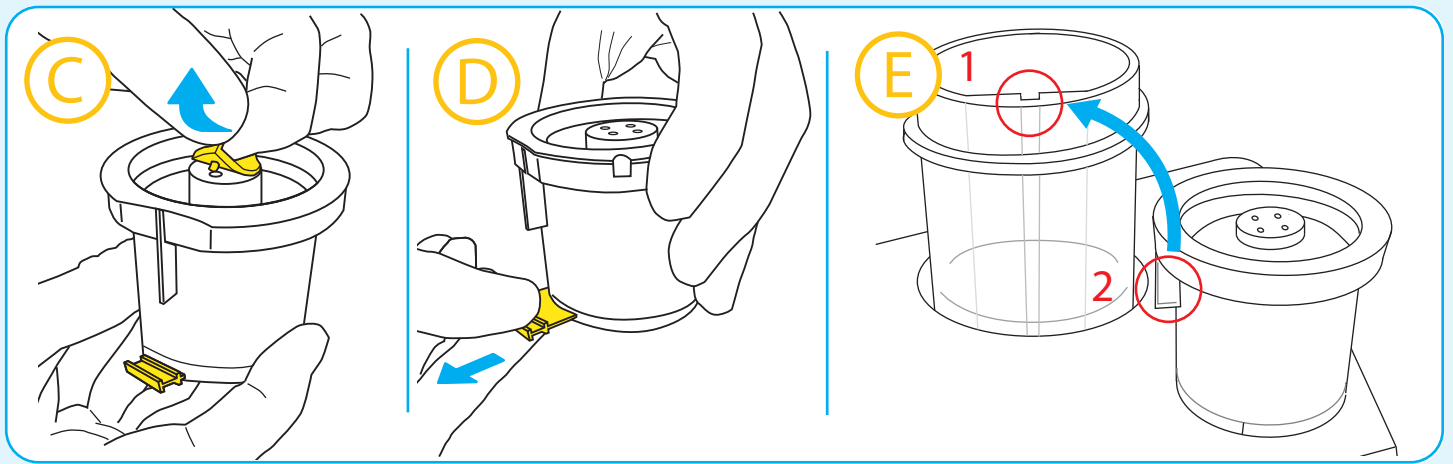

6

Using the controls\Utilisation des commandes\Verwendung der Steuerungen\ Usare i comandi\Usó de los controles\Использование элементов управления

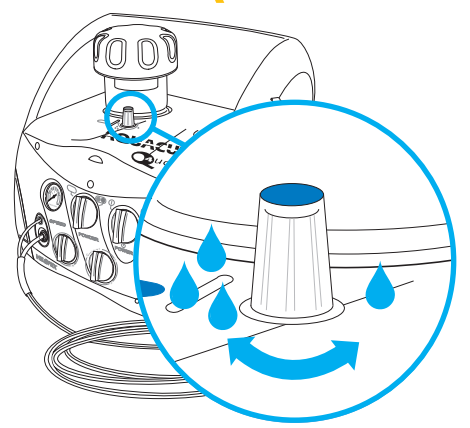
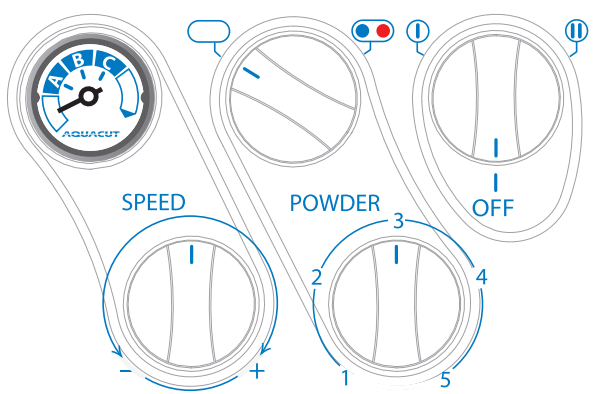

7

Using the foot pedal\Utilisation de la pédale à pied\Verwendung des Fußschalters\ Usare il pedale\Usó del pedal\Использование ножной педали

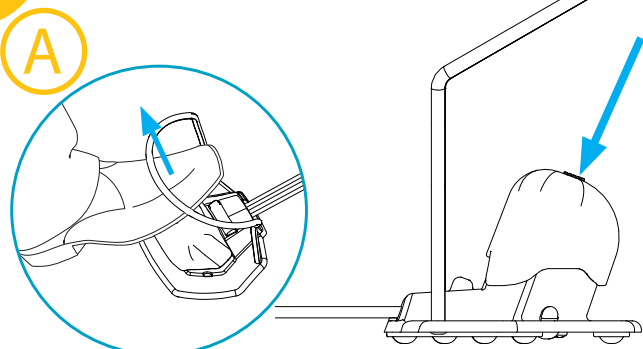

- B**
- 1 = Air/Air/Luft/Aria/Aire/Воздух
 - 2 = Fluid & Air/Fluide & Air/Fluid & Luft/Fluido & Aire/Жидкость & Воздух
 - 3 = Powder & Fluid & Air/Poudre & Fluide & Air/Pulver & Fluid & Luft/Polvere & Fluido & Aria/Polvo & Fluido & Aire/Порошок & Жидкость & Воздух

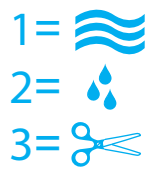

AQUACUT Quattro Jnr.

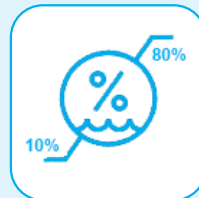
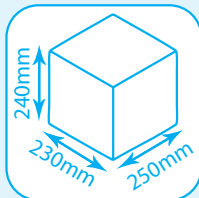
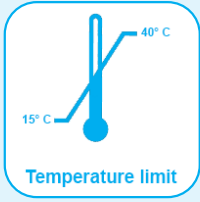
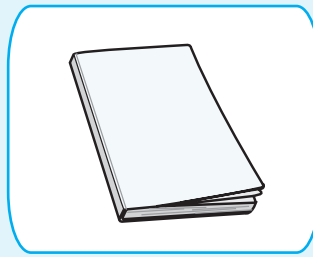

USES: 

Preparation of pit and fissure for sealants. Removal of composites for restoration. Cavity preparation. Cleaning, polishing, and stain removal. Etching.

ONLY QUALIFIED DENTISTS SHOULD USE THE AQUACUT QUATTRO. GIVE SPECIAL CONSIDERATION TO PATIENTS WITH:

1) Respiratory difficulties	2) Asthma
3) Blocked nasal passages	4) A cold
5) Restricted sodium diet	6) Any medical problem preventing breathing through the nose.

Patients suffering from the above must consult their physician before treatment.

UTILISATIONS: 

Préparation des cavités et des fissures pour les scellements. Élimination de composites pour la restauration. Préparation de cavités. Nettoyage, polissage et élimination de tâches. Gravure.

SEULS DES DENTISTES QUALIFIÉS DOIVENT UTILISER L'AQUACUT QUATTRO. NOUS RECOMMANDONS UNE PRUDENCE TOUTE PARTICULIÈRE FACE À DES PATIENTS PRÉSENTANT :

1) Des difficultés respiratoires	2) De l'asthme
3) Des voies nasales obstruées	4) Un rhume
5) Un régime pauvre en sodium	6) Tout problème médical empêchant le patient de respirer par le nez.

Les patients présentant ce genre de troubles doivent consulter leur médecin avant de recevoir ce traitement

EINSATZMÖGLICHKEITEN: 

Vorbereitung von punktförmigen Vertiefungen und Fissuren für Versiegelung. Entfernen von Komposit-Restaurationen. Kavitätenpräparation. Reinigen, Polieren und Zahnbelagentfernung. Abätzen.

NUR QUALIFIZIERTE ZAHNÄRZTE DÜRFEN AQUACUT QUATTRO VERWENDEN. BESONDERE VORSICHT IST BEI PATIENTEN MIT FOLGENDEN KRANKHEITSSYMP-TOMEN GEBOTEN:

1) Atembeschwerden	2) Asthma
3) Blockierte Nasenatmung	4) Schnupfen
5) Eingeschränkte Natriumdiät	6) Andere medizinische Probleme, die eine Atmung durch die Nase erschweren .

Patienten, die an den oben genannten Symptomen leiden, müssen vor der Behandlung ihren Arzt konsultieren

USI: 

Preparazione di solchi e fessure per sigillatura. Rimozione dei compositi per la ricostruzione. Preparazione della cavità. Pulizia, lucidatura e rimozione di macchie. Acquaforte.

L'UTILIZZO DI AQUACUT QUATTRO È RISERVATO ESCLUSIVAMENTE A DENTISTI QUALIFICATI. SI DEVE PRESTARE PARTICOLARE ATTENZIONE AI PAZIENTI CHE PRESENTINO:

1) Difficoltà respiratorie	2) Asma
3) Ostruzione delle vie nasali	4) Raffreddore
5) Regime dietetico a regime iposodico	6) Qualsiasi altro problema che potrebbe impedire una corretta respirazione.

I pazienti affetti dai disturbi indicati nel precedente elenco devono consultare il proprio medico prima di sottoporsi al trattamento.

USOS: 

Preparación de las piezas picadas y fisuras para los selladores. Eliminación de composites para restauración. Preparación de la caries. Limpieza, pulido y eliminación de manchas. Grabado.

UNICAMENTE LOS DENTISTAS CUALIFICADOS DEBERÍAN USAR AQUACUT QUATTRO. PRESTAR ESPECIAL ATENCIÓN A PACIENTES CON:

1) Problemas respiratorios	2) Asma
3) Congestión nasal	4) Resfriado
5) Dieta baja en sodio	6) Cualquier otro problema médico que pueda impedir que el paciente respire normalmente por la nariz.

Si un paciente sufre alguno de los trastornos anteriores, deberá consultar a su médico antes de someterse a un tratamiento.

ПРИМЕНЕНИЕ: 

Диагностика и лечение кариеса, раскрытие и герметизация фиссур, реставрация, снятие зубного налета.

ОСОБОЕ ВНИМАНИЕ СЛЕДУЕТ УДЕЛЯТЬ ПРИ РАБОТЕ ПРИБОРОМ AQUACUT С ПАЦИЕНТАМИ, КОТОРЫЕ В АНАМНЕЗЕ ИМЕЮТ :

1) ЗАБОЛЕВАНИЯ ДЫХАТЕЛЬНОЙ СИСТЕМЫ;	2) АСТМУ
3) ПРОСТУДУ	4) НАСМОРК
5) ПРОБЛЕМЫ МЕДИЦИНСКОГО ХАРАКТЕРА, КОТОРЫЕ МОГУТ ПРЕПЯТСТВОВАТЬ ДЫХАНИЮ ПАЦИЕНТА ЧЕРЕЗ НОС	

Пациенты имеющие вышеуказанные проблемы должны проконсультироваться со своим лечащим врачом, прежде чем начать лечение.