



Canadian Concrete Masonry Producers Association

Metric Technical Manual

Firewalls

By Gary Sturgeon, B.Eng., MSc., P.Eng.
Technical Services Engineer, CCMPA



This Chapter of the CCMPA Metric Technical Manual has been largely reproduced from “*Firewalls, A Design Guide*”, published by the Canadian Concrete and Masonry Codes Council (CCMCC) in 1992. It also includes updates for consistency with NBCC-10, and additional material synthesized from other related documents.

5A.1 What is a Firewall?

A *firewall* is the ultimate defense against the spread of fire. It must be able to withstand the onslaught of a fire and prevent further fire spread by containing it to one side of the wall until the fire burns itself out, or is extinguished.

The most stringent provisions in our Building Codes with regard to structural stability and fire performance apply to *firewalls*. *Firewalls* must be suitably designed and constructed to function as a barrier against the spread of fire and smoke. They are subject to very specific requirements regarding use, fire-resistance rating, structural stability, and construction. Requirements for *firewalls* are not typical of any other *fire separation*. The NBCC-10 definition for *firewall* states that it must have the “*structural stability to remain intact under fire conditions for the required fire-rated time*”. If a fire were to occur on one side of a *firewall*, collapse of the building or of a portion of the building on the fire-exposed side of the *firewall* must not cause the *firewall* to collapse or otherwise fail within the code-required, fire-rated time assigned to that *firewall*. This need for structural integrity during the fire event is an important distinction between the Building Code requirements for a *firewall* and for a *fire separation*. Because of this important distinction, design options and recommendations for compliance with the structural stability requirements for *firewalls* are discussed in the “*Structural Considerations*” section of this chapter.

The term *firewall* is often used when referring to a *fire separation*. This is incorrect. As noted in Chapter 5 of this Manual, a *fire separation* is typically a wall or floor assembly that acts as a barrier to the spread of smoke and fire, yet it may or may not be required to have a fire-resistance rating, although most do have some inherent fire-resistance. A required fire-resistance rating for a *fire separation* may be achieved through the use of combustible or noncombustible building materials, provided combustible construction is permitted for the building by the Building Code. A *fire separation* need not satisfy requirements for structural integrity. These are not the case for a *firewall*.

Specific to the design of *firewalls* intended to comply with Part

3 of NBCC-10, code references include the following:

- a. requirements pertaining to determining fire-resistance ratings are stated in Subsection 3.1.7, and Appendix D, Division B, “*Fire Performance Ratings*”;
- b. requirements for closures are provided in Subsection 3.1.8;
- c. requirements for service penetrations are given in Subsection 3.1.9;
- d. requirements pertaining to *firewall* connections and their relationship to structural collapse, required fire-resistance ratings, *firewall* continuity, and projection beyond combustible construction are contained in Subsection 3.1.10;
- e. requirements related to their structural design are provided in Article 4.1.5.17 and in Commentary “C”, “*Structural Integrity of Firewalls*” in the “*User’s Guide—NBC 2010, Structural Commentaries (Part 4 of Division B)*”.

Requirements specific to *firewalls* under Part 9 of the NBCC are contained in Subsection 9.10.11. Notably, by Article 9.10.11.3, where *firewalls* are used they are to be constructed in accordance with the requirements of Part 3.

Until the 2005 edition of the NBCC, all *firewalls* regardless of the required fire-resistance rating were required to be constructed of concrete or masonry. The 2005 edition of the NBCC permitted *firewalls* having a fire-resistance rating of not more than 2 hrs. to be constructed of other than concrete or masonry. This requirement remains unchanged in the 2010 edition. Discussions pertaining to this requirement, the use of alternative *firewall* construction, and the associated inherent risks of using other than concrete or masonry *firewall* construction are provided in Section 5A.7.1 of this chapter.

Chapter 5 “*Fire Performance*”, offers the groundwork for an understanding of fire performance issues, provides discussion fully relevant to *firewalls*, and complements the information specific to *firewalls* provided in this chapter. The reader is therefore urged to review the material presented in Chapter 5.

5A.2 Application of Firewalls

A *firewall* is designed and constructed with the primary purpose of dividing a building into separate entities or *building areas*, which are considered as separate *buildings* under the NBCC for the purposes of fire protection. The wall acts as a barrier against the spread of fire from one area to another to prevent major conflagration, total

or partial loss of the building of fire origin, total or partial loss of adjacent buildings, and injury to occupants of the building of origin and to occupants beyond.

In accordance with the assigned and stated *Objectives* of Part 2, Division A, NBCC-10, and the assigned and stated *Functional Statements* of Part 3, Division A, a firewall is intended to:

- limit damage to the building of origin due to fire, explosion, or collapse of physical elements or structural insufficiency, or loss of use due to structural insufficiency;
- limit damage to adjacent buildings, or otherwise beyond the building of origin caused by fire, explosion or collapse of physical elements; and,
- limit exposure of building occupants, and occupants in adjacent buildings to injury due to fire, explosion, structural insufficiency or collapse of physical elements.

The firewall satisfies these objectives by:

- retarding the effects of fire beyond its point of origin;
- limiting or accommodating expected loads and forces;
- retarding its own failure or collapse due to the effects of fire or explosion; and,
- resisting deterioration expected from service conditions.

5A.2.1 Separation of Buildings

The division or separation of buildings by a firewall can be utilized in a number of situations. Where a wall is jointly owned and used by two parties sharing a building and is erected at or upon a property line, it is called a party wall. Since, in effect, it divides a single building extending across a property line into two buildings, it must be constructed as a firewall (Article 9.10.11.1, NBCC-10).

The use of a firewall in a building under one ownership on a single property can be beneficial. The two areas of a building created by a dividing firewall are each considered by the NBCC as separate areas (Figure 5A.1) (Article 1.3.3.4, Division A, NBCC-10). The fire protection requirements of the NBCC are then applied to each separate area rather than to the building as a whole.

Such requirements typically become less stringent with a decrease in building area. Therefore, it is usually more economical to apply the fire protection requirements of each smaller portion of the building than those of the building as a whole. Installation of several firewalls at appropriate intervals will permit a structure to contain a total area many times the maximum permitted for a single building area. Height and area limitations based on the occupancy, type of construction and fire fighter access govern the number of firewalls required within a given building.

Figure 5A.1: Example Firewall Location

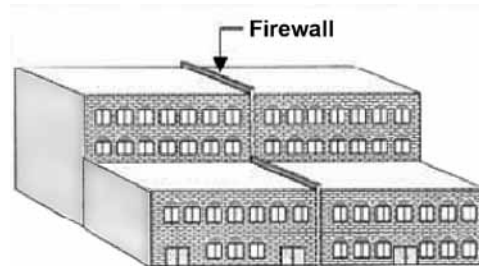

5A.2.2 Separation of Major Occupancies

A firewall can also be used for the separation of major occupancies (Figure 5A.2) (Article 3.1.10.2, NBCC-10). Although most different major occupancies can share the same building, a high hazard occupancy (Group F, Division 1) is not permitted in the same building as an assembly, institutional or residential occupancy (Groups A, B, or C) (Article 3.1.3.2, NBCC-10).

Figure 5A.2: NBCC Minimum Firewall Ratings

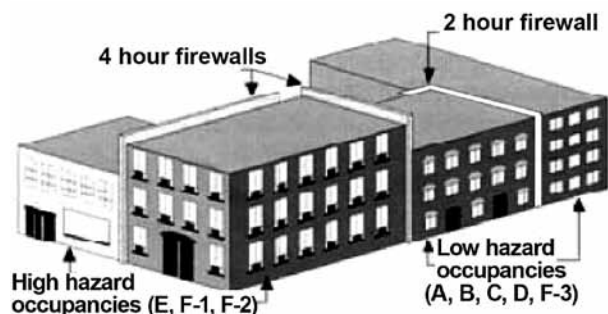

Note: Group F-1 occupancies are not permitted within the same building as Group A, B or C occupancies (Article 3.1.3.2, NBCC-10).



5A.2.3 Additions and Renovations

A firewall can also be useful when adding to, or rehabilitating an existing building. A proposed addition may increase a building's area so that more stringent fire protection requirements must then be applied to the entire building, not only to the addition. Placing a firewall at a well-chosen location divides the old and new construction into separate buildings. Thus, the existing building would not require upgrading to the current Building Code. The addition may also then be permitted to comply with less stringent fire protection requirements than would the total building.

Many buildings constructed years ago do not, and cannot, comply with fire protection requirements of today's Building Code because of their construction type. If, because of renovation, such a building would be required to be upgraded to comply with the current Building Code, the use of a firewall to create two smaller buildings that meet current fire protection requirements may be the solution.

5A.2.4 Business Loss Reductions

Many factories and warehouses enclose large areas used for hazardous processes and storage of products. In such buildings, firewalls are the ideal type of fire separation for use in limiting the amount of materials that may be exposed in a fire. Dividing a building into truly isolated fire compartments that will confine a fire to its place of origin and prevent its spread is the most important means of reducing the over-all fire risk in a building. Limiting fire spread will limit the loss of supplies, machinery, and records. Delays incurred in replacing a destroyed building can result in a permanent loss of customers. Saving a portion of a building reduces the amount of reconstruction and material replacement needed, and permits quicker resumption of operations.

5A.3 Fire-Resistance Ratings

5A.3.1 Determination of Ratings

Fire-resistance rating (FRR), its concept, its determination using fire testing, alternative Code compliant means to establish FRR for concrete block masonry, the affects of cell fill, the affects of additional finishes, and a variety

of other related topics are discussed in detail in Chapter 5.

Like a masonry fire separation, the equivalent thickness of concrete block masonry is used to calculate the fire-resistance rating of a firewall, and additionally, the grout in partially grouted masonry construction is excluded from the equivalent thickness calculation. However, unlike a masonry fire separation, and in accordance with Sentence 3.1.10.2.(3) of NBCC-10, the required fire-resistance rating of a firewall must be provided by masonry or concrete only. The consequence of this Sentence is that the inclusion of cell material other than grout/concrete or mortar cannot contribute to the fire-resistance rating of a masonry firewall whether all cells are filled or not. Appendix A-3.1.10.(4) explains that inherent in the use of a firewall is the intent that the wall construction also provides resistance to physical damage arising out of normal use that would compromise the fire-resistance rating of the assembly. Specific to concrete masonry construction, the use of mortar or grout fill, unlike loose fill materials such as vermiculite or perlite, will not lead to a spill of the cell material and the attendant loss of fire-resistance rating if the face shell of the masonry unit is compromised. This has been a prescriptive requirement for concrete masonry firewalls for many editions of the NBCC.

Concrete block masonry construction used for firewalls does not require "special" masonry mortars. Conventional Type N and Type S mortars, in accordance with CSA A179-04, *"Mortar and Grout for Unit Masonry"*, are suitable.

NBCC-10 does not assign or limit fire-resistance ratings of concrete masonry based upon bond pattern (running and stack). Therefore, the determination of the fire resistance rating of concrete masonry is independent of bond pattern.

5A.3.2 Fire-Resistance Requirements for Firewalls

A building's fire load is related to the combustible content of the occupancy as well as to its construction materials. The degree of fire-resistance required for a firewall is based on the assumed fire load of a building and the



expectation that the firewall will withstand a complete burnout of any portion of a divided building. For a building which will contain highly combustible or hazardous materials, or large amounts of combustibles, a required firewall must have at least a 4 hour fire-resistance rating [3.1.10.2.(1), NBCC-10]. A firewall with not less than a 2 hour rating is deemed to be sufficient by the NBCC for dividing low hazard occupancies [3.1.10.2.(2), NBCC-10]. If a firewall is to separate a high hazard occupancy and a low hazard occupancy into two building areas, it must be constructed in accordance with the firewall requirements for the greater hazard (Table 5A.1 and Figure 5A.2). Notwithstanding these code requirements, a designer should determine if the fire-resistance rating required by the Building Code will be sufficient to provide adequate fire safety based on the proposed use of the building, particularly where a 2 hour firewall is required by the code. Additional fire-resistance rating may be needed. Compared to a 2 hour firewall, constructing a masonry firewall as a 4 hour wall can usually be done for little additional cost because no “special” construction is required. This can be particularly beneficial if possible future occupancy changes may include high hazard uses.

Table 5A.1: NBCC Fire-Resistance Ratings of Required Firewalls (Constructed from NBCC-2010 requirements, Sentence 3.1.3.2.1 and Article 3.1.10.2)

Building Area Occupancy	Minimum Required Fire-resistance Rating			
	Adjoining Building Area Occupancy			
	A, B or C	D or F-3	E or F-2	F-1
A, B or C	2 h	2 h	4 h	N.P.
D or F-3	2 h	2 h	4 h	4 h
E or F-2	4 h	4 h	4 h	4 h
F-1	N.P.	4 h	4 h	4 h

N.P. Occupancies not permitted within same building

Due to perceived high risk, there may be situations where a firewall is desired in a building even though it would not be required by the Building Code. Such a wall may have whatever fire-resistance rating that is deemed appropriate for service by the designer. If such a wall

is shown on project construction drawings as a firewall having a stated fire-resistance rating, it must meet all of the structural requirements of the Building Code which apply to firewalls. Otherwise, the wall must be termed a fire separation and the building and construction would not qualify for any of the benefits available by using and specifying a firewall.

5A.4 Structural Considerations

5A.4.1 General

Firewalls must possess sufficient strength to remain standing and intact during their specified rating period. To ensure this, NBCC-10 contains requirements in Subsection 3.1.10 dealing with the structural integrity of firewalls. Additionally, loading and support criteria intended to ensure sufficient strength in the firewall are specified in Article 4.1.5.17.

When designing firewalls structurally, it is necessary to recognize the strength reduction that occurs in connections at elevated temperatures. All external anchors and connections used with firewalls must be fire protected for the required fire rating period. Information on the fire protection required for these components is contained in *Reference 18*.

Both steel and concrete strengths diminish with elevated temperatures. The structural resistances of a firewall should be calculated using strength-temperature relationship data for steel and concrete, and information on temperature distributions within concrete/masonry elements during fire exposures. In general, the rate at which heat reaches the reinforcement in a masonry wall, and thus, the loss of strength of the reinforcing steel, is inversely proportional to the masonry cover provided. Designers should be aware that the minimum cover requirements specified in CSA S304.1 and CSA A371 may not be sufficient to meet the needed structural requirements under fire exposure without consideration of effects of elevated temperatures. Elastic modulus and bond between reinforcement and concrete/grout are also known to decrease with increasing, elevated temperatures. *Reference 10* is a treatise on the effects of elevated temperatures on the physical properties of concretes

and reinforcing steels, and the behaviour of reinforced concrete members. Additional design data pertaining to the effects of elevated temperatures are available in *Reference 8*. The strength of reinforcement as a function of temperature is provided in Table 5A.3, herein.

Additionally, detailed structural recommendations are provided in *Reference 7*.

5A.4.1.1 Structural Integrity

Commentary “C”, “*Structural Integrity of Firewalls*”, within the “*User’s Guide-NBCC 2010, Structural Commentaries (Part 4 of Division B)*”, expands on the rationale of the firewall structural integrity requirements. Sentence 3.1.10.1.(1) of the NBCC requires that the connections and supports of framing members, which are expected to collapse within the fire rated period of the firewall, be detailed such that the collapse of the framing members will not cause a premature failure of the firewall (Figure 5A.3a).

Figure 5A.3a: Illustrating NBCC-10 Sentence 3.1.10.1.(1)

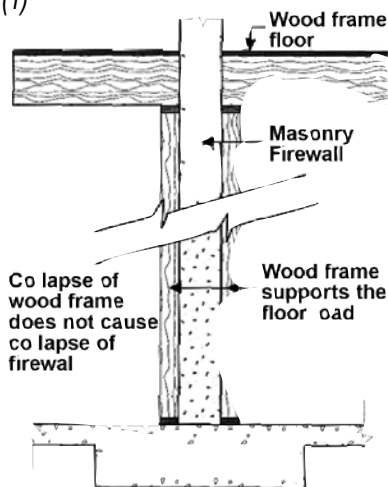

Note: Where a floor or roof member is framed into a firewall, the remaining masonry must have sufficient equivalent thickness to provide the fire-resistance rating required by the firewall. (See Figure 5A.3b).

Sentence 3.1.10.1.(2) of NBCC-10 provides an exception to this requirement. Frames otherwise detailed may be tied to a firewall having a higher fire-resistance rating than the frame, provided the firewall is comprised of two

Figure 5A.3b: Thickness Required at Framed-In Members

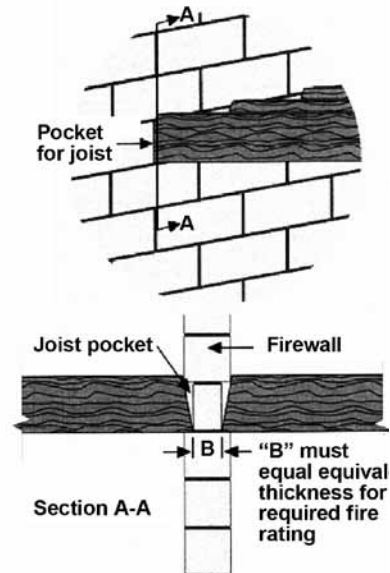
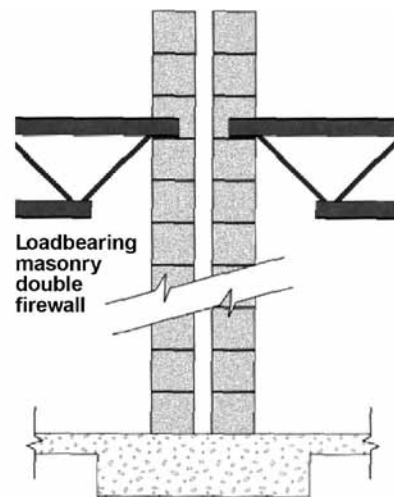

Figure 5A.4: Illustrating NBCC-10 Sentence 3.1.10.1.(2)



separate walls that are structurally independent, each having a fire-resistance rating of at least half of that required for the firewall (termed a “Double Firewall”) (Figure 5A.4).

Where a building frame is non-combustible and possesses a fire-resistance rating equal to or greater than that of the firewall to which it is attached, the requirements of

Figure 5A.5: Illustrating NBCC-10 Sentence 3.1.10.1.(3)

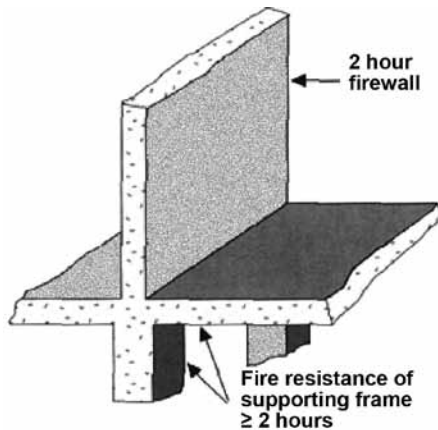

Sentence 3.1.10.1.(3) are applicable. In such cases, the structural frame may provide support to the firewall and the connection of the frame to the firewall need not meet the requirements of Sentence 3.1.10.1.(1). Figure 5A.5 illustrates the requirements of Sentence 3.1.10.1.(3).

5A.4.1.2 Loading Requirements

The lateral loading requirements for firewalls given in Article 4.1.5.17 of NBCC-10 are intended to insure that in addition to being able to resist normal lateral design loads, the firewall possesses sufficient strength to withstand the accidental loads that can be expected during a fire. Requiring a minimum factored lateral load of 0.5 kPa for firewalls is intended to ensure that the firewall possesses sufficient strength to withstand fire induced loads such as glancing blows from falling debris, the thermal shock and force of a fire-hose stream, and some incident wind pressure. Firewalls must, however, be designed to withstand any loads and forces which reasonably may be expected. Because of this, firewalls are not typically designed to be resistant to a major explosion, as this is a severe requirement. Therefore, in most instances, flammable liquid mixing and storage rooms should be located a remote distance from the firewall, or alternatively, explosion venting should be provided.

Firewalls must be designed for the normal structural requirements relating to walls for wind and earthquake, including that for impact damage, as prescribed by Part 4 of the NBCC. If the firewall is used as part of the structural

framing system, the wall should be designed to provide structural integrity in accordance with Commentary “C”, “Structural Integrity of Firewalls” in the “User’s Guide—NBC 2010, Structural Commentaries (Part 4 of Division B)”. Thus, a firewall must be designed to resist the “maximum effect” resulting from these otherwise normal loading conditions prescribed by Part 4, or the 0.5 kPa factored load under fire conditions [4.1.5.17.(1), NBCC-10].

5A.4.1.3 Thermal Expansion

Steel building frames exposed to fire may expand significantly towards a firewall. The three main factors that determine the extent of this expansion are temperature rise, coefficient of thermal expansion, and length of frame over which the temperature rise takes place. Commentary “C” suggests that the thermal expansion of the structure be based on an assumed temperature rise of 500°C. Thermal coefficients of expansion are given in Table E-1 of Commentary “E” in the “User’s Guide—NBC 2010, Structural Commentaries (Part 4 of Division B)”. Half the fire compartment length, up to a maximum distance of 20 m, is suggested by Commentary “C” as the length of frame over which expansion should be considered for design. These guidelines result in a maximum thermal movement of 120 mm for steel structures. Table 5A.2 lists steel frame thermal movement dimensions for various fire compartment lengths as determined by the NBCC guidelines. These values are the minimum clearances (denoted as “X” in later figures) required between steel framing and the firewall or wythes of a firewall located in a steel structure.

Table 5A.2: Thermal Movement Values for Steel Frames

Total Fire Compartment Length ⁽¹⁾ , (m)	Minimum Clearance X for Steel Frame Expansion, (mm)
10	15
15	30
20	45
25	60
30	75
35	90
≥40	120

⁽¹⁾ Dimension perpendicular to the plane of the firewall

5A.4.2 Designing for Thermal Expansion

5A.4.2.1 Unrestrained Frame Expansion

The design and construction of a firewall should ensure that thermal movements do not cause damage to the wall that would allow fire spread through the wall. This can be accomplished in several ways. The firewall can be detailed so that clearance, in accordance with Table 5A.2, is maintained between the wall and the structural frame to accommodate the expected movement (Figure 5A.6). This approach is required when the structural frames on opposing sides of the firewall are not aligned vertically and horizontally, or where the forces of expansion cannot be resisted by the unexposed frame. In practice, the thermal expansion of flexible metal deck roof systems has not been found to impair the serviceability of firewalls. As a result, it is not considered necessary to provide thermal clearance between the edge of such roof systems and the firewall (Figure 5A.6). However, where the roof system is comprised of a stiff membrane, such as a concrete slab over a steel deck, clearance between the edge of the roof and the firewall should be provided to accommodate the anticipated expansion.

Figure 5A.6: Detailing for Thermal Expansion

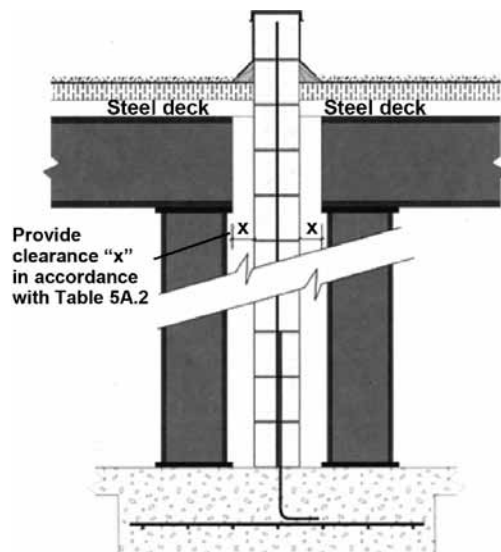

5A.4.2.2 Restrained Frame Expansion

As an alternative approach, and under certain circumstances, the wall may be constructed in close proximity to the building frames. In this case, the fire-exposed frame is allowed to expand and bear against the firewall which in turn bears against the resisting unexposed frame. Figure 5A.7 illustrates the bearing solution to the thermal expansion condition

Figure 5A.7: Expanding Frame Bears Against Firewall

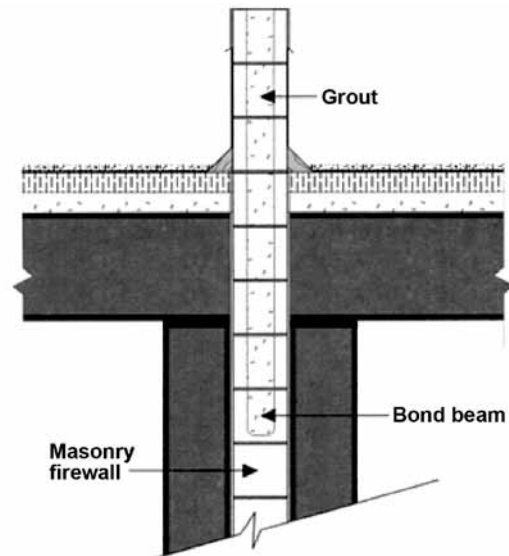

This alternative approach may only be used when:

- the structural framing members are aligned both vertically and horizontally on both sides of the firewall;
- the unexposed frame is capable of resisting the loads imposed by the expanding frame, and;
- a recommended maximum clearance of 20 mm is maintained between the firewall and the frame for walls up to 12.2 m high, with this clearance increased by no more than 6 mm for each additional 3 m of wall height.

If the main framing elements run parallel to the masonry firewall, a continuous bond beam should be installed in the second course below the primary steel framework,

and all cells in the blocks units above should be filled with grout. If they run perpendicular to the firewall, fully grouted areas need only be constructed at the column locations between the framing members. This solid bearing area should extend a distance of not less than 300 mm on both sides of the main framing member at the column location. This condition is illustrated in Figure 5A.8.

Figure 5A.8: *Thermal Expansion Bearing Areas*

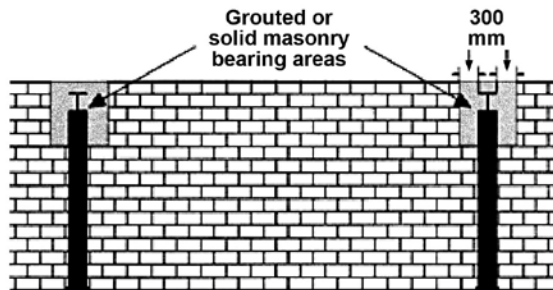

When building frames are allowed to expand and bear against a firewall in this manner, it is important that the recommended maximum clearance of 20 mm be observed. Too much clearance will allow considerable bowing of the firewall between the framing members during the fire. This causes uneven bearing between the wall and the framing elements, which may damage the wall when resistance to expansion begins. Where on-site construction tolerances or other circumstances cause the recommended maximum clearance to be exceeded, corrective measures may include the construction of pilasters or concrete corbels on the wall to reduce the clearance to recommended levels. The pilaster or corbel should be constructed over the same area as that provided for bearing purposes. The configuration of a typical concrete bearing corbel used to reduce the maximum clearance between the wall and the frame is illustrated in Figure 5A.9.

The corbel should be at least as high as the primary structural steel member and, the face abutting the wall should be not less than 600 mm in height.

Figure 5A.9: *Bearing Corbel*

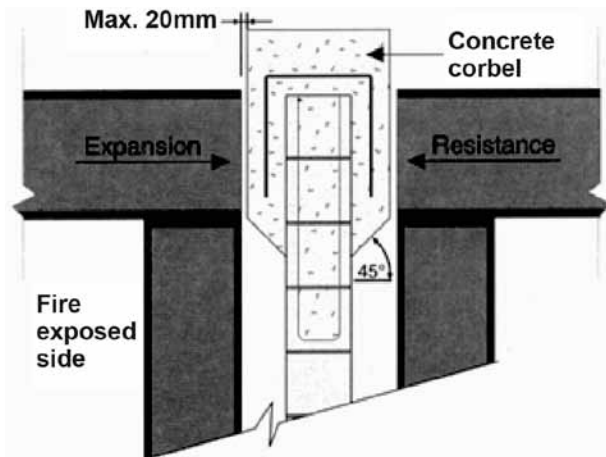

5A.4.2.3 Movement Joints in the Firewall

Masonry firewalls should have construction joints in line with those of the building frame to prevent cracking. The width of these joints is identical to those placed within the building itself.

Masonry firewalls should also have movement joints of sufficient width and frequency of placement to accommodate anticipated in-plane movements caused by short- and long-term shrinkage of the masonry, service temperature changes, anticipated elevated temperatures caused by the fire event itself, and where applicable, in-service structural deformations caused by in-plane loading due to wind and seismic forces.

See Sections 5A.6.2 and 5A.6.5 for discussion regarding joint treatments needed to maintain firewall continuity and integrity.

5A.4.3 Types of Walls

Four basic types of firewalls are used to contain fires in buildings. These are:

1. Double
2. Cantilever
3. Tied
4. Weak Link

The type chosen by the designer will depend on the required fire-resistance rating, building type, scale of

the firewall, and the structural design considerations. A detailed description and application of each of these four basic types of firewalls is provided in 5A.4.4.1, 5A.4.4.2, 5A.4.4.3, and 5A.4.4.4, respectively.

5A.4.4 Design Considerations

5A.4.4.1 Double Firewalls

5A.4.4.1.1 Design Considerations

As the name suggests, a double firewall is comprised of two parallel firewalls which are constructed in close proximity to one another, but which are not structurally connected. Double firewalls are used to meet the requirements of Sentence 3.1.10.1.(2) of NBCC-10 and, as such, may or may not be loadbearing. The structural frame on each side of the firewall must be tied to its respective separate wythe such that failure of the exposed structural frame on the fire-side of the wall results only in collapse of the wythe to which it is connected, without damage to the remaining wythe. Double firewalls are ideally used in providing a fire separation between an existing building and new adjoining construction. These walls are also utilized at expansion joints in buildings as illustrated in Figure 5A.10.

Figure 5A.10: Location of Double Firewalls

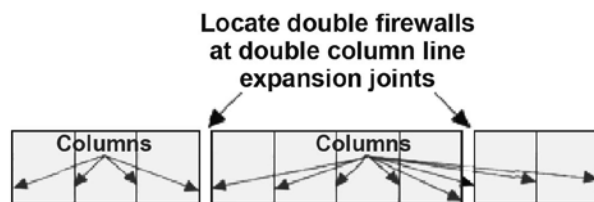

A double firewall is particularly useful with renovations and additions to existing buildings. An existing masonry exterior wall may be modified, if required, to provide an adequate level of fire-resistance. An adjacent masonry wythe may be constructed close to the existing wall and secured to the new building frame. Examples of two types of double firewall assemblies are illustrated in Figures 5A.11a and 5A.11b.

Figure 5A.11a: Loadbearing Double Firewall

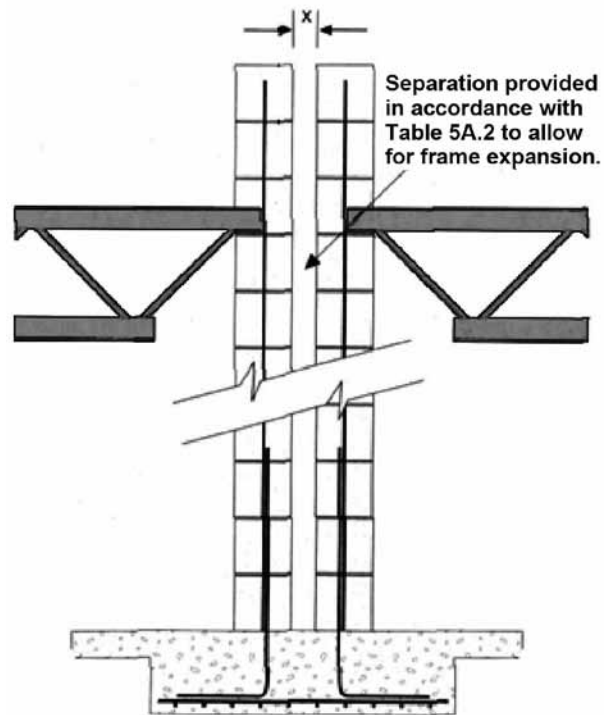

Note: Where a floor or roof member is framed into a firewall, the remaining masonry must have sufficient equivalent thickness to provide the fire-resistance rating required by the firewall. (See Figure 5A.3b).

In Figure 5A.11a, the double firewall provides structural support to the roof joists. In Figure 5A.11b, the steel frame is used to support the roof joists, and the firewall is simply tied back to the frame. In both cases, separation between the walls should be provided in accordance with Table 5A.2 to accommodate the thermal movements expected in a steel building frame during a fire. At sites where the seismic hazard index, $I_E F_a S_a(0.2)$, is equal to or greater than 0.35, special consideration should be given to the separation between the double walls so that pounding during a seismic event is avoided.

Where double firewalls support structural loads, thermal expansion of the frame may cause lateral displacements at the wall top. Curvature of the wall caused by fire exposure on one side will tend to exacerbate this effect.

Figure 5A.11b: *Non-loadbearing Double Firewall*

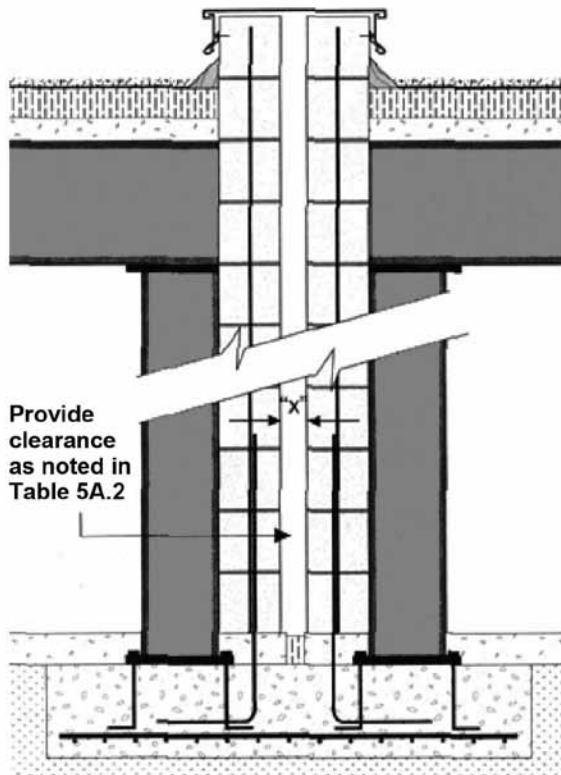

These displacements may induce $P-\delta$ effects. The designer must consider these deformations, and their effects on loading, in the structural design of the firewall, otherwise, it is recommended that the wall be designed as non-loadbearing to ensure that premature failure of the framing is not initiated by collapse of the firewall. For very tall firewalls, the self-weight of the wall may be as much or more than the supported roof dead and live load. The structural resistance of the wall must be sufficient to resist the prescribed lateral loads, vertical loads, and $P-\delta$ effects resulting from anticipated deformations due to elevated temperatures.

Each wythe of the double firewall should be anchored to its respective building framework at the roof level. This connection must have sufficient strength to support the walls under the lateral loads specified in NBCC Article 4.1.5.17. The only connection between the two wythes of the double firewall should be at the flashing. Typical con-

nection details for double firewalls are shown in Figures 5A.12.a and 5A.12.b.

Figure 5A.12a: *Non-loadbearing Double Firewall Connection*

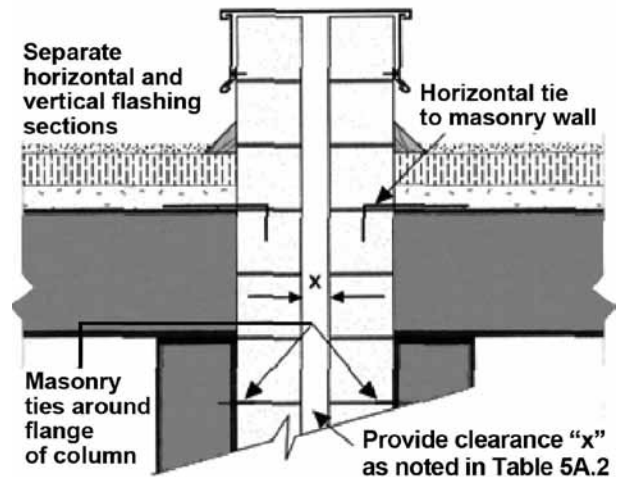
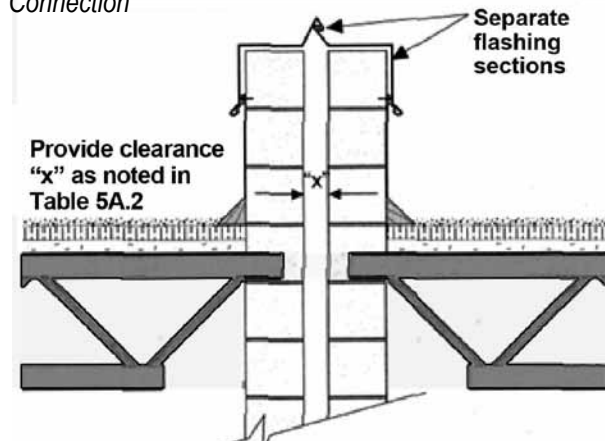

Figure 5A.12b: *Loadbearing Double Firewall Connection*



Note: Where a floor or roof member is framed into a firewall, the remaining masonry must have sufficient equivalent thickness to provide the fire-resistance rating required by the firewall. (See Figure 5A.3b).

The NBCC-10 requires that each of the two walls comprising the double wall need only possess one half of the fire-resistance rating required for the entire firewall [3.1.10.1.(2), NBCC-10]. However, this does not appropriately consider the possibility of premature collapse

of a fire-exposed frame, and hence, the destruction of one wythe of the firewall before half of the required fire-resistance rating period has expired. In light of this, prudent design will ensure that sufficient fire-resistance is provided by each of the two wythes such that adequate fire-resistance is still provided should one wall be prematurely destroyed. This may be accomplished by adjusting the fire-resistance rating of the double walls or ensuring that the building frame attached to the double wall has a fire-resistance rating at least equivalent to that wythe of the wall to which it is attached.

5A.4.4.1.2 Design Recommendations

- Each of the two wythes of a double firewall should have a minimum fire-resistance rating equal to the greater of: (a) half the total fire-resistance rating required, or (b) the total fire-resistance required less the lowest fire-resistance rating assigned to the framing system on either side of the firewall, whichever is greater.
- Sufficiently reinforce each wythe of a double firewall to resist the lateral loadings specified in NBCC-10 Article 4.1.5.17. In the structural design of each wythe, consideration should be given to any eccentric gravity load effects (self-weight, supported floors, etc.) due to thermal bowing or thermal frame displacement (secondary effects). The design strength of the reinforcement, masonry, bond between reinforcement and grout, and the elastic modulus of the assembly should be determined at elevated temperatures using the temperature of these materials at the fire rating time period (Table 5A.3, and *References 10 and 18*).
- Ensure sufficient separation between the two wythes (in accordance with Table 5A.2) in order to accommo-

date the thermal expansion of the connected structural framing at elevated temperatures. Consider any seismic requirements that may require the design to exceed the thermal separation requirements of Table 5A.2.

- Locate double firewalls at expansion joints, or joints between buildings.
- Each wythe of a double firewall should be anchored to its respective building framework at the roof level. There should be no connection between the two firewalls other than the roof flashing.

5A.4.4.2 Cantilever Firewalls

5A.4.4.2.1 Design Considerations

As the name implies, a cantilever firewall is a free standing wall that is not structurally connected to the building frame. This wall is also ideally located at an expansion joint or at joints in the building framing.

NBCC-10 requires that a minimum lateral load of 0.5kPa be resisted by a firewall under fire conditions [4.1.5.17. (1)]. Reinforced concrete masonry walls provide strong cantilever walls, but usable heights are limited by deflection at the wall tops, which greatly affect serviceability and exacerbate the effects of any eccentric loading on the wall. It is most likely that vertical reinforcement will be required to suitably resist the movement developed at the wall base. It should be noted that, in particular, the

Table 5A.3: Reinforcement Strength Reduction Values

Strength remaining in hot rolled reinforcing steel during a standard fire for various concrete types (percent of specified yield strength at 21° C)				
Concrete Cover to Reinforcement (mm)	at 2 hours		at 4 hours	
	Type N	Type S	Type N	Type S
100	86	85	83	83
76	83	83	79	77
50	79	78	67	61
38	72	71	58	30
25	61	45	36	11
19	42	25	20	–
13	28	18	–	–

stability of a cantilever firewall depends on the capacity of its vertical reinforcement which may have a relatively thinner surface cover (surface covers are prescribed by structural design and construction standards, and typically are based upon design considerations rather than fire performance). In such cases, this reinforcement should be designed for reduced strength at elevated temperatures and with greater coverage if required. For calculating reinforcement requirements, the strength reduction values listed in Table 5A.3 are recommended.

For relatively high cantilever firewalls, masonry pilasters may be used to enhance lateral resistance. In general, due to strength and deflection requirements, the practical height limit for a cantilever firewall is about 10 m. For greater heights, use of a tied firewall (subsequently discussed herein) may be more suitable. Three examples of pilaster types integrated with cantilever firewalls are illustrated in Figure 5A.13.

Figure 5A.13: *Cantilever Firewall, Use of Pilasters to Increase Wall Lateral Load Resistance*

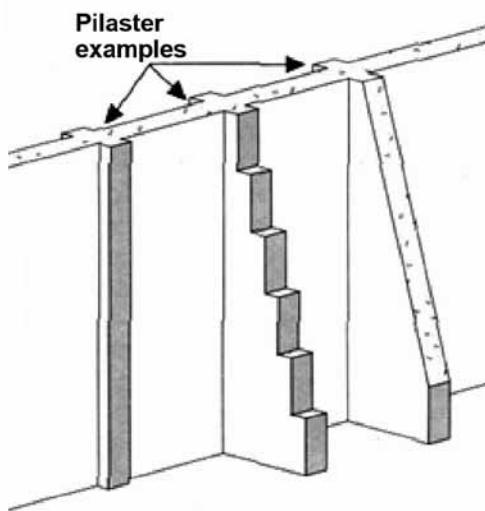

If not appropriately accounted for in the design, the thermal expansion of the fire-exposed building frame may exert high lateral forces on a cantilever firewall, possibly causing the wall to fail prematurely. This is especially true if the steel framing does not align horizontally and vertically on each side of the wall (Figure 5A.7). Where

adjacent framing does not align, sufficient clearance in accordance with Table 5A.2 should be left between the cantilever firewall and the frame to allow full thermal expansion of the frame without damage to the wall. Figure 5A.14 illustrates proper detailing of such a cantilever firewall at the roof level. Where the building frame is aligned both vertically and horizontally on both sides of the wall, the expansive force may be transferred through the firewall to the unexposed frame on the opposite side of the wall by direct bearing, as illustrated in Figure 5A.8. Where the building frame is allowed to expand and bear against the firewall, as described earlier under “Thermal Expansion” (Section 5A.4.1.3), a maximum clearance of 20 mm between the frame and the firewall should be observed. The framing must be designed to resist the imposed forces caused by frame expansion and bearing.

Cantilever firewalls are not recommended at sites where

Figure 5A.14: *Cantilever Firewall Connections*

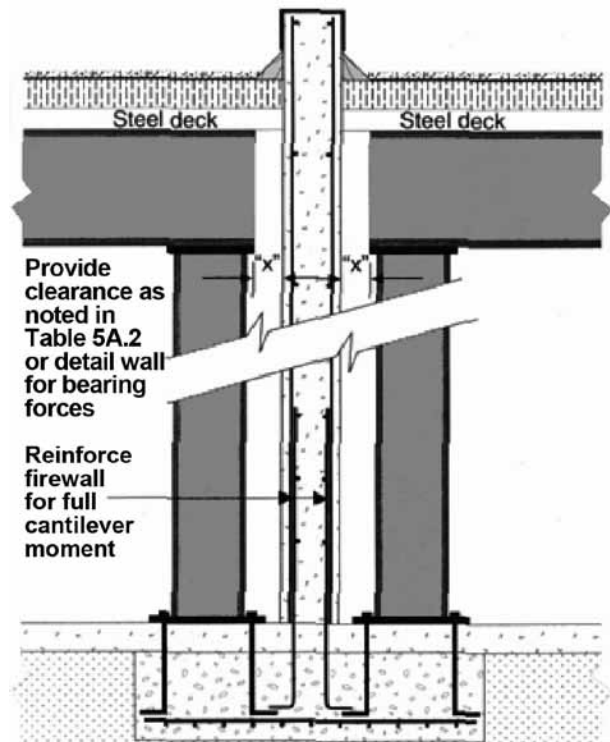

the seismic hazard index, $I_E F_a S_a(0.2)$, is equal to or greater than 0.35. Where used, they should be specifically designed to resist the anticipated seismic event and they must not be allowed to bear against the building frame because this would result in pounding damage during a seismic event.

5A.4.4.2.2 Design Recommendations

1. To assure stability during fire events, cantilever firewalls and their foundations should be designed for the lateral loads specified in Article 4.1.5.17 of the NBCC, as well as the eccentric gravity load effects due to thermal bowing of the wall or thermal frame displacement (secondary effects).
2. Cantilever firewalls must be connected to their foundations, sufficient to resist the overturning moment resulting from the lateral loads and secondary effects noted in Recommendation 1, above.
3. The design strength of the reinforcement, concrete, bond between reinforcement and concrete/grout, and the elastic modulus of the assembly should be determined at elevated temperatures using the assumed temperature of these materials at the fire rating time period. Of particular importance is the affect on the strength of cantilever reinforcement (Table 5A.3, and *References 10 and 18*).
4. Clearance should be provided between the steel framing and the firewall in accordance with Table 5A.2, otherwise the framing must be designed to resist the imposed forces caused by frame expansion and bearing.
5. If used as a temporary exterior wall, cantilever firewalls should be tied to the building frame and designed to resist wind and seismic loads as well as the lateral loading requirements noted under Recommendation 1.
6. The use of cantilever firewalls is not recommended at sites where the seismic hazard index, $I_E F_a S_a(0.2)$, is equal to or greater than 0.35.

5A.4.4.3 Tied Firewalls

5A.4.4.3.1 Design Considerations

Tied firewalls derive their lateral stability from the stability inherent in the building frame. The general stability requirements for firewalls of NBCC-10 Article 4.1.5.17 must be respected. There are two basic types of tied firewalls, these being single column line, and double column line.

When located at a single column line, the tied firewall will be tied to, and may totally encapsulate, the aligned steel columns in a steel frame structure. The top of the firewall will be tied to the horizontal steel elements which are located directly over the firewall and span in the same direction (Figure 5A.19).

At a double column line, a tied firewall is located between the two adjacent, parallel lines of steel columns and is entirely external to the framework. Tied firewalls should not be loadbearing. In Figure 5A.15a, the structure on each side of the tied firewall provides lateral support to the firewall. The framework is tied together

Figure 5A.15a: Tied Firewall

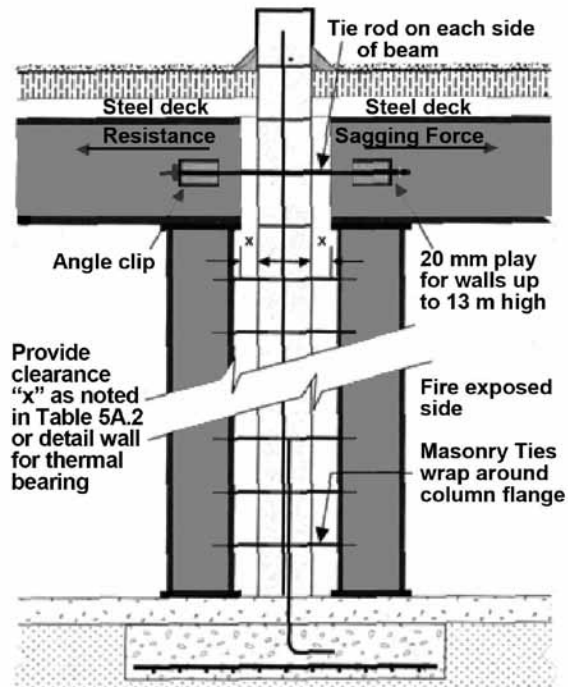

in such a way that lateral forces resulting from collapse of the structure exposed to the fire are adequately resisted by the structural frame of the building on the other side. Flexible masonry anchors (Figure 5A.15b) should be provided for lateral bracing, in addition to the through-wall ties connecting the primary steel. Some free play should be provided between the masonry anchors and the column flange to prevent collapsing steel from pulling on the wall before there is resistance from the unexposed side. To remain stable, the pull of the collapsing steel on the fire side of the wall must be resisted by the strength of the unheated steel frame on the protected side. In a symmetrically framed structure at the building's centre of strength, this will occur naturally.

Figure 5A.15b: Flexible Masonry Anchors

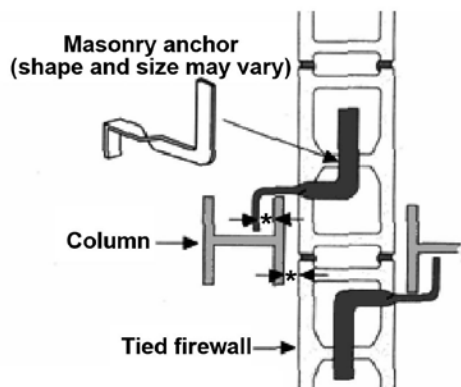

* Maximum space should be 20 mm for walls up to 12.2 m high and an additional 6 mm for every additional 3.0 m of wall height

In small buildings, the centre of strength is generally at the middle of the building (Figure 5A.16a). In larger structures, the centre of strength may lie between two double column expansion joints (Figure 5A.16b)

Figure 5A.16a: Tied Firewall Location in a Small Building

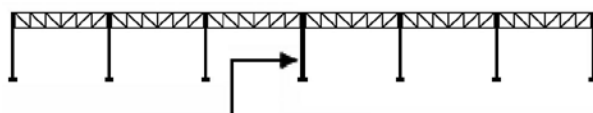
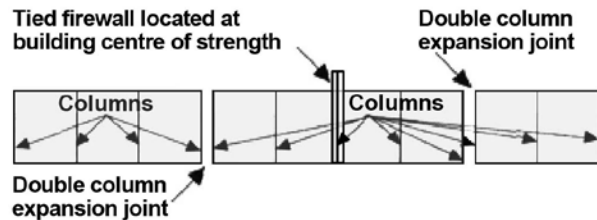

Figure 5A.16b: Tied Firewall Location in a Large Building



5A.4.4.3.2 Horizontal Forces from Collapsing Structure

As a steel frame weakens from exposure to elevated temperatures on the fire side, roof loads cause the supporting steel beams to sag and pull the firewall toward the fire. In Commentary "C", "Structural Integrity of Firewalls" in the "User's Guide—NBC 2010, Structural Commentaries (Part 4 of Division B)", guidance is given to determine the force generated by sagging members on the fire-exposed side of a tied firewall. By treating the sagging beam as a cable subjected to a vertical force per unit length, and using a parabolic approximation to a catenary curve, Paragraphs 16 and 17 of Commentary "C" suggest that the sagging force can be calculated as (Figure 5A.17a and 5A.17b):

$$\text{Sagging Force} = P = wBL^2/(8S)$$

Where

- w = dead weight + 25% of specified snow load
- B = the distance between ties
- L = the span of the collapsing structure between columns measured perpendicular to the wall
- S = sag of the member at its mid-point, assumed be 0.07L for steel open-web beams and 0.09L for steel solid-web members.

The supporting structure should be capable of resisting the recommended forces for ties within a 10 m length of the firewall; the other ties are assumed to carry no force (Figure 5A.17a). The factored resistance of the tie should include a reduction factor of 0.5 to account for reduced yield strength at high temperature. Alternatively, if the building frame possesses equal strength on both sides of the firewall (i.e., the firewall is located at

the centre of strength of the building), only the tie must be designed for the factored force $wBL^2/(8S)$. A load factor of 1.0 is applied to the sagging force because it is an accidental load.

Figure 5A.17a: Calculating Sagging Force for Tied Columns

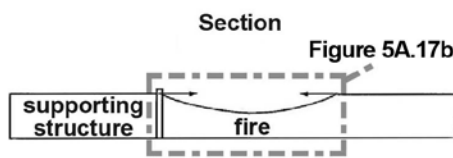
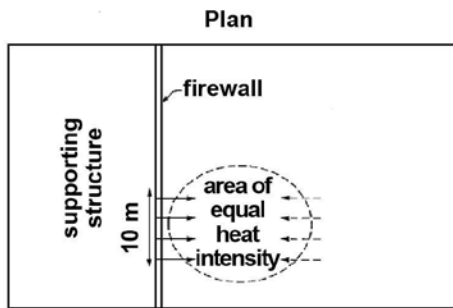
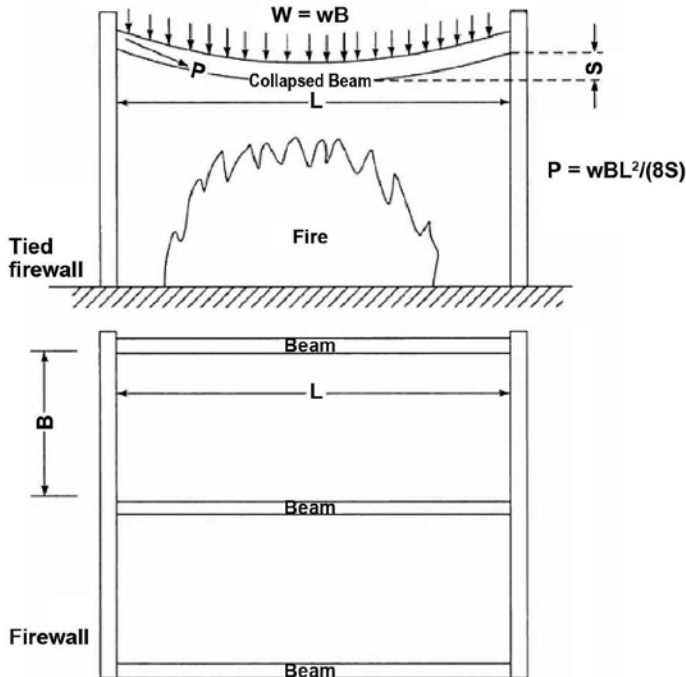

Figure 5A.17b: Calculating Sagging Force for Tied Columns



Tied firewalls derive their lateral stability from the building framework. A premature failure of the steel framing in the immediate vicinity of the firewall would jeopardize both the wall and the tie connection. It is therefore essential that the framing members located within, or immediately adjacent to the firewall not fail. These framing members should be fire protected for the required fire rating period or have adequate fire-resistance to ensure they will not collapse during the fire. The columns and steel framework adjacent to tied firewalls should have a fire-resistance rating at least equal to that of the firewall.

It should be noted that single column line firewalls do not break the continuity of the building frame. Figure 5A.18 illustrates a tied firewall location where additional bracing of the exterior building frame may be needed to accommodate unbalanced sagging forces which may develop during a fire.

Figure 5A.18: Tied Firewall Located Away From Centre of Resistance

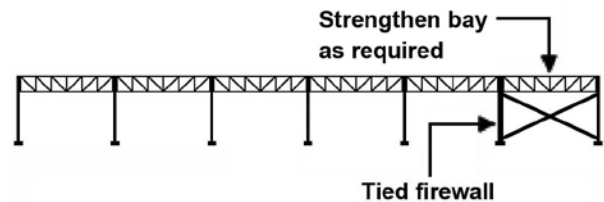

In situations where tied firewalls encase the structural framework, as shown in Figure 5A.19, it is imperative that the encasement of the framework be properly constructed to ensure that the fire-resistance rating of the firewall is provided. An inadequate level of fire protection would cause a premature failure of the firewall. To meet NBCC-10 requirements, framing members running parallel to, and above the firewall must also be encased. Design of this encasement will depend upon the framing layout selected for the building. A clearance of 20 mm between the steel frame and the encasing firewall is needed to accommodate normal building movements.

Figure 5A.19: Tied Firewall Encasing Steel Columns

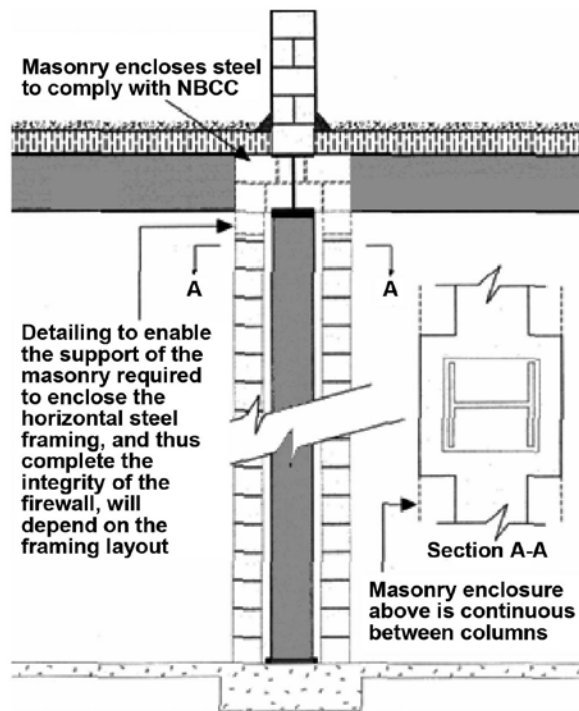

5A.4.4.3.3 Design Recommendations

1. A tied firewall should follow a column line to take advantage of the resistance offered by the columns and to minimize twisting forces on the wall. For tied firewalls located at single column lines, both the columns and roof framing members in line with the wall must have a fire-resistance rating, obtained by the masonry, equal to that of the wall. Where the wall is located between columns on a double column line, the columns and beams or trusses parallel to the wall immediately on each side should have a fire-resistance rating at least equal to that of the wall to prevent the steel from buckling and damaging the integrity of the firewall. This generally implies fire protection of the steel.
2. The framing members should be aligned vertically and horizontally on each side of the tied firewall.
3. Where the steel frames on both sides of the tied firewall are not of equivalent strength, the weaker

side must be designed to accommodate the forces calculated in accordance with Paragraph 16 of Commentary "C", "Structural Integrity of Firewalls" in the "User's Guide—NBC 2010, Structural Commentaries (Part 4 of Division B)", as well as those of NBCC-10 Article 4.1.5.17.

4. At roof level, the expected horizontal force should be transmitted through the wall with continuous steel framing (for single column line tied walls), or by through-wall ties (for double column line tied walls).
5. Where the wall is constructed between double column lines, the ties should be designed based on the forces calculated in accordance with Paragraph 16 of Commentary "C", "Structural Integrity of Firewalls" in the "User's Guide—NBC 2010, Structural Commentaries (Part 4 of Division B)". Two tie rods per column should be used to reduce torsion on the columns. The ties should be connected to the roof framing steel over the columns. Where the primary steel is parallel to the wall, it may be necessary to install ties more often than every column line. For walls up to 13 m high, 20 mm of free play should be maintained in the through-wall ties to accommodate normal building movement, as illustrated in Figure 5A.20. This dimension should be increased by 6 mm for each additional 3 m of wall height.

In addition to using through-wall connections to make the framing steel continuous across the firewall, flexible masonry anchors (Figure 5A.15b) should be provided for lateral bracing. And similar to the requirements for the through-wall ties, free play between the masonry anchors and the column flange should be provided to prevent collapsing steel from pulling on the wall before there is resistance from the unexposed side

6. To accommodate initial steel expansion during the fire, clearance between the steel framing and a double column line tied firewall should be provided in accordance with Table 5A.2.

An alternative approach would be to allow the firewall to act as a bearing pad between the expand-

ing frame and the unexposed frame. This can be achieved by using solid wall sections, as illustrated in Figures 5A.8 and 5A.9.

7. Where tied firewalls encase steel columns, expansion of the steel framing members on the fire side of the wall will be resisted by the framing on the unexposed side of the wall. The connection of the columns to the wall should allow for movements which would occur in the protected frame when resisting the sagging force exerted by the fire-exposed frame. This can be achieved by using flexible masonry anchors or by using concrete block units that loosely key into the re-entrant space of the column.
8. In all cases, the firewall itself must be designed to withstand the lateral loads specified in NBCC-10 Article 4.1.5.17.

Figure 5A.20: Through-Wall Tie, Primary Steel Perpendicular to Tied Firewall

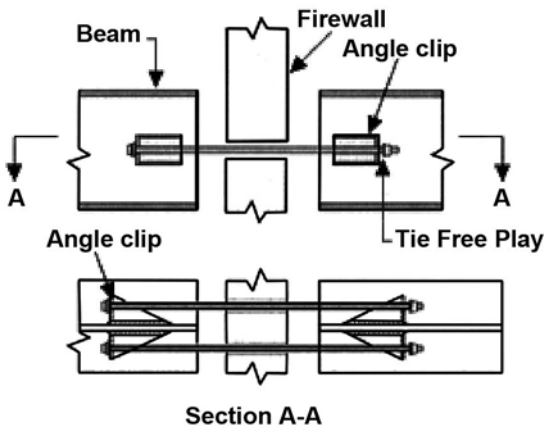

5A.4.4.4 Weak Link Tied Firewalls

5A.4.4.4.1 Design Considerations

By using weak link tied firewalls, structural components are supported by the firewall in such a way that the failing structure may collapse without damaging the integrity of the firewall. Weak link connections are used with tied firewalls where the wall is braced with wood construction, as illustrated in Figure 5A.21. The blocking connection to the wood frame must be detailed to

act as a weak link in accordance with Paragraph 15 of Commentary “C” of “User’s Guide—NBC 2010, Structural Commentaries (Part 4 of Division B)”. The firewall itself must be reinforced and detailed in accordance with Paragraphs 8, 9, 14 and 15 of Commentary “C”. This form of construction is typically used in wood frame multi-unit residential buildings where firewalls are used to separate dwelling units or building sections.

Figure 5A.21: Weak Link Connection Firewall

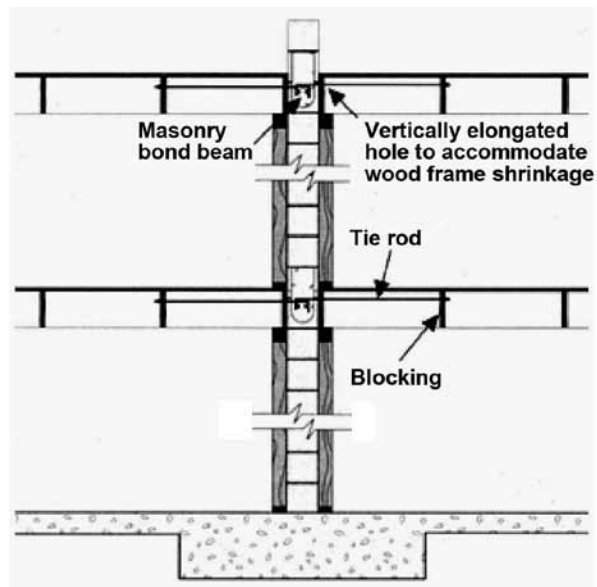

An alternative form of the weak link connection can be used where wood floor joists run perpendicular to, and are supported on, the firewall. The ends of the joist should be fire cut as shown in Figure 5A.22. This will enable the floor framing exposed to the fire to disengage from its bearing connection on the firewall without pulling the wall down. A minimum thickness necessary to maintain the required fire-resistance rating of the wall must be provided at the joist bearing locations as indicated in Figure 5A.23

Figure 5A.22: Thickness Required at Framed-in Members; Fire Cutting Wood Joists

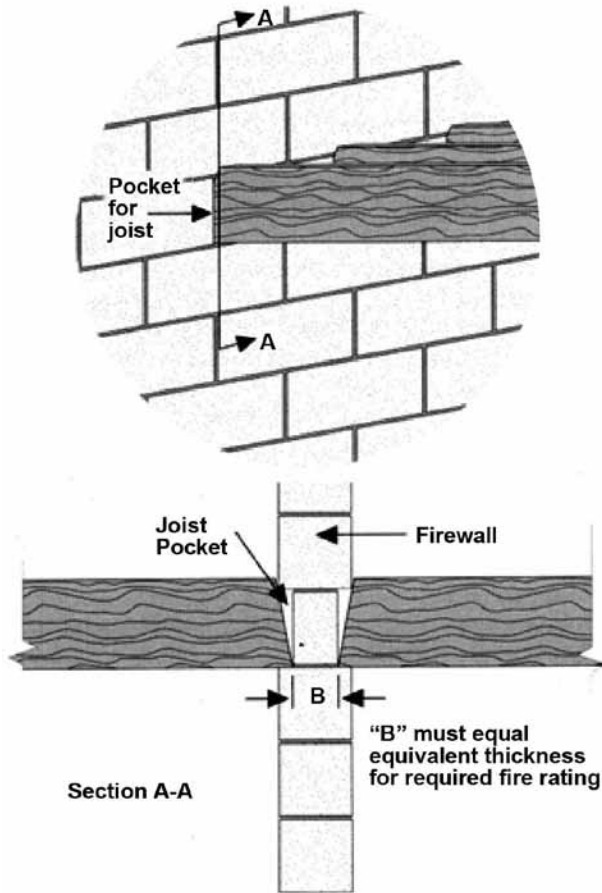

5A.5 Continuity and Terminations

5A.5.1 General

The basic function of a firewall is to prevent the horizontal spread of fire from one area of a building to a neighbouring area. The firewall must completely separate the two areas. To do so, in most cases, it must extend from the foundation through all storeys of the building and through the roof to form a parapet (Articles 3.1.10.3 and 3.1.10.4, NBCC-10).

5A.5.2 Continuity

A firewall must remain in one vertical plane throughout its height. Prior to 1977, the NBCC permitted firewalls to

be offset from storey to storey provided the fire separation was continuous bottom to top. This provision was dropped from the 1977 NBCC. Thus, if offsetting of a firewall is desired, a designer must demonstrate to the Authority Having Jurisdiction that the proposed design meets the objectives of the NBCC, as permitted by "alternative solutions" in Division A. Any structural framing supporting a firewall or a portion of it must be noncombustible and have a fire-resistance rating not less than that of the firewall. The framing must remain in place and support the wall for the length of time of the firewall's fire rating.

Figure 5A.23: Permitted Fire-Resistance Reduction

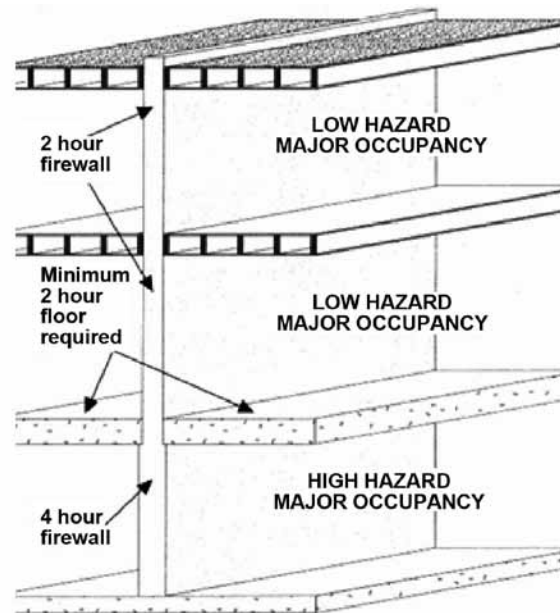

Where different floors in a multi-storey building contain occupancies with different fire hazard levels, a firewall may not be required to have the same fire-resistance rating throughout its height [3.1.10.2.(1), NBCC-10]. For example, if the first storey of a building contains high hazard occupancies, a firewall through that storey would require a 4 hr. fire-resistance rating. And although the firewall must extend through all other storeys of the building, where the upper storeys contain only low hazard occupancies, the fire-resistance rating of the firewall

through those storeys may be reduced to 2 hours. The fire-resistance rating of the floor between the high and low hazard occupancies, which must have at least a 2 hour rating, combined with the 2 hour firewall in the upper storeys, provides the required 4 hours between high and low hazard occupancies on opposite sides of the firewall (Figure 5A.23).

Where the high hazard occupancy is located above the lesser hazard, the fire-resistance rating of the entire firewall must be at least 4 hours because the supporting firewall or structural frame must have a fire-resistance rating at least equal to the firewall it supports [3.1.10.1.(3), NBCC-10].

5A.5.3 Termination Over Parking Garages

Because of the durability and inherent fire-resistance of concrete construction used for parking garages, and because other fire protection measures must be applied in basement parking garages, there is an exception to having the base of the firewall begin at the foundation. Provided the floor assembly immediately above the parking garage is a fire separation constructed of reinforced concrete having not less than a 2 hour fire-resistance rating, the base of the firewall may terminate on top of that floor [3.1.10.3.(1), NBCC-10]. The floor acts as a horizontal extension of the firewall (Figure 5A.5). If, however, the firewall is required to have a 4 hour rating, its supporting structure must also have a fire-resistance rating of 4 hours.

5A.5.4 Termination at Underside of Roof Slab

Where a building on both sides of the firewall has a reinforced concrete roof with not less than $\frac{1}{2}$ the fire-resistance rating required of the firewall (1 hour for a 2 hour wall, 2 hour for a 4 hour wall), the firewall is permitted to terminate at the underside of the roof slab [3.1.10.3.(2), NBCC-10]. The fire rated concrete slab prevents the fire from spreading over the firewall to the adjacent building area. The roof slab immediately above the firewall must not have any concealed spaces crossing the firewall because they may provide a path for fire to spread over the firewall. Also, the joint between the

wall and the roof slab must be properly fire stopped to prohibit the passage of smoke and flame.

Using a fire-rated concrete slab also permits combustible roofing material to extend across the firewall location. A loadbearing cantilever firewall should be considered for use in this situation to ensure that a collapsing roof slab does not cause the wall to fail (Figure 5A.24).

Figure 5A.24: Termination at Concrete Roof

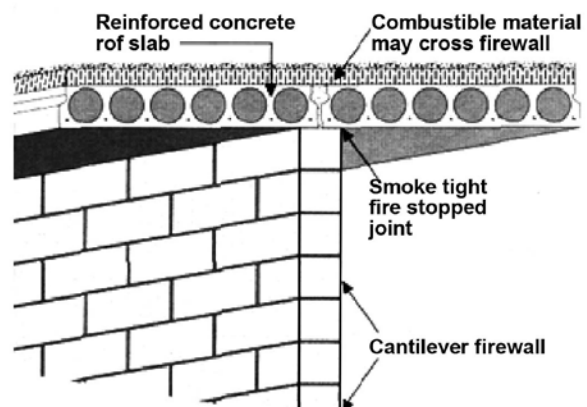

5A.5.4 Parapets

Parapets are considered to be an extension of a firewall above the roof line. As with any other part of the firewall, combustible materials may not pass through, over, or around the parapet. Its height is dependent on the expected fire severity, which is related to the fire load of the occupancy. Where the fire hazard is low and only a 2 hour fire-resistance rated wall is required, the NBCC permits the parapet height to be as little as 150 mm [3.1.10.4.(1), NBCC-10]. For a 4 hour firewall, the parapet must be at least 900 mm above the roof [3.1.10.4.(1), NBCC-10]. These parapet heights are considered by the NBCC to be adequate to prevent the ignition of combustible roof elements by wind-driven flames or radiant heat, although greater heights are recommended particularly for 2 hour firewalls (Figures 5A.25a and 5A.25b).

Figure 5A.25a: Parapet for 2 Hour Firewall

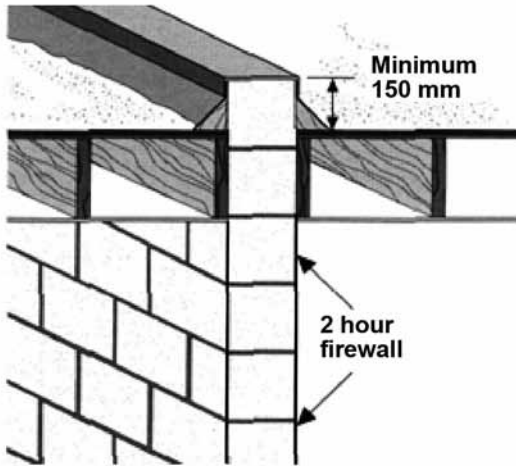
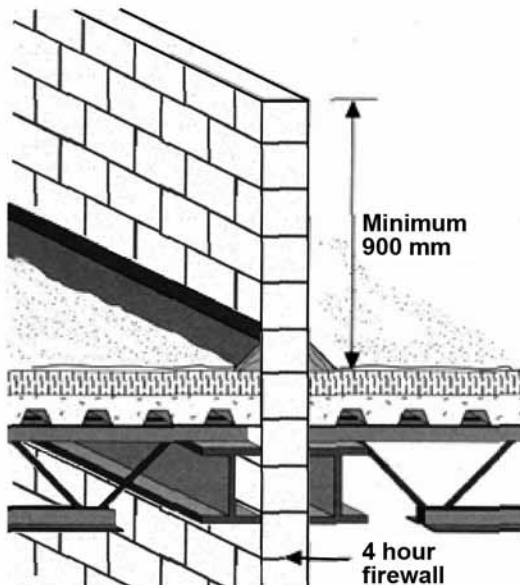
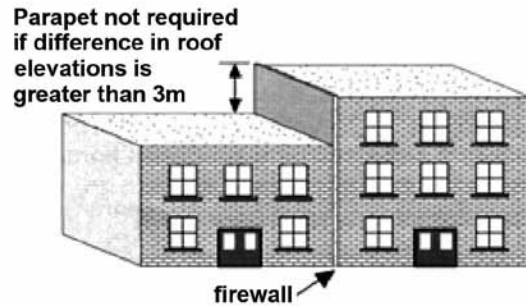

Figure 5A.25b: Parapet for 4 Hour Firewall



Where the two building areas separated by a firewall having different roof elevations, the firewall must extend above the upper roof surface and form the required parapet. However, if the difference in roof elevations is greater than 3 m, this is considered to be of sufficient height, and a parapet is not needed on the higher building [3.1.10.4.(2), NBCC-10]. The use of a double firewall is not recommended in this case (Figure 5A.26).

Figure 5A.26: Firewall at Differing Roof Elevations



5A.5.6 Horizontal Extensions

A firewall must be designed so that fire will not pass through it or around its perimeter. Like the top of a firewall and the need for parapets, the ends should also extend beyond all combustibles. Although not specifically required by the NBCC, an extension of the firewall beyond the outer surface of a combustible exterior wall of 750 mm or greater is recommended, particularly for 4 hr. firewalls. This projection will help prevent flames jumping around, or radiant heat passing by, the firewall (Figure 5A.27a). The use of masonry exterior walls without combustible exterior finishes will eliminate the need for extensions.

Figure 5A.27a: Firewall Extension at Combustible Wall

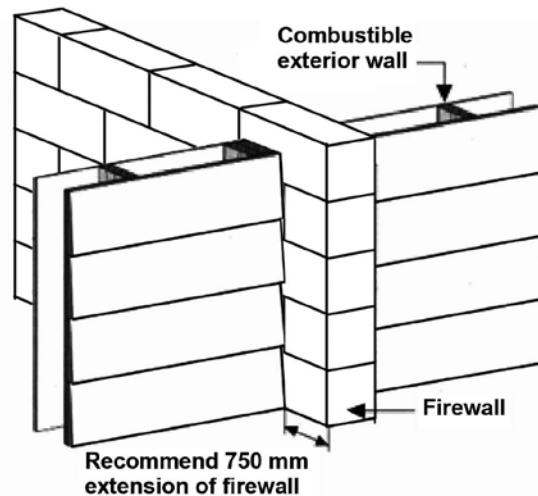

Where a firewall abuts against a noncombustible exterior wall and does not extend through the exterior wall, the joint between the two walls must be smoke tight (Figure 5A.27b). Where the exterior wall construction is combustible, and has a noncombustible exterior cladding such as concrete masonry veneer, the firewall must extend through to the noncombustible exterior layer [3.1.10.7(1), NBCC-10]. A smoke tight joint is also required here (Figure 5A.27c). Where combustible projections such as eaves are not properly separated (subsequently discussed in 5A.5.7), a firewall must also extend beyond those projections. An extension of 150 mm is recommended (Figure 5A.27d).

Figure 5A.27b: Firewall Abutting Masonry Wall

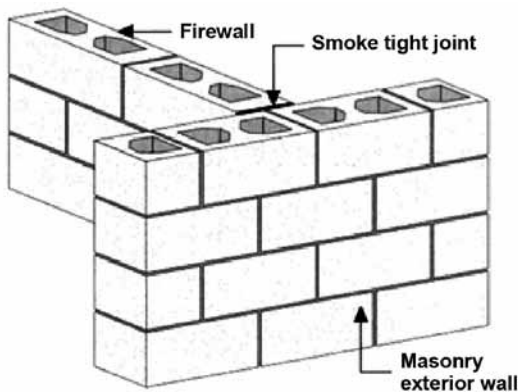

Figure 5A.27c: Firewall Abutting Masonry Veneer

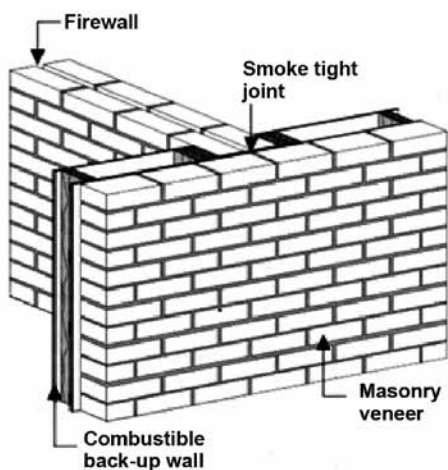
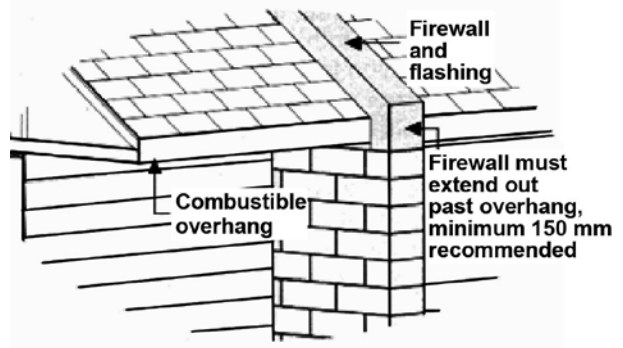

Figure 5A.27d: Firewall Extension Past Eave



5A.5.7 Combustible Projections

Combustible projections such as balconies, platforms, stairs and eaves that are located near a firewall can also be ignited by flames or heat that pass around the end of a firewall. Therefore, combustible projections are not permitted within 2.4 m of similar combustible projections, or window or door openings, placed on the opposite side of the firewall. This distance should provide adequate separation to prevent ignition of combustibles [3.1.10.7.(2), NBCC-10] (Figure 5A.28).

Figure 5A.28: Combustible Projections

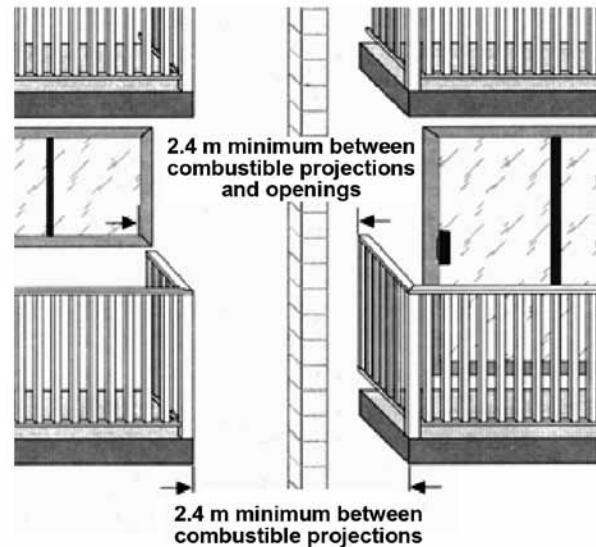

5A.5.8 Exposure Protection

Where the exterior walls of a building adjacent to a firewall are not both perpendicular to the firewall, there may be potential for the fire spread by flame or radiation across the firewall. Where such exterior walls are at an external angle less than 135°, the exterior walls must be constructed with a fire-resistance rating equal to that of the firewall, and without any openings, within a minimum calculated distance of the firewall [3.1.10.7.(2) and Article 3.2.3.14, NBCC-10]. Figure 5A.29 illustrates this situation, using the equation required by Sentence 3.2.3.14.(1) of NBCC-10.

Figure 5A.29: Exposure Protection Example

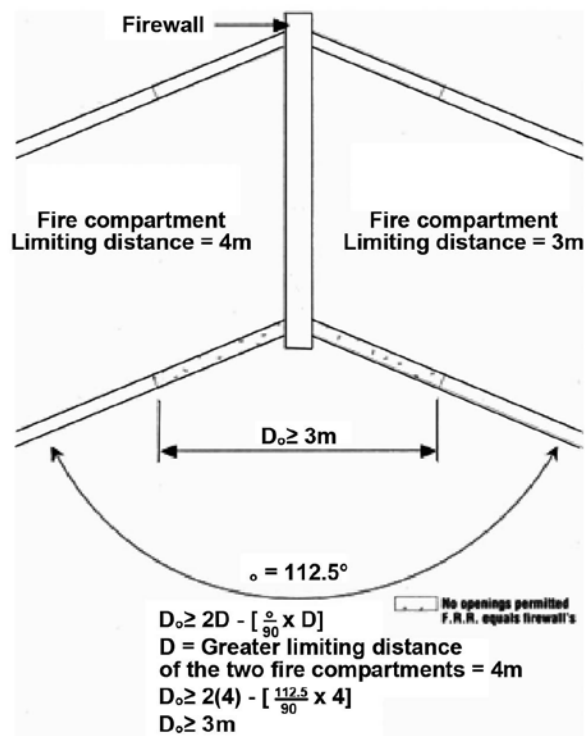

5A.6 Openings and Penetrations/ Closures and Fire Stopping

A firewall, being a fire separation having a fire-resistance rating, must provide a continuous barrier to the spread of fire, and thus, it must be constructed

as a continuous element [3.1.8.1.(1), NBCC-10]. The ultimate firewall, and one that would be the most reliable in performing this intended function, would have no openings or penetrations. However, this is oftentimes not practicable. And regardless of its fire-resistance rating, no firewall will reliably protect against fire spread if unprotected openings, or poorly maintained openings exist, or penetrations are not suitably sealed.

In order for the firewall to provide the required continuity, large openings such as a door or window must be equipped with a closure, and discontinuities and penetrations must be fire stopped.

5A.6.1 Closures

A closure is a device or assembly for closing an opening through a fire separation such as a door, a shutter, wired glass or glass block, including all of the necessary hardware for the device or assembly. Openings in firewalls must be fire-protected by closures. The fire-protection rating of a closure is the time in minutes or hours that a closure will withstand the passage of flame when exposed to fire under specified conditions of test and performance criteria prescribed by the NBCC. A series of extensive requirements for closures are provided in Subsection 3.1.8 of NBCC-10.

Notwithstanding these minimum fire-protection ratings required by the NBCC for approved closures, openings are the weak points in firewalls. A closure in a firewall requires a fire-protection rating of not less than about $\frac{3}{4}$ of the required fire-resistance rating of the firewall into which it is included (Table 5A.4). Justification for this reduction is based on the premise that closures are not

Table 5A.4: Required Fire-Protection Rating for Closures (Adapted from Table 3.1.8.4, NBCC-10)

Fire Resistance Rating of Fire Separation	Minimum Fire-Protection Rating of Closure
45 min	45 min
1 hr	45 min
1.5 hr	1 hr
2 hr	1.5 hr
3 hr	2 hr
4 hr	3 hr

structural elements, and that the ratio of closure area to firewall area is quite limited.

For double firewalls, two closures would be required for each opening, one in each wythe of the wall, with each having half the total required fire-protection rating. For fire dampers, a slip joint should be provided between the dampers.

The NBCC recognizes that closures often rely on fusible links or electronically operated devices to close them during the fire event, which may delay or cause failure of continuity of the fire separation. Thus, although openings in firewalls are protected in the same manner as for other fire separations, there are limits on the aggregate width of firewall openings. As with a fire separation, where a compartment on either side of the firewall is unsprinklered, any one opening in the wall may not be more than 11 m² in area or have a width or height greater than 3.7 m [3.1.8.6.(1), NBCC-10]. However, if both compartments are sprinklered, the maximum area may be doubled to 22 m², and the width or height may be as much as 6 m [3.1.8.6.(2), NBCC-10]. Additionally, the combined width of all openings cannot exceed 25% of a firewall's length [3.1.10.5.(1), NBCC-10] (Table 5A.5).

Table 5A.5: NBCC-10 Maximum Permitted Openings

Protected Opening	Maximum Permitted Dimensions	
	Unsprinklered	Sprinklered
Height	3.7 m	6.0 m
Width ⁽¹⁾	3.7 m	6.0 m
Area	11.0 m ⁽²⁾	22.0 m ⁽²⁾

Notes: (1) The sum of the widths of all openings shall not be greater than one-quarter the width of the firewall.
(2) Buildings on each side of the firewall must be sprinklered.

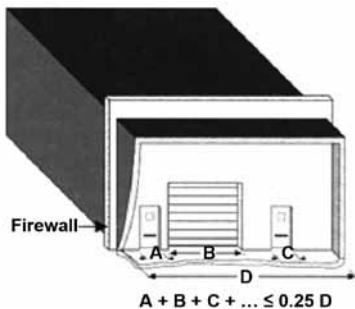

Wired glass and glass block masonry are not approved closures for firewall openings [3.1.8.14.(1), and Table 3.1.8.15, NBCC-10]. Wired glass is also prohibited in doors in 4 hr. firewalls, but may be used in doors in 2 hr. firewalls provided the area of wired glass is not more than 645 cm² (Table 3.1.8.15). A door placed in a firewall must comply with maximum temperature rise limits stated in Article 3.1.8.15. These restrictions are due to the critical nature of firewalls and the possible unreliability of such closures.

5A.6.2 Penetrations and Joints

Requirements for service penetrations and joints in fire-rated assemblies are discussed in detail in Section 5.6 of Chapter 5. Pertinent requirements for both fire separations and firewalls are identified therein.

Specific to firewalls:

1. Items penetrating a firewall require a fire stop system, and unlike fire separations, service penetrations through firewalls cannot be sealed by casting-in-place [3.1.9.1.(1), NBCC-10].
2. Penetrant fire stop systems for firewalls require an hourly "FT rating" not less than the required fire-resistance rating of the firewall [3.1.9.1.(2), NBCC-10].
3. Joint fire stop systems for firewalls must provide an hourly FT-rating not less than the fire-resistance rating for the firewall.

In addition to the above, pipes, ducts, totally enclosed noncombustible raceways or other similar service equipment permitted to penetrate a firewall must also be designed so that they will not cause the wall to fail if they collapse [3.1.10.1.(4), NBCC-10]. There are several methods which may be used to accomplish this, for example:

1. Pass raceways, pipes, ducts and other service equipment through the wall at or near the floor. Generally, the recommended height is no more than 1 m above finished floor level. The lower area of a wall is subjected to less heat and is more stable so damage is less likely to occur.



2. Loosely coil (loop) the cables for cable trays right above the floor level on each side of the firewall to prevent them from pulling on the wall during a collapse of part of the building.
3. Where possible, piping, cable trays, conduits, and cables should be passed over, under or around firewalls, rather than through them.
4. For cable trays and ducts, install slip joints on each side of the firewall, as near to the face of the wall as possible, so they can detach from the wall without exerting force on it during a collapse.
5. Feed sprinkler systems on either side of the firewall to avoid penetration of the wall.

5A.7 Firewalls of other than Masonry or Concrete

The 1995 National Building Code of Canada (NBCC-95) prescribed that all firewalls be constructed of masonry or concrete regardless of their required fire-resistance rating. Requirements for fire performance, structural integrity, and durability of firewalls were thereby explicit and implicit, and compliance was comparatively simple to demonstrate. The needed properties and performance of a firewall were assured by the inherent properties, characteristics and behaviours of traditional masonry and concrete systems designed and constructed in accordance with their respective, consensus-based CSA standards.

In marked contrast, and in a radical departure from NBCC-95, the Objective-Based 2005 NBCC introduced requirements that permit a firewall having a fire-resistance rating of not more than 2-hr. to be constructed of non-combustible materials other than concrete or masonry [3.1.10.2.(4), NBCC-05]. This has provided opportunity for the marketing of alternative, proprietary firewalls such as those offered by the gypsum industry. On occasion, the substitution of a masonry firewall with an alternative construction might be considered by an owner, developer, or builder for a perceived construction first-cost benefit. When considering this substitution, caution, prudence and diligence by the structural engineer and other design professionals are essential

to avoid specifying and constructing an alternative wall assembly that simply cannot perform the intended functions of a firewall.

Upon closer examination, the new objective-based requirements for 2-hr. firewalls, also permitted in NBCC-10 [3.1.10.2.(4)], are readily found to be deficient because they do not identify all of the required attributes of a firewall needed to ensure its intended function, acceptable minimum and quantified levels of performance for each function, and means to specify the levels of performance, or appropriately define means to determine compliance. These deficiencies are identified and discussed in detail in Section 5A.7, herein.

Note that NBCC-10 requires firewalls having a fire-resistance rating greater than 2 hrs. to be constructed of masonry or concrete. This has not changed from the 1995 edition of the NBCC.

5A.7.1 Compliance with NBCC-10; 2-hr. Firewalls of Other Than Masonry/Concrete

5A.7.1.1 Attributes of a Firewall, Performance, and Verification

The NBCC-95 requirements for firewalls are entirely prescriptive in nature, and code compliance is therefore readily discernable. In contrast, the NBCC-10 requirements for 2-hr. firewalls of other than masonry/concrete are entirely objective-based, and whereas the mandatory requirements of Sentence 3.1.10.2.(4) and Appendix Note A-3.1.10.2.(4) provide objectives as a basis for evaluating solutions, there are obvious deficiencies:

1. They identify only "fire-resistance rating" (endurance), "protection against damage", and overall structural stability (by cross-reference to Article 4.1.5.17) as the essential attributes (or functional requirements) of firewall construction. They do not identify other essential properties, characteristics or attributes needed by firewalls to perform satisfactorily including, but not limited to:
 - structural serviceability (movements and deformation)
 - structural and fire resistance to direct/localized



impact from collapsing members and falling construction debris or other objects during a fire event;

- resistance to hose stream for full fire duration;
- resistance to renovation;
- duplicity of construction in the field;
- residual post-test strength; and,
- durability (see subsequent discussion, herein).

These are unstated or unidentified attributes inherent in masonry firewall construction prescribed by the NBCC-95. When a firewall is called upon to stop a spreading fire that is reaching or has attained conflagration proportions, and if it is to serve its purpose, it must have attributes far in excess of the two attributes required by NBCC-10, 3.1.10.2.(4) (a) and (b).

2. They do not make mandatory or identify any test(s), either field or laboratory, to establish a measure of performance related to:
 - “protection against damage”;
 - other properties, characteristics or attributes needed by firewalls to perform satisfactorily.
3. They do not make mandatory or identify any minimum levels of performance related to:
 - “protection against damage”;
 - other properties, characteristics or attributes needed by firewalls to perform satisfactorily.
4. Although they do caution the user by way of appendix note that:

“...for the purposes of determining the overall performance of the assembly, it is also necessary to determine by test whether the failure of the damage protection component during a fire affects the performance of the fire-resistive component...”

they do not provide quantitative criteria or verification methods, that is, useable guidance to building officials or to designers on testing or minimum level of performance related to this attribute to exercise judgment and to determine if the objective “protec-

tion against damage” has been met.

5. They do not reference good-practice documents, or more importantly, do not reference related consensus standards or consensus documents.

In summary, with respect to a user’s ability to establish compliance for 2-hr. firewalls of other than masonry/concrete construction, the stated requirements in NBCC-10 do not satisfactorily:

- identify (all) the required attributes of a firewall;
- determine acceptable minimum levels of performance;
- identify means to specify the levels of performance;
- define means to determine compliance;

and, consequently, the NBCC-10 requirements for firewalls of other than masonry/concrete are discretionary and not verifiable.

5A.7.1.2 “Durability”, and “On-Going Performance” of a Firewall

There is an inherent “resistance” to the use of the term “durability” within the National Building Code of Canada. Notwithstanding, the Canadian Commission on Building and Fire Codes (CCBFC) acknowledges that “durability” is a legitimate issue to address, but only to the extent that it is related to the achievement of the codes’ objectives, and that durability is not an objective for its own sake. An illustrative example provided in a CCBFC document titled, *“Appendix A, Objectives Addressed by the National Building Code”*, states:

“For example, given that one objective of the National Building Code is safety, the intent of many durability-related requirements is to discourage deterioration of the building’s safety features at an unacceptable rate. Therefore these requirements would be linked to the objective of safety.”

Because “firewalls” are fire safety features (“fire safety” being a sub-objective to the objective of “safety”), the issue of “durability” is applicable to them. Rationally, firewalls:

- must be resistant to any mechanisms of deterioration, without maintenance, throughout the



design service life of the building, in readiness to satisfactorily perform their intended functions during a fire; and,

- must be resistant to any mechanisms of deterioration during a fire for a stated minimum period of time.

The CCBFC also acknowledges that *“durability is a factor appropriate for codes, provided...any requirements are clear, explicit and enforceable at the time of construction.”* (*Possible Measures to Implement the Strategic Plan of the CCBFC*, 1996)

Requirements for the “on-going performance” of firewalls are implicit in the prescriptive requirements of NBCC-95, which demand construction of only masonry or concrete; they are neither implicit nor explicit in the NBCC-10 for alternative firewalls having a fire-resistance rating of 2 hr. or less.

NBCC-10 permits 2-hr. firewalls to be constructed of other than masonry or concrete by way of objective-based requirements, but it does not in any manner identify “durability” or “on-going performance” as requirements or objectives.

Although Part 5 of the NBCC-10 contains requirements for *“compatibility”* and *“resistance to any mechanisms of deterioration which would be reasonably expected”*, these requirements apply only to *“materials that comprise building components and assemblies that separate dissimilar environments”* and firewalls do not necessarily serve this function; moreover, such requirements in Part 5 do not pertain to issues of fire safety.

“One important aspect of enforceable durability requirements is that the criteria used to define the required performance must be clearly stated and conformance to those criteria must be easily determined at the time of construction. Inability to assess and verify conformance in advance of putting the building into use will result in an inoperable regulation that will shift the burden to the legal system.” (*The National Building Code: Durability Requirements and their Incorporation into an Objective-Based Structure*, Chown and Oleszkiewicz, 1997)

In summary, the NBCC-10 requirements permit the construction of firewalls other than of masonry/concrete that are not required to satisfy any stated or implied criteria for *“on-going performance”*.

5A.7.1.3 Technical Requirements for Firewalls, NBCC-10

5A.7.1.3.1 Use of Duplicate Specimen to Provide Fire-Resistance Rating, and Testing to Establish Performance and Evaluate a Firewall

Article 3.1.7.1 of NBCC-10 references CAN/ULC-S101 for the determination of fire-resistance ratings of assemblies, wherein, a duplicate test specimen may be used (if needed) to satisfy resistance to the hose stream test. Use of a duplicate specimen to achieve a stated fire-resistance rating is common for assemblies not of masonry or concrete, for example, gypsum board assemblies. Where a duplicate specimen is used, it is exposed to the effects of the hose stream immediately after being subjected to a fire endurance test for a time period of one-half the fire endurance classification period determined from the fire endurance test on the original specimen. Stated alternatively, a duplicate specimen is exposed to a hose stream after 1 hour when the original specimen is subjected to fire for a 2 hr. period; if it sustains the hose stream, the assembly is given a 2 hr. fire-resistance rating.

Masonry assemblies do not require a duplicate specimen to pass the hose stream test. The fire-resistance rating for masonry assemblies is limited by temperature rise on its unexposed face and not by impact/shock due to hose stream. Hence, the behaviour of a masonry/concrete firewall under the standardized test is radically different from other wall types that achieve the same fire-resistance rating using the duplicate specimen compliance path of the standardized test. For additional discussion, see 5.3.2.2.3 *Significance, Use, and Limitations of ULC-S101 (ASTM E 119)*. For additional discussion about the standardized fire test and use of the duplicate specimen, see 5.3.2 of this Guide.

As a general comment about all “standardized tests”, such tests compare materials or assemblies under a



given set of conditions which may not represent all conditions under which they are used. Each standardized fire test has some sort of explanatory paragraph in the scope. For example in ASTM E 119, *Standard Test Methods for Fire Tests of Building Construction and Materials*, Sec 1.3 qualifies: “This standard ... does not by itself incorporate all factors required for fire hazard or fire risk assessment of the materials, products or assemblies under actual fire conditions.”

There exists no standard to test and evaluate the performance of a “firewall”, and to differentiate and evaluate the performance of such a wall from a wall having a “fire-resistance” rating. Previous to the NBCC-10, the performance of firewalls could be relied upon in the field because they were prescribed to be constructed of masonry/concrete which inherently offer properties and behaviours under field or test fire conditions that can differ markedly from other walls that receive a fire-resistance rating using a test that (simply) measures fire-resistance rating. And moreover, in the specific cases of ULC-S101 and ASTM E 119, two profoundly different compliance paths can be used to establish hose stream performance, hence two distinct levels of durability performance are included, and the relative fire performance of different wall assemblies becomes somewhat of an optional measurement.

The intent of Article 3.1.7.1, NBCC-10, is not clear. Rationally, firewalls should not rely on a duplicate specimen to pass the hose stream test to receive its fire-resistance rating. If it is not the intent of Article 3.1.7.1 to prohibit the use of a duplicate specimen to establish the fire-resistance rating for a firewall, then effectively, the NBCC-10 permits a 2-hr. firewall constructed of other than masonry/concrete to be penetrated by a standard hose-stream after 1-hr., and this is indeed contrary to the performance needed to maintain integrity throughout full exposure (non-compliance with Sentence 2, Commentary “C”, “*Structural Integrity of Firewalls*” in the “*User’s Guide—NBC 2010, Structural Commentaries (Part 4 of Division B)*”).

5A.7.1.3.2 Structural Integrity

The term “integrity” is used in Sentences 3.1.10.1.(1), and 3.1.10.2.(4)(a) of NBCC-10. Although the term “integrity” is not defined by the NBCC-10, in the context of these Sentences and with reference to Commentary “C”, “*Structural Integrity of Firewalls*” in the “*User’s Guide—NBC 2010, Structural Commentaries (Part 4 of Division B)*”, “integrity” implies that the firewall must be designed structurally so “that the fire not spread between compartments separated by a firewall within the required fire-resistance rating for the wall”, and further, “...to achieve this, the wall must not be damaged to the extent that it allows fire spread during this time”. Commentary C further identifies and describes:

- that collapse of the firewall due to explosion, glancing blows from falling debris, force and thermal shock of fire-hose stream and wind pressure can be prevented by designing the system to resist a factored live load of 0.5 kPa (for a firewall located on the building interior);
- that the firewall be designed to resist “normal structural requirements” for interior walls for wind and earthquake, including that for pounding damage;
- that the firewall resist the loads and the effects of loads caused by thermal expansion that would cause damage and allow premature fire spread through the wall; and,
- that the firewall be designed for “structural integrity” in accordance with Part 4 Commentary B.

Part 4 Commentary B, “*Structural Integrity*” describes “structural integrity” as “*the ability of the structure to absorb local failure without wide-spread collapse*”.

Thus, for firewalls, the Part 4 commentary suggests that requirements for “integrity” may be satisfied by a design that:

- resists a factored uniformly distributed live load of 0.5 kPa (interior loading);
- resists normal structural loads otherwise required by Part 4;



- does not collapse (wide-spread, not local) during the fire;
- accommodates thermal effects of a fire event; and,
- resists “pounding”.

In review of this,

- The NBCC-10 uses a 0.5 kPa uniformly distributed load imposed on the firewall to model forces due to explosion, glancing blows from falling debris, impact and thermal shock of a fire-hose stream, all of which are point loads.
- The NBCC-10 does not clarify if the resistance by the wall system to the 0.5 kPa load is determined on the assembly at the time of construction, or, if the resistance must be established using those properties/characteristics/behaviour of the assembly resulting from exposure to the fire (although concrete and masonry firewalls are designed as such).
- In some manner, the firewall must resist “pounding”; “pounding” is neither defined nor described by the NBCC-10...it is not quantified...and no standard test is referenced.
- The text in Commentary C-10 remains unchanged from Commentary M-95. Part 4, NBCC-10, assumes that local penetration of the firewall under fire conditions may not lead to widespread collapse, or otherwise, it assumes that there exists an inherent resistance to local penetration by the wall system, and this assumption has shown to be correct where the firewall is constructed of masonry/concrete. It cannot be assumed, and should be demonstrated where the firewall is constructed of other than masonry/concrete.

In light of these observations, the NBCC-10 can be seen as deficient in its structural requirements for 2-hr. firewalls constructed of other than masonry/concrete, in that:

- The NBCC-10 does not appropriately address requirements for point loading incident upon a

firewall during a fire event, needed to ensure that firewall integrity for walls constructed of other than masonry/concrete is maintained throughout the required fire rated time.

- By way of imposing a uniformly distributed load as a means to assess point loading caused by fire events, the NBCC-10 is misleading, with the attendant risk that a firewall constructed of other than masonry/concrete may indeed not be designed to resist point loading and consequently may not maintain its integrity during the fire for the required time of exposure.
- In the move to objective-based codes, and by NBCC-10 acceptance of firewalls constructed of other than masonry/concrete, the structural design requirements in the NBCC-10 do not acknowledge that the resistance to a point loading inherently offered by masonry/concrete systems during fire, inherently may not be offered by alternative systems.

As such, where this inherent resistance can be relied upon by the designer when using prescriptive requirements (Division B, Acceptable Solutions), it cannot be relied upon and may be absent from alternative systems designed and constructed under the objective-based requirements (Division A).

- Because the NBCC-10, by way of ULC-S101, permits assignment of fire-resistance rating using a duplicate specimen, there is a high risk that a 2-hr. firewall designed and constructed under the objective-based requirements will not maintain its integrity throughout its intended 2-hr. duration.

The requirements related to firewall integrity within the NBCC-10 are unclear and contradictory. Consequently, firewalls of other than masonry/concrete cannot be fully rationally designed for structural integrity using the current requirements of NBCC-10.



5A.7.1.2 Consequences of NBCC-10

5A.7.1.2.1 General

The objective-based path of the NBCC-10 does not fully and clearly identify all of the required attributes of a firewall, acceptable minimum (quantified) levels of performance, means to specify the levels of performance, means to measure, or means to verify compliance. In a strict and real sense, a rational engineering approach to, and verifying compliance of, an alternative solution to 2-hr. firewalls of masonry/concrete is prohibitive because the technical requirements in the Code are incomplete, not clear, and contradictory or absent. And, presently, in the absence of the intelligence needed to undertake a rational design, Building Officials should be compelled to scrutinize and challenge the design process, testing standards, performance baselines, and all design and construction criteria used by any designer or purveyor of a proprietary firewall system to “demonstrate” compliance of an alternative firewall design.

Unfortunately, with this confusion comes some likelihood that assemblies that cannot perform will be constructed and substituted for firewalls of masonry and concrete for a perceived construction first-cost benefit.

Firewalls of masonry and concrete are proven to perform effectively in the field, are forgiving to deficiencies in design and construction, do not require unusual or non-standard construction practices, are inherently resistant to nearly all mechanisms of deterioration occurring in-service both before and during the fire, and are easily duplicated. Using the requirements of NBCC-10, compliance is readily verifiable where the firewalls are designed and constructed of masonry.

5A.7.1.2.2 Ontario Building Code, and Alternative Firewalls

Despite the strong commitment by all provinces to integrate the national and provincial code development systems and harmoniously adopt NBCC requirements for the provincial building codes, the Ontario Building Development Branch chose to move unilaterally and to amend the NBCC-10 on the issue of 2-hr. firewalls constructed of other than masonry/concrete.

The Ontario Building Code does *not* permit 2-hr. firewalls (and “less”) to be constructed of other than masonry or concrete where they separate buildings or buildings with floor areas having care or detention occupancies, or where they are used in “high buildings”. Therein, is an inherent acknowledgement that 2-hr. firewalls of other than masonry/concrete likely will not offer the same level of fire performance. Additionally, where permitted for other Uses such as for party walls, the OBC requires the level of performance of such alternative firewalls to be not less than that of masonry or concrete in areas of performance during fire conditions, mechanical damage during the normal use of the building, and resistance to damage from moisture.

The OBC requirements maintain an objective-base and are intended to provide assurances that designers, builders, and purveyors of systems alternative to masonry or concrete firewalls must clearly demonstrate, by way of standardized tests and comparison, that such firewalls offer equivalency to masonry/concrete firewalls in all areas of fire performance and related structural performance.

Despite these improvements, the current OBC conspicuously omits a comprehensive list of the functions of firewalls, and the design considerations for each function which must be addressed to demonstrate equivalency to masonry/concrete firewalls and ensure firewall performance. To demonstrate equivalency, areas for consideration must include all of the essential properties, characteristics and attributes needed by firewalls to perform satisfactorily, including those not specifically stated and unidentified by the NBCC-10 and OBC, and inherent in masonry/concrete construction prescribed by the NBCC-95 and OBC-97. Such areas would include, but are not necessarily limited to: resistance to renovation and abuse; duplicity of construction in the field; durability and on-going performance (alternatively stated, resistance to mechanisms of deterioration without maintenance throughout the design service life of the building, in readiness to satisfactorily perform their intended functions during a fire); determination of fire-resistance rating (in its most simple form, requir-



ing resistance to hose-stream after full duration of fire test rather than half-duration as is commonly reported for gypsum systems); structural and fire resistance to direct/localized impact during fire from collapsing members, falling construction debris or other objects, and to explosion; and overall and local structural integrity and serviceability at elevated temperatures.

5A.7.1.2.3 Alberta Building Code, and Alternative Firewalls

Unlike the OBC, the Alberta Building Code adopted the NBCC-05 requirements without change. However, the Alberta Building Technical Council, responsible for the technical content of the Alberta Building Code, identified a concern and need to clarify and interpret the NBCC-05 for both designers and building officials. In February, 2008, the ABTC released STANDATA 06-BCI-005-R1, titled, "Two Hour Firewalls" (<http://municipalaffairs.gov.ab.ca/documents/ss/STANDATA/building/bci/06BCI005.pdf>)

The STANDATA identifies a number of changes and clarifications to the requirements in the ABC/NBCC-10, including, but not limited to: (a) modifying the ULC-S101 fire test to eliminate the use of duplicate specimens; (b) stating the need to evaluate the damage protection features using the resistance of masonry and concrete as the basis for acceptance, and (c) clearly identifying the design professional as the individual responsible for ensuring that evaluations have been performed.

5A.8 Masonry Firewalls vs. Masonry Fire Separations

There are substantive differences between requirements for masonry firewalls and masonry fire separations within NBCC-10 because these walls perform markedly different functions. Yet, there are many similarities. Their differences are summarized as follows:

Fire-Resistance Rating:

1. The required fire-resistance rating of a firewall must be provided by masonry or concrete only. The inclusion of cell material other than grout/concrete or

mortar cannot contribute to the fire-resistance rating of a masonry firewall whether all cells are filled or not.

Structural:

1. A firewall must have structural stability, sufficient to remain intact under fire conditions for the required fire-rated time. Consequently:
 1. a firewall must be designed to resist the "maximum effect" resulting from otherwise normal loading conditions prescribed by Part 4, or a minimum factored lateral load of 0.5 kPa under fire conditions;
 2. the connections and supports of framing members must be detailed such that the collapse of the framing members will not cause a premature failure of the firewall;
 3. pipes, ducts, totally enclosed noncombustible raceways or other similar service equipment which penetrate a firewall must be designed so that they will not cause the wall to fail if they collapse.

Openings/Closures:

1. Openings in firewalls are protected in the same manner as for fire separations. A closure requires a fire-protection rating of not less than about $\frac{3}{4}$ of the required fire-resistance rating of the wall into which it is included (Table 5A.4).
2. There are limits on the aggregate width of firewall openings:
 1. where a compartment on either side of the firewall is unsprinklered, any one opening may not be more than 11 m² in area or have a width or height greater than 3.7 m;
 2. if both compartments are sprinklered, the maximum area may be doubled to 22 m², and the width or height may be as much as 6 m;
 3. the combined width of all openings cannot exceed 25% of a firewall's length.
3. Wired glass and glass block masonry cannot be used for firewall openings.



4. Wired glass is prohibited in doors in 4 hr. firewalls, but may be used in doors in 2 hr. firewalls provided the area of wired glass is not more than 645 cm².
5. A door placed in a firewall must comply with maximum temperature rise limits.

Penetrations:

1. Unlike fire separations, service penetrations through firewalls cannot be sealed by casting-in-place.
2. Penetrant and joint fire stop systems require an FT-rating for firewalls, and an F-rating for fire separation walls.
3. The required hourly ratings for fire stop systems must be not less than that shown in Table 5.6 of this Manual.

Parapets and Extensions:

1. The primary purpose of a firewall is to divide a building into separate building areas. Consequently, a firewall must provide vertical continuity, and in most cases, a firewall must extend from the foundation through all storeys of the building and through the roof to form a parapet. Additionally, to provide horizontal continuity, an extension of the firewall beyond the outer surface of a combustible exterior wall is recommended, particularly for 4 hr. firewalls.

5A.9 Summary

This Manual explains the provisions within the NBCC-10 for firewalls, and specifically, pertinent to masonry firewalls. The key points can be summarized as follows:

1. The required fire-resistance rating for masonry firewalls must be obtained using masonry (or concrete) materials and assemblies only. Conventional Type N and Type S mortars, in accordance with CSA A179-04, "Mortar and Grout for Unit Masonry", are suitable for the construction of masonry firewalls. NBCC-10 does not assign or limit fire-resistance ratings of concrete masonry based upon bond pattern (running and stack). Therefore, the determination of the fire-resistance rating of concrete masonry is independent of bond pattern.

2. The function of a firewall is to effectively contain the anticipated fire for the time it takes the fire on one side of the firewall to burn itself out.
3. Building areas divided by firewalls are considered separate buildings for structural fire protection purposes.
4. The number of firewalls needed in a building is generally governed by height and area restrictions, which are based on occupancy and construction type.
5. The required fire-resistance rating of a firewall depends on the occupancy of the building: high hazard occupancy requires a 4-hr. rating, other occupancies require a 2-hr. rating.
6. All openings in firewalls must be protected by appropriate fire-rated assemblies.
7. A firewall designed in accordance with the appropriate provisions of the NBCC may be used to support adjoining construction assemblies.
8. A firewall may terminate at the underside of a properly fire-rated concrete roof but must extend through any other roof and form a parapet.
9. A firewall need not extend below a reinforced concrete floor above a parking garage.
10. A firewall must extend through all combustible materials placed in exterior walls, and beyond using suitable length of projections, but is permitted to terminate at the inside face of a noncombustible wall or a noncombustible cladding.
11. The principal difference between a firewall and a fire separation having a fire-resistance rating is its superior fire-resistance and its ability to withstand the collapse of construction on either side of the wall without collapse of the firewall itself.
12. Firewalls having a fire-resistance rating greater than 2-hr. must be constructed of masonry or concrete. Firewalls having a fire-resistance rating of not more than 2 hr. may be constructed of other than masonry or concrete, however, the related objective-based



technical requirements within the NBCC-10 intended to ensure fire performance are incomplete, not clear, contradictory or absent. Consequently, there is a risk that a 2-hr. firewall designed and constructed under these requirements will not perform as expected during the rating period. Designers and Building Officials should be well-aware of the deficiencies of the objective-based firewall requirements of the NBCC-10 where the respective provincial building code is based on this model.

5A.10 References

1. Balanced Design Fire Protection, TEK 7-2. National Concrete Masonry Association. Herndon, VA, 2008.
2. G.E. Brandow, G.E. Chukwuma, G.C. Hart. 2006 Design of Reinforced Masonry Structures. Concrete Masonry Association of California and Nevada, 2007.
3. C. Beall. Masonry Design and Detailing for Architects, Engineers, and Builders. 2nd Ed. McGraw-Hill, 1987.
4. Best Practice Guide on Fire Stops and Fire Blocks and Their Impact on Sound Transmission. National Research Council of Canada. NRCC-49677. Ottawa, ON, 2007.
5. Code Requirements for Determining fire Resistance of concrete and Masonry Construction Assemblies, ACI 216.1 / TMS-0216-07. American Concrete Institute. Farmington Hills, MI, 2007.
6. Concrete Masonry Fire Resistance. Northwest Concrete Masonry Association. Lynwood, WA, 2005.
7. Criteria for Maximum Foreseeable Loss Firewalls and Space Separation. Property Loss Prevention Data Sheet 1-22. Factory Mutual Insurance Company, 2000.
8. Design Manual, Precast and Prestressed Concrete. Canadian Precast/Prestressed Concrete Institute. 4th Ed., Ottawa, ON, 2009.
9. R.G. Drysdale and A.A. Hamid. Masonry Structures Behaviour and Design. Canadian Edition. Canada Masonry Design Centre, 2005.
10. The Effect of Elevated Temperature on Concrete Materials and Structures-A Literature Review. Oak Ridge National Laboratory. Oak Ridge, TN, 2006.
11. Fire Resistance Ratings of Concrete Masonry Assemblies, TEK 7-1C. National Concrete Masonry Association. Herndon, VA, 2009.
12. Firestopping & Effective Compartmentation Strategies. K. Brebner, M. McClure, B. McHugh.
13. Firewalls: A Design Guide. Canadian Concrete and Masonry Codes Council. Ottawa, ON, 1992.
14. Fire Stopping and Penetration Seals for the Construction Industry. Association for Specialist Fire Protection, Fire Test Study Group. 2nd ed., 2004.
15. Fire Stopping Service Penetrations in Buildings. City of Calgary., Calgary, AB, 2003.
16. Guidelines for Calculated Fire Resistance Using Non-Listed Aggregates. National Concrete Masonry Association. National Concrete Masonry Association. Herndon, VA, 2009.
17. Guidelines for Determining Fire Resistance Ratings of Building Elements. Building Officials & Code Administrators International, Inc. Country Club Hills, IL, 2001.
18. Gustaferro, A.H. and Martin, L.D., Design for Fire Resistance of Precast Prestressed Concrete. Prestressed Concrete Institute, Chicago, Ill., MNL-124-89, 1989.
19. Increasing the Fire Resistance of Concrete Masonry, TEK 7-4. National Concrete Masonry Association. Herndon, VA, 2001.
20. W.C. Panarese, S.H. Kosmatka, F.A. Randall. Concrete Masonry Handbook for Architects, Engineers, Builders. Portland Cement Association. 5th Ed., Skokie, IL, 2005.
21. R.R. Schneider, W.L. Dickey. Reinforced Masonry Design. 2nd Ed. Englewood Cliffs, NJ: Prentice-Hall, Inc., 1987.
22. Steel Column Fire Protection, TEK 7-6A. National Concrete Masonry Association. Herndon, VA, 2001.
23. User's Guide—NBC 2010, Structural Commentaries (Part 4 of Division B). Commentary C, Structural Integrity of Firewalls.