

MIT EECS CONNECTOR

Annual News from the MIT Department of Electrical Engineering and Computer Science





the MIT EECS Connector

**SPRING
2015**

Perspectives from the Department Head : 1

Features : 3

- 50-40-30-20-10 Milestones in EECS : **4 - 12**
- MAC50: CSAIL10 Celebrating 50 Years of Computer Science and Artificial Intelligence at MIT : **4**
- 40th Anniversary of EECS : **7**
- MTL Celebrates its 30th : **10**
- 20th Anniversary of the EECS MEng Degree : **12**
- Initiatives in EECS : **13 - 24**
- SuperUROP in its Third Year : **13**
- USAGE: Four Years of Contributions to EECS : **17**
- EECScon paired with Masterworks puts EECS student research on the map : **19**
- Start6: Building the Innovation Community : **20**
- Postdoc6 comes full cycle : **22**
- Rising Stars in EECS: Sharing a Common Goal : **24**

Lab Features : 25

- CSAIL: Minimizing Data Movement in Multicore Systems, *Daniel Sanchez* : **26**
- CSAIL: Computation Obscura, *Vinod Vaikuntanathan* : **28**
- LIDS: Systemic Risk and Networks, *Asuman Ozdaglar* : **30**
- MTL: Towards Terahertz Integrated Systems on Chip, *Ruonan Han* : **32**
- RLE: Next Generation Video Coding, *Vivienne Sze* : **34**

Faculty Features : 36

- Awards, Fellowships, Chairs : **37, 41, 42**
- New Faculty : **44**
- Leadership : **47**
- In Remembrance : **50**

Education Updates : 52

- 6.170 focuses on software design : **53**
- 6.035: Winning a semester-long contest : **55**
- 6.UAT gives engineers tools to convey ideas : **57**
- Extraordinary Educators in EECS : **59**
- Tours in EECS : **61**

Staff Features : 63

- Kathleen McCoy, Bill Tilden, Myung-Hee Vabulas : **63**

Alumni Features/Awards : 67

- Ashar Aziz, '81 : **68**
- Robert Blumofe PhD '95 : **70**
- Vanu Bose '87, SM '94, PhD '99 : **72**
- Cynthia Breazeal SM '93, ScD '00 : **74**
- Mike Evans '99, MEng '00 : **76**
- Yoky Matsuoka 'SM '95, PhD '98 : **78**
- Jaime Teevan PhD '07 : **80**

Donor Recognition : 83

Research Snapshots : inside back cover

Anantha P. Chandrakasan
Department Head

Silvio Micali
Associate Department Head

David J. Perreault
Associate Department Head

CONTACT
the MIT EECS Connector
Room 38-401
77 Massachusetts Avenue
Cambridge, MA 02139
newsletter@eecs.mit.edu

Editor: Patricia A. Sampson
Design: Subbiah Design
Printer: Artco, Inc.

www.eecs.mit.edu

Front cover images: 1: EECS Undergraduate students gain a new dedicated space — The EECS Undergraduate Student Lounge — thanks to the work of USAGE. See Department Initiatives, page 17. 2: Over 100 SuperUROP students presented their research to guests, including Desh Deshpande, at the December Research Review, page 13. 3: Start6 day 1 featured a panel including from left, Sophie Vandebroek, Xerox CTO; EMC Co-founder Roger Marino; Erika Angle, Founder and Executive Chairman of the Board, Counterpoint Health Solutions; Bernard Gordon, father of high-speed analog to digital conversion; and Vanu Bose, President, CEO, Vanu, Inc. See page 20. 4: Arun Saigal '13, MEng '13 talked about startup employment for Start6 students, See page 20. 5: Start6 included a reception for Women in Innovation. See page 20. 6: Prof. Anantha Chandrakasan with (from left) Marina Hatsopoulos, entrepreneur, director and angel investor, Erika Angle, Founder & Executive Chairman of the Board, Counterpoint Health Solutions, and keynote speaker Cynthia Breazeal, SM '93, ScD '00, Founder of and Chief Scientist at her company Jibo, Inc.



Perspectives from the Department Head



Welcome to the 2015 MIT EECS Connector — an opportunity to share the milestones attained this past year in research, education and innovation in the Electrical Engineering and Computer Science Department at MIT. The department's continued global eminence in education and research is made possible and enhanced by the dedication and hard work of its faculty, students and staff, and the generous and ongoing support of its alumni and friends.

The department has launched a number of initiatives that enhance the experiences of students, faculty, staff and alumni. These initiatives are becoming more widely known across the Institute and beyond. SuperUROP, Rising Stars, Start6, EECScon, Postdoc6 and USAGE are all made possible through the engagement of our department members, and are based on the 2012 Strategic Plan and its subsequent elaboration.

In its third year, the SuperUROP, a year-long advanced research experience for undergraduates in EECS, has attracted over 100 students — more than ever. Likewise, our base of companies committed to supporting these students, and sharing in a growing research network with the SuperUROP students and their faculty advisors, continues to expand (see page 13).

As the SuperUROP has grown, so has the interest and commitment of our undergraduate juniors and seniors to an extended research experience. This is reflected in the growth of EECScon, the undergraduate research conference held each spring in a professional conference setting. Each year we are pleased to see more interest from industry members, who come to engage these students in informal research discussions at the poster session. We look forward to EECSCon 2015. EECScon

is now traditionally followed by Masterworks, a similar presentation of research by our master's degree students (see page 19).

Interest in Start6 hit a new high as we opened up participation in this IAP workshop for entrepreneurs and innovators to the entire Institute. The cross-campus mix of students and postdocs from around 15 departments created a new energy as Sloan, School of Science and engineering disciplines and cultures mixed in the common core of startups. Sparked by panels and talks by 50 successful entrepreneurs and leaders in the VC field, participants learned not only the nuts and bolts of startups but also how to navigate the channels towards building a startup project. The energy and positive feedback generated by this two-week class has helped to establish Start6 as a fixture in the new innovation culture at the Institute (with some participants claiming that Start6 can teach entrepreneurship in two weeks! — see page 20). The momentum of Start6 continues to build into the following term, with a startup competition followed during Spring break with a trip for some of the class participants to San Francisco and Palo Alto startups and VC firms.

Rising Stars, the program that is helping to build the pipeline to academic careers for talented women graduate students and postdocs in electrical engineering and computer science, met this past year at UC Berkeley after its successful launch at MIT in 2012 and the repeat at MIT in 2013. This shared hosting and the continued successful placement of Rising Stars participants in academic posts at major universities and research institutes is encouraging a growing number of women in academics (see page 24).

Perspectives from the Department Head

Based on feedback by the Visiting Committee in 2013, the EECS Department initiated a community-building effort for postdocs from its affiliated labs. The new group, now called Postdoc6, was formally launched with a daylong workshop in January 2014 to address some of the common goals and issues voiced in earlier feedback sessions. Since then, with the goal of building a supportive community for EECS postdocs, Postdoc6 has grown with regular gatherings for networking and information (see page 22).

Other initiatives, which continue to play tremendous roles in the ongoing and important work of keeping EECS vibrant and responsive for its students, include the Undergraduate Student Advisory Group in EECS (USAGE, a standing committee created in Fall 2011), and the Student Search group, which includes both graduate and undergraduate students who provide input to our faculty search process. As a direct result of the work of USAGE last year, a new Undergraduate Student Lounge where EECS undergraduates can study, network and meet was opened in fall 2014. The work of USAGE this year is deeply important to understanding and addressing workload balance, and their input on the new undergraduate curriculum is providing crucial feedback to our faculty curriculum committee (see page 17).

Several anniversaries involving members of our department have either been celebrated or are noted in this edition of the Connector. The Computer Science and Artificial Intelligence Lab (CSAIL) held a symposium in May 2014 to mark the 50th anniversary of Project MAC, MIT's response to the need for connected computing in the 1960s, which subsequently played a leading role in the tremendous digital revolution that has changed all of our lives. Forty years ago the MIT Electrical Engineering Department made the decision to update its identity to include Computer Science — in the process becoming one of the few combined EECS departments anywhere (see page 7). The Microsystems Technology Laboratories (MTL) celebrated its 30th anniversary in late October 2014. Several of MTL's former leaders, including President L. Rafael Reif and President Emeritus Paul Gray, provided history and context, while keynote speakers and panelists showed how MTL continues to be an intellectual home for a wide range of research disciplines as well as a world class laboratory, producing work that has provided the stimulus for MIT's new nanotechnology center. And, at 20 years, the department's Master of Engineering Degree, the "MEng," is celebrated for its growth and appeal to generations of EECS students. (See pages 4 - 12.)

This year has marked the transition and advancement of members of the department leadership, including Associate Department Head Bill Freeman now succeeded by Silvio Micali, and co-Education Officers Saman Amarasinghe and Jacob White now succeeded by Hae-Seung (Harry) Lee and Rob Miller. The tremendous service to the department by Professors Freeman, Amarasinghe and White are noted in this edition (see page 47).



We celebrate the continued recognition of Institute Professor Mildred Dresselhaus's pioneering and varied accomplishments. She was presented last year with the country's highest civilian award, the Presidential Medal of Freedom, and also named by the IEEE for its highest award — the IEEE Medal of Honor. She is the first woman to receive this IEEE award (see page 40).

We note with profound sadness the loss this past summer of a beloved faculty member in his prime. An expert in computer vision and a gifted visionary in robotics and human-robot interaction, Seth Teller had forged the path at MIT and beyond to enable machines to become aware of their surroundings and interact naturally with people in healthcare, military, civilian, and disaster-relief settings. We deeply miss his engaging presence (see page 50).

For this edition, we are delighted to feature several alumni who are leaders in their fields and who share with us their thoughts on their work, including how their experiences in EECS at MIT helped guide and shape this work. Please read about them on pages 67 - 81.

We are always eager to engage our alumni in exploring ways for them to share their expertise with current students in classes or the department's numerous initiatives. I welcome your input and hope that you will stay in touch directly or through our website and social network sites.

Anantha P. Chandrakasan

Joseph F. and Nancy P. Keithley Professor of
Electrical Engineering

Department Head,
MIT Electrical Engineering and Computer Science

Features

50-40-30-20-10: Milestones in EECS

4 - 12

MAC50 | CSAIL10:
Celebrating 50 Years of
Computer Science & Artificial Intelligence

4

40th anniversary of EECS:
How CS took its place alongside EE

7

Microsystems Technology Laboratories
Celebrates its 30th

10

20th anniversary of the EECS
Masters of Engineering Degree

12

Initiatives in EECS:

13 - 24

Building a Research Community:
SuperUROF in its third year

13

USAGE at four: credited with a growing
list of accomplishments

17

EECScon and Masterworks:
Putting Student Research on the map

19

Start6: Building the Innovation Community

20

Postdoc6 comes full cycle

22

Rising Stars: sharing a common goal

24

50-40-30-20-10: Milestones in EECS



MAC50 | CSAIL10: Celebrating 50 Years of Computer Science & Artificial Intelligence

Courtesy Adam Conner-Simons, MIT CSAIL, and Hiawatha Bray, The Boston Globe

On May 28 and 29, 2014, MIT's Computer Science and Artificial Intelligence Laboratory (CSAIL) commemorated 50 years of computer science research with a one and a half day conference featuring talks by the leading thinkers in the field, including the founders of iRobot, Ethernet, and Google's Boston Dynamics.

In advance of the celebration, CSAIL released a list of "50 Ways that MIT has Transformed Computer Science," five of which are listed on page 6.

"When this [ProjectMAC] started in 1963, the dream was to let multiple people use computers simultaneously, said Daniela Rus, CSAIL director. "Fifty years later we're now in a world where we find computing indispensable."

MIT actually got involved with computing long before the 1960s. In the early 1930s, electrical engineer Vannevar Bush developed a mechanical computer for doing complex math. In 1938, one of Bush's students, mathematician Claude Shannon, showed how to use electric switches to do calculations and transmit information — the basic concept behind digital computing and communications gear.

In the 1950s, MIT was involved with Project Whirlwind, an advanced military computer with features still in use today. Then

in July 1963, the Institute working with DARPA, the Defense Advanced Research Projects Agency, set out to develop a computing system that would allow individuals to access computational power much like accessing electricity in their homes. Project MAC, for Multiple Access Computer and Machine-Aided Cognition, solved the problem with first the Compatible Time-Sharing System (CTSS) and eventually Multics, a forerunner of the operating software that runs on Apple Inc.'s Mac computers, iPhones and iPads. At that time the members of Project MAC also helped establish the Free Software Foundation, which strongly influenced the development of the Unix operating system and laid the foundation for many of today's basic design concepts for software systems.

In the 1970s, Project MAC evolved to become the Laboratory for Computer Science (LCS) and the Artificial Intelligence Laboratory (AI Lab) — paving the way for an enormously productive era of computing research at MIT and laying the foundation of an official academic computer science curriculum at MIT. Out of LCS foundational work developed operating systems, programming languages, distributed systems, and the theory of computation; while out of the AI Lab a wealth of new applications and methods for image-guided surgery and natural-language-based Web access, a new generation of micro displays, haptic interfaces and behavior-based robots were realized.

Over the years the two labs increasingly collaborated and, with the construction of the Stata Center, they merged as the Computer Science and Artificial Intelligence Lab (CSAIL) in 2003. 2014 marks not only the 50th anniversary of Project MAC but also the 10th anniversary of CSAIL's formation.



MAC50 Symposium guests gathered for a group photo. [Jason Dorfman/CSAIL photographer]

As the presenters gathered last spring for MAC50, they discussed their involvement in some of MIT's biggest computing breakthroughs, as well as the areas in which the technologies have not yet reached their full potential. The atmosphere was not just nostalgic but infused with optimism and enthusiasm with talks focusing on issues that could be solved by computing over the next decade.

Tom Leighton, an MIT Professor of applied mathematics and co-founder of Akamai Technologies, spoke about the technical challenges that arise when consumers expect high-quality video and "instant web performance, from any device, anytime."

Bob Metcalfe, co-inventor of Ethernet and a professor at the University of Texas at Austin, talked about his early days at MIT building hardware for Apanet, the precursor to the Internet. "Harvard told me that this sort of work was 'too important' for a graduate student," he told attendees, "so I walked down Broadway to 545 Technology Square, and took a job at MIT." He credited Project MAC as the launch pad of his career saying "I owe it to the excellence of the people who were there."

"I picture a world where it's as easy to operate a driverless car or program a robot to play with your cat as it is to use a smartphone," CSAIL Director Daniela Rus said. She continued, "People thought President Kennedy was crazy when he said we were going to the moon; at CSAIL, we've dreamed up dozens of moonshot goals and then said, 'Let's make them happen.'"

In his opening welcome remarks, MIT President L. Rafael Reif spoke about all of the Institute's areas of research that have been impacted by CSAIL — from aerospace and architecture to genomics and musicology. "Subtract CSAIL," he said, "and you subtract a central part of MIT's intellectual character, many of our most important analytical tools, and a fundamental way that we think about solving problems for society."

Rod Brooks, having graphed out the ProjectMAC/CSAIL line of events based on the symposium's sequence, suggested it as a good news story, but queried "What's missing? Robotics," he suggested. "Robotics hasn't changed the world yet! Why not?" he followed. With the promise of elder care robots to answer the large numbers of people living longer, the biggest need is hardware development, he suggested — for robotic cars, fully mobile robots that can navigate our homes and complex robotic hands to handle everything else.

Project MAC founder Robert Fano, EECS professor emeritus was honored during the evening program with a special "Founder's Award." Fano noted that the culture at the time viewed computing as a passing fad rather than a legitimate academic discipline. "I believed computer science would be an



CSAIL directors, past and present (clockwise from top left): Anant Agarwal, Victor Zue, Ed Fredkin, Robert Fano, Rodney Brooks, Daniela Rus, and Patrick Winston. [Jason Dorfman/CSAIL photographer]

important competence for MIT to develop," he said. "There were a lot of people who didn't agree with me at the time." Other former directors of CSAIL and its predecessors including Anant Agarwal, Ed Fredkin, Patrick Winston, and Victor Zue also attended.

View the MAC50 website: <http://mac50.csail.mit.edu/>

See the videos of the talks: <http://mac50.csail.mit.edu/Talks>

50-40-30-20 -10: Milestones in EECS

COMPUTING THE FUTURE



To commemorate MAC50, a list of 50 ways that MIT has transformed the field of computer science was created. These include achievements or notable technologies that either happened at Project MAC (or LCS, the AI Lab or CSAIL), or were spearheaded by MIT EECS alums or lab researchers. Due to space limitations, below are 5 of the 50. See <http://www.csail.mit.edu/node/2223> for the entire list.

1. The digital computer (1944)

Don't take that MacBook for granted! The first digital computer that could operate in real-time came out of Project Whirlwind, an initiative during World War II in which MIT worked with the U.S. Navy to develop a universal flight simulator. The device's success led to the creation of MIT's Lincoln Laboratory, which helped create the SAGE computer and radar-based air defense system.

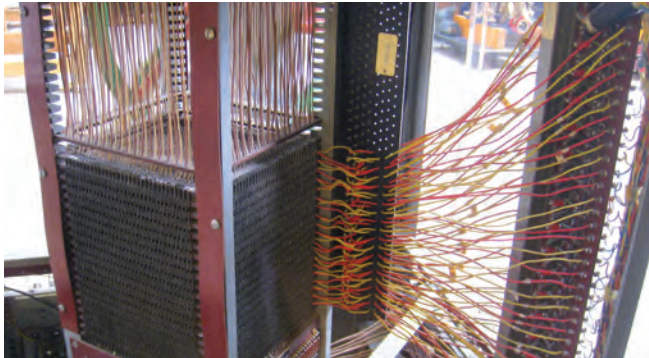

2. The computer password (1963)

The average person types 8 passwords a day - and you can indirectly thank CTSS, which by many accounts represented the first instance of passwords in computing. "We were setting up multiple terminals which were to be used by multiple persons but with each person having his own private set of files," Prof. Fernando Corbató (pictured below) told Wired. "Putting a password on for each individual user as a lock seemed like a very straightforward solution."



3. Graphical user interfaces (1963)

Nearly 50 years before the iPad, an MIT PhD student had already come up with the idea of directly interfacing with a computer screen. Ivan Sutherland's "Sketchpad" allowed users to draw geometric shapes with a touch-pen, pioneering the practice of "computer-assisted drafting" that has proven vital for architects, planners, and now even toddlers.



4. Multics (1964)

MIT researchers helped develop the Multics time-sharing system that was a predecessor to the UNIX operating system and spawned the creation of the "video display terminal," which lets users see the text they're typing on a screen. The system furthered the idea of the computer as a "utility" that can be operated by multiple users separately.

5. Email (1971)

Did you know that the first email to ever travel across a computer network was sent to two computers that were right next to each other? It came from MIT alum Ray Tomlinson of BBN Technologies - he's the one you can credit (or blame) for the @ symbol.



40th Anniversary of EE-CS

40th anniversary of EECS: How CS took its place alongside EE

by Eric Smalley

The EECS Department owes its existence to many small things. Millions of small things, in fact.

In the 1960s, researchers who were developing circuit theory, and those who were writing software, were operating in a new, common paradigm. The ability to connect millions of simple components via simple connection rules can give rise to extraordinarily complex systems. At MIT, those people were in a single department: Electrical Engineering.

The Electrical Engineering Department was founded at the turn of the 20th century to research and develop power systems. In the run up to World War II, the government formed the Radiation Laboratory to carry out the country's radar R&D and housed the lab at MIT. The lab brought together hundreds of scientists and engineers from around the country who gained hands-on experience developing electronic systems and participated in one of the largest multidisciplinary collaborations in history.

Many in the MIT Electrical Engineering department worked at the Radiation Laboratory, and most returned to the department after the war. "That gave them a huge start in the whole process of reorganizing the department in quite a different direction" during the 1950s, said Prof. Emeritus Campbell Searle.



MIT's Building 20, home of the Radiation Laboratory

The reorganization, presaged by the rise of radio and electronics in the 20s and 30s, turned a department founded on turbines and transformers into one also dealing with circuits, signals and information. Central to the new focus was another technology jumpstarted by the war effort: computing. Computers became widespread in business, government and academia by the 1960s, and the practice of designing and programming them evolved into a full-fledged discipline: computer science.

Computer science at MIT gained a formal home with the launch of Project MAC on July 1, 1963. Among the founding organizations was



Prof. (then student) Gerald Sussman operating the PDP-6

the Artificial Intelligence Group, which Profs. John McCarthy and Marvin Minsky launched in 1959. Prof. Gerald Jay Sussman remembers his days as an undergraduate in the early years of Project MAC. He worked with Minsky, who had a single Digital Equipment Corporation PDP-6 computer that Minsky was able to upgrade, at a cost of \$380,000 to a megabyte of RAM. "That was the biggest memory around," Sussman said.

Though paltry by today's standards, those resources allowed the theory and application of computer science to flourish at MIT. Because computer science developed within the electrical engineering department, the two disciplines informed each other.

Programming is about building things from a huge number of simple components, in this case logic operations. "Once you can build things with a million parts, then you've got a different kind of problem, which is how do you organize it?" said Sussman. "So what you learn from computation is very often organizational principles, which then can be used in thinking about physical systems."

Similarly, electronics is about building things from a huge number of components, in this case, circuits. One concept engineers developed to cope with this is abstraction, which became very important in computation, said Sussman. "The idea that you could wrap up something and give it a name, and then that name could be used somewhere else and have a specification, that's very important," he said.

(next page)

40th Anniversary of EE-CS, *continued*

This interrelation between EE and CS became apparent to Prof. (now emeritus) Paul Penfield, Jr., who researched circuit theory and developed one of the first circuit modeling and simulation software programs. “That convinced me that EE and CS were more tightly, strongly, intellectually connected than CS could be with any other discipline that I could imagine,” Penfield said.

Independence movement

By 1970, the EE department had grown to roughly 700 undergraduates, making it by far the largest department at MIT. That year, the Artificial Intelligence Group was spun out of Project MAC to form the Artificial Intelligence (AI) Laboratory. Computer science was a rapidly growing field, which presented the prospect of a department grown too large and unwieldy. Some CS faculty argued that computer science should have its own department with its own curriculum and degree program. “Back then there was a certain amount of tension between Computer Science – people who were in Project MAC – and the rest of the department,” said Prof. Alan Oppenheim. “And the computer science people felt like they were not getting their piece of the pie.”



Before 1970, programmers used card punches to prepare programs to be run by mainframe computers in overnight batches. Timesharing systems like CTSS developed at MIT (see page 6), made computers much easier to use and spurred the growth of CS in the EE department.

Much of the uncertainty about computer science’s future at MIT in the 1960’s and early 70’s stemmed from uncertainty about the discipline itself. Was computer science simply a specialized form of applied mathematics? If so, why was it in an engineering department? Many of the younger CS faculty who supported the move for a separate department had come to MIT from universities where computer science had emerged from the mathematics department.



Technology Square, home of LCS and the AI Lab

The drive to split off computer science from the EE department was fueled in part by the CS faculty’s physical separation. Project MAC and the AI Lab were housed in Technology Square, not near other EE activity. “The people there felt isolated,” said Penfield. “They felt out of touch with a big segment of the population at MIT, and I think they were right.”

Strength in unity

However, not everyone felt that the solution was to make CS a separate department. Many of the more senior CS faculty recognized the institutional benefits of remaining unified, said Prof. Emeritus Fernando Corbató. “There was a feeling that we were a lot smarter to be part of a large complex that already had its ongoing machinery and traditions and maturity, and it would be foolish to be separate,” he said.

The many connections between EE and CS convinced Penfield that the disciplines would develop in each other’s context. “If we split into two, we would introduce an artificial barrier between two intellectual activities which drew so heavily from each other,” he said. “That would be a very costly mistake.”

The faculty whose work crossed the line between EE and CS, like Penfield and Sussman, drove the decision to keep the department unified, said Prof. Emeritus Jerome Saltzer. In addition, a major focus of CS in its early years at MIT was on designing computer hardware, which made it hard to find a bright-line boundary between EE and CS interests, he said.

Some younger faculty who came to MIT from pure CS backgrounds also saw the value of a unified department. “Having one department made it easier for people who are on the boundaries to work with one another,” said Prof. Barbara Liskov. “It’s not so easy if you’re in different departments,” she said.

50-40-30-20-10: Milestones in EECS, *continued*

A key step in addressing the needs of the CS side was the restructuring of the department leadership. In 1972, department head Louis Smullin appointed two associate department heads — Prof. Mildred Dresselhaus for EE and Prof. Robert Fano for CS. This was seen by most faculty as a move in the right direction, but some thought it did not go far enough. In 1973 some CS faculty members urged the creation of separate EE and CS departments. Most department faculty did not favor separate departments, and an overwhelming majority voted in an informal poll conducted by Joel Moses to rename the department EECS. The official renaming took place in 1975 and the urge to create a separate CS department subsided. The leadership structure with two associate department heads was popular, however, and continues to this day.

Renaming the department — the most visible aspect of giving CS equal billing with EE — was the culmination of a lot of work carried out over many years to strengthen CS. Undergraduate education is fundamental to the Institute's mission, and the CS curriculum was a measure of the discipline's maturity and status. Through the mid-1960s, undergraduate computer science education consisted of one beginning computer programming class (6.45/6.47) and two computer system design classes (6.25 and 6.251), said Saltzer.

In 1966, CS faculty members began developing a formal computer science curriculum. They started with a series of three CS subjects: a software course (6.231), a hardware course (6.232), and a systems course (6.233). Between 1968 and 1974 the CS faculty developed a full spectrum of undergraduate CS subjects, including artificial intelligence (6.234), compilers (6.235), discrete mathematics (6.043), computability and complexity (6.045), and two CS laboratory subjects (6.175 and 6.176), said Saltzer. "So by 1974 we were offering a complete undergraduate CS curriculum," he said.

The department took another crucial step in elevating CS within a unified departmental structure. It developed the Common Core requirement that EE students take the first two CS subjects and vice versa. One of the final steps on the road to elevating CS to equal status with EE was renaming Project MAC the Laboratory for Computer Science in 1976.

Because there were multiple facets to the department's restructuring and the process unfolded over several years, the transformation might have seemed evolutionary rather than revolutionary, said Penfield. "Once the name was changed the subsequent reorganization was done in a series of steps that individually may not have seemed critical but when taken as a whole produced deep, fundamental, pervasive changes to the department."

Even as EECS looks back on 40 years, the department is preparing for a future where the physical and the digital are more closely connected. The rise of ubiquitous sensors, the Internet of Things, and the continued colonization of the nano scale and quantum domain are putting a renewed focus on electrical engineering in general and analog systems in particular. "The world is moving more and more to the integration of hardware and software," said Ray Stata, cofounder and chair of Analog Devices and EECS benefactor.

The department can once again play a key role in helping the Institute evolve, said Stata. The unified structure of EECS and the focus on materials research through MIT Nano, puts MIT "in the best position to lead when collaboration across disciplines will become even more important to success," he said.

It is an exciting time as the department expands and strengthens core disciplines while defining new opportunities and creating interdisciplinary programs.

Further Reading:

A Century of Electrical Engineering and Computer Science at MIT, 1882 – 1982

Karl L. Wildes and Nilo A. Lindgren available online (for purchase): <http://books.google.com/books?id=6ZX-GwvhcnkC&pg=PA90&lpg=PA90#v=onepage&q&f=false>

The Electron and the Bit, EECS at MIT 1902 – 2002

John V. Guttag, Editor [a limited supply is available through the MIT EECS headquarters]

MTL Celebrates its 30th Anniversary

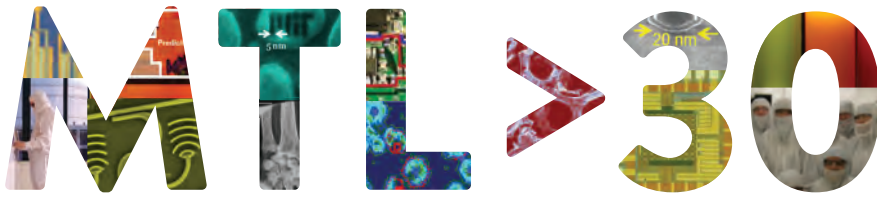

MIT's Microsystems Technology Laboratories Celebrates its 30th Anniversary with a Look Backwards and a Look Forward

by William Holber, Associate Director, MTL

On October 29th and 30th, 2014, MIT's Microsystems Technology Laboratories (MTL) celebrated its 30th anniversary. Over 300 people from a wide variety of institutions attended the banquet on the 29th and the Symposium on the 30th. The event constituted both a look back at MTL's past and a look forward to the bright prospects for nanotechnology and nanosystems at MIT with the coming of MIT.nano, a new nanotechnology facility for the campus.

MTL is an interdepartmental laboratory that supports research across a wide range of disciplines, including circuits and systems, MEMS, electronic, photonic and molecular devices, and nanotechnology. MTL acts both as an intellectual home, where researchers with overlapping interests work together and as a set of shared experimental facilities, providing capabilities not available in any individual researcher's laboratory. Annually, MTL supports the research of about 550 students and staff. More about MTL can be found at <http://www-mtl.mit.edu>.

The MTL>30 Symposium program kicked off on the evening of October 29th with a reception and dinner at the Cambridge Marriott Hotel, next to campus. Opening talks included short remarks by Jesús del Alamo, current MTL Director, and Charles Sodini, the Symposium Organizer. L. Rafael Reif, President of MIT, then spent a few moments reflecting on the history of MTL and his role in it, sharing anecdotes that delighted the audience. The after-dinner speaker was Robert Kahn, Chairman, CEO and President of the Corporation for National Research Initiatives. Dr. Kahn discussed the historical developments that played a crucial role in the advent of modern microsystems.

The main Symposium event took place at MIT's Media Lab on October 30th (photo upper right). The venue was ideal. The speakers and discussion panels were located in the main auditorium, with a high-definition video screen in the reception/poster area for those of us who wanted to chat while listening. At one point a drone with a gyro-stabilized camera made its appearance at the roof deck, leading to much speculation as to its ownership!!



MTL Director Jesús del Alamo opened the MTL 30th Anniversary Symposium introducing senior leaders in the lab. (See text immediately below.)

The positive tone for the day was set by opening remarks from MIT faculty who have had senior leadership roles at both MTL specifically and MIT broadly. These included Jesús del Alamo; Martin Schmidt, MIT Provost and former MTL Director; Paul Gray, Professor Emeritus and President Emeritus of MIT; Paul Penfield, Professor Emeritus of EECS; and Dimitri Antoniadis, Professor of EECS and founding Director of MTL, who participated via video.

This was followed by the Keynote Session, chaired by Charles Sodini. The first keynote talk was given by Ahmad Bahai, CTO of Texas Instruments, and was titled *Pervasive Solid State Electronics – Promises & Challenges*. Dr. Bahai gave us a great perspective on the background and future of modern electronics systems, from his broad academic and industrial experience, which in addition to Texas Instruments includes National Semiconductor, Bell Laboratories, and Algorex, which he co-founded.

The next keynote talk was by Jack Sun, VP of Research and Development and CTO of Taiwan Semiconductor Manufacturing Company. The talk, *Collaborative Semiconductor Innovation – The Next Frontiers*, gave us a look at the various semiconductor innovations that will be necessary to propel the nano-micro-electronics industry into the next decade of growth. This particularly includes 3D transistor, interconnect and packaging technologies. Prior to joining TSMC, Dr. Sun held a number of senior management and engineering positions at IBM.

50-40-30-20-10: Milestones in EECS, *continued*

After a short break, there was a panel discussion on Education for the Future of Nanotechnology / Nanosystems Students, moderated by Thomas Lee, Professor of Electrical Engineering at Stanford and MIT alumnus. Those in the audience who attended the MTL MARC 2014 conference in January of 2014 recalled among themselves the fascinating talk that Prof. Lee gave at that meeting. This panel discussion was equally engaging. The panel was composed of five well-established MIT / MTL alumni representing academia, industry, and national laboratories: Mark Allen, Professor at University of Pennsylvania; Kush Gulati, Maxim Integrated; Craig Keast, MIT Lincoln Laboratory; Martin Schlecht, SynQor; and David White, Cadence. The discussion was centered on the future of the modern research university, with advice for today's students.

Next, a set of graduate students did a great job giving short 'pitches' for their research. This was followed by a lunch buffet combined with a poster session where students presented their work, which in some cases included live demos (See photo right). The subject matter ranged widely and included non-silicon device physics, power conversion, various nano-devices and applications, medical electronics, sensors, and modeling. A few of the attendees managed to slip away for a tour of the MTL fabrication facility in Building 19, including visitors from Monterrey Institute of Technology, Mexico.

As a symbol of our appreciation for their years of service at MTL during its entire 30 years, Carolyn Collins and Paul McGrath, MTL staff members, received special awards.

Vladimir Bulović, Professor in EECS and MIT Associate Dean for Innovation, then gave us a look at the future of nano-innovation at MIT, with *MIT.nano, A Sneak Preview*. For many in the audience this was the first look at plans for the innovation space now under construction. The new facility will be constructed in the heart of the MIT campus and will house a comprehensive set of tools for nanoscale research.



MIT President and former MTL Director L. Rafael Reif blows out the candles marking 30 years of MTL.

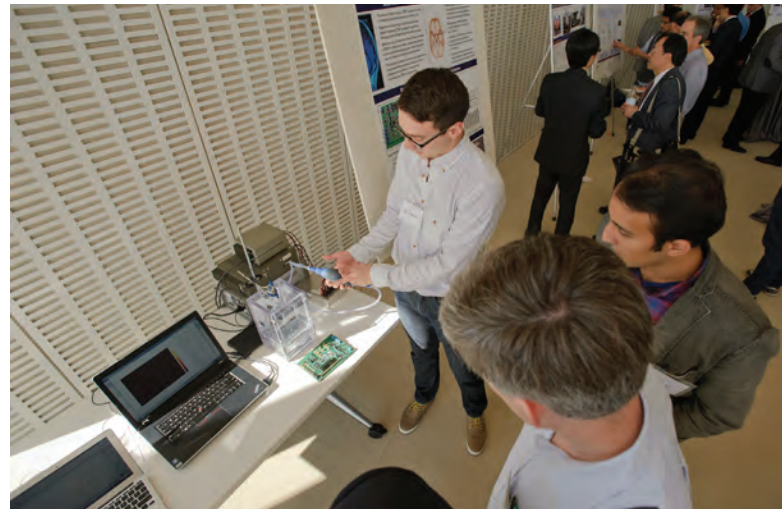

Twenty-seven research posters and demos showcased some of the latest work in MTL.

The next panel discussion was moderated by Karen Gleason, Professor of Chemical Engineering and MIT Associate Provost: *Vision for the Future of Nanotechnology*. The panelists, all MIT professors and MTL core faculty, included Dirk Englund (EECS), Pablo Jarillo-Herrero (Physics), William Tisdale (Chemical Engineering), Kripa Varanasi (Mechanical Engineering) and Michael Watts (EECS). Each gave a short overview of their research program and all discussed their dreams for the future of nanotechnology.

The final panel discussion of the Symposium was moderated by Anantha Chandrakasan, Professor and Department Head of EECS and a former MTL Director. It was titled *Vision for the Future of Nanosystem Applications*. The panelists, all MIT professors and MTL core faculty, were Ruonan Han (EECS), Thomas Heldt (Institute for Medical Engineering and EECS), Scott Manalis (Biological Engineering), Tomás Palacios (EECS) and Dana Weinstein (EECS). The panelists presented both a view of each of their particular research efforts and collectively discussed some of the application areas for nanotechnology.

Closing remarks were by Jesús del Alamo who thanked both the audience for their attendance and participation as well as the event organizers made up of staff from the MIT Industrial Liaison Program and the MTL. The very successful dinner and symposium represented the culmination of several months of intense planning between the Microsystems Technology Laboratories and the MIT Industrial Liaison Program.

The curated website of the conference with the detailed agenda, a PDF of the printed program and pictures can be found at <https://mtl30.mit.edu/>.

MEng: 20 years of EECS's flagship professional degree

Celebrating the MEng! 20 years of EECS's flagship professional degree

by Eric Smalley

Ali Alavi, like many Course 6 undergraduates in 1993, faced a dilemma. He was anxious to graduate and get a job, but he knew that getting a masters degree would give him an advantage in competing for better jobs. The Course 6.3 student eyed computer science programs at UC Berkeley, CMU and Stanford. "I really wanted to get a masters, but also wanted to be done with school and get into the workforce ASAP."

In the preceding years, the MIT EECS faculty had been wrestling with a related set of issues. The undergraduate program had become overloaded. Students were struggling to absorb the electrical engineering and computer science material needed to keep pace with an industry that was changing rapidly and was in the midst of a digital transformation. "The undergraduate curriculum was getting incredibly packed in and there was no pressure valve," said Prof. Charles Leiserson.

In short, the SB degree program was no longer capable of turning out graduates who were properly prepared to be professional engineers. "The driving issue was one of providing undergraduates with sufficient depth and breadth," said Professor Emeritus Paul Penfield, Jr., who became department head in 1989. "There just wasn't time in four years to do it all."

The graduates themselves addressed this shortcoming by going on in large numbers to earn masters degrees at other universities. Industry also recognized that the bachelors degree was insufficient. Companies commonly allowed recent hires to take a year off to earn their masters degrees, and often paid their tuition and continued their salaries. "So we said, why shouldn't they do their masters thesis here instead?" said Leiserson.

In the mid-1980s, the late Prof. William Siebert started a discussion within the department about a solution. The options, as Siebert saw them, were to shortchange students on breadth, shortchange them on depth, shortchange them on a general university education, or take an extra year of their lives. Several feasibility studies, draft reports and numerous committee meetings later, the discussion culminated in a bold proposal: revamp the department's degree structure and introduce a new, five-year professional degree: the Master of Engineering.

Penfield formed a committee to develop the degree program, and appointed Profs. John Gutttag, Campbell Searle, William Siebert, and Rosalind Williams to join him. The Committee on the First Professional Degree presented its report, A Proposal for New Degree Structures for EECS Students, to the EECS faculty in November 1991. The proposal introduced the MEng, redesigned the SB, and defined the roles of the two and the Master of Science and PhD.

The MEng differs considerably from the SM. The MEng prepares students for a career in engineering practice as well as for study toward a doctorate and a career in research or teaching. The MEng is a seamless combination of a bachelors and masters degree rather than a standalone masters program. It keeps the structure of a bachelors program through the fifth year, meaning students have course requirements as well as a thesis requirement. The SM program was retained and serves principally as a step toward an MIT doctorate for students who completed their undergraduate work elsewhere.

The new degree structure changed the SB program. A bachelor's thesis was no longer required, less advanced engineering was prescribed, and students had more flexibility. The program continued to prepare students for life and, at least for some students, for further study leading to careers outside of engineering, such as medicine, law, politics, or management. This role is one which liberal arts education also fulfills. Penfield said he regards the new SB program as "a form of liberal arts suitable for today's needs because of its large science and engineering content. Its graduates can use their engineering skills and attitudes wherever their careers take them."

The department published a report, New EECS Curriculum, in the MIT Faculty Newsletter in October 1992, and the School of Engineering approved the changes two months later. The department argued for and won a key change to the MIT course catalog for the introduction of the MEng. To that point, every department's catalog description had begun with the bachelors degree, followed by the masters degree, then the doctorate. Instead, EECS led with the MEng. "That provided an implicit statement of what we felt the new degree was," said Penfield. "It was our flagship degree. We wanted it front and center."

The department accepted the first MEng students in 1993, and Alavi jumped at the chance. The first degrees, including Alavi's, were awarded the following year. The program quickly ramped up, and by the academic year 1996-1997, 178 MEng degrees were awarded, which amounted to 60% of EECS undergraduates.

Today, Alavi leads a team of more than 200 engineers as Vice President of Software Engineering at MicroStrategy, Inc., a global business intelligence, mobile software and cloud-based services company. The MEng made a difference in the trajectory of Alavi's career, and it should be the first choice for today's EECS students, Alavi said. "Anyone who is not intent on getting a PhD should do the MEng," he said. "It's a total no-brainer: the opportunity cost is truly negligible compared with the long-term benefit."

Initiatives in EECS: building communities

Building a Research Community: SuperUROP in its third year

Getting to do serious, year-long research projects in electrical engineering and computer science is in! This year, 104 Course VI juniors and seniors elected to immerse themselves in a year-long research experience in SuperUROP, the three year old program in EECS modeled after MIT's Undergraduate Research Opportunities Program (UROP). Students are seeking the benefits and opportunities that SuperUROP provides – including working closely with a faculty advisor and his/her research group, working in high tech laboratory facilities, publishing a scientific paper or producing a prototype, and building a network with peers and industry sponsors.

"We are creating a community of scholars," notes SuperUROP creator and EECS Department Head Anantha Chandrakasan. "As they are exposed to the breadth of research in EECS, their excitement and enthusiasm to engage in research and innovation is contagious." While UROPs also enable students to conduct research, the SuperUROP includes a two-term course on undergraduate research (6.UAR), which focuses on topics such as choosing and developing a research topic, industry best practices, and presentation skills. The class — taught by Chandrakasan and Dean for Undergraduate Education and EECS faculty member Dennis Freeman — engages a wide range of experts from inside and outside MIT to broaden the approach to research, entrepreneurship and funding.

Support for the SuperUROP comes from industry and private sponsors through the Research and Innovation Scholars Program (RISP). Industries such as Cisco, Texas Instruments, VMWare, and Analog Devices are interested in not only building the next generation of top level researchers but also exposure to new directions in technology innovation. The RISP students also have a chance to present their work to their supporting company as well as to the annual undergraduate research conference started in 2013 called EECScon.

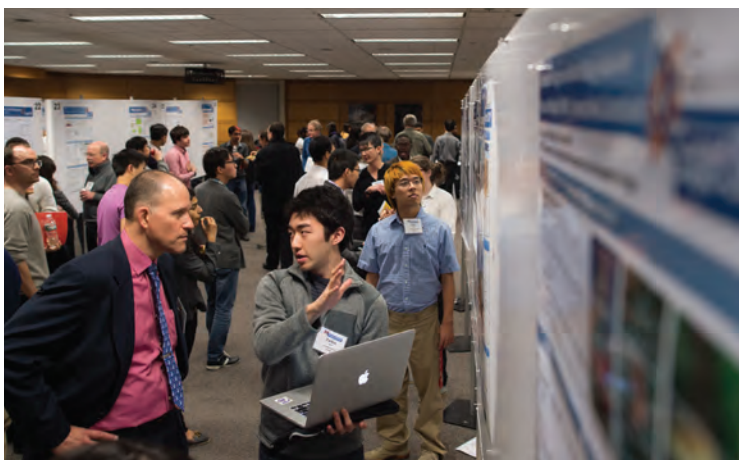

Two sessions were held back-to-back to accommodate the 104 SuperUROP students who presented their research work at the SuperUROP Research Review. Pictured left foreground : Ted Equi, SuperUROP Industry Liaison.

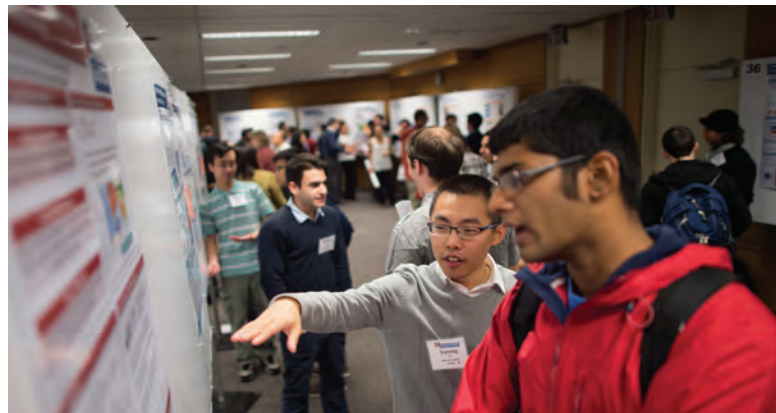

104 SuperUROP students presented their research work at the SuperUROP Research Review in early December 2014, attended by many Industry sponsors, MIT faculty and guests.

In an email to The Tech, in May 2012, Ray S. Stata '57, founder of Analog Devices, said, "As an industrial sponsor, Analog Devices will look for opportunities to collaborate with students and faculty on research topics of continual interest and provide insights into the relevance of research to real world applications. Analog Devices is excited about exploring new possibilities to strengthen our relationship with MIT students and faculty through the SuperUROP program."

"You get to meet a lot of people in different fields — from industry, graduate school and academia," says Lyne Tchampi Petse '14, who joined SuperUROP in 2013 at the urging of her advisor, Charles Sodini, the Clarence J. LeBel Professor of Electrical Engineering. She saw the program as a way to dive deeper into her project — developing an earpiece that monitors and sends vital signs to a smartphone for doctors to analyze. "The project has given me a lot of insight into my future career choices." (Read more about Lyne and other SuperUROP grads and current students, pages 15-16.)

In addition to the students and company sponsors and mentors, the other key component group in the SuperUROP is the faculty advisor. This group has also been growing with 58 faculty building a working research mentorship with one or more SuperUROP students this academic year 2014-15. EECS faculty members have posted well over 100 research project ideas for which students can apply to work on, beginning in the coming academic year. In the spring, EECS Principal Investigators aggressively recruit undergraduates into their groups through SuperUROP. Each participating SuperUROP faculty member also benefits through the RISP with a stipend — something which George Verghese, the Henry Ellis Warren Professor and MacVicar Fellow notes is not only generous but reflects the enthusiasm of the sponsors in their sustained support of the program.

SuperUROP in its third year, *continued*



“There are so many things to like about SuperUROP!” Verghese, says. “I particularly like the way it gets students to really settle into a research project over the academic year, and to take serious ownership from the beginning. Doing the project in a cohort, with joint classes, activities, milestones, and presentations to the wider community, also changes the dynamics — and not just for the students, but also for the mentors (graduate students and faculty).”

By the end of their full year, SuperUROP students earn a certificate in advanced undergraduate research, which is offered in a variety of fields, including artificial intelligence, computer systems, nanotechnology and synthetic biology to name a few. In many cases, this work becomes the basis for earning an MEng degree and applying to graduate school.

One of the final preparations each SuperUROP student makes is to distill his or her year of research into a 90 second pitch for an audience of 6.UAR peers, course instructors and industry sponsors. Francis Chen about to go on in his MEng in artificial intelligence, at the time, had done his SuperUROP research in synthetic biology, specifically designing and implementing a microfluidic DNA assembly system. “The 90 second pitch was my chance to practice all I’d learned from 6.UAR in a setting with feedback from the entire class,” Chen said. “It was an excellent opportunity to distill my work down to its essentials, polish an impactful pitch and experience broad, unfiltered feedback.” (Read more about Francis and other SuperUROP grads and current students, pages 15-16.)

Growing the SuperUROP

As SuperUROP moves into its 4th year, MIT’s Aero/Astro Department is joining EECS in offering SuperUROP to its upcoming juniors and seniors. Students will learn about the program at two info sessions in early March with applications due by April 1.

MIT President L. Rafael Reif noted in the fall 2014 about SuperUROP: “In just two years, SuperUROP has developed into a tremendous opportunity for Course VI students to gain meaningful research experience in world-class labs. The impact we are already seeing is enormous; I am enthusiastic about the program’s potential to help shape how our students think about the role research plays in addressing important challenges.”

See the brief features on several SuperUROPs from the inaugural class through the current 2014-15 class (pages 15 and 16). Three USAGE students who helped shape the SuperUROP as it was being formed are featured in the section on USAGE, page 18.

<http://eecs-superuop.mit.edu>



Photos taken at the SuperUROP Research Review and Community Dinner where 104 SuperUROP research students presented their work and joined industry sponsors for a Research Community dinner following. [Gretchen Ertl, photography]

Initiatives in EECS, continued

Current and Alumni SuperUROPs: part of a growing community

Class of 2012-13



After completing his SuperUROP in 2013, **Arun Saigal**, then a senior, fulfilled his MEng, and by July (still in 2013), joined Quizlet, an education technology startup. *"I had UROP'd in the Media Lab my freshman year and in CSAIL my sophomore and junior years. While I felt like the UROPs allowed me to do some interesting work, they didn't give me a really in-depth research experience. I was hoping to do research at a level that I could publish."*

Not finding that in his UROPs, Saigal was able to reach that level in the SuperUROP in his senior year. He worked on MIT App Inventor, a blocks-based programming language that allows people to build Android applications. His MEng focused on information accountability for mobile applications — a fitting preparation for his work at Quizlet, where he is lead Android developer.

"The SuperUROP is a great opportunity to do meaningful work outside of the classroom during the school year. Take advantage of this time to build relationships with your mentors and people in the lab you are in, and produce high quality research that you are proud of."

Lyne Tchampi-Petsi worked under Prof. Charles Sodini and his students David He and Eric Winokur, for her SuperUROP, followed by earning her VI-A MEng at Maxim Integrated. Now she is pursuing her PhD in Electrical Engineering at Stanford.

"I worked on developing a wireless communication system for an earpiece that monitors and sends vital signs to a smartphone for display and analysis. The project was extremely comprehensive and allowed me to further my skills in embedded programming and circuit design. I learned to do research in topics I initially had little experience in — encouraging me to try new projects and topics of research. The class portion of the SuperUROP was mind opening. It gave me a glimpse into the different possibilities for careers in industry, graduate school and academia."

Tchampi-Petsi wants to use all the skills she has acquired to create Software, Electronics, and Robotics systems that will help enhance the lives of people throughout the world.



Class of 2013-14



Ishwarya Ananthabhotla completed her SuperUROP in 2014 as a junior working under Professor Daniela Rus in the Distributed Robotics Lab. She said about the experience:

"The concept of the research entailed design, development, and fabrication of miniature robots and robotic components that were capable of assembling themselves by self-folding upon the application of heat. I enjoyed being on the forefront of a novel investigation, learning from the creative approaches of my mentors and fellow students, and simply being able to work on technical challenges in a space of robotics that I found fascinating. The experience I gained from the SuperUROP program solidified my future plans — it showed me that I truly am passionate about research, and I see myself being in academia in the years down the road. I'm beginning to do my Master's research this year in an area that's closely tied to hardware and robotics, under Prof. Chandrakasan, and I hope to join a PhD program after my MEng is complete. Overall, the SuperUROP program really gave me a sense of direction and a valuable set of skills as I work towards achieving my future career goals."

As a SuperUROP, **Francis Chen**, worked under Prof. Ron Weiss designing and implementing a microfluidic DNA assembly system. The idea was to be able to automatically synthesize custom sequences of DNA for experimentation in the field of synthetic biology. His work involved three foci: a microfluidic chip (design and fabrication), a controller (hardware), and a compiler (software). "Though I was not able to produce a working end-to-end system as a SuperUROP, I made a great deal of progress in terms of designing/building the sub-systems."

"I've learned a lot about engineering research on the cutting edge and will be gaining more experience in this area in the MEng program in the MIT EECS Department (concentrating in artificial intelligence). I chose not to continue my research last fall, because I wished to focus on software engineering instead of a highly multidisciplinary project for now."



SuperUROP Alumni and Current, *continued*

Class of 2013-14, *continued*

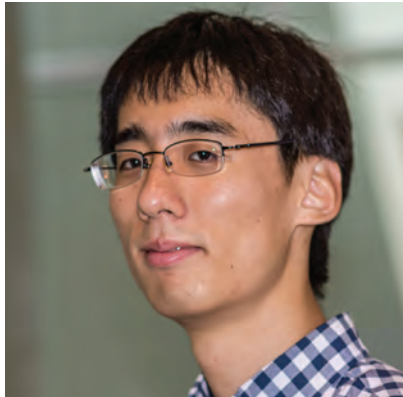

Through SuperUROP, **Daniel Kang** was able to work with Prof. David Gifford on applying state-of-the-art machine learning techniques to understand large biological data-sets in the context of epigenetics. This work both implemented a distributed, approximate inference algorithm to process billions of examples on the hours time-scale and has led to novel discoveries regarding the accessibility of DNA. Currently this work is under review for publication in the journal *Science*.

Kang was selected recently for the Churchill Scholarship — only the 12th MIT student ever to be selected for this honor for which he will study math at Cambridge University. He will then study for his PhD at Stanford.

Since high school, Kang has gained perspective by working in industry, such as open source projects x264 and FFmpeg/Libav, work on Google's then experimental video codec and later on Google Search followed by an externship at Apple's Applied Machine Learning Group.

Class of 2014-15

SuperUROP and EECS senior **Elaine McVay** is working in Prof. Tomas Palacios' lab to develop large area electronics out of conductive and semi-conductive two-dimensional materials including graphene, graphene oxide, and Molybdenum Disulfide (MoS₂). I am approaching this challenge by developing inks out of these 2D materials that a 3D printer can print into not just a large area, but a large volume. I am also developing an organic LED display that is powered by MoS₂ transistors. This application is first being fabricated by conventional methods, but components of the display can also be printed with our 3D printer once it and the inks are fully developed.

McVay says about her experience, *"This project has helped me decide that I want to continue on to graduate school."* She wants to pursue her MEng followed by a PhD program.

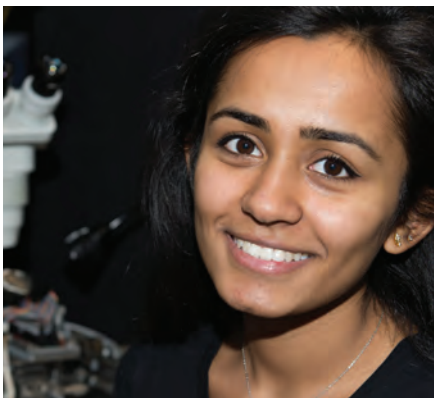
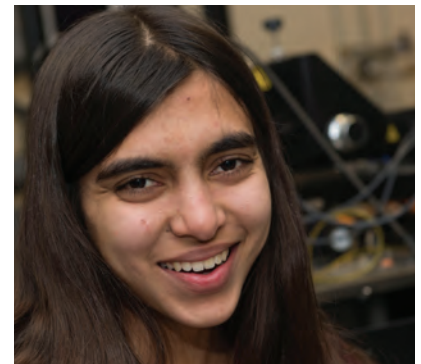

Mihika Prabhu is working as a SuperUROP in the Quantum Photonics Laboratory under Prof. Dirk Englund, Jamieson Career Development Professor. The work involves developing a quantum photonic processor that will be able to carry out a wide range of quantum and classical algorithms. *"We seek to advance the state-of-the-art by creating a quantum Photonic Integrated Circuit (PIC) that boasts complete reprogrammability, as well as a decrease in chip size by using the silicon-on-insulator fabrication process,"* she says. Prabhu is thrilled to work in a research group where she is exposed to many aspects of an exciting field.

"It was incredibly exciting seeing light propagating through the quantum photonic processor for the first time. Seeing the system finally functioning has been one of the most satisfying moments of my research thus far." Prabhu has discovered through this work a fascination with creating quantum technologies using photonics and plans to pursue her PhD in the field.

"Working at the cutting edge of synthetic biology—and working largely independently—has been extremely exciting!" says EECS senior and SuperUROP **Ava Soleimany**. *"Being able to point to something completely novel and say 'I created that' is extremely cool."* As a 6-7 major, Soleimany is working in the lab of Prof. Tim Lu, where she says the aim is to expand the scope of biological computation by constructing higher-order cellular state machines in *Escherichia coli*. Using DNA recombinases as a basis for circuits, cells can be engineered to execute sequential logic and differentiate in a controlled, predictable manner. She is amazed at the potential from this work to use these logic systems to enable biotechnology applications such as microbes engineered to produce a large number of pharmaceuticals based on only a few inputs. She wants to continue towards a PhD in either Computational Systems Biology or Bioengineering. *"I've realized [through SuperUROP] that intellectual discovery, leadership and mentorship are really my core motivators,"* she says.



USAGE: Four years of contributions to EECS



USAGE is making a difference in Undergraduate Life in EECS

As the 2014-15 Undergraduate Student Advisory Group in EECS (USAGE) gathered this, its fourth season, there was an air of familiarity with nearly a third of its 36 members returning for another year of reflection, discussion and action to enhance the undergraduate experience for fellow and future EECS undergraduates. This standing committee has also continued to entice new members — sophomores who want to connect early to make a difference in their department.

Pratheek Nagaraj, a member of USAGE as a sophomore in fall 2013, recognizes that the group is unique as it bridges the gap between the administrative leadership and the undergraduate student body. “In my time on USAGE,” he says “we have contributed to several high-impact decisions within the Course 6 community, ranging from the creation of a new EECS undergraduate lounge to revamping the curriculum. For me,” he continues, “the meaningfulness and the visibility of my contributions are most significant as I truly feel that I have a voice in the future of Course 6.”

Serving on USAGE has become a sought-after outlet and opportunity that students find worth their time. The accomplishments of their USAGE predecessors include input that helped shape the formation of the SuperUROP, feedback that has created roles for undergraduates in the faculty search process, input that influenced the creation of EECScon – the EECS undergraduate research conference, and the creation of the EECS Undergraduate Student Lounge, launched in early October this year.

Uttara Chakraborty is excited to be involved this year to enhance the opportunities for electrical engineering students (Course 6-1). “To me, the most thrilling aspect of being a part of USAGE,” she notes, “is the ability to have a voice in shaping the undergraduate curriculum, workload, and courses in EECS. As a sophomore in Course 6-1, I am excited to see USAGE playing a role in helping to enhance the EE curriculum and provide more opportunities for EE students. This experience is novel, providing a beautiful, one-of-a-kind bondage to the family that



The EECS Undergraduate Student Lounge opened in October, 2014, the fruits of the work by USAGE 2013-14 members with members of the EECS administration. See: www.eecs.mit.edu/news-events/media/course-6-crates-new-undergraduate-student-lounge

is EECS. I am grateful to Professor Chandrakasan for giving us this unique opportunity.”

Anantha Chandrakasan, EECS Department Head since July 2011, notes the significance of forming this group. “One of my best early decisions as department head was to form the Undergraduate Student Advisory Group in EECS, whose members provide critical student input guiding curriculum development and enhancements.” USAGE was created in 2011-12 as part of the department’s strategic planning process.

The focus of USAGE members this academic year is to provide feedback as the EECS faculty updates the curriculum. USAGE members have also polled their peers on workload issues and implications of gender differences towards majoring in EECS.

(next page.)

Initiatives in EECS, *continued*

USAGE contributions since 2011 are having an impact, *continued*

Meeting every other week with Prof. Chandrakasan, Prof. Albert Meyer, EECS Undergraduate Officer, and Undergraduate Administrator Anne Hunter, the students actively report as leads in subcommittees once data is collected to develop best approaches for further action.

EECS faculty members have also become involved in engaging USAGE members on specific issues. Shafi Goldwasser, for example, is meeting with a USAGE subcommittee to discuss workload for EECS undergraduate students and its implications. Goldwasser, who proposed the idea to USAGE, notes about this project, "The Usage group met to discuss the charter of a new EECS committee commissioned to study the work load of Course 6 students. The meeting was instrumental

in formulating areas of investigation, such as the balance between credits and hours students put into the course, typical work weeks and sleep schedules of MIT EECS students, and evaluating knowledge retention in the light of the above."

In December 2014, Prof. Leslie Kaelbling presented a progress report of the EECS Education Curriculum Committee (ECC) to the members of USAGE. On this first exposure to the proposed new curriculum, the students raised many questions in addition to providing input on various issues. Prof. Chandrakasan notes that the students provided some excellent suggestions and good feedback, as the ECC continues to shape the new curriculum.

See the online article to read about each USAGE member: <https://www.eecs.mit.edu/news-events/media/usage-its-fourth-year>

USAGE Alumni who helped shape the SuperUROP in 2011-12:



Carine Abi Akar '12, is working with McKinsey & Company in their Dubai Office. She spends a lot of her work efforts on solving unemployment challenges for women in the Gulf through technology and creating strategies for new areas of growth in the Middle East, especially entrepreneurship. She notes: "This is very different from my coding 6-3 days. Many ask me, "How did you go from MIT to where you are today?? Debugging in the basement of Stata is nothing like consulting in Dubai!" Well, other than the hard content we learn at MIT, we also develop our intrinsic, our knack for solving any problem. MIT gave me a toolkit, and this toolkit is applicable anywhere and everywhere. We approach the world differently: we problem solve, challenge, think critically, work collaboratively, utilize resources, design solutions, iterate and design them again. An MIT education is gold, if not better."

As she looks at SuperUROP from afar, Abi Akar says that SuperUROP students are developing cutting-edge solutions to real-world problems. "The more we create opportunities for problem solving in universities, the more we are enabling future generations with strong skills to become agents of change in our societies. I recommend all students to think of themselves as contributors to the MIT community's growth, especially for the long run. The world is waiting for you!"

Gustavo Goretkin '13, not only participated in the inaugural USAGE, helping to shape the SuperUROP, but was a member of the inaugural SuperUROP class in 2012-13. In the photo right, he is speaking, as an MEng student, to the new 2013-14 class of SuperUROPs. Goretkin has been working in robotic manipulation as a PhD candidate with Professors Kaelbling and Lozano-Pérez.

"SuperUROP not only made it possible for me to apply for graduate school with strong recommendation letters, but it prepared me well to present my research," he said. "Most useful," he concluded, "was hearing from the 'rockstar' people who presented to the [SuperUROP] class members during the year."



Catherine Olsson, SB '13, MEng '13, worked in Prof. Aude Oliva's lab, studying scene-action associations in natural images. That project resulted in a conference paper at the European Conference for Computer Vision in 2014. She is now a graduate student in computational neuroscience at NYU, studying the low-level basis of human vision. She spends most of her time programming, using the image processing and data analysis skills that she learned in EECS at MIT.

"Being part of USAGE was a highlight of my MIT experience," Catherine says. "Contributing to the quality of education in our department was very rewarding." This past term, she TA'd her department's introductory math and programming course for incoming graduate students, many of whom do not have an EECS background. "My experience in USAGE thinking deeply about effective program and curriculum design in EECS helped me tailor my teaching to the concrete skills and concepts that we wanted the students to get out of the course."

EECScon: Undergraduate Research Conference

Pairing EECScon with Masterworks, the annual EECS Master's Presentation, puts EECS Students' research on the map

Whether presented in a formal conference hall at a Kendall Square hotel or accompanied by large servings of ice cream along the Charles M. Vest Student Street in MIT's Stata Center, research carried out by students in MIT's Department of Electrical Engineering and Computer Science (EECS) has gained a strong presence around MIT and beyond.

In 2014, and going forward, EECS decided to pair its cornerstone venues for showcasing student research — EECScon (photo right) and Masterworks (photo, lower right) — in one afternoon, to capture a large group of guests including fellow students, postdocs, research staff, faculty, and industry visitors.

"The conference was a great opportunity to get feedback from professors and students on the progress I had made in my research," says EECS senior Abubakar Abid. As one of six oral presenters at EECScon 2014, Abid found that he got the opportunity to answer questions from those who weren't as familiar with his topic, neural probes. He also says that this feedback will help him to pitch his work more clearly and concisely in the future.

EECScon, launched in 2013 to provide a professional-level research conference experience for undergraduates, was again organized and run by EECS students under the guidance of Professor Joel Voldman. Nearly 170 of the more than 280 who registered attended the event — including a large number of undergraduates.

Voldman enthusiastically endorsed EECScon 2014, noting a rise in registrations and the many touches that elevate this conference to professional standing: peer-reviewed abstracts, professionally printed programs, graduate-student mentoring, and both oral and poster presentations. He credited the members of the EECScon committee — Abid, Ali Finkelstein, Skanda Koppula, Zeo Liu, Pratheek Nagaraj, Akshay Padmanabha, Hyungie Sung, and Benjamin Xie — and the event's two co-chairs, Jenny Shen and Jon Birjiniuk.

Among the strategies established by this group last September, the EECScon committee built in ways to help students prepare — including setting up information booths at study breaks to attract more participants, focusing on individual researchers in their publicity, and increasing interactivity at the conference itself. Nagaraj notes, "We spent time with each researcher to help further their presentations, including mentorships and dry runs."

Texas Instruments' Heather McCulloh, a unit process development manager at MaineFab, was impressed with the quality of work at EECScon and Masterworks. "I particularly liked the strong understanding the students demonstrated of the significance of their work and competitive technologies," she said.



Since 1994, when the Master of Engineering degree (MEng) was launched in EECS, Masterworks has been an annual venue for master's and MEng students to present their work, using posters and demo materials, to their fellow students, as well as to faculty and outside guests. (The lure of free ice cream has also been a part of Masterworks for nearly a decade.)

Masterworks 2014 was the best-attended yet, with more than 400 students, faculty, and industry guests interacting with the 38 presenters. Tomas Palacios, Masterworks faculty co-chair, noted "Many of the presenters brought all kinds of demos to better explain and highlight their work — making the event a lot of fun."

Read more online at: <http://newsoffice.mit.edu/2014/eecon-masterworks-raise-awareness-student-research>

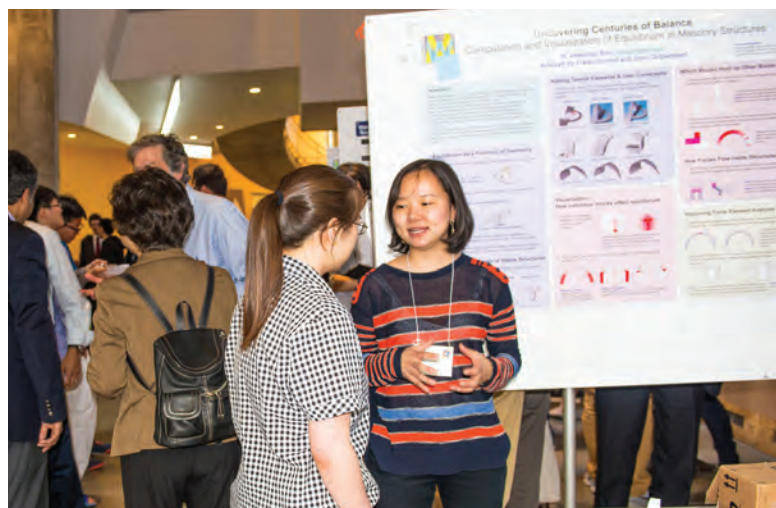

Start6: Building the innovation community



Start6 connects MIT students to lasting, high-level entrepreneurship community

Start6, the IAP workshop for entrepreneurs and innovators, in its second year, finished Monday, Jan. 26, pre-blizzard — a day packed with project presentations, a talk given to a full house in 34-101 by Institute Professor, serial entrepreneur and inventor Robert Langer, and a “fire side chat” that was improvised as a Skype chat with Drew Houston, EECS alumnus and Dropbox Co-Founder and CEO, as he waited at Logan Airport to catch his flight back to California.

The wide range of the twenty-four projects that were presented through the morning and early afternoon that day by Start6 teams and single developers included new medical technology applications, educational software, photonics driven security communications, drone applications in fighting fires or rescue situations, and Internet-driven social services models, to name a few. With roughly five minutes to make a comprehensive and compelling presentation, each project group built on the previous two weeks of pitch practice, honing their value proposition and incorporating some of the many suggestions offered in the previous two weeks of the for-credit class.

EECS graduate student Colm Joseph O'Rourke put Lemnos Labs Founding Partner, Jeremy Conrad's suggestions to practice by video-taping himself before his Start6 presentation. He also heeded the public speaking lessons he picked up from Sloan School program manager Christina Chase, one of over 50 Start6 speakers, as he pitched MathMotion, a software for smart boards and tablets to help students and educators communicate and understand mathematical operations using animated steps in solving an equation.

Carey Anne Nadeau, has developed a service startup. Designed for non-profits and cities that publish open public data, Open Data Discourse, ODD, hosts civic challenges that invite the hacker, data visualization, and policy advocacy communities to inform civic priorities and scale solutions to improve communities. Hearing Actifio Chief Marketing Officer Mike Troiano speak about crafting a value proposition resulted in her re-evaluating how she and her team are describing their company and improve their pitch to articulate the description of their product precisely.

Whatever their project, Start6 students and visitors flocked to hear Prof. Langer's accounting of some of his experiences in creating companies based on his seminal drug delivery and biomedical discoveries. Catering his talk to the Start6 innovators and entrepreneurs, Langer suggested a formula for building companies, particularly building on platform technologies that will have multiple applications (both publishing in major journals and obtaining broad patents), engaging people who “walk through walls for you”, and getting a good CEO.

When asked about time management in the follow-up Q and A, Langer said his criteria is based on impact. Asked about any failed startups, he noted that none of his now 28 companies have failed, though he repeated that choosing a CEO (with very good business sense) is key.

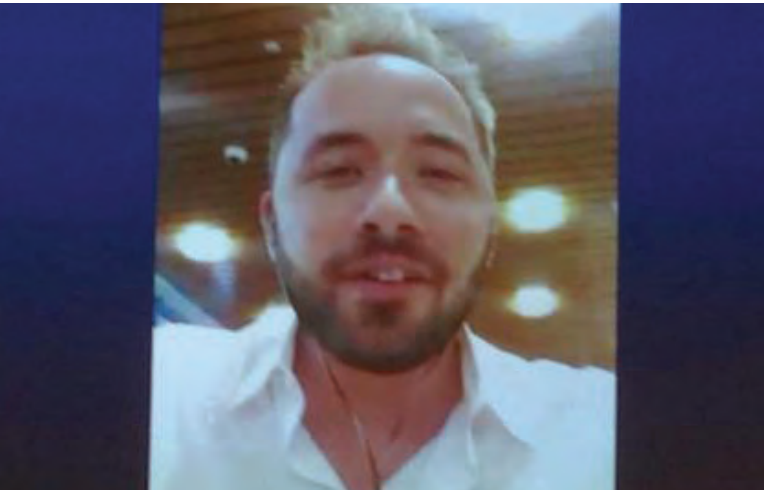

Institute Professor and serial entrepreneur and inventor Robert Langer (photo top) spoke to a full house at 34-101 for the last day of Start6, 2015, followed by a Skype-enabled fire-side chat with Drew Houston, '05, Dropbox Co-founder and CEO (screen view photo).



The Panel titled *Marketing Techniques* was moderated by Erica Swallow (Sloan MBA candidate), left, followed by panelists (from left) Jay Acunzo (Next View Ventures), Rachel Zimmerman (WBUR), Kris Bronner (UNREAL Brands), Giuseppe Frustaci (marketing professional focused on digital performance marketing for startups). Day 4 of week 1 of Start6 2015.

Initiatives in EECS, *continued*

Skyping from Legal Seafoods at Logan Airport, Dropbox Co-founder and CEO Drew Houston, '05, welcomed the chance to fit in his Start6 fireside chat with EECS Department Head and Start6 founder Anantha Chandrakasan. Houston described his early days both starting Dropbox and his previous startup for an online SAT Prep service. "How did he develop his management knowhow?" Chandrakasan asked. Houston responded that he poured over books he bought online – during summers on the roof of his fraternity. Now his most important work is recruiting for Dropbox, which has over 1,000 employees (doubled over the past year) and working with small groups of team leaders to build their products.

"We live these things everyday," Houston said about the forces that shape the direction his company takes. He noted that organizing and sharing data, such as Dropbox's photo app, dubbed Carousel, introduced in spring 2014, have been major foci. The relevance of machine vision and data predictions and security has continued to be high priority at Dropbox, Houston noted, as he described the Dropbox goal of remaining close to its customers and always looking for a deeper understanding of the problems they solve. His favorite class in Course VI? Intro to Algorithms (6.046).

Houston noted that it has become commonplace that Internet technology companies have allowed small numbers of people to solve the world's needs. He also pointed out that patented technologies are not as strategically important in most Silicon Valley, Internet-based companies. In response to an audience question: How do you keep your head cool as you run a \$10 billion company? "It's all a gradual process," he said. "There are a lot of things that could take us down, ...but we have a lot we want to do, so we stay on our toes."

Graduate students Monica Stanciu, in Biology and Adrian Dalca, in EECS, who are working on a project called Cromia, found Houston's talk "very down to earth, making it seem like success is within reach." Cromia is a crowd-sourced medical image analysis startup aiming for quick and accurate automatic analysis for medical imaging in clinical trials. Stanciu and Dalca were thrilled to learn from Start6 speaker Sangeeta Bhatia, 2014 MIT-Lemelson \$500k prize winner and joint professor in EECS and HST, how the science drove her entrepreneurship journey, in addition to the excitement and hurdles that she described along the way.

They also found the Start6 lateral learning sessions, such as the pitch practice "immensely helpful because of the personalized attention from a mentor as well as other students." Start6 included over 50 mentors guiding the registered students and postdocs, from over 15 departments at MIT.

Curtis Northcutt, an alumnus of Start6 (2014) returned to a reception hosted by Paul English at Blade LLC, in Boston on Jan. 22 to share his experiences growing his startup Reverse Definition— Revdef, a new search engine that interprets queries about phrases or a word or fact, to be made available for public



Curtis Northcutt, Start6 alumnus spoke at the Blade Reception on Jan. 22. Anantha Chandrakasan, EECS Department Head (center) and MIT School of Engineering Dean Ian Waitz are pictured in the background.

use in late spring or summer. "It seems as though a glass wall resides between us and the 'real' entrepreneurs on the other side. Start6 shattered that glass wall for me," Northcutt shared with the Blade guests. "The biggest advantage of Start6 isn't learning how to start a company, it's the human resources and network it provides."

Although the Start6 class is over, the real work for many of the participants is ongoing and jump-started by all that has transpired since. Many of the teams have continued meetings with their Start6 mentors. A Start6 reunion in mid February provided the students a chance to hear Rod Brooks, Rethink Robotics Founder and CEO, talk informally about his experiences.

Through February, at least 30 Start6 students prepared for the Spring break trip to meet with several venture capital firms and startups in Palo Alto and San Francisco. And, all Start6 students were eager to hear the announcement of the Start6 first- and second-prize winners following the selection in mid February of ten project teams to compete for a new Start6 prize.

At the Blade Start6 Alumni Reception, Chandrakasan announced the creation of the Start6 Fund made possible by alumna Haejin Baek '86, a double major in computer science and management. The 2015 Start6 prizes made possible through this funding will be awarded to two teams, which are working towards commercial launch of their startup, for \$10k and \$7.5k.

"Start6 this year has made entrepreneurship a focal point for students from across the Institute," Chandrakasan said. "We are pleased that many top entrepreneurs, venture capitalists and experts in innovation services shared their time and passion with a very receptive group. There is a good chance that some impressive innovations and a new group of entrepreneurs will emerge and *all* will have benefited from this experience."

See more news coverage at: <https://start6-2015.mit.edu/>

Postdoc6 comes full cycle: EECS Postdocs gain new perspectives



“So you are in! [as a postdoctoral associate in EECS at MIT] What is important about your research that matters in applying for a job? Is there funding? Is your [research] area one that has traction in getting funding?”

Professor Munther Dahleh (in photo, above), spoke extemporaneously to an overflow crowd of over 100 postdocs who came to the first fall event held in late October 2014 for Postdoc6, a group, which was created by the Electrical Engineering and Computer Science (EECS) Department in late 2013. Dahleh, the Director of MIT’s Engineering Systems Division and the William A. Coolidge Professor in Electrical Engineering and Computer Science is talking with the group to encourage open discussion about the issues that these researchers face as they seek to establish their paths in either academic research or research positions in industry. He guided the responsive group towards his main point: “Ownership — own your piece of work. Show that you can think for yourself.”

Dilip Krishnan, a former postdoc since fall 2013, worked with Professor Bill Freeman in the field of computer vision to develop depth perception. When he graduated from NYU, he didn’t know whether he wanted to head for an academic or industry research position, so building his research independence as a postdoc was his most important next step. “In a PhD,” he said, “things are driven by the vision of your advisor rather than your own. A postdoc gives you much more freedom to set your own agenda but you need to take advantage of that opportunity,” Krishnan notes. He is now a research scientist at Google Cambridge.

At MIT, as of fall 2014 there are 1,565 postdoctoral scholars and in the EECS Department roughly 240 postdocs working in the four affiliate labs — Computer Science and Artificial Intelligence (CSAIL), Laboratory for Information and Decision Systems (LIDS), Microsystems Technology Laboratories (MTL) and Research Laboratory of Electronics (RLE). Besides being spread across these four labs housed in buildings 39, 38, 36

and 32, the population of EECS postdocs pales in comparison with roughly 800 undergraduates and 750 graduate students. The ultimate effect is that EECS postdocs, who are already steeped in heavy demands for original research and leadership in their fields — usually in a short time span — are likely to become isolated, missing potential opportunities for networking that could make a difference as they reach for their next, or ultimate career goal.

Recognizing these realities and, at the suggestion of the 2013 EECS Visiting Committee, the leadership in EECS decided to start a new group — now called Postdoc6 — to give its postdoctoral associates a sense of community and to address concerns and needs. After an initial gathering in late fall 2013 to test the interest, EECS department head Anantha Chandrakasan and then associate head Bill Freeman launched the group with a daylong workshop “A Bootcamp for EECS Postdocs.”

Freeman continued to build the new EECS postdoc group organizing three other events in spring 2014 to answer the needs typical for postdocs: networking, understanding funding avenues, starting a teaching or industry career and learning from recent graduates who were interviewing for faculty positions. He noted: “Being a post-doc is the ideal job. You usually have the freedom to explore whatever you want to, and you’re often in a very supportive work environment. You generally have the freedom to try something new, and the freedom to fail without bad consequences happening.”

Time to gain perspective

Former CSAIL postdoc I-Ting Angelina Lee, who earned SM and PhD degrees in computer science from MIT, found her experience valuable in the long run, though she says that the transitional (and temporary) nature of the position created anxiety for her. Deciding between an industry position and an academic one was difficult. Having taught 6.172 alongside Prof. Charles Leiserson, Lee found that she gained perspective on the role of a principal investigator (pi) and professor. “I got to see different perspectives from the point of view of a pi but not total head of household— if the house comes crashing down, Charles would be there,” she noted last summer (2014). She is now an assistant professor at Washington University in St. Louis.

Balancing act: the two-body problem

When Daniel Zoran graduated from Hebrew University and joined Prof. Freeman’s lab to work in computer vision, he had been well prepared as a graduate student for his postdoc position and preferred to work at MIT. “I came here to expand my horizons. I hope to become faculty at some point. I chose MIT because it’s very densely populated in a good way.”

Zoran’s wife, a neuro biologist was also looking for a postdoc position. They were unusually fortunate to be able to choose between three offers. His wife took a postdoc position in MIT’s Brain and Cognitive Sciences and expects to stay on for three

years. “My wife does real experiments where everything is very time-consuming,” he notes. “With a two-year-old son, very little free time is left. The bottom line is that you need to publish something during this span of time.” Zoran plans to continue research in Cambridge while his wife finishes another year of her postdoc at MIT.

Postdoc positions in Engineering — early preparation

Ram Vasudevan, former postdoc with Prof. Russ Tedrake in CSAIL and now an assistant professor at the University of Michigan, came to MIT after earning his PhD at UC Berkeley. After attending several of the Postdoc6 events in spring 2014, he wishes he had had this kind of preparation while he was a graduate student. In reflection, he says “I like how you guys are now turning it [Postdoc6] into something that is not only for postdocs but for senior graduate students. That is a smart idea. Many places are just beginning to start up similar initiatives in engineering now.”

Having searched for a long time for the most advantageous postdoc position, Vasudevan found that the academic landscape in engineering — in terms of sequence of study followed by postdoc positions — is beginning to resemble that in biology. “That is,” he notes, “the postdoc is starting to become a standard component of any individual interested in pursuing an academic career.”

Broad vision in a defined field

Zheshen Zhang has been a postdoc for three years — working as an experimentalist in quantum optics in RLE. Working with theorist Prof. Jeff Shapiro and senior research scientist Franco Wong is an experience that Zhang both enjoys and finds very helpful in his personal development. Quantum optics as a field is in its early stages, but Zhang is hopeful for opportunities as some companies such as Google and IBM have begun to set up labs in this developing field.

Raised in China, where he completed his undergraduate work, Zhang was a graduate student at Georgia Tech in both the U.S. and Georgia Tech’s European campus in France. He notes, “I have lived in three different continents. This is a benefit.” With multinational contacts, Zhang hopes to continue to give research talks abroad to make his work known — while he explores both academia and industry.

As the EECS department leadership has shaped the structuring of Postdoc6 to respond to feedback from its postdocs, several participants have voiced appreciation and suggestions for building what is already a responsive community. In addition to making data on postdoc positions available to its current graduate students, EECS postdocs have voiced the need for establishing a database on the job scene — for both academic and industry positions. Several have suggested a career fair for postdocs, the need for local opportunities for coffee hours and



Professor Charles Leiserson leading a session at the Postdoc6 all-day workshop in January to develop a unique two sentence research statement.

networking, and establishing a portal site for postdocs to be privately listed with the potential to exchange resource ideas and encourage greater mutual support.

Postdoc 6 — full cycle

By January 2015 launching into its second year, Postdoc6 held another all-day workshop. “With many new postdocs every year, we should allow for this repeat,” said the new coordinator for Postdoc6 Aude Oliva, Principal Research Scientist in CSAIL and the MIT Computer Vision and Graphics Group. “Now we have the full cycle,” she notes, “... and continuity is underway.”

Oliva should know about postdocs. She held four different postdoc positions in four different countries, in four different research areas over the course of seven years. “Those are the golden years of building your mind!” she notes enthusiastically about her experience. In fact, Oliva, formerly an associate professor in the MIT Department of Brain and Cognitive Sciences, used to run workshops for graduate students about postdocs and future advising. “I am a big fan of the future,” she says. “When you are neither a student or a faculty,” she notes, “you can open your mind up and dedicate most of your time to develop a research program that will make you unique.”

Now almost two years in CSAIL and EECS, Oliva finds that the cross-disciplinary nature of these communities allows for the best opportunities for exchange “...where one of my students in neuroscience, for example, can talk with an expert in robotics,” she says. She also notes that larger talks and events offered by Big Data and Start6 are also geared to postdocs.

Based on the attendance (over 70) at the January 26 workshop, Oliva says that the feedback suggested concrete views, such as how the search process happens behind the scenes, and personal perspectives such as developing an effective research statement. Professor Charles Leiserson led a session for participants to develop a unique research statement in two sentences. “Learning how to make such an impactful statement was so useful!” Oliva said. She was glad to have been present herself.

Rising Stars in EECS: sharing a common goal



As a part of the 2012 Strategic Plan, the EECS Department launched the Rising Stars program in fall 2012, to build and strengthen the academic pipeline for top recent women graduates in electrical engineering and computer science.

The inaugural workshop held in November of 2012, brought together 38 of the world's top young female electrical engineers and computer scientists for two days of scientific discussions and informal sessions aimed at navigating the early stages of their careers in academia. Attendees came from MIT, UC Berkeley, Stanford University, Cornell University, Carnegie Mellon University, the Max Planck Institute in Munich, École Polytechnique Fédérale de Lausanne in Switzerland and other research institutions to network with one another and with faculty from MIT and elsewhere.

By presenting their work to each other, Rising Stars participants raised their visibility within the wide range of research in EECS. The scholars became familiar with MIT and were introduced to invited high-profile women in their fields – including senior women faculty in the EECS department. Participants in Rising Stars were also made aware of the possibilities for ongoing collaboration and professional support following the experience. In addition to research presentations, the Rising Stars conferences feature panel discussions with faculty members, discussions about the interview and the promotion processes, and networking time for the participants to get to know each other and form connections that will likely persist through time.

Attendance increased to 40 in the 2013 workshop held at MIT. The workshop has generated significant interest nationally and the department has received several requests to host the workshop. The rising stars workshop was hosted by U.C. Berkeley in 2014 (with MIT as a co-sponsor). The workshop will return to MIT in early November 2015.

“The Rising Stars workshop was an amazing opportunity to chat with absolutely top professors about my research, to learn from insiders about how to thrive in an academic career, and to meet the next wave of world-class researchers in EECS.” — **Tamara Broderick, Rising Stars 2013, Assistant Professor at MIT**

“The Rising Stars workshop helped me understand thoroughly all the aspects of the job application process, so I can do my best at every step of this process.” — **Raluca Ada Popa, Rising Stars 2013, Assistant Professor at U.C. Berkeley**

“Attending the Rising Stars in EECS workshop answered many questions I had as to what is expected of faculty and provided insight into what exactly the role involves. It was also very encouraging to learn that there's a large support system focused on helping junior faculty succeed (not just sink or swim). So although the ramp up is steep, there are a lot of people and resources to help you get there. It was also really wonderful to meet so many impressive women across the breadth of EECS who are also just starting off in their careers.”
— **Vivienne Sze, Rising Stars 2012, Assistant Professor at MIT**

The Electrical and Computer Engineering Department Heads Association (ECEDHA) awarded the 2014 Diversity Award to Professor **Polina Golland** for her leadership role in creating the new annual “Rising Stars in EECS” workshop for women. The ECEDHA Diversity Award recognizes outstanding and proactive work to increase cultural, ethnic and gender diversity within the nearly 300 ABET accredited ECE departments across the U.S. and Canada that comprise the organization.



Research Lab News

**Minimizing Data Movement
in Multicore Systems** 26-27

Computation Obscura 28-29

Systemic Risk and Networks 30-31

**Towards Terahertz Integrated
Systems On Chip** 32-33

**Next Generation Video Coding:
more pixels, fewer bits, less watts** 34-35

Minimizing Data Movement in Multicore Systems

by Daniel Sanchez, Assistant Professor, Computer Science and Artificial Intelligence Lab

Technology trends are drastically changing the way we build computer systems. While Moore’s Law still provides an increasing amount of transistors per chip, transistor speed and energy efficiency are barely improving. To improve performance within a limited power budget, systems across all domains, from cellphones to supercomputers, are becoming more parallel, featuring an increasing amount of simpler and more efficient cores. But as computation becomes more efficient, systems face the fundamental costs of data movement. Memory accesses and communication have become orders of magnitude more expensive than basic compute operations. Yet current architectures still use techniques and abstractions designed decades ago, when computation was expensive and data movement was cheap, so they are organized in a way that causes more data movement than needed. To overcome this challenge, my students and I are investigating *data-centric parallel architectures* that seek to minimize data movement as a primary design objective. Excessive data movement often stems from a disconnect between hardware and software, so we are taking a cross-layer approach that combines the strengths of hardware and software techniques to achieve gains that neither hardware-only nor software-only approaches can provide.

Current systems with few cores rely on rigid, hardware-managed memory hierarchies to reduce data movement. For example, Figure 1 shows the four-level memory hierarchy of a recent 8-core processor, including the latency and energy of accesses to each level. Each level provides a larger amount of slower and cheaper storage that is more expensive to access. Moreover, all levels but the last one are hardware *caches*, associative memories that transparently retain recently-accessed data. Memory accesses traverse all the levels until they find the data or reach (non-associative) main memory. Because main memory

accesses are so expensive, current multicores devote about half of chip area to caches. Most of this cache space is coalesced in a monolithic last-level cache shared among all cores. While this organization works reasonably well for systems with few cores, it scales poorly.

As the number of cores grows, it is far more efficient to distribute cache capacity across the chip. Figure 2 (next page) illustrates this organization, showing a 64-tile chip, where each tile has one core and a bank of the last-level cache. Each core has access to a small amount of capacity nearby and a larger amount of capacity further away. To reduce data movement, it is crucial that most accesses are served by nearby banks.

Most prior work has approached this problem by developing hardware techniques that adaptively place data close to the cores that use it. But hardware-only techniques suffer from two key shortcomings. First, software is often in a better position than hardware to place data, as it has better semantic knowledge about data usage. For example, the operating system knows what regions of memory are used by each thread. Second, how the last-level cache is managed has a large impact on the performance of the different threads and processes sharing the chip, and involves making tradeoffs, e.g., speeding up some threads at the expense of making others slower. Software should be able to control these tradeoffs to align them with system-level objectives, such as prioritizing critical applications over background processes.

To tackle the limitations of hardware-only approaches, we have designed Jigsaw [1], a distributed cache organization that gives software full control over the cache efficiently. First, software classifies memory regions into logical partitions, or shares. In our implementation, the operating system performs this classification, so Jigsaw operates transparently to applications. The OS maps thread-private data to per-thread shares, data shared by threads within a process to per-process shares, and data shared by multiple processes (e.g., OS code and data) to a single global share. This coarse-grain classification captures the semantic information that the OS has about memory usage. Shares could also be exposed to individual programs to capture application-level knowledge. Then, Jigsaw lets software divide each cache bank in multiple partitions, and combine multiple bank partitions to form virtual caches, each of which caches data from a specific share. Figure 3 (next page) shows an example division of banks into virtual caches.

Periodically, an OS runtime reconfigures the size and location of each virtual cache to minimize both expensive main memory accesses and on-chip traffic. To guide reconfigurations, cheap hardware monitors sample a small fraction of accesses to estimate the miss curve of each virtual cache. Miss curves capture how many off-chip accesses each virtual cache would

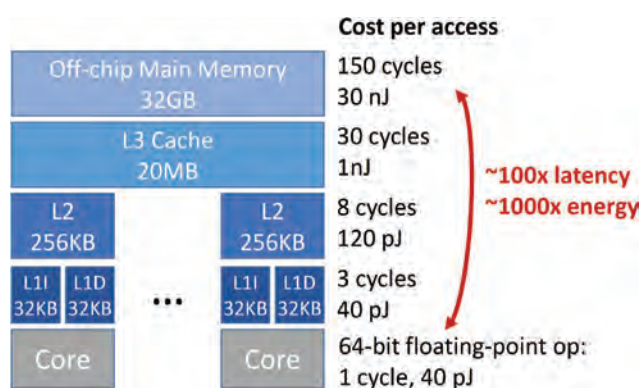

Figure 1: Current chips with few cores use hardware-managed hierarchies to reduce the cost of memory accesses. This figure shows the sizes, latency per access, and energy per access of an 8-core Intel E5-2670 chip running at 2.6 GHz.

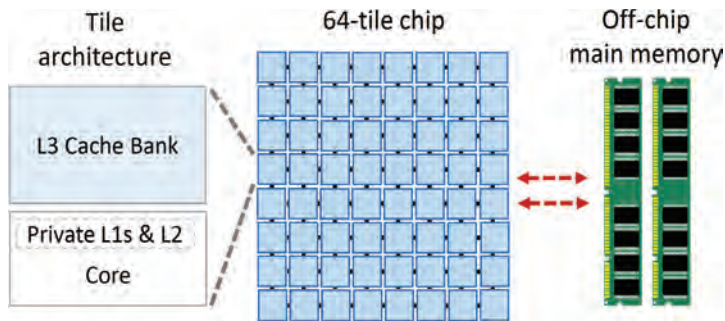

Figure 2: A tiled 64-core chip with a distributed cache hierarchy.

incur at each possible size. Miss curves make it easy for software to perform predictive optimization, finding the right size and placement of each virtual cache without trial and error. Efficient optimization algorithms allow software to reconfigure the cache every few milliseconds, quickly adapting to application changes. At 64 cores, Jigsaw improves performance over a conventional architecture by 38% on average, and reduces energy consumption by 34%. Jigsaw achieves these gains because it reduces both off-chip accesses to main memory (by 23%) and on-chip data movement (by 7x) [3]. Jigsaw yields larger improvements as the number of cores grows.

While Jigsaw seeks to reduce data movement by placing data close to the threads that use it, how threads are laid out across the chip greatly affects how well this can be done. For example, if two threads that need a lot of capacity to work well are running in nearby cores, they will contend for capacity at nearby banks and will be forced to place data further away. To solve this problem, we have developed computation and data co-scheduling (CDCS), a technique that jointly places threads and their data to further reduce data movement [3]. CDCS frees programmers and operating systems from managing thread placement, avoids the pathological behavior of fixed policies, and improves performance further, by 46% on average at 64 cores. The key challenge in CDCS is to find high-quality solutions with low overheads. Simultaneously placing computation and data is much more complex than placing data alone. The optimal solution is NP-hard, and the problem

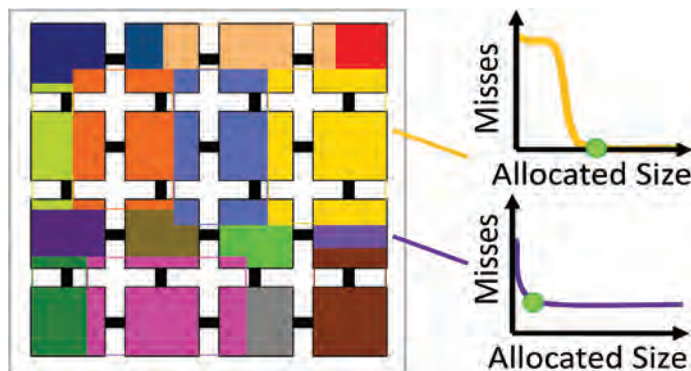

Figure 3: Jigsaw gangs physically distributed cache banks into virtual caches, which are sized to minimize cache misses and placed close to the threads that use them.

is similar in structure to VLSI place-and-route, where solvers use algorithms that are impractically expensive. Instead, we have designed a fast optimization algorithm that achieves within 1% of the performance of these expensive solvers, and runs in about one millisecond. This allows CDCS to continuously monitor and reconfigure the system with low overheads.

A constant challenge in our work is to make hardware predictable and easy to analyze, so that software runtimes can manage it efficiently and programmers can easily understand its performance. Analyzability becomes more crucial as systems become more heterogeneous and complex. Unfortunately, the conventional wisdom is that one needs to sacrifice analyzability for performance and efficiency. For example, in the past, caches implemented the least-recently-used (LRU) policy, which, on a miss, replaces the datum that was used furthest in the past. LRU is simple and predictable, but has common pathologies that cause poor performance. As a result, current chips use adaptive, empirically-designed policies that address LRU's most common pathologies. However, these policies sacrifice LRU's predictability, precluding software management. In Jigsaw and CDCS, we used LRU to allow software management, trading off efficiency for predictability. More recently, we have shown that no such tradeoff is needed. We have designed Talus [2], a technique that fixes performance pathologies and enables caches to yield smooth and predictable performance gains with additional space. Talus not only bridges the gap between LRU and high-performance policies, but also guarantees convex performance gains with additional space, allowing software to use much simpler and efficient convex optimization methods to manage them.

Though the techniques we have developed so far allow for more scalable and efficient systems, many challenges and opportunities to reduce data movement remain unexplored. While the architecture of chips in the far future is still an open question, achieving substantial efficiency gains will require further innovation across the stack, from reconfigurable memory systems that can accommodate diverse combinations of heterogeneous memory technologies, to new data-centric programming models that allow programmers to easily convey locality and parallelism while shielding them from unnecessary complexity. Addressing these challenges is the focus of our ongoing work.

References

- [1] N. Beckmann and D. Sanchez. Jigsaw: Scalable Software-Defined Caches. In Proc. PACT-22, 2013.
- [2] N. Beckmann and D. Sanchez. Talus: A Simple Way to Remove Cliffs in Cache Performance. In Proc. HPCA-21, 2015.
- [3] N. Beckmann, P.-A. Tsai, and D. Sanchez. Scaling Distributed Cache Hierarchies through Computation and Data Co-Scheduling. In Proc. HPCA-21, 2015.

Computation Obscura

by Vinod Vaikuntanathan, Steven and Renée Finn Career Development Assistant Professor, Computer Science and Artificial Intelligence Lab

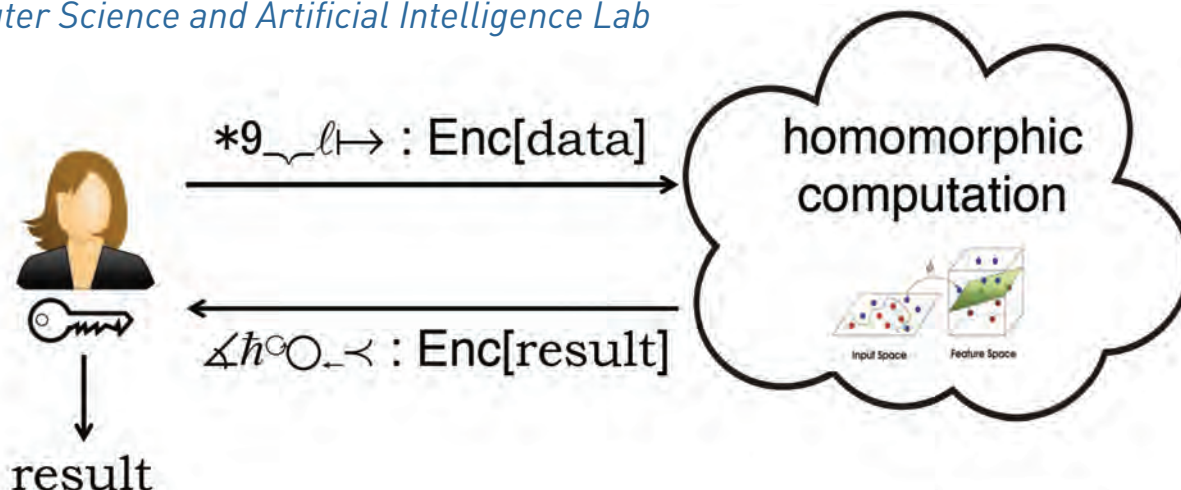

We live in a world of big data and constant communication. We exchange sensitive personal information through the internet, e-mails and phone calls. Individuals and organizations store and process this information on third party cloud services. All these transactions constitute an incredible treasure-trove of high-value data that malicious hackers, organizations and even powerful state actors could target and profit from. Against this backdrop, the need for encrypting our data seems like a no-brainer. Thanks to modern cryptography, we now have sophisticated algorithms and protocols that enable strong encryption and authentication.

Encrypting data is often compared to locking it inside an opaque box. Anyone with a key can unlock the box and “see” the data inside, but without the key, the box is completely opaque and perfectly immutable. Indeed this is quite an apt analogy for the use of encryption in secure communications and secure storage of data. But just as the analogy suggests, encryption is an all-or-nothing primitive: encrypted data betrays no information and is completely useless until it is decrypted. This is exactly what we want. Or, is it?

The new world of cloud computing requires us to adopt a more nuanced view of encryption, where privacy has to co-exist with usefulness. Not only do we store data on the cloud, we also perform computations on it, without transporting it back to our local machine. We are faced with what seems like an impossible fantasy: how can the cloud compute on encrypted data without decrypting it and without knowledge of the secret key?

The answer to this conundrum lies in a suite of cryptographic techniques collectively referred to as Computation Obscura. This includes fully homomorphic encryption, secure multiparty computation and functional encryption, techniques that help us achieve a fine balance between privacy and usefulness.

Homomorphic encryption is a special type of encryption system that allows us to perform computations on encrypted data without decrypting it. With homomorphic encryption, the cloud can store encrypted data and process it without ever “seeing” the data, the intermediate results of the computation, or even the output. A *fully* homomorphic encryption system is one that supports any computation, however complex, on encrypted data. This notion was first formulated by Rivest, Adleman and Dertouzos [1] in 1978, but a construction eluded cryptographers until Gentry’s work [2] in 2009.

The security of encryption systems is always based on unproven mathematical assumptions, such as the hardness of factoring large composite numbers. Initial constructions of fully homomorphic encryption, starting with the work of Gentry, were based on multiple new and untested cryptographic assumptions, which made their ultimate security questionable. Furthermore, the encryption schemes were astronomically inefficient. Private keys and ciphertexts in the encryption system were many gigabytes long, making it difficult even to store them in memory. Computations on encrypted data suffered enormous loss in efficiency, a factor of 10^{14} slow-down compared to computing on plaintext data.

During the last few years, we have invented new mathematical constructions of fully homomorphic encryption that perform several orders of magnitude better, and are based on standard, well-studied cryptographic assumptions. In particular our encryption system, invented together with Brakerski and Gentry [3, 4], is able to perform arbitrary computations on encrypted data with slowdown

factors of 10^5 to 10^6 , and special-purpose computations much faster. The system is a cornerstone of a large DARPA project aimed at building practical systems that compute on encrypted data. In the span of five years, homomorphic encryption technology has gone from being a distant dream to the point where it now has the potential to be practical.

To give a sense of how such encryption systems work, let us describe a very rough outline of the ideas underlying the construction. The starting point is to observe that complex computations can be broken down into simple units. Our units of computation will be addition and multiplication of numbers. The next item on the agenda is a way to encrypt numbers. There are many ways to do this, but here is a toy version of the system. Our private key will be a large prime number P (think thousands of digits). The encryption of a number M is simply $PQ + M$, where Q is also a very large number. Decrypting a ciphertext is easy: simply reduce the ciphertext modulo P . I will leave it to my mathematically enlightened reader to observe that operations on ciphertexts mirror operations on encrypted numbers. Adding two ciphertexts $PQ_1 + M_1$ and $PQ_2 + M_2$ adds the underlying numbers M_1 and M_2 , and multiplying the ciphertexts multiplies M_1 and M_2 .

Homomorphic encryption is only the beginning of the road. It is but one tool in a growing cryptographic toolkit that allows us to extract utility from data while preserving its privacy. Secure multiparty computation [5, 6], a technique from the 1980s, offers a way for multiple data owners to collaborate and compute a function on the aggregation of their data sets, without revealing their individual data. Although large data owners currently shy away from such collective computation, an efficient secure multiparty computation platform will enable them to collaborate while alleviating their concerns about privacy. A functional encryption system [7, 8] gives us expressive access control of encrypted data, allowing us to encrypt in such a way that we can reveal carefully chosen functions of the data to people with the right credentials.

In order to realize the tremendous potential of these technologies, we are actively investigating ways to make them faster and more efficient. Rather than focus on general purpose computations, our goal is to develop techniques for specific, useful classes of computations in areas such as statistics and machine learning.

Nowadays, one often hears about the tension between privacy and functionality, and between privacy and security. The implicit assumption in such assertions is that privacy of data is antithetical to deriving any usefulness out of it.

Modern cryptographic technologies such as homomorphic encryption, secure multiparty computation and functional encryption challenge such notions and demonstrate that, in many scenarios, the dichotomy between privacy and functionality is a false one. Sometimes, it appears, we can eat our cake and have it too.

References

- [1] Ronald Rivest, Leonard Adleman, and Michael Dertouzos. On Data Banks and Privacy Homomorphisms, In Foundations of Secure Computation, New York: Academic Press, 1978, pp. 169-180.
- [2] Craig Gentry. Fully Homomorphic Encryption using Ideal Lattices, In ACM Symposium on Theory of Computing, 2009, pp. 169-178.
- [3] Zvika Brakerski and Vinod Vaikuntanathan. Efficient Fully Homomorphic Encryption from (Standard) LWE, In IEEE Annual Symposium on Foundations of Computer Science, 2011, pp. 97-106.
- [4] Zvika Brakerski, Craig Gentry and Vinod Vaikuntanathan. (Leveled) Fully Homomorphic Encryption without Bootstrapping, In Innovations in Theoretical Computer Science, 2012, pp. 209-325.
- [5] Oded Goldreich, Silvio Micali and Avi Wigderson. How to Play any Mental Game or A Completeness Theorem for Protocols with Honest Majority, In ACM Symposium on Theory of Computing, 1987, pp. 218-229.
- [6] Michael Ben-Or, Shafi Goldwasser and Avi Wigderson. Completeness Theorems for Non-Cryptographic Fault-tolerant Distributed Computation, In ACM Symposium on Theory of Computing, 1988, pp. 1-10.
- [7] Dan Boneh, Amit Sahai and Brent Waters. Functional Encryption: A New Vision for Public-key Cryptography, In Communications of the ACM, 2012, pp. 56-64.
- [8] Shafi Goldwasser, Yael Tauman Kalai, Raluca Ada Popa, Vinod Vaikuntanathan and Nickolai Zeldovich. Reusable Garbled Circuits and Succinct Functional Encryption, In ACM Symposium on Theory of Computing, 2013, pp. 555-564.

Systemic Risk and Networks

by Asuman Ozdaglar, Professor, Director, Laboratory for Information and Decision Systems

On September 15, 2008, the investment bank Lehman Brothers filed for bankruptcy. What made this event cataclysmic for global financial markets was not that it was the largest bankruptcy filing in the United States, but that Lehman itself was yet one more domino in a financial crisis that had started more than a year earlier, with accumulating losses from subprime loans. Lehman's collapse immediately created financial distress for several large financial institutions that were its counterparties. The next financial institution to come to the brink of bankruptcy was the American Insurance Group (AIG), whose collapse would have meant its inability to pay its counterparties for the credit default swap arrangement it had made. These counterparties included, among others, Goldman Sachs and Deutsche Bank. Federal Reserve and Treasury officials, convinced that AIG's collapse would bring down scores of other financial institutions, intervened and bailed out AIG to stem the rapidly spreading financial contagion.

Of the many lessons learned by policymakers and academics from the turbulent weeks surrounding these events, the most important one is the danger of financial contagion, which can amplify small shocks into systemic risk and even a financial tsunami. But the lesson is only partial. More than six years after these momentous events, there is still a limited understanding of how financial contagion is created and what structures of financial interconnections ("network architecture") paves the way for systemic risk. In fact, many claims in the literature are contradictory. Some maintain, for example, that it is the sparseness of financial connections and the lack of diversified liabilities structures that underpin systemic risk because with more densely-connected financial networks, a negative shock to a bank would be spread across several counterparties, rather than one or two as in a sparse network, making contagion less likely. Yet others take the exact opposite perspective and blame the denseness of financial linkages for the spread of risks and contagion of failure in financial markets based on the argument that a negative shock to a bank can infect many more when this bank has many counterparties.

How can we make sense of these conflicting claims? What are the structural properties of financial networks that create systemic risk? Which financial institutions are systemically important and play an oversized role in financial contagion?

Recent research by Asu Ozdaglar and Daron Acemoglu (from MIT's Laboratory for Information and Decision Systems (LIDS), and Department of Economics, respectively) and their collaborator Alireza Tahbaz-Salehi (from the Business School at Columbia University) sheds light on these questions. This work considers an interconnected financial network in which each bank simultaneously lends and borrows from other banks and also has real assets (such as loans to firms and con-

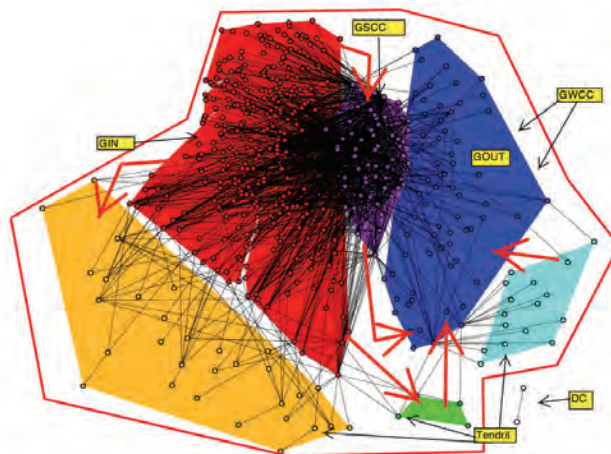

The network of loans among financial institutions (source: Bech and Atalay, 2008). The connections among financial institutions raise the possibility of cascades, where shocks to some units propagate, creating systemic risk (source: <http://intermarket-andmore.fianza.com/banche-usa-rischi-enormi-orizzonte-per-il-2011-21648.html>).

sumers) with stochastic returns. A bank makes the specified payments on its liabilities (the debts that it has taken on) as long as it can. When its income from its real assets combined with the payments it receives from loans to other financial institutions fall short of its obligations, however, that bank is forced to default (fully or partially). But once a bank defaults, this creates hardship on other banks expecting payments from it, creating the first step in a chain of dominoes — as was the concern in the fall of 2008 with the failure of AIG to make its payments to financial institutions such as Goldman Sachs and Deutsche Bank.

The central message that emerges from this analysis is that the nature of financial contagion together with the structural

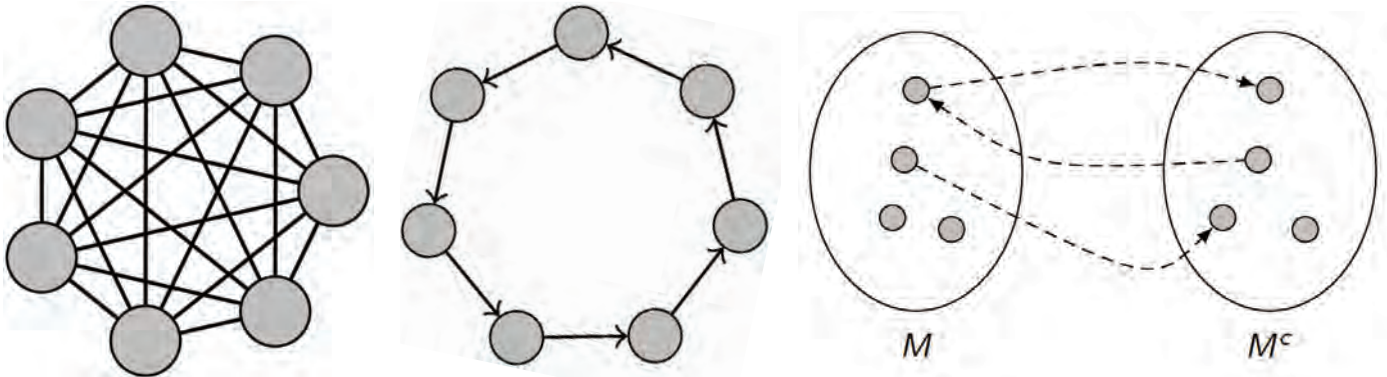

Which network structures minimize systemic risk?

properties of networks that make them susceptible to systemic risk, depend heavily on the magnitude of shocks hitting individual banks. When these shocks are small (for example, the assets of only one or a few banks are hit by relatively small shocks), diversification concerns are key, and thus more densely-connected financial networks are more stable and less prone to systemic risk. In contrast, financial networks that are sparse, such as rings, are the least stable ones. For example with every network, even a small negative shock to a single bank can start a chain reaction as this bank's default on its liabilities falls on the shoulders of its single creditor, and its single creditor's subsequent default then spreads to another bank and so on.

However, as the size of negative shock to some real assets exceeds a shock threshold, there is a phase transition, and the nature of systemic risk is transformed. In such large shock regimes, it is now densely-connected financial networks that are prone to contagion. The complete network, where each bank's liabilities are equally distributed across all other banks is the least stable one, because this large shock to a single bank now creates hardship to all of its creditors, bringing the entire banking system to its knees. In contrast, financial networks that create islands of weakly connected components are much more resilient against such large shocks. The reason why there is such a complete turnaround in what types of networks underpin systemic risk is related to the fact that densely-connected networks do not have a way of absorbing negative shocks by shifting some of it to senior creditors and thus make the entire shock transmit to other banks.

These insights also help us to understand the claim made by the deputy governor of the Bank of England, Andrew Haldane who suggested that highly interconnected financial networks may be "robust-yet-fragile" and that they "exhibit a knife-edge or tipping point property", in the sense that "within a certain range, connections serve as shock-absorbers [and] connectivity engenders robustness." However, beyond a certain range, inter-

connections start to serve as a mechanism for propagation of shocks, "the system [flips] the wrong side of the knife-edge," and fragility prevails. The pattern of financial contagion has this robust-yet-fragile feature emphasized by Haldane. Financial interconnections create stability in response to small shocks but become powerful dominoes when shocks are large.

Another important consequence of this analysis concerns the identification of systemically important banks, which has become a key regulatory concern since the financial crisis. Many practitioners and regulators have relied on applications of standard notions of network centrality, such as degree centrality or various eigenvector centrality measures including Bonacich centrality, for identifying such systemically important financial institutions. But many of these centrality measures are derived from models that have little to do with how financial contagion takes place. The micro-founded model of financial contagion teaches two key lessons about systemic importance. The first is that no unambiguous notion of systemic importance can be derived as witnessed by the fact that which institutions and which financial networks facilitate the chain reaction crucially depends on whether shocks are large or small (whether we are on one or the other side of the phase transition). The second is that even within a regime, different notions of centrality reflecting the exact nature of economic relations arise as the appropriate measures of systemic importance.

This research is obviously not the last word on contagion in financial networks. It nevertheless highlights how careful analytical modeling of economic relations in a networked setting can both pave the way to a comprehensive study of systemic risk and bring new insights on which structural properties of financial networks and which types of financial institutions might create future faultlines.

Towards Terahertz Integrated Systems On Chip

by Ruonan Han, Emanuel E. Landsman (1958) Career Development Assistant Professor, Microsystems Technology Laboratories

Terahertz frequency, broadly defined from 100 GHz to 10 THz, is an electromagnetic spectrum between microwave and infrared. The radiation in this frequency range has great potential in the applications of biomedical diagnosis, security screening, as well as high-speed communications. For instance, terahertz wave can propagate through non-metallic, non-polar materials with small attenuation. This property, combined with the small wavelength (compared to microwave) and low photon energy (compared to X-ray), makes terahertz wave an ideal option for non-ionizing medical imaging, such as burn injury assessment and skin cancer detection. Utilizing the molecular resonance in this frequency range, terahertz spectroscopy can help us identify hazardous gas (e.g. methylchloride) and warfare chemical agents (e.g. sarin) in a remote distance. It is also expected that wireless/wired data link operating at such broad, unallocated band will boost the transmission speed significantly and resolve the spectral congestion issues nowadays. As an example, using a 240-GHz carrier wave, researchers have demonstrated a 30-Gbps link over 40-m distance [J. Antes, et al, IMS 2013].

So why didn't we exploit this promising spectrum earlier? The main technical constraint is depicted as a "Terahertz Gap": terahertz frequency is too high for electronics mainly due to the limited carrier velocity and breakdown voltage of devices; meanwhile, it is too low for photonics due to the increased loss and the lack of materials with sufficiently small bandgap. As a result, the generated power level and signal detection sensitivity are the poorest among the entire electromagnetic spectrum. To address this issue, significant efforts and progress have been made in both electronics (e.g. devices based on high-mobility III-V semiconductors and vacuum tubes) and photonics (e.g. quantum-cascade lasers and photoconductive switches). However, these solutions are normally too bulky and costly, and lack of decent systematic integration capability. Some also require stringent operational conditions such as cryogenic cooling, which severely limit their applications.

The Terahertz Integrated Electronics research group, led by Prof. Ruonan Han, is focusing on filling such Terahertz Gap using integrated circuit technologies. In the past, we mostly relied on the most accessible platform in the semiconductor industry: silicon CMOS. Although silicon has an inferior speed property compared to many III-V compound semiconductor materials, the performance of silicon transistors has been improved steadily thanks to Moore's Law of technology scaling. Now the cutoff frequency of the main-stream CMOS technologies has reached 300 GHz, which makes the terahertz operation possible. Without a doubt, CMOS will drastically reduce the cost and size of current THz systems. Meanwhile, on the same die, terahertz components can be built with other analog/digital circuitries, enabling unprecedented levels of integration and flexibility. This will trigger tremendous opportunities in the portable equipment market, such as in-vivo tooth cavity detection and handheld breath analyzer for disease diagnostics.

On the other hand, however, we are facing great challenges in the design of terahertz integrated circuits. When a transistor operates near its cutoff frequency, the activity of the device becomes very weak. In order to achieve the maximum gain and to extract the highest power from the device, several optimum conditions have to be met simultaneously. This problem is exacerbated by the passive components and interconnects (such as resonant cavity and transmission lines) that are very lossy in the terahertz range. Lastly, to break the speed limits set by the cutoff frequency, we commonly resort to harmonic-signal generation (namely we distort the waveform as much as possible). The nonlinear analysis and optimization involved in this process further complicate the circuit design.

Figure 1. A terahertz radiator array with integrated phase-locking loop. Each unit inside the array enables maximum oscillation, optimum harmonic generation, as well as efficient on-chip radiation [R. Han, et al, ISSCC 2015].

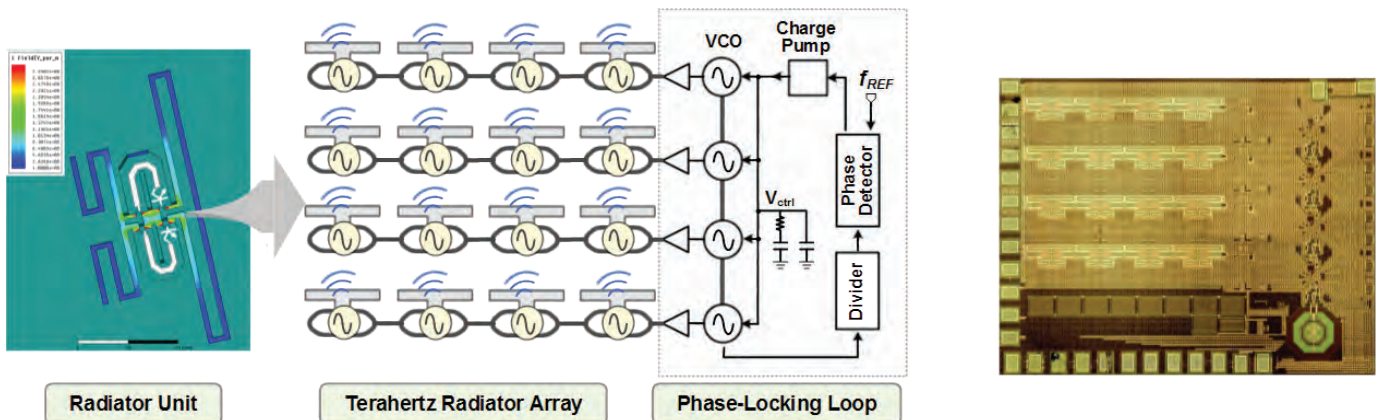

Next Generation Video Coding: more pixels, fewer bits, less watts

by Vivienne Sze, Emanuel E. Landsman (1958) Career Development Assistant Professor, Research Laboratory of Electronics

Over 60% of the bits that flow through the Internet today are used to transport video. This can be attributed to the growing popularity of applications such as video streaming, video conferencing and video surveillance. In addition, the amount of video content being generated is staggering: over 100 hours of video are uploaded to YouTube every minute; and over 400 petabytes of data, equivalent to 92 million DVDs, are collected from security cameras every day. The demand to transmit and store video continues to grow exponentially with the increasing number of low cost cameras and the diversity of video-based applications. Thus, advances in video compression, which enable us to represent video with fewer bits, and squeeze more pixels through bandwidth-limited channels, are critical in supporting both today and tomorrow's demand for video.

However, as we continue to push for higher coding efficiency, higher resolutions (e.g. Ultra-HD) and more sophisticated multimedia applications, the required number of computations per pixel, and the pixel processing rate, will grow exponentially. This poses significant power and performance challenges for battery-operated devices such as smart phones and tablets, as well as emerging devices such as wearable cameras and Internet of Things with cameras. For instance, the battery life of Google glasses is limited primarily due to video processing and computer vision [1]. Thus, next generation video compression systems not only need to deliver high coding efficiency, but also address implementation challenges such as power and throughput.

An effective approach to address the tight power and throughput requirements of video compression is through the use of parallelism. Parallelism can be used to increase pixels rate and any additional throughput can be traded-off for reduced power consumption with voltage scaling. Our earlier work showed that by using efficient architectures that exploit parallelism, the power consumption for decoding video sequences compressed using H.264/AVC, today's most widely used video compression standard,

can be reduced by a factor of 10x (Fig. 1, below) [2].

However, efficient architectures alone are not sufficient as the video compression algorithms limit the amount of parallelism that can be exposed. Video compression works by removing redundancy in the video sequences, which naturally introduces dependencies in the data. Accordingly, advanced compression algorithms that add a lot of dependencies for increased compression are more difficult to parallelize. An example of this is the entropy-coding engine of the video codec called Context-Adaptive Binary Arithmetic Coding (CABAC). Entropy coding is a form of lossless compression used at the last stage of video encoding (and the first stage of video decoding), after the video has been reduced to a series of syntax elements. Syntax elements describe how the video sequence can be reconstructed at the decoder. Entropy coding achieves compression by mapping elements to bits based on the probability of occurrence (e.g. in the English alphabet, you would assign fewer bits to vowels, and more bits to consonants); thus it is important to accurately model the probabilities of the elements in order to achieve high coding efficiency. CABAC uses several hundred probability models to capture the distribution of the various syntax elements and uses a sophisticated finite state machine to select the correct probability model for each element. The models are updated on-line during the compression and decompression process. Although CABAC delivers higher compression than alternative entropy coding approaches, the complex probability model selection and update lead to tight data dependencies in the form of feedback loops (Fig. 2); this limits the overall throughput of the video codec making it difficult to achieve the desired pixel rate or trade-off the throughput for increased battery life. throughput of the video codec making it difficult to achieve the desired pixel rate or trade-off the throughput for increased battery life.

Figure 1: (Left) Die photo of low power decoder test chip; (Right) Setup of real-time HD video decoding system [2].

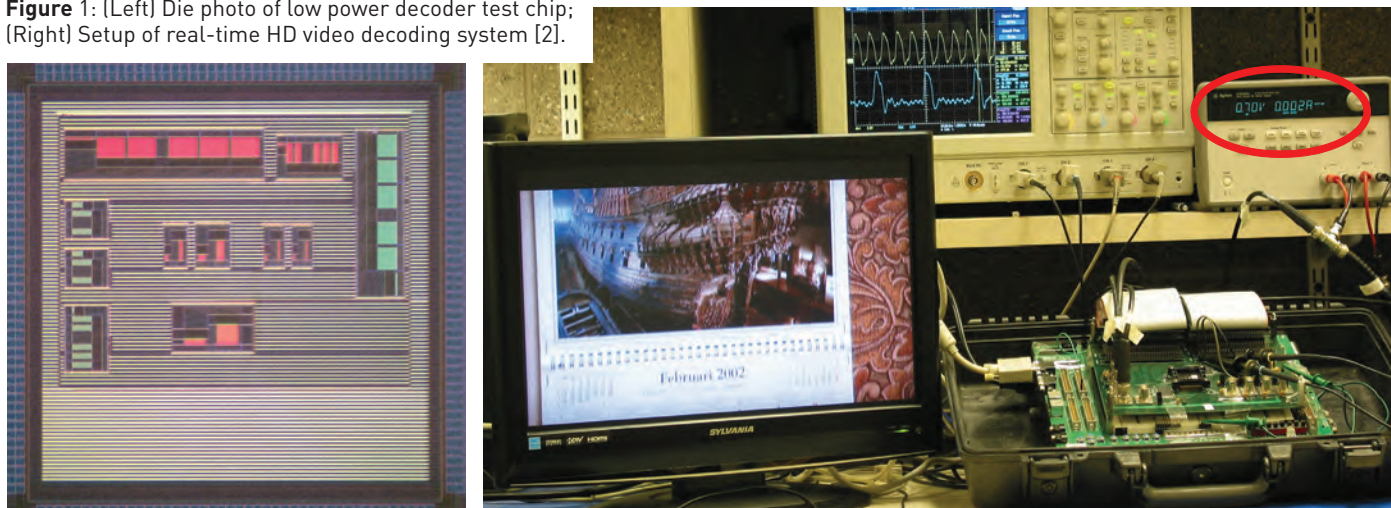

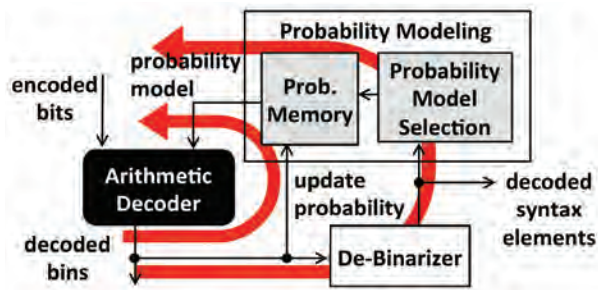

Figure 2: Feedback loops in CABAC entropy decoding engine.

Accordingly, the CABAC was re-designed using joint algorithm and architecture optimization to increase throughput while maintaining high coding efficiency. One key insight was that the encoded data could be reorder such that the dependencies within the feedback loops could be reduced and enable multiple loops to run in parallel. Removing dependencies also reduced memory accesses, which sped up each of the loops. The new CABAC algorithm was able achieve over 10x higher throughput compare to state-of-the-art H.264/AVC CABAC implementations [3], which translates to a 3x power reduction when combined with voltage scaling. Several concepts from this work (e.g. simplified probability model selection, line memory reduction and wavefront parallel processing based on interleaved entropy slices) were adopted into the latest video coding standard High Efficiency Video Coding (HEVC) [4], a.k.a. H.265. Based on these design principles, HEVC contains multiple built-in implementation-friendly features while still delivering 50% higher coding efficiency compared to its predecessor H.264/AVC [5, 6]. HEVC is now being deployed on numerous devices (e.g. televisions, phones, set-top boxes).

In the Energy-Efficient Multimedia Systems Group, we are investigating the use of optimization methods to further improve the coding efficiency and reduce the power consumption of next-generation of video compression systems that could be incorporated into future standards (e.g. 'H.266'). While video compression continues to be a challenge that needs to be addressed, many of the emerging video-driven applications do not require the complete reconstruction of the

compressed video. Instead, it may be sufficient to extract and store/transmit only the relevant information from the video rather than the pixels for the video itself, which can result in much more significant compression. For instance, in retail and traffic surveillance applications, it may necessary to only store/transmit the number of customers or vehicles that appeared in the video over a certain time period. The processing required to extract the desired information typically occurs near the camera, where energy is constrained. Thus, we are also investigating low power methods of extracting this information using computer vision algorithms such object detection and recognition. In our recent work, we showed that processing the gradient image rather than the original pixels (Fig. 3) reduces the energy cost of image scale generation, required for detecting objects of different sizes, by 43% with only a 2% reduction in detection accuracy [7]. Enabling real-time energy-efficient video processing can impact a wide range of emerging video-based applications ranging from improved safety through elderly assistance, advanced driver assistance systems and crime prevention to increased efficiency through structural monitoring, smart homes, navigation of unmanned vehicles and traffic control.

[1] E. Ackerman. (2013, January) IEEE Spectrum. [Online]. <http://spectrum.ieee.org/consumer-electronics/gadgets/google-gets-in-your-face>
 [2] V. Sze, D. Finchelstein, M. E. Sinangil, A. P. Chandrakasan, "A 0.7-V 1.8-mW H.264/AVC 720p Video Decoder," IEEE Journal of Solid-State Circuits, November 2009.
 [3] V. Sze, A. P. Chandrakasan, "A highly parallel and scalable CABAC decoder for next generation video coding," IEEE Journal of Solid-State Circuits, January 2012.
 [4] V. Sze, M. Budagavi, "High-Throughput CABAC in HEVC," IEEE Transactions on Circuits and Systems for Video Technology, Dec. 2012.
 [5] V. Sze, M. Budagavi, G. J. Sullivan, "High Efficiency Video Coding (HEVC) – Algorithms and Architectures," Springer, 2014.
 [6] ITU-T and ISO/IEC, ITU-T Rec. H.265 and ISO/IEC 23008-2: High Efficiency Video Coding, April 2013.
 [7] A. Suleiman, V. Sze, "Energy-Efficient HOG-based Object Detection at 1080HD 60 fps with Multi-Scale Support," IEEE International Workshop on Signal Processing Systems (SiPS), October 2014.
 [8] INRIA Persons Dataset <http://pascal.inrialpes.fr/data/human/>

Figure 3: (Left) Original figure from INRIA Persons Dataset [8]. (Right) Perform gradient pre-processing of image before object detection to reduce energy consumption.

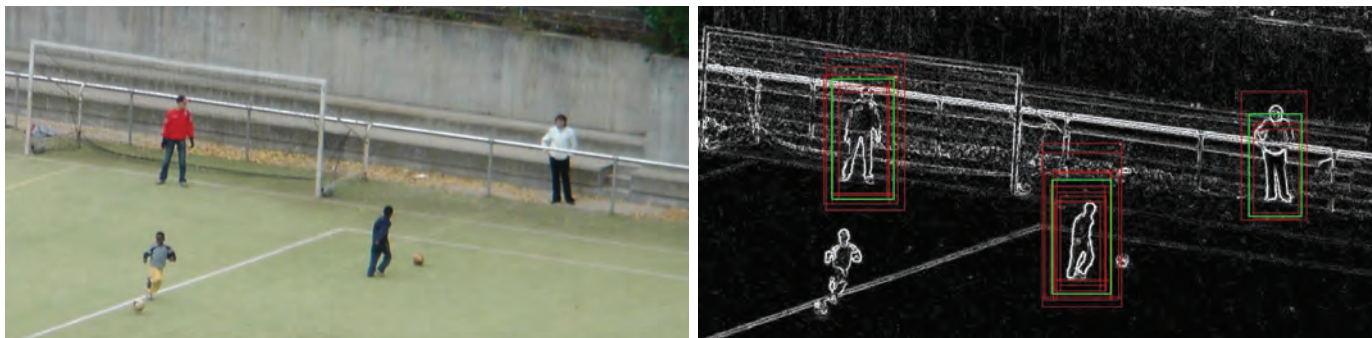

Faculty Features

Faculty Awards in the past year include the Presidential Medal of Freedom and the IEEE Medal of Honor to Mildred Dresselhaus, and more

37-39

Faculty Fellowships, Chairs, New Faculty, Leadership Appointments

40-49

**In Memory of Seth Teller
Shaoul Ezekiel, and Jack Ruina**

**50
51**

Faculty Awards



Dimitri Antoniadis

2014 SRC Aristotle Award;
2015 IEEE Jun-ichi Nishizawa Medal



Arvind

Elected to India National Academy of
Sciences (Foreign Fellow)



Hari Balakrishnan

2015 National Academy of Engineering



Dimitri Bertsekas

2014 American Automatic Control Council
Richard Bellman Heritage Award



Sangeeta Bhatia

2014 Winner of \$500,000 Lemelson-MIT
Prize; 2015 National Academy of En-
gineering; One of Foreign Policy's 100
Leading Global Thinkers



Rodney Brooks

2014 Engelberger Award for Leadership
Robotics Industries Association;
2014 IEEE Robotics and Automation



Anantha Chandrakasan

2015 National Academy of Engineering



Jesús del Alamo

2014 Fellow American Physical Society;
Recipient of 2015 Bose Research Grant



Srinivas Devadas

Elected 2014 Fellow of Association for
Computing Machinery (ACM)

Faculty Awards, *continued*



Mildred S. Dresselhaus

2014 Presidential Medal of Freedom;
IEEE 2015 Medal of Honor



James Fujimoto

Awarded Honorary Doctorate at Nicolaus
Copernicus University, Poland;
2015 OSA Frederic Ives Medal



W. Eric L. Grimson

Elected 2014 Fellow of Association for
Computing Machinery (ACM)



Polina Golland

2014 ECEDH Diversity Award



Qing Hu

2015 Optical Society (OSA) Nick Holonyak
Jr. Award



Franz Kaashoek

2014 MIT Earl M. Murman Award for Ex-
cellence in Undergraduate Advising



Charles E. Leiserson

2014 ACM/IEEE Computer Society Ken
Kennedy Award

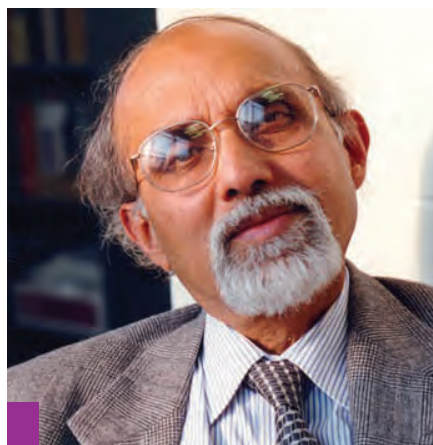

Sanjoy Mitter

2015 IEEE Eric E. Sumner Award



Robert Morris

Elected 2014 Fellow of Association for
Computing Machinery (ACM)



Rajeev Ram

Elected 2014 Fellow of the Optical Society (OSA); Recipient of 2015 Bose Research Grant

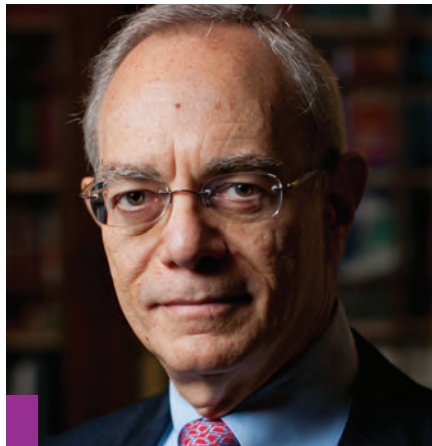

L. Rafael Reif

2015 National Academy of Engineering



Ronitt Rubinfeld

Elected 2014 Fellow of Association for Computing Machinery (ACM)



Daniela Rus

Elected 2014 Fellow of Association for Computing Machinery (ACM);
2015 National Academy of Engineering



Daniel Sanchez

2015 NSF Faculty Early Career Development (CAREER) Award



Madhu Sudan

2014 Infosys Prize in Mathematical Sciences



Vivienne Sze

2014 DARPA Young Faculty Award



Vinod Vaikuntanathan

2014 Microsoft Research Faculty Fellow



Nickolai Zeldovich

2014 Harold E. Edgerton Faculty Achievement Award

Faculty Awards, *continued*

Five EECS Faculty are elected to the NAE and ACM, and Mildred Dresselhaus receives the Presidential Medal of Freedom and the IEEE Medal of Honor

In January 2015, a record five MIT Computer Science and Artificial Intelligence Lab (CSAIL) EECS faculty members were elected as Fellow to the Association for Computing Machinery. **Srini Devadas**, **Eric Grimson**, **Robert Morris**, **Ronitt Rubinfeld** and **Daniela Rus** were selected for “providing key knowledge” to computing.

In February 2015, a record five members of the MIT EECS Department (out of eight total MIT faculty) were elected to the National Academy of Engineering. **Hari Balakrishnan**, the Fujitsu professor in Electrical Engineering and Computer Science, was cited for his contributions to wired and wireless networks and distributed systems; **Sangeeta Bhatia**, the John and Dorothy Wilson Professor of Health Sciences and Technology and Electrical Engineering and Computer Science, was cited for her work in tissue engineering and tissue-regeneration technologies, stem-cell differentiation, and preclinical drug evaluation; **Anantha Chandrakasan**, the Joseph F. and Nancy P. Keithly Professor in Electrical Engineering, was cited for his work on the development of low-power circuit and system design methods; **L. Rafael Reif**, President of MIT was cited for his technical and educational contributions, and for university leadership; and **Daniela Rus**, the Andrew and Erna Viterbi Professor in the Department of Electrical Engineering and Computer Science and the Director of CSAIL, was cited for contributions to distributed robotic systems.



In November 2012 Institute Professor **Mildred Dresselhaus** was recognized by the US Department of Energy with the Enrico Fermi Award — for her leadership in condensed matter physics, in energy and science policy, in service to the scientific community, and in mentoring women in the sciences — followed a few months later by the Kavli Prize for her pioneering contributions to the study of phonons, electron-phonon interactions and thermal transport in nanostructures.

In December 2014, as Dresselhaus was receiving the Presidential Medal of Freedom in the White House from President Obama, the IEEE announced the recipient for its highest award. In honoring Dresselhaus with the 2015 IEEE Medal of Honor, the IEEE cited her “For leadership and contributions across many fields of science and engineering.” She is the first woman to receive this honor.

Dresselhaus continues her research with dedication and excitement. “Throughout my career,” she notes, I have been interested in finding out how the unique properties of new materials beyond silicon could contribute to electronics. My recent research interests involve layered materials like the semimetal graphene, the related wide gap semiconductor hexagonal boron nitride in its few layered form, the few layered transition metal dichalcogenides which offer a wide variety of properties from semiconductors to metals, to Phosphorene which is a puckered layer semiconductor.”

Faculty News: FRIFs

Faculty Research and Innovation Fellowships

Two new FRIFs are awarded in 2014



Three 2014-2015 Faculty Research Innovation Fellowships (FRIF) were announced by Department Head Chandrakasan in early October. The FRIF was established in 2011 to recognize mid-career EECS faculty members for outstanding research contributions and international leadership in their fields. The FRIF provides tenured, mid-career faculty in the department with resources to pursue new research and development paths, and to make potentially important discoveries through early stage research. "We are grateful to the generous contributors who have made these awards possible," Chandrakasan said.

The *Peter Levine Faculty Research Innovation Fellow* donated by **Peter Levine**, a partner at the venture capital firm Andreessen Horowitz, was awarded to Professor Rob Miller. The *Frank Quick Faculty Research Innovation Fellow*, donated by EECS alumnus **Frank Quick '69, SM '70**, was awarded to Professor Joel Voldman. Professor Collin Stultz is the recipient of this year's *Steven G. '68, SM '69, EE '70, ScD '75, and Renée Finn Faculty Research Innovation Fellowship*, donated by **Steven and Renée Finn**.

Professor **Rob Miller '95** (top image left) is a member of CSAIL where he heads the User Interface Design Group and focuses his research on human-computer interaction and crowd computing. He has contributed to professional programming by designing tools with appropriate user interfaces such as Theseus, a new type of JavaScript debugger that makes dynamic information visible in the code editor. A MacVicar Faculty Fellow, Professor Miller has been at the core of developing and adapting online education on campus. With the launch of the XSeries courses, for example, members of his group have been studying how to make video lectures more effective for learning, how to develop self-generating tutoring systems based on students' trial-and-error problem solving and how to improve in-class activities.

Professor **Collin Stultz** (middle image, left) is a principal investigator in RLE and a member in the Institute for Medical Engineering and Science (IMES). A practicing cardiologist, Professor Stultz focuses on conformational changes in macromolecules and the effect of structural transitions on common human diseases such as Parkinson's and heart disease. Under his leadership, the Computational Biophysics Group uses an interdisciplinary approach in this work, utilizing techniques drawn from computational chemistry, signal processing, and basic biochemistry. Professor Stultz has co-lead the department's recent undergraduate curriculum development, creating 6.S02, a medical-based technology introduction to EECS. He is a recipient of the Burroughs Wellcome Fund Career Award in Biomedical Sciences and the James Tolbert Shipley Prize.

Professor **Joel Voldman** (lower image left) is a principal investigator in MTL and RLE and works to understand the most basic interactions between single cells – building on various disciplines including electrical engineering, microfabrication, bioengineering, transport modeling, biology and medicine. Under his leadership, members of the Biological Microtechnology and BioMEMS Group engineer cutting-edge approaches to stem cell signaling, point of care therapeutics and neuroengineering. As one of three co-founders and co-directors of the Medical Device Realization Center (MEDRC) at MIT, Professor Voldman has directed the use of microfluidics technologies to detect protein biomarkers using portable all-electronic immunoassays. Professor Voldman has also served the EECS department as faculty advisor for the new undergraduate research conference known as EECScon.

Faculty News: Chair Appointments

Munther A. Dahleh is appointed to the William A. Coolidge Professorship



Electrical Engineering and Computer Science (EECS) Department Head Anantha Chandrakasan announced the appointment of Professor Munther A. Dahleh to the William A. Coolidge Professorship at MIT in late May 2014.

William A. Coolidge, a Harvard College graduate (1924) and founder and chair of the National Research Corporation, was a devoted member of the MIT Corporation (from 1948, as a term member, to his appointment as a Life Member Emeritus in 1976). The professorship was established in 1988 in recognition of Mr. Coolidge's years of thoughtful advice and generosity to MIT.

A star in his research field, Munther Dahleh has driven new problem areas in large-scale, heterogeneous, interconnected systems. He is an exceptional teacher and mentor. He has also made outstanding contributions to service in the past few years as the Associate and Acting Director of LIDS, Associate Head of EECS, and currently as the Acting Director of ESD, and Director-designate of a potential new organization that would incorporate the people and programs of ESD, LIDS, and a significant new initiative in statistics.

Prof. Dahleh's research is broadly in the area of systems and control, with specific interest in distributed systems. He was already recognized early in his career as an exceptional talent in this field, particularly through his ground-breaking theoretical work in robust feedback control and his practical applications in autonomous systems, automotive systems, and neuroscience. These accomplishments led to his winning the prestigious Donald P. Eckman Award in 1993, for the best control engineer under the age of 35.

Prof. Dahleh has made foundational contributions in at least three areas of control: (a) robust control theory, especially through the L^1 -optimal control paradigm; (b) fundamental performance limitations for feedback control in the presence of communication constraints; and (c) learning and control in networked environments. His contributions with his students and collaborators in these areas were recognized by three Axelby Outstanding Paper Awards for papers in the IEEE Transactions on Automatic Control.

In his current research, Prof. Dahleh focuses on the foundational theory necessary to understand systemic risk in interconnected systems. He is also involved in a number of related application domains, including transportation systems, financial systems, the future power grid, and social networks. His work draws from various fields including game theory, optimal control, distributed optimization, information theory, and distributed learning. His collaborations include faculty from all five schools at MIT.

Munther Dahleh is an outstanding teacher and has made important educational contributions. He was recognized with the MIT Graduate Council Teaching Award (1995). He has been the lead instructor in 6.003 Signals and Systems and 6.041 Probabilistic Systems Analysis, and has helped create subjects that span traditional areas, including 6.435 Statistical Inference and Systems Identification. In collaboration with Prof. Asu Ozdaglar he developed 6.207 Networks, which is jointly listed with economics.

As EECS Associate Head (2011–2013), Prof. Dahleh helped develop strategic hiring directions for EECS, created a more unified EE structure, and in collaboration with Professor Leslie Kolodziejski solidified guaranteed support for all incoming EECS graduate students. He has also done a tremendous job in his current role to define the vision for a new entity combining ESD, LIDS and Statistics. He currently serves as the chair of the Committee on Discipline, and has contributed deeply to the MIT student community.

Two Chair Appointments are announced in EECS

*Qing Hu is inaugural holder of new chair: the Distinguished Professor of Electrical Engineering and Computer Science
Charles Leiserson becomes the Edwin Sibley Webster Professor*

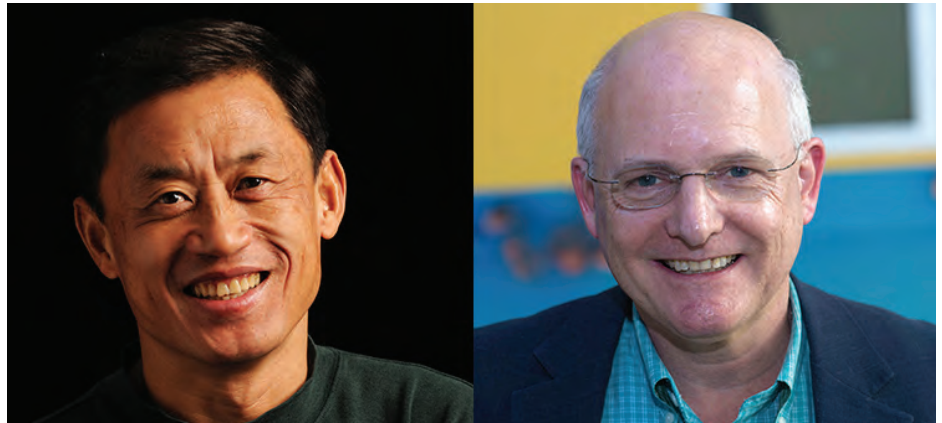

EECS Department Head Anantha Chandrakasan announced in early fall 2014 the appointments of Qing Hu as Distinguished Professor of Electrical Engineering and Computer Science and of Charles E. Leiserson as Edwin Sibley Webster Professor of Electrical Engineering and Computer Science.

Professor Hu, [photo left] the inaugural holder of the Distinguished Professor of Electrical Engineering and Computer Science, has made significant contributions to physics and device applications over a broad electromagnetic spectrum, from millimeter wave, through terahertz (THz), to infrared frequencies. His research has involved technology development for detectors and sources, as well as system-level imaging and sensing applications. A most distinctive contribution is his development of high-performance THz quantum cascade lasers. This breakthrough has already found applications in sensing and real time THz imaging, which was also pioneered by his group. He is a Fellow of the Optical Society of America (OSA), of the American Physical Society (APS), of the IEEE, and of the American Association for the Advancement of Science (AAAS). He is the recipient of the 2012 IEEE Photonics Society William Streifer Scientific Achievement Award. He has been an Associate Editor of Applied Physics Letters since 2006, and was the co-chair of the 2006 International Workshop on Quantum Cascade Lasers.

In addition to his research, Professor Hu has also made important contributions to the department in service and teaching. He has served on the EECS faculty search committee during 2008-2011, the EECS ABET committee during 2012-2013, and the personnel committee since 2012. He has taught a broad range of courses, including signals and systems (6.003), microelectronic devices and circuits (6.012), electromagnetics (6.013/6.014), quantum mechanics (6.017 prior to 1995), and solid-state physics (6.730 and 6.732).

Professor Leiserson [photo right] will be occupying a chair held over its sixty years by a succession of distinguished faculty in the department, including Ernst Guillemin in 1960, Lan Jen Chu in 1963, Peter Elias in 1974, Ronald Rivest in 1992, and most recently Alan Willsky. The Edwin Sibley Webster chair is also currently held by Professor Srinivas Devadas. Professor Leiserson's research centers on algorithms and parallel computing. He wrote the first paper on systolic architectures, devised the retiming method of digital-circuit optimization, invented the fat-tree interconnection network, introduced the notion of cache-oblivious algorithms, and developed the Cilk multithreaded programming technology, which incorporated the first provably efficient work-stealing scheduler. Many of Professor Leiserson's inventions have been embodied in industrial artifacts.

In parallel with his seminal contributions to computer science and engineering, Professor Leiserson has made important contributions in education within the MIT community and beyond. His annual workshop on Leadership Skills for Engineering and Science Faculty has educated hundreds of faculty at MIT and around the world in the nontechnical issues involved in leading technical teams in academia. He has taught widely in the EECS undergraduate curriculum — including 6.001, 6.002, 6.004, 6.032, 6.033, 6.042, 6.045, 6.046, 6.172 — and led the development of 6.042, 6.046, and 6.172. He has also taught graduate subjects in algorithms, VLSI theory, and parallel computing, as well as led the Singapore-MIT Alliance distance-education program in computer science. He is well known for coauthoring Introduction to Algorithms, one of the most cited and best selling textbooks in computer science. Professor Leiserson has been recognized for his educational and research contributions with the ACM/IEEE Computer Society 2014 Ken Kennedy High-Performance Computing Award, the IEEE Computer Society 2014 Taylor L. Booth Education Award, and the ACM 2013 Paris Kanellakis Theory and Practice Award.

New Faculty in EECS

Welcoming Six new Faculty in EECS



Mohammad Alizadeh will join the EECS department as an Assistant Professor of Computer Science in September 2015. He completed his graduate studies at Stanford University, earning his MS and PhD degrees in Electrical Engineering in 2009 and 2013, respectively. Before that, he received his BS in Electrical Engineering from Sharif University of Technology, Iran. In April 2012, he joined networking startup, Insieme Networks, where he developed algorithms for Insieme's next generation datacenter network products. He was a principal engineer at Cisco Systems following its acquisition of Insieme Networks in December 2013.

Mohammad's research interests are in the areas of computer networks and systems. His research strives to improve the performance, scalability, and ease of management of future networks and cloud computing systems. His recent projects focus on architectures and algorithms for large-scale datacenters, particularly, high performance networks for real-time web and big data applications. He is also broadly interested in the modeling and analysis of computer systems and bridging theory and practice in computer system design. His research has garnered significant industry interest: his work on datacenter transport mechanisms has been implemented in commercial (Windows Server 2012) and open source (Linux) operating systems and was used in the development of the IEEE 802.1Qau standard; most recently, his research on adaptive network load balancing has been implemented in Cisco's flagship Application Centric Infrastructure products.

Mohammad is a recipient of the Caroline and Fabian Pease Stanford Graduate Fellowship, the Numerical Technologies Inc. Prize and Fellowship, a Stanford Electrical Engineering Departmental Fellowship, and a SIGCOMM Best Paper award.



Tamara Broderick is an Assistant Professor in the Department of Electrical Engineering and Computer Science at MIT. She is also a member of the MIT Computer Science and Artificial Intelligence Laboratory (CSAIL). She completed her PhD in Statistics at the University of California, Berkeley in 2014. Previously, she received an AB in Mathematics from Princeton University (2007), a Master of Advanced Study for completion of Part III of the Mathematical Tripos from the University of Cambridge (2008), an MPhil by research in Physics from the University of Cambridge (2009), and an MS in Computer Science from the University of California, Berkeley (2013).

Tamara's recent research has focused on developing and analyzing models for scalable, unsupervised machine learning using Bayesian nonparametrics. One side of her research demonstrates how to retain the strengths of the Bayesian paradigm (such as flexible modeling and coherent treatment of uncertainty) and nonparametric analysis while simultaneously enabling fast, and even streaming, inference on large data sets. Additionally, her work provides a broader perspective on the kinds of models that populate a toolbox for Bayesian nonparametric analysis. Much of unsupervised learning has focused on clustering, where the goal is to discover a collection of latent groups, called clusters, such that each data point belongs to exactly one such group. Tamara has developed theory and methodology for a variety of extensions to clustering. For instance, *feature allocations* allow data points to belong to multiple groups—an idea which more accurately captures that an individual might belong to multiple friend groups in a social network, a document in a corpus might be described by multiple themes, or a customer's purchases might correspond to multiple interests.

Tamara has been awarded the Evelyn Fix Memorial Medal and Citation (for the PhD student on the Berkeley campus showing the greatest promise in statistical research), the Berkeley Fellowship, an NSF Graduate Research Fellowship, a Marshall Scholarship, and the Phi Beta Kappa Prize (for the graduating Princeton senior with the highest academic average).

Ruonan Han joined the EECS department at MIT as an assistant professor in July 2014. He received his BSc degree in microelectronics from Fudan University in 2007 and his MSc degree in electrical engineering from the University of Florida in 2009. In 2014, he received the PhD degree in electrical and computer engineering (ECE) from Cornell University, where he also won the ECE Innovation Award and the Director's Best Thesis Research Award. He is the recipient of IEEE Solid-State Circuits Society Pre-Doctoral Achievement Award and IEEE Microwave Theory & Techniques Society Graduate Fellowship Award.

Ruonan's research interest is ultra-high-speed integrated circuits and systems. At MIT, his research group will investigate microelectronic approaches to bridge the least explored Terahertz Gap (0.1–10THz) between microwave and infrared spectrum. Such effort is expected to revolutionize the electronic infrastructures for tera-scale communications, biomedical imaging and chemical sensing. Meanwhile, it helps us to better understand and push the fundamental limits of electronics, such as radiation power, detection sensitivity and energy efficiency, under extremely high frequency conditions.



Stefanie Jegelka joined the EECS Department in January 2015 as an Assistant Professor and a member of CSAIL. She studied Computer Science (Bioinformatics) at the University of Tuebingen in Germany and at the University of Texas at Austin, and received a Diploma with distinction in 2007. In 2012, she received a PhD in Computer Science from ETH Zurich, in collaboration with the Max Planck Institute for Intelligent Systems and the University of Washington. From 2012 to 2014, she was a postdoctoral researcher in the EECS Department at the University of California Berkeley. In addition, she has been a research visitor at Microsoft Research Redmond, Georgetown University Medical Center and INRIA Paris.

Stefanie's research interests lie in machine learning. Her work focuses on the computational challenges that arise from learning problems with complex variable interactions and discrete structure. In particular, her research has addressed scalable and parallelizable algorithms for discrete optimization problems in machine learning and computer vision, kernel methods, and the design of new models that exploit the mathematical structure of submodular set functions, a discrete analog of convex functions.

Stefanie has given several tutorials on Discrete Optimization and Submodular Functions in Machine Learning at conferences and summer schools, and has organized five workshops on the topic. Among other fellowships, she has been a fellow of the German National Academic Foundation, and has received a Best Paper Award at the International Conference on Machine Learning.



Faculty News, *continued*

Welcoming Six new Faculty in EECS, *continued*



Aleksander Madry joined the EECS Department in February 2015 as an Assistant Professor of Computer Science and a member of CSAIL. He received his SM and PhD in Computer Science from MIT in 2009 and 2011, respectively. Prior to joining the MIT faculty, he spent a year as a postdoctoral researcher at Microsoft Research New England and then almost three years as a faculty at the Swiss Federal Institute of Technology in Lausanne (EPFL).

Aleksander's research centers on tackling fundamental algorithmic problems that are motivated by real-world optimization. Most of his work is concerned with developing new ideas and tools for algorithmic graph theory. His focus in this context is on applying a mix of combinatorial and linear-algebraic techniques to tackle central challenges in the area. This approach enabled him, in particular, to make the first progress in decades on classic graph questions such as the maximum flow problem and the bipartite matching problem.

In addition to his work on algorithmic graph theory, Aleksander is also keenly interested in understanding uncertainty in the context of optimization — how to model it and cope with its presence.

Aleksander has received a variety of awards for his research, including the Association for Computing Machinery (ACM) Doctoral Dissertation Award Honorable Mention, the George M. Sprowls Doctoral Dissertation Award, and a number of best paper awards at the Foundations of Computer Science, the Symposium on Discrete Algorithms, and the Symposium on Theory of Computing meetings.



Matei Zaharia joined the EECS Department in March 2015 as an Assistant Professor and a member of CSAIL. He received his B.Math. in Computer Science from the University of Waterloo in 2007, and his PhD in Computer Science from the University of California, Berkeley in 2013. Starting in 2013, he has been serving as CTO of Databricks, the big data analysis startup commercializing the popular open source platform Apache Spark.

Matei's research is in systems and programming models for large-scale distributed computing. He developed scheduling algorithms that are widely used in data processing software such as Hadoop, as well as the Apache Spark cluster computing engine, which is now one of the largest open source projects in big data, and the Apache Mesos cluster manager, now used at Twitter and other large Internet companies.

Matei has received multiple awards including the David J. Sakrison Prize for research at UC Berkeley in 2013, Best Paper awards at SIGCOMM 2012 and NSDI 2012, the University of Waterloo Faculty of Mathematics Young Achievement Medal in 2014, a Google PhD Fellowship, and the National Sciences and Engineering Research Council of Canada (NSERC) Julie Payette Research Scholarship.

Faculty Leadership News

EECS co-Education Officers Amarasinghe and White are succeeded by Lee and Miller; Berggren succeeds Leeb as UG Laboratory Officer

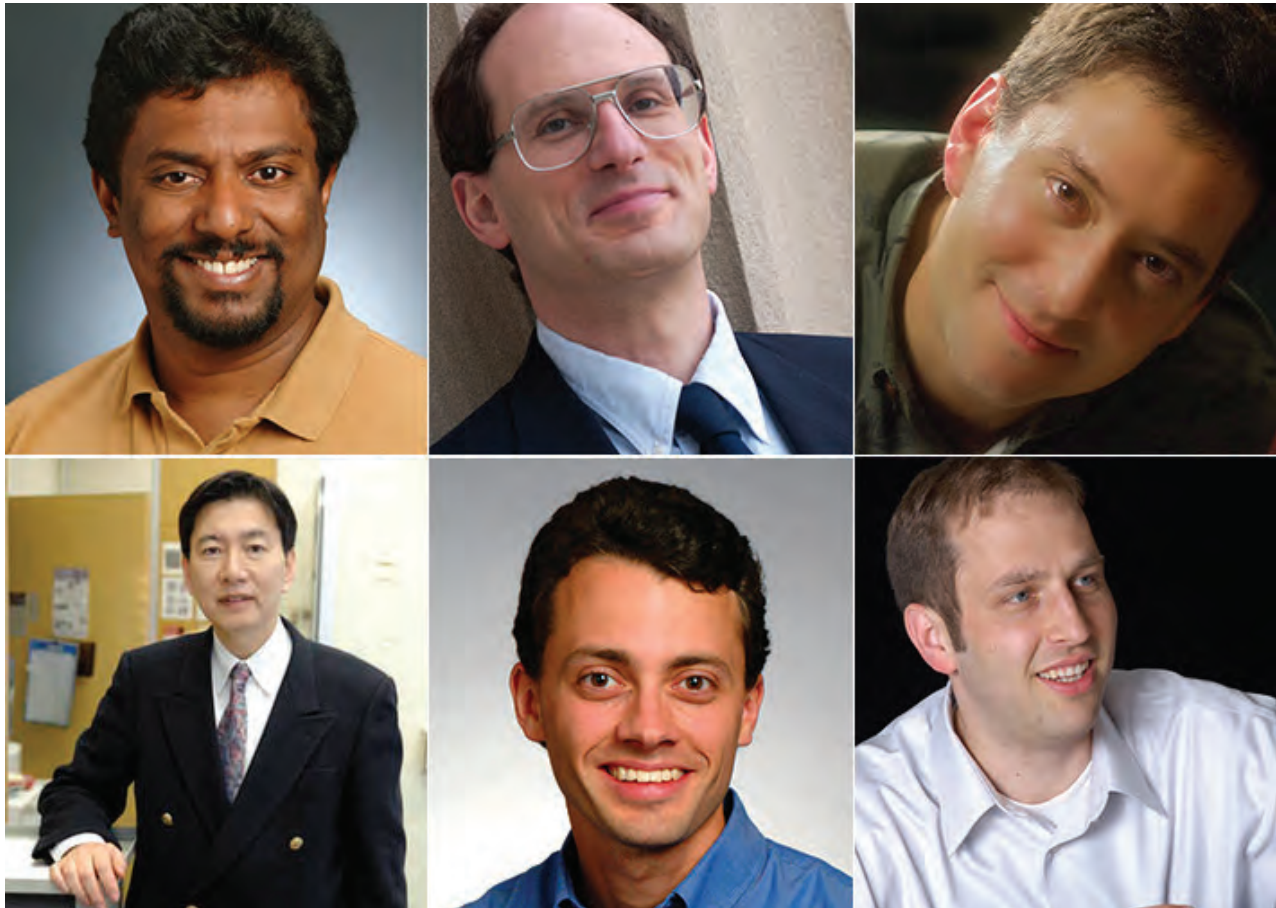

EECS Department Leadership Group turnover in 2014 included co-Education Officers Saman Amarasinghe (upper left) and Jacob White (top, middle), who served for three years and succeeded by (lower left) Hae-Seung (Harry) Lee and Rob Miller (middle lower). Karl K. Berggren (lower right) succeeded Steven Leeb (upper right) as Undergraduate Laboratory Officer.

In July 2014, Anantha Chandrakasan, EECS Department Head acknowledged the contributions of three faculty members who served as part of the Department Leadership Group (DLG) since July 1, 2011. Saman Amarasinghe and Jacob White, both served as co-education officers and Steven Leeb, as Undergraduate Laboratory Officer. Chandrakasan also welcomed the new DLG members (since July 1, 2014) including co-Education Officers Hae-Seung "Harry" Lee, Rob Miller and Undergraduate Laboratory Officer Karl Berggren.

In his first year as co-Education Officer, **Saman Amarasinghe** developed and deployed a web-based portal for course administration allowing students to apply for TA positions online, faculty to provide teaching and TA preferences, education officers to make class assignments TA selections and provide faculty and students up-to-date information about course staffing. He has continued to expand this online accessibility. As these online tools have been used since 2012, multi-year planning based on TA evaluations has also become available.

Amarasinghe was the first chair of the newly formulated Education Curriculum Committee, and under his leadership, an orderly process for updating the curriculum was created. With the dramatic increase in enrollment over the past few years, Amarasinghe helped alleviate the shortage of TAs by creating the Undergraduate Teaching Assistant (UTA) program in spring 2013. His creation of Course 6 class overviews at EECS faculty lunches provided a wider understanding of the latest curricular thinking and application to department teaching.

With fellow co-Education Officer Amarasinghe, **Jacob White** led the education task force of the 2012 EECS Strategic Plan. Under White's leadership, educational innovation across the department resulted in nearly a dozen new classes, and a new level of transparency and load balancing on teaching nurtured the educational enterprise throughout the department. By creating the Extraordinary Educators in EECS (EE-EECS) White helped the department address the enrollment increase. Through this program, six highly motivated and experienced

(next page)

Faculty News, *continued*

Faculty Leadership News, *continued*

educators, each with a three-year contract have additionally provided creative input on curriculum development. With Dennis Freeman, professor of electrical engineering and MIT Dean for Undergraduate Education, White worked with Eta Kappa Nu to enable the move of the department to the Institute on-line class evaluation system.

As EECS Undergraduate Laboratory Officer, **Steven Leeb** co- led the Undergraduate Committee in development of the 2012 Strategic Plan, paving the way for significant improvements in the undergraduate laboratory safety procedures and facilities. Based on his personal goal for EECS to have an advanced prototyping facility, Leeb built the infrastructure needed for the creation and realization of the 2500 square foot space now known as the Cypress Engineering Design Studio. His collaboration with faculty in EECS (and from across the Institute and beyond) in running the Department Teaching Laboratories has provided the context for creatively connecting deep analytical tools with practice for countless students. Leeb not only built the potential for the new design studio—but in the process helped EECS faculty realize innovative ways to benefit from the new facility. EDS is now being used in a number of classes and in design competitions.

Hae-Seung Lee, the Advanced Television and Signal Processing (ATSP) Professor of Electrical Engineering and member of the MIT EECS Department since 1984, is well known for his contributions to greater efficiency in modern analog integrated circuits, his leadership in the Microsystems Technology Laboratories (MTL) and his teaching excellence in the department. He served as Associate Director of MTL from 2009 to 2011. As a graduate student at UC Berkeley, he developed the now-widely used self-calibration techniques for A/D converters. Professor Lee works in the area of analog integrated circuits focusing on data converters, bio-medical circuits and systems, and sensor systems. He has directed the Center for Integrated Circuits and Systems (CICS) since 1998. He is the recipient of the 1988 Presidential Young Investigators' Award and a Fellow of the IEEE. He has served on a number of technical program committees including the International Electron Devices

Meeting, the International Solid-State Circuits Conference and the IEEE Symposium on VLSI Circuits. Professor Lee has taught 6.002, 6.775 Design of Analog MOS LSI and will teach 6.301 Solid-State Circuits this coming term. Prof. Lee received the Louis D. Smullin (1939) Award for Teaching Excellence in 2013.

Rob Miller, professor of computer science and member of the Computer Science and Artificial Intelligence Laboratory, was named a MacVicar Faculty Fellow in 2013 for outstanding contributions to undergraduate education. Professor Miller's research interests lie at the intersection of programming and human computer interaction including crowd computing, online education, software development tools and end-user programming. Rob's teaching has included 6.813, User Interface Design and Implementation, 6.005 Elements of Software Construction, 6.811 Principles and Practice of Assistive Technology, and 6.MITx Building MITx Courseware. Professor Miller received the 2011 Jamieson Prize for excellence in teaching. Professor Miller has been program co-chair for UIST 2010 and Learning at Scale 2015, general chair for UIST 2012, associate editor of ACM TOCHI, and associate director of MIT CSAIL.

Karl K. Berggren is a member of the Research Laboratory of Electronics (RLE), where he directs the Nanostructures Laboratory, and is a core faculty member in the Microsystems Technology Laboratories (MTL). From December of 1996 to September of 2003, Professor Berggren served as a staff member at MIT Lincoln Laboratory in Lexington, Massachusetts, and from 2010 to 2011, was on sabbatical at the Technical University of Delft. Professor Berggren's current research focuses on methods of nanofabrication, especially applied to superconductive quantum circuits, photodetectors, and high-speed superconductive electronics. His thesis work focused on nanolithographic methods using neutral atoms. In fall 2014 Professor Berggren was the head lecturer for 6.002, Circuits and Electronics, a class for which he has served many times on the teaching staff. This spring he was recipient of the Jerome Saltzer Award, given to a faculty member for sustained excellence in teaching of recitations.

Micali Succeeds Freeman as Associate Dept. Head



Professor Silvio Micali, left, has succeeded Professor Bill Freeman in the role of Associate Department Head in EECS effective January 15, 2015.

Electrical Engineering and Computer Science Department (EECS) Head Anantha Chandrakasan announced the appointment of Professor Silvio Micali as Associate Department Head (ADH) of EECS effective January 15, 2015. Micali succeeds Professor Bill Freeman, who served as ADH and member of the Department Leadership Group (DLG) since July 2011.

Micali, a graduate of University of California, Berkeley (1982), is best known as a visionary for his fundamental and foundational work on public-key cryptography, pseudorandom number functions, digital signatures, oblivious transfer, secure multiparty computation, zero knowledge proofs and mechanism design.

Professor Micali has been recognized for his work with many honors including the Gödel Prize in 1993 and the RSA Prize in Cryptography in 2004. He was elected to the American Academy of Arts and Sciences in 2003, and elected in 2007 to both the National Academy of Sciences and the National Academy of Engineering. Silvio Micali and Shafi Goldwasser received the 2012 Turing Award for their work in cryptography — developing new mechanisms for encrypting and securing information — methods that are widely applicable and applied today in communication protocols, Internet transactions and cloud computing.

Micali has been awarded over 50 patents on practical implementations of his inventions for encryption, digital signa-

tures, electronic cash, certified transactions, key-escrow and more. He established two start-up companies: Peppercorn (for micro-payments, launched in 2002 with Ron Rivest and acquired by Chockstone in 2007), and CoreStreet (for real-time credentials) and acquired by ActiveIdentity in 2009.

Chandrakasan said in his announcement to the EECS faculty: “I know that Silvio will bring to his new position the clarity, creativity and passion that characterize his research work and teaching, and the department will be the stronger for it.”

Chandrakasan also extended his appreciation to Professor Freeman for his tremendous service as ADH. Freeman played a key role in the faculty search and hiring process. Along with former ADH Munther Dahleh, Freeman co-chaired the Strategic Hiring Areas planning, leading to the hiring of 12 faculty members and he also worked towards successfully establishing a student committee for the faculty search process.

Prof. Freeman was instrumental in creating Postdoc6 — a dedicated community for the postdoctoral associates in the department. For this initiative, he organized and launched an annual workshop for postdocs (held in January), as well as periodic lunches, with speakers for the group during the semester (see pages 22-23).

Remembering Seth Teller, 1964 - 2014



Seth Teller: expert of computer vision, robotics, and human-robot interaction and member of the MIT Electrical Engineering and Computer Science Department faculty since 1994

“Seth had a unique ability to envision new approaches to problems, then assemble, motivate, and guide large research teams to accomplish things far beyond what they thought possible.”

“Seth was a champion of the MIT Undergraduate Research Opportunities Program, and supervised well over one hundred UROP students and hundreds of UROP projects.”

“He excelled at bringing people together to increase understanding and to tackle complex challenges.”

Seth Teller passed away on July 1, 2014. The MIT News Office obituary included remarks from many of MIT’s faculty including Seth’s colleague and former EECS Department Head and now MIT President, L. Rafael Reif, who announced the news to the MIT community: “I knew Seth as a person of great human warmth and intellectual intensity,” Reif wrote in his message. “He was a brilliant engineer and a gifted advisor with a passion for new challenges. His loss is difficult to grasp.”

As a member of the Computer Science and Artificial Intelligence Laboratory (CSAIL), Teller led CSAIL’s Robotics, Vision, and Sensor Networks group, whose work aims to enable machines to become aware of their surroundings and interact naturally with people in health-care, military, civilian, and disaster-relief settings. CSAIL Director Daniela Rus and EECS Department Head Anantha Chandrakasan wrote in a joint letter to their communities:

“Seth Teller had a unique ability to envision new approaches to problems, then assemble, motivate, and guide large research teams to accomplish things far beyond what they thought possible. As a colleague his reflexive openness and friendliness were a delight; he always seemed to have something new to talk about and he shared it in a way that drew you into the excitement that bubbled up from him.”

On September 29, 2014, a celebration to honor the life of Seth Teller was held at the MIT Stata Center. An academic symposium and research displays paid tribute to the wide range of his research and consequent outreach and impact during his time at MIT. These events were followed by a memorial service and reception.

A few excerpts from the text in the September 29 celebration booklet titled “Remembering Seth Teller” are reprinted below and under his photo left.

“Seth Teller was a technological visionary who pursued grand challenges throughout his career. Full of ideas and enthusiasm, Seth was driven to make bold rather than incremental advances. When faced with the choice between “an easy way” and “the right way” to pursue a technologically ambitious problem, Seth always chose the more difficult path, relishing the scientific challenge and recognizing the greater potential benefits.”

“Seth was motivated by the goal of enabling robots to work with, for, and as extensions of people, to improve their daily lives. He sought to create robots that had an awareness of their surroundings and that could interact naturally with people in health-care, military, civilian, and disaster-relief settings.”

“A major theme of Seth’s work has been the development of assistive technologies to help the disabled. One of Seth’s favorite projects was work with Nicholas Roy to create a robotic wheelchair operated by voice commands. This system has been repeatedly deployed in the Boston Home, a specialized-care residence for adults with multiple sclerosis and other progressive neurological conditions.”

“Seth was also an inspirational teacher. With Daniela Rus, Nicholas Roy and Una-May O’Reilly, he created 6.141 Robotics: Science and Systems, a cornerstone of MIT’s robotics curriculum. Seth also recently developed MIT’s first class in assistive technologies with his colleague Rob Miller, to bring his mission of helping people with disabilities to MIT’s undergraduates.”

Remembering EECS faculty

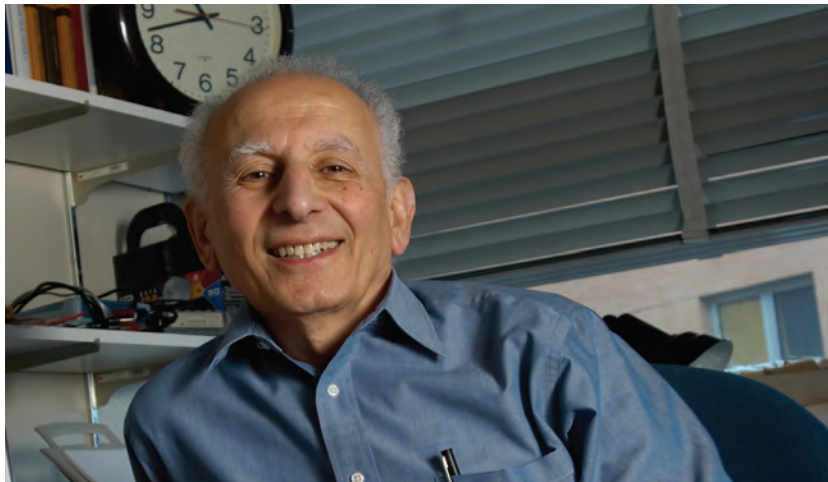

Shaoul Ezekiel, longtime AeroAstro and EECS professor, dies at 79

Professor Emeritus Shaoul “Ziggy” Ezekiel, an MIT alumnus who spent 46 years at the Institute as a professor in the departments of Aeronautics and Astronautics (AeroAstro) and Electrical Engineering and Computer Sciences (EECS), died from soft-tissue sarcoma cancer on Jan. 7. He was 79.

Ezekiel was born in Baghdad, and moved to London with his family in 1948. He received a BS in electrical engineering from Imperial College London in 1957. Ezekiel joined MIT as a graduate student in 1962, receiving an SM in 1964 and ScD in 1968, both in aeronautics and astronautics. He was appointed as an assistant professor in AeroAstro in 1968 and a full professor in AeroAstro and

in Electrical Engineering 10 years later. He taught classes in dynamics, optics, laser fundamentals, basics of measurement systems, and optical sensors.

In 1986, Ezekiel was appointed director of the MIT Center for Advanced Engineering Study. Ezekiel’s research interests were in the fields of lasers and optics and their applications in atom-field interactions; ultra-high resolution spectroscopy; optical frequency/wavelength standards; and sensors, including optical/fiberoptical gyroscopes, magnetic field sensors, and spectroscopic sensors. He exploited nonlinear optical effects to create a variety of new sensors and optical devices, and novel high frequency sources.

EECS Professor Erich Ippen, a principal investigator in the Research Laboratory of Electronics, says, “Ziggy had a marvelous ability to engage students, demonstrate laser phenomena with simple experiments, and make complicated concepts seem intuitive. Always upbeat and positive, he was active professionally well into retirement. Everyone who knew him, discussed laser physics with him, attended one of his classes, or saw him ballroom dancing, has fond memories. We already miss him.”

Read more in the MIT News: <http://newsoffice.mit.edu/2015/shaoul-ezekiel-longtime-aeroastro-eeecs-professor-dies-0112>

Jack Ruina, Professor Emeritus in EECS and first director of MIT’s Security Studies Program, 1923 - 2015

Jack Ruina, professor of electrical engineering and computer science at the Massachusetts Institute of Technology from 1963 to 1997 and emeritus thereafter, died on Feb. 4, 2015 at the age of 91.

Emigrating from Poland in 1926 at age three and a half, Jack Ruina grew up, as the youngest of nine children, in Brooklyn, NY, eventually attending the City College of New York. Following receipt of his PhD degree in electrical engineering from the Polytechnic Institute of Brooklyn in 1948, Ruina joined the faculty at Brown University. As his interests in defense-related areas increased, Ruina joined the faculty at the University of Illinois, Champaign-Urbana in 1953. While on leave from the University of Illinois, Ruina served in several senior positions at the Department of Defense’s radar division in the Control Systems Laboratory and as Director of Defense Research and Engineering in the Air Force and Assistant Director for Air Defense.

For nearly three years, starting in 1961, Jack Ruina was the Director of Advanced Research Projects Agency, ARPA, now called DARPA, in the Defense Department under President Kennedy and Secretary of Defense Robert McNamara. Some projects under Ruina’s supervision at the time included development of technologies for seismic detection of nuclear tests, contributing to the Partial Test Ban Treaty of 1963, research on missile defense systems and radar, and hiring J.C.R. Licklider in creating the project that would become ARPANET, one of three early progenitors of the global Internet.



Read more about Jack Ruina in the MIT News at: <http://newsoffice.mit.edu/2015/jack-ruina-dies-at-91-0212>

Photo above courtesy MITRE Corp and the Ruina family.

Education Updates

6.170: Software Studio 53

6.035: Computer Language Engineering 55

6.UAT: Oral Communication 57

Extraordinary Educators in EECS 59

On the EECS Tour 61

6.170 focuses on software design

6.170, also known as Software Studio, is a class that Professor Daniel Jackson built and has been teaching since Fall 2011. Jackson relates the history. “When we designed the new curriculum, we always planned a more advanced course on programming and software engineering.” He and Prof. Rob Miller had discussed how 6.005, Elements of Software Construction, had turned out to be more challenging than they had anticipated. “So we decided it [6.005] needed to be reshaped into a more conventional programming course — from the more advanced course I’d originally devised,” he explained.

The need for a more advanced course resulted in Jackson’s creating the current 6.170 and Miller’s reshaping 6.005. Jackson chose the number 6.170 in tribute to the original software engineering course developed by Professors Barbara Liskov and John Guttag in the 1980s. The new 6.170 is very different, with more focus on application design and less on programming, but some of its key features, notably the half-term-long team project, were inspired by the original one.

“I decided to make 6.170 a class focused on design aspects of software,” Jackson says, “and chose the web as the platform — since it was already becoming the dominant software platform, and we had no course on building web apps.”

Jackson’s rationale has paid off. At this point 6.170, only offered in the fall term, is a very popular class now up to 180 students (compared with just 42 three years ago). Besides the fact that students want the practical skill of building a web app, he is excited by the challenge of teaching design, something he says “is underemphasized in general at MIT.”

Design of software, however, has its specific issues. Jackson notes that programming courses often skip the most important and hardest part of design: getting from a vague sense of the problem to a specification of what you want to build. In other words, understanding how the software should behave.

In teaching 6.170, Jackson says he’s considered several issues. What do you need to think about to cross this gap—from defining the problem to specifying what to build, and, what should be written down to help crystallize and record the ideas (for critique purposes). He has developed a simple method. “It consists of formulating the purposes that you want to achieve,” he notes, “and then devising concepts that fulfill these purposes.”

EECS senior Josh Haimson says about 6.170 “I liked the focus on design and the practical nature of precisely narrowing and defining a real project of our own design.”



From left, EECS graduate students Erica Du, and Jonathan Wang and TA Viikas Velagapudi hash out an app design in the new 6.170.

Haimson appreciates the focus on understanding the problem. “In any engineering setting, it’s important to truly understand the problem that you are solving and refine your vision for the simplest way to solve that problem,” he says. Haimson is interested in pursuing his interests in AI and entrepreneurship when he graduates in 2016. He wants to work in a company that applies state of the art Artificial Intelligence (AI) and machine learning algorithms to influence industries in a meaningful way.

“From the point of view of alums and companies,” Jackson notes, “the most valuable thing about 6.170 is that students are taught how to conceive what the app is about—what its purpose is and what the concepts are.”

6.170 TA and EECS graduate student, Michael Maddox says that one reason the class is very popular is that it covers web programming — something that is extremely useful and applicable, he notes. But he adds that web programming is a difficult area with a lot of moving parts, difficult pitfalls and is generally poorly documented compared with other programming environments.

Another more recent feature in the setup of 6.170, Jackson notes, is the use of a newer (server-side) framework called Node.js, which is based on JavaScript. Using a conceptually simpler and smaller core means that the students don’t need to learn a new language such as the previous more well established Ruby on Rails language, which has a lot of hidden “black magic” — therefore requiring a higher learning curve
(next page)

6.170 Software Studio, *continued*



TAs for 6.170 seated left to right: Rebecca Krosnick, Cynthia Jing and Kathryn Siegel; standing left to right: Daniel Jackson, Evan Wang, Vivek Desari, Emily Zhang, Kimberly Toy, Charles Liu, Bryan Collazo, Michael Maddox and Mark Day.

and not allowing a clear vision of what is going on under the hood. “[With Node.js], it’s possible to create small pedagogical examples,” he says and “...it looks good on a resume as it’s perceived as cutting edge.” He also adds that it can be installed in a few minutes and tends to be used for more interactive systems.

Data structuring is yet another aspect of design that Jackson originally taught in 6.005 and now incorporates in 6.170. He notes, “Getting from what data you need to how the data is structured requires a simple but potent representation called a data model, which is then transformed into a database structure.”

Maddox notes that Prof. Jackson’s professional research in data and conceptual modeling has built in a take-home message for 6.170: “The up-front design pays dividends throughout the life-cycle of software,” he says. “Through the conceptual and data modeling ideas that are introduced in the course, programmers should in principle be able to save themselves a lot of time and effort later on, and potentially avoid critical and irreversible infrastructure errors altogether.”

Charles Liu, 6.170 TA and EECS graduate student explains that this data model is a “snapshot” of what data exists in an application and how the various pieces of data relate to one another. He notes that this is a huge concern not just in 6.170 and web applications, but in any program that deals with creating and updating data fields. “After an app is in use,” he says, “changing the structure of the data is much harder than getting it right the first time.”

Liu also notes that other prevalent models in computer science are discussed in 6.170 as well, such as “model-view-controller”, which governs the relations between the data, the user’s actions and the presentation of the data, and also “client-server”, which governs the separations and communications between two machines – one the “client” (i.e., the browser) and the “server.”

EECS Junior Jessica Andersen says “Being a computer scientist isn’t only about making things — it’s about sharing the things you make.” She thinks the general design and communication through design skills that were taught were valuable for her and any computer science student, especially “...the ability to share the things you’ve created.”

From TA and EECS graduate student Kimberly Toy’s perspective, the most appealing aspect of 6.170 is a set of learning skills that are directly applicable to industry. “Many of the software giants are consumer web companies, and when hiring, they definitely value the practical experience that students gain through 6.170,” she notes, adding that making web applications is fun anyway. “We use our computers and surf the web all the time, so thinking of ideas for new applications can come quite naturally,” she says. “The idea of implementing that idea and making it a reality is very exciting and is what 6.170 is all about — empowering you to bring those ideas to life.”

Photo left: From left, Pasin Manurangsi, Eric Chang, Minshu Zhan, Weihua James Li, and Prof. Daniel Jackson with TA Hassan Mousaid. Minshu Zhan holds the winning team’s ice cream gift certificate.



6.035: Computer Language Engineering



What it takes to win 6.035, a semester-long project competition

For over a decade, 6.035 has been taught at MIT with the goal of students building a software system from scratch, says Prof. Martin Rinard, who joined Prof. Saman Amarasinghe in 1999 to teach the class. Teams for the term-long project are formed at the beginning of term since building a compiler is a significant engineering effort, Rinard notes. “The end of term competition [known as the compiler derby] is designed to provide a fun and motivating experience for committed students, who welcome a challenge, enjoy competition and strive for excellence.”

Over the past few years, the course has moved towards giving the students more choices and freedom with less structure. In previous years, students were required to use Java and given code skeletons to support coding the compiler in this language. Students now start with a clean slate and the freedom to use other languages such as Scala and Haskell, which can be more productive for writing compilers. And, “the class has become more uniformly successful”—to the point that this fall, “...everyone’s compiler worked with no outright disasters,” Rinard says.

6.035 TA and EECS graduate student Sasa Misailovic notes that building the compiler visits all the major phases of compiler development, from beginning with specification of the programming language to ending with the techniques that make the produced executable fast. “Most of the student compilers have from several thousand to over ten thousand lines of code,” he says.

“Unlike most classes in CS, 6.035 is structured around having a semester-long project — actually writing from the ground up your own compiler [a system that takes a program’s source code and produces an executable file that can run on a computer’s processor]. It’s a rare and valuable experience to do it, though you want to take this class with friends you can rely on.” says Tom Boning, EECS senior and one of four on the winning team. His role on the team was to focus on the hardware and what was needed to make it listen.

Team member Michael Behr, a senior in Brain and Cognitive Science and MEng student in EECS — the one who took on team manager role plus implementing the team’s parallelizing code — explained the class structure: “The first half semester we wrote a compiler that could generate code for a computer to run and in the second half, we improved the compiler to optimize that code so that it could run as quickly as possible.”

“The group’s compiler focused on generating parallel code,” he continued, “splitting most of the work into multiple tasks that the computer can run at the
(next page)

Winning 6.035 team, named 0xD06E, from left: Jenny Ramseyer, Eli Davis, Tom Boning, and Michael Behr with TA Sasa Misailovic.

Below, a cropped section of the team’s parallel output. See the full parallel output diagram next page.

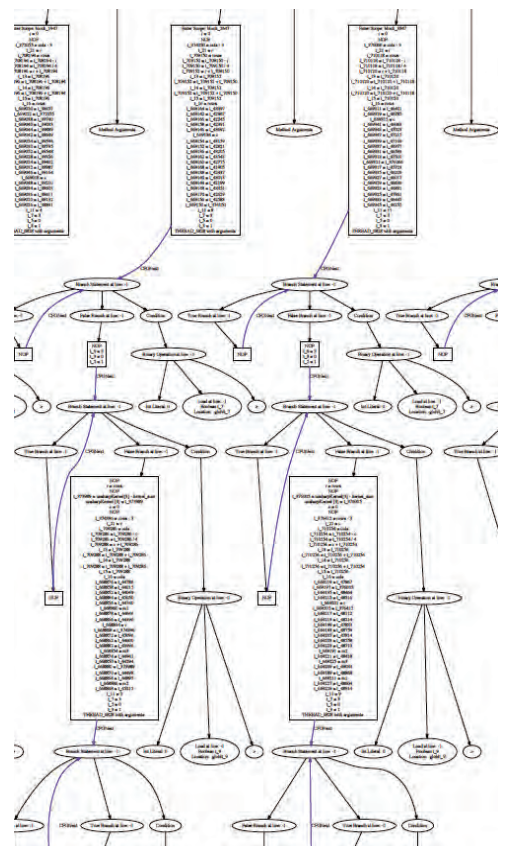

Winning and learning in 6.035, *continued*

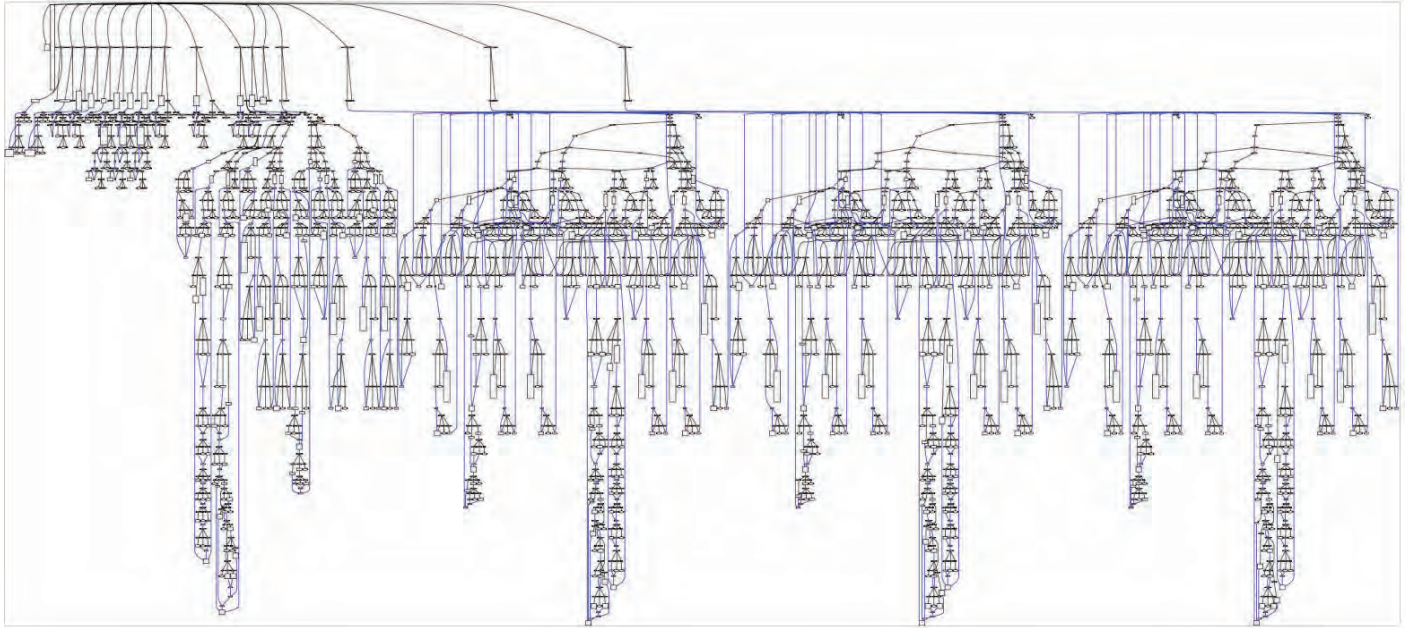

The parallel output diagram, courtesy of the members of the the 6.035 winning team Jenny Ramseyer, Michael Behr, Tom Boning and Eli Davis.

same time.” The group was able to split most of the work into four tasks, allowing the program to run three and four times as fast. He says “This kind of work is becoming increasingly important as processor manufacturers push their chips to the limits of physics. This parallelization is what is making it possible to take advantage of the past decade’s advances in processors.”

EECS Senior Jenny Ramseyer another member of the winning team described 6.035 as a mainly lecture-based class about compilers sprinkled with “funny stories from industry”. She noted about her team, “We chose the name 0xD06E, in honor of the Internet “doge” phenomenon. It’s doge in hexadecimal.”

Ramseyer says the toughest times in the class were getting the compiler to output machine code known as codegen and the final round of optimizations. She and fourth team member Eli Davis, also a senior in EECS, pulled two all-nighters in a row for the last round of optimizations. “It was bad. But fun!” Ramseyer says. “This class will take up all of your free time, ...but it worked out. Debugging was definitely the worst. You’re looking at these giant messy graphs.” [See the code diagram she prepared, above.] Ramseyer, who is looking forward to her MEng for which she has already lined up a project in reconstructing origami tessellations, notes about the class, “You really should know your code inside out, and understand how everything works together. In other classes, it seems more like you’re filling in little functions that magically work together to do something, but in 6.035 you write everything.”

“The hardest part of the process for me was the end of that first half, when we went from representing a program to actually running it,” Behr said. “We spent the first few weeks building representations of computer programs and checking by hand that they looked right, but the processor was much more demanding than we had been.” When the team realized how the program

needed to run — in comparison with their ideas about how it should look — they discovered their mistakes. Behr noted, “Any students reading this and planning to take the class: be ready for the difficulty to ramp up enormously once you’re generating assembly code!”

As Team 0xD06E was reaching a winning conclusion, Boning described the experience. “It’s really rewarding to see something you built yourself take shape and actually work. You’re not filling in a box inside something someone else built—you’re coding the entire thing yourself.” He says that he can see applications of this class in reverse engineering, which tries to decompile, or at least figure out the behavior of programs based on compiled binaries. His goal is to head for industry after he completes his degree in June 2015.

Behr, who is aiming for scientific research in the cognitive sciences and neuroscience, admits that it’s unlikely he will be writing many compilers again, but the skill sets he has gained include much better understanding of what exactly happens when he writes a computer program — something that he anticipates will be needed in the computationally rich areas of neuroscience. Even more important for him was the experience of being team manager.

“We were thrown into the deep end of the project in a way that I don’t expect to happen for most of my career,” he notes. “We had no prior experience and no management but what we provided,” Behr said. “It was a crash course in a lot of the ways that organizing a project can go wrong: misunderstanding each other’s work, leaving functionality unwritten because everyone thought someone else would do it, miss-prioritizing important tasks, and many more failure modes. Fortunately we all kept our heads on and stayed friends by the end of the project!”

6.UAT: How to Communicate in EECS



Jenny Shen, left, EECS senior and 6.UAT undergraduate TA, describes a word she has drawn from a deck of Taboo cards — developed by a number of TAs, students and 6.UAT creator and EECS Senior Lecturer Tony Eng (center). Anthony Adams '15, second from left, assists his teammate while Benoit Landry (far right), EECS grad student, and Francis Chen '15 attempt to identify the mystery word.

6.UAT gives engineers tools to convey ideas

by Kathryn O'Neill

If you're playing improvisational games or Taboo in class, chances are you're in 6.UAT Oral Communication. This is not your average engineering class—yet instructors and students agree that 6.UAT is invaluable to success in engineering.

"All of us [alumni] looking back think that 6.UAT might have been the most important class in our curriculum," says David Thomas '13, a quantitative researcher for Teza Technologies. "I can't imagine a more quantitative and technical job than the one I have, but a big part of the job is convincing people a project is worth pursuing and getting partners on board."

Designed to teach students to speak confidently and give effective technical presentations, 6.UAT is a required subject for all undergraduates in Electrical Engineering and Computer Science (EECS). "Engineers have great ideas, brilliant ideas, but ... part of being good at what you do is being able to explain what it is that you do to audiences with different backgrounds," says Senior Lecturer Tony Eng, who launched the subject in 2004 and has taught it ever since.

"You can go though MIT and just focus on big algorithms and the best way to write code, but if you didn't learn the communication piece, that would be a shame," says Sean Liu '10, M.Eng. '10, who works as a product manager at Facebook. "So much [of a job] is getting a project approved and communicating results. I'm very thankful that the department folded this class in."

Practice, practice, practice

A one-semester subject that is usually best taken in spring of the sophomore year or during the junior year, 6.UAT typically requires students to attend one large-group meeting and two small-group recitations a week. The class features many opportunities to practice public speaking and centers on three main assignments:

- A short, structured talk of four to five minutes in which students present a technical project they've worked on to a general MIT audience;
- An eight-to-10-minute talk explaining the intuition behind a technical topic to a non-technical audience—namely, a live high school student audience during an outreach event at MIT; and
- A 15-17-minute talk proposing a technical project to an audience of peers.

"The MIT culture puts a great deal of emphasis on coming up with great ideas, and our students (and faculty) do an impressive job of it. Our culture does not, it seems to me, put sufficient value on the ability to communicate those ideas," says Professor Randall Davis, one of a number of EECS faculty members who have taught recitations for the subject. "One of the important things 6.UAT does is try to change this, teaching our students how to be effective communicators and showing them the value in that skill."

6.UAT, continued



Eng agrees. “Students think, ‘Why do I have to take a class on talking? I’ve been talking since I was 3,’” he says. “I hope they discover there are all these tools and ideas they can use.”

For example, Eng says he incorporates improvisation to help students gain a level of comfort dealing with the unexpected and uses a form of the game Taboo to train students to avoid jargon. (In Taboo, players have to describe a word while avoiding certain banned terms; Eng has created his own cards featuring technical terms and a list of outlawed jargon.) Students in 6.UAT also gain experience designing technical presentations, presenting to different audiences, and giving and receiving constructive feedback.

Engineering a presentation

Liu says he was pleasantly surprised to discover he could improve his speaking skills through 6.UAT, because he had always been fearful of communicating to audiences. “You can think of it almost as an engineering problem,” he says, noting that key talking points can be blocked out and developed piece by piece. “It becomes almost a formula where I can solve each block independently and construct the presentation.”

Students say that it’s helpful that Eng provides a great role model for the class—illustrating in every lecture that it is possible to be both a skilled engineer (Eng has five technical degrees from MIT, including a PhD in computer science) and a compelling speaker. “He tells these magical stories and tries to convey the story behind each lesson. It’s pretty cool and inspiring,” Liu says. “He is like the Jedi master of public speaking,” Thomas says, adding that Eng finds a seemingly endless number of ways to make 6.UAT entertaining. “You don’t know what to expect, but it’ll be fun and different from other engineering courses,” Thomas says.

Along the way, students hopefully change their views about oral communication, Eng says. “When a student approaches presenting, they think of it as a hurdle to get across to get the grade. In reality, it’s more about the audience and getting a message across,” he says.

That’s a lesson that Liu remembers well. “Even something technical and dry if presented with the right examples and analogies can tell the story of what the project was trying to do,” Liu says. “That was a big aha moment.”



6.UAT students give a three- minute presentation for their final class in 26-100. (photo, above) Earlier in the term, 6.UAT students give teaching lectures to a group of high school students. (photo, page top)

Extraordinary Educators in EECS

Managing the enrollment overload in EECS

With the expectation that in September 2014 there would be more than 6000 occupied seats in EECS classes, 4000 of which would be occupied by undergraduates, the EECS Department has taken on some extraordinary help.

Three years ago, the EECS Department began experimenting with adding longer-term lecturer support. The department focused on finding lecturers who could be faculty collaborators in resource intensive classes. As of fall 2014, EECS has had six such lecturers, each with a three-year contract, and each an excellent classroom instructor and educational innovator who also has a strong record of collaborating with faculty on course development and delivery.

When **Ana Bell** graduated with her PhD from Princeton in 2013, she was hired by MIT EECS to be a lecturer for 6.00.1x, the first offering of a split 6.00x. While at Princeton, Ana was a TA in undergrad for one year, teaching intro computer science to freshman and during the summers, she taught the basics of computer science to high school students. “I enjoy introducing computer science to students who have never programmed before. It’s satisfying to see students excited to see their first program run for the first time,” she says. Ana plans to continue teaching computer science and hopes to continue exposing students to the basics of computer science and programming.

She has noticed during her tenure over the past almost two years that with MOOCs gaining traction, the department is transitioning to have the course be more interactive and hopefully more efficient at teaching computer science. “We used MITx to provide students with practice programming exercises and held exams online rather than on paper to better simulate the process of programming that students are used to from problem sets,” she notes.

Max Goldman has been at MIT a while — earning his BS in Course 18C (Math with Computer Science) and his PhD studying with Prof. Rob Miller in Human Computer Interaction in CSAIL in 2012. He became excited about teaching through a number of experiences. First, he says he has Prof. (now emeritus) Paul Penfield to thank for his first teaching opportunity in Course VI when he was an undergraduate assistant for Information and Entropy (then 6.095 and now 6.050) in 2002. His research interest in better ways to learn and teach software engineering grew out of his experience with MEET, the educational initiative aimed at building a common professional language between young Israeli and Palestinian leaders. He taught MEET students, designing and building the program’s CS curriculum and managing teams of MIT instructors. As an extraordinary educator, Max is teaching 6.005, a very popular class — the 10th largest at MIT, according to *The Tech*. He finds it very rewarding to work with so many students. “I think the ideas and tools in 6.005 are absolutely necessary for anyone who wants to write larger programs, or collaborate with others, or anyone who simply wants their code to work reliably.” He says that the class has been reorganized in favor of active learning with as much time as possible devoted to working problems and writing code. He loved crafting fun lectures, but enjoys working on the new challenges of an active learning classroom.

These “Extraordinary Educators” in EECS (EE-EECS) include Adam Hartz (6.01), Katrina LaCurts (6.033 and 6.02), Joe Steinmeyer (6.01), Max Goldman (6.005), Ana Bell (6.00 and 6.00x), and Silvina Hanono Wachman (6.004 and 6.004x). Our EE-EECS lecturers are dedicated award-winning technical educators, and creative curriculum developers and leaders. They co-lead classes during the term, and spend summers collaborating with faculty on education-related research. And even though the EE-EECS program is in its infancy, it has already dramatically improved both student evaluations and faculty quality of life.

Read about these six Extraordinary Educators below. One thing they all have in common is a love for teaching.

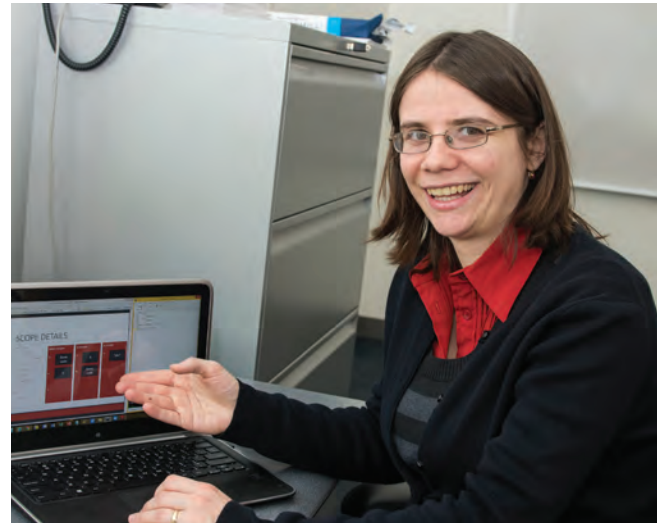

Extraordinary Educators, *continued*



Adam Hartz knows MIT EECS well, having earned his SB (6-3) in 2011 and his MEng also in Electrical Engineering and Computer Science in 2012. He has been an EECS extraordinary educator for just about three years. How did he prepare? During his undergrad and MEng years, he worked as a lab assistant and teaching assistant for 6.01— with some brief experience with 6.02 and 6.003 as well. He started as a lab assistant for 6.01 in the Fall 2008 term and has been working his way up through the ranks for a while. “By the time I was hired as a lecturer, I had a lot of experience under my belt, ...so I was ready to jump in,” he says. Working mostly with freshmen and sophomores, Adam finds it exciting to be a part of their academic transition from high school students to MIT students. “In particular,” he notes, “6.01 has a strong engineering focus, and for many students, it is the first time they engage with an authentic engineering problem; it is very gratifying to help students make the transition from solving to creating, from analysis to design.” He also finds it gratifying to work on course development, on improving teaching and learning on a broader scale. “I can think of nothing I would rather be doing than teaching,” Adam says, “and I hope to continue doing so in the long term.” He says it’s an added bonus to be able “to work with so many wonderful people who all care about teaching and learning just as much as I do.”



Katrina LaCurts, SM '10, PhD '14, the daughter of two teaching parents, coached high school programming teams while she was in college, and in graduate school (in EECS at MIT) she TAed for 6.02 and taught recitations for 6.02 and 6.033. She also spent two summers as the discrete math instructor for the Women’s Technology Program (WTP) for which she designed her own curriculum and managed her own staff. She has also taken classes with the Teaching and Learning Lab at MIT and keeps track of the literature in higher education. The most rewarding aspect of her teaching as an extraordinary lecturer she says is seeing the students get excited about the material—especially if they were initially unenthusiastic. “My favorite course reviews to receive are ones along lines of ‘This class was way more interesting than I thought it would be!’” she says. “There are so many amazing things in the world, especially in science and engineering, and it’s easy to lose sight of that,” she adds. “So I try to instill that knowledge in my students, and it’s very rewarding when I am successful.”

Katrina is hoping to remain in teaching. In fact, ideally, she’d like to remain in a similar position for the rest of her career.



Joe Steinmeyer’s first taste of teaching was as an undergrad TA at the University of Michigan, and he liked it. Then at MIT as a TA and grad instructor in EECS classes for the last four years of his graduate work, he got to know how things work in the department. In addition, he has worked for the last six years in some of the Office of Engineering Outreach Programs (OEOP) summer and school-year programs teaching really smart high school students. In some cases, he has enjoyed working with them again in Course 6 classes as they have ended up coming to MIT. “I think just seeing students *get* concepts is rewarding,” he says. “By that I mean I’m a big nerd and really love EECS material and when somebody else understands something and then proceeds to ‘nerd out’ about it... I think that is really fun and rewarding,” he says.

Joe finds the extraordinary educator position is really helpful towards his goal of teaching long-term. He enjoys the freedom in curriculum development and experimentation. “MIT isn’t the sort of place that wants or encourages people to teach stale curricula,” he notes, “so having both the freedom and encouragement to experiment with teaching techniques and content is really nice.” He is excited by the way that MIT and EECS are embracing the MOOC movement and by the fact that education is a dynamic field. “So it’s neat to be in this environment,” he says.

Education News, *continued*

As an undergraduate, **Silvina Hanono Wachman** studied electrical engineering with a focus on computer engineering at Cornell University. Then she came to MIT for her master's and PhD, focused on programmable hardware and code generation that could be retargeted for different VLIW architectures. As a graduate student she TAed 6.004, the class she is teaching now. After a 12-year stint working in industry, she decided she wanted to return to teaching and came back to MIT — teaching 6.004 again. This has led to her being hired as a Lecturer for the residential MIT course as well as preparing for the 6.004x version of the course for edX. "I love explaining difficult concepts to students in a way that simplifies the material and helps them understand it," she says. She hopes to continue teaching at MIT as well as on edX courses. In addition to working with 6.004, she looks forward to expanding her teaching repertoire with other classes as well. She notes that the development of the edX version of 6.004 presents many challenges. While the material taught is pretty much the same," she says, "adapting it all to work on edX and be able to self assess is a daunting task for the amount of material involved. Nevertheless, she says it is extremely rewarding to be involved in the process during its infancy.



Taking the EECS Tour

Since 2000, the EECS Undergraduate Office has trained its students to lead tours

Anne Hunter remembers when the EECS Department started doing tours 20 years ago. She was the tour guide. Five years later, the tours became popular enough that Anne offered to "meet and greet" and students were hired to run the tours. She says it is not so much an admissions kind of thing. "Having a bunch of smart people come learn about all the great things that go on here is the best kind of PR," she says. In fact, several of her student tour guides were originally wowed by the department when they went on a tour years before.

The tours are definitely seasonal, Anne says, with very large groups coming in spring and summer. She says that big groups are good because then there is a chance for the prospective students in the group to meet and ask their down-to-earth questions like "What is it like to be a student here?"

Tour guide Alex Hsu, '13 and currently an MEng student in the department, remembers large tours where big groups take longer to move from one spot to the next and younger ones in the group actually become friends exchanging emails.

"As I leave Anne's office," Alex says about her tours, "I usually introduce myself and try to find out what people are most interested in (whether it is EE or CS or they have no idea). I also explain the differences between 6-1, 6-2, 6-3 and 6-7 and discuss the MEng program. I usually also try to mention that at MIT we speak in numbers so if I say a number that doesn't make sense, people should definitely ask because chances are it is MIT speak."



Anne Hunter surrounded by her EECS undergraduate tour guides, spring 2012. Seated from left: Dylan Sherry (6-2, '12), Kevin Fischer (6-1, '12), standing from left: Louis Lania (6-2, '14), Irena Huang (6-1, '11), Anne Hunter, and Elaina Chai (6-1, '12).

On the EECS Tour, *continued*



Cody Coleman, '13, MEng '15, describes his EECS experiences on a tour. Tour guides Ben Greenberg, MEng '15, on his right and Alex Hsu, '13, 'MEng '15, center join the listening guests.

The first stop on the tour is the **6.01 lab**. “I like to show people one of the robots and discuss how hands-on the class is, giving students a chance to get real experience with coding and with building circuits. This helps people figure out which track they are the most interested in.” This also gives her a chance to talk about class requirements and sizes.

Next Alex moves the group on to the **6.02/6.002 lab space**, where she shows off the tabletop MRI machines. “A lot of times people (especially parents) are concerned about degree programs and not having time to take extra classes,” Alex says. So she makes sure to explain that MIT students have wiggle room in most majors and even double majors are possible. At the 6.02 end of the lab she also likes to talk about 6.02 check-offs with TAs, where a TA will go over each student’s code individually.

In the lab she also mentions Athena clusters (and usually gets asked about macs vs. pcs, so she explains that students use our his or her own operating system. Then she typically moves down to the **6.002** end of the lab where she shows off some of the EE equipment and talks about how this is one example of an elective class that isn’t required by everyone in the Course 6 major. Here she also discusses how this class is very theoretical, but also has a fun lab component, which takes less time than 6.01 lab per week. She describes how the class builds throughout the semester, how students learn how to make various components, like a digital to analog converter, and an amplifier circuit, and ultimately an mp3 player — with one still conveniently in the lab .

Next stop is the (new) **Engineering and Design Studio**. Sometimes the lab techs talk while the tour is there, but if not, Alex points out the various machines that students have access to and shows off some of the tools and projects that are on dis-

play. Next they walk to CSAIL, Alex usually stops by the elevators in building 36 to talk about UROPs and how that is an amazing opportunity for MIT undergrads. Then as they walk through **RLE** she mentions that RLE is the biggest EE lab on campus and points to the informational wall art. At this point, she also talks about SuperUROPs and how they are a Course 6 creation and an unparalleled opportunity. She also talks about how a lot of SuperUROP projects turn into MEng theses for students, allowing them to have a more substantial research project.

Next in **CSAIL** outside of the **PR2 robots lab**, Alex shows the robot and talks about the research being done that is easy for them to visualize. She tells them about the goal of getting robots into homes, but how a “simple” task like “do the laundry” varies from home to home, so the robot has to learn how to learn. From there they go down to the first floor, where by far one of the most popular stops is the mechanical calculator (the **DIGI-COMP II**) that can do bitwise math using pool balls as the ‘bits’. “People are fascinated by this!” Alex says. “I once had a group that stayed here for 15 minutes ...they thought this was the most interesting part of the tour.” From here they see 32-123 if it is open and talk about MITx and then head back to chat more with Anne Hunter in the EECS Undergraduate Office.

Cody Coleman, '13, MEng '15 has enjoyed giving tours since 2013. He says: “Between my bachelors and masters degree in the EECS department, I have traveled to over 15 different countries, worked at Google, and done research to define the future of learning, accomplishing more than I had ever imagined. What is even more impressive is that I am not an anomaly but the norm. There is a strong network and support system, making MIT a place where you can have an impact and make the world a better place. As a tour guide, I get to impart that to people all over the country and the world.”

Staff Features

A Conversation with:

Kathleen McCoy

64

William Tilden

66

Myung-Hee Vabulas

67

Meet some EECS Staff Members

A Conversation with Kathleen McCoy



Q Have you always lived in the Boston area?

A I am Boston born, and bred — one of eight (six girls and two boys). My parents were also from Boston. My dad's father was literally the first person in his neighborhood to have electricity and had to bring the wires to his street/house in Jamaica Plain by himself. His dad, my grandfather, worked at Haffenreffer Brewery and was responsible for the maintenance and boiler at the brewery.

Rumor has it that Babe Ruth and his teammates would play poker and consume large quantities of alcohol that had to be syphoned off the product from the brewery so it could be sold as non-alcoholic beverage during prohibition. My dad and his brother were the kids who brought the pitchers of illegal refreshment to Babe and the others from the back. I suspect that's how my dad got his job selling peanuts at the ball game too!

I learned to sail at Community Boating on the Charles and then worked there through high school and college. My fondest memories are the regattas on the Charles or against other local sailing teams, walking to Fenway after working all day and catching a night game when the bleacher seats were just \$2.00 per ticket, and spending each 4th of July either at Community Boating or at the Hatch Shell, as the views for fireworks were the best in the city. I even sat for 6 hours in the pouring rain at the Hatch Shell for the Arthur Fielder Memorial concert. I guess the Charles River just called me back home and that's why I'm at MIT!

After graduating from Simmons College with a degree in management with a specialization in retail, I interned at Filene's at Downtown Crossing and then worked for many years with Star Market — where I met my husband. We have 3 daughters.

In High School and at Simmons I always held leadership or mentor roles. I served as a commuter representative, student advisor and PE Sailing teacher. I loved being in a higher education environment. I knew I would work for a college or university. When my kids were all in school I was offered a position in continuing education at Bentley College (now Bentley University) back in the 90's. I have been working in some form of education ever since. I earned my MBA from Bentley back in 2000.

Q What are the things you really like about the EECS department and your work in the Graduate Office?

A First of all the faculty, students and staff are all brilliant! Not only that, but they are genuine. It seems the community is filled with people who have a passion for what they do whether studying, researching, advising or supporting faculty and staff, the folks at MIT are here because they want to be the best they can be. There is a feeling of family in the department. I believe that EECS is very service oriented and this is especially true of those who work in the headquarters, the UG office and the Grad Office. It really is very uplifting to come to work every day. Even when there are problems that may arise, you always know help is there, all you need to do is ask. It is an extremely welcoming environment and it's great to be part of this community.

Q Outside of work, what do you love to do?

A I love the little things like walks or cool breezes or even a summer rain shower. I am amazed at children and how fast they learn. I was a Girl Scout leader for about 10 years. It was just cool spending time with these girls and watching them grow into caring young women. My knot-tying skills from sailing were helpful as our troop worked on several troop badges. My extended family is pretty close, not only do we spend many holidays together, but we have had excursions to Ireland, Alaska, Disney World and Hawaii. On these trips we have had from 15 to 40 people traveling with us. When my daughter lived in Paris for a spell we all rotated our visits as she lived in a one-bedroom apartment across the river from Notre Dame. But we all visited at some point during her stay, cousins, aunts, uncles, sisters and parents made the trek across the pond and then shared notes on our trips for the next group. We hope to visit Scandinavia as a group perhaps on a cruise in 2016.

Meet some EECS Staff Members

A Conversation with Bill Tilden

Q What attracted you to working at MIT?

A I originally arrived at MIT after finishing graduate school back in 2006. Being a political science major, I was torn between seeking employment here at home in New England or migrating to Washington DC. I was fortunate enough to spot a job opening at the MIT Political Science department and was able to put many of my skills and much of my knowledge to good use there. I had no idea that I would continue to be working at MIT nine years later with tours of duty at Political Science, the Media Lab, and now here at EECS. It's been quite interesting to see both the similarities and differences at each department. Like any large organization, each department at MIT has its own individual office cultures and ways of doing things. Yet the overwhelming majority of the people that reside in these departments share the ethic of hard work, modesty, and can do spirit that makes MIT the formidable institution that it is.



Q What do you do in your position at EECS Headquarters?

A Throughout the year I am responsible for tasks such as faculty and staff parking, coordinating faculty and EE lunches, and processing HQ staff payroll. But the task I focus the most on is verifying and processing Research Assistant (RA) appointments for the Fall, Spring, and Summer semesters. About two months before the beginning of each term, the labs send me their RA request forms. Being meticulous and organized is a must as we are reviewing hundreds and hundreds of RA requests. Taking part in this task three times a year gives my job a nice rhythm. As the term approaches, the intensity increases as my job gets more and more busy. After the term has begun, there is a nice de-escalation period for a month or two where I can catch up on other tasks.

Q What are some of the things about EECS that you really like?

A The thing that continues to impress me here at EECS is the quality of students that this department attracts. The way I know this is due to the interest that companies, from Silicon Valley to here in Massachusetts, continue to express towards our students. As most people know, reputation will only take you so far in life. There comes a point in time where one needs to display both the talent and drive that is necessary to become successful in life. It is this winning combination of aptitude and motivation that I see on a daily basis in the hallways of EECS.

Q You really like to travel. Can you describe what motivates you to take solo trips worldwide?

A Over the past few years I've become more and more involved in international travel. This recent aspect of my life has come as a bit of a surprise to both my family members and indeed to me. Before the age of 30, I had only left the country a couple of times during my undergraduate days. In the past four years, however, I have travelled to six countries in Europe and Asia. During my youth, I never gave much thought to the idea of travelling the world. Everything I thought I needed to see could be found here in the 3.8 million square miles of the U.S. The idea of sitting in an airplane for over 7 hours to go to Europe or 15 hours to go to Asia was not one that got me too excited. Thanks to the friends I made in graduate school, however, I now have an excuse to visit the various world capitals that they inhabit.

I think the thing that keeps me looking for more and more countries to explore is the perspective I gain from these trips. It is one of life's ironies that in order to better understand yourself and where you come from, you often need to get away from your roots for a while and see how things are done elsewhere.

A Conversation with Myung-Hee Vabulas

Q How did you come to be working in MIT EECS Headquarters?

A I grew up in Port Washington, which is on the north shore of Long Island in New York. I moved to New Hampshire to study biology at Dartmouth College, where I met my husband, Shin. After graduating, I worked at a local bookstore while Shin finished his PhD, and we also had our first son, Eita. We moved to Cambridge in 2008, at which point I became a full-time stay-at-home mom. Our younger son, Kai, was born here in 2010. During this period, I started a small business making and selling quilts. Running a business was eye-opening and a lot of fun—I really enjoyed having a hand in everything from photographing the quilts for my online store to doing the taxes.

By 2013, my kids had become more independent, and I was ready to take a part-time position outside the home. I worked briefly at the Whitehead Institute and then in RLE, before I started here in EECS headquarters. One of the things I was looking for was being able to interact with other adults every day, something that I missed during my years at home. I'm happy that I was able to find that here—I feel lucky to be working with such a great group of people.

Q What are the things about your work that you really enjoy and appreciate?

A EECS is an exciting place to be. It's the largest department at MIT and has so many brilliant faculty members and students. I can't claim to fully understand their research, but it's rewarding to feel like I'm contributing in some small way to this environment at MIT that supports their success.

The other thing that stands out is the quality of the staff working here in EECS headquarters. I have learned so much from my coworkers—many of them have years of experience at MIT and are happy to help and advise me as a relatively new employee here.

Q What are your favorite things to do outside work and how do they contribute (indirectly) to your work?

A I love to bake—breads, cookies, cakes, pies. My latest go-to recipes are for brioche and a rustic sourdough bread. The process is very detail-oriented, which relates to my work here at MIT. Especially when baking, you have to follow the recipe precisely or you risk having something turn out poorly. At the same time, over the years I've gained enough experience that I feel more comfortable now manipulating temperatures and rising times to make a bread recipe work for my schedule rather than the other way around. I think a lot of this is applicable to my work life in that you often have to decide what is critical for a project's success and which variables are more flexible.

In terms of other activities outside of work, they mostly revolve around my kids. Actually, we're at the Z Center every weekend for their swimming lessons, and last weekend we also watched the MIT men's basketball team get a win over Fitchburg State. So I often find myself at MIT even on my days off!



Alumni Features & Awards

Ashar Aziz	68
Robert Blumofe	70
Vanu Bose	72
Cynthia Breazeal	74
Mike Evans	76
Yoky Matsuoka	78
Jaime Teevan	80
Alumni Awards & Recognition	82



Ashar Aziz, '81

*Founder, Vice Chairman of the Board, and Chief Strategy Officer
FireEye, Inc.*

Growing up in Pakistan, Ashar Aziz at a young age had a goal to be a technologist and an inventor and entrepreneur. When he learned from one of his cousins that MIT was the best engineering school in the world, he decided that would be the best way to reach his goal.

But he didn't actually know how to apply directly to MIT — something that was not common knowledge in his country. "I heard through the grapevine that if you went to a certain school in Turkey [the Middle East Technical University in Ankara, also known as METU], and you did well there, you could transfer to MIT," he said. Fortunately, the information was correct. He applied to METU and went there for two years, transferring finally to MIT in his junior year. Aziz looks back noting about his unusual entry to MIT that it was "a curious journey, but not one that was uncommon in those days."

On completing his SB in 1981 in electrical engineering, Aziz earned an M.S. in computer science from the University of California, Berkeley, where he also received the U.C. Regents Fellowship. He then went to work at Sun Microsystems where, for twelve years, his work focused on networking and network security.

Aziz's first company called Terraspring, Inc., was founded in 1999. A data center automation and virtualization company, Terraspring, Inc. was acquired in 2002 by Sun Microsystems.

Aziz served as Chief Technology Officer until October 2003. Throughout this period he was building patents in the field of cryptography, networking, network security and data center virtualization.

Lessons Learned to Define a New Problem

And, Aziz was setting out to learn from his first startup experience so he could launch into his next. His thinking: "Work backwards from a problem to a novel solution, making the solution easy to deploy and to use, and making it track the problem trajectory much better than existing solutions — making it truly disruptive in the market. These are just some of the lessons I learned during my first startup."

Aziz then began his quest for an interesting and very hard problem to solve — one that the world was going to have to confront. He found the problem description in the U.S. Department of Defense archives — proposals that were soliciting for answers to solve the problem related to highly stealthy self-propagating malware.

"The more I studied the problem, the more I was convinced this would be a defining problem in the 21st century," Aziz says. He also realized on continued examination of this problem, that the fast evolution of the malware threat was going to make all current efforts obsolete.

Aziz determined that the solution was to develop a brand new defensive architecture blueprint. His extensive work culminated in FireEye, Inc. and its product portfolio. “The last 10 years have massively validated the cyber-security problem, the failure of traditional approaches, and the efficacy of the solution I developed!” says Aziz, who founded the company in 2004.

The core of the FireEye platform is a virtual execution engine, complemented by dynamic threat intelligence, to identify and block cyber attacks in real time and across the different stages of an attack life cycle.

Aziz noted in an online interview in 2012: “Our goal is to bolster the security and key infrastructure that is pervasive across financial, government and credit card infrastructure to protect from three very important threats: crime, espionage, and warfare.” Aziz noted: “These are not one-off failures in say Google or Juniper or Adobe, it’s a systemic fault in enterprise security architecture. The reality is everybody can go down at any point in time, and the majority are [vulnerable].”

Building the Disruptive Technology that works

As Aziz shared with the students in Start6, the IAP workshop for innovators and entrepreneurs held in mid January 2015, finding the disruptive technology that answers a large and growing need makes it possible for even a small startup to gain significant market interest in a short time. As cyber attacks increased and the large incumbent, dominant providers were not coming up with the solutions, the market for a less known

company – but one that could solve the security problems – led to FireEye’s recognition and success.

He noted that building the team for a company means finding high-quality talent, which he says is rare. When he built FireEye’s team he was fortunate to recruit a technical team that he already knew from his previous startup. What is he looking for in recruiting? “Fire, passion, the desire to make a difference, and not being satisfied with the status quo,” he says.

And, he shared with the responsive group of Start6 engineering and management students, advice based on his experience:

“Before you even have an idea, think about how you construct it – backwards – from the problem. Once you have reverse engineered the solution,” he continued, “you have to validate it with a potential customer.” He cautions that “...it should not be something that represents an incremental change to an existing product – but something out of the box – uniquely addressing the problem in ways that make the solution value proposition significantly better than anything that the incumbent market can offer.” From there the job is to get investors. As he puts it, “Raising the money is getting a ticket to the game, but figuring out how to win the game is the most important thing.”

He tops off this advice with: “You need to have courage, because when things go wrong, not only will you need to look in the mirror and motivate yourself, you’re going to go out there and have to motivate your employees too.”

“The last 10 years have massively validated the cyber-security problem, the failure of traditional approaches, and the efficacy of the solution I developed!”

— Ashar Aziz on founding FireEye, Inc.

Robert Blumofe, SM '92, PhD '95

Executive Vice President, Platform Division, Akamai Technologies, Inc.



Robert (Bobby) Blumofe admits that his predecessors did not provide math/science role models. “My father was in charge of production at United Artists and then Director of the American Film Institute West. On the other side, my mother’s father was Jack Benny,” he notes. But, when his older half brother was an undergraduate at Stanford taking Computer Science courses, Bobby at age 10 picked up programming on his HP calculator and things clicked. Teaching himself Basic, he wrote programs for fun in elementary school. Although he was a tinkerer with radio-controlled airplanes and the like, his programming went on hold until he was an undergraduate at Brown University.

At Brown, Blumofe returned to programming, learning C and more languages, ultimately earning a spot in the graphics research group of Prof. Andreis (Andy) van Dam, the Thomas J. Watson, Jr. University Professor. Blumofe had his first experience with research and writing reasonably large-scale programs and he credits Andy with playing an important role in pointing him in the direction of MIT.

During a year away from Brown, Andy got Bobby a job as a programmer at a local startup in Providence called Cadre Technologies. There, Bobby was taken into the fold, working with the founder, Lou Mazzuchelli and a talented group. “I got a ton of great experience, and I value those friendships to this day,” he says. “That turned out to be an amazing experience.”

Super-focused on his return to Brown, Blumofe got back into math and theory— including a class taught by Jeff Vitter who taught from manuscripts by Don Knuth for his book *Concrete Math*. Although challenged by this material, with persistence, Bobby gained satisfaction while studying the proofs and solving problems. “There’s amazing creativity and elegance in complexity theory and the analysis of algorithms,” he notes. He was hooked and continued with theory classes even reading research papers.

On graduating from Brown, Bobby Blumofe was still not set on graduate school or MIT. He could have been happy returning to Cadre Technologies and had little confidence in getting accepted. But, his growing interest in theory and research, was enough to convince him to apply to Stanford and MIT. Accepted to both, Blumofe credits his references, “Clearly Andy van Dam, Jeff Vitter, and Lou Mazzuchelli, wrote some great letters for me, and I’m forever grateful.”

EECS Alumni: innovative, caring and smart

What tipped his decision? Blumofe says, “My decision to go to MIT over Stanford was largely driven by what I found in visiting the two. Maybe it was just timing, but at MIT, visiting the theory group, there was an energy, level of activity, and collaboration that I didn’t see at Stanford. It was really exciting to think that I could be part of that activity, working with these people, solving problems and writing papers.”

Blumofe reflects, “MIT is intense, it’s high energy, it’s in your face” — not necessarily for everyone — “but more than anything it’s the most incredibly talented group of people that I’ve ever come across.”

In fact, he found all these things at MIT and notes that he found it important to balance with another activity—like a hobby or sport. He got into hockey — even though he had never played before — because the theory group had an active intramural team. Tom Cormen, who was just completing his work on the textbook “Introduction to Algorithms” (along with Professor Charles Leiserson), convinced him to start playing.

This turned out to be a good thing, as Blumofe made a number of friendships through hockey — including his now wife Cynthia Breazeal, then a graduate student in the AI Lab. Their friendship blossomed years later and they now have three sons. (Read about Cynthia in this issue, page 74).

He also worked with Charles Leiserson, his advisor as a graduate student in the theory group. He says about him, “Charles is all energy, all enthusiasm, all the time, and I’ve never met anyone who cares more about the development of his students than Charles. He loves what he does, he loves his colleagues and students, and it shows. When you’re working with Charles, it always feels like whatever you’re working on is the most important, most impactful, most interesting, and coolest thing that anyone could possibly be working on.”

Blumofe notes that Leiserson’s attention to detail rubbed off, not only teaching him about research and problem solving, but how to write and present ideas and solutions — skills he uses daily in his professional life — down the road at Akamai Technologies.

Bobby Blumofe joined Akamai in August 1999 when the company was about 10 months old. He says his decision had to do with the people, namely Tom Leighton, Akamai’s founder and now CEO and Blumofe’s former teacher and reader on his thesis. And, the other people were equal pulls including Charles Leiserson and Bruce Maggs, then VP of Engineering at Akamai. Although he knew Akamai at the time had something to do with large-scale distributed systems, using theory and algorithms to solve large-scale problems, he knew that he wanted to work with this group of people. “I knew that so long as I stayed near these people that great things would happen.”

Although he is no longer developing algorithms or proving theorems, Bobby uses the problem solving skills every day as an executive at Akamai. “I learned how to analyze a complex system, find useful abstractions that focus attention on the core elements that drive the system, use those abstractions to develop solutions, and then implement those systems while accounting for all of the non-core elements and real world constraints.”

He says that this approach works not only for technical systems for human systems. And, in large-scale systems, the human element is often the most important, so it must be treated as core in order to ensure that the solutions implemented are aligned with the interests and motivations of the people involved.

In fact, Blumofe notes, “If there’s been any guiding principle in my career it’s that if you surround yourself with great people, then great things will happen, and it’s at MIT that I met so many great people.” And, applying the same principle, Bobby Blumofe credits his relationships and experiences that got him to MIT — all making it possible for him to be at Akamai, where, he notes “again I’m surrounded by extraordinary, talented people who make my job such a joy.”

“If there’s been any guiding principle in my career it’s that if you surround yourself with great people, then great things will happen, and it’s at MIT that I met so many great people.”

— *Bobby Blumofe*

Vanu Bose, '87, SM '94, PhD '99

Founder, President and CEO, Vanu, Inc.



Vanu Bose was an MIT child as his father, Amar, was a professor in the Electrical Engineering and Computer Science Department for 45 years, as well as founder of the Bose Corporation in 1964. Every Sunday morning Vanu remembers coming to play badminton with his father and a group of faculty and students – an enduring early vision of what MIT was about. He also has fond memories of the MIT day camp, especially sailing on the Charles River and seeing his father's new office in the brand new, ultra-modern, Building 36.

While at MIT as an undergraduate and then graduate student starting in 1983, Vanu recalls the unique opportunities that he found there to meet and talk to so many famous company founders. "I remember meeting Ken Olsen of DEC, as a grad student when I presented to the EECS Visiting Committee," he notes. His advisor introduced him to the late Teradyne founder, Alex D'Arbeloff, who shared his experiences with Vanu over coffee. Vanu also met Analog Devices Co-Founder and then CEO Ray Stata and was an EECS graduate student with Stata's son Raymie, now CEO of Altiscale. "I think it's a unique part of the MIT experience that there are not only so many great founders around, but that they make themselves accessible," Vanu says.

Creating wireless coverage where it doesn't exist

Vanu Bose founded Vanu, Inc in 1998, pioneering the commercialization of software-defined radio and the first company to receive FCC certification of a software-defined radio in 2004. As CEO of Vanu, Inc., Vanu says about the direction of his company: "We've had to learn the hard way to shift focus from technology to solving customer problems. Our mission is to create solutions for places that don't have good wireless coverage today."

He notes that today's technology works well and is cost effective – where carriers build the coverage. The equipment, however, doesn't get built where it is not cost effective – including inside buildings, in rural areas, in developing areas and on ships. So Vanu, Inc. plies a variety of solutions not just for the communication technology, but also in the business models and power usage to make it viable to provide this coverage.

In a Jan. 29, 2015 interview with Ranjani Saigal for the e-magazine *Lokvani*, Vanu talked about the efforts his company is making to bridge these gaps in wireless coverage in the developing world, in rural areas and world-wide.

Vanu noted that the most common issue in the developing world is lack of power. "If you look at it, there are about 3 billion people in the world today that don't have cellular coverage simply because they don't have electricity." Some areas, he reports, run on up to 4,000 gallons of diesel a year — expensive and environmentally unsound.

So Vanu Inc has developed a compact base station requiring only 50 watts (rather than the traditional 2-3 KW). The product, called Compact RAN and weighing only 12 pounds, is sealed and requires no installation. "At \$5,000 per unit, it is the cheapest outdoor base station on the market today," Vanu notes.

Further, for areas in Africa where cell phones are used and need to be charged, this unit— the Compact RAN, in combination with a 20 meter pole specially rigged with solar panels can provide GSM cellular and Wi-Fi hotspot coverage with a cell phone charging station at the base of the pole. "So now, you can charge your cellphone, you can use cellular, and you can access the Internet all from this one little kiosk in the middle of the village," Vanu says.

In the rural US, Vanu says his company has created a business model and network architecture by launching a wholesale network through a subsidiary company. "We don't have subscribers; we're not a carrier. But any carrier can connect to

our network and pays us a rate-per-minute and megabyte that's transferred over our network," Vanu said.

In fact, worldwide, Vanu hopes to provide complete coverage in roughly five years. As for developing world impact, he notes to Ranjani Saigal for *Lokvani*, "I strongly believe that a good business model is needed to make a viable impact that sustains over time." He adds, "Of course it is always nice to see the social impact that comes as a by-product."

Creating Entrepreneurship Opportunities

Vanu Bose has taken an interest in helping MIT EECS students gain more access to entrepreneurship opportunities both through involvement with EECS faculty, serving on the board of the Gordon-MIT Engineering Leadership Program and as a member of the MT Corporation, as well as offering his time as a panelist and moderator for the EECS Department's workshop on entrepreneurship and innovation, Start6. He notes, "Entrepreneurship is by nature a grass roots effort – often during efforts that others think are crazy. In fact," he continues, "if you are doing something that everyone thinks is a good idea, then it's not innovative, it's obvious."

Vanu suggests: "MIT has a great grass roots entrepreneurship community. The MIT Venture Mentoring Service (VMS) is a tremendous resource, as are various student groups and clubs. But, I don't think anyone, at any university, has figured out how to really create a more formal process for fostering entrepreneurship and that is the challenge."

"Entrepreneurship is by nature a grass roots effort – often during efforts that others think are crazy. In fact, if you are doing something that everyone thinks is a good idea, then it's not innovative, it's obvious."

— Vanu Bose

Cynthia Brezeal, SM '93, ScD '00

Founder and Chief Scientist, Jibo, Inc.



Cynthia Brezeal speaking at the Women in Innovation and Entrepreneurship Networking Reception on January 22 at the MIT Media Lab. Photo credit: John Gillooly, Professional Event Images, Inc.

At age 10, Cynthia Brezeal, was really inspired and influenced by the movie Star Wars. “I was fascinated by the droids, R2D2 and C3PO.” Brezeal felt robots were not only intelligent and capable, but also social and emotive — with rich personalities and capable of forging meaningful relationships with people. “Robots for me should always have intelligence with heart, and they should engage with us like devoted sidekicks, instead of just tools or slaves. Our experience with technology should reinforce what we love about the human experience, not dehumanize us.” This is her enduring vision.

When it came time for her to think about her future, she first wanted to be a doctor – typical at that time for girls who were serious about their futures and interested in science. In terms of gender issues, she notes, “I am fortunate that I have not encountered roadblocks on my career path because of my gender. It starts at home,” she says, where she was raised with the expectation and confidence that she could do anything that she set her mind to. Both her parents were career scientists.

Being aware of the great job opportunities in STEM-related fields, her parents encouraged her to pursue them. So she worked summers at the Lawrence Livermore National Lab, where her mother worked.

As an undergraduate at the University of California, Santa Barbara, Brezeal realized – with some parental encouragement — that majoring in engineering would keep her options more open than premed. Later, she decided she wanted to be an astronaut – a mission specialist, which meant getting a PhD in a relevant field. Space robotics was a natural choice and she applied for graduate programs accordingly.

At the time that she was accepted to MIT to work in the Artificial Intelligence Lab with Rod Brooks in the early 90s, he had just published his seminal work advocating for small, autonomous micro rovers for planetary exploration — Fast, Cheap and Out of Control: A Robot Invasion of the Solar System. “Rod’s ideas

EECS Alumni: innovative, caring and smart

about autonomous microrovers,” she notes “were very influential for NASA’s sojourner program, which came about in 1997.”

Reality hit Breazeal when she arrived at Brooks’ AI Lab. “I remember my first day walking into Rod Brooks’ lab and seeing all the autonomous robots scurrying about (or not)— all inspired by insect intelligence,” she recalls. “It was as if my first moment of watching Star Wars on the big screen came flooding over me all over again. At that moment, I knew that if we were ever going to see real robots like R2D2 and C3PO, it was going to happen in this lab.” From that point on, Breazeal didn’t want to be an astronaut; she wanted to make the dream of her childhood, robots a reality.

Rod Brooks’ support ranged from intellectual and creative freedom to credit that helped build her reputation in the field – even while she was a graduate student. “Rod is the one who taught me how to be a thought leader and a visionary,” she notes. He told her that no matter how big the field, people get stuck in a rut – making the same assumptions. He recommended: “Find that rut, change yourself and change it, and create a new movement” — which she is doing with Social Robotics.

In fact, she credits Rod Brooks for his support of the women in his group. When she first joined his group, women actually outnumbered the men. “Few people know what a strong proponent Rod has been to women in the field. Look at the women leaders in robotics today — many were either Rod’s former students, or students of his students,” she notes.

Breazeal also credits Anita Flynn, who was a staff research scientist in Rod’s lab when she first joined the group. Breazeal describes her as one of the most high energy, positive thinking, creative, tech-savvy people she knows. She says “For [Anita], robotics was a ‘family sport’ — everyone pitches in, everyone helps everyone else because that’s what a family does.” Breazeal has emulated her positive impact by setting the same culture in her own group the Personal Robotics Group in the MIT Media Lab where she is Associate Professor.

At the time of this writing, Breazeal is on professional leave from MIT, and is founder and Chief Scientist at her new company Jibo, Inc. The company is dedicated to bringing social

robots to the mass consumer market. Toward that goal, they are developing the first open social robotics platform and the world’s first family robot named Jibo. In fact, as she gave the keynote for the first Women in Innovation and Entrepreneurship networking reception held in connection with Start6, the EECS IAP workshop for entrepreneurs and innovators, she announced that she had just closed a series A funding of \$25.3 million (the press announcement was the day before on Jan. 21, 2015) for her company. “The world will be a better place with more women entrepreneurs,” she shared to an enthusiastic group.

She says, “Jibo is the ‘meta’ of my work at MIT and of the field of Social Robotics.” Her insight is that while most people think of robots doing physical things, her research and labs worldwide have shown that social robots are a powerful technology for human engagement — making greater emotional and social impact than current flat-screened, gadget, data-driven technologies. In creating Jibo (and most likely successors) she believes that people will be open to a technology that engages them in a humanized way; that this will exert a real and positive impact on human behavior and performance.

“The provocative thing,” she says, “is that research in my lab and others around the world is showing that people can actually learn better with social robots, adhere to a behavior change protocol better, feel greater psychological involvement and empathy via telepresence, etc.”

Breazeal, who is also the mother of three boys and married to Robert Blumofe (see page 70), relates her perspective on the growth of social robotics.

“The dream of robots has been with us for a very, very long time. Think of our myths and legends. Then think of the evolution of ancient automata. The digital computer was invented in the 1930s, and in 1950 Alan Turing wrote his seminal article “Computing Machinery and Intelligence” — where he argued for robots! It is a long and profound human quest. We’ve been dreaming about, building and iterating on the dream of robots longer than computers, smartphones, the Internet...because robots speak to the philosophical question: ‘what does it mean to be human?’ We have a connection to robots unlike any other technology.”

“We’ve been dreaming about, building and iterating on the dream of robots longer than computers, smartphones, the Internet...because robots speak to the philosophical question: ‘what does it mean to be human?’ We have a connection to robots unlike any other technology.”

— *Cynthia Breazeal*

Mike Evans, '99, MEng '00

Co-Founder and COO, GrubHub Seamless; blogger, writer



Mike Evans has known about MIT for a long time — since his older brother applied to MIT when he (Mike) was in the sixth grade. “I distinctly remember sitting in the back seat of our car listening to my mother talking to him about it. She said, ‘If you go to MIT, you can do anything in the world.’” Growing up, Evans noticed that MIT was often part of movies he watched and in science fiction books. Once on campus, he was fascinated by the idea of combining disciplines from the impressive number of top-rated programs — such as the interface of mechanical and electrical engineering and computer science.

Evans’ MIT “light bulb moment” hit in a Science, Technology, and Society class. He realized, “Never before, in the history of humanity, has a single individual been so in control of the means of creating value as a software developer in 1997.” The heady idea that he could bring ideas all the way to market entirely based on his own skills and efforts came to him during the dotcom boom. And, in his last semester when he studied acoustics with Dr. Amar Bose, the final sequence of lectures that focused on the financial engineering behind the Bose Corporation became for Evans an inspiring reality check in successful management.

In 1998 and 99, Evans notes, almost the entire campus was thinking about entrepreneurship. The 50k competition had just launched, at the AI lab, Akamai had just been founded and the Media Lab was just getting going. “There was a lot of entrepreneurial energy. Rather than making a big course correction, however, the Institute treated this as the newest incarnation of a long history of innovation. Engagement looked much like it had for years: individual professor and individual students meeting in an ecosystem that encourages experimentation and risk-taking.”

After graduating Mike worked for three years as a software developer — as the dotcom bubble burst. While his technical skills developed, he fed his craving to understand how management in a larger company handled its employees. He saw how his boss, who valued and protected his people, created an effective team dynamic. Evans also noticed how HR worked to limit liability rather than maximize employee potential.

All the while, his engineering mind kept asking, “Can this be done better? How would I break the challenges of

EECS Alumni: innovative, caring and smart

creating a culture into smaller pieces and tackle them individually?” This thinking was supported by an engineering lesson he had learned: a key principle of engineering is questioning things that have always been done that way.

Also during this stretch, Evans says, his actual hunger such as ordering pizza downtown began to bug him. He was coding late at night and wanted to order food online. He wondered why it could be featured in the movie *The Net* in 1995, but not exist in 2004? So MIT-trained in the art of “all-nighters”, he wrote the first version of GrubHub. The following morning, his co-founder Matt Maloney sold a restaurant and by that afternoon, Evans had quit his job. By day 10, they had signed up eight restaurants. When a restaurant owner asked Evans if they had coupons on the site, he said yes... and proceeded to pull another all-nighter to write the coupon functionality, signing up two more restaurants with the coupons the following morning.

He notes, “Today, this methodology is called the “Lean Startup” movement.” At the time, he just thought of it as an engineering problem to be solved: Step 1: Build a product., Step 2: Sell it. Step 3: Profit.

Evans and Maloney bootstrapped their business for three years before taking venture capital. When they did take VC, they took it as much to learn from institutional investors as to finance the growth of the company. Evans says about this time: “Each stage of growth brought challenges, and each round of VC brought new expertise to help us meet those challenges. Internally, we added

“Never before, in the history of humanity, has a single individual been so in control of the means of creating value as a software developer in 1997.”

— *Mike Evans*



Mike Evans dipping his bicycle in the Atlantic (at Virginia Beach) and 4,500 miles later on day 75, in the Pacific, at Florence, Oregon.

experts in fields I had never encountered before: sales, marketing, operations, and customer service. I learned as much from our employees as I did from our investors.”

From the first day Evans and Maloney were solving challenging problems at GrubHub. Each solution led to another opportunity to create a better discover, ordering, and fulfillment opportunity. Sometimes they used technology, other times process optimization, still other times education of restaurants and customers. Each innovation represented change, but throughout all of that change one thing remained constant: making delivery better for the customer.

Following the GrubHub IPO in spring 2014, Evans decided to hand over the company reigns. This was a time, he describes, as critical to centering himself following the intensity of the previous 10 years at GrubHub. It was also a time he used to figure out what would come next.

Although he says he totally failed at that goal — more like letting it gel — he did splash his bicycle tire in the Atlantic (at Virginia Beach) and ride 4,500 miles across the country reaching the Pacific 75 days later. He describes this journey and more on his blog: <http://mikeevans.co/>.

He said for this feature, “I succeeded in an unexpected way: I discovered that people are amazing. Across 4,500 miles, and over a thousand interactions with people on my trip, I overwhelmingly experienced kindness, graciousness, and generosity.” In a characteristic engineer’s approach he notes that “if the 24 hour news cycle was representative of how people actually act, we’d be watching 23 hours and 58 minutes of acts of kindness, with 2 minutes of all the other garbage.”

Besides listing himself as writer and photographer, Mike Evans has decided to write a science fiction novel. He notes that there is a good chance that MIT will be mentioned in there somewhere. [We’re on the waiting list Mike!]



Yoky Matsuoka, SM '95, PhD '98

Pursuing a serial curiosity while improving people's lives



Yoky Matsuoka has always liked math and physics, but, she says, "...those interests were dwarfed by my pursuit to be a professional tennis player." Since her earlier years in her native Japan and then in California by age 16, she loved tennis. Spending about 30 hours per week training, she realized two things: "I didn't know much else besides tennis and my career as a high-earning top tennis player was not going to be a reality [due in part to injuries]."

That's when she thought she could study robotics since she loves math and physics. She would build herself a tennis buddy. "It needed to have two legs, a torso, two arms and a head." And, that was not all, "It needed to run around on the other side of the tennis court and play physical and mental games against me," she says.

Admitting that she was never interested in computer science—though she liked problem solving—she realized computer science might be another tool to help in her quest to build a robotic tennis partner. So she went to UC Berkeley where she worked with robotics professors Ron Fearing and John Canny. Working in both of their labs she got a feel for robotics and even worked with a graduate student to build a robotic leg.

On graduating from UC Berkeley in 1993, with a BS in Electrical Engineering and Computer Science, Matsuoka had decided that pursuing her dream to build a sophisticated robot to play tennis with would require much more education. She applied to four schools considered tops in robotics at the time — MIT, CMU, Stanford and UC Berkeley — getting accepted by them all. She fell in love with the ambitious humanoid project at MIT led by Professor Rodney Brooks. "It was a good combination of physical embodiment with mechanical systems and neural/cognitive coding with electrical/computer engineering," she explains. She got her SM working with Brooks on the development of a humanoid hand.

"What kept me at MIT?" she asks. "One of the best things about MIT was that I was able to pursue my 'serial' curiosity."

EECS Alumni: innovative, caring and smart

As she worked with Rod Brooks on robotics and neural networks, she realized that artificial intelligence would not allow her to achieve human-level intelligence – still part of her quest to create a robotic tennis player. “I realized we don’t even understand how our brain controls movements to play tennis,” she says. So she looked around for the best research groups in the world to study how the human brain controls movements. She found it just two blocks away (in building E25) – where Professor Emilio Bizzi, then chair of the MIT Department of Brain and Cognitive Sciences was conducting research in this area. She settled in and completed her PhD – but not without getting very curious as well about entrepreneurship and business in general. Although she recognized then that the best place to study technical entrepreneurship was another block away from E25, she was dissuaded by Boston’s (winter) weather.

Matsuoka has recognized since she was a young girl that she’s pretty intense. “My lab had a motto that was ‘work hard, play hard.’ And, that’s what I did.” She let her curiosity and intensity drive her — but at the same time she felt the need to hide her intensity towards academic endeavors — to avoid being perceived as a nerd, or worse.

At MIT, Matsuoka found that she could be herself. “This is the place where I met people who are all trying to learn beyond any boundaries.” she says. And, the MIT culture allowed her to come out of her shell.

Over the years Matsuoka’s drive and curiosity has carried her through many careers. Developing the microcode for the Barrett Hand as chief engineer at Barrett Technology in 1996, she moved on to academia, first as an assistant professor at Carnegie Mellon. By 2006, as an associate professor of Computer Science and Engineering at the University of Washington, she directed the Center for Sensorimotor Neural Engineering — an effort that brought hundreds of people and large financial support to achieve interdisciplinary research that wouldn’t have been possible otherwise. In 2007 Matsuoka was named a MacArthur Fellow with the citation [top right]:

“This [MIT] is the place where I met people who are all trying to learn beyond any boundaries.”

— Yoky Matsuoka

“Her work transforms our understanding of how the central nervous system coordinates musculoskeletal action and of how robotic technology can enhance the mobility of people with manipulation disabilities.”

By 2009, recognizing the need to see her energy and learning put to practical use in people’s lives, Matsuoka turned to industry, first to become one of the three founding members of Google X, where she worked with the early Google Glass team and developed Google X’s portfolio in medical space. In late 2010, Matsuoka then moved on to become VP of Technology at Palo-Alto-based, and Google-owned Nest Labs, where she led the development of the company’s first product, the Nest Learning Thermostat.

She says about this phase of her work: “This trust of technology is a risky thing. Nest asked for people to trust us and let us into their homes, to make their lives better. And, it is working.” The work saved over 2 billion kWh with these devices while letting people carry on with their lives. She discusses this work in a Technology Review video, in which she describes the ying-yang relationship between human learning and machine learning. “I absolutely believe that the combination of them makes humans whole,” she said. See her discussion at: <http://www.technologyreview.com/emtech/14/video/watch/yoky-matsuoka-internet-of-things/>

Recognizing her evolutionary career path, Matsuoka notes: “I have never left a position because I was unhappy — I always had to make a choice between something exciting and another thing that’s exciting. Life is short and there are a lot of people’s lives I want to improve because of things I can contribute in a way that’s different from others. And there is a lot to do.”

Matsuoka is also raising four children – with her husband who is a computer vision specialist. She notes, “Raising four children makes me realize how lucky I am and what’s really important every single day.” She says it makes her use her time productively so she can be with them and, as she notes, “...learning from them how to live and who I am [expressed through genetics that I could never articulate for myself].”

Jaime Teevan, PhD '07

Senior Researcher, Microsoft Research in Context, Learning and User Experience for Search Group



Jaime Teevan is a Senior Researcher at Microsoft Research in the Context, Learning, and User Experience for Search Group, an Affiliate Assistant Professor in the Information School at the University of Washington, and a graduate of the MIT EECS Department. She enjoys doing research because she thrives on exploring open-ended unanswered questions. She says, “One trait that I have found advantageous is a willingness to jump headfirst into things — be it starting a new line of research or helping my son publish a book.”

When Teevan decided to attend MIT for her graduate work, she chose the school because she “connected at a gut level with the quirky, adventurous, smart people she met when visiting” — including the faculty, graduate students, and her future advisor David Karger. These connections grew while she was at school, with her advisor playing a particularly important part in her graduate experience. “David provided an excellent model of how to tackle hard problems with his supernatural ability to ask deep, insightful questions when presented with something new.”

Teevan is also a mother of four boys (ages 6 to 10), three of whom were born while she was at MIT. She appreciates the support that Karger, the lab and MIT provided, and believes this allowed her to establish a pattern for combining work and family that has become routine for her as her children grow. Her oldest, Griffin, attended daycare in the Stata Center, where she joined him for lunch every day. When the two of them visited MIT last year, they were thrilled that his teacher, Diana, recognized him with a huge welcome.

Teevan is known for her integration of parenting with a research career that includes a lot of travel. “My children force me to allocate my time productively, prioritize sleep, and approach problems creatively,” she says, and “escaping” to the office sometimes gives her an out from “the noise, mud and chaos at home.” She has written several articles about traveling with children to conferences and worked with conference organizers to provide additional assistance for attendees who are also parents.

Teevan admits that having children while in graduate school made her experience somewhat unusual. As she wrote her thesis, she says her twins kept her company “in utero”. Though on bed rest by the time of

EECS Alumni: innovative, caring and smart

her defense, her doctor gave the ok to go ahead. The defense went well, but she is pretty sure the questions were limited so she could get back to bed. She notes that during the time between the births of her first child and the twins, MIT became one of the first graduate programs to implement a maternity leave policy.

To support women pursuing top-level careers in computer science, Teevan urges institutions “to create diverse paths to excellence while rewarding long-term outcomes and seeking broad representation.” She suggests that institutions study and address the challenges women face, build opportunities for women to contribute and support environments where everyone is heard. And she suggests her own mantra for women and men who want to do big things in computer science: “Relentlessly pursue the problems you find interesting. Be brave, jump at opportunities and then see them through.”

Teevan was one of MIT Technology Review’s TR35 in 2009 for her work in improving personal search results based on personal search histories. She developed the first algorithm used by Bing to personalize search result ranking and is still actively doing research to push the field forward. “As our ability to capture online behavioral data expands, so does the opportunity to create tailored information experiences,” she says.

Although web searchers expect search engines to return results instantaneously, Teevan is interested in figuring out how to support search tasks that extend over time. She knows this will take a carefully designed approach, as research suggests that people perceive results that are delivered quickly as higher quality and more engaging than those delivered more slowly.

“People already engage in slower, in-depth search experiences when they do things like ask questions of their social networks,” she says. (See her 2012 TEDx talk on question asking. <https://www.youtube.com/watch?v=-gZ-FD-HzxQ>). She wants to slow down the search experience to allow

searchers to take the necessary time to learn as they search, gather information from multiple sources and explore tangents. “During this process,” she notes, “high quality, personally relevant information can be identified via algorithms that are slower than traditional search engines.” A general overview of the work she is doing in this space can be found in this CACM article (<http://aka.ms/slowsearch>).

In fact, Teevan believes we are in the middle of a revolution in how people perform information work. “Research shows that concrete plans with actionable steps enable people to complete their tasks better and faster,” she says. In her work, a new way has been devised to algorithmically break complex tasks into microtasks that take as little as a few seconds each. By breaking information tasks down, Teevan explains, it becomes possible to pull out the repeatable subcomponents from these tasks to be performed by the task owner (i.e., selfsourcing) or the crowd (i.e., crowdsourcing).

The transformation of information work into microwork will change when and how people work, Teevan notes, enabling individuals and automated processes to efficiently complete tasks that currently seem challenging. A summary of Teevan’s current research focused on supporting this transition can be found in this co-authored article (<http://aka.ms/selfsource>).

In 2014, Jaime Teevan received the Anita Borg Early Career Award. Reflecting on the award, she says, “We spend almost all of our time in research looking into the future. I am always thinking about what I want to figure out next or what I want to help make happen. Receiving this award encouraged me to also pause and reflect a little on the past. It was surprising to realize that I actually have already accomplished a lot, and it makes me even more excited to keep pushing forward.”

Read more on her blog: <http://slowsearching.blogspot.com/>



“My children force me to allocate my time productively, prioritize sleep, and approach problems creatively.”

— Jaime Teevan

Jaime Teevan’s sons aged 6 - 10, from left, Dillon, Cale, Griffin and Brier. Information on Griffin’s book can be seen at: <http://slowsearching.blogspot.com/2013/05/making-maran-ways.html>

Some Alumni Awards and Recognition

Three EECS alumni were selected for the **2014 Technology Review's TR35** list of 35 innovators under 35. These three were selected in the category of inventor.



Fadel Adib, SM '13 and currently a PhD student in CSAIL designs and develops wireless technologies that can see through walls, track human motion, and monitor human's vital signs by relying purely on wireless signal reflections.



Shyamnath Gollakota, PhD '12 and University of Washington professor, was honored for his research using RF as a human gesture detector and his innovative work on ambient back-scatter.



David He, SM '08, PhD '13, cofounder and the Chief Scientific Officer of Quanttus, where he is working on new ways for wearable sensors, algorithms, and data insights to transform personal health, specifically heart health. He was also named for *Forbes' 30 under 30* in 2015.



Maryam Shanechi, SM '06, PhD '11, is part of the Obama Brain Initiative, working at University of Southern California to build a closed-loop system to revolutionize treatments for neuropsychiatric disorders, such as PTSD and depression.

On Oct. 8, 2014, Advanced Micro Devices, one of the world's biggest chip-design companies appointed **Lisa Su**, '91 SB, SM, PhD '94, as its president and chief executive officer. She is the first female to head the 45 year old company and the latest female top executive at a major Silicon Valley tech company. Now in her third year with AMD, Su told VentureBeat that as CEO her focus is to build the right products and look at opportunities to streamline and improve AMD's business operations. Prior to her work with AMD, Su worked first at Texas Instruments and then at IBM (for 13 years since 1995), where she advanced quickly as an executive, starting Emerging Products that focused on low-power and broadband semiconductors as well as biochips. In 2007, Su worked as senior vice president and general manager for Networking and Multimedia at Freescale Semiconductor, Inc.



Alumni elected to the National Academy of Engineering in 2015:

Thomas M. Jahns '73, SM '74, PhD '78, Grainger Professor of Power Electronics and Electrical Machines, and professor of electrical and computer engineering, University of Wisconsin, Madison. For advancement of permanent magnet machines and drives for transportation and industrial applications.

Radia Perlman '88, PhD, fellow at EMC Corporation, Hopkinton, Mass. For contributions to Internet routing and bridging protocols.

Harry Van Trees, ScD '61, professor emeritus and director emeritus, Center of Excellence in Command, Control, Communications, Computing, and Intelligence, George Mason University, Fairfax, Va. For contributions to detection, estimation, and modulation theory and leadership of defense communication systems.

Please share your awards and recognition news! Send to the alumni updates contact form at: www.eecs.mit.edu/people/alumni/alumni-please-share-your-news

Donor Recognition



As part of Start6, the Women in Innovation and Entrepreneurship Networking Reception was held Jan. 22, 2015, and hosted by Marina Hatsopoulos, top left, and Erika Angle, top right, and featuring key note speaker Cynthia Breazeal, (lower image), founder and Chief Scientist at Jibo, Inc. [Photos by John Gillooly, Professional Event Images, Inc.]

Donor Recognition and Appreciation

From the Department of Electrical Engineering and Computer Science at MIT, we extend our thanks to the generous donors listed below who made their gifts to the Department this past fiscal year 2014 (July 1, 2013 - June 30, 2014). We have attempted to list all donors of \$100 or more to the EECS Department in this time period unless anonymity was requested. Although care has been taken in the preparation of this list, some errors or omissions may have occurred; for these we extend our sincere apologies. If you designated your gift to the EECS Department and your name does not appear here or is incorrectly listed, please bring the error to our attention.

All donor recognition categories are exclusive of corporate matching gifts.

**deceased*

BENEFACTORS + **\$1,000,000 +**

Andrew J. Viterbi '56, SM '57

BENEFACTORS **\$100,000 — 999,999**

Thomas Kailath SM '59, ScD '61
Peter J. Levine
Jae S. Lim '74, SM '75, EE '78, ScD '78
Alan L. McWhorter ScD '55
Frank R. Quick, Jr. '69, SM '70
James H. Simons '58
Marilyn Simons

PATRONS **\$50,000 — 99,999**

Ash Ashutosh
Rodney A. Brooks
Terry T. Gou
Caroline B. Huang SM '85, PhD '91
James J. Olsen '80, SM '85, PhD '93
Michael Phillips EE '91
Raymie Stata '90, SM '92, ScD '96
Jeremy M. Wertheimer SM '89, PhD '96
Joyce N. Wertheimer '83

SPONSORS **\$10,000 — 49,999**

Jeff A. Dean
Diandra D. Drago '11
Arthur A. Gleckler '88, SM '92
John V. Guttag
Michael G. Hluchyj EE '79, SM '79, PhD '82
Theresa H. Hluchyj EE '82
Charlene C. Kabcenell '79
Dirk A. Kabcenell '75
Ronald B. Koo '89, SM '90
Kurt A. Locher '88, SM '89
Barry Margolin '83
Nils R. Sandell SM '71, EE '73, PhD '74
William W. Wu SM '67

SUPPORTING MEMBERS **\$5,000 — 9,999**

Chee-Yee Chong '69, SM '70, EE '71, PhD '73
Beth Crotty
Sherwin Greenblatt '62, SM '64
Vivian Greenblatt '62 EE
Frank J. Liu EE '66
Maryanne Sinville For Attivio
Andrew F. Stark '97, MEng '98

SUPPORTING MEMBERS, continued **\$5,000 — 9,999**

Gunter Stein
John D. Summers SM '84
Edwar G. Tiedemann Jr. PhD '87
Ronald E. Zelazo '66, SM '67, EE '69, PhD '71

SUSTAINING MEMBERS **\$1,000 — 4,999**

James D. Ahlgren '55
Abeer A. Alwan SM '86, EE '87, MEng '87, PhD '92
Mickey Bhatia PhD '94
Lenore C. Blum PhD '68
Manuel Blum '59, SM '61, PhD '64
Charles G. Bures '69
David L. Chaiken SM '90, PhD '94
Ronald D. Chaney '85, SM '86, PhD '93
Chee-Seng Chow '84, SM '85, EE '87, PhD '90
Hui-Meng Q. Chow '85, SM '89, PhD '90
Won S. Chun '00
Richard J. Coddling SM '66
Fernando J. Corbató PhD '56
Thomas P. Denny SM '90
Srinivas Devadas
Sulochana Devadas
David H. Doo '77
Paul R. Drouilhet '54, SM '55, EE '57
Rosemary Ellis
Robert R. Everett SM '43
Robert M. Fano '41, ScD '47
Mathew L. Fichtenbaum '66, SM '67, EE '68
Michelle Finneran EE '90
Jenny M. Ford '81, SM '82
G. David Forney SM '63, ScD '65
Robert M. Frankston '70, EE '74, SM '74
Janet A. Fraser SM '84
Robert W. Freund EE '74, SM '74
Edward C. Giaimo III '74, SM '75
Robert P. Gilmore '76, SM '77
Yehuda Golahny SM '54
Julie E. Greenberg SM '89, PhD '94
Sheldon Gruber ScD '58
Joshua Y. Hayase '52, EE '57, SM '57
Jerrold A. Heller SM '64, PhD '67
Robert O. Hirsch '48, '50, SM '51
Gim P. Hom '71, SM '72, EE '73, SM '73
Henry H. Houh '89, '90, AM '91, PhD '98
Lisa Houh '89
Chi-Ming Hui '79
Grace W. Hui '79
Bartley C. Johnson EE '81, SM '81, PhD '86
Susan B. Jones
Richard Y. Kim '83, SM '88
Ernest R. Kretzmer SM '46, ScD '49
Yang Pal Lee '72
Frederick J. Leonberger SM '71, EE '72, PhD '75
Anthony J. Ley SM '63
Chi-Yu Liang '01, MEng '02

SUSTAINING MEMBERS, continued **\$1,000 — 4,999**

Yih Lin '80, EE '83, SM '83
John I. Makhoul PhD '70
Henrique S. Malvar PhD '86
Frederic R. Morgenthaler '55, SM '56, PhD '60
Peter G. Neumann
Abby Newton
Kenneth W. Nill '61, SM '63, PhD '66
Paola F. Nisonger SM '79
Robert L. Nisonger SM '78
Alan V. Oppenheim '59, SM '61, ScD '64
Wendy Peikes '76
Paul L. Penfield, Jr. ScD '60
Sharon E. Perl SM '88, PhD '92
Lisa A. Pickelsimer SM '92
John C. Pinson SM '54, ScD '57
Robert P. Porter '53, SM '65, EE '66
Alexander L. Pugh III SM '53, EE '59
Clark J. Reese SM '69, EE '70
Ellen E. Reintjes '73, MCP '74
Roger A. Roach
Murray A. Ruben EE '64, SM '64
William L. Sammons* '43, SM '44
John E. Savage '61, SM '62, PhD '65
Richard J. Schwartz SM '59, ScD '62
Malcolm L. Schoenberg '45
Charles L. Seitz '65, SM '67, PhD '71
Shu Ser EE '82, SM '82
Danny Seth SM '01
Carol L. Seward '47
Paul J. Shaver SM '62, ScD '65
Henry R. Shomber SM '80
Birgit L. Sorgenfrei SM '93
Christopher E. Strangio EE '76, SM '76
David L. Sulman SM '69
Aurelie Thiele SM '00, PhD '04
Richard D. Thornton SM '54, ScD '57
Richard L. Townsend SM '59, EE '60
Oleh J. Tretiak SM '60, ScD '63
Joseph E. Wall EE '76, SM '76, PhD '78
David Wang '00, MEng '00
Kang-Lung Wang SM '66, PhD '70
Shen-Wei Wang PhD '68
Harold M. Wilensky '70
Joseph F. Wrinn '75
Katsumi Yamane SM '71
Anthony Yen SM '87, EE '88, MEng '88, PhD '92
Robert A. Young PhD '68
Dale A. Zeskind EE '76, SM '76

\$500 — 999

Richard A. Barnes '68
Robert V. Baron '71, EE '77, SM '77
Paul D. Bassett EE '85, SM '85
Manish Bhardwaj SM '01, PhD '09
Michael S. Branicky ScD '95
Geoffrey F. Burns SM '89, PhD '92
John F. Carson '63, SM '64



Photos taken at the Start6 reception on Jan. 15 held at Blade and hosted by Blade CEO and Co-Founder Paul English. [Photos by John Gillooly, Professional Event Images, Inc.]

\$500 — 999, continued

- Daniel K. Chang SM '92
- Harry H. Chen SM '76
- Shu-Wie F. Chen '86
- Douglas J. Deangelis SM '06
- Sandra C. Dow '96
- Robyn Field
- Thomas H. Freeman '76 '77
- Gwendolyn Gerhardt
- Kent L. Gerhardt
- Michael D. Gerstenberger EE '85, SM '85
- Kenneth W. Goff SM '52, ScD '54
- James G. Gottling SM '56, ScD '60
- Walter C. Hamscher SM '83, PhD '88
- Jerry L. Holsinger PhD '65
- Tareq I. Hoque '88, SM '88, SM '92
- Paul K. Houghton PhD '75
- David L. Isaman SM '70, PhD '79
- Zafar M. Kahn '79, SM '85
- Stephen T. Kent SM '76, EE '78, PhD '81
- Jerome S. Khohayting '93, '94 MEng '94
- Elliott J. Kim '12
- Wolf Kohn SM '74, PhD '78
- Yu-Ting Kuo SM '94
- Nathan A. Liskov '60
- Charles I. Malme SM '58, EE '59
- Scott E. Meninger SM '99, PhD '05
- Warren A. Montgomery EE '76, SM '76, PhD '79
- Joel Moses PhD '67
- Marianne Mosher '76
- Seth W. Muriph '82, SM '84
- Phillip T. Nee SM '94, PhD '99
- Peng-Teng P. Ng '79, SM '81, EE '82, PhD '86
- Carl E. Nielsen Jr. SM '58
- Rajesh K. Pankaj SM '88, PhD '92
- Lee S. Parks '79
- Robert J. Petrokubi SM '68
- Cynthia A. Phillips SM '85, PhD '90
- Sanjay K. Rao '02, MEng '03
- Stan J. Reiss SM '95
- Frederick L. Ricker SM '77
- Joel E. Schindall '63, SM '64, PhD '67

\$500 — 999, continued

- Edward M. Singel EE '75, SM '75
- Eric M. Soederberg SM '92
- David A. Spencer SM '71, EE '72
- Steven V. Sperry SM '78
- Daniel D. Stancil SM '78, EE '79, PhD '81
- John C. Ufford SM '75
- J.S. Wiley III '73
- John A. Wilkens PhD '77
- Lucile S. Wilkens PhD '77
- William J. Wilson SM '63, EE '64, PhD '70
- Helen H. Wong SM '75

\$250 — 499

- Robert L. Adams III SM '69
- Bill W. Agudela SM '82
- Sarah Ahmed '00, MEng. '01
- Roger K. Alexander SM '91
- Tao D. Alter SM '92, PhD '95
- Mark Asdoorian '98, MEng. '98
- Eugene J. Baik '05 MEng. '06
- Benjamin E. Barrowes PhD '04
- Barbara Blanton EE '49
- H. E. Blanton SM '49, EE '55
- Richard W. Boberg SM '73
- Thomas D. Bracewell '76
- John F. Buford '79, SM '81
- Julian J. Busgang SM '51
- Chalres H. Campling SM '48
- Howard F. Chan '04, MEng. '05
- Brian Chen SM '96, PhD '00
- Geoffrey J. Coram PhE '00
- Susan R. Curtis SM '82, PhD '85
- Audrey A. Dima SM '96
- Adam M. Eames '04, MEng '05
- Anna V. Gallagher '02
- Michael A. Gennert '80, SM '80, ScD '87
- Stephen E. Grodzinsky '65, SM '67
- Allan R. Gunion SM '60
- Ralph R. Harik '01, MEng. '03



Donor Recognition and Appreciation



Photos taken at the Start6 class in the first week of class, pages 86 - 88. See Start6 story on pages 20 -21. [Gretchen Ertl, photographer]

\$250 — 499, continued

Wendi B. Heinzelman SM '97, PhD '00
 John S. Hill SM '60
 Berthold K. Horn SM '68, PhD '70
 Hing-Loi A. Hung '68
 Robert A. Iannucci PhD '88
 Hans P. Janssen '65, EE '68, PhD '71
 Lori L. Jeromin SM '82
 Stephen A. Jordan '74
 Susan M. Jordan '74
 Gregory A. Klanderman SM '95
 Thomas F. Klimek SM '59
 Terry Y. Koo '04, MEng '04, PhD '10
 Huy X. Le '94, MEng. '96, PhD '99
 Laurence H. Lee SM '90, PhD '94
 Young S. Lee EE '69, SM '69
 David B. Leeson SM '59
 Alexander H. Levis '63, SM '65, ME '67, ScD '68
 Ying Li SM '89, EE '93, MEng. '93, PhD '94
 Chia-Liang Lin PhD '95
 Francis C. Lowell Jr. SM '64, EE '65
 Allen W. Luniewski EE '77, SM '77, PhD '80
 Alexandros S. Manos SM '96
 Carla Marceau SM '70
 Glendon P. Marston ScD '71
 Uttara P. Marti '03, MEng. '05
 John L. McKelvie SM '49
 Morihiro Myodo SM '63
 Keith S. Nabors SM '90, PhD '93
 Stephen D. Patek SM '94, PhD '97
 Mary Linton B. Peters '92
 Stephen L. Peters '91, SM '92, PhD '06
 Peter O. Rexer '91
 Larry S. Rosenstein '79, SM '82
 Jonathan Ross '85
 Jean-Pierre Schott EE '82, MEng. '82, SM '82, PhD '89
 Sarah E. Schott '83
 Paul S. Schluter EE '76, SM '76, PhD '81
 Herbert F. Schwartz* '57
 Nan Schwartz '56
 Phillip E. Serafim SM '60, ScD '64
 Sameer E. Shalaby SM '91
 Jeffrey H. Shapiro '67 SM '68, EE '69, PhD '70
 Howard J. Siegel '71
 Guy M. Snodgrass SM '00
 David L. Standley SM '86, PhD '93
 Russell L. Steinweg '79

\$250 — 499, continued

Ahmed H. Tewfik SM '84, EE '85, ScD '87
 David A. Torrey SM '85, EE '86, PhD '88
 Sara Torrey EE '88
 Min-Yuan Tung '90
 Kathleen E. Wage SM '94, MEng. '96, PhD '00
 Holly A. Waisanen PhD '07
 James T. Walton '77, SM '77, PhD '93
 Jennifer Welch SM '84, PhD '88
 Raydiance R. Wise SM '07
 Harvey M. Wolfson EE '74, SM '74
 James F. Womac SM '66, PhD '72
 H. R. Zapp '63, SM '65

\$100 — 249

Mr. Michael A. Ashburn SM '96
 Alia K. Atlas '93
 Sandeep Bahl SM '88, EE '92, MEng '92, PhD '93
 Eileen J. Baird SM '87
 David R. Barbour SM '61
 Kevin L. Boettcher SM '81, EE '82, PhD '86
 Michael T. Bolin '03, MEng '05
 Richard J. Bonneau PhD '74
 Gary C. Borchardt PhD '92
 Hardy M. Bourland SM '57
 Steven K. Brierley EE '75, SM '75
 Gretchen P. Brown EE '74, SM '74
 Valentino E. Castellani SM '66
 Christopher Carl '60
 Gregory A. Carlin SM '90
 Cy Chan SM '07, PhD '12
 Ming Hong Chan
 Kan Chen SM '51, ScD '54
 Monica H. Choi SM '93
 Nelson C. Chu SM '90
 Shun-Lien Chuang SM '80, EE '81, PhD '83
 Jacinda L. Clemenzi '02
 Douglas R. Cobb SM '65
 Gerald Cook SM '62, EE '63, ScD '65
 Jack D. Cowan SM '60
 David R. Cuddy EE '74, SM '74
 Jerome Daniels
 Bahman Daryanian '77, SM '80, SM '86, PhD '89
 George A. Davidson SM '56
 Brian T. DeCleene '88
 Nigel A. Drego SM '03, PhD '09

\$100 — 249, continued

Steven C. Ellis '88
 Kenneth W. Exworthy SM '59
 Peilei Fan SM '01, PhD '03
 Oleg V. Fedoroff SM '63
 James G. Fiorenza PhD '02
 John T. Fischer SM '52
 Emily B. Fox '04, MEng. '05, Eng. '08 PhD '09
 Paul J. Fox EE '73, SM '73
 Thomas H. Gauss SM '73
 Diane C. Gaylor SM '87, PhD '89
 Michelle J. Glaser-Weiner SM '82
 John N. Gowdy '67
 Paul A. Green II '73
 David R. Greenberg SM '90, PhD '95
 Michael B. Greenwald '80
 Randall V. Gressang SM '66, EE '67
 Daniel W. Griffin SM '84, PhD '87
 Wayne H. Hagman SM '81
 John G. Harris '83, SM '86
 William A. Harrison EE '84, SM '84
 John M. Heinz SM '58, EE '59, ScD '62
 Richard M. Heller '81
 Peter S. Hermansen '70
 Donald T. Hess SM '58
 Herbert L. Hess SM '82
 Stephen D. Hester '63
 Charles Robert Hewes SM '67, PhD '71
 Timothy J. Higgins
 Una Higgins
 Roger A. Holmes SM '58
 Merit Y. Hong '84, SM '87, PhD '91
 Paul J. Howard '87
 Edward P. Hsieh SM '64
 Jeff M. Hsing SM '00
 Joel T. Johnson SM '93, PhD '96
 Nolan T. Jones SM '54
 Steven Kamerman '73
 Hsin-Kuo Kan SM '73, ScD '77
 Suil Kang SM '86
 Kirpal S. Khalsa '80
 Kenneth P. Kimi Jr. SM '81
 Richard D. Klaffer '58
 David L. Kleinman SM '63, PhD '67
 Richard W. Kolor SM '67
 John D. Kramer Jr. SM '58, ScD '64
 Barton Krawetz '60



Start6 featured high level speakers and panelists. See <https://start6-2015.mit.edu> for details.

\$100 — 249, continued

- David D. Kuo SM '87, PhD '90
- Shang-Chien Kwei '05
- Christopher T. Lee SM '62, EE '66
- Jay K. Lee SM '81, EE '82, PhD '85
- Michael Lee SM '95
- Steven B. Leeb '87, SM '89, EE '90, MEng '90, PhD '93
- Alan Levin III '72
- Kevin A. Lew SM '95
- Catherine Lin
- Chia-Liang Lin PhD '95
- Tzu Mu Lin
- Archie J. MacMillan EE '59, PhD '61
- William F. Maher Jr. SM '80
- Alexandros S. Manos SM '96
- Carla Marceau SM '70
- Steven I. Marcus SM '72, PhD '75
- Elizabeth A. Marley SM '96, PhD '00
- Glendon P. Marston ScD '71
- Uttara P. Marti '03, MEng. '05
- Emin Martinian SM '00, PhD '04
- Ernst W. Mayr SM '77
- Benjamin J. McCarroll SM '87
- Patrick J. McCleer SM '72
- John L. McKelvie SM '49
- Christopher L. Medina '86
- Norman H. Meyers SM '54, ScD '57
- Peyman Milanfar SM '91, EE '93, MEng. '93, PhD '93
- Owen R. Mitchell Jr. SM '68, EE '69, PhD '72
- Aye M. Moah '05
- Lajos Molnar '97, MEng. '98
- Guy E. Mongold Jr. SM '59
- Alexander W. Moore '05, MEng. '06
- Anca I. Mosoiu '95
- Jose M. Moura EE '73, SM '73, ScD '75
- Thomas E. Murphy SM '97, PhD '01
- Steve C. Ng '73
- Laura K. Oler SM '97
- Mitchell Oler EE '97
- Randy B. Osborne EE '86, SM '86, PhD '90
- Lynne E. Parker PhD '94
- Hugh M. Pearce SM '66, EE '67
- Thomas J. Perrone '65
- Stephen L. Peters '91, SM '92, PhD '06
- Marvin E. Peterson SM '57
- Brian K. Pheiffer SM '92
- Marilyn Pierce

\$100 — 249, continued

- Damian O. Plummer '02
- Charles E. Porges '74
- Aditya Prabhakar '00, MEng. '01
- James C. Preisig EE '88, MEng '88, SM '88, PhD '92
- Robert A. Price SM '53
- Richard H. Rearwin SM '54
- John A. Redding SM '76
- Howard C. Reeve III SM '83
- Mark B. Reinhold SM '87, PhD '93
- John F. Reintjes Jr. '66
- Jason Rodriguez
- Clifford A. Rose Jr. EE '67, SM '67
- Larry S. Rosenstein '79, SM '82
- Jonathan Ross '85
- William D. Rummeler SM '60, EE '61, ScD '63
- Nora L. Ryan '84
- Karen B. Sarachik SM '89, PhD '94
- Sunil K. Sarin SM '77, EE '78, PhD '84
- Ronald W. Schafer PhD '68
- Roger R. Schell PhD '71
- David A. Segal '89
- Todd C. Sepke SM '02, PhD '07
- Ying Shan
- Edmund M. Sheppard SM '58
- Howard B. Sherman SM '81
- Shih-En Shih PhD '98
- Minoo N. Shroff '63
- Roswitha H. Sidelko
- Stephen W. Sidelko
- Eero P. Simoncelli SM '88, PhD '93
- Mahmut E. Sinangil SM '08, PhD '12
- Jagadishwar R. Sirigiri SM '00, PhD '03
- Sylvia Smullin
- Gary H. Sockut SM '74
- Avron N. Spector '54, SM '57
- John M. Spinelli SM '85, PhD '89
- Eric H. Stern '73
- Mark W. Terpin '83
- Kirk D. Thompson SM '66
- Susak Thongthammachat SM '67
- Chalres D. Trawick SM '80
- Thomas H. Van Vleck '65
- Miguel Velez-Reyes EE '88, MEng '88, SM '88, PhD '92
- Olga Y. Veselova SM '03
- David A. Vogel '74



Donor Recognition and Appreciation



Start6 included four panels. See the Start6 website for details: <https://start6-2015.mit.edu>.



\$100 — 249, continued

Lawrence C. Wang '99, '00, MEng '03
Duncan C. Watson SM '72, PhD '75
Herbert L. Weiner
Sheila S. Weiner
Robert J. Wenzel EE '74, SM '74
Gary L. Westerlund
Donald F. Western SM '66
Kenneth R. Wooling '71, SM '72
Joyce H. Wu SM '00 PhD '07
Xiaowei Yang SM '98, MEng. '00, PhD '04
Ying-Ching Yang SM '85, EE '86, MEng. '86, PhD '89
Zheng Yang SM '99
Roy D. Yates SM '86, PhD '90
Vera S. Yaul
Wayne Y. Yaul
Robert D. Yingling SM '68
Ryan E. Young '08
Livia L. Zien '88
Assef A. Zobian SM '95, ScD '96

FOUNDATIONS AND CORPORATIONS

Actifio, Inc.
Activision Inc.
Adobe Systems Incorporated
Aisle 50
Amazon.com
Analog Devices, Inc.
Andreessen Horowitz
Apportable Inc.
Association for Computing Machinery
Boeing Company
Broadway Technology LLC
Cisco Foundation
Cisco Systems Inc.
D.E. Shaw Y Co., L.P.
Denso International America, Inc.
CS Draper Laboratory
Dropbox Inc.
Duke Energy Corporation
eBay Inc.
Exxon Mobil Corporation
Gameloft.com Inc.
General Motors Foundation Inc.
Google, Inc.
Hon Hai Precision Industry Co., Ltd.
Intel Corporation
Kayak Software Corporation
MediaTek Inc.
Minnesota Mining & Mfg Company
Northrop Grumman Corporation
Oracle America Inc.
Oracle Corporation
Palantir Technologies, Inc.
Qualcomm Incorporated
Regeneron Pharmaceuticals
Schlumberger Foundation
State Farm Automobile Insurance
Texas Instruments Inc.
Two Sigma Investments LLC

Research Snapshots, just a few

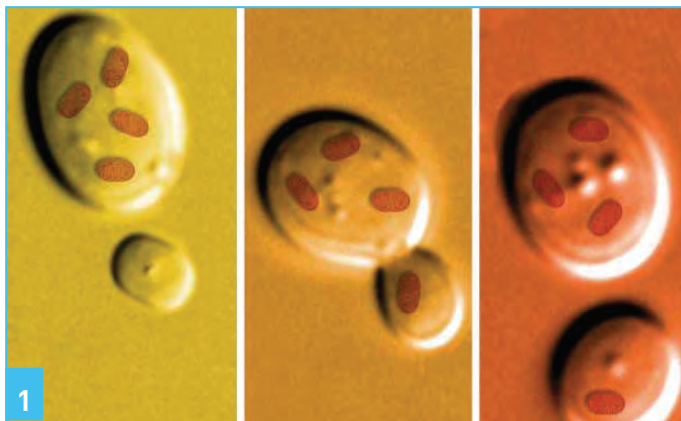

1



2

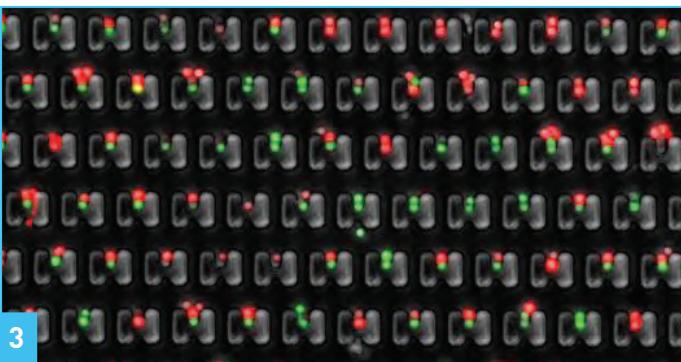

3

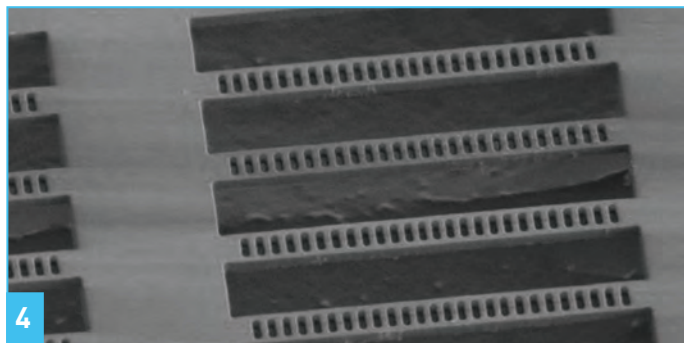

4



5

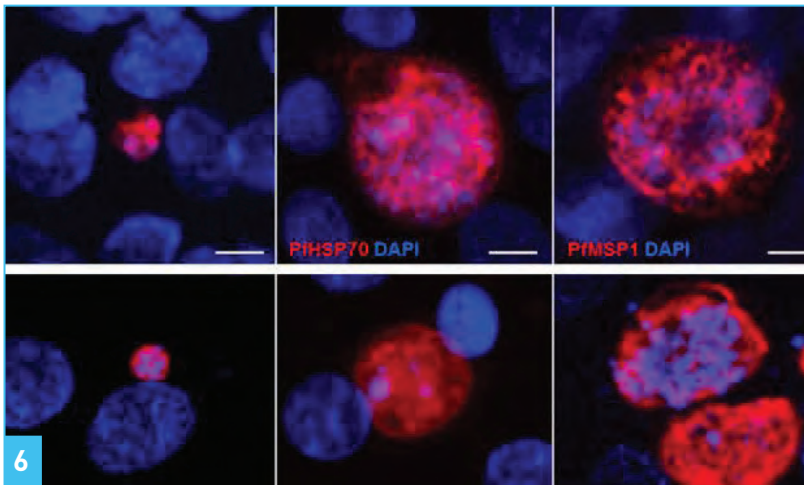

6

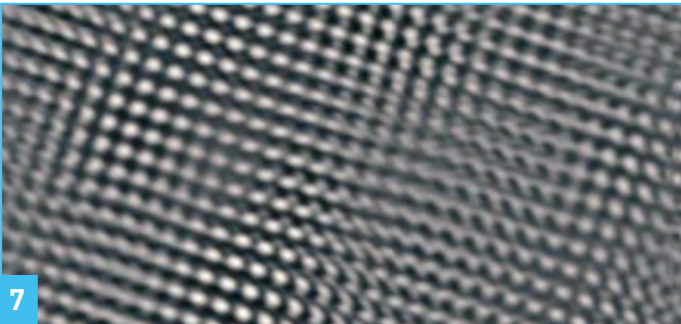

7

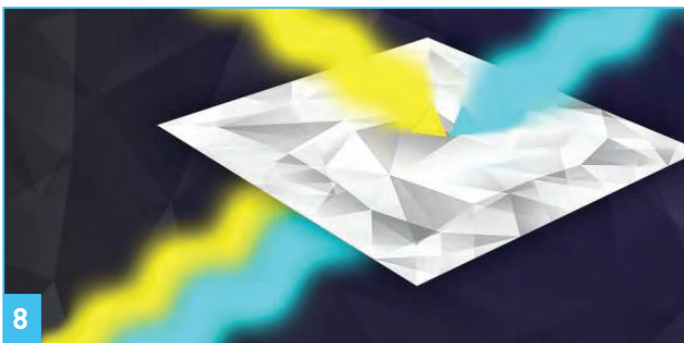

8

Check the EECS homepage for details on each of these research stories from March 2014 - March 2015. 1. Gifford reveals new nonchromosomal way to study genetic influence; 2. Chlipala develops Ur/Web, a new programming language for Web development; 3. Voldman develops new device to watch how immune cells communicate; 4. Englund teams to enhance duration of quantum states towards practical quantum computing; 5. Radio chip for Internet of things - Chandrakasan group extends battery

life by reducing idle transmitter power leaks; 6. Bhatia derives liver cells from stem cells for modeling malaria; 7. Ivry, Berggren discover new universal layer of superconductivity; 8. Shapiro, Wong, Zhang: Advantages of entanglement for quantum sensors outlive its existence. (www.eecs.mit.edu)

You may make corrections to your name, mailing address, or email address by sending email to mitalum@mit.edu or calling Alumni Records at 617-253-8270 or 800-648-1865

Getting through the Winter of 2015, the MIT EECS way

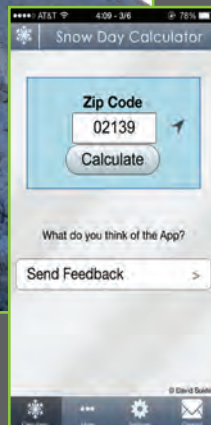
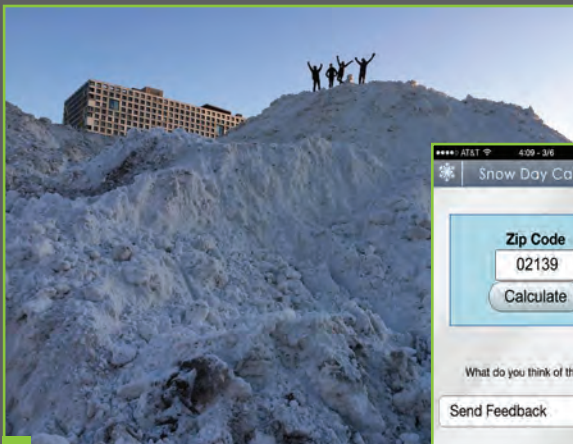

As the “MIT Alps” — a very large storage pile of snow from all around the MIT campus — grew behind Simmons Residence with students climbing its height, the *Boston Globe* picked up the story. About that time, EECS senior David Sukhin made WBUR’s blog as they revisited their coverage of his Snow Day Calculator, an app he created at age 16. And, just when we thought winter was endless, CSAIL’s spring-like robotic garden appeared. The MIT students learned their Alps was not safe — fortunately without injury. Sukhin reports that the Snow Day Calculator app (based on predicted snowfall) got heavy use (<http://www.snowdaycalculator.com/>). And, the CSAIL robotic garden has served as both a visual embodiment of Prof. Daniela Rus’ latest work in distributed computing as well as an aesthetically appealing way to get more young students, particularly girls, interested in programming. (<http://www.csail.mit.edu/node/2433>) Happy spring!

