

TYPE 06 TRENCH HEATER

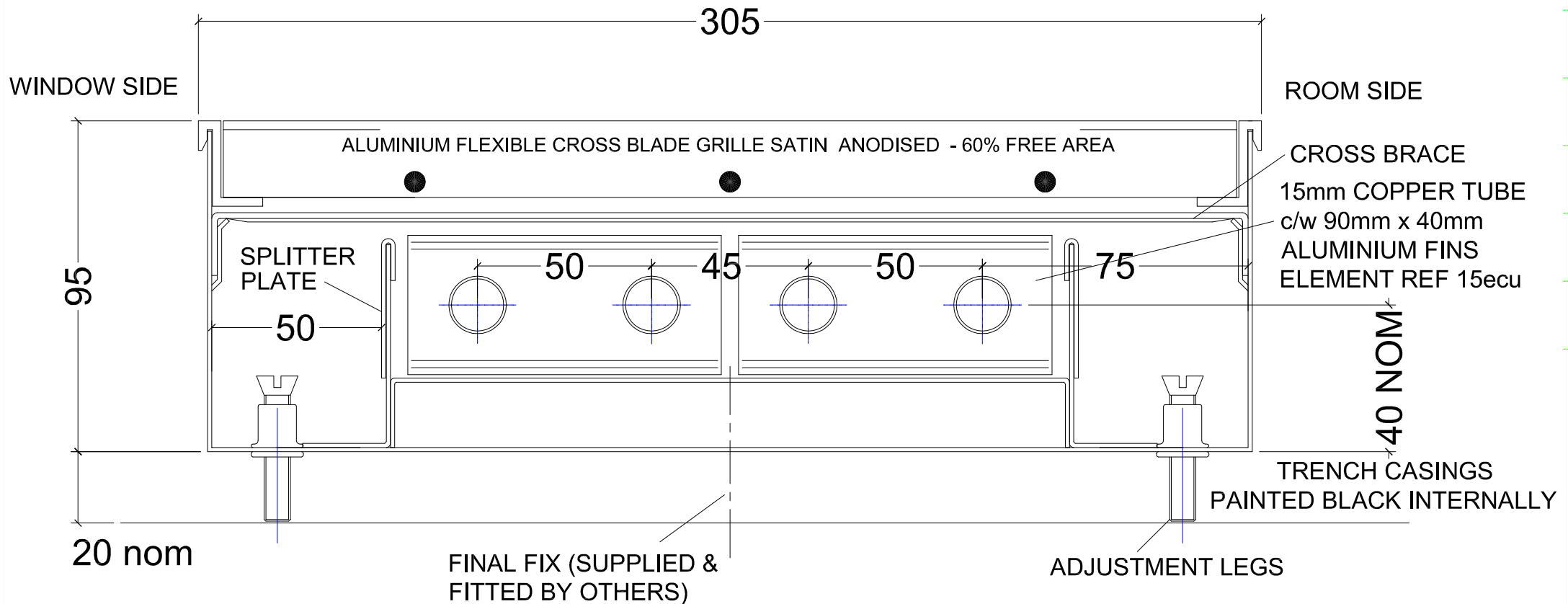

OUTPUT BASED ON CONDITIONS OF 76.5°C
MWT WITH AN EAT OF 18°C WITH A FR OF
0.92m/s IS 350w/m (FINNED ELEMENT LENGTH)