

OWNER'S MANUAL



Due to our continuous improvement programs, all models, operation, and/or specifications are subject to change without prior notice.

RLS510, Rev. B

05/01/09

Owner's Record

Spa Model: _____

Shell Color: _____

Spa Serial Number: _____

Date Purchased: _____

Date Delivered: _____

Date Installed: _____

Dealer's Name: _____

Dealer's Telephone Number: _____

Dealer's Address: _____

Your unique spa serial number is written in blue on a wood block, which is located below the topside control panel behind the front access cabinet panel. Please record the serial number and model number of your spa along with the installation date in the space provided above. **STORE THIS MANUAL WHERE YOU CAN EASILY FIND IT.** When calling for service, have your spa serial number in hand to expedite its servicing.



Location of your Spa Serial Number

Table of Contents

Introduction.....	3
Important Safety Instructions.....	4
General Spa Guidelines.....	7
Installation Instructions.....	9
Electrical Installation Requirements.....	10
Electrical Wiring Diagram.....	13
Initial Start-up Instructions.....	17
Operating Instructions.....	21
Feature Operations.....	24
Troubleshooting.....	25
Draining Your Spa.....	27
Spa Care and Maintenance.....	28
DIP Switches and Jumpers Definitions.....	32

Introduction

Congratulations on the purchase of your new spa! With proper preparation and care, your spa will give you many years of enjoyment. We believe that your spa will become a special place in your garden that allows your family and friends to relax, have fun and enjoy time together in a soothing, natural water environment.

Please remember, your spa is a powerful piece of electrical equipment. It is extremely important that you have it properly installed to ensure safe use. To properly acquaint yourself with your spa, we suggest that you take the time to read through this owner's manual before installing and operating your spa. And it is also a supplement to the training that you should receive from your spa dealer when you purchase and start up your spa for the first time. Doing so will familiarize you with important operating and safety procedures, thereby ensuring an enjoyable experience right from the start.

If you have any questions regarding this manual, please call your spa dealer, who will be happy to further assist you.

 **WARNING:** This manual was written to ensure the proper use and installation of your spa. Any modifications to the procedures outlined in this manual may result in your warranty being void.

This manual and its contents are subject to change without notice. Although we have prepared this manual as accurate and precise as possible, we will not be liable for loss, injury or damages caused by improper installation or improper use of the spa.

Important Safety Instructions

PLEASE TAKE THE TIME TO READ ALL OF THESE WARNINGS AND CAUTIONS BEFORE INSTALLING AND USING YOUR SPA.

Please be a responsible spa owner. When installing and using your spa, please always follow these basic safety precautions. Be certain to explain the safety precautions to all new or occasional users of your spa.

NOTE: A licensed electrician may be required to upgrade your standard receptacle and/or circuit breaker.

 **DANGER -- RISK OF CHILD DROWNING & INJURY:** To avoid accidents, ensure that children cannot use the spa unless they are supervised at all times. Make sure you always lock the cover after using your spa for children's safety.

Lower water temperatures are recommended for children. Children are especially sensitive to hot water.

 **DANGER -- RISK OF INJURY:** The suction fittings in this spa are sized to match the specific water flow created by the pump. Should the need arise to replace the suction fittings, or the pump, be sure the flow rates are compatible.

Never operate the spa if the suction fitting or filter baskets are broken or missing.

Never replace a suction fitting with one that is rated less than the flow rate marked on the original suction fitting.

 **DANGER -- RISK OF ELECTRICAL SHOCK:** Install the spa at least 5 feet (1.5m) from all metal surfaces. As an alternative, the spa may be installed within 5 feet (1.5m) of metal surfaces when each metal surface is permanently connected by a minimum 6mm² solid copper conductor to the outside of the spa's control box.

 **DANGER -- RISK OF ELECTRICAL SHOCK:** Do not permit any external electrical appliances, such as a light, telephone, radio, television and etc., within 5 feet

(1.5m) of the spa. Never attempt to operate any electrical device from inside the spa.

WARNING -- TO REDUCE THE RISK OF INJURY

The spa water should never exceed 40°C (104°F). Water temperatures between 38°C (100°F) and 40°C are considered safe for a healthy adult. Lower water temperatures are recommended for young children and when spa use exceeds 10 minutes.

High water temperatures have a high potential for causing fetal damage during pregnancy. Women who are pregnant, or who think they are pregnant, should always check with their physician prior to spa usage.

The use of alcohol, drugs or medication before or during spa use may lead to unconsciousness with the possibility of drowning.

Persons suffering from obesity, a medical history of heart disease, low or high blood pressure, circulatory system problems or diabetes should consult a physician before using the spa.

Persons using medications should consult a physician before using the spa since some medication may induce drowsiness while others may affect heart rate, blood pressure and circulation.

AVOID RISKS OF HYPERTHERMIA

Prolonged exposure to hot air or water can induce hyperthermia. Hyperthermia occurs when the internal temperature of the body reaches a level above 2°C to 4°C the normal body temperature of 37°C. While hyperthermia has many health benefits, it is important not to allow your body's core temperature to rise above 39.5°C. Symptoms of excessive hyperthermia include dizziness, lethargy, drowsiness and fainting. The effects of excessive hyperthermia may include:

- Failure to perceive heat
- Failure to recognize the need to exit spa
- Unawareness of impending hazard

- Fetal damage in pregnant women
- Physical inability to exit the spa
- Unconsciousness

⚠️WARNING: The use of alcohol, drugs, or medication can greatly increase the risk of fatal hyperthermia.

AVOID RISKS OF BURNS

- Before entering a spa, measure the water temperature with an accurate thermometer since the tolerance of temperature-regulating devices may vary by as much as $\pm 5^{\circ}\text{F}$ (2°C).
- Test the water with your hand before entering the spa to be sure it's comfortable.

FOR SPAS EQUIPPED WITH AUDIO COMPONENTS

Audio components are optional and available on all spa models.

⚠️WARNING: Do not connect any auxiliary components – for example, cable, additional speakers, headphones, etc., to the system.

⚠️Caution: Do not leave audio compartment door open. Replace audio components only with identical components.



General Spa Guidelines

Your new spa is meant to be enjoyable, healthful and relaxing. The following operating and maintenance instructions are very important and must be followed carefully.

- Always check the water temperature by hand before entering your spa. High water temperatures can be hazardous to your health.
- Children should not use spas without adult supervision.
- Do not use your spa alone.
- Keep all glass and other breakables away from the spa area.
- Enter and exit the spa slowly. Wet surfaces can be slippery.
- Prolonged immersion can be hazardous to your health.
- Maintain water chemistry in accordance with manufacturer's instructions.

Your new spa has been engineered with a high-powered water pump that pushes water through various hydro-therapy jets, which will relax even the tightest muscles.

The filtering of the spa is very important. It will minimize cleaning time and the amount of chemicals needed to keep your spa water balanced. The two daily programmable filter cycles can be set for any duration up to 11 hours if the need arises. This can be accomplished through the topside control panel.

IMPORTANT: Keep your spa securely covered when not in use!

- Covered spas use less electricity while maintaining a set temperature.
- Covering your spa will protect your spa's finish from the sun's ultraviolet rays.
- You are required to keep the spa covered to maintain warranty coverage.
- Covering your spa helps prevent children from drowning in the spa.

Your new spa comes equipped with an electric heater. Follow the instructions

mentioned below will ensure the most efficient operation:

- Keep the spa's operating temperature 2°C below the desired usage temperature when not in use. One or two hours before use, set the temperature to the desired temperature.
- If the spa usage exceeds two hours a week, the set temperature should remain at the desired usage temperature.
- The air venturis should be used sparingly. When open, water temperature drops quite rapidly and can also dissipate chemicals.

NOTE: This method is only for spa usage under two hours a week.

- The filter needs to be cleaned or changed on a regular basis. This process takes only a few minutes and the result is increased water clarity and equipment longevity.
- Water level is very important to the operation of your spa. If the water level is too low or too high, your spa will not operate properly. The water level should be approximately 1" above the highest jet (or about ½" below the pillow) when the spa is not being used.
- We recommend that your spa water be changed every 2 to 3 months. You may find the need to change your spa water more frequently with heavy use. When empty, your spa should be cleaned with a non-abrasive cleaner then rinsed thoroughly.
- When filling your spa, always fill through the skimmer filter canister. Use only regular tap water.
- See page 27 for instructions on draining your spa.



WARNING: DO NOT USE SOFT WATER IN YOUR SPA!

Installation Instructions

Proper planning is an important consideration when installing your new spa. Site selection is a critical step and should be given some serious thought. Planning ahead, before the delivery of your spa, makes the installation process easier.

SITE SELECTION AND PREPARATION

The following information is provided to assist you in finding the right location for your new spa:

(1) Place your spa on a structurally strong, solid and reasonably level surface that is large enough for the entire spa to fit. A filled spa is extremely heavy. Make sure that the location you choose can support the weight of your filled spa. Uneven settling could cause a spa to crack, or structural damage due to an improper foundation is not covered under warranty.

(2) Be sure your spa will fit into the space you have chosen. Always comply with local building codes with respect to gates, fences, etc.

(3) Ensure that the spa installation and location allow a clear and unobstructed access on ALL SIDES of the spa for normal servicing. Be sure your spa has proper access to all electrical components, circuit breakers, fuses, cabinet panels, etc. Failure to do so may result in additional charges or assessments to service and/or repair the spa.

(4) Ensure that water drains away from the spa in order to keep water out of the equipment compartment and away from all electrical components. Remember, the electrical components inside your spa must be kept dry.

(5) Provide adequate ventilation for the humidity created by your spa. In most cases, a spa cover is sufficient.

(6) Check the load carrying capabilities of the floor on which the spa will reside. Most homes should meet the requirement of 80 pounds per square foot.

Electrical Installation Requirements

It is the responsibility of the spa owner to ensure that a qualified and licensed electrician performs the electrical installation. And this installation must be in accordance with the National Electrical Code; local and state electrical codes. The following information is provided for hooking up the electrical power supply to your new spa.

⚠️ WARNING: Do not turn on the power to your spa until you are told to do so later in this Owner's Manual. Improper electrical connections may damage the equipment, cause injury, cause a fire, and void your spa warranty.

IMPORTANT: In most areas, Residual Current Device (RCD) is required for spa installation. In other areas, RCD's are recommended for spa installations, but are not mandatory.

If the spa you are servicing was not installed with RCD, we strongly urge you to improve safety and comply with current standards by installing one. Failure to do so will cause equipment damage and will not be covered under your warranty.



POWER REQUIREMENTS

Single Service [3 wires (line, neutral, ground)]

I 230VAC, 50Hz, 1~, 16A/32A, (Circuit Breaker rating = 20A/40A max.)

Dual Service [5 wires (line 1, neutral 1, line 2, neutral 2, ground)]

I 230VAC, 50Hz, 1~, 2 x 16A, (Circuit Breaker rating = 20A max each service.)

3-Phase Service [5 wires (line 1, line 2, line 3, neutral, ground)]

I 400VAC, 50Hz, 3N~, 16A, (Circuit Breaker rating = 20A max each phase line.)

IMPORTANT: Service must include a neutral wire, with a line to neutral voltage of

230VAC.

OTHER REQUIREMENTS

⚠Caution: Your spa must be wired by a qualified and licensed electrician, and according to the instructions below. Failure to do so will terminate all warranties.

- (1) The spa must be hard wired to the power supply, with no plug-in connections, extension cords, or sharing of service.
- (2) The spa requires that you run 6mm² solid copper wire, depending on the size of the residual current device (RCD) that you use. Do not use Aluminium wire.
- (3) The power supply must have a suitable residual current device (RCD). This could be used as the shut-off switch, which must be installed in plain view of the spa. This electrical service must be readily accessible to the spa owner, but must not be within 5 feet (1.5m) of the spa.
- (4) Use only non-metallic conduit and fittings while installing power to your spa.
- (5) After your spa has been positioned, route lines through the knockout on the left or right front corner of your spa.
- (6) Connect the electrical power to your spa.

ELECTRICAL CONNECTIONS

To hook up your spa, please follow the instructions below:

- 1) Remove the screws and cabinet panel on the side of the spa under the topside control panel, and then set the cabinet panel aside.
- 2) After removing the cabinet panel, locate the electrical control box. Loosen the screws on the front of the control box. Remove the screws and the control box cover.

3) Run a flexible non-metallic conduit from the power source to the spa, through the hole in the left or right front corner and into the electrical control box.

4) After pulling all lead wires through the non-metallic conduit, connect the lead wires (color to color) to the proper terminals as indicated by the wiring diagram on the back of the control box cover. Make sure the wires are properly tightened.

5) A grounding lug has been provided on the exterior of the control box to allow connection of a ground wire to a local grounding point to be established in compliance with the National Electric Code (NEC) and all local codes (See Figure 1).

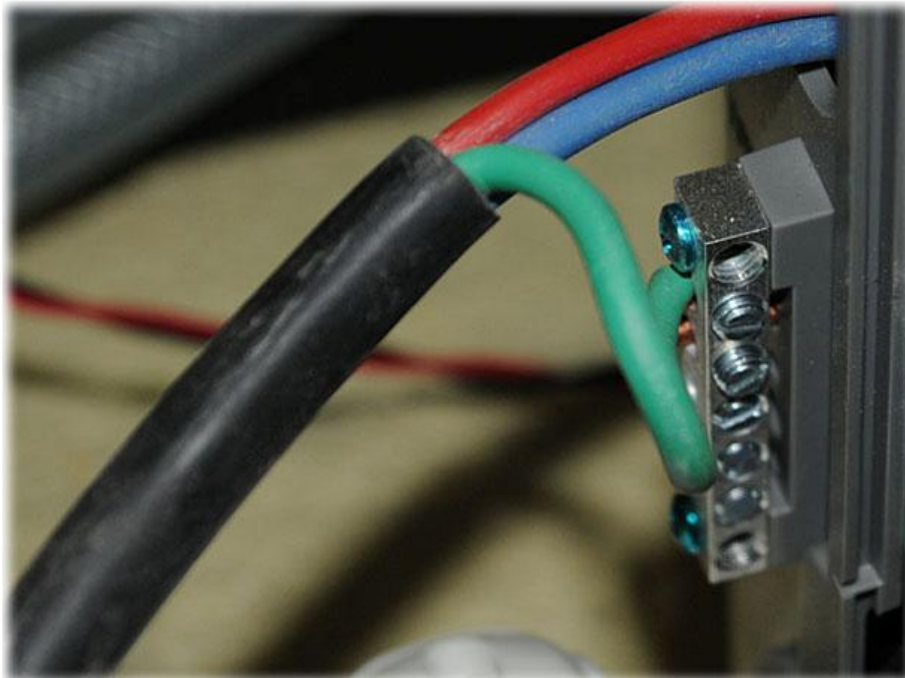

Figure 1

6) Close the control box cover and secure with screws.

7) Electrical connection is now complete.

Electrical Wiring Diagram

NOTE: This wiring diagram is meant as a guide only and not as instructions on how to wire the RCD. Different brands of RCD may be wired differently. The RCD must be wired by a qualified and licensed electrician.

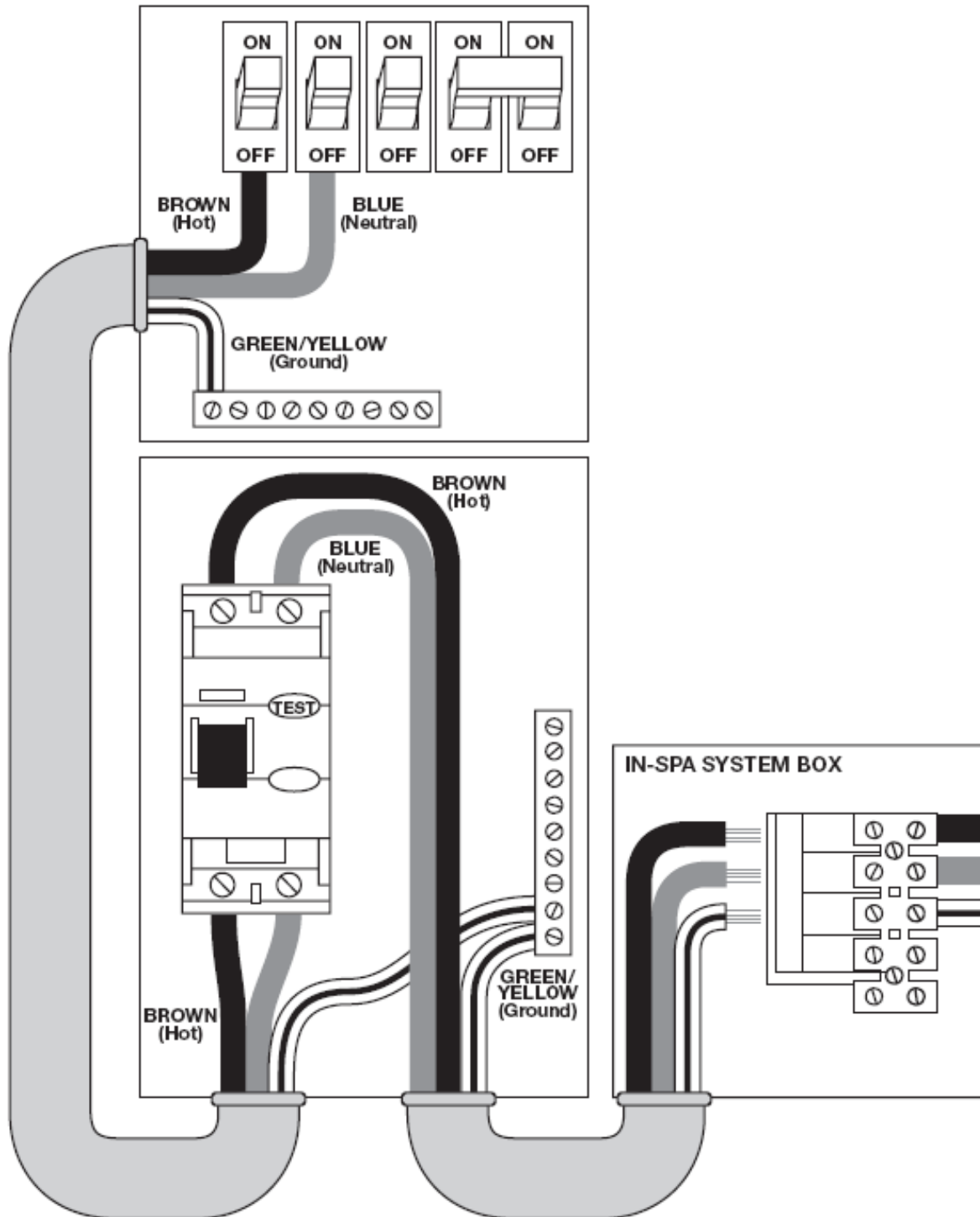

Single Service (1 x 16 Amp or 1 x 32 Amp)

3 Wires (1 Line + 1 Neutral + 1 Protective Earth)

Protective Earth wire (Green/Yellow) must be connected to system ground terminal as marked.

This option is configured and shipped as the default.

All equipment (pumps, blower, and heater) runs on service line L1.

Systems using only 1 DIP switch (A10) for heat disable:

For 1 x 16 Amp Service:

DIP Switch A10 must be ON.

For 1 x 32 Amp Service:

Set DIP Switch A10 such that total system amperage draw never exceeds rated service input.

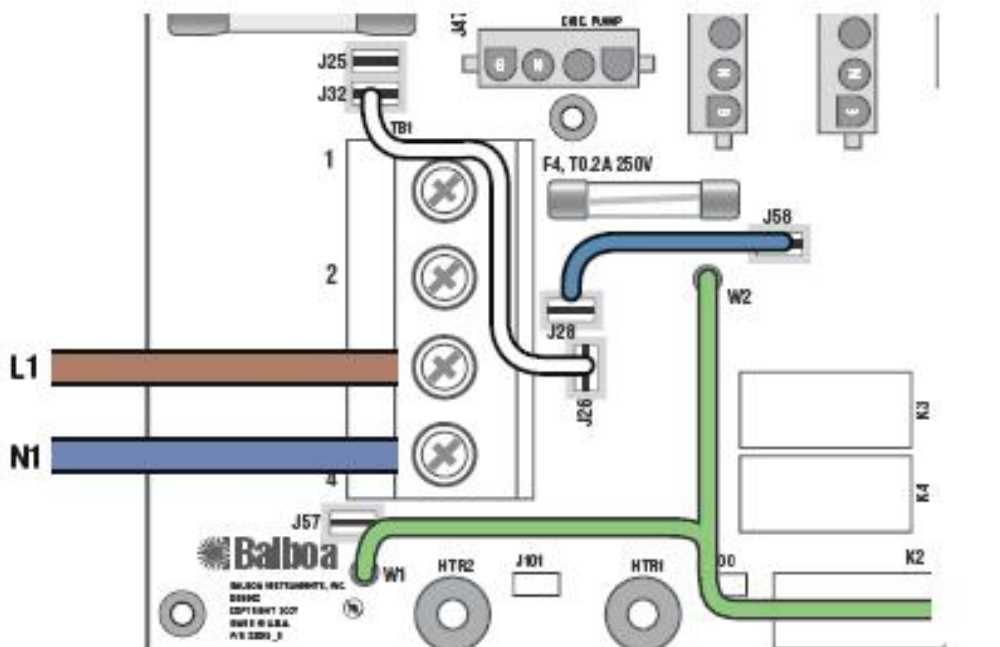

NOTE: Original wiring diagram is attached to the back of the control box cover.

3-Phase Service (3 x 16 Amp)

5 Wires (3 Lines + 1 Neutral + 1 Protective Earth)

Protective Earth wire (Green/Yellow) must be connected to system ground terminal as marked.

IMPORTANT: Service MUST include a neutral wire, with a line to neutral voltage of 230VAC.

The heater runs on service line L1. All main-board equipments run on service line L3. Additional equipment, such as expansion boards, run on service line L2.

Completely remove the white wire from J26 and J32, or J25.

Completely remove the blue wire from J28 and J58.

If an expansion board is installed, black wire must connect to J28 (Line L2) only.

Systems using only 1 DIP switch (A10) for heat disable:

DIP Switch A10 must be OFF.

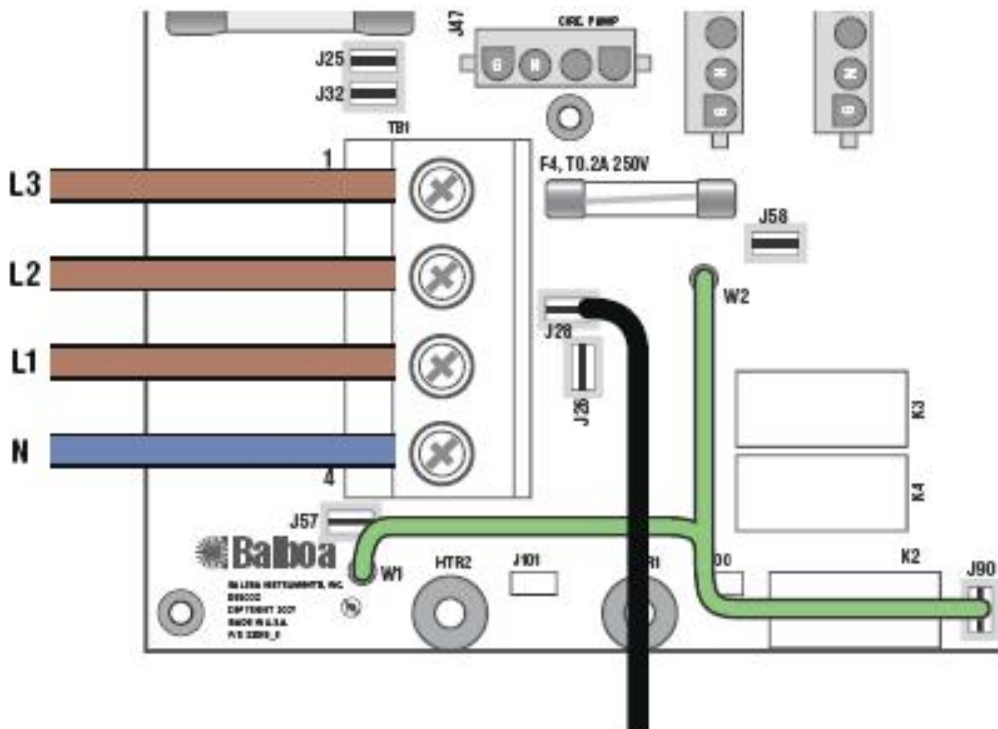

To an optional fuse-protected expansion board.

NOTE: Original wiring diagram is attached to the back of the control box cover.

Initial Start-up Instructions

IMPORTANT: Read these step-by-step startup procedures before starting your spa. Failure to follow any of the below mentioned instructions may result in damage to the equipment and may void your warranty.

⚠Caution: Do not turn on the power to an empty or partially filled spa. Running the spa pump dry (without water running through it) can cause IMMEDIATE damage and will void the warranty! Be sure that the spa is installed properly in accordance with the installation instructions in this manual.

INSPECTION

You will have to inspect your spa before filling it with water. Go through the following steps to prevent common issues when hooking up your spa for the first time.

- 1) Turn the power off to the spa at the main breaker.
- 2) Remove the synthetic cabinet panels on the side of the spa to access the internal electrical components and equipments.
- 3) Rotate all the jets in the spa to a clockwise position (fully open position).
- 4) Be sure all ball valves are fully opened to the heater and all pumps.
- 5) Check the heater unions and pump unions to assure that they are tight to prevent the possibility of leakage in the equipment's area (Each pump has 2 unions and the heater has 2 unions, a newly delivered spa may have loose unions caused in transporting the spa). These are hand-tightened and do not need any kind of special tools to tighten them.

⚠Caution: Do not use a wrench. Over-tightening may cause damage to unions and gaskets, which will not be covered under warranty.

- 6) Check that there are no obvious signs of loose wires or broken pipes.

7) Clean out any debris from within the service access area or inside of the spa itself.

8) Make sure that the drain valve is closed (See page 27).

9) Clean and polish the surfaces of your spa.

FILLING YOUR SPA WITH WATER

 **Caution:** DO NOT fill your spa with hot water straight out of your water heater or tap. This water may be as hot as 82.2°C (180°F) and will cause damage to the surface and plumbing of the spa. This will void your warranty. Level your spa before filling.

Now it's time to fill your spa with water. Do not turn on the power to the spa until your spa is completely filled. The following is the recommended method for properly filling your spa:

1) Remove the filter lid / cup holder and set it aside.

2) Remove the floating weir and basket. Then remove the filter cartridge by pulling it out from the filter canister.

3) Place a garden hose in the center of the filter canister.

4) Fill the spa with water from the circulation pump line until water level is above the foot-well.

NOTE: This will purge all the air out of the circulation pump. An air lock can cause damage to the circulation pump and this will void your warranty.

5) Once the water level is filled over the foot-well, you can pull the hose out of the filter canister and continue filling the spa from foot-well area of the spa shell.

6) Fill the spa until the water level is about 1" above the highest jet (or about ½" below the pillow). Do not over fill.

NOTE: Every person entering the spa will displace a given volume of water, so adjust water level to the number of people regularly using the spa.

7) Turn off the hose, then verify there are no leaks at the pump unions during filling your spa.

8) Reinstall the filter cartridge and basket into the filter canister.

TURNING THE POWER ON

 **WARNING:** Do not turn on any pump until your spa is properly filled with water. Running any pump without water in your spa can cause IMMEDIATE damage, which will not be covered under warranty!

After filling your spa with water to a level of approximately 1" above the highest jet (or about ½" below the pillow), you can turn on the power to the spa at the main circuit breaker. Verify that your spa has no error codes. If you encounter a problem, please refer to the troubleshooting guide (See page 25).

TESTING THE RCD BREAKER

Test the RCD breaker prior to first use and periodically when power to the spa is turned on. To test the RCD breaker, please follow these instructions (spa should be operating):

1) Press the "TEST" button on the RCD. The RCD will trip and the spa will shut off.

2) Reset the RCD breaker by switching the breaker to the full "OFF" position, wait a moment, then turn the breaker back on. The spa should have power again.

 **DANGER -- RISK OF ELECTRICAL SHOCK:** If the RCD breaker fails to operate as described, there is a possibility of an electrical shock if the spa is used. Turn off the power at the main electrical service panel until the source of the problem has been identified and corrected by a licensed electrician or qualified spa technician.

PRIMING THE PUMP(S)

When filling your spa for the first time or, after draining and refilling the spa, you may need to bleed air from the system. Due to the nature of water flow and hydro-therapy pumps, please be advised that air locking of pumps may occur. We have taken measures to reduce the possibility of this, but it still may occur, especially after refilling your spa. This is not a service covered under warranty.

If an air lock still occurs, follow the instructions below.

- 1) Turn the pump off by shutting off the power to your spa at the main breaker panel.
- 2) Remove the synthetic cabinet panels on the side of the spa to access the pumps.
- 3) Loosen the pump unions until you hear all the air escapes and water starts to drip out (See Figure 2).



Figure 2

- 4) Once water drips out in a continuous stream, hand tighten the unions until the water stops leaking.
- 5) Turn on the pump to make sure that there are no leaks.
- 6) Reinstall the cabinet side panel.

⚠ Caution: Running your spa continuously without water flow will damage your pump(s) and void your warranty.

Operating Instructions



Button shapes and labels may vary.

Initial Start-up

When your spa is first actuated, it will go into Priming mode (after displaying some configuration information). The Priming mode will last for less than 5 minutes and then the spa will begin to heat the spa and maintain the water temperature in the Standard mode. You can exit Priming mode early by pressing "Warm" or "Cool" button.

Temp Set (80°F - 104°F / 26.0°C - 40.0°C)

The start-up temperature is set at 100.4°F/38°C. The last measured water temperature is constantly displayed on the LCD.

NOTE: The water temperature displayed is current only when the pump has been running for at least 2 minutes.

Temp Control

Press the "Warm" or "Cool" button once to display the set temperature. To change the set temperature, press a temperature button again before the display stops flashing. After three seconds, the display will stop flashing and begin to display the current spa temperature.

Mode

A button combination is used to switch between standard, economy, and sleep modes. Mode is changed by pressing "Warm" or "Cool", then pressing "Mode" button.

Standard Mode maintains the desired temperature. "Std" will be displayed momentarily when you switch into Standard Mode.

Economy Mode heats the spa to the set temperature only during filter cycles. "**Ecn**" will display when water temperature is not current, and will alternate with water temperature when the pump is running.

Sleep Mode heats the spa to within 20°F/10°C of the set temperature only during filter cycles. "**SLP**" will display when water temperature is not current, and will alternate with water temperature when the pump is running.

Jets 1

Press "Jets 1" button once to turn the pump 1 on. Press "Jets 1" button a second time to turn the pump 1 off.

NOTE: If left running, the pump 1 will turn off after 15 minutes.

Jets 2

Press "Jets 2" button once to turn the pump 2 on. Press "Jets 2" button a second time to turn the pump 2 off.

NOTE: If left running, the pump 2 will turn off after 15 minutes.

Blower (optional)

Press the "Blower" button once to turn the blower on. Press the "Blower" button a second time to turn the blower off.

NOTE: If left on, the blower will automatically turn off after 15 minutes.

Light

Press the "Light" button to turn the spa light on and off. To select a specific color, simply press the "Light" button to turn off the spa light, immediately press the "Light" button again to change the spa light to the next color selection. Continue until the desired color is reached. This feature allows the spa owner to retain a favorite color operation mode. And the color operation modes are available:

- Spectrum Quick Dance: fade through all 7 colors, 1 second/color
- Spectrum Slow Dance: fade through all 7 colors, 10 seconds/ color
- Color Burst: strobe effect change through all 7 colors, 5 seconds/ color
- Spectrum Slow Dance: fade through all 7 colors, 6 seconds/ color

- Spectrum Quick Dance: fade through all 7 colors, 0.05 second/ color
- Tidal (fade between blue and green)
- Blue
- Red
- Green
- Cyan
- Purple

NOTE: If the spa light is left on, it will automatically turn off after 4 hours.

Preset Filter Cycles

The first preset filter cycle begins 6 minutes after the spa is powered up. The second preset filter cycle begins 12 hours later. Filter duration is programmable for 2, 4, 6, or 8 hours or for continuous filtration (indicated by "**F1LC**"). The default filter time is 4 hours for circ systems.

Setting Filter Cycles

To program, press "Warm" or "Cool" button, then "Jets 1" button. Press "Warm" or "Cool" button to adjust. Press "Jets 1" button to exit the programming mode.

For circulation systems, the circ pump and the ozone generator run 24 hours. In hot environments, the circ pump may turn off for 30 minute periods, except during filter cycles. At the beginning of each filter cycle all other equipment will run briefly to purge the plumbing.

Feature Operations

DIVERTER VALVE

Your spa is equipped with a diverter valve. This valve can be used to divert jet power from one area in the spa to another area. This valve is fully adjustable and can be used to suit the user's desired effect. The valve may be slightly harder to turn when the water pump is operating. This is normal due to high rate of water flow and pressure present in the valve.

AIR CONTROL VALVES

Your spa is equipped with some air control valves. The air control valve is an on/off valve that allows air to be introduced into a specific jet configuration resulting in a more vigorous jet action. Turn the valve handle counterclockwise to turn the air on, and clockwise to turn the air off. Opening the valve increases jet pressure and closing the valve decreases the jet pressure.

AROMATHERAPY CANISTER (optional)

Your spa is equipped with an aromatherapy canister. This canister is to dispense your favorite fragrance via the champagne air bubble.

WATERFALL / Fountain (optional)

Your spa may be equipped with a waterfall or fountain which is set into the top rim of the spa. Water from the spa circulation system flows into a closed end of a channel located in the top rim and along the channel to the open end located at the edge of the top rim on the inside wall to fall into the body of water in the spa.

Troubleshooting

Should you experience and problem whatsoever, please do not hesitate to contact your spa dealer. Here are some tips to help you to diagnose and rectify more common sources of trouble yourself, if you choose to do so.

Message	Meaning	Action Required
	No message on display. Power has been cut off to the spa.	The control panel will be disabled until power returns. Spa settings will be preserved until next power up.
— —	Temperature unknown.	After the pump has been running for 2 minutes, the current water temperature will be displayed.
OHH	"Overheat" - The spa has shut down. One of the sensors has detected 118°F/47.8°C at the heater.	DO NOT ENTER THE WATER. Remove the spa cover and allow water to cool. Once the heater has cooled, reset by pushing any button. If spa does not reset, shut off the power to the spa and call your dealer or service organization.
OHS	"Overheat" - The spa has shut down. One of the sensors has detected that the spa water is 110°F/43.5°C.	DO NOT ENTER THE WATER. Remove the spa cover and allow water to cool. At 107°F/41.7°C, the spa should automatically reset. If spa does not reset, shut off the power to the spa and call your dealer or service organization.
SnA	Spa is shut down. The sensor that is plugged into the Sensor "A" jack is not working.	If the problem persists, contact your dealer or service organization. (May appear temporarily in an overheat condition.)
Snb	Spa is shut down. The sensor that is plugged into the Sensor "B" jack is not working.	If the problem persists, contact your dealer or service organization. (May appear temporarily in an overheat condition.)
SnS	Sensors are out of balance. If alternating with spa temperature, it may just be a temporary condition. If flashing by itself, spa is shut down.	If the problem persists, contact your dealer or service organization.

HFL	A significant difference between temperature sensors has been detected. This could indicate a flow problem.	If the water level is normal, make sure all pumps have been primed. If problem persists, contact your dealer or service organization.
LF	Persistent low flow problems. (Displays on the fifth occurrence of HFL message within 24 hours.) Heater is shut down, but other spa functions continue to run normally.	Follow action required for HFL message. Heating capability of the spa will not reset automatically; you may press any button to reset.
dr	Possible inadequate water, poor flow, or air bubbles in detected in the heater. Spa is shut down for 15 minutes.	If water level is normal, make sure all pumps have been primed. Press any button to reset. This message will reset within 15 minutes. If problem persists, contact your dealer or service organization.
dry	Inadequate water detected in heater. (Displays on third occurrence of dr message.) Spa is shut down.	Follow action required for dr message. Spa will not automatically reset. Press any button to reset manually.
ICE	"Ice" - Potential freeze condition detected.	No action required. All equipment will automatically activate regardless of spa status. The equipment stays on 4 minutes after the sensors detect that the spa temperature has risen to 45°F/7.2°C or higher. An optional freeze sensor may be added to protect against extraordinary freeze conditions. Auxiliary freeze sensor protection is advisable in colder climates. See your dealer for details.

 Warning! Shock Hazard! No User Serviceable Parts.

Do not attempt service of this control system. Contact your dealer or service organization for assistance. Follow all owner's manual power connection instructions. Installation must be performed by a licensed electrician and all grounding connections must be properly installed.

Draining Your Spa

Your spa needs to be drained, cleaned, and refilled approximately every 2 to 3 months. For heavier spa use, you may wish to change the water more frequently. The following is the recommended method for draining your spa.

1) Turn off the power to your spa at the main breaker panel.

NOTE: Do not leave an empty spa exposed for long periods of time in hot and sunny weather.

2) Remove the spa cover and allow the spa water to cool down.

3) The drain valve is located in the front-left corner at the base of the spa (See figure 3).



Figure 3

4) Grasp the hose bib cap and turn it counterclockwise. The hose bib fitting will then be able to be pulled out slightly and the cap can be removed. Attach a garden hose to the end of hose bib and allow the water to drain away from your spa. It will take most spas 3-4 hours to drain using the hose bib.

5) When all water has been evacuated, turn the hose bib fitting clockwise until it stops. Remove the garden hose, then screw the cap onto the end of hose bib.

6) To refill your spa, please follow the initial start-up procedures to reheat the spa.

Spa Care and Maintenance

FILTER CLEANING

Your new spa has been designed for quick and easy filter maintenance. On initial start-up, the filter should be cleaned every other day for the first two weeks of operation. We recommend the filter to be cleaned once a week to avoid a decrease in jet performance. We also recommend having an extra replacement filter on hand, which is to install when cleaning the filter. To clean the filter, please follow the steps below:

- 1) Turn power off to your spa at the breaker.
- 2) Remove the filter lid / cup holder and set it aside.
- 3) Remove the floating weir and basket.
- 4) Remove the filter cartridge by pulling it out from the filter canister.
- 5) Clean the filter cartridge with a garden hose as follows:
 - a. Hold the filter cartridge vertically.
 - b. Spray the filter cartridge with a pressure nozzle, starting from the top and spraying down each pleat.
 - c. Turn the filter cartridge over and repeat step a & b.
- 6) To reinsert the filter cartridge, please follow the steps in the reverse sequence.

 **WARNING:** Power to your spa must be turned off prior to removing and cleaning the filter. The suction at the filter is extremely strong and can cause injury if there is no filter. NEVER operate the spa without any filter in place or never use your spa without the filter properly installed. If done, damage will result to the pumps and other electrical components. Any damage to the electrical components due to this circumstance will not be covered under warranty.

CARE FOR SPA COVER

Proper care and cleaning of your spa cover is an important part of routine maintenance. Dirt acts as an abrasive to the vinyl topcoat of spa cover, and can also cause wear to folds, seams, and stitching. Mildew growing on damp, dirty vinyl will begin to actually root in the fabric, accelerating failure. Your cover will last much longer if you heed the following suggestions:

- 1) Rinse the vinyl topcoat with cool water.

- 2) Spray with a gentle, non-foaming cleaner and wipe clean. Never use laundry detergent, abrasives, alcohols, dish soaps or harsh cleaners. These can actually remove some of the topcoat and cause premature vinyl failure.

- 3) For stubborn dirt, use a non-abrasive sponge.

- 4) Rinse the spa cover again thoroughly with water and allow it to dry completely.

⚠Caution: Your spa cover is affected by the UV in sunlight. Periodic treatment with a liquid protectant will extend the life of your spa. The wrong kind of protectant can be more harmful than no protectant at all. Keep any product away from your spa, which is labeled "flammable" that contains any type of oil, or that leaves a waxy coating on your spa cover.

NOTE: Never stand or sit on the cover (The insulating foam in your cover is not designed to hold the weight of a person or an animal). Cracked foam in the cover is not covered under warranty! Never drag it over abrasive surfaces.

Keep the spa covered when not in use! Doing so will be utilized to discourage unsupervised children from entering the spa and to minimize heat loss. Small locks are available for the cover tie downs.

CARE FOR PILLOWS

Remove and clean the pillows with soapy water and a soft cloth when needed. Use a vinyl conditioner once a month. Remove pillows when doing chemical shock treatment.

 **WARNING:** Do not use oil-based vinyl protectants on the pillows. These products will cause severe water clarity issues that are difficult to correct.

CARE FOR JETS

We recommend that you clean your jets when you drain your spa. However, if you do need to clean your jets in between this will be accomplished with a full spa.

1) Remove the jet internal by turning it counterclockwise to the off position until it stops. Continue to turn the jet past the stop point to loosen it from the spa. The jet internal will now pull out.

2) Soak the jet internal in a mixture of 1 part vinegar to two parts warm water for 2-3 hours. Periodically rotate the spinner nozzle to break up residue in the jet.

3) Rinse the jet internal with warm water.

4) Reinstall the jet internal into the jet body and turn clockwise until fully seated, then tug to make sure it is seated properly. You can then continue to turn clockwise until it stops.

NOTE: A jet with stainless steel cover can be slippery. You can use a soft cloth or jar-opening pad to assist in removing and installing the jet.

CARE FOR SPA SURFACE

With a minimum amount of care and cleaning for the acrylic surface, your spa will look new for years.

After draining the spa, wipe the surface with a soft damp cloth (or sponge) using household soap or liquid detergent. Be sure to rinse detergent well as this will cause suds when refilling the spa.

NOTE: It is important that you do not use any abrasive cleaners or strong chemicals.

CARE FOR SPA CABINET

Your spa comes with a beautiful wood-looking synthetic cabinet. This synthetic cabinet requires little or no maintenance of any kind. To clean, simply wipe the cabinet panels with a clean towel and mild detergent soap solution.

⚠Caution: Do not use any cleaning products containing abrasives or solvents since these could damage the surface of the spa cabinets and void your warranty.

SPECIAL COLD WEATHER INSTRUCTIONS (WINTERIZING)

Winter can be one of the most enjoyable times of the year to enjoy your spa. As it is difficult to get water out of the plumbing lines, **WE DO NOT RECOMMEND DRAINING YOUR SPA FOR THE WINTER.** However, if you decide not to use your spa during the winter, we recommend you winterize as follows:

- 1) If you drain your spa, turn off the main power to the spa. Drain as completely as possible. You may want to use a wet-vacuum or high-pressure blower to evacuate as much water as possible.
- 2) When the spa is completely empty, loosen all pump unions and fittings to allow air and water to expand freely within the system. This should help prevent water from freezing and damaging pipes and fittings. The idea is to try to eliminate water from any sealed areas in the system.

A power outage can cause your spa equipment system to freeze quickly. During freezing conditions, check your spa frequently to ensure proper operation. Be sure to check your spa after any power failure to ensure the spa is operational.

For additional information on winterizing your spa, please contact your spa dealer.

DIP Switches and Jumpers Definitions

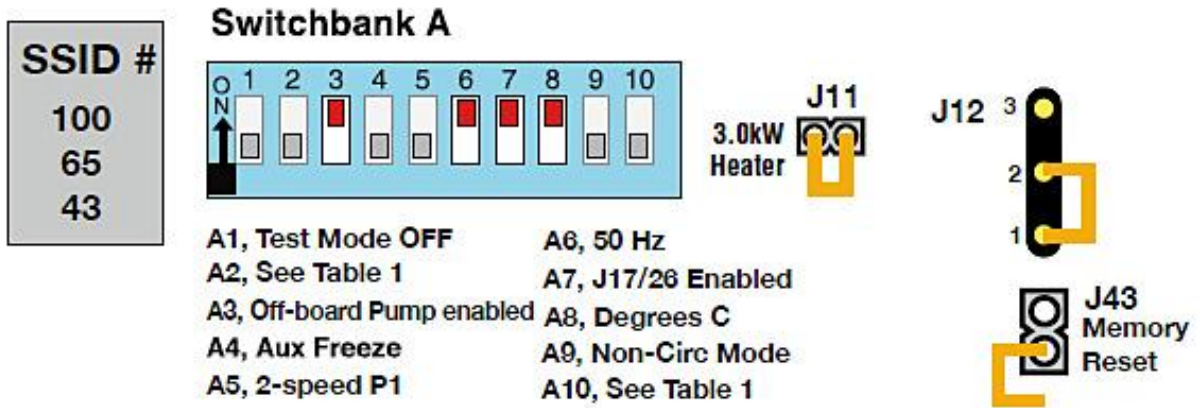

SSID 100 65 43

DIP Switch Key

A1 Test Mode (normally OFF)

A2+A10 Control amp draw requirements (See Table 1)

<u>A2</u>	<u>A10</u>	
OFF	OFF	0
ON	OFF	1
OFF	ON	2
ON	ON	3

A3 "ON" position: off-board pump enabled *

"OFF" position: off-board pump disabled

A4 Aux Freeze (must be OFF)

A5+A9 Pump 1 speeds and Circ Modes:

<u>A5</u>	<u>A9</u>	Circ Mode	Pump 1 Speed
OFF	OFF	Non-circ	2-speed
ON	OFF	Circ "acts like Pump 1 low" (filters/polls/ect)	1-speed
OFF	ON	24 hours with 3°F shut-off	1-speed
ON	ON	24 hours with 3°F shut-off	2-speed

A6 "ON" position: 50Hz operation

"OFF" position: 60Hz operation

A7 "ON" position: J17/26 equipment enabled *

"OFF" position: J17/26 equipment disabled

A8 "ON" position: temperature is displayed in degrees Celsius

"OFF" position: temperature is displayed in degrees Fahrenheit

* Panel with button layout  is not compatible when both A3 and A7 are ON.

Jumper Key

J11

If using 3kW or higher wattage heater, jumper can be set in either position, but may perform better on Pins 1 and 2.

If using 2.5kW or lower wattage heater, jumper must be set on 1 Pin only.

J12

Factory set. DO NOT MOVE.

Jumper must be on Pins 1 and 2 for GS51xZ/GS5xxSZ/GS5xxDZ software.

Jumper must be on Pins 2 and 3 for GS50xZ software.

J43

When jumper is placed on 2 pins during power-up, system will reset persistent memory.

Leave on 1 pin only to enable persistent memory feature.

WARNING:

- I Setting DIP switches incorrectly may cause abnormal system behavior and/or damage to system components.

- I Refer to Switchbank illustration on Wiring Configuration page for correct settings for this system.

Notes: